



Unified Profile for DoDAF and MODAF (UPDM)

Version 2.0

OMG Document Number: formal/2012-01-03
Standard document URL: <http://www.omg.org/spec/UPDM/2.0>
Associated Schema Files*: <http://www.omg.org/spec/UPDM/20110601>
<http://www.omg.org/spec/UPDM/20110601/dtc/11-06-15.xml>

* original file: dtc/11-06-15

Copyright © 2003-2011, Adaptive
Copyright © 2003-2011, Advanced Systems Management Group Ltd
Copyright © 2003-2011, Atego (formerly Artisan Software Tools, Ltd.)
Copyright © 2003-2011, International Business Machines
Copyright © 2003-2011, Mega International
Copyright © 2003-2011, No Magic
Copyright © 2003-2011, Object Management Group, Inc.
Copyright © 2003-2011, Sparx Systems Pty Ltd
Copyright © 2003-2011, Visumpoint

USE OF SPECIFICATION - TERMS, CONDITIONS & NOTICES

The material in this document details an Object Management Group specification in accordance with the terms, conditions and notices set forth below. This document does not represent a commitment to implement any portion of this specification in any company's products. The information contained in this document is subject to change without notice.

LICENSES

The companies listed above have granted to the Object Management Group, Inc. (OMG) a nonexclusive, royalty-free, paid up, worldwide license to copy and distribute this document and to modify this document and distribute copies of the modified version. Each of the copyright holders listed above has agreed that no person shall be deemed to have infringed the copyright in the included material of any such copyright holder by reason of having used the specification set forth herein or having conformed any computer software to the specification.

Subject to all of the terms and conditions below, the owners of the copyright in this specification hereby grant you a fully-paid up, non-exclusive, nontransferable, perpetual, worldwide license (without the right to sublicense), to use this specification to create and distribute software and special purpose specifications that are based upon this specification, and to use, copy, and distribute this specification as provided under the Copyright Act; provided that: (1) both the copyright notice identified above and this permission notice appear on any copies of this specification; (2) the use of the specifications is for informational purposes and will not be copied or posted on any network computer or broadcast in any media and will not be otherwise resold or transferred for commercial purposes; and (3) no modifications are made to this specification. This limited permission automatically terminates without notice if you breach any of these terms or conditions. Upon termination, you will destroy immediately any copies of the specifications in your possession or control.

PATENTS

The attention of adopters is directed to the possibility that compliance with or adoption of OMG specifications may require use of an invention covered by patent rights. OMG shall not be responsible for identifying patents for which a license may be required by any OMG specification, or for conducting legal inquiries into the legal validity or scope of those patents that are brought to its attention. OMG specifications are prospective and advisory only. Prospective users are responsible for protecting themselves against liability for infringement of patents.

GENERAL USE RESTRICTIONS

Any unauthorized use of this specification may violate copyright laws, trademark laws, and communications regulations and statutes. This document contains information which is protected by copyright. All Rights Reserved. No part of this work covered by copyright herein may be reproduced or used in any form or by any means--graphic, electronic, or mechanical, including photocopying, recording, taping, or information storage and retrieval systems--without permission of the copyright owner.

DISCLAIMER OF WARRANTY

WHILE THIS PUBLICATION IS BELIEVED TO BE ACCURATE, IT IS PROVIDED "AS IS" AND MAY CONTAIN ERRORS OR MISPRINTS. THE OBJECT MANAGEMENT GROUP AND THE COMPANIES LISTED ABOVE MAKE NO WARRANTY OF ANY KIND, EXPRESS OR IMPLIED, WITH REGARD TO THIS PUBLICATION, INCLUDING BUT NOT LIMITED TO ANY WARRANTY OF TITLE OR OWNERSHIP, IMPLIED WARRANTY OF MERCHANTABILITY OR WARRANTY OF FITNESS FOR A PARTICULAR PURPOSE OR USE.

IN NO EVENT SHALL THE OBJECT MANAGEMENT GROUP OR ANY OF THE COMPANIES LISTED ABOVE BE LIABLE FOR ERRORS CONTAINED HEREIN OR FOR DIRECT, INDIRECT, INCIDENTAL, SPECIAL, CONSEQUENTIAL, RELIANCE OR COVER DAMAGES, INCLUDING LOSS OF PROFITS, REVENUE, DATA OR USE, INCURRED BY ANY USER OR ANY THIRD PARTY IN CONNECTION WITH THE FURNISHING, PERFORMANCE, OR USE OF THIS MATERIAL, EVEN IF ADVISED OF THE POSSIBILITY OF SUCH DAMAGES.

The entire risk as to the quality and performance of software developed using this specification is borne by you. This disclaimer of warranty constitutes an essential part of the license granted to you to use this specification.

RESTRICTED RIGHTS LEGEND

Use, duplication or disclosure by the U.S. Government is subject to the restrictions set forth in subparagraph (c) (1) (ii) of The Rights in Technical Data and Computer Software Clause at DFARS 252.227-7013 or in subparagraph (c)(1) and (2) of the Commercial Computer Software - Restricted Rights clauses at 48 C.F.R. 52.227-19 or as specified in 48 C.F.R. 227-7202-2 of the DoD F.A.R. Supplement and its successors, or as specified in 48 C.F.R. 12.212 of the Federal Acquisition Regulations and its successors, as applicable. The specification copyright owners are as indicated above and may be contacted through the Object Management Group, 140 Kendrick Street, Needham, MA 02494, U.S.A.

TRADEMARKS

MDA®, Model Driven Architecture®, UML®, UML Cube logo®, OMG Logo®, CORBA® and XMI® are registered trademarks of the Object Management Group, Inc., and Object Management Group™, OMG™, Unified Modeling Language™, Model Driven Architecture Logo™, Model Driven Architecture Diagram™, CORBA logos™, XMI Logo™, CWM™, CWM Logo™, IIOP™, IMM™, MOF™, OMG Interface Definition Language (IDL)™, and OMG SysML™ are trademarks of the Object Management Group. All other products or company names mentioned are used for identification purposes only, and may be trademarks of their respective owners.

COMPLIANCE

The copyright holders listed above acknowledge that the Object Management Group (acting itself or through its designees) is and shall at all times be the sole entity that may authorize developers, suppliers and sellers of computer software to use certification marks, trademarks or other special designations to indicate compliance with these materials.

Software developed under the terms of this license may claim compliance or conformance with this specification if and only if the software compliance is of a nature fully matching the applicable compliance points as stated in the specification. Software developed only partially matching the applicable compliance points may claim only that the software was based on this specification, but may not claim compliance or conformance with this specification. In the event that testing suites are implemented or approved by Object Management Group, Inc., software developed using this specification may claim compliance or conformance with the specification only if the software satisfactorily completes the testing suites.

OMG's Issue Reporting Procedure

All OMG specifications are subject to continuous review and improvement. As part of this process we encourage readers to report any ambiguities, inconsistencies, or inaccuracies they may find by completing the Issue Reporting Form listed on the main web page <http://www.omg.org>, under Documents, Report a Bug/Issue (<http://www.omg.org/technology/agreement.htm>).

Table of Contents

Preface	xiii
1 Scope	3
1.1 General	3
1.2 Scope	3
2 Compliance	4
2.1 Compliance Levels	4
2.1.1 Level 0 : Based on UML 2 and Partial SoaML Import	6
2.1.2 Level 1 : Based on UML 2 and Full SysML Import	6
3 Normative References	6
3.1 OMG Documents	6
3.2 Other Documents	7
3.3 Department of Defense Documents	7
4 Terms and Definitions	8
5 Symbols and Acronyms	8
6 Additional Information	9
6.1 Additional Materials	9
6.1.1 Statement of support from the DoD representative 19 May 2011	10
6.1.2 Statement of contribution from the MOD representative received 17th May, 2011	11
6.1.3 Statement of support from the Swedish Armed Forces representative received 16 th May 2011	12
6.2 Overview of this Specification	12
6.2.1 Intended Audience	12
6.2.2 Organization of this Specification	12
6.3 Acknowledgements	13
7 Language Architecture	17
7.1 Introduction	17
7.2 Philosophy	17
7.3 Core Principles	17
7.4 Profile Structure	18
7.4.1 Top Level	18
7.4.2 Middle Level	19
7.4.3 Low Level	20
7.5 Representing Stereotype Constraints	20

7.6 UML Constraint Representation	23
7.7 Important Areas of the Architecture	23
7.7.1 Aliases	23
7.7.2 DoDAF 2.02 Conformance	24
7.7.3 SoaML Reuse in L0	24
7.7.4 SysML Reuse in L1	25
7.7.5 SOPES Reuse in L1	25
8 UPDM Profile	29
8.1 DoDAF Class Library	29
8.1.1 ClassificationType	29
8.1.1.1 Enumeration Literals	29
8.1.2 CommunicationsLinkProperties	30
8.1.3 DataElementProperties	30
8.1.4 ExchangeProperties	30
8.1.5 InformationAssuranceProperties.....	30
8.1.6 InformationElementProperties	30
8.1.7 OperationalActivityProperties	30
8.1.8 SecurityAttributes	31
8.2 UPDM L1	31
8.2.1 UPDM L1::UPDM L0	35
8.2.1.1 UPDM L1::UPDM L0::Core	35
8.3 ActualProject	35
8.3.1 OrganizationalProjectRelationship	36
8.3.1.1 ProjectType	37
8.3.1.2 ActualProjectMilestoneRole	38
8.3.1.3 ProjectMilestoneRole	39
8.3.1.4 UPDM L1::UPDM L0::DoDAF	161
8.3.1.5 UPDM L1::UPDM L0::MODAF	182
8.3.1.6 UPDM L1::UPDM L0::SOPES	207
8.3.1.7 UPDM L1::UPDM L0::SwAF	209
Annex A - Domain Meta-Model (DMM).....	215
Annex B - UPDM Views (Profile)	261
Annex C - UPDM Elements Traceability.....	295
Annex D - Sample Problem	315
Annex E - Bibliography	371

List of Figures

Figure 1.1- UPDM Viewpoint Support Illustration 4

Figure 2.1 - UPDM Compliance Levels 0 and 1 5

Figure 2.2 - L0 and L1 5

Figure 7.1 - Top Level Profile Structure 18

Figure 7.2 - Middle Level Profile Structure 19

Figure 7.3 - Performs Stereotype 20

Figure 7.4 - Performs Hierarchy 21

Figure 7.5 - Connector Extension 21

Figure 7.6 - Capabilities Generalization 22

Figure 7.7 - Visualizing «metarelationship» 22

Figure 7.8 - UML Dependency metaclass 22

Figure 7.9 - “stereotyped relationship” dependency 23

Figure 7.10 - Aliases 24

Figure 8.1 - DoDAF Class Library 29

Figure 8.2 - UPDM Profile 31

Figure 8.3 - ActualProject 36

Figure 8.4 - OrganizationalProjectRelationship 37

Figure 8.5 - ProjectType 38

Figure 8.6 - ActualProjectMilestoneRole 38

Figure 8.7 - ProjectMilestoneRole 39

Figure 8.8 - UPDMElement 40

Figure 8.9 - Exchange 41

Figure 8.10 - ExchangeItem 42

Figure 8.11 - Activity 43

Figure 8.12 - Implements 43

Figure 8.13 - IsCapableOfPerforming 44

Figure 8.14 - CapableElement 45

Figure 8.15 - LocationHolder 46

Figure 8.16 - ActualLocation 46

Figure 8.17 - ConditionType 47

Figure 8.18 - Environment 48

Figure 8.19 - EnvironmentProperty 49

Figure 8.20 - LocationHolder 50

Figure 8.21 - LocationType 51

Figure 8.22 - ActualMeasurement 52

Figure 8.23 - ActualPropertySet 53

Figure 8.24 - Measurement 54

Figure 8.25- Property 55
Figure 8.26- PropertySet 56
Figure 8.27- PropertyValue 57
Figure 8.28- MeasurementSet 58
Figure 8.29- ExchangeElement 59
Figure 8.30- Participant 60
Figure 8.31- Resource 60
Figure 8.32- Rule 61
Figure 8.33- ArchitecturalDescription 62
Figure 8.34- ArchitecturalReference 64
Figure 8.35- ArchitectureMetadata 64
Figure 8.36- Metadata 65
Figure 8.37- View 66
Figure 8.38- Viewpoint 67
Figure 8.39- ISO8601DateTime 68
Figure 8.40- NodeOperation 69
Figure 8.41- OperationalActivity 70
Figure 8.42- OperationalActivityAction 71
Figure 8.43- OperationalActivityEdge 72
Figure 8.44- OperationalEventTrace 73
Figure 8.45- OperationalMessage 73
Figure 8.46- OperationalParameter 74
Figure 8.47- OperationalStateDescription 75
Figure 8.48- SubjectOfOperationalStateMachine 76
Figure 8.49- OperationalState 76
Figure 8.50- LogicalDataModel 77
Figure 8.51- Command 78
Figure 8.52- OperationalExchange 79
Figure 8.53- OperationalExchangeItem 81
Figure 8.54- ArbitraryConnector 82
Figure 8.55- Competence 83
Figure 8.56- ConceptItem 83
Figure 8.57- ConceptRole 84
Figure 8.58- HighLevelOperationalConcept 84
Figure 8.59- KnownResource 85
Figure 8.60- LogicalArchitecture 86
Figure 8.61- Mission 86
Figure 8.62- Needline 87
Figure 8.63- Node 88
Figure 8.64- NodeParent 89
Figure 8.65- NodePort 90
Figure 8.66- NodeRole 91
Figure 8.67- OperationalConstraint 92

Figure 8.68- SecurityDomain 92
Figure 8.69- SubjectOfOperationalConstraint 93
Figure 8.70- ActualOrganization 94
Figure 8.71- ActualOrganizationalResource 95
Figure 8.72- ActualOrganizationRelationship 95
Figure 8.73- ActualOrganizationRole 96
Figure 8.74- ActualPerson 97
Figure 8.75- ActualPost 98
Figure 8.76- CompetenceProvider 99
Figure 8.77- FillsPost 99
Figure 8.78- CompetenceRequirer 100
Figure 8.79- Organization 101
Figure 8.80- OrganizationalResource 102
Figure 8.81- Person 102
Figure 8.82- Post 103
Figure 8.83- ProvidesCompetence 104
Figure 8.84- RequiresCompetence 105
Figure 8.85- Responsibility 106
Figure 8.86- ServiceFeature 107
Figure 8.87- ServiceFunction 108
Figure 8.88- ServiceFunctionAction 109
Figure 8.89- ServiceFunctionEdge 109
Figure 8.90- ServiceInteraction 110
Figure 8.91- ServiceMessage 111
Figure 8.92- ServiceMessageHandler 112
Figure 8.93- ServiceOperation 112
Figure 8.94- ServiceParameter 113
Figure 8.95- ServiceStateMachine 114
Figure 8.96- AsynchronousMessage 115
Figure 8.97- Request 115
Figure 8.98- Service 116
Figure 8.99- ServiceAttribute 116
Figure 8.100- ServiceInterface 118
Figure 8.101- ServiceLevelValue 119
Figure 8.102- ServiceLevelValueSet 119
Figure 8.103- ServicePolicy 120
Figure 8.104- ServicePort 121
Figure 8.105- Capability 122
Figure 8.106- CapabilityProperty 123
Figure 8.107- EnterpriseGoal 124
Figure 8.108- EnterprisePhase 125
Figure 8.109- EnterpriseVision 126
Figure 8.110- Exhibits 127

Figure 8.111- MapsToCapability 128
Figure 8.112- StructuralPart 128
Figure 8.113- TemporalPart 129
Figure 8.114- VisionStatement 130
Figure 8.115- Function 131
Figure 8.116- FunctionAction 132
Figure 8.117- FunctionEdge 132
Figure 8.118- ResourceEventTrace 133
Figure 8.119- ResourceMessage 134
Figure 8.120- ResourceOperation 135
Figure 8.121- ResourceParameter 136
Figure 8.122- ResourceStateMachine 136
Figure 8.123- ResourceState 137
Figure 8.124- DataModel 138
Figure 8.125- PhysicalDataModel 138
Figure 8.126- ResourceInteraction 139
Figure 8.127- ResourceInteractionItem 140
Figure 8.128- CapabilityConfiguration 141
Figure 8.129- FieldedCapability 142
Figure 8.130- Forecast 142
Figure 8.131- PhysicalArchitecture 143
Figure 8.132- Resource 144
Figure 8.133- ResourceArtifact 145
Figure 8.134- ResourceConnector 146
Figure 8.135- ResourceConstraint 147
Figure 8.136- ResourceInterface 148
Figure 8.137- ResourcePort 149
Figure 8.138- ResourceRole 150
Figure 8.139- Software 151
Figure 8.140- SubjectOfForecast 151
Figure 8.141- SubjectOfResourceConstraint 152
Figure 8.142- VersionOfConfiguration 152
Figure 8.143- WholeLifeConfiguration 153
Figure 8.144- SystemResource 154
Figure 8.145- Protocol 156
Figure 8.146- ProtocolImplementation 157
Figure 8.147- Standard 157
Figure 8.148- StandardConfiguration 158
Figure 8.149- EntityAttribute 159
Figure 8.150- EntityItem 160
Figure 8.151- EntityRelationship 160
Figure 8.152- Project 161
Figure 8.153- ProjectActivity 162

Figure 8.154- ActivityPartOfProject 162
Figure 8.155- Information 163
Figure 8.156- ActivityPerformedByPerformer 164
Figure 8.157- Condition 165
Figure 8.158- ConditionProperty 166
Figure 8.159- GeoPoliticalExtent 166
Figure 8.160- Location 167
Figure 8.161- LocationType 168
Figure 8.162- GeoPoliticalExtentType 169
Figure 8.163- Measure 170
Figure 8.164- MeasureType 170
Figure 8.165- Performer 171
Figure 8.166- IndividualPerson 172
Figure 8.167- Organization 172
Figure 8.168- OrganizationType 173
Figure 8.169- PersonType 173
Figure 8.170- Skill 174
Figure 8.171- SkillOfPersonType 174
Figure 8.172- ActivityPartOfCapability 175
Figure 8.173- CapabilityOfPerformer 175
Figure 8.174- DesiredEffect 176
Figure 8.175- Vision 177
Figure 8.176- DesiredState 177
Figure 8.177- Desirer 178
Figure 8.178- System 178
Figure 8.179- SystemConnector 179
Figure 8.180- FunctionalStandard 179
Figure 8.181- TechnicalStandard 180
Figure 8.182- AssociationOfInformation 180
Figure 8.183- SecurityAttributesGroup 181
Figure 8.184- ServiceAccess 182
Figure 8.185- ServiceDescription 182
Figure 8.186- ActualProjectMilestone 183
Figure 8.187- IncrementMilestone 184
Figure 8.188- MilestoneSequence 185
Figure 8.189- OutOfServiceMilestone 185
Figure 8.190- ProjectMilestone 186
Figure 8.191- ProjectOwnership 187
Figure 8.192- ProjectSequence 187
Figure 8.193- ProjectStatus 188
Figure 8.194- ProjectTheme 189
Figure 8.195- StatusIndicators 190
Figure 8.196- Climate 190

Figure 8.197- LightCondition 191
Figure 8.198- Alias 191
Figure 8.199- Definition 192
Figure 8.200- ExternalIndividual 193
Figure 8.201- ExternalType 194
Figure 8.202- OntologyReference 195
Figure 8.203- SameAs 196
Figure 8.204- StereotypeExtension 196
Figure 8.205- ActivitySubject 197
Figure 8.206- OwnsProcess 198
Figure 8.207- Process 199
Figure 8.208- StandardOperationalActivity 199
Figure 8.209- Control 200
Figure 8.210- Energy 201
Figure 8.211- ProblemDomain 201
Figure 8.212- Trustline 202
Figure 8.213- RoleType 203
Figure 8.214- DeployedMilestone 204
Figure 8.215- NoLongerUsedMilestone 204
Figure 8.216- EnduringTask 205
Figure 8.217- WholeLifeEnterprise 206
Figure 8.218- ProtocolLayer 206
Figure 8.219- SOPEs elements 207
Figure 8.220- Design Rule Elements 210

Figure A.1- AcV-1/PV-1 - DMM 215
Figure A.2- AcV-2/PV-2 - DMM 216
Figure A.3- PV-3 - DMM 217
Figure A.4- AV-1 - DMM 218
Figure A.5- AV-2 - DMM 219
Figure A.6- OV - 1 - DMM 220
Figure A.7- OV-2 - DMM 221
Figure A.8- OV-3 - DMM 222
Figure A.9- OV-4-Actual - DMM 223
Figure A.10- OV-4 Typical - DMM 224
Figure A.11- OV-5 - DMM 225
Figure A.12- OV-6a - DMM 226
Figure A.13- OV-6b - DMM 226
Figure A.14- OV-6c - DMM 227
Figure A.15- OV-7/DIV-1/DIV-2 - DMM 227
Figure A.16- SOV-1 - DMM 228
Figure A.17- SOV-2 - DMM 229
Figure A.18- SOV-3 - DMM 229
Figure A.19- SOV-4a - DMM 230

Figure A.20- SOV-4b - DMM 230
Figure A.21- SOV-4c - DMM 231
Figure A.22- SOV-5 - DMM 231
Figure A.23- CV-7 - DMM 232
Figure A.24- StV-1/CV-1 - DMM 233
Figure A.25- StV-2/CV-2 - DMM 233
Figure A.26- StV-3/CV-3 - DMM 234
Figure A.27- StV-4/CV-4 - DMM 235
Figure A.28- StV-5/CV-5 - DMM 235
Figure A.29- StV-6/CV-6 - DMM 236
Figure A.30- SV-1/SvcV-1 - DMM 237
Figure A.31- SV-10a/SvcV-10a - DMM 238
Figure A.32- SV-10b/SvcV-10b - DMM 238
Figure A.33- SV-10c/SvcV-10c - DMM 239
Figure A.34- SV-11 - DMM 239
Figure A.35- SV-12 - DMM 240
Figure A.36- SV-2/SvcV-2 - DMM 241
Figure A.37- SV-3/SvcV-3a/SvcV-3b - DMM 242
Figure A.38- SV-4/SvcV-4 - DMM 243
Figure A.39- SV-5/SvcV-5 - DMM 243
Figure A.40- SV-6/SvcV-6 - DMM 244
Figure A.41- SV-7/SvcV-7 - DMM 245
Figure A.42- SV-8/SvcV-8 - DMM 245
Figure A.43- SV-9/SvcV-9 - DMM 246
Figure A.44- TV-1&2&3 - DMM 247
Figure A.45- SOPES - DMM 248
Figure A.46- Design Rule - DMM 248
Figure A.47- Activity - DM2 249
Figure A.48- Capability - DM2 250
Figure A.49- Goals - DM2 251
Figure A.50- Information and Data - DM2 252
Figure A.51- Information Pedigree - DM2 252
Figure A.52- Location - DM2 253
Figure A.53- Measure - DM2 254
Figure A.54- Organizational Structure - DM2 255
Figure A.55- Performer - DM2 256
Figure A.56- Project - DM2 257
Figure A.57- Resource Flow - DM2 258
Figure A.58- Rules - DM2 259
Figure A.59- Services - DM2 260

Figure B.1- AcV-1/PV-1 262
Figure B.2- AcV-2/PV-2 263
Figure B.3- PV-3 263

Figure B.4- AV-1 264
Figure B.5- AV-2 265
Figure B.6- Environment Elements 266
Figure B.7- Measurements 267
Figure B.8- OV-1 268
Figure B.9- OV-3 269
Figure B.10- OV-3 270
Figure B.11- OV-4 Actual 271
Figure B.12- OV-4 Typical 272
Figure B.13- OV-5 273
Figure B.14- OV-6a 274
Figure B.15- OV-6b 274
Figure B.16- OV-6c 275
Figure B.17- OV-7/DIV-1/DIV-2 276
Figure B.18- SOV-1 277
Figure B.19- SOV-2 277
Figure B.20- SOV-3 278
Figure B.21- SOV-4a 278
Figure B.22- SOV-4b 279
Figure B.23- SOV-4c 279
Figure B.24- SOV-5 280
Figure B.25- CV-7 280
Figure B.26- StV-1/CV-1 281
Figure B.27- StV-2/CV-2 282
Figure B.28- StV-3/CV-3 282
Figure B.29- StV-4/CV-4 283
Figure B.30- StV-5/CV-5 283
Figure B.31- StV-6/CV-6 284
Figure B.32- SV-1/SvcV-1 285
Figure B.33- SV-10a/SvcV-10a 286
Figure B.34- SV-10b/SvcV-10b 286
Figure B.35- SV-10c/SvcV-10c 287
Figure B.36- SV-11/DIV-3 287
Figure B.37- SV-12 288
Figure B.38- SV-2/SvcV-2 288
Figure B.39- SV-3/SvcV-3a/SvcV-3b 289
Figure B.40- SV-4/SvcV-4 290
Figure B.41- SV-5/SvcV-5 291
Figure B.42- SV-6/SvcV-6 291
Figure B.43- SV-7/SvcV-7 292
Figure B.44- SV-8/SvcV-8 292
Figure B.45- SV-9/SvcV-9 293
Figure B.46- TV-1&2&3/StdV-1&2 294

Figure D.1 - Diagram Flow 318
Figure D.2 - AV-1 319
Figure D.3- AV Measurements Class Diagram 321
Figure D.4 - AV Measurements Instance Diagram 322
Figure D.5 - SysML BDD Units, Dimensions, and Value Types 322
Figure D.6- SysML Requirements 324
Figure D.7 - StV-1 Enterprise View 325
Figure D.8 - StV-2 Capability Taxonomy 326
Figure D.9 - StV-4 328
Figure D.10 - StV-4 Alternative View 328
Figure D.11 - StV-6 329
Figure D.12 - OV-1a 330
Figure D.13 - Alternate OV-1a 330
Figure D.14 - OV-1d 332
Figure D.15 - OV-2 Class Diagram 333
Figure D.16 - Alternate OV-2 SysML Version without Service Ports 333
Figure D.17 - Alternate OV-2 with SysML Flow Ports 334
Figure D.18 - OV-4 Typical 336
Figure D.19 - OV-4 Actual 336
Figure D.20 - OV-5 337
Figure D.21 - Alternate OV-5 338
Figure D.22 - OV-6b 339
Figure D.23 - OV-6c 340
Figure D.24 - OV-7 341
Figure D.25 - SOV-1 342
Figure D.26 - SOV-2 342
Figure D.27- SOV-3 343
Figure D.28 - SOV-4b 344
Figure D.29 - SOV-5 345
Figure D.30 - SV-1 Maritime Rescue Unit 346
Figure D.31 - SV-2 347
Figure D.32 - SV-4 348
Figure D.33 - SV-4 Activity Diagram 349
Figure D.34 - SV-5 350
Figure D.35 - SV-7 352
Figure D.36 - SV-9 354
Figure D.37 - SV-10b 356
Figure D.38 - SV-10c 357
Figure D.39 - SV-11 358
Figure D.40 - AcV-2 360
Figure D.41 - AcV-3 Class Diagram 360
Figure D.42 - AcV-3 Actual 361

Figure D.43 - AcV-3 Additional Milestone Types 361
Figure D.44 - TV-2 363
Figure D.45 - TV-2 363
Figure D.46 - Block Definition Diagram 366
Figure D.47 - System Parametrics 367
Figure D.48 - Scanning and Availability Equations 367
Figure D.49 - Fuel Availability Equation 368
Figure D.50 - Crew Availability Equation 368
Figure D.51 - Aircraft System Parametric 368
Figure D.52 - System Instance Diagram 369

Preface

About the Object Management Group

OMG

Founded in 1989, the Object Management Group, Inc. (OMG) is an open membership, not-for-profit computer industry standards consortium that produces and maintains computer industry specifications for interoperable, portable, and reusable enterprise applications in distributed, heterogeneous environments. Membership includes Information Technology vendors, end users, government agencies, and academia.

OMG member companies write, adopt, and maintain its specifications following a mature, open process. OMG's specifications implement the Model Driven Architecture® (MDA®), maximizing ROI through a full-lifecycle approach to enterprise integration that covers multiple operating systems, programming languages, middleware and networking infrastructures, and software development environments. OMG's specifications include: UML® (Unified Modeling Language™); CORBA® (Common Object Request Broker Architecture); CWM™ (Common Warehouse Metamodel); and industry-specific standards for dozens of vertical markets.

More information on the OMG is available at <http://www.omg.org/>.

OMG Specifications

As noted, OMG specifications address middleware, modeling and vertical domain frameworks. A Specifications Catalog is available from the OMG website at:

http://www.omg.org/technology/documents/spec_catalog.htm

Specifications within the Catalog are organized by the following categories:

OMG Modeling Specifications

- UML
- MOF
- XMI
- CWM
- Profile specifications.

OMG Middleware Specifications

- CORBA/IIOP
- IDL/Language Mappings
- Specialized CORBA specifications
- CORBA Component Model (CCM).

Platform Specific Model and Interface Specifications

- CORBA services
- CORBA facilities
- OMG Domain specifications
- OMG Embedded Intelligence specifications
- OMG Security specifications.

All of OMG's formal specifications may be downloaded without charge from our website. (Products implementing OMG specifications are available from individual suppliers.) Copies of specifications, available in PostScript and PDF format, may be obtained from the Specifications Catalog cited above or by contacting the Object Management Group, Inc. at:

OMG Headquarters
140 Kendrick Street
Building A, Suite 300
Needham, MA 02494
USA
Tel: +1-781-444-0404
Fax: +1-781-444-0320
Email: pubs@omg.org

Certain OMG specifications are also available as ISO standards. Please consult <http://www.iso.org>

Typographical Conventions

The type styles shown below are used in this document to distinguish programming statements from ordinary English. However, these conventions are not used in tables or section headings where no distinction is necessary.

Times/Times New Roman - 10 pt.: Standard body text

Helvetica/Arial - 10 pt. Bold: OMG Interface Definition Language (OMG IDL) and syntax elements.

Courier/Courier New - 10 pt. Bold: Programming language elements.

Helvetica/Arial - 10 pt: Exceptions

Note – Terms that appear in *italics* are defined in the glossary. Italic text also represents the name of a document, specification, or other publication.

Issues

The reader is encouraged to report any technical or editing issues/problems with this specification to <http://www.omg.org/technology/agreement.htm>.

Subpart I - Overview of the UML Profile for DoDAF and MODAF

This subpart contains the following Clauses and sub clauses:

1. Scope
 - 1.1 General
 - 1.2 Scope
2. Compliance
 - 2.1 Compliance Levels
 - 2.1.1 Level 0 : Based on UML 2 and Partial SoaML Import
 - 2.1.2 Level 1 : Based on UML 2 and Full SysML Import
3. Normative References
4. Terms and Definitions
5. Symbols and Acronyms
6. Additional Information
 - 6.1 Additional Materials
 - 6.1.1 Statement of support from the DoD representative
 - 6.1.2 Statement of contribution from the MOD representative
 - 6.1.3 Statement of support from the Swedish Armed Forces representative
 - 6.2 Overview of this Specification
 - 6.2.1 Intended Audience
 - 6.2.2 Organization of this Specification
 - 6.3 Acknowledgements

1 Scope

1.1 General

The authors believe that this specification for a Unified Profile for the Department of Defense Architecture Framework (DoDAF) and the Ministry of Defence Architecture Framework (MODAF) will

- enhance the quality, productivity, and effectiveness associated with enterprise and system of systems architecture modeling,
- promote architecture model reuse and maintainability,
- improve tool interoperability and communications between stakeholders, and
- reduce training impacts due to different tool implementations and semantics.

The purpose of this document is to specify a UML 2, and optional SysML, profile to enable practitioners to express DoDAF and MODAF model elements and organize them in a set of specified viewpoints and views that support the specific needs of stakeholders in the US Department of Defense and the United Kingdom Ministry of Defence. The profile defined in this specification has been imported by at least four tool vendors including Artisan, EmbeddedPlus, No Magic, and Visumpoint, and the implementation is actively under development. They all plan to release a commercially available product supporting this version of UPDM within the next year. Currently, partial implementations are being used actively on projects.

UPDM 2.0 defines a set of UML and optional SysML stereotypes and model elements and associations to satisfy the requirements of the UPDM 2.0 RFP. This specification documents the language architecture in terms of the parts of UML 2 that are reused and the extensions to UML 2 and SysML. The specification includes the concrete syntax (notation) for the complete language. The reusable portion of the UML 2 and SysML specification are not included directly in the specification but are included by reference. The specification also provides an example of how the language can be used to represent a UPDM 2.0 architecture.

1.2 Scope

The scope of UPDM 2.0 includes the language extensions to enable the extraction of specified and custom views from an integrated architecture description. These views include a system's viewpoint (DoDAF Systems View) along with associated systems implementation standards (DoDAF/MODAF Technical View) within the context of the business or enterprise viewpoint (DoDAF/MODAF Operational View). The DoDAF/MODAF AllViews is also included. In addition, UPDM 2.0 allows the architecture model to include representation of an enterprise capability and strategic intent (MODAF Strategic Viewpoint, DoDAF 2.02 Capability Model) and the process steps associated with the procurement of conformant systems (MODAF Acquisition View, DoDAF 2.02 Project Model). Finally, the MODAF and DoDAF 2.02 Services View is included to model Service Oriented Architectures. UPDM 2.0 also includes mechanisms for designing ad hoc custom views and more formal extensions of new views of the model. The specification also allows for combined views such as the DoDAF 2.02 Data Model combining the SV-11 and OV-7. NAF is supported implicitly through the recent convergence of the MODAF and NAF standards. Consequently, NAF is not explicitly mentioned in the following specification for simplicity. However, a separate mapping subsection is included in Annex C to demonstrate compliance. In addition, the authors have worked closely with the NAF management group in order to ensure compliance and that the specification is fit for purpose.

UPDM 2.0 will support the capability to:

- model architectures for a broad range of complex systems, which may include hardware, software, data, personnel, and facility elements;
- model consistent architectures for system-of-systems down to lower levels of design and implementation;
- model service oriented architectures;
- support the analysis, specification, design, and verification of complex systems; and
- improve the ability to exchange architecture information among related tools that are UML based and tools that are based on other standards.

The profile provides the modeling of operational capabilities, services, system activities, nodes, system functions, ports, protocols, interfaces, performance, and physical properties and units of measure. In addition, the profile enables the modeling of related architecture concepts such as DoD's doctrine, organization, training material, leadership & education, personnel, and facilities (DOTMLPF) and the equivalent UK Ministry of Defence Lines of Development (DLOD) elements.

UPDM 2.0, as illustrated in Figure 1.1, will address DoDAF and MODAF Viewpoints as well as enabling extensions to new architecture perspectives (e.g., Services views, Custom views, Logistics views cost views, etc.). MODAF terminology has been used for simplicity.

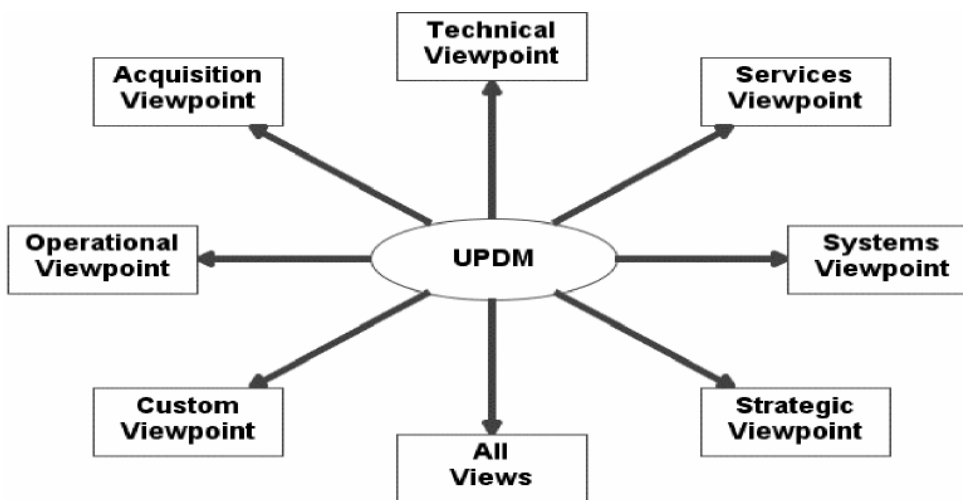

Figure 1.1 - UPDM Viewpoint Support Illustration

2 Compliance

2.1 Compliance Levels

UPDM 2.0 specifies two compliance levels corresponding to supporting a UML-based profile and a UML+ OMG SysML™ profile.

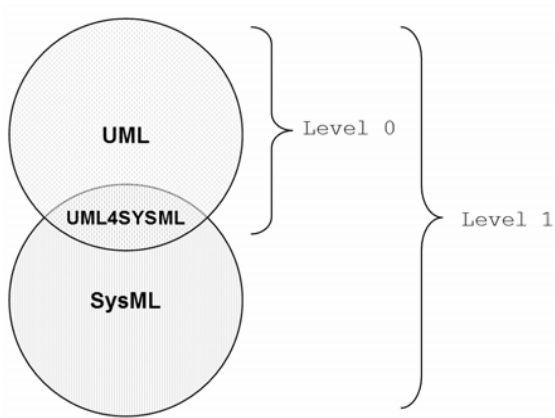

Figure 2.1 - UPDM Compliance Levels 0 and 1

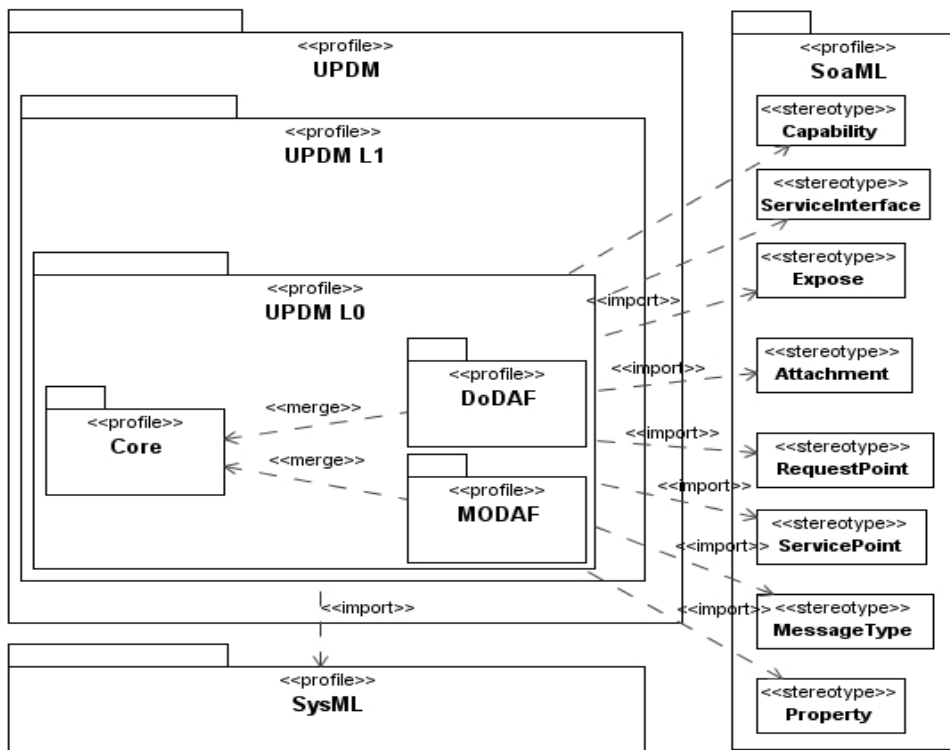

Figure 2.2 - L0 and L1

2.1.1 Level 0 : Based on UML 2 and Partial SoaML Import

Figure 2.2 illustrates that UPDM 2.0 Compliance Level 0 is an implementation of UPDM extending UML 2 and importing several SoaML stereotypes – namely Expose, Attachment, RequestPoint, ServicePoint, MessageType, Property. In order for a tool to be considered as compliant with L0, the following must be true:

- All stereotypes, classes, attributes, constraints, associations, and package structures that are scoped to the L0 package (including sub-packages) must exist and be compliant with this specification.
- XMI import and export of the user model and profile must be supported.
- A Level 0 compliant implementation must be able to import and export Level 0 UPDM 2.0 models with 100% fidelity (i.e., no loss or transforms).
- A Level 0 compliant implementation must be able to import Level 1 UPDM 2.0 models with only minimal losses.

2.1.2 Level 1 : Based on UML 2 and Full SysML Import

Figure 2.2 illustrates that UPDM 2.0 Compliance Level 1 includes everything in Level 0, imports the rest of the SysML sub-profiles and defines constraints that pair together the application of SysML and UPDM 2.0 stereotypes. This provides a UPDM 2.0 implementation that can be seamlessly taken forward into SysML modeling. For a tool to be considered as compliant with L1, the following must be true:

- All stereotypes, classes, attributes, constraints, associations and package structures that are scoped to the L1 package (including sub-packages) must exist and be compliant with this specification.
- XMI import and export of the user model and profile must be supported.
- A Level 1 compliant implementation must be able to import and export Level 1 UPDM 2.0 models with 100% fidelity (i.e., no loss or transforms).

A Level 1 compliant implementation must be able to import Level 0 UPDM 2.0 models with no loss, and transformations where necessary.

3 Normative References

The following normative documents contain provisions, which through reference in this text, constitute provisions of this specification. Subsequent amendments to, or revisions of, any of these publications do not apply.

3.1 OMG Documents

- Unified Modeling Language: Superstructure version 2.3 (<http://www.omg.org/spec/UML/2.3/Superstructure>)
- Unified Modeling Language: Infrastructure version 2.3 (<http://www.omg.org/spec/UML/2.3/Infrastructure>)
- MOF 2.0/XMI Mapping Specification, v2.1 (<http://www.omg.org/spec/XMI/2.1>)
- UML 2.0 OCL Specification, v2.0 (<http://www.omg.org/spec/OCL/2.0>)
- SoaML Specification, v1.0: (<http://www.omg.org/spec/SoaML/>)
- OMG Systems Modeling language (OMG SysML), V1.2 (<http://www.omg.org/spec/SysML/1.2>)

3.2 Other Documents

- MODAF The MOD Architectural Framework Version 1.2.002 August 2008 (<http://www.modaf.org.uk>
<http://www.modaf.org.uk/M3>)

3.3 Department of Defense Documents

DoD Deputy Chief Information Officer. Department of Defense Architecture Framework, Version 2.02, August 2010.

1. *The DoDAF Architecture Framework Version 2.02*. is defined in a web site format. One should start from the home page <http://cio-nii.defense.gov/sites/dodaf20/>

The following information was current on the web site as of 27 April 2011. The official and current version for the Department of Defense Architecture Framework. **is Version 2.02, dated** August 2010. An Adobe Portable Document Format (PDF) version of the 2.02 website is produced can be downloaded as: [DoDAF 2.02.pdf](#) from http://cio-nii.defense.gov/sites/dodaf20/products/DoDAF_v2-02_web.pdf. This is approximately 289 pages.

2. For readers familiar with the three-volume version of DoDAF, the latest version is still DoDAF 2.0 of 2009. DoDAF 2.01 and 2.02 have not produced updates to that version. The reader must apply the changes documented in the Version Description Documents (see section 3 below) as well as the material on the official web site (see section 1 above). Again, the documentation set has not been changed from DoDAF Version 2.0 and is no longer definitive for 2.02 without the changes. It can be downloaded from the DoDAF Archives <http://cio-nii.defense.gov/sites/dodaf20/archives.html> or
 - Volume One: Introduction, Overview, and Concepts: Manager's Guide, 28 May 2009
 - <http://cio-nii.defense.gov/docs/DoDAF%20V2%20-%20Volume%201.pdf>
 - Volume Two: Architectural Data and Models: Architect's Guide, 28 May 2009
 - <http://cio-nii.defense.gov/docs/DoDAF%20V2%20-%20Volume%201.pdf>
 - Volume Three: DoDAF Meta-model: Physical Exchange Specification: Developer's Guide, 28 May 2009
 - <http://cio-nii.defense.gov/docs/DoDAF%20V2%20-%20Volume%203.pdf>
3. DoDAF Meta Model (DM2). The DM2 for Version 2.02 of DoDAF can be derived sequentially as follows:
 - The DoDAF Meta Model (DM2) **has changed** from DoDAF Version 2.0. It can be derived as a sequential update from DoDAF MetaModel (DM2) Version 2.00 to 2.01, and 2.02. There were 94 changes in the DoDAF MetaModel (DM2) from DoDAF 2.0 (68 in Version 2.01 and (26 in Version 2.02).¹ These changes may be traced as follows:

- 3.1 Start with a *description* of DoDAF/DM2 Version 2.00 baseline
See <http://cio-nii.defense.gov/sites/dodaf20/DM2.html>

The DM2 consists of the following data items:

- a. Conceptual Data Model:

<http://cio-nii.defense.gov/sites/dodaf20/conceptual.html> and

http://cio-nii.defense.gov/sites/dodaf20/DM2_HTML/index.htm

1. The proper tracing of metamodel is so critical to UPDM 2.0 that UPDM 2.0 has produced a deliverable spreadsheet tracing UPDM Profile to the DM2 & MM3 in Annex C.

- b. Logical Data Model: <http://cio-nii.defense.gov/sites/dodaf20/logical.html>
- c. Physical Exchange Specification: <http://cio-nii.defense.gov/sites/dodaf20/PES.html>
- d. Ontology: <http://cio-nii.defense.gov/sites/dodaf20/Ontology1.html>

3.2 Proceed to the description of changes made to DoDAF/DM2 2.00 to create DoDAF/DM2 2.01. **Version 2.01** as of 1 April 2010. Version Description Document for the DoD Architecture Framework (DoDAF) and DoDAF Meta Model (DM2), Version 2.01 can be downloaded from http://cio-nii.defense.gov/sites/dodaf20/products/DoDAF_DM2_VDD_v2-01.doc

3.3 Proceed to the description of changes made to DoDAF/DM2 2.01 to create DoDAF/DM2 2.02, download the [Version Description Document](http://cio-nii.defense.gov/sites/dodaf20/products/DoDAF-DM2_v2-02_VDD.pdf) from http://cio-nii.defense.gov/sites/dodaf20/products/DoDAF-DM2_v2-02_VDD.pdf.

4. Supporting Material

- The [Data Dictionary for Version 2.02](http://cio-nii.defense.gov/sites/dodaf20/products/DM2_Data_Dictionary_and_Mappings_v202.xls) is available in spreadsheet format as http://cio-nii.defense.gov/sites/dodaf20/products/DM2_Data_Dictionary_and_Mappings_v202.xls
- Promulgation Memo: <http://cio-nii.defense.gov/docs/DoDAF%20V2%20-%20Promulgation%20Memo.pdf>

4 Terms and Definitions

No new terms and definitions have been required to create this specification. All terms should be available in the normative references or bibliographic citations for detailed explanation.

5 Symbols and Acronyms

AcV-*	Acquisition View
AV-*	All View
BPMN	Business Process Modeling Notation
C4ISR	Command, Control, Communications, Computers, Intelligence, Surveillance, and Reconnaissance
COI	Communities of Interest
CV-*	Capability View
DIV-*	Data and Information Views
DM2	DoDAF Meta Model
DMM	UPDM Domain Meta Model
DoD	United States Department of Defense
DoDAF	Department of Defense Architecture Framework
DOTMLP	Doctrine, Organization, Training, Material, Leadership, Personnel, Facilities
EIE	Enterprise Information Environment

IDEAS	International Defense Enterprise Architecture Exchange
IDEF	Integrated DEFinition Methods
JCIDS	Joint Capabilities Integration and Development System
JETL	Joint Essential Task List
MOD	United Kingdom Ministry of Defence
MODAF	Ministry of Defence Architecture Framework
NEC	Network Enabled Capability
NCW	NetCentric Warfare
NCAT	NetCentric Assessment Tool
NCOIC	NetCentric Operations Industry Consortium
OV-*	Operational View
PES	DoDAF Physical Exchange Specification
POC	Proof of Concept
PV-*	Project View
SoS	System of Systems
SOV-*	Service Oriented View
StdV-*	Standards View
STV-*	Strategic View
SV-*	System View
SvcV-*	Service View
TPPU	Task, Post, Process, and Use
TV-*	Technical View
UPDM	Unified Profile for DoDAF and MODAF

6 Additional Information

6.1 Additional Materials

Accompanying this specification are XMI files and requirements documents, as listed below.

Title	OMG Document Number	Supersedes
UPDM Profile Submission	dtc/2011-06-14	c4i/2010-08-06
UPDM Profile Submission - ERRATA	N/A	N/A

UPDM Beta 2 specification without change notes	dtc/2011-06-13	N/A
Inventory List	dtc/2011-06-16	N/A
Final Report	dtc/2011-06-12	N/A
UPDM XMI Document for UML	dtc/2011-06-15	c4i/2010-08-07
UPDM Requirements Traceability Document	N/A	N/A
UPDM Requirements Traceability Document - ERRATA	N/A	N/A

6.1.1 Statement of support from the DoD representative 19 May 2011

19 May 2011

To: Co-Chairs of the OMG UPDM Group

From: Leonard F. Levine DoD/DISA/EE31/703-225-4748

Subject: Summary of US DoD Support for UPDM 2.0

I am pleased to update and strengthen the endorsement of the Unified Profile for DoDAF and MODAF (UPDM) for Version 2.0

DoD support for the UPDM is strong and has steadily increased since 2005. As I wrote for UPDM Version 1.0, DoD promotes the use of international, national, and industry-wide open standards.

DoD welcomed the adoption of UPDM Version 1.0 by the Object Management Group (OMG) as an industry specification for architecture tools and the submission of UPDM Version 1.1 this very month to the International Organization for Standardization (ISO) as an international standard. UPDM Version 1.x has been mandated for use in DoD Acquisition and recorded in the DoD IT Standards Registry (DISR). One of the criteria for this mandate was the availability of more than three widely-used commercial tools complying with standard. UPDM 1.x remains viable for those using the DoD Architecture Framework (DoDAF), Version 1.5. I also point out that, on 19 September 2008, the United Kingdom Ministry of Defence (UK MOD) and the United States Department of Defense issued a joint statement of support.

Immediately upon release of DoDAF, Version 2.0 in May 2009, the OMG UPDM Group began synchronization of its lifecycle, particularly the respective Meta Models with the DODAF, and in August 2011, finalized its requirements upon the issuance of the maintenance upgrade of DoDAF 2.02. During the ensuing two years, technical representatives of the two groups have met quarterly at the OMG as well as at numerous ad hoc meetings. The result was a complete mapping between the DoDAF Meta Model (DM2) and the UPDM Domain Meta Model (DMM), from which the normative Profile derives. This is particularly noteworthy since UPDM maintained equal support for the MODAF and added support for the NATO Architecture Framework (NAF).

Particularly noteworthy is the inclusion within the current and upcoming versions of the UPDM Profile of the Unified Modeling Language (UML) Profiles for Systems Modeling Language (SysML), Service Oriented Architecture Modeling Language (SOAML), and Business Process Modeling Notation (BPMN). While these are optional within UPDM, these standards are also DoD mandated standards. SysML, SOA, and BPMN support other DoD processes referenced in DoDAF and in Acquisition Processes supported by Acquisition, Technology and Logistics (OASD/ATL). This flexibility increases the appeal of the standard across the Department and promotes reuse across the various disciplines involved with acquisition.

A most important development in UPDM 2.0 is the proven capability of exchange of models among end-users as well as tool vendors. UPDM compliant tools will include architecture exchanges through the XML Metadata Interchange (XMI), and I note the facilitating role of the OMG Model Interchange Working Group in testing and making this practicable. This group plans to subject UPDM and its Search and Rescue (SAR) to tough interoperability tests through its use of OMG / ISO XMI.

In closing, I will paraphrase Mr. Brian Wilczynski, the Director, Architecture and Infrastructure, U.S. Department of Defense, Office of the Chief Information Officer, at the annual Enterprise Architecture Conference held this 11 – 15 April 2011 in Hampton, Virginia (Introductory Remarks at <http://afei.kzoplatform.com/swf/player/758> and Closing Remarks at <http://afei.kzoplatform.com/swf/player/770>):

- While UPDM does not solve all architecture problems, it represents a significant jump ahead in interoperability and architecture exchange.
- There has been a lot of DoD involvement, a very intensive engagement at times, involved with development of UPDM with significant devotion of human resource. This not something we could sit back and monitor, yet more impressively
- The UML tool vendors have come to the table because they see benefit in this.
- What's in it for us in DoD?
 - These tool vendors are implementing our standard.
 - And now we can reuse architectures.
- UPDM solves many of our problems because it is an enabler and allows improvement of information exchange across architecture toolsets.
- But that is a limited set of toolsets.
- Further education is required on where UPDM is applicable and where it can solve our problems, and what its role is.
- The whole experience with the OMG group is a model of how to work with industry without us (government) having to do a solution of its own.
- In summary, if you are using UML modeling tools for DoDAF 2.0, use UPDM. UPDM 2.0 will be mandated for those using DoDAF 2 and it will be part of the DISR.

Defense Information Systems Agency (DISA)
ATTN: Leonard F. Levine /Code EE31
P.O. Box 549
Ft. Meade, MD 20755-0549

6.1.2 Statement of contribution from the MOD representative received 17th May, 2011

The United Kingdom Ministry of Defence, who developed and own MODAF, has actively contributed to the development of UPDM version 1 and version 2, primarily through the provision of contracted expertise sourced from Model Futures. The standardisation effort made by the UPDM group and OMG is regarded with high importance by MOD, as is demonstrated by the level of internal and external MOD resource provided to support the development of UPDM, and further evidenced by the recognition of UPDM in MOD's Joint Services Publication 605, Defence Architecture Policy Version 1.1 (page 7, EAP.12) dated 11/04/2011, which states that:

“EAP.12. Software Tools that are based on the Unified Modelling Language (UML) or the Systems Modelling Language (SysML) notations shall use the Unified Profile for DoDAF and MODAF (UPDM) standard which MOD recognises as a correct implementation of the M3.”

Patrick Gorman
Assistant Head Architecture Framework
CIO-ISP-POL
Ministry of Defence
Main Building, 2.N.19

Whitehall
LONDON, SW1A 2HB

6.1.3 Statement of support from the Swedish Armed Forces representative received 16 th May 2011

Swedish Armed Forces has in an active way, through FMV and with Generic AB as expert contractor to FMV, been supporting the work with UPDM version 1 and version 2. The standardization effort made within the UPDM group and OMG is regarded as very important by us, as proved by the level of support we have provided to the work with developing UPDM version 1 and 2. In those cases where UML tools are applicable for our work, we will only select UML tools that are compliant with the UPDM standard.

LtCol Mikael Hagenbo
Swedish Armed Forces HQ.
Supreme Commanders Staff, Joint Development Department, Head of architecture, frameworks and International co-operation
Diplomaed Change Manager
SE-107 85 STOCKHOLM

6.2 Overview of this Specification

6.2.1 Intended Audience

This specification will be of interest to end users who expect to use this profile, and to tool vendors interested in developing tool support for the development of enterprise and system of systems architectures, and that can satisfy contract documentation requirements for DoD and MOD customers. Tool vendors will also be able to use this specification to support Model Driven Development of systems based on the architectural descriptions based on this profile. Developers and reviewers of the views will have a clearer understanding of the semantics behind specific views and viewpoints, which will support more precise evaluation and comparison.

6.2.2 Organization of this Specification

DoDAF and MODAF are formally expressed as domain-specific meta-models known as the DoDAF Meta Model (DM2) and the MODAF Meta Model (M3) respectively. There is also a set of viewpoints and views that address the concerns of a well-defined set of stakeholders. Before DoDAF Version 2.02 and UPDM Version 2.0, these were the organizing factors. This is no longer the case. This specification organizes the presentation of the UPDM 2.0 abstract and concrete syntax around the meta-models, with effort made to establish a maximum set of common Core models and a minimum set of DoDAF DM2 or MODAF M3 specific models. Significant effort has also been made to continue to support the now over 50 viewpoints that can be derived from these meta-models as well as "user-defined views". This is done so that the discussion is well-connected to the domain experts required to produce these views. (See Section 1.5 for a more detailed description.)"The rest of this document contains the technical content of this specification. As background for this specification, readers may wish to review the UML, OMG SysML, and SoAML specifications that complement this specification.

Although the chapters are organized in a logical manner and can be read sequentially, this is a reference specification that can be read in a non-sequential manner.

Part I of the specification describes the details of the specification.

Part II provides the technical details essential to understanding the specification:

The specification of the Profile language. The profile includes both a Compliance Level 0 that extends UML and a Compliance Level 1 that extends UML and OMG SysML. The elements of the profile are organized by the specific viewpoints required by DoDAF and MODAF. Within each of the viewpoint-specific sections, e.g., Operational Views (OVs), the elements are presented in alphabetical order.

Annex A presents a non-normative view of various diagrams that document the Domain Metamodel (DMM) that document the DoDAF 2.02 and MODAF 1.2 integrated model. This model was used as a basis for creating the UPDM 2.0 profile.

Annex B presents a non-normative view of the various diagrams that document the views from the UPDM Profile that implement the DoDAF 2.02 and MODAF 1.2 views in the Domain Meta-Model described in Annex A.

Annex C presents the traceability among UPDM 2.0 stereotypes and DoDAF/MODAF elements. Please note that not all DoDAF/MODAF elements have corresponding UPDM 2.0 stereotypes. Those DoDAF/MODAF elements are modeled by UML artifacts directly, which is shown in the Metaclass column. Annex C also contains a mapping table showing traceability between the NAF 3.1 and MODAF 1.2 views and elements, and the DoDAF 2.02 and the MODAF 1.2 views.

Annex D Sample Problem illustrating UPDM 2.0 concepts

Annex E contains the bibliography providing a listing of additional consulted artifacts.

6.3 Acknowledgements

The following individuals submitted parts of this specification and/or have assisted the UPDM 2.0 team in the development of the specification:

Adaptive Inc	Pete Rivett
Advanced System Management Group	Michael Abrason
Atego	Phil Astle
Atego	Matthew Hause
BAE Systems	David C. Putman
BORO Solutions	Chris Partridge
Decisive Analytics Corp	Charles Johnson
DOD	Leonard Levine
DOD	Walt Okon
EmbeddedPlus Engineering	Paula Obeid
EmbeddedPlus Engineering	Kumar Marimuthu
Generic AB	Lars-Olof Kihlstrom
General Dynamics	Ron Townsend
International Business Machines	Graham Bleakley
Lockheed Martin	Sanford Friedenthal
Lockheed Martin	Laura Hart
Malina Software	Bran Selic
Mega	Antoine Lonjon

Mitre
MOD
MOD
MOD
Model Futures
No Magic, Inc.
No Magic, Inc.

No Magic, Inc.
No Magic, Inc.
No Magic
Northrop Grumman
OSD
Raytheon
Raytheon
Rolls Royce
Cisco
Silver Bullet
Silver Bullet
Sparx Systems
Swedish Armed Forces
Visumpoint
Visumpoint

Fatma Dandashi
Adrian Pearson
Patrick Gorman
John Keefe
Ian Bailey
Daniel Brookshier
Aurelijus Morkevicius
Jim Rice
Amelia Shroyer
Andrius Strazdauskas
J. D. Baker
Jeff Wilson
Dwayne Hardy
Ron Williamson
Wally Lee, PhD
Francis Thom
Fariba Hozhabrafkan
Dave McDaniel
Greg Schaefer
Sam Mancarella
Mikael Hagenbo
Robert Lario
Ginna Yost

The team would like to express their thanks to all of the above individuals and many others who are not listed.

Once again, it is important to stress that UPDM 2.0 is not a new framework. Instead, UPDM 2.0 is a specification for modeling DoDAF and MODAF architectures using UML and SysML. As such, it could not have been produced without taking concepts, structures and descriptions, etc, from the DoDAF and MODAF documentation and specifications, particularly the M3. The main authors of the M3 were:

V1.0 – Dave Mawby (PA Consulting), Paul King (Vega/ Detica) and Ian Bailey.

V1.1 – Adrian Pearson (MOD), Paul King and Ian Bailey.

V1.2 – Adrian Pearson (MOD), Patrick Gorman (MOD) and Ian Bailey.

The authors of this UPDM 2.0 specification are therefore greatly indebted to organizations and authors who have contributed to all the DoDAF and MODAF specifications over the years. Some of these are listed above. To list all of them would not be possible.

Subpart II - Language Architecture

This subpart contains the following Clause and subclauses:

7. Language Architecture

7.1 Introduction

7.2 Philosophy

7.3 Core Principles

7.4 Profile Structure

7.4.1 Top Level

7.4.2 Middle Level

7.4.3 Low Level

7.5 Representing Stereotype Constraints

7.6 UML Constraint Representation

7.7 Important Areas of the Architecture

7.7.1 Aliases

7.7.2 DoDAF 2.02 Conformance

7.7.3 SoaML Reuse in L0

7.7.4 SysML Reuse in L1

7.7.5 SOPES Reuse in L1

7 Language Architecture

7.1 Introduction

The UPDM specification reuses a subset of UML 2 and provides additional extensions needed to address requirements in the UPDM RFC Mandatory Requirements. We have used those requirements as the basis for this specification. This specification documents the language architecture in terms of the parts of UML 2 that are reused and the extensions to UML 2, as well as defining how to implement UPDM in SysML. This clause explains design principles and how they are applied to define the UPDM language architecture.

7.2 Philosophy

The UPDM was developed using a model-driven approach. A simple description of the work process is:

- The Domain Metamodel (DMM) was created using UML Class models to represent the concepts in DoDAF and MODAF. Concepts common to both DoDAF and MODAF were captured in a Core package.
- The DMM concepts were mapped to corresponding stereotypes in the Profile.
- The Profile was analyzed and refactored to reflect language architecture, tool implementation, and reuse considerations.
- The conformance levels were finalized including mapping to SysML.
- The Profile diagrams, stereotype descriptions, and documentation were added.
- The specification was generated from the profile model.

This approach allowed the team to concentrate on architecture issues rather than documentation production. Consistency was automatically maintained by the UML tool.

The UML tool also enabled traceability to be maintained between the profile and the DMM where every stereotype is linked to the DMM element using UML Abstraction relationship.

7.3 Core Principles

The fundamental design principles for UPDM are:

- **Requirements-driven:** UPDM is intended to satisfy the requirements of the UPDM RFC Mandatory Requirements.
- **Domain meta model (DMM) driven:** The DMM was created first by domain experts and it served as a foundation for profile development.
- **Reuse of existing specifications:** UPDM reuses UML/SysML wherever practical to satisfy the requirements of the UPDM RFC and leverage features from both UML and SysML to provide a robust modeling capability. Consequently, UPDM is intended to be relatively easy to implement for vendors who support UML 2. The UPDM team intended to reuse UPMS. However, since UPMS had not been formally adopted at the time of this specification, a separate service profile in UPDM was developed that used similar concepts, with the intent to replace it with UPMS in the future.
- **Partitioning:** The package is the basic unit of partitioning in this specification. The packages partition the model elements into logical groupings that minimize circular dependencies among them.

- **Compliance levels:** UPDM includes two compliance levels. L0 is a UML only profile and L1 extends L0 to enable seamless integration with SysML modeling and to leverage the features of SysML in UPDM modeling.
- **Interoperability:** UPDM inherits the XMI interchange capability from UML.

7.4 Profile Structure

7.4.1 Top Level

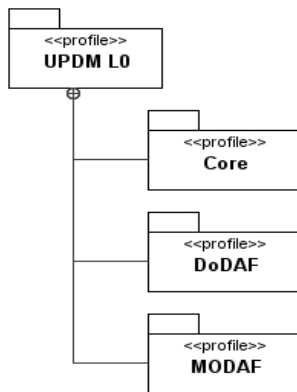

Figure 7.1 - Top Level Profile Structure

All the core elements for UPDM are in the UPDM L0 profile. The UPDM L0 profile has 3 top level profiles:

- **Core** - Elements shared by DoDAF and MODAF
- **DoDAF** - DoDAF specific elements
- **MODAF** - MODAF specific elements

7.4.2 Middle Level

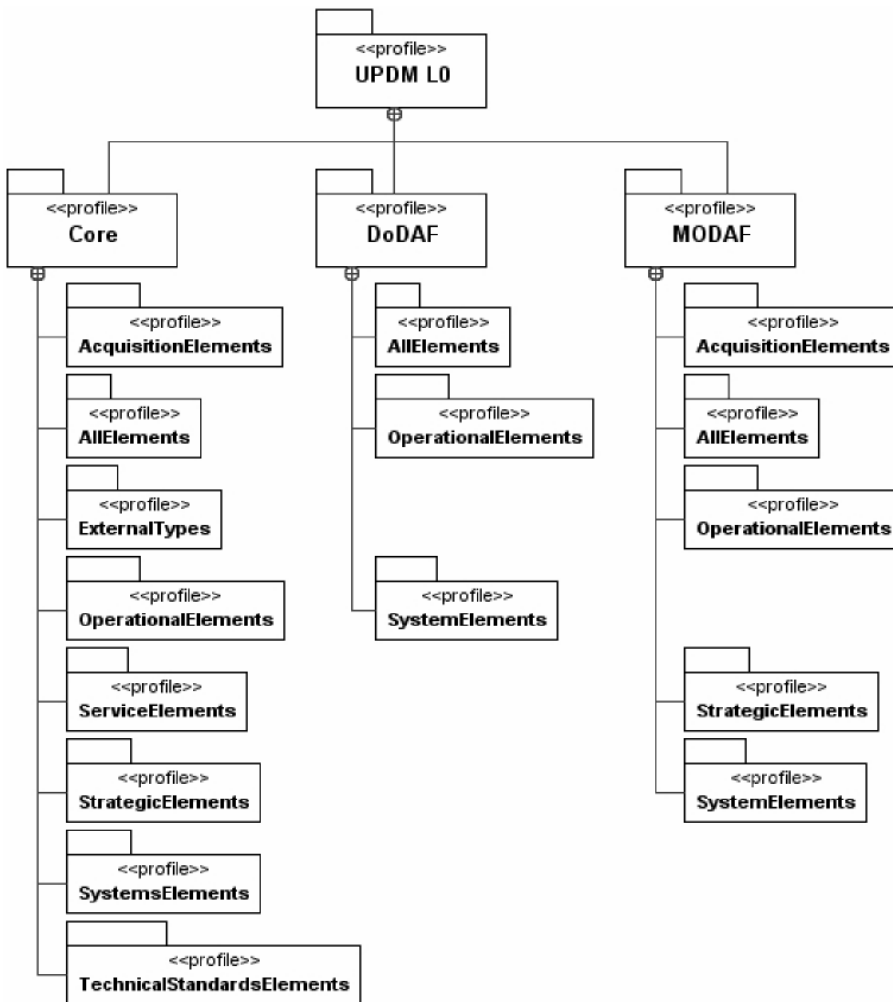

Figure 7.2 - Middle Level Profile Structure

Every top level profile may have the following subprofiles:

- **AllElements** - Cross-cutting elements.
- **AcquisitionElements** - Elements relating to Acquisitions.
- **ExternalTypes** - External types.
- **OperationalElements** - Elements relating to Operational models.
 - **ServiceElements** - Elements relating to Service models.
 - **StrategicElements** - Elements relating to Strategic models.
 - **SystemsElements** - Elements relating to Systems models.
 - **TechnicalStandardsElements** - Elements relating to Technical Standards models.

7.4.3 Low Level

Each of these subprofiles may be further decomposed into low-level profiles:

- **Behavior** - Stereotypes for modeling behavior
- **Data** - Stereotypes for modeling data
- **Environment** - Stereotypes for modeling environment
- **Flows** - Stereotypes for modeling flows
- **Measurements** - Stereotypes for modeling measurements
- **Milestone** - Stereotypes for modeling milestones
- **Structure** - Stereotypes for modeling structure
- **Views** - Stereotypes for modeling views

7.5 Representing Stereotype Constraints

The profile uses a non-standard notation to represent stereotype constraints in the profile to improve readability of the profile.

«metaclass» dependency

«metaclass» is a stereotype that extends the Dependency metaclass. It is used to specify constrained elements within the profile.

A sample of the «metaclass» dependency is a diagram for stereotype extending the Dependency metaclass. See the following example:

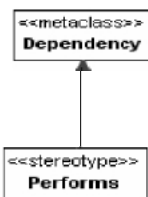

Figure 7.3 - Performs Stereotype

Performs is a stereotype that extends Dependency. The constraint on this stereotype is that its client end must be stereotyped by a Performer and its supplier end must be stereotyped by Activity. But as this constraint is not visible; therefore, the diagram does not communicate the needed information. We are using the “metaclass” dependency to visualize the constraint.

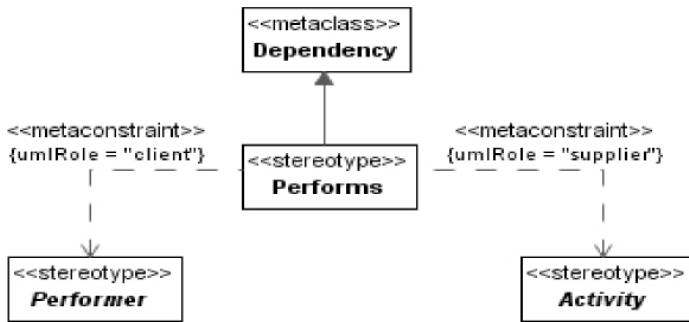

Figure 7.4 - Performs Hierarchy

This diagram should be read as follows:

Performs is a stereotype extending the Dependency metaclass and is used for modeling a relationship between a Performer (or its specializations) and an Activity (or its specializations). A Dependency stereotyped Performs must have its values for the client property stereotyped as Performer, and its values for the supplier property must be stereotyped Activity.

The «metaconstraint» dependency will appear only in the specification diagrams, but not the profile XMI.

Note – When stereotype extends Connector, the stereotype property umlRole has values “end[0].role” and “end[1].role.”

For example:

This is done because Connector has no direct “linkage” to the connected element; it links to the Connector Ends, which references the linked element. So, end[n] gives the reference to the ConnectorEnd, and role gives the reference to the linked element.

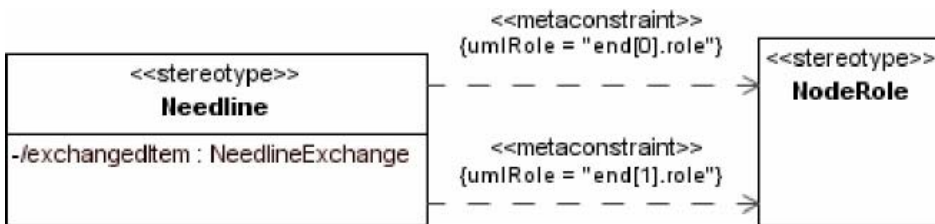

Figure 7.5 - Connector Extension

"metarelationship" dependency

“metarelationship” is a stereotype for dependency, showing that certain domain concepts will be implemented using regular UML relationships.

For example: A Capability may depend on other Capabilities, but this concept cannot be visualized on the diagram:

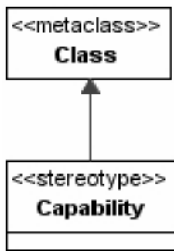

Figure 7.6 - Capabilities Generalization

We are using the “metarelationship” dependency to visualize the dependency concept.

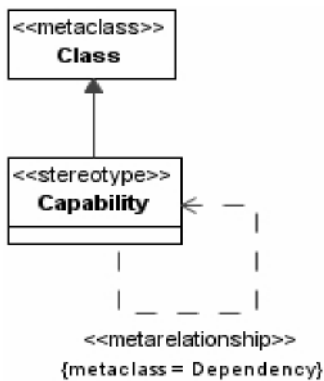

Figure 7.7 - Visualizing «metarelationship»

This diagram should be read as follows:

Capability may have other Capabilities related to it, using the UML Dependency metaclass.

The “metarelationship” dependency will appear only in the specification diagrams, but not the profile XMI.

"stereotyped relationship" dependency

The “metaconstraint” dependency creates a good way to show the constrained ends of the stereotyped relationship, however, it also creates some overhead when showing the relationship between two stereotypes.

For example, the diagram needs to show that Node may require a Capability.



Figure 7.8 - UML Dependency metaclass

The “stereotyped relationship” dependency is used as follows:

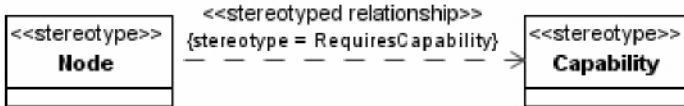

Figure 7.9 - “stereotyped relationship” dependency

The “stereotyped relationship” dependency will appear only in the specification diagrams, but not the profile XMI.

7.6 UML Constraint Representation

The specification uses the Object Constraint Language (OCL), as defined in Clause 6, “Object Constraint Language Specification” of the UML specification, for expressing well-formedness rules. The following conventions are used to promote readability:

- Self - which can be omitted as a reference to the metaclass defining the context of the invariant, has been kept for clarity. UML Infrastructure Specification, v2. 1.2 25
- In expressions where a collection is iterated, an iterator is used for clarity, even when formally unnecessary. The type of the iterator is usually omitted, but included when it adds to understanding.
- The ‘collect’ operation is left implicit where this is practical.
- The context part of an OCL constraint is not included explicitly, as it is well defined in the sub clause where the constraint appears.

The OCL constraints are stored with the profile and can be interchanged via XMI standard. Below is the pattern to represent constraint for stereotyped relationship in OCL as per UML 2.1:

- To constraint the client of the stereotyped relationship that should be a particular stereotyped element:
self.client->forAll(getAppliedStereotype(CLIENT_STEREOTYPE)-> notEmpty())
- To constraint the supplier of the stereotyped relationship that should be a particular stereotyped element:
self.supplier->forAll(getAppliedStereotype(SUPPLIER_STEREOTYPE)-> notEmpty())
- The constraint represented in Figure 7.7 can be represented in OCL as follows:
self.client->forAll(getAppliedStereotype('UPDM: :AllElements: :Behavior : :Performer')-> notEmpty()
self.supplier->forAll(getAppliedStereotype('UPDM: :AllElements: :Behavior : :Activity')->notEmpty())

7.7 Important Areas of the Architecture

7.7.1 Aliases

Although there are similar concepts in DoDAF and MODAF, they are not named the same. To keep interoperability and to fit the needs of both audiences, the UPDM specification used generalizations as a way to alias concepts.

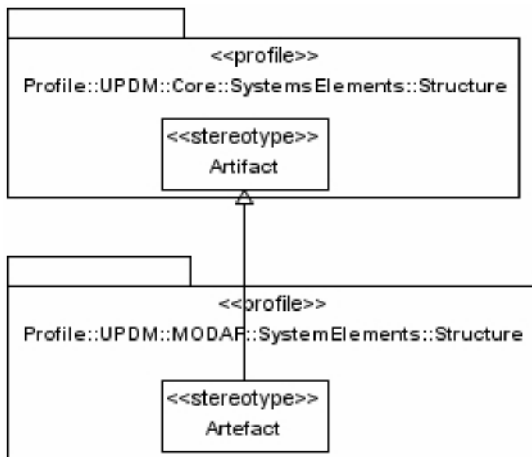

Figure 7.10 - Aliases

7.7.2 DoDAF 2.02 Conformance

Compliance with UPDM 2.0 Profile including metadata should assist the tool vendor in adhering to DoDAF 2.02 because the UPDM 2.0 Core and DoDAF-specific metadata models in UPDM 2.0 adhere to the metadata model inherent in DoDAF 2.02 Conceptual and Logical data models. In developing the UPDM 2.0, domain meta-modelers have also consulted the corresponding Physical data model in DoDAF 2.02 and to resolve questions of general conformance with enterprise-level architectural elements. Nevertheless, tool vendors are advised to consult DoDAF Version 2.02 (especially Volume I, page 2-6; Volume II, page 2-6; and Volume III, page 1-2) before claiming DoDAF 2.02 conformance. While conformance with UPDM 2.0 Core and DoDAF-specifics should greatly facilitate conformance with DoDAF 2.02, each tool vendor is still responsible for the tool's ultimate conformance with the documented architecture framework.

Compliance with UPDM 2.0 Profile including metadata should assist the tool vendor in adhering to DoDAF 2.02 because the UPDM 2.0 Core and DoDAF-specific metadata models in UPDM 2.02 adhere to the metadata model inherent in DoDAF 2.02 Conceptual and Logical data models. In developing the UPDM 2.0, domain meta-modelers have also consulted the corresponding Physical data model in DoDAF 2.02 to resolve questions of general conformance with enterprise-level architectural elements. Nevertheless, tool vendors are advised to consult DoDAF Version 2.02 before claiming DoDAF 2.02 compliance.

The DoD-CIO has clarified in a Decision Brief of 12 Jan 11 that it does not expect UPDM 2.0 to export models in PES, nor to provide an implementation of 4D (geo-spatial-temporal modeling) including a global implementation of Whole-Part and Temporal-Whole-Part for all UPDM elements (classes/objects).

The UPDM Profile to DoDAF Metamodel Compliance Matrix has been published as non-normative Annex C of the specification to aid tool vendors in their claims to DoDAF Level 2 Conformance. This matrix should also facilitate upgrades to Level 3 and 4 of DoDAF Conformance in future versions of UPDM.

7.7.3 SoaML Reuse in L0

SoaML is quickly becoming the standard modeling choice for capturing and creating service oriented architectures. By importing the SoaML stereotypes, a UPDM model gains access to these powerful features. They can be used and viewed in a UPDM model using the standard SoaML approach and as such have not been further documented.

7.7.4 SysML Reuse in L1

Defining an architectural framework in UPDM provides the highest level abstraction of what will one day become integrated pieces of hardware and software. Being able to trace from the architectural framework to the various levels of implementation is critical for ensuring the initial goals have been reached. By including the full SysML profile inside UPDM, a modeler can have all of the architectural, system, and software design in the same place. This provides huge benefits in analysis, cross abstraction level communication, traceability, and reuse. As in L0, all of the stereotypes contained in SysML can be used and displayed using standard SysML approaches while still being able to be connected to UPDM elements such as Nodes and Artifacts.

7.7.5 SOPES Reuse in L1

SOPES IEDM use of UML is becoming a standards based model for specifying and describing the rules governing the aggregation, marshalling, and processing of information across system interfaces. By importing the SOPES stereotypes, a UPDM 2.0 models gains higher fidelity in the specification and design of information exchange requirements. Additional information on the SOPES modeling approach can be found in <http://www.omg.org/spec/SOPES/>.

Subpart III - UPDM Profile

This subpart contains the following Clause and sub clauses:

- 8.1 DoDAF Class Library
 - 8.1.1 ClassificationType
 - 8.1.1.1 Enumeration Literals
 - 8.1.2 CommunicationsLinkProperties
 - 8.1.3 DataElementProperties
 - 8.1.4 ExchangeProperties
 - 8.1.5 InformationAssuranceProperties
 - 8.1.6 InformationElementProperties
 - 8.1.7 OperationalActivityProperties
 - 8.1.8 SecurityAttributes
- 8.2 UPDM L1
 - 8.2.1 UPDM L1::UPDM L0
 - 8.2.1.1 UPDM L1::UPDM L0::Core
- 8.3 ActualProject
 - 8.3.1. OrganizationalProjectRelationship
 - 8.3.1.1 ProjectType
 - 8.3.1.2 ActualProjectMilestoneRole
 - 8.3.1.3 ProjectMilestoneRole
 - 8.1.1.4 UPDM L1::UPDM L0::DoDAF
 - 8.1.1.5 UPDM L1::UPDM L0::MODAF
 - 8.1.1.6 UPDM L1::UPDM L0::SOPES
 - 8.1.1.7 UPDM L1::UPDM L0::SwAF

8 UPDM Profile

UPDM L1 contains UPDM L0 and imports the entire SysML profile. This compliance level contains a set of constraints that specify which SysML stereotypes are applied to the L0 elements. The use of this compliance level is intended to provide more seamless integration with system modeling using SysML and to be able to fully leverage the capabilities of SysML in UPDM.

8.1 DoDAF Class Library

A library of Measurements, MeasurementSets, and SecurityAttributesGroup derived from DoDAF.



Figure 8.1 - DoDAF Class Library

8.1.1 ClassificationType

Enumeration of types of security classification, derived from DoDAF.

8.1.1.1 Enumeration Literals

The following are enumeration literals for ClassificationType:

C	Confidential
CTS	COSMIC TOP SECRET

CTS-V	COSMIC TOP SECRET - BOHEMIA
CTS-BALK	COSMIC TOP SECRET - BALK
CTSA	COSMIC TOP SECRET ATOMAL
NC	NATO Confidential
NCA	NATO Confidential Atomal
NR	NATO Restricted (similar to US For Official Use only)
NS	NATO Secret
NS-A	NATO Atomal
NS-S	NATO Secret
NSAT	NATO Secret Atomal
NU	NATO Unclassified
R	Restricted Data (RD) US Nuclear Information OR FOR OFFICIAL USE ONLY
S	Secret
TS	Top Secret
U	Unclassified

8.1.2 CommunicationsLinkProperties

Properties detailing aspects of Resource Interfaces.

8.1.3 DataElementProperties

Properties detailing the aspects of a DataElement.

8.1.4 ExchangeProperties

Properties detailing aspects of exchange for Operational Exchange and/or Resource Interaction.

8.1.5 InformationAssuranceProperties

Properties indicating the assurance of a piece of information.

8.1.6 InformationElementProperties

Predefined additional DoDAF properties for InformationElement.

8.1.7 OperationalActivityProperties

Properties detailing aspects OperationalActivities.

8.1.8 SecurityAttributes

W3C XML Schema for the Intelligence Community Metadata Standard for Information Security Marking (IC-ISM), which is part of the IC standards for Information Assurance.

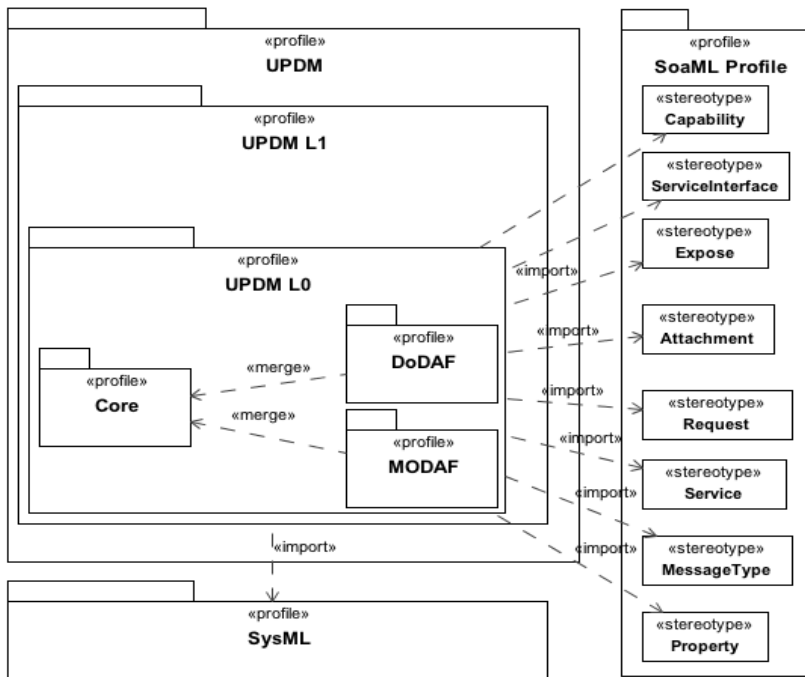

Figure 8.2 - UPDM Profile

8.2 UPDM L1

UPDM L1 contains UPDM L0 and imports the entire SysML profile. This compliance level contains a set of constraints that specify which SysML stereotypes are applied to the L0 elements. The use of this compliance level is intended to provide more seamless integration with system modeling using SysML and to be able to fully leverage the capabilities of SysML in UPDM.

Capability

context Class inv:

UPDM::Capability::allInstances()->exists(n|n.base_Class=self) implies

SysML::Block::allInstances()->exists(b|b.base_Class = self)

CapabilityConfiguration

context Class inv:

UPDM::CapabilityConfiguration::allInstances()->exists(n|n.base_Class=self) implies

SysML::Block::allInstances()->exists(b| b.base_Class = self)

Climate

context DataType inv:
UPDM::Climate::allInstances()->exists(n|n.base_Class=self) implies
SysML::ValueType::allInstances()->exists(b|b.base_Class = self)

Commands

context InformationFlow inv:
UPDM::Commands::allInstances()->exists(n|n.base_Class=self) implies
SysML::ItemFlow::allInstances()->exists(b|b.base_Class = self)

Condition

context DataType inv:
UPDM::Condition::allInstances()->exists(n|n.base_Class=self) implies
SysML::ValueType::allInstances()->exists(b| b.base_Class = self)

Control

context InformationFlow inv:
UPDM::Controls::allInstances()->exists(n|n.base_Class=self) implies
SysML::ItemFlow: :allInstances()->exists(b|b.base_Class = self)

Energy

context Class inv:
UPDM::Energy::allInstances()->exists(n|n.base_Class=self) implies
SysML::Block: :allInstances()->exists(b|b.base_Class = self)

EnterpriseGoal

context Class inv:
UPDM::EnterpriseGoal::allInstances()->exists(n|n.base_Class=self) implies
SysML::Requirement: allInstances()->exists(b| b.base_Class = self)

EntityItem

context Class inv:
UPDM::EntityItem::allInstances()->exists(n|n.base_Class=self) implies
SysML::Block::allInstances()->exists(b|b.base_Class = self)

Environment

context DataType inv:
UPDM::Environment::allInstances()->exists(n|n.base_Class=self) implies
SysML::ValueType::allInstances()->exists(b|b.base_Class = self)

ExchangeElement

context DataType inv:
UPDM::ExchangeElement::allInstances()->exists(n|n.base_Class=self) implies
SysML::Block::allInstances()->exists(b|b.base_Class = self)

ExternalType

context Class inv:
UPDM::ExternalType::allInstances()->exists(n|n.base_Class=self) implies
SysML::Block::allInstances()->exists(b|b.base_Class = self)

GeoPoliticalExtentType

context DataType inv:
UPDM::GeoPoliticalExtentType::allInstances()->exists(n|n.base_Class=self) implies
SysML::ValueType::allInstances()->exists(b| b.base_Class = self)

HighLevelOperationalConcept

context Class inv:

UPDM::HighLevelOperationalConcept::allInstances()->exists(n|n.base_Class=self) implies

SysML::Block::allInstances()->exists(b| b.base_Class = self)

LightCondition

context DataType inv:

UPDM::LightCondition::allInstances()->exists(n|n.base_Class=self) implies

SysML::ValueType::allInstances()->exists(b| b.base_Class = self)

LocationType

context DataType inv:

UPDM::LocationType::allInstances()->exists(n|n.base_Class=self) implies

SysML::ValueType::allInstances()->exists(b|b.base_Class = self)

LogicalArchitecture

context Class inv:

UPDM::LogicalArchitecture::allInstances()->exists(n|n.base_Class=self) implies

SysML::Block::allInstances()->exists(b|b.base_Class = self)

Materiel

context Class inv:

UPDM::Materiel::allInstances()->exists(n|n.base_Class=self) implies

SysML::Block::allInstances()->exists(b| b.base_Class = self)

MeasurementSet

context DataType inv:

UPDM::MeasurementSet::allInstances()->exists(n|n.base_Class=self) implies

SysML::ValueType::allInstances()->exists(b| b.base_Class = self)

Node

context Class inv:

UPDM::Node::allInstances()->exists(n|n.base_Class=self) implies

SysML::Block::allInstances()->exists(b|b.base_Class = self)

NodePort

context Port inv:

UPDM::NodePort::allInstances()->exists(n|n.base_Class=self) implies

SysML::FlowPort::allInstances()->exists(b|b.base_Class = self)

OperationalExchange

context InformationFlow inv:

UPDM::OperationalExchange::allInstances()->exists(n|n.base_Class=self) implies

SysML::ItemFlow::allInstances()->exists(b|b.base_Class = self)

Organization

context Class inv:

UPDM::Organization::allInstances()->exists(n|n.base_Class=self) implies

SysML::Block::allInstances()->exists(b| b.base_Class = self)

OrganizationType

context Class inv:

UPDM::OrganizationType::allInstances()->exists(n|n.base_Class=self) implies

SysML::Block::allInstances()->exists(b| b.base_Class = self)

Performer

context Class inv:

UPDM::Performer::allInstances()->exists(n|n.base_Class=self) implies

SysML::Block::allInstances()->exists(b| b.base_Class = self)

PersonType

context Class inv:

UPDM::PersonType::allInstances()->exists(n|n.base_Class=self) implies

SysML::Block::allInstances()->exists(b| b.base_Class = self)

PhysicalArchitecture

context Class inv:

UPDM::PhysicalArchitecture::allInstances()->exists(n|n.base_Class=self) implies

SysML::Block::allInstances()->exists(b| b.base_Class = self)

Post

context Class inv:

UPDM::Post::allInstances()->exists(n|n.base_Class=self) implies

SysML::Block::allInstances()->exists(b| b.base_Class = self)

ResourceArtifact

context Class inv:

UPDM::ResourceArtifact::allInstances()->exists(n|n.base_Class=self) implies

SysML::Block::allInstances()->exists(b| b.base_Class = self)

ResourceInteraction

context InformationFlow inv:

UPDM::ResourceInteraction::allInstances()->exists(n|n.base_Class=self) implies

SysML::ItemFlow::allInstances()->exists(b| b.base_Class = self)

ResourcePort

context Port inv:

UPDM::ResourcePort::allInstances()->exists(n|n.base_Class=self) implies

SysML::FlowPort::allInstances()->exists(b|b.base_Class = self)

Responsibility

context Class inv:

UPDM::Responsibility::allInstances()->exists(n|n.base_Class=self) implies

SysML::Block::allInstances()->exists(b|b.base_Class = self)

RoleType

context Class inv:

UPDM::RoleType::allInstances()->exists(n|n.base_Class=self) implies

SysML::Block::allInstances()->exists(b|b.base_Class = self)

SecurityAttributesGroup

context DataType inv:

UPDM::SecurityAttributesGroup::allInstances()->exists(n|n.base_Class=self) implies

SysML::ValueType::allInstances()->exists(b|b.base_Class = self)

SecurityDomain

context Class inv:

UPDM::Node::allInstances()->exists(n|n.base_Class=self) implies

SysML::Block::allInstances()->exists(b|b.base_Class = self)

ServiceAccess

context Class inv:

UPDM::ServiceAccess::allInstances()->exists(n|n.base_Class=self) implies

SysML::Block::allInstances()->exists(b|b.base_Class = self)

Software

context Class inv:

UPDM::Software::allInstances()->exists(n|n.base_Class=self) implies

SysML::Block::allInstances()->exists(b|b.base_Class = self)

System

context Class inv:

UPDM::System::allInstances()->exists(n|n.base_Class=self) implies

SysML::Block::allInstances()->exists(b|b.base_Class = self)

8.2.1 UPDM L1::UPDM L0

UPDM L0 contains all the Core, DoDAF, and MODAF elements, and imports parts of SysML - Requirements and ModelElements namely. This compliance level is primarily based on UML and reuse of a minimum of SysML elements. This includes Requirements and Views/Viewpoints. As one of the core principles is reuse, cloning/recreating of these existing SysML structures was considered as inappropriate.

8.2.1.1 UPDM L1::UPDM L0::Core

The Core contains most of the elements of UPDM profile. These elements are common to both DoDAF and MoDAF or are critical to a complete model of core concepts. The Core is always associated with either the DoDAF or MoDAF profiles.

If desired, there is no prohibition of using both MODAF, DoDAF, and Core should the end-user desire to use some or all of the concepts represented.

8.2.1.1.1 UPDM L1 ::UPDM L0::Core::AcquisitionElements

The AcquisitionElements describe project details, including dependencies between projects and capability integration. These Views guide the acquisition and fielding processes.

8.2.1.1.2 UPDM L1::UPDM L0::Core::AcquisitionElements::Milestone

Milestone elements from the acquisition section of the profile.

8.3 ActualProject

MODAF: (MODAF::Project): A time-limited endeavor to create a specific set of products or services.

DoDAF: (DoDAF::Project): A temporary endeavor undertaken to create Resources or Desired Effects.

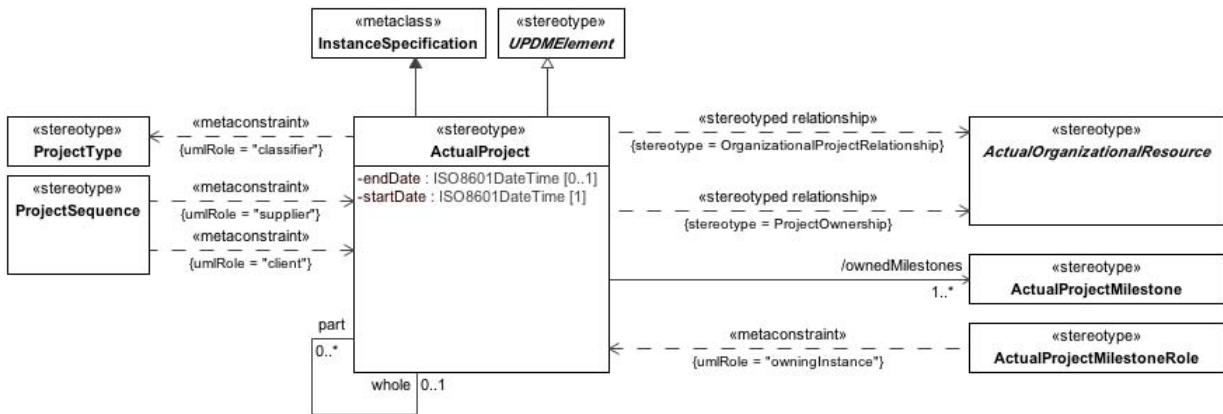

Figure 8.3 - ActualProject

Elements related to the Project stereotype.

Constraints

The following are constraints for ActualProject:

- ActualProject.classifier - Classifier property value must be stereotyped "Project" or its specializations.

Attribute

The following are attributes for ActualProject:

- endDate : ISO8601DateTime[0..1] - End time for this Project.
- ownedMilestones : ActualProjectMilestone[1..*] - Milestones associates with this project.
- part : ActualProject[0..*] - Sub-projects.
- startDate : ISO8601DateTime[1] - Start time for this Project.
- whole : ActualProject[0..1] - Parent project.

Extensions

The following are extensions for ActualProject:

- InstanceSpecification

Generalizations

The following are generalization relationships for ActualProject:

- UPDMElement

8.3.1 OrganizationalProjectRelationship

MODAF: A relationship between an ActualOrganization and a Project.

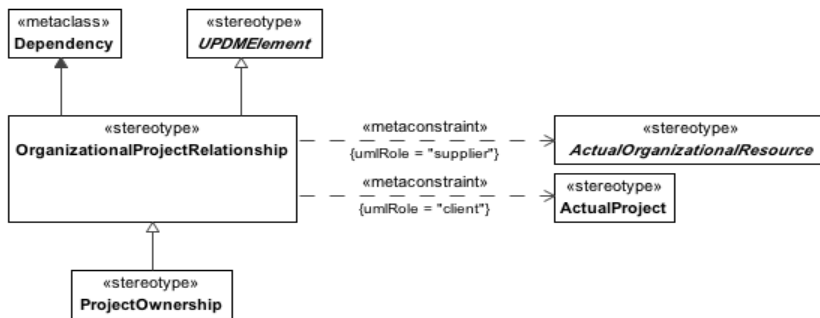

Figure 8.4 - OrganizationalProjectRelationship

Constraints

The following are constraints for OrganizationalProjectRelationship:

- OrganizationalProjectRelationship.client - Value for the client property must be stereotyped “ActualProject” or its specializations.
- OrganizationalProjectRelationship.supplier - Value for the supplier property must be stereotyped a specialization of “ActualOrganizationalResource.”

Extensions

The following are extensions for OrganizationalProjectRelationship:

- Dependency

Generalizations

The following are generalization relationships for OrganizationalProjectRelationship:

- UPDMElement

8.3.1.1 ProjectType

MODAF: A Project (MODAF::ProjectType) is used to define a category of project: For example, “Programme,” “Acquisition Project,” or “Training Programme.”

DoDAF: NA (only Individual Project in DoDAF).

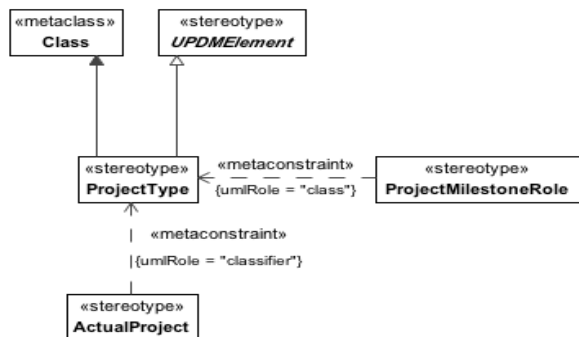

Figure 8.5 - ProjectType

Constraints

The following are constraints for ProjectType:

- Project.ownedAttribute - Values for ownedAttribute property must be stereotyped “ProjectMilestoneRole” or its specializations.

Extensions

The following are extensions for Project:

- Class

Generalizations

The following are generalization relationships for Project:

- UPDMElement
- Desirer

8.3.1.2 ActualProjectMilestoneRole

UPDM: An instance of a ProjectMilestoneRole in the context of an ActualProject.

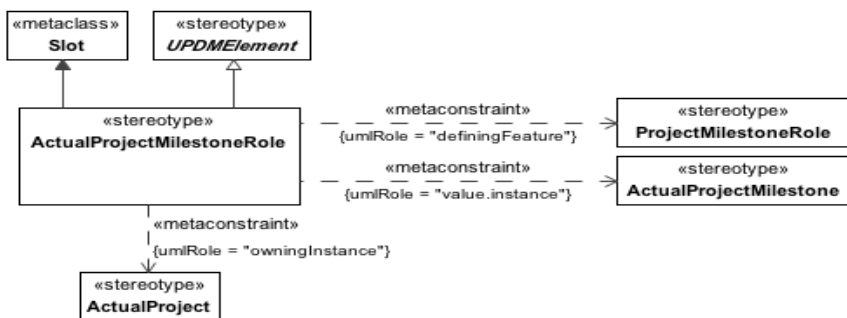

Figure 8.6 - ActualProjectMilestoneRole

Constraints

The following are constraints for ActualProjectMilestoneRole:

- ActualProjectMilestoneRole.definingFeature - Value for definingFeature property has to be stereotyped “ProjectMilestoneRole” or its specializations.
- ActualProjectMilestoneRole.owningInstance - Value for owningInstance property has to be stereotyped “ActualProject” or its specializations.

Extensions

The following metaclasses are extended by ActualProjectMilestoneRole:

- Slot

Specializations

The ActualProjectMilestoneRole element is a specialization of:

- UPDMElement

8.3.1.3 ProjectMilestoneRole

UPDM: The role played by a ProjectMilestone in the context of an ActualProjectMilestone.

MODAF: NA

DoDAF: NA

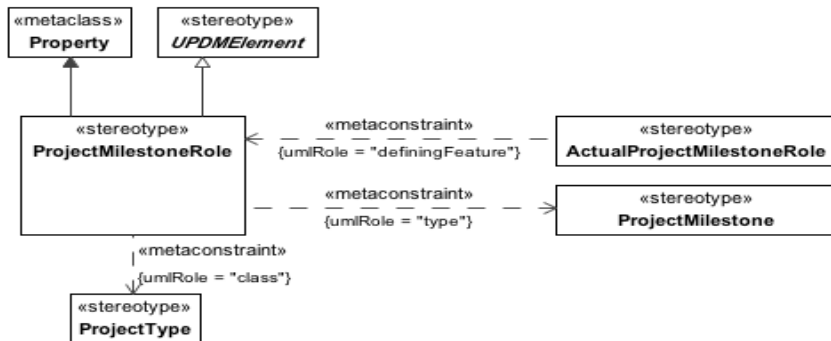

Figure 8.7 - ProjectMilestoneRole

Constraints

The following are constraints for ProjectMilestoneRole:

- ProjectMilestoneRole.class - Value for the class property must be stereotyped “Project” or its specializations.
- ProjectMilestoneRole.type - Value for the type property must be stereotyped “ProjectMilestone” or its specializations.

Extensions

The following metaclasses are extended by ProjectMilestoneRole:

- Property

Specializations

The ProjectMilestoneRole element is a specialization of:

- UPDMElement

8.3.1.3.1 UPDM L1::UPDM L0::Core::AllElements

The AllElements are elements that are part of the All View. The All-Views (AVs) provide an overarching description of the architecture, its scope, ownership, timeframe and all of the other meta data that is required in order to effectively search and query architectural models. They also provide a place to record any findings arising from the architecting process. The AVs include a dictionary of the terms used in the construction of the architecture - which helps others fully understand its meaning at a later date. Since the AVs provide critical information for the future access and exploitation of an architectural model their population is essential whenever an architecture is created or modified. The AVs provide a critical input into the processes that provide architectural governance.

8.3.1.3.1.1 UPDMElement

UPDM Artifact: Super type for many of the UPDM elements. It provides a means of extending UPDM elements in a common way. With links to the measurement set, it also allows quantitative metrics to be associated with structural and behavioral elements.

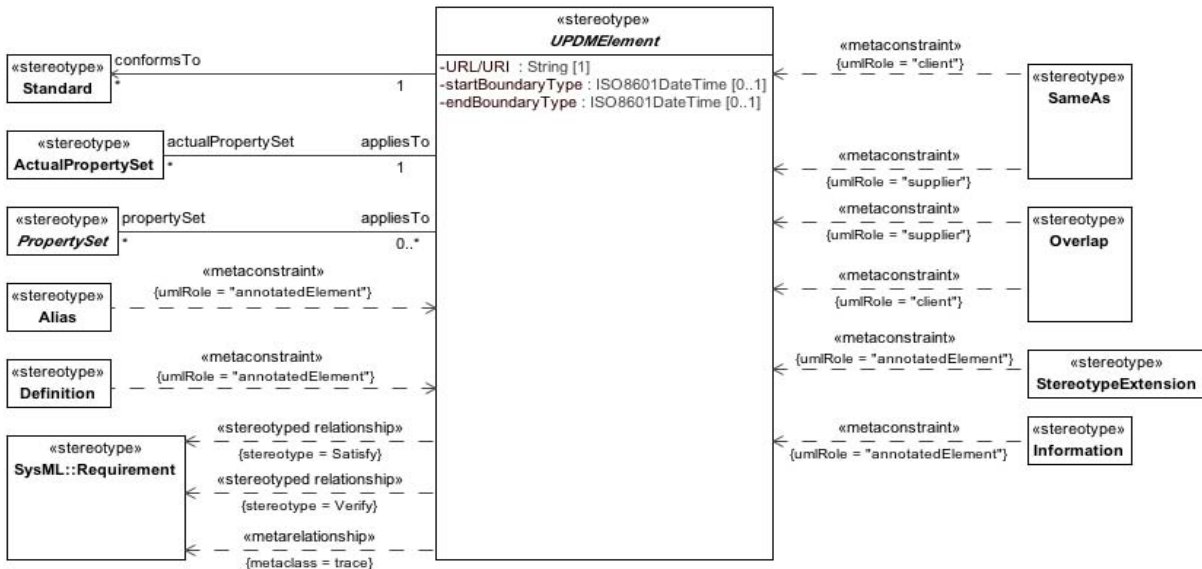

Figure 8.8 - UPDMElement

Standard that this UPDM element is conforming to.

Attribute

The following are attributes for UPDMElement:

- actualPropertySets : ActualPropertySet[*] - The actual measurements to which the element must conform.
- conformsTo : Standard[*] - Standard that this UPDM element is conforming to.
- endBoundaryType : ISO8601DateTime[0..1] -
- propertySets : PropertySet[*] - Types of measurements corresponding to the actual measurements.
- startBoundaryType : ISO8601DateTime[0..1] -
- URL/URI : String[1] - Unique identifier for the element.

8.3.1.3.1.2 Exchange

UPDM: Abstract grouping for interactions that exchange messages.

MODAF:NA

DoDAF:NA

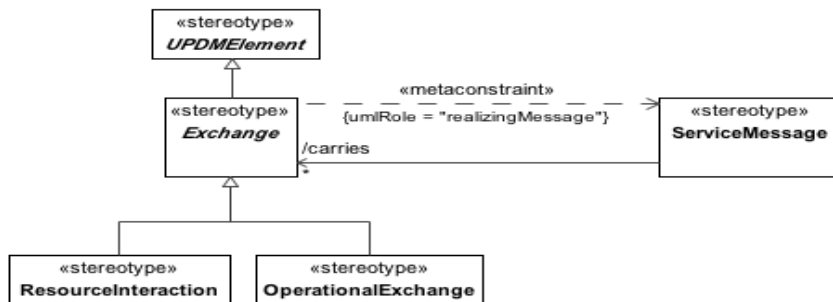

Figure 8.9 - Exchange

Generalizations

The following are generalization relationships for Exchange:

- UPDMElement

8.3.1.3.1.3 ExchangeItem

UPDM: Abstract grouping for types of information to be exchanged.

MODAF:NA

DoDAF:NA

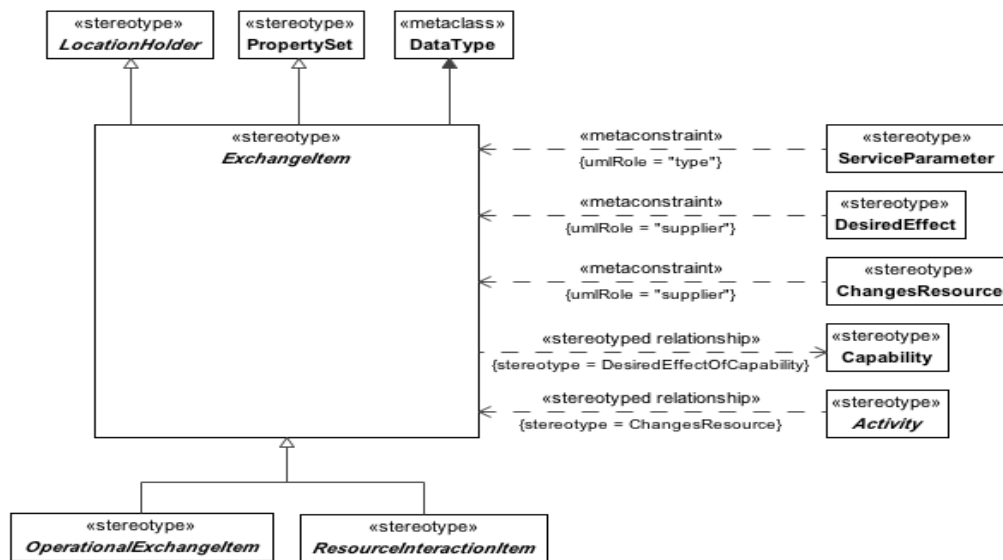

Figure 8.10 - ExchangeItem

Extensions

The following are extensions for ExchangeItem:

- DataType

Generalizations

The following are generalization relationships for ExchangeItem:

- PropertySet
- LocationHolder

8.3.1.3.1.4 UPDM L1::UPDM L0::Core::AllElements::Behavior

The behavioral portion of the AllElements profile.

8.3.1.3.1.4.1 Activity

UPDM: An abstract element that represents a behavior (i.e., a Function or OperationalActivity) that can be performed by a Performer.

MODAF: NA

DoDAF: Work, not specific to a single organization, weapon system or individual that transforms inputs (Resources) into outputs (Resources) or changes their state.

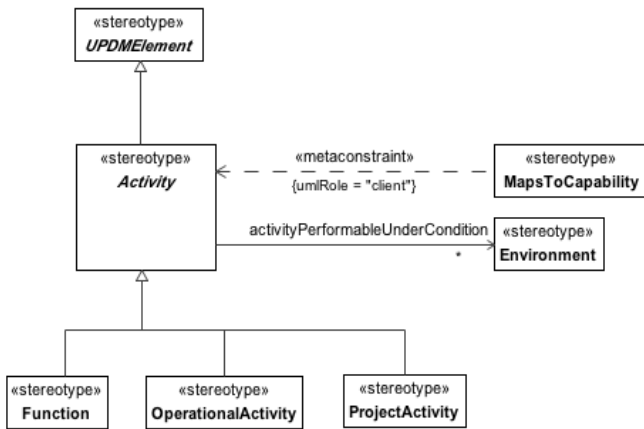

Figure 8.11 - Activity

Generalizations

The following are generalization relationships for Activity:

- UPDMElement
- Desirer

8.3.1.3.1.4.1.1 Implements

UPDM: Tuple defining the relationship between systems and service elements and operational elements

MODAF: ActivityToFunctionMapping, Asserts that a Function (at least in part) performs or assists in the conducting of an OperationalActivity.

DoDAF: N/A

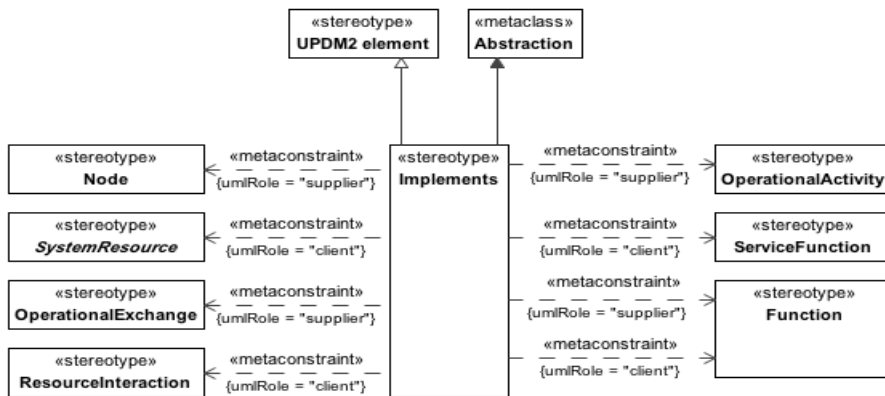

Figure 8.12 - Implements

Constraints

The following are constraints for Implements:

- Implements.client - Values for the client property must be stereotyped “SystemResource,” “ResourceInteraction,” “Function,” “ServiceFunction,” or their specializations.
- Implements.supplier - Values for the supplier property must be stereotyped “Node,” “OperationalActivity,” “OperationalExchange,” “Function,” or their specializations.

Extensions

The following metaclasses are extended by Implements:

- Abstraction

Specializations

The Implements element is a specialization of:

- UPDM2 element

8.3.1.3.1.4.2 IsCapableOfPerforming

UPDM: Links a Performer to the behavior that it can perform.

DoDAF: The Performs (DoDAF::activityPerformedByPerformer) relationship is an overlap between a Performer and a PerformedActivity (DoDAF::Activity) wherein the activity is performed by the Performer.

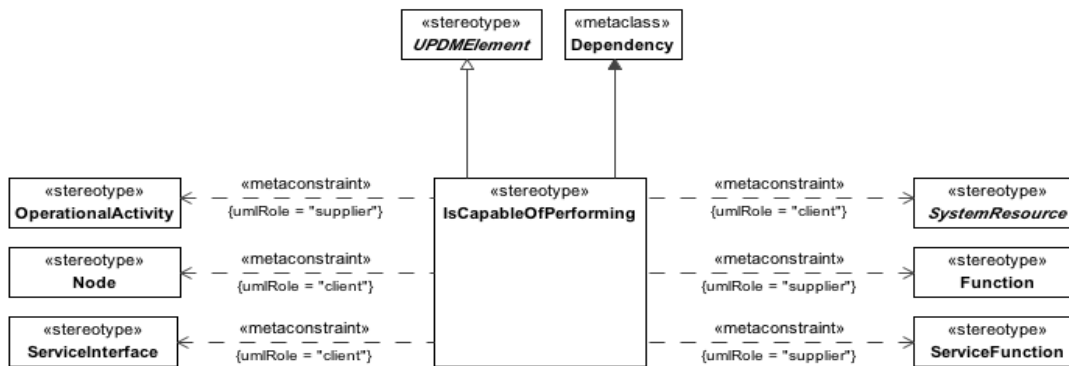

Figure 8.13 - IsCapableOfPerforming

Constraints

The following are constraints for IsCapableOfPerforming:

- IsCapableOfPerforming.client - Values for the client property must be stereotyped “Node,” “SystemResource,” “ServiceInterface,” or their specializations.
- IsCapableOfPerforming.supplier - Values for the supplier property must be stereotyped “OperationalActivity,” “Function,” “ServiceFunction,” or their specializations.

Extensions

The following metaclasses are extended by IsCapableOfPerforming:

- Dependency

Specializations

The IsCapableOfPerforming element is a specialization of:

- UPDMElement

8.3.1.3.1.4.3 CapableElement

UPDM An abstract element that represents a structural element that can perform behaviors (i.e., PerformedActivity).

DoDAF: NA

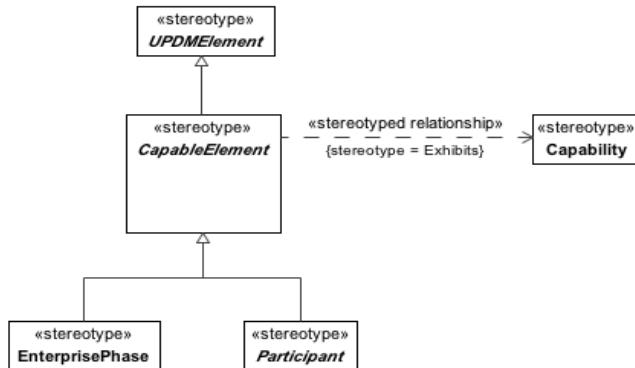

Figure 8.14 - CapableElement

Generalizations

The following are generalization relationships for CapableElement:

- UPDMElement
- Participant

8.3.1.3.1.5 UPDM L1::UPDM L0::Core::AllElements::Environment

The environmental aspects of the AllElements profile.

8.3.1.3.1.5.1 LocationHolder

UPDM:Abstract grouping to capture elements that can have a location.

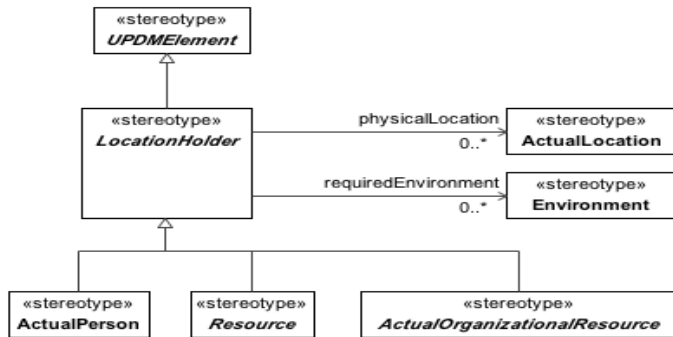

Figure 8.15 - LocationHolder

Attribute

The following are attributes for LocationHolder:

- physicalLocation : PhysicalLocation[0..1] -
- requiredLocation : Location[0..1] -

Generalizations

The following are generalization relationships for LocationHolder:

- UPDMElement

8.3.1.3.1.5.2 ActualLocation

MODAF: A PhysicalLocation (MODAF::ActualLocation) is a location anywhere on the earth. The means of describing the location is a string (locationDescription). The information contained in that string is governed by the taxonomy reference (e.g., if the PhysicalLocation is a “GPS reference,” the string will contain the GPS coordinates).

NOTE: This has been extended in UPDM to include non-earth locations.

DoDAF: All subtypes of << IndividualType >> Location, such as Facility, Site, etc.

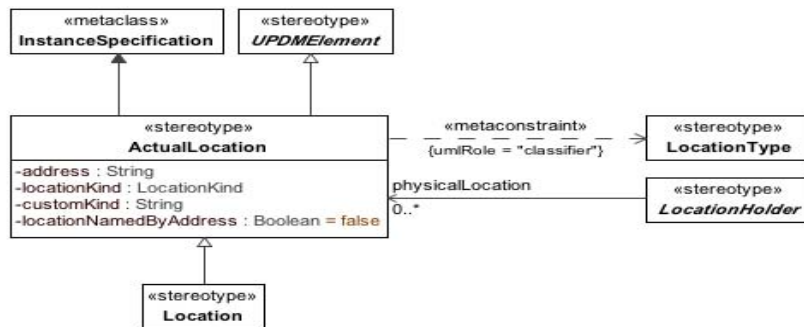

Figure 8.16 - ActualLocation

Constraints

The following are constraints for ActualLocation:

- ActualLocation.classifier - Classifier property value must be stereotyped “LocationType” or its specializations.

Extensions

The following metaclasses are extended by ActualLocation:

- InstanceSpecification

Specializations

The ActualLocation element is a specialization of:

- UPDMElement

8.3.1.3.1.5.3 ConditionType

Abstract element indicating what an EnvironmentProperty can be typed by.

NOTE: ConditionType is abstract.

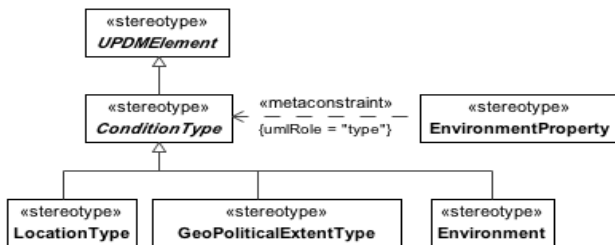

Figure 8.17 - ConditionType

Specializations

The ConditionType element is a specialization of:

- UPDMElement

8.3.1.3.1.5.4 Environment

MODAF:A definition of the conditions in which something exists or functions.

DoDAF:NA

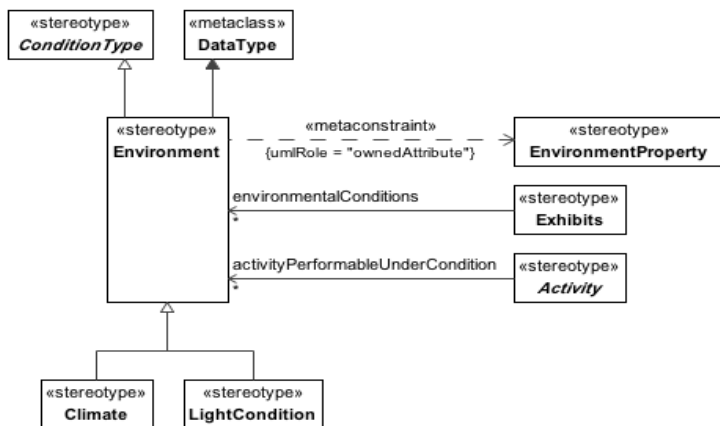

Figure 8.18 - Environment

Constraints

The following are constraints for Environment:

- Environment.ownedAttributes - Owned attributes have to be stereotyped <<EnvironmentProperty>>.

Extensions

The following metaclasses are extended by Environment:

- DataType

Specializations

The Environment element is a specialization of:

- ConditionType
- PropertySet

8.3.1.3.1.5.5 EnvironmentProperty

MODAF: Asserts that an Environment has one or more properties. These may be Climate, LocationType, or LightCondition.

DoDAF: NA

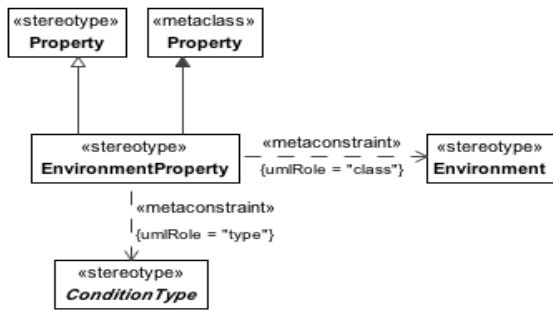

Figure 8.19 - EnvironmentProperty

Constraints

The following are constraints for EnvironmentProperty:

- EnvironmentalProperty.class - Value for the class property must be stereotyped “Environment” or its specializations.
- EnvironmentalProperty.type - Value for the type property must be stereotyped “ConditionType” or its specializations.

Extensions

The following metaclasses are extended by EnvironmentProperty:

- Property

Specializations

The EnvironmentProperty element is a specialization of:

- Property

8.3.1.3.1.5.6 LocationHolder

UPDM:Abstract grouping to capture elements that can have a location.

NOTE: LocationHolder is abstract.

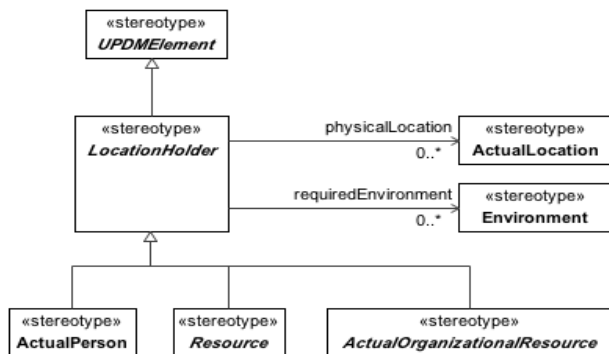

Figure 8.20 - LocationHolder

Specializations

The LocationHolder element is a specialization of:

- UPDMElement

8.3.1.3.1.5.7 LocationKind

Enumeration of location kinds, derived from DoDAF, used to support the locationKind tag of the LocationKind stereotype.

Enumeration Literals

The following are enumeration literals for LocationKind:

- CircularArea - The space enclosed by a circle.
- EllipticalArea - The space enclosed by an ellipse.
- GeoStationaryPoint - Unidimensional Individual (dimensionless in space, existent over all time).
- Line - A geometric figure formed by a point moving along a fixed direction and the reverse direction.
- Other - Other Location kind that is not on the enumerated list.
- PlanarSurface - A two-dimensional portion of space.
- Point - Unidimensional Individual (dimensionless in space, existent over all time).
- PolygonArea - The space enclosed by a polygon.
- RectangularArea - The space enclosed by a rectangle.
- SolidVolume - The amount of space occupied by a three-dimensional object

8.3.1.3.1.5.8 LocationType

MODAF: A general specification of the surroundings / scenario in which an operation may take place. Examples would be: “desert,” “arctic,” “at sea,” etc.

DoDAF: A point or extent in space that may be referred to physically or logically. Includes concepts such as: Facility, Installation, RealProperty, Site, , and instances of conditions such as underwater (as specified in UJTLS).

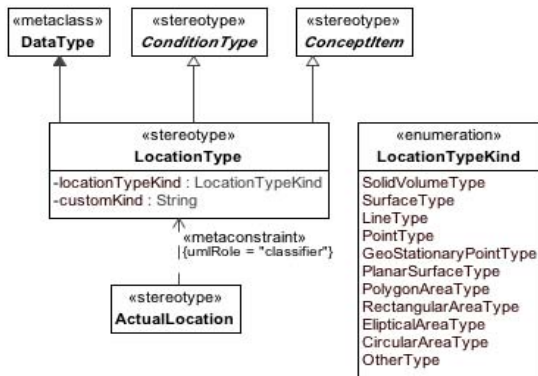

Figure 8.21 - LocationType

Extensions

The following metaclasses are extended by LocationType:

- DataType

Specializations

The LocationType element is a specialization of:

- ConceptItem
- ConditionType

8.3.1.3.1.5.9 LocationTypeKind

Enumeration of kinds of location types, derived from DoDAF, used to support the LocationTypeKind tag of the LocationTypeKind stereotype.

Enumeration Literals

The following are enumeration literals for LocationTypeKind:

- CircularAreaType - Powertype Of CircularArea.
- EllipticalAreaType - Powertype Of EllipticalArea.
- GeoStationaryPointType - Powertype Of GeoStationaryPoint.
- LineType - Powertype Of Line.
- OtherType - Other LocationType kind that is not on the enumerated list.
- PlanarSurfaceType - Powertype Of PlanarSurface.
- PointType - Powertype Of Point.

- PolygonAreaType - Powertype Of PolygonArea.
- RectangularAreaType - Powertype Of RectangularArea.
- SolidVolumeType - Powertype Of SolidVolume.
- SurfaceType - Powertype Of Surface.

8.3.1.3.1.6 UPDM L1::UPDM L0::Core::AllElements::Measurements

The measurement portion of the AllElements profile.

8.3.1.3.1.6.1 ActualMeasurement

UPDM: An actual value of the Measurement.

MODAF: NA

DoDAF: NA

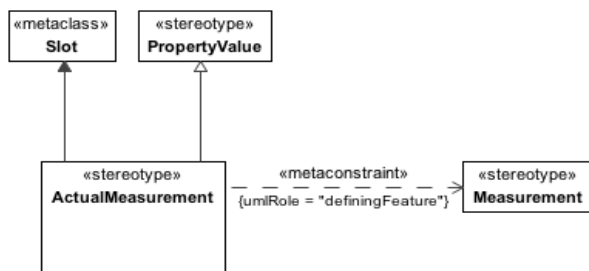

Figure 8.22 - ActualMeasurement

Constraints

The following are constraints for ActualMeasurement:

- ActualMeasurement.definingFeature - Value for definingFeature property must be stereotyped “Measurement” or its specializations.

Extensions

The following are extensions for ActualMeasurement:

- Slot

Generalizations

The following are generalization relationships for ActualMeasurement:

- PropertyValue

8.3.1.3.1.6.2 ActualPropertySet

UPDM: A set or collection of ActualMeasurement(s). A date of measurement can be set. An intent of ActualMeasurementSet can be “Result,” “Required,” or “Estimate.”

MODAF: NA

DoDAF: NA

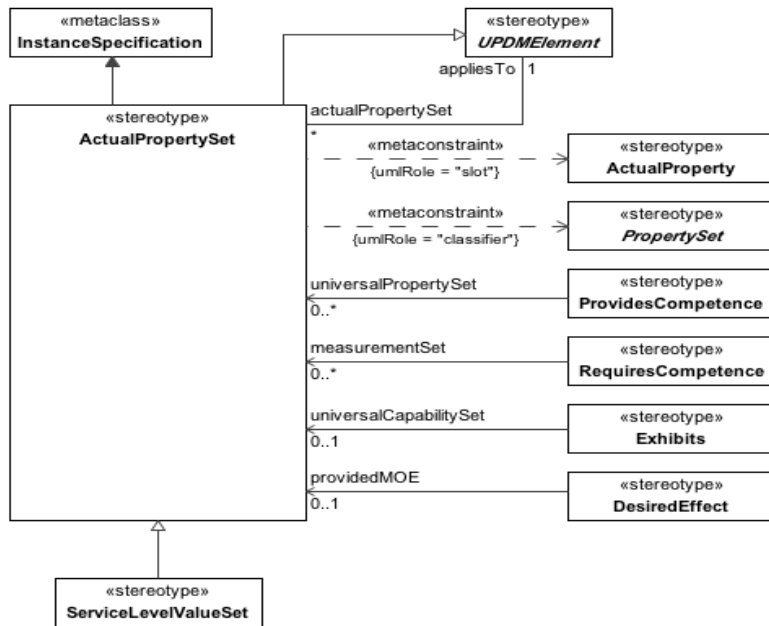

Figure 8.23 - ActualPropertySet

Constraints

The following are constraints for ActualPropertySet:

- ActualPropertySet.classifier - Value for the classifier property must be stereotyped “PropertySet” or its specializations.
- ActualPropertySet.slot - Value for the slot property must be stereotyped “ActualProperty” or its specializations.

Attribute

The following are attributes for ActualPropertySet:

- appliesFor : UPDMElement[1] - Measured element.
- intrinsicCapability : Exhibits[0..1] -
- requiredMOE : DesiredEffect[0..1] -
- resourceType : ProvidesCompetence[0..1] -
- role : RequiresCompetence[0..1] -

Extensions

The following are extensions for ActualPropertySet:

- InstanceSpecification

Generalizations

The following are generalization relationships for ActualPropertySet:

- UPDMElement

8.3.1.3.1.6.3 Measurement

MODAF: MeasurableProperty: A property of something in the physical world, expressed in amounts of a unit of measure. The property may have a required value - either specified by the [defaultValue] from UML::property attribute, or the [minValue] and [maxValue] to specify a required range.

DoDAF: Measure: A Measurement (DoDAF::Measure) is the magnitude of some attribute of an individual.

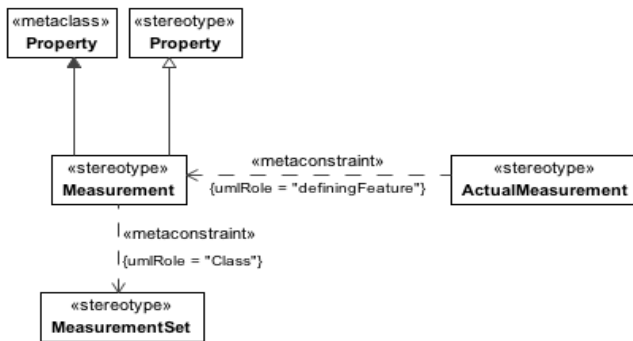

Figure 8.24 - Measurement

Extensions

The following are extensions for Measurement:

- Property

Generalizations

The following are generalization relationships for Measurement:

- Property

8.3.1.3.1.6.4 Property

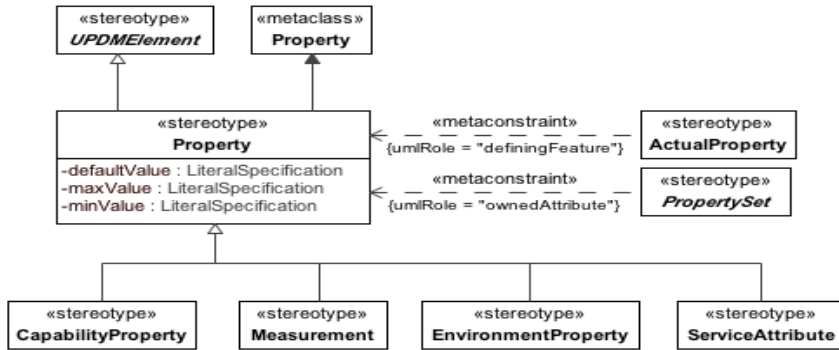

Figure 8.25 - Property

Attribute

The following are attributes for Property:

- defaultValue : LiteralSpecification[] -
- maxValue : LiteralSpecification[] -
- minValue : LiteralSpecification[] -

Extensions

The following are extensions for Property:

- Property

Generalizations

The following are generalization relationships for Property:

- UPDMElement

8.3.1.3.1.6.5 PropertySet

UPDM: A set or collection of Measurement(s).

MODAF: NA

DoDAF: NA

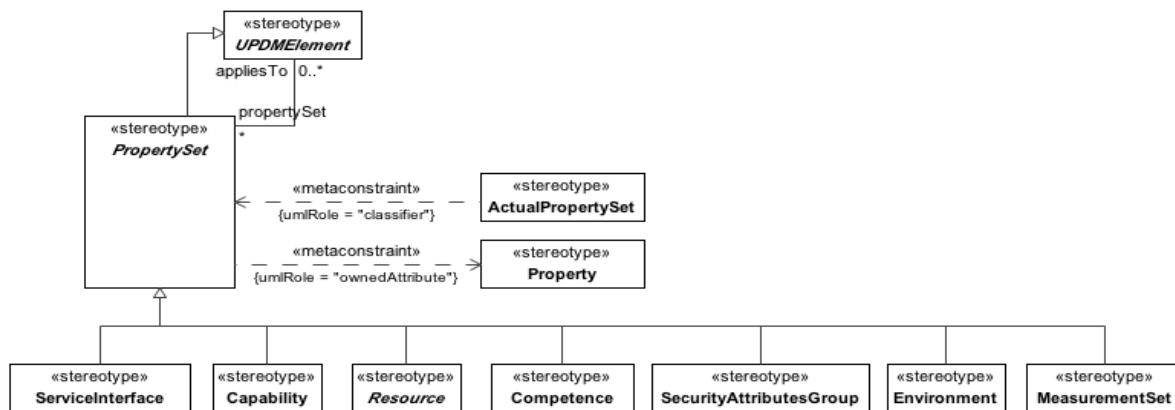

Figure 8.26 - PropertySet

Constraints

The following are constraints for PropertySet:

- PropertySet.ownedAttribute - Values for the ownedAttribute property must be stereotyped “Property” or its specializations.

Attribute

The following are attributes for PropertySet:

- appliesFor : UPDMElement[0..*] - Measured element.

Generalizations

The following are generalization relationships for PropertySet:

- UPDMElement

8.3.1.3.1.6.6 PropertyValue

UPDM:The value of a Measure.

MODAF:NA

DoDAF:NA

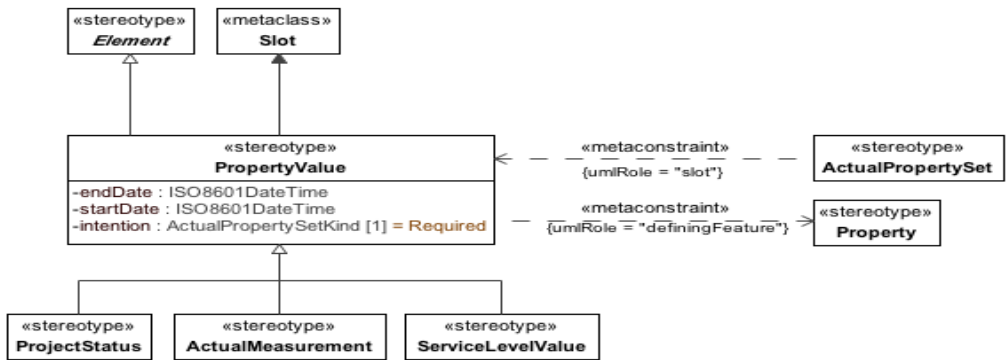

Figure 8.27 - PropertyValue

Constraints

The following are constraints for PropertyValue:

- PropertyValue.definingFeature - Value for definingFeature property must be stereotyped “Property” or its specializations.

Attribute

The following are attributes for PropertyValue:

- endDate : ISO8601DateTime[] -
- intention : ActualPropertySetKind[1] -
- startDate : ISO8601DateTime[] -

Extensions

The following are extensions for PropertyValue:

- Slot

Generalizations

The following are generalization relationships for PropertyValue:

- UPDMElement

8.3.1.3.1.6.7 MeasurementSet

UPDM: A collection of Measurements.

MODAF: N/A

DoDAF: N/A

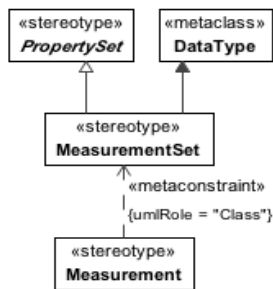

Figure 8.28 - MeasurementSet

Constraints

The following are constraints for MeasurementSet:

- MeasurementSet.ownedAttributes - Owned attributes have to be stereotyped <<Measurement>>.

Extensions

The following metaclasses are extended by MeasurementSet:

- DataType

Specializations

The MeasurementSet element is a specialization of:

- PropertySet

8.3.1.3.1.7 UPDM L1::UPDM L0::Core::AllElements::Structure

This section of the specification contains the Structural Aspects of the All Elements section.

8.3.1.3.1.7.1 ExchangeElement

MODAF: A relationship specifying the need to exchange information between nodes.

DoDAF: NA - this is a specialization of OperationalExchange (DoDAF::Interface).

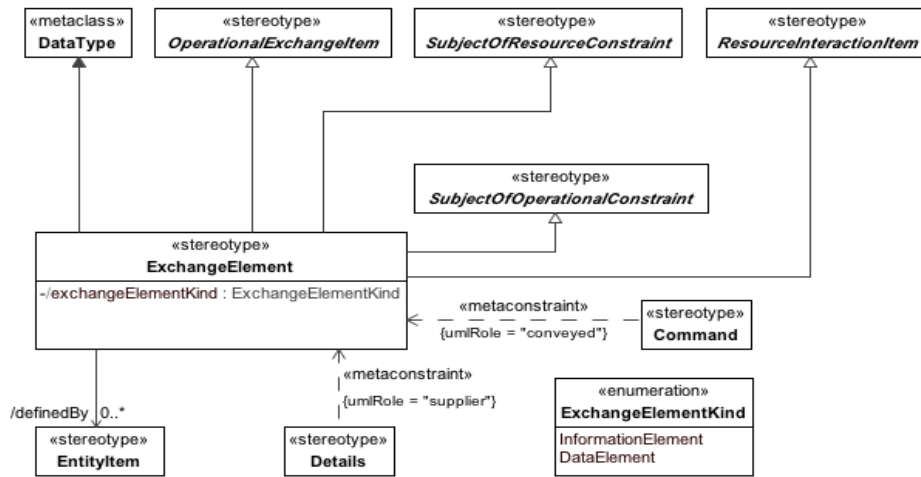

Figure 8.29 - ExchangeElement

Extensions

The following metaclasses are extended by ExchangeElement:

- DataType

Specializations

The ExchangeElement element is a specialization of:

- OperationalExchangeItem
- SubjectOfResourceConstraint
- ResourceInteractionItem
- SubjectOfOperationalConstraint

8.3.1.3.1.7.2 ExchangeElementKind

Enumeration of the types of element being exchanged on an information exchange.

Enumeration Literals

The following are enumeration literals for ExchangeElementKind:

- DataElement - A formalized representation of data which is managed by or exchanged between resources.
- InformationElement - An item of information that flows between Operational Activities and Nodes. The structure of an InformationElement may be defined using a LogicalDataModel.

8.3.1.3.1.7.3 Participant

UPDM: A participant is the abstract type of a provider and/or consumer of services. In the business domain a participant may be a person, organization, or system. In the systems domain a participant may be a system, application, or component.

NOTE: Participant is abstract.

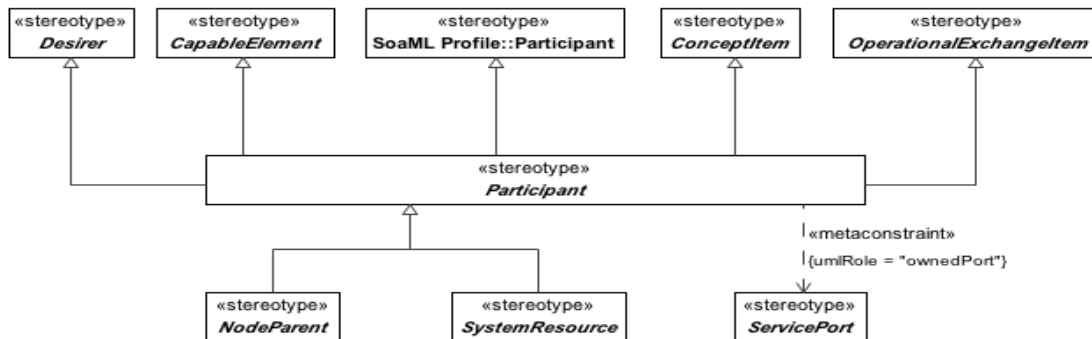

Figure 8.30 - Participant

Constraints

The following are constraints for Participant:

- Participant.ownedPort - Values for the ownedPort property must be stereotyped “ServicePort” or its specializations.

Specializations

The Participant element is a specialization of:

- CapableElement
- ConceptItem
- OperationalExchangeItem
- Desirer
- Participant

8.3.1.3.1.7.4 Resource

UPDM: Abstract element placeholder to indicate that resources can be exchanged in Operational and Systems views.

MODAF: NA

DoDAF: Data, Information, Performers, Materiel, or Personnel Types that are produced or consumed.

NOTE: Resource is abstract.

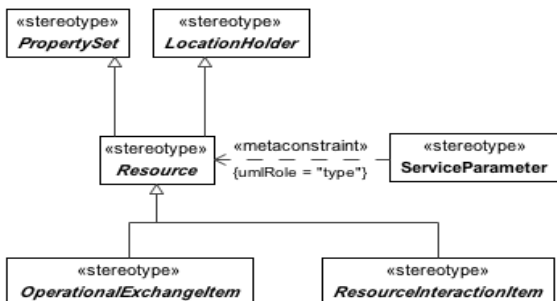

Figure 8.31 - Resource

Specializations

The Resource element is a specialization of:

- LocationHolder
- PropertySet
- SubjectOfResourceConstraint

8.3.1.3.1.7.5 Rule

MODAF: An abstract Class that is extended by OperationalConstraint (A rule governing an operational behavior or property.) and ResourceConstraint (A rule governing the structural or functional aspects of an implementation - this may also include constraints on OrganizationalResources that are part of an implementation).

DoDAF: Rule: A principle or condition that governs behavior; a prescribed guide for conduct or action. Subtype: Constraint: The range of permissible states for an object.

NOTE: Rule is abstract.

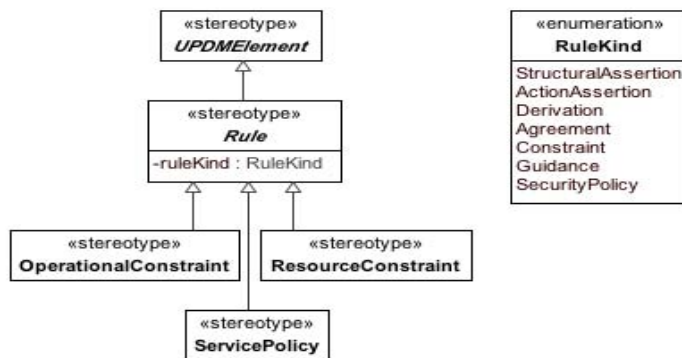

Figure 8.32 - Rule

Specializations

The Rule element is a specialization of:

- UPDMElement

8.3.1.3.1.7.6 RuleKind

Enumeration of possible kinds for constraints.

Enumeration Literals

The following are enumeration literals for RuleKind:

- ActionAssertion - Statement that concerns some dynamic aspect of the business.
- Agreement - A consent among parties regarding the terms and conditions of activities that said parties participate in.
- Constraint - Business Rule, Rule, Restraint, Operational Limitation.

- Derivation - Rule derived from another rule.
- Guidance - An authoritative statement intended to lead or steer the execution of actions.
- SecurityPolicy - An OperationalConstraint that specifies policy for information handling, physical security, encryption, etc.

8.3.1.3.1.8 UPDM L1::UPDM L0::Core::AllElements::Views

The views section of the AllElements profile.

8.3.1.3.1.8.1 ArchitecturalDescription

MODAF: A specification of a system of systems at a technical level that also provides the business context for the system of systems.

DoDAF: Information describing an architecture such as an OV-5 Activity Model document.

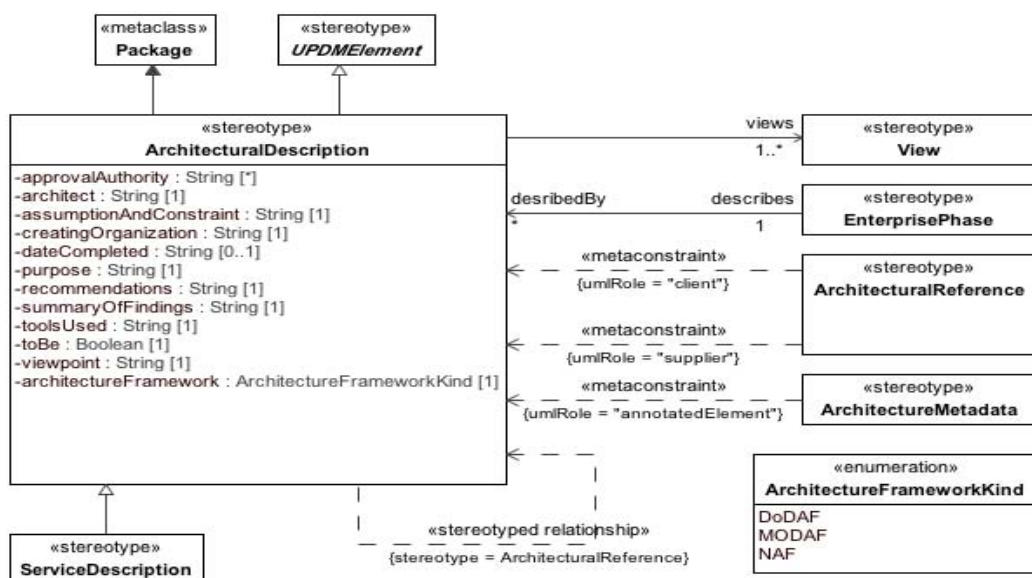

Figure 8.33 - ArchitecturalDescription

Constraints

The following are constraints for ArchitecturalDescription:

- ArchitecturalDescription.architectureFramework - If the property is set to DoDAF, only aliases scoped under the DoDAF profile can be used - if set to MODAF then only MODAF aliases can be used. Should the property be set to nothing, none of the aliases can be used.

Attribute

The following are attributes for ArchitecturalDescription:

- approvalAuthority : String[*] - References the actual organizational resource that has the authority to approve the architectural description.

- architect : String[1] - The name of the architect responsible for the ArchitecturalDescription.
- architectureFramework : ArchitectureFrameworkKind[1] - Indicates the type of framework used.
- assumptionAndConstraint : String[1] - Any assumptions, constraints, and limitations contained in the ArchitecturalDescription, including those affecting deployment, communications performance, information assurance environments, etc.
- creatingOrganization : String[1] - Describes the ActualOrganizationalResource creating the ArchitecturalDescription.
- dateCompleted : String[0..1] - Date that the Architectural Description was completed.
- purpose : String[1] - Explains the need for the Architecture, what it will demonstrate, the types of analyses that will be applied to it, who is expected to perform the analyses, what decisions are expected to be made on the basis of each form of analysis, who is expected to make those decisions, and what actions are expected to result.
- recommendations : String[1] - States the recommendations that have been developed based on the architecture effort. Examples include recommended system implementations, and opportunities for technology insertion.
- summaryOfFindings : String[1] - Summarizes the findings that have been developed so far. This may be updated several times during the development of the ArchitecturalDescription.
- toBe : Boolean[1] - Indicates whether the ArchitecturalDescription is existing or future.
- toolsUsed : String[1] - Identifies any tools used to develop the ArchitecturalDescription as well as file names and formats if appropriate.
- viewpoint : String[1] - Indicates which viewpoints are used in the architecture.
- views : View[1..*] - Indicates which views are used in the architecture.

Extensions

The following are extensions for ArchitecturalDescription:

- Package

Generalizations

The following are generalization relationships for ArchitecturalDescription:

- UPDMElement

8.3.1.3.1.8.2 ArchitecturalReference

MODAF: Asserts that one architectural description (referrer) refers to another (referred).

DoDAF: NA

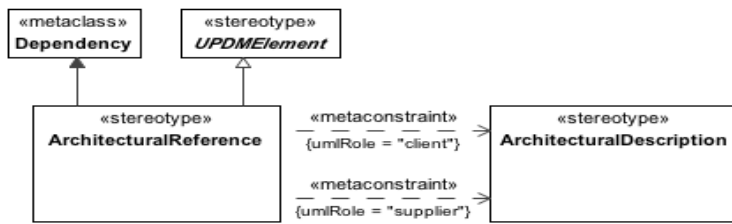

Figure 8.34 - ArchitecturalReference

Constraints

The following are constraints for ArchitecturalReference:

- ArchitecturalReference.client - Value for the client property must be stereotyped “ArchitecturalDescription” or its specializations.
- ArchitecturalReference.supplier - Value for the supplier property must be stereotyped “ArchitecturalDescription” or its specializations.

Extensions

The following are extensions for ArchitecturalReference:

- Dependency

Generalizations

The following are generalization relationships for ArchitecturalReference:

- UPDMElement

8.3.1.3.1.8.3 ArchitectureMetadata

UPDM: Information on ArchitecturalDescription. It states things like what methodology was used, notation, etc.

MODAF: A Metadata element that applies to the whole architecture.

DoDAF: NA

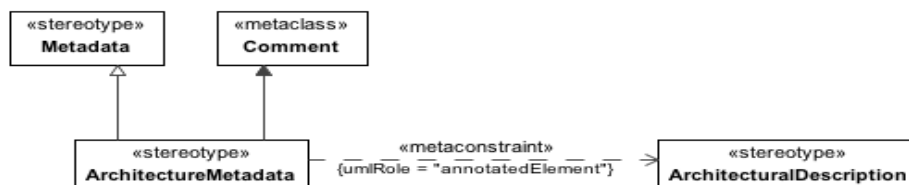

Figure 8.35 - ArchitectureMetadata

Constraints

The following are constraints for ArchitectureMetadata:

- ArchitectureMetadata.annotatedElement - Value for the annotatedElement property must be stereotyped “ArchitecturalDescription” or its specializations.

Extensions

The following are extensions for ArchitectureMetadata:

- Comment

Generalizations

The following are generalization relationships for ArchitectureMetadata:

- Metadata

8.3.1.3.1.8.4 Metadata

MODAF: Annotation that can be applied to any element in the architecture.

DoDAF: NA

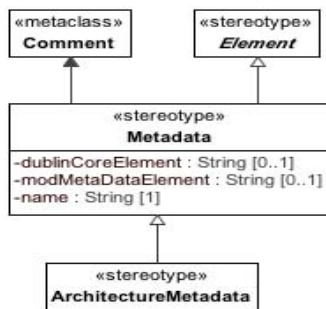

Figure 8.36 - Metadata

Attribute

The following are attributes for Metadata:

- dublinCoreElement : String[0..1] - If the meta data corresponds to the Dublin Core Meta-Data Standard, then the meta-data element name should be listed here
- modMetaDataElement : String[0..1] - If the meta data corresponds to the MOD Meta-Data Standard, then the meta-data element name should be listed here.
- name : String[1] - The name of the Metadata.

Extensions

The following are extensions for Metadata:

- Comment

Generalizations

The following are generalization relationships for Metadata:

- UPDMElement

8.3.1.3.1.8.5 View

MODAF: A specification of a way to present an aspect of the architecture. Views are defined with one or more purposes in mind - e.g., showing the logical topology of the enterprise, describing a process model, defining a data model, etc.

DoDAF: NA

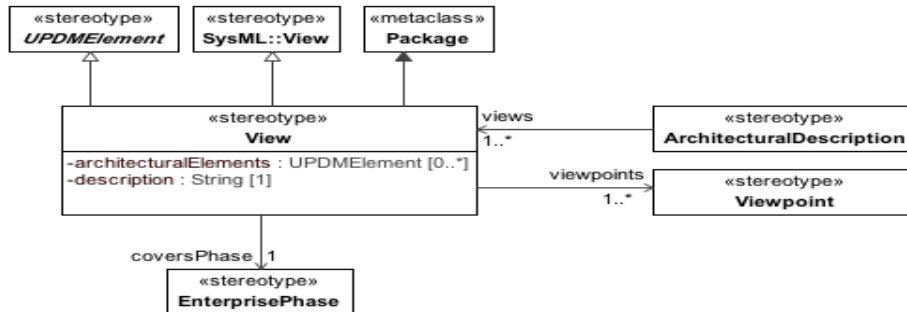

Figure 8.37 - View

Attribute

The following are attributes for View:

- architecturalElements : UPDMElement[0..*] -
- description : String[1] -
- viewpoints : Viewpoint[1..*] -

Extensions

The following are extensions for View:

- Package

Generalizations

The following are generalization relationships for View:

- View
- UPDMElement

8.3.1.3.1.8.6 Viewpoint

MODAF: An instance of the specified View.

DoDAF: NA

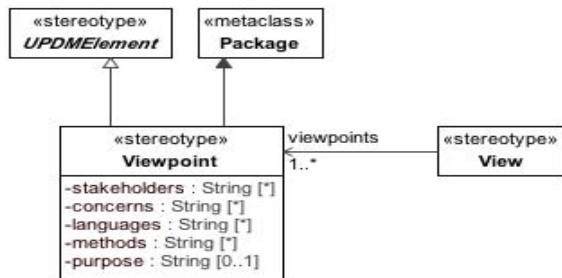

Figure 8.38 - Viewpoint

Attribute

The following are attributes for Viewpoint:

- concerns : String[*] -
- languages : String[*] -
- methods : String[*] -
- purpose : String[0..1] -
- stakeholders : String[*] -

Extensions

The following are extensions for Viewpoint:

- Package

Generalizations

The following are generalization relationships for Viewpoint:

- UPDMElement

8.3.1.3.2 UPDM L1::UPDM L0::Core::ExternalTypes

A type defined by an external ontology. This may be higher-order - i.e. a type of a type.

8.3.1.3.2.1 ISO8601DateTime

MODAF: A date and time specified in the ISO8601 date-time format including timezone designator (TZD): YYYY-MM-DDThh:mm:ssTZD.

DoDAF: NA

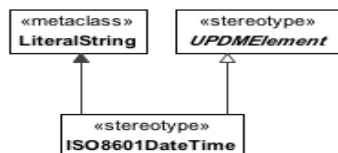

Figure 8.39 - ISO8601DateTime

Extensions

The following are extensions for ISO8601DateTime:

- LiteralString

Generalizations

The following are generalization relationships for ISO8601DateTime:

- UPDMElement

8.3.1.3.3 UPDM L1::UPDM L0::Core::OperationalElements

OperationalElements group elements used to model product for Operational View. An Operational View (OV) describes the tasks and activities, operational elements, and information exchanges required to conduct operations. A pure OV is materiel independent. However, operations and their relationships may be influenced by new technologies such as collaboration technology, where process improvements are in practice before policy can reflect the new procedures. There may be some cases, as well, in which it is necessary to document the way processes are performed given the restrictions of current systems, in order to examine ways in which new systems could facilitate streamlining the processes. In such cases, an OV may have materiel constraints and requirements that must be addressed. For this reason, it may be necessary to include some high- level Systems View (SV) architecture data as overlays or augmenting information onto the OV products.

8.3.1.3.3.1 UPDM L1::UPDM L0::Core::OperationalElements::Behavior

Behavioral section of the OperationalElements Profile.

8.3.1.3.3.1.1 NodeOperation

UPDM:A partial or full realization of an OperationalActivity.

MODAF:NA

DoDAF:NA

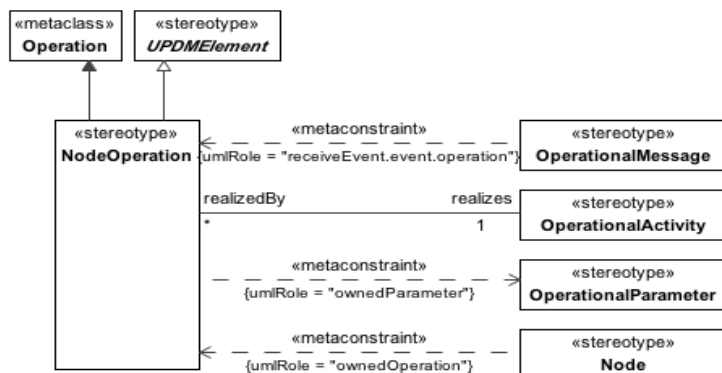

Figure 8.40 - NodeOperation

Constraints

The following are constraints for NodeOperation:

- NodeOperation.ownedParameter - The values for the ownedParameter property must be stereotyped “OperationalParameter” or its specializations.

Attribute

The following are attributes for NodeOperation:

- realizes : OperationalActivity[1] -

Extensions

The following are extensions for NodeOperation:

- Operation

Generalizations

The following are generalization relationships for NodeOperation:

- UPDMElement

8.3.1.3.3.1.2 OperationalActivity

MODAF: A logical process, specified independently of how the process is carried out. DoDAF: An activity is an action performed in conducting the business of an enterprise. It is a general term that does not imply a placement in a hierarchy (e.g., it could be a process or a task as defined in other documents and it could be at any level of the hierarchy of the OV-5). It is used to portray operational actions not hardware/software system functions.

NOTE: This is also a specialization of Activity.

DoDAF:NA

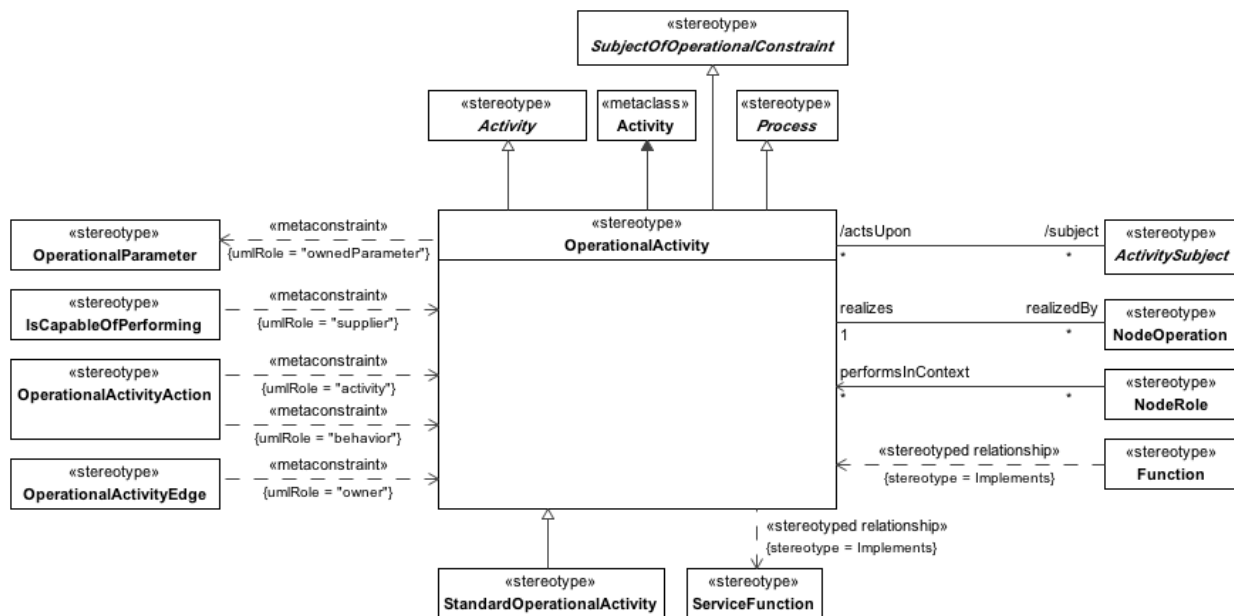

Figure 8.41 - OperationalActivity

Constraints

The following are constraints for OperationalActivity:

- OperationalActivity.ownedParameter - The values for the ownedParameter property must be stereotyped “OperationalParameter” or its specializations.

Attribute

The following are attributes for OperationalActivity:

- realizedBy : NodeOperation[*] -
- realizingFunction : Function[*] -
- subject : ActivitySubject[*] - Object acting upon this OperationalActivity.

Extensions

The following are extensions for OperationalActivity:

- Activity

Generalizations

The following are generalization relationships for OperationalActivity:

- Activity
- SubjectOfOperationalConstraint
- Process

8.3.1.3.3.1.3 OperationalActivityAction

UPDM: The OperationalActivityAction is defined as a call behavior action that invokes the activity that needs to be preformed.

MODAF: Used to relate an OperationalActivity to its sub-activities.

DoDAF:NA

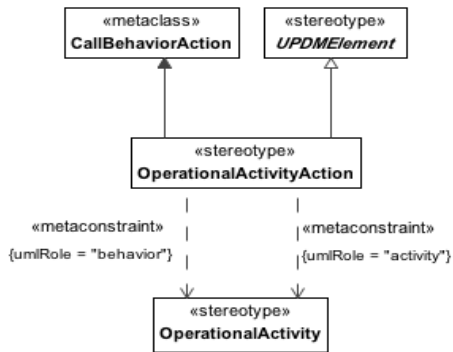

Figure 8.42 - OperationalActivityAction

Constraints

The following are constraints for OperationalActivityAction:

- OperationalActivityAction.activity - Value for behavior property must be stereotyped “OperationalActivity” or its specializations.
- OperationalActivityAction.behavior - Value for activity property must be stereotyped “OperationalActivity” or its specializations.

Extensions

The following are extensions for OperationalActivityAction:

- CallBehaviorAction

Generalizations

The following are generalization relationships for OperationalActivityAction:

- UPDMElement

8.3.1.3.3.1.4 OperationalActivityEdge

UPDM An extension of <<ActivityEdge>> that is used to model the flow of control/objects through an OperationalActivity.

MODAF: An OperationalActivityEdge (MODAF::OperationalActivityFlow) is a flow of information, energy, or materiel from one activity to another.

DoDAF:NA

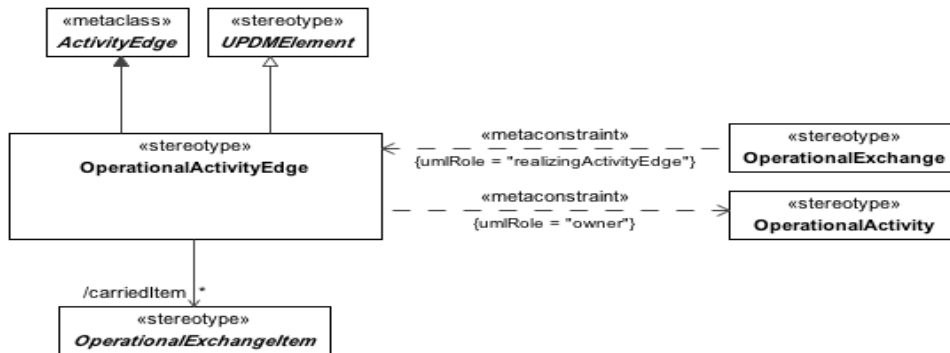

Figure 8.43 - OperationalActivityEdge

Constraints

The following are constraints for OperationalActivityEdge:

- OperationalActivityEdge.owner - “OperationalActivityEdge” must be owned directly or indirectly by “OperationalActivity.”

Attribute

The following are attributes for OperationalActivityEdge:

- carriedItem : OperationalExchangeItem[*] -

Extensions

The following are extensions for OperationalActivityEdge:

- ActivityEdge

Generalizations

The following are generalization relationships for OperationalActivityEdge:

- UPDMElement

8.3.1.3.3.1.5 OperationalEventTrace

MODAF: An OperationalEventTrace (MODAF::OperationalInteractionSpecification) is a specification of the interactions between nodes in an operational architecture.

DoDAF: The Operational Event-Trace Description (OV-6c) DoDAF-described View provides a time ordered examination of the resource flows as a result of a particular scenario. Each event-trace diagram will have an accompanying description that defines the particular scenario or situation.

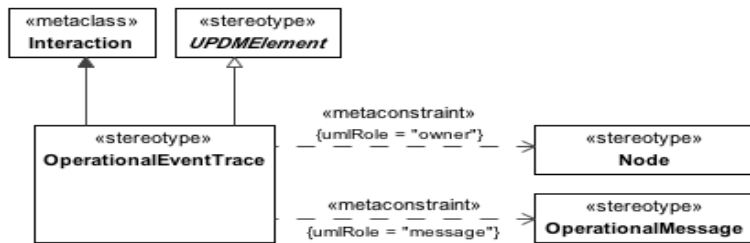

Figure 8.44 - OperationalEventTrace

Constraints

The following are constraints for OperationalEventTrace:

- OperationalEventTrace.message - Values for the message property must be stereotyped with “OperationalMessage” or its specializations.
- OperationalEventTrace.owner - Values for the owner property must be stereotyped with “Node” or its specializations.

Extensions

The following are extensions for OperationalEventTrace:

- Interaction

Generalizations

The following are generalization relationships for OperationalEventTrace:

- UPDMElement

8.3.1.3.3.1.6 OperationalMessage

UPDM: Message for use in an Operational Event-Trace which carries any of the subtypes of OperationalExchange. This is used to provide additional information about OperationalMessages for display on an OV-6c.

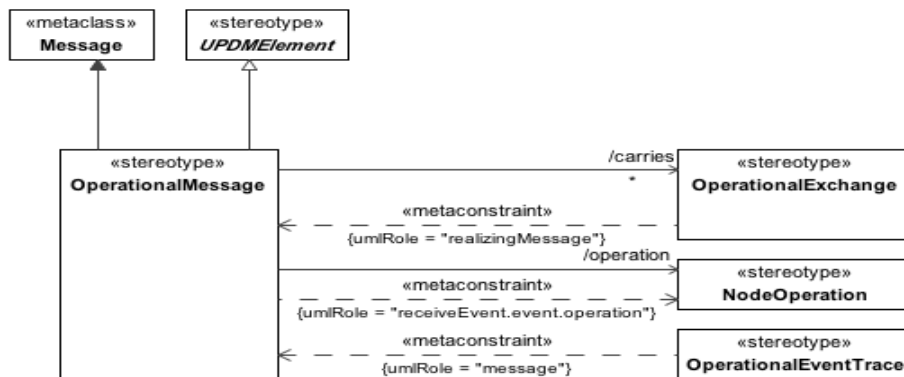

Figure 8.45 - OperationalMessage

Attribute

The following are attributes for OperationalMessage:

- carries : OperationalExchange[*] - Carried OperationalExchange.
- operation : NodeOperation[0..1] -

Extensions

The following are extensions for OperationalMessage:

- Message

Generalizations

The following are generalization relationships for OperationalMessage:

- UPDMElement

8.3.1.3.3.1.7 OperationalParameter

UPDM Represents inputs and outputs of an OperationalActivity. It is typed by OperationalExchangeItem.

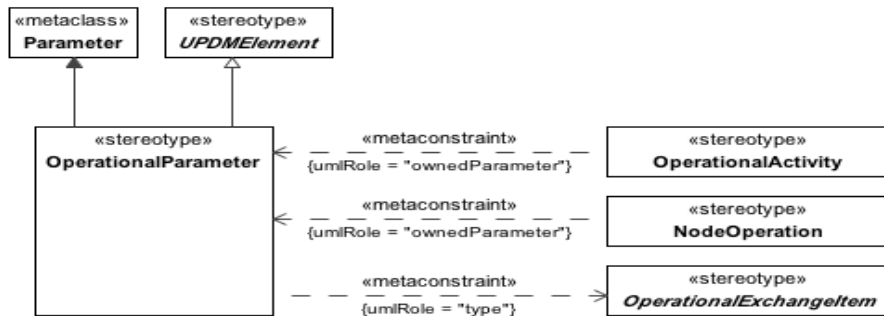

Figure 8.46 - OperationalParameter

Constraints

The following are constraints for OperationalParameter:

- OperationalParameter.type - Value for the type property must be stereotyped by specialization of “OperationalExchangeItem.”

Extensions

The following are extensions for OperationalParameter:

- Parameter

Generalizations

The following are generalization relationships for OperationalParameter:

- UPDMElement

8.3.1.3.3.1.8 OperationalStateDescription

UPDM: A state machine describing an operational behavior or property.

MODAF: An OperationalStateMachine (MODAF::OperationalStateDescription) is a rule governing an operational behaviour or property.

DoDAF: The Operational State Transition Description (OV-6b) DoDAF-described View is a graphical method of describing how an Operational Activity responds to various events by changing its state. The diagram represents the sets of events to which the Architecture will respond (by taking an action to move to a new state) as a function of its current state. Each transition specifies an event and an action.

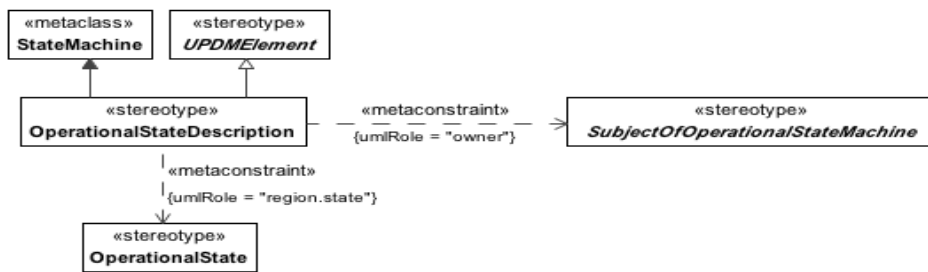

Figure 8.47 - OperationalStateDescription

Constraints

The following are constraints for OperationalStateDescription:

- OperationalStateDescription.owner - Values for the owner property must be stereotyped with specializations of “SubjectOfOperationalStateMachine.”
- OperationalStateDescription.region.state - Values for the region.state property must be stereotyped with “OperationalState” or its specializations.

Extensions

The following are extensions for OperationalStateDescription:

- StateMachine

Generalizations

The following are generalization relationships for OperationalStateDescription:

- UPDMElement

8.3.1.3.3.1.9 SubjectOfOperationalStateMachine

UPDM Abstract UPDMElement: The element being described by the state machine.

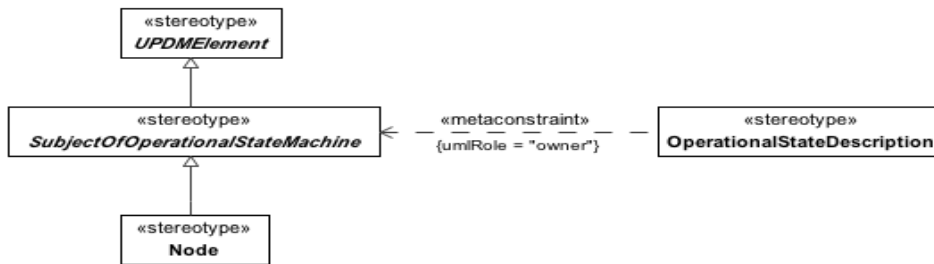

Figure 8.48 - SubjectOfOperationalStateMachine

Constraints

The following are constraints for SubjectOfOperationalStateMachine:

- SubjectOfOperationalStateMachine.ownedBehavior - If elements, that have applied stereotypes that are specializations of “SubjectOfOperationalStateMachine” have StateMachines as owned behaviors, then those behaviors must be stereotyped “OperationalStateMachine” or its specializations.

Generalizations

The following are generalization relationships for SubjectOfOperationalStateMachine:

- UPDMElement

8.3.1.3.3.1.10 OperationalState

UPDM: State identified in the context of an OperationalStateDescription.

MODAF:N/A

DoDAF:N/A

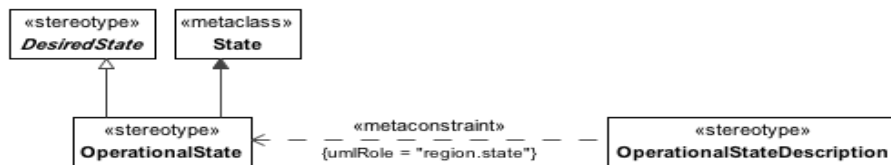

Figure 8.49 - OperationalState

Extensions

The following metaclasses are extended by OperationalState:

- State

Specializations

The OperationalState element is a specialization of:

- DesiredState

8.3.1.3.3.2 UPDM L1::UPDM L0::Core::OperationalElements::Data

The Data Profile is used to document the business information requirements and structural business process rules of the architecture. It describes the information that is associated with the information exchanges of the architecture. Included are information items, their attributes or characteristics, and their inter-relationships.

8.3.1.3.3.2.1 LogicalDataModel

MODAF: A LogicalDataModel is a specification of business information requirements as a formal data structure, where relationships and classes (entities) are used to specify the logic which underpins the information.

DoDAF: A Logical Data Model allows analysis of an architecture's data definition aspect, without consideration of implementation specific or product specific issues.

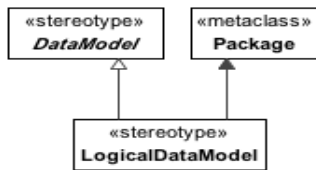

Figure 8.50 - LogicalDataModel

Extensions

The following are extensions for LogicalDataModel:

- Package

Generalizations

The following are generalization relationships for LogicalDataModel:

- DataModel

8.3.1.3.3.3 UPDM L1::UPDM L0::Core::OperationalElements::Flows

Section of the OperationalElements profile that describe flows exists or are required between Nodes such as flows of information, people, materiel, or energy.

8.3.1.3.3.3.1 Command

MODAF: Asserts that one OrganizationalResource (source) commands another (target)

DoDAF: NA

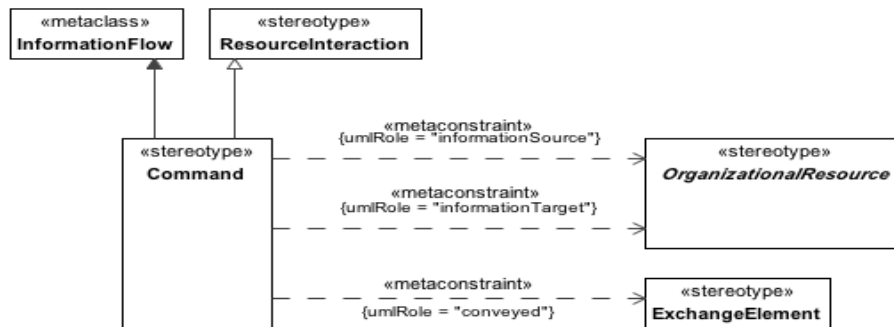

Figure 8.51 - Command

Constraints

The following are constraints for Command:

- Command.conveyed - Value for the conveyed property must be stereotyped “ExchangeElement” or its specializations.
- Command.informationSource - Value for the informationSource property must be stereotyped “OrganizationalResource” or its specializations.
- Command.informationTarget - Value for the informationTarget property must be stereotyped “OrganizationalResource” or its specializations.

Extensions

The following are extensions for Command:

- InformationFlow

Generalizations

The following are generalization relationships for Command:

- ResourceInteraction

8.3.1.3.3.2 OperationalExchange

UPDM: An utility element used as common flow for:

- InformationExchange
- OrganizationalExchange
- EnergyExchange
- MaterielExchange
- ConfigurationExchange
- GeoPoliticalExtent

An operational exchange is formed when an activity of one operational node consumes items produced by another activity of a different operational node.

An operational exchange describes the characteristics of the exchanged item, such as the content, format (voice, imagery, text and message format, etc.), throughput requirements, security or classification level, timeliness requirement, and the degree of interoperability.

MODAF: An OperationalExchange (MODAF::LogicalFlow) asserts that a flow exists or is required between Nodes (e.g., flows of information, people, materiel, or energy).

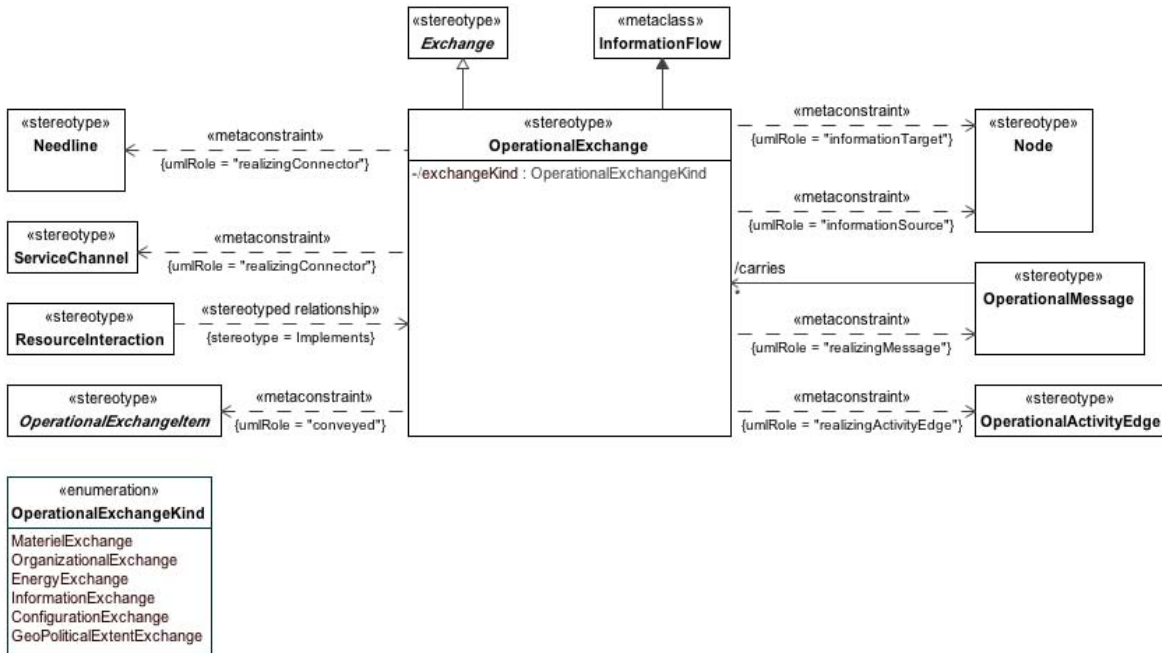

Figure 8.52 - OperationalExchange

Constraints

The following are constraints for OperationalExchange:

- OperationalExchange.conveyed - In case of OperationalExchange.operationalExchangeKind:
 - = InformationExchange, the conveyed element must be stereotyped “ExchangeElement” or its specializations,
 - = MaterielExchange, the conveyed element must be stereotyped “ResourceArtifact” or its specializations,
 - = EnergyExchange, the conveyed element must be stereotyped “Energy” or its specializations,
 - = OrganizationalExchange, the conveyed element must be stereotyped “OrganizationalResource” or its specializations,
 - = ConfigurationExchange, the conveyed element must be stereotyped “CapabilityConfiguration” or its specializations, or
 - = GeoPoliticalExtentExchange, the conveyed element must be stereotyped “GeoPoliticalExtent” or its specializations.
- OperationalExchange.informationSource - Value for informationSource property has to be stereotyped “Node” or its specializations.
- OperationalExchange.informationTarget - Value for informationTarget property has to be stereotyped “Node” or its specializations.

- OperationalExchange.realization/realizingConnector - Value for realization or realizingConnector property has to be stereotyped “Needline,” “ServiceChannel,” or their specializations.
- OperationalExchange.realizingActivityEdge - Value for realizingActivityEdge property has to be stereotyped “OperationalActivityEdge” or its specializations.
- OperationalExchange.realizingMessage - Value for realizingMessage property has to be stereotyped “OperationalMessage” or its specializations.

Attribute

The following are attributes for OperationalExchange:

- exchangeKind : OperationalExchangeKind[1] -
- realizingResourceInteractions : ResourceInteraction[*] -

Extensions

The following are extensions for OperationalExchange:

- InformationFlow

Generalizations

The following are generalization relationships for OperationalExchange:

- Exchange

8.3.1.3.3.3 OperationalExchangeItem

UPDM - An abstract utility element used as common ancestor for:

- InformationElement
- ResourceArtifact
- Energy
- OrganizationalResource
- CapabilityConfiguration
- GeoPoliticalExtent

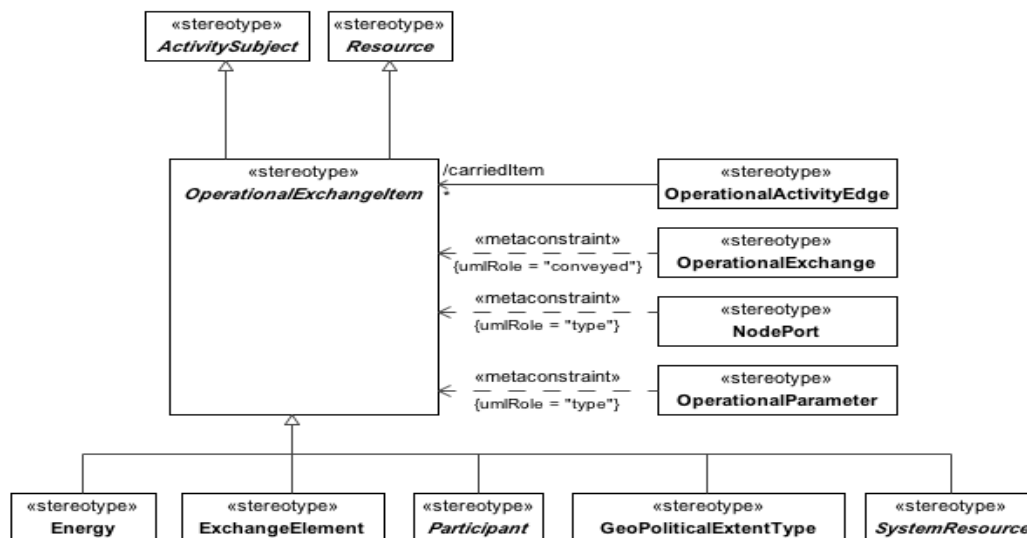

Figure 8.53 - OperationalExchangeItem

Generalizations

The following are generalization relationships for OperationalExchangeItem:

- ActivitySubject
- Resource

8.3.1.3.3.3.4 OperationalExchangeKind

Enumeration of operational exchange kinds, used to support the exchangeKind tag of the OperationalExchange stereotype.

Enumeration Literals

The following are enumeration literals for OperationalExchangeKind:

- ConfigurationExchange - A LogicalFlow where CapabilityConfigurations flow from one node to another.
- EnergyExchange - A LogicalFlow where energy is flowed from one node to another.
- GeoPoliticalExtentExchange - A LogicalFlow where GeoPoliticalExtents (i.e., Borders) flow from one place to another.
- InformationExchange - A LogicalFlow where energy is flowed from one node to another.
- MaterielExchange - A flow of materiel (artifacts) between Functions.
- OrganizationalExchange - A LogicalFlow where human resources (PostTypes, RoleTypes) flow between Nodes.

8.3.1.3.3.4 UPDM L1::UPDM L0::Core::OperationalElements::Structure

Section of the OperationalElements profile that describes structural concepts.

8.3.1.3.3.4.1 ArbitraryConnector

UPDM: Represents a visual indication of a connection used in high level operational concept diagrams. The connections are purely visual and cannot be related to any architectural semantics.

MODAF: NA

DoDAF:NA

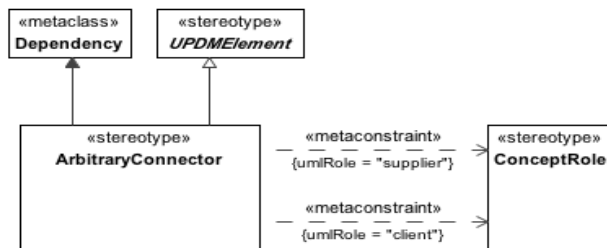

Figure 8.54 - ArbitraryConnector

Constraints

The following are constraints for ArbitraryConnector:

- ArbitraryConnector.client - The value for client property has to be stereotyped “ConceptRole” or its specializations.
- ArbitraryConnector.supplier - The value for supplier property has to be stereotyped “ConceptRole” or its specializations.

Extensions

The following are extensions for ArbitraryConnector:

- Dependency

Generalizations

The following are generalization relationships for ArbitraryConnector:

- UPDMElement

8.3.1.3.3.4.2 Competence

MODAF: A specific set of abilities defined by knowledge, skills, and attitude.

DoDAF: (DoDAF::Skill): The ability, coming from one's knowledge, practice, aptitude, etc., to do something well.

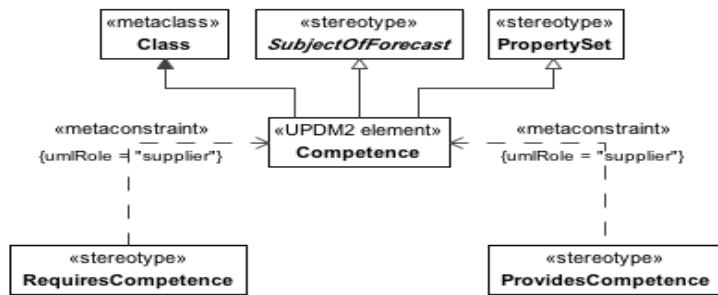

Figure 8.55 - Competence

Extensions

The following are extensions for Competence:

- Class

Generalizations

The following are generalization relationships for Competence:

- SubjectOfForecast
- PropertySet

8.3.1.3.3.4.3 ConceptItem

UPDM: Abstract, an item which may feature in a high level operational concept.

DoDAF:NA

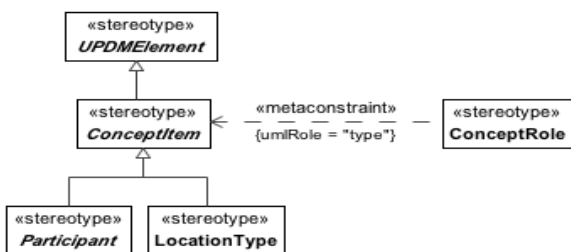

Figure 8.56 - ConceptItem

Generalizations

The following are generalization relationships for ConceptItem:

- UPDMElement

8.3.1.3.3.4.4 ConceptRole

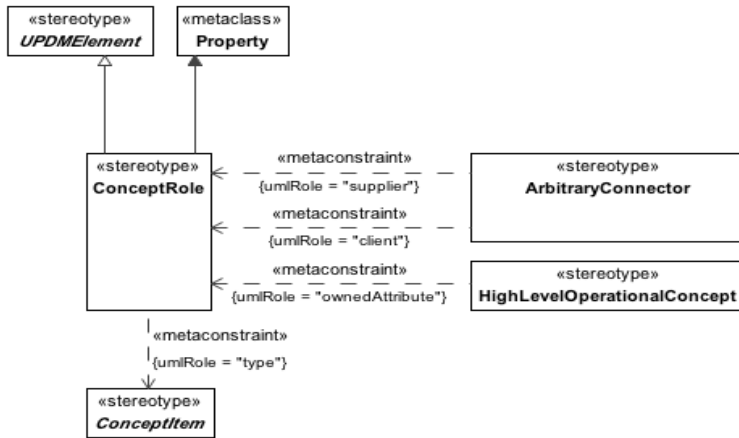

Figure 8.57 - ConceptRole

Constraints

The following are constraints for ConceptRole:

- ConceptRole.type - Value for the type property must be stereotyped a specialization of “ConceptItem.”

Extensions

The following are extensions for ConceptRole:

- Property

Generalizations

The following are generalization relationships for ConceptRole:

- UPDMElement

8.3.1.3.3.4.5 HighLevelOperationalConcept

MODAF: A generalized model for operations.

DoDAF: NA

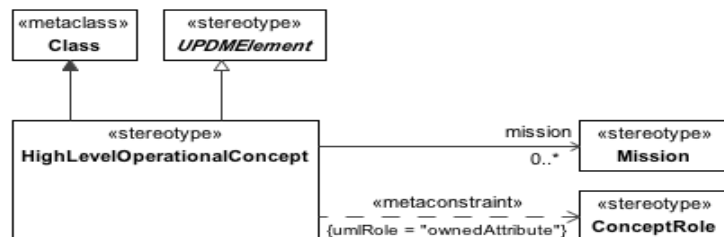

Figure 8.58 - HighLevelOperationalConcept

Constraints

The following are constraints for HighLevelOperationalConcept:

- HighLevelOperationalConcept.ownedAttribute - The values for the ownedAttribute properties must be stereotyped with specializations of the “ConceptRole.”

Attribute

The following are attributes for HighLevelOperationalConcept:

- mission : Mission[0..*] - Mission that is described by this HighLevelOperationalConcept.

Extensions

The following are extensions for HighLevelOperationalConcept:

- Class

Generalizations

The following are generalization relationships for HighLevelOperationalConcept:

- UPDMElement

8.3.1.3.3.4.6 KnownResource

MODAF: Asserts that a known Resource plays a part in the architecture.

DoDAF: NA - covered by the more general temporalWholePart element.

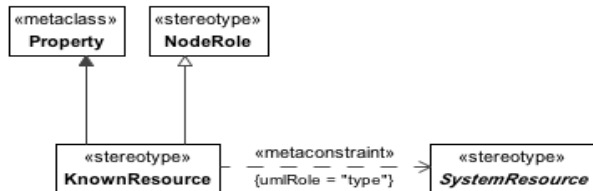

Figure 8.59 - KnownResource

Constraints

The following are constraints for KnownResource:

- KnownResource.type - Values for type property have to be stereotyped “SystemResource” or its specializations.

Extensions

The following are extensions for KnownResource:

- Property

Generalizations

The following are generalization relationships for KnownResource:

- NodeRole

8.3.1.3.3.4.7 LogicalArchitecture

MODAF: A CompositeStructureModel whose parts are either NodeRoles (MODAF::Node), ProblemDomains, or KnownResources.

DoDAF: NA

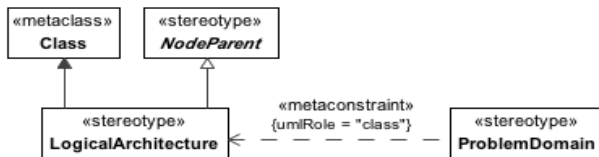

Figure 8.60 - LogicalArchitecture

Extensions

The following are extensions for LogicalArchitecture:

- Class

Generalizations

The following are generalization relationships for LogicalArchitecture:

- NodeParent

8.3.1.3.3.4.8 Mission

MODAF: A purpose to which a person, organization or autonomous system is tasked.

DoDAF: The task, together with the purpose, that clearly indicates the action to be taken.

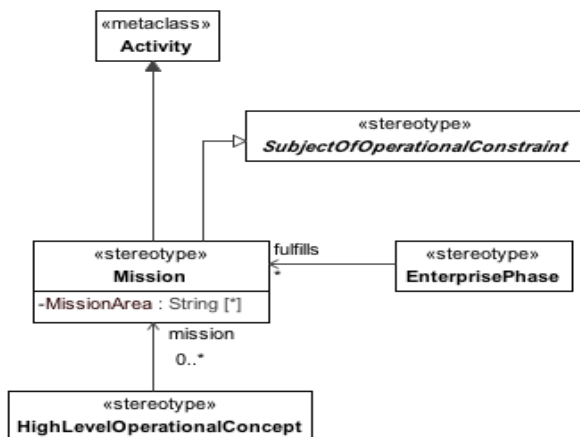

Figure 8.61 - Mission

Attribute

The following are attributes for Mission:

- MissionArea : String[*] - The area in which the Mission will take place.

Extensions

The following are extensions for Mission:

- Activity

Generalizations

The following are generalization relationships for Mission:

- SubjectOfOperationalConstraint

8.3.1.3.3.4.9 Needline

MODAF: A relationship between Nodes representing a bundle of InformationExchanges.

DoDAF: A needline documents the requirement to exchange information between nodes. The needline does not indicate how the information transfer is implemented.

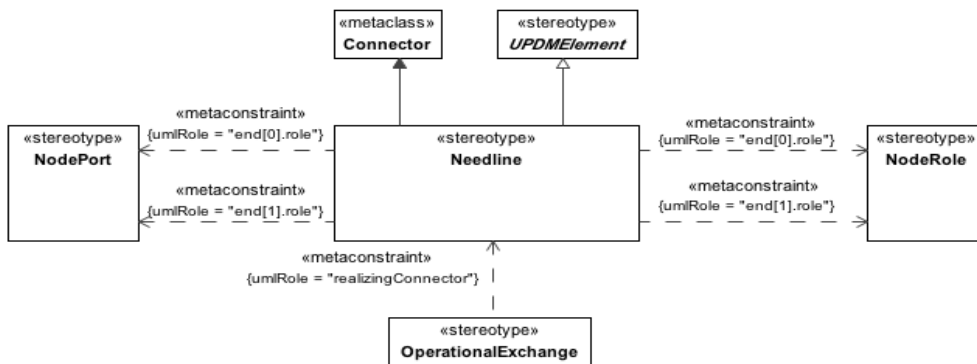

Figure 8.62 - Needline

Constraints

The following are constraints for Needline:

- Needline.end - The value for the role property for the owned ConnectorEnd must be stereotype “NodeChild”/”NodePort” or its specializations.

Extensions

The following are extensions for Needline:

- Connector

Generalizations

The following are generalization relationships for Needline:

- UPDMElement

8.3.1.3.3.4.10 Node

MODAF: A Node (MODAF::NodeType) is a logical entity that performs operational activities. Note: nodes are specified independently of any physical realization.

DoDAF: A Node (DoDAF::OperationalNode) is an element of the operational architecture that produces, consumes, or processes information.

NOTE: This is also a specialization of Performer.

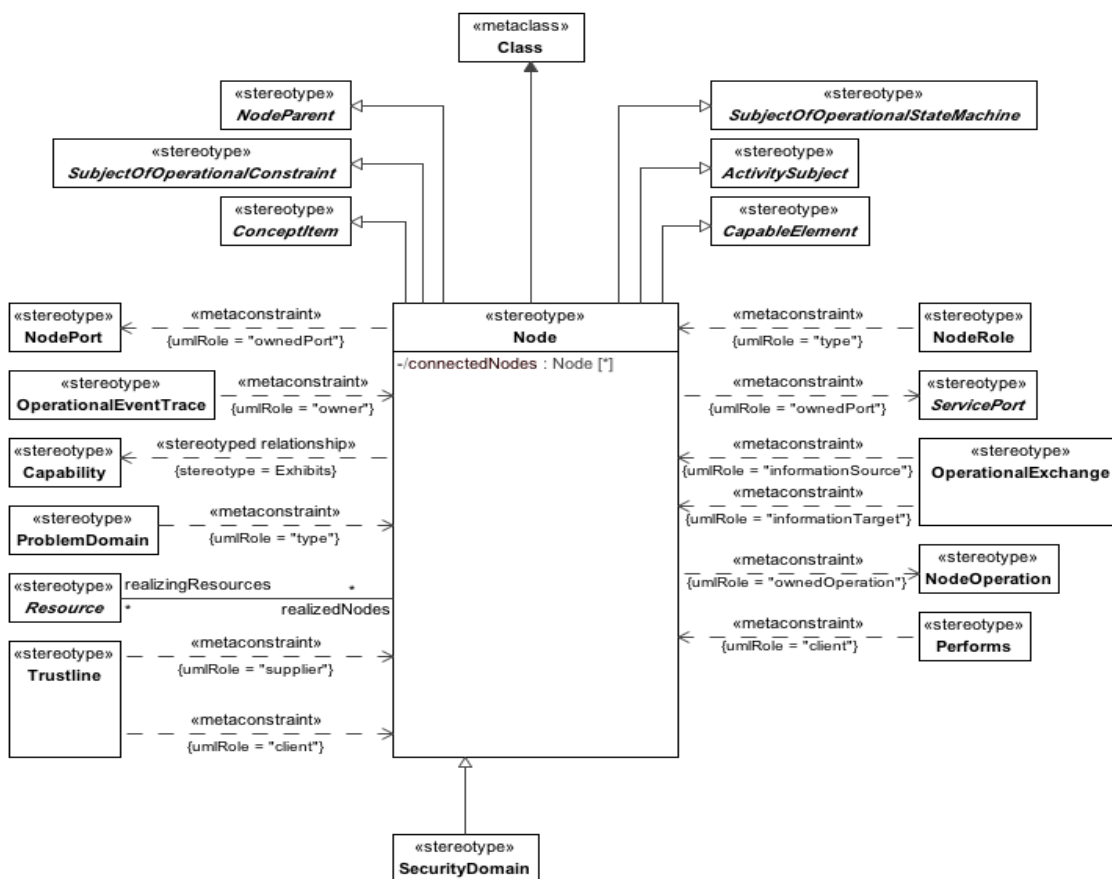

Figure 8.63 - Node

Constraints

The following are constraints for Node:

- Node.isCapableOfPerforming - Is capable of performing only “OperationalActivity” elements or its specializations.
- Node.ownedOperation - Values for the ownedOperation property must be stereotyped “NodeOperation” or its specializations.

Node.ownedPort - Values for the ownedPort property must be stereotyped “NodePort,” “ServicePort,” or their specializations.

Attribute

The following are attributes for Node:

- connectedNodes : Node[*] -
- realizingResources : Resource[*] -

Extensions

The following are extensions for Node:

- Class

Generalizations

The following are generalization relationships for Node:

- ActivitySubject
- SubjectOfOperationalConstraint
- NodeParent
- SubjectOfOperationalStateMachine

8.3.1.3.3.4.11 NodeParent

UPDM: An abstract element representing the owners/context of composite structure at the operational level.

MODAF: The abstract supertype of all elements that can have child Nodes (LogicalArchitecture, ProblemDomain & NodeType)

DoDAF:NA

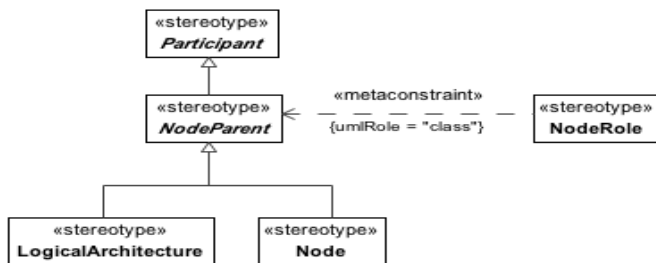

Figure 8.64 - NodeParent

Generalizations

The following are generalization relationships for NodeParent:

- UPDMElement

8.3.1.3.3.4.12 NodePort

UPDM: A port is a property of a Node that specifies a distinct interaction point between the node and its environment or between the (behavior of the) node and its internal parts. It is the “entry/exit” point where resources (e.g., energy, information/data and people, etc.) flow in and out of a node.

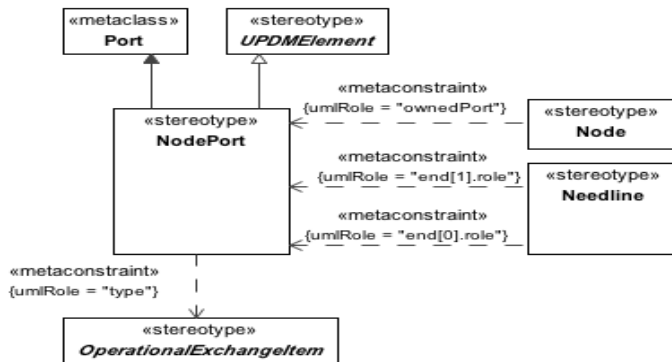

Figure 8.65 - NodePort

Constraints

The following are constraints for NodePort:

- NodePort.type - Value for the type property must be stereotyped specialization of “OperationalExchangeItem.”

Extensions

The following are extensions for NodePort:

- Port

Generalizations

The following are generalization relationships for NodePort:

- UPDMElement

8.3.1.3.3.4.13 NodeRole

MODAF: A NodeRole (MODAF::Node) is used to link a parent Node to its sub-nodes.

DoDAF: NA

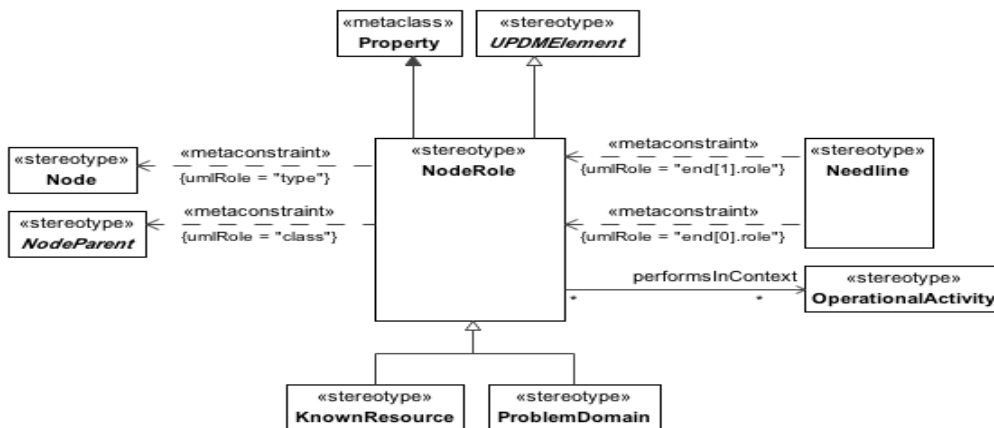

Figure 8.66 - NodeRole

Constraints

The following are constraints for NodeRole:

- NodeRole.class - Value for class meta property must be stereotyped a specialization of “NodeParent.”
- NodeRole.type - Value for type meta property must be stereotyped “Node” or its specializations.

Attribute

The following are attributes for NodeRole:

- performsInContext : OperationalActivity[*] -

Extensions

The following are extensions for NodeRole:

- Property

Generalizations

The following are generalization relationships for NodeRole:

- UPDMElement

8.3.1.3.3.4.14 OperationalConstraint

UPDM: An abstract Class that is extended by OperationalConstraint (A rule governing an operational behavior or property) and ResourceConstraint.

MODAF: A rule governing an operational behavior or property.

DoDAF: A principle or condition that governs behavior; a prescribed guide for conduct or action (Rule).

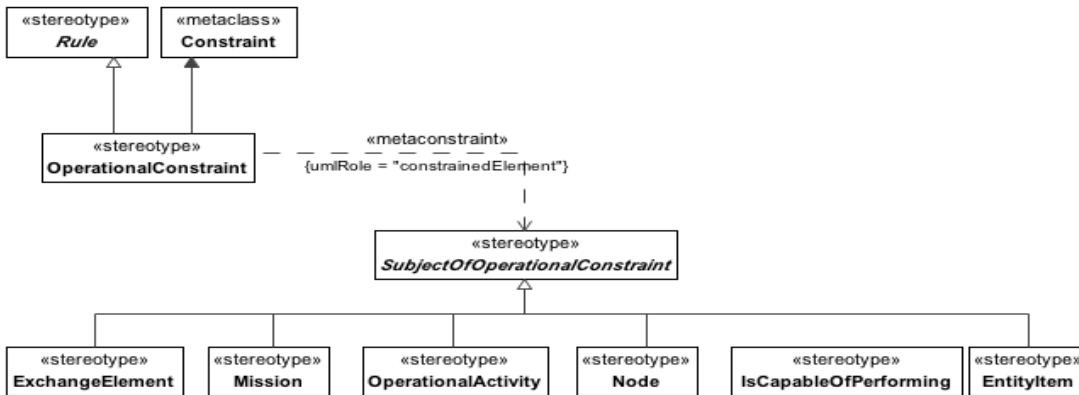

Figure 8.67 - OperationalConstraint

Constraints

The following are constraints for OperationalConstraint:

- OperationalConstraint.constrainedElement - Value for the constrainedElement property must be stereotyped by any specialization of "SubjectOfOperationalConstraint."

Extensions

The following are extensions for OperationalConstraint:

- Constraint

Generalizations

The following are generalization relationships for OperationalConstraint:

- UPDMElement
- Rule

8.3.1.3.3.4.15 SecurityDomain

MODAF:NA

DoDAF: A NodeType whose members (other Nodes, KnownResources) all share a common security policy.

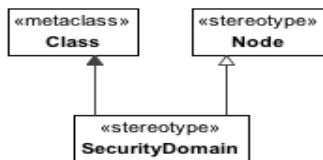

Figure 8.68 - SecurityDomain

Extensions

The following are extensions for SecurityDomain:

- Class

Generalizations

The following are generalization relationships for SecurityDomain:

- Node

8.3.1.3.3.4.16 SubjectOfOperationalConstraint

MODAF: Abstract. An element of the architecture that may be subject to an OperationalConstraint or OperationalStateDescription.

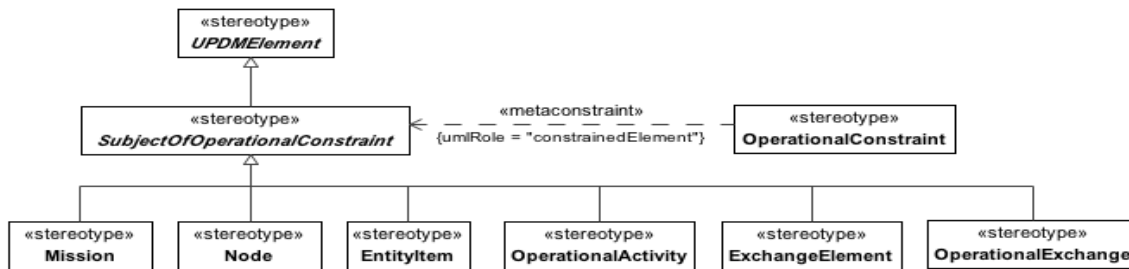

Figure 8.69 - SubjectOfOperationalConstraint

Generalizations

The following are generalization relationships for SubjectOfOperationalConstraint:

- UPDMElement

8.3.1.3.3.4.17 UPDM L1::UPDM L0::Core::OperationalElements::Structure::Organizational

The organizational elements of the operational structure.

8.3.1.3.3.4.17.1 UPDM L1::UPDM L0::Core::OperationalElements::Structure::Organizational::Actual

Actual elements in the organizational part of the structural part of the Operational profile.

8.3.1.3.3.4.17.1.1 ActualOrganization

MODAF: An actual specific organization, an instance of an organization class - e.g., “The US Department of Defense.”

DoDAF: [DoDAF::Organization]: A specific real-world assemblage of people and other resources organized for an on-going purpose.

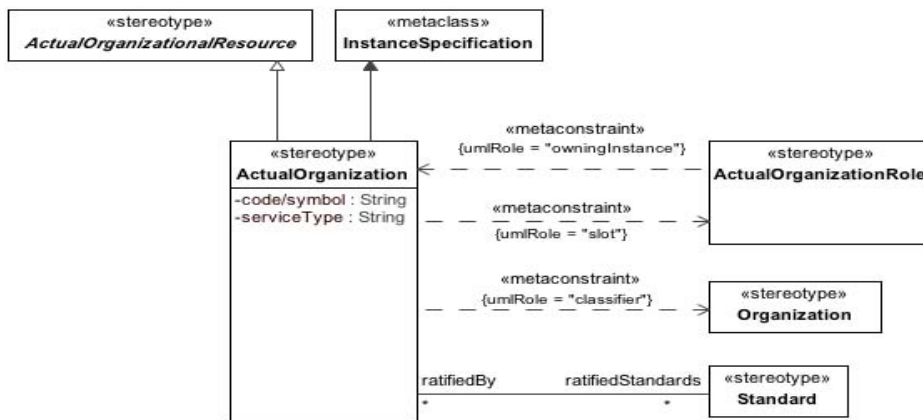

Figure 8.70 - ActualOrganization

Constraints

The following are constraints for ActualOrganization:

- ActualOrganization.classifier - Classifier property value must be stereotyped “Organization” or its specializations.
- ActualOrganization.slot - Slot property value must be stereotyped “ActualOrganizationRole” or its specializations.

Attribute

The following are attributes for ActualOrganization:

- code/symbol : String[] - Army, Navy, Air Force, Marine Corps, Joint
- ratifiedStandards : Standard[*] - Standards that were ratified by this ActualOrganization.
- serviceType : String[] - Service office code or symbol

Extensions

The following are extensions for ActualOrganization:

- InstanceSpecification

Generalizations

The following are generalization relationships for ActualOrganization:

- ActualOrganizationalResource

8.3.1.3.3.4.17.1.2 ActualOrganizationalResource

UPDM: An ActualOrganization or an ActualPost.

MODAF: An instance of either an actual organization or an actual post.

DoDAF: A specific real-world assemblage of people and other resources organized for an on-going purpose.

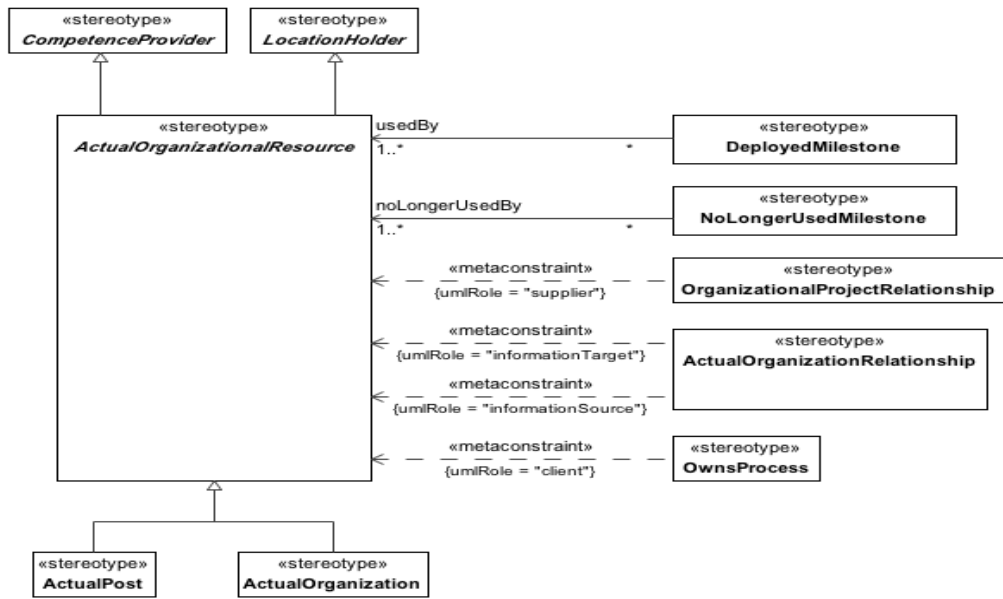

Figure 8.71 - ActualOrganizationalResource

Generalizations

The following are generalization relationships for ActualOrganizationalResource:

- LocationHolder
- CompetenceProvider

8.3.1.3.3.4.17.1.3 ActualOrganizationRelationship

UPDM: A relationship between two ActualOrganizationResources.

MODAF: A relationship between two actual specific organizations or parts of an organization.

DoDAF: NA

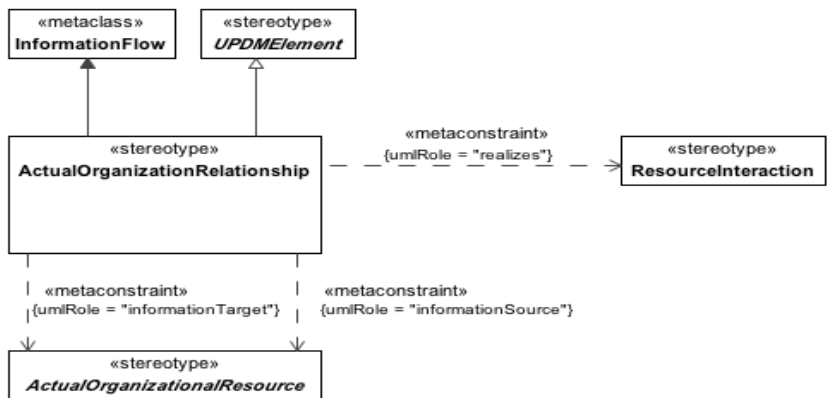

Figure 8.72 - ActualOrganizationRelationship

Constraints

The following are constraints for ActualOrganizationRelationship:

- ActualOrganizationRelationship.conveyed - Value for conveyed metaproperty must be stereotyped “ExchangeElement” or its specializations.
- ActualOrganizationRelationship.source - Value for source metaproperty must be stereotyped “ActualOrganizationalResource” or its specializations.
- ActualOrganizationRelationship.target - Value for realizes metaproperty must be stereotyped “ResourceInteraction” or its specializations.

Extensions

The following are extensions for ActualOrganizationRelationship:

- InformationFlow

Generalizations

The following are generalization relationships for ActualOrganizationRelationship:

- UPDMElement

8.3.1.3.3.4.17.1.4 ActualOrganizationRole

UPDM: Relates an actual specific organization to an actual specific organizational resource that fulfills a role in that organization.

MODAF: NA

DoDAF: NA

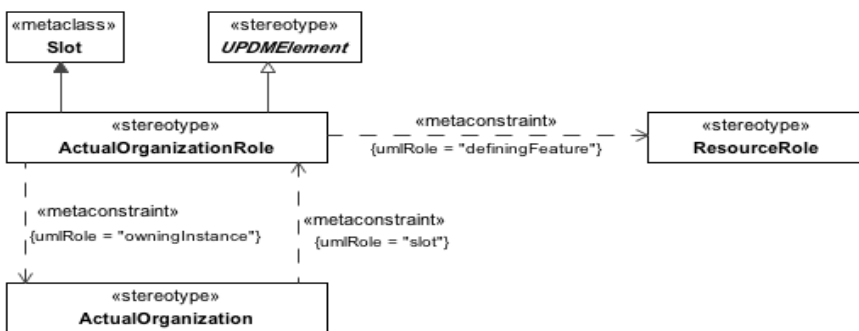

Figure 8.73 - ActualOrganizationRole

Constraints

The following are constraints for ActualOrganizationRole:

- ActualOrganizationPart.definingFeature - Value for definingFeature property has to be stereotyped “OrganizationRole” or its specializations.

- ActualOrganizationPart.owningInstance - Value for owningInstance property has to be stereotyped “ActualOrganization” or its specializations.

Extensions

The following are extensions for ActualOrganizationRole:

- Slot

Generalizations

The following are generalization relationships for ActualOrganizationRole:

- UPDMElement

8.3.1.3.3.4.17.1.5 ActualPerson

UPDM: Named individual that fulfills an ActualPost. An individual human being (vs Person which is a type), that is recognized by law as the subject of rights and duties.

MODAF: NA

DoDAF: An individual person

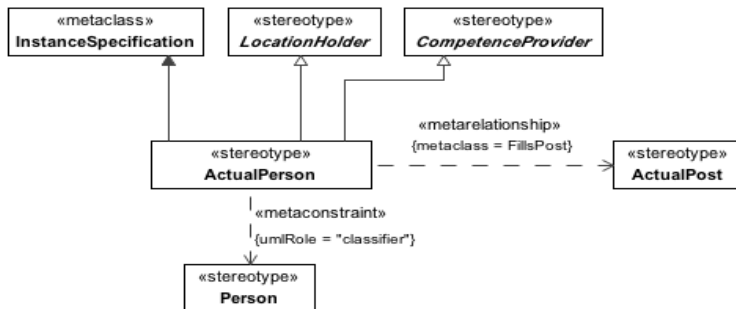

Figure 8.74 - ActualPerson

Constraints

The following are constraints for ActualPerson:

- ActualPerson.classifier - Value for the classifier property has to be stereotyped “Person” or its specializations.

Extensions

The following are extensions for ActualPerson:

- InstanceSpecification

Generalizations

The following are generalization relationships for ActualPerson:

- LocationHolder
- CompetenceProvider

8.3.1.3.3.4.17.1.6 ActualPost

UPDM: An actual, specific post, an instance of a PostType class - e.g., “President of the United States of America.”

MODAF: NA

DoDAF: NA

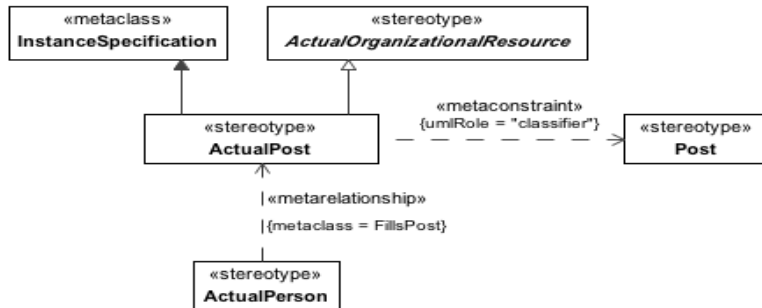

Figure 8.75 - ActualPost

Constraints

The following are constraints for ActualPost:

- ActualPost.classifier - Classifier property value must be stereotyped “Post” or its specializations.

Extensions

The following are extensions for ActualPost:

- InstanceSpecification

Generalizations

The following are generalization relationships for ActualPost:

- ActualOrganizationalResource

8.3.1.3.3.4.17.1.7 CompetenceProvider

UPDM: Abstract element used to group ActualPersons and ActualOrganizationalResources.

MODAF: NA

DoDAF: NA

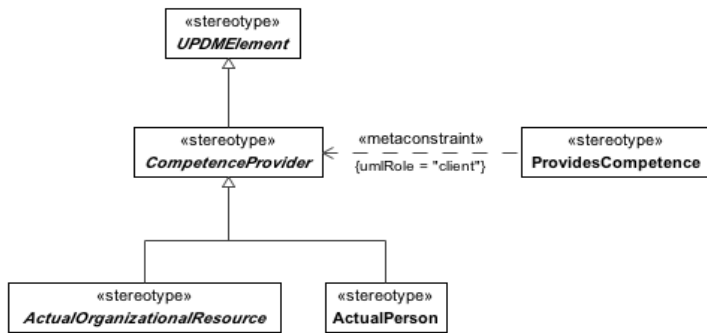

Figure 8.76 - CompetenceProvider

Extensions

The following are extensions for CompetenceProvider:

- InstanceSpecification

Generalizations

The following are generalization relationships for CompetenceProvider:

- UPDMElement

8.3.1.3.3.4.17.1.8 FillsPost

UPDM: Asserts that ActualPerson fills an ActualPost.

MODAF: NA

DoDAF: NA

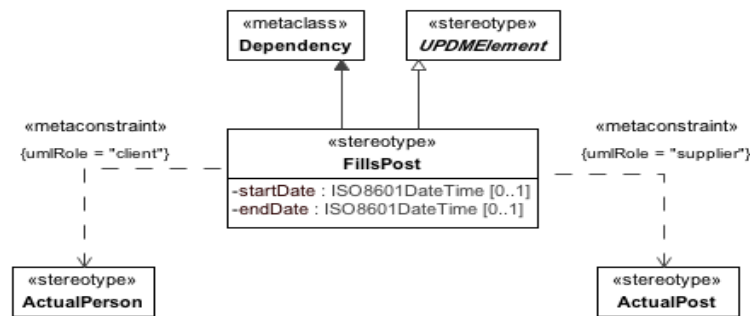

Figure 8.77 - FillsPost

Constraints

The following are constraints for FillsPost:

- FillsPost.client - Value for the client property must be stereotyped by “ActualPerson” or its specializations.

- FillsPost.supplier - Value for the supplier property must be stereotyped by “ActualPost” or its specializations.

Attribute

The following are attributes for FillsPost:

- endDate : ISO8601DateTime[0..1] - End date
- startDate : ISO8601DateTime[0..1] - Start date

Extensions

The following are extensions for FillsPost:

- Dependency

Generalizations

The following are generalization relationships for FillsPost:

- UPDMElement

8.3.1.3.3.4.17.2 UPDM L1::UPDM L0::Core::OperationalElements::Structure::Organizational::Typical

Typical elements in the organizational part of the structural part of the Operational profile.

8.3.1.3.3.4.17.2.1 CompetenceRequirer

UPDM: Abstract element used to group Organizations, Post, and Responsibilities.

MODAF:NA

DoDAF:NA

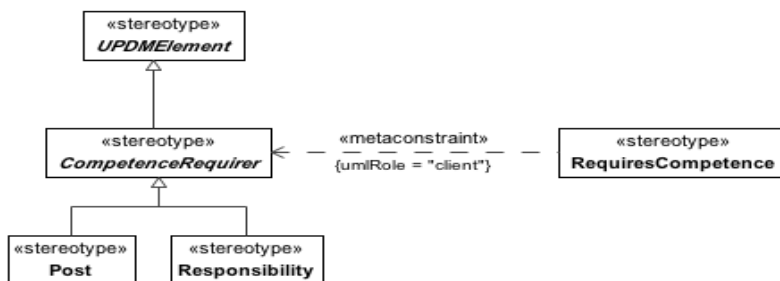

Figure 8.78 - CompetenceRequirer

Extensions

The following are extensions for CompetenceRequirer:

- Class

Generalizations

The following are generalization relationships for CompetenceRequirer:

- UPDMElement

8.3.1.3.3.4.17.2.2 Organization

MODAF: A group of persons associated for a particular purpose.

DoDAF: A type of Organization.

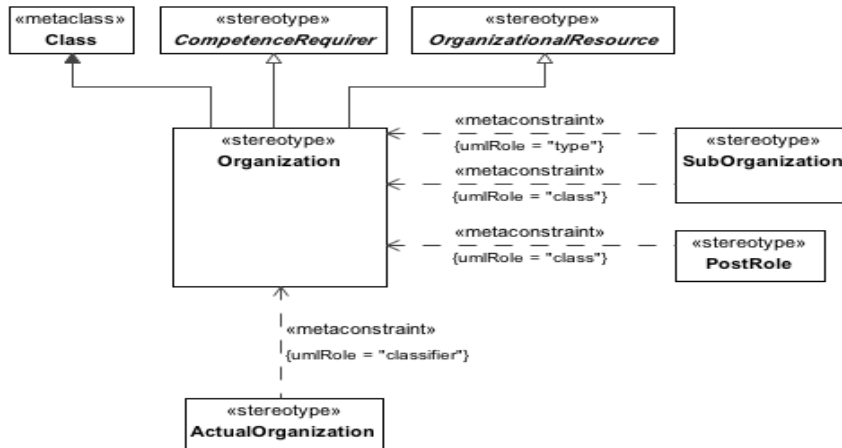

Figure 8.79 - Organization

Extensions

The following are extensions for Organization:

- Class

Generalizations

The following are generalization relationships for Organization:

- OrganizationalResource
- CompetenceRequirer

8.3.1.3.3.4.17.2.3 OrganizationalResource

UPDM An abstract element that represents Organizations and Posts.

MODAF: Either an organization, or a post.

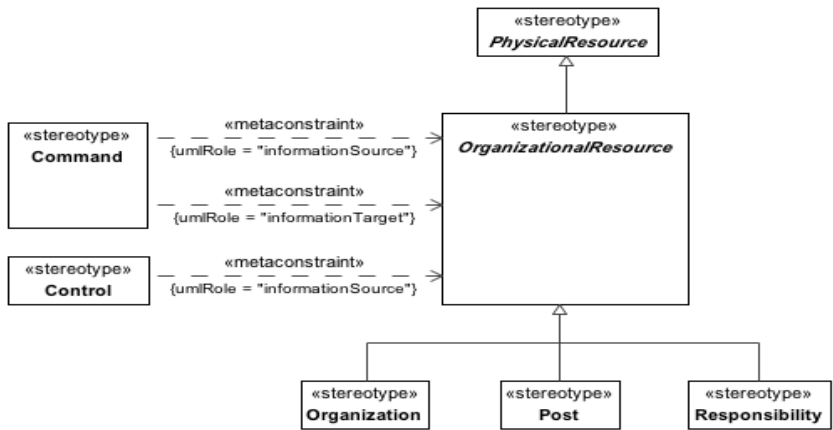

Figure 8.80 - OrganizationalResource

Generalizations

The following are generalization relationships for OrganizationalResource:

- Resource

8.3.1.3.3.4.17.2.4 Person

UPDM: A type of a human being that is recognized by law as the subject of rights and duties. This is used to define the characteristics that require capturing for ActualPersons (e.g., properties such as address, rank, telephone number, etc.).

MODAF: NA

DoDAF: NA

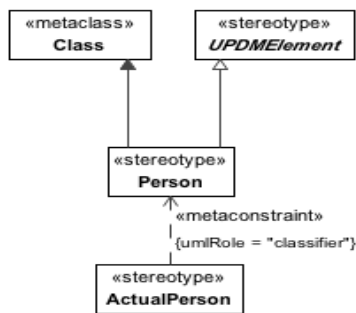

Figure 8.81 - Person

Extensions

The following are extensions for Person:

- Class

Generalizations

The following are generalization relationships for Person:

- UPDMElement

8.3.1.3.3.4.17.2.5 Post

MODAF: A Post (MODAF::PostType) is a type of point of contact or responsible person. Note that this is the type of post (e.g., Desk Officer, Commander Land Component, etc.).

DoDAF: A Post (DoDAF:: PersonType) is a category of persons defined by the role or roles they share that are relevant to an architecture.

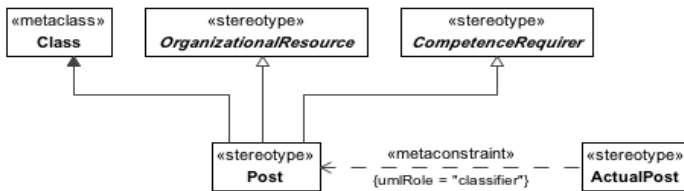

Figure 8.82 - Post

Extensions

The following are extensions for Post:

- Class

Generalizations

The following are generalization relationships for Post:

- OrganizationalResource
- CompetenceRequirer

8.3.1.3.3.4.17.2.6 ProvidesCompetence

UPDM: Asserts that a Resource type provides a competence.

MODAF: Asserts that a Role requires a Competence (MODAF::CompetenceForRole).

DoDAF: An overlap between a Personnel Type and the Skills it entails (DoDAF:: skillPartOfPersonType)

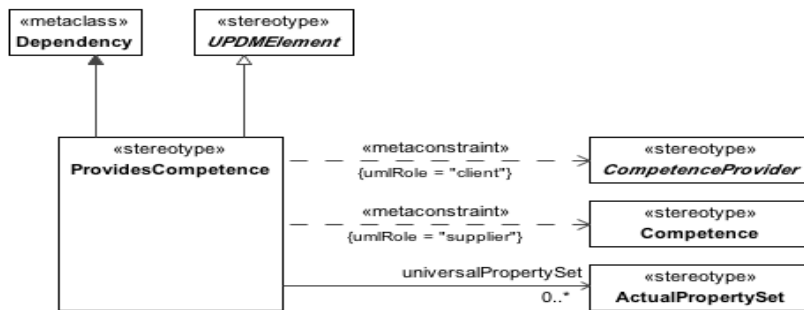

Figure 8.83 - ProvidesCompetence

Constraints

The following are constraints for ProvidesCompetence:

- ProvidesCompetence.client - Value for the client property must be stereotyped by a specialization of “CompetenceProvider.”
- ProvidesCompetence.supplier - Value for the client property must be stereotyped “Competence” or its specializations.

Attribute

The following are attributes for ProvidesCompetence:

- universalPropertySet : ActualPropertySet[0..*] -

Extensions

The following are extensions for ProvidesCompetence:

- Dependency

Generalizations

The following are generalization relationships for ProvidesCompetence:

- UPDMElement

8.3.1.3.3.4.17.2.7 RequiresCompetence

MODAF:: Asserts that an Role requires a Competence (MODAF::CompetenceForRole).

DoDAF: An overlap between a Personnel Type and the Skills it entails (DoDAF:: SkillPartOfPersonType).

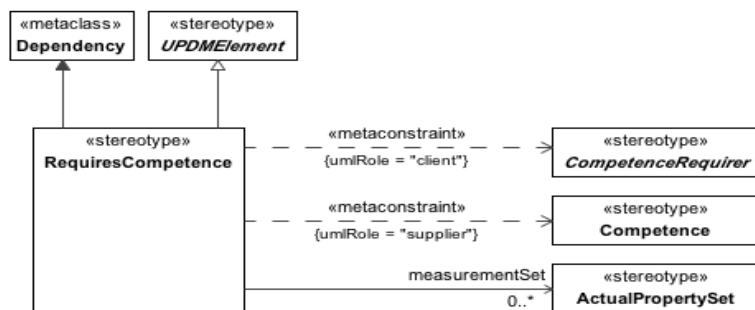

Figure 8.84 - RequiresCompetence

Constraints

The following are constraints for RequiresCompetence:

- RequiresCompetence.client - Value for the client property must be stereotyped a specialization of “CompetenceRequirer.”
- RequiresCompetence.supplier - Value for the client property must be stereotyped “Competence” or its specializations.

Attribute

The following are attributes for RequiresCompetence:

- measurementSet : ActualPropertySet[0..*] -

Extensions

The following are extensions for RequiresCompetence:

- Dependency

Generalizations

The following are generalization relationships for RequiresCompetence:

- UPDMElement

8.3.1.3.3.4.17.2.8 Responsibility

UPDM: Asserts that a Post or Organization has specific responsibilities.

MODAF: NA

DoDAF: NA

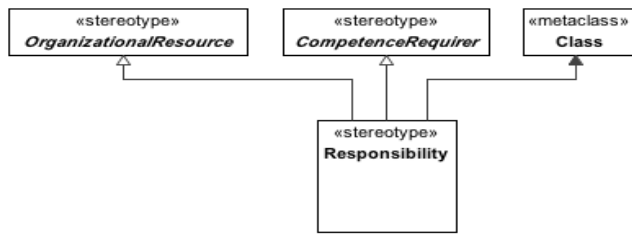

Figure 8.85 - Responsibility

Extensions

The following are extensions for Responsibility:

- Class

Generalizations

The following are generalization relationships for Responsibility:

- CompetenceRequirer
- OrganizationalResource

8.3.1.3.4 UPDM L1::UPDM L0::Core::ServiceElements

The Service-Orientated View (SOV) is a description of services needed to directly support the operational domain as described in the Operational View. A service should be understood in its broadest sense, as a unit of work through which a provider provides a useful result to a consumer. This could be anything from web-based services to delivering an effect to transporting troops.

8.3.1.3.4.1 UPDM L1::UPDM L0::Core::ServiceElements::Behavior

Behavior elements of the service oriented view.

8.3.1.3.4.1.1 ServiceFeature

UPDM:Abstract grouping used to ServiceFunctions to Serviceoperations and ServiceMessageHandlers.

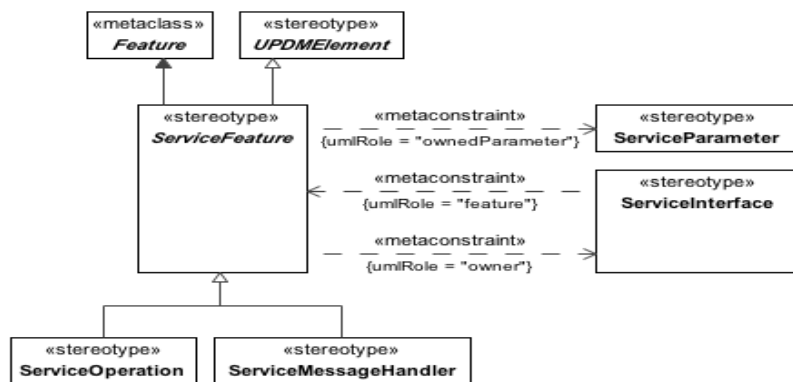

Figure 8.86 - ServiceFeature

Constraints

The following are constraints for ServiceFeature:

- ServiceFeature.ownedParameter - The values for the ownedParameter property must be stereotyped “ServiceParameter.”
- ServiceFeature.owner - The values for the owner property must be stereotyped “ServiceInterface.”

Extensions

The following are extensions for ServiceFeature:

- Feature

Generalizations

The following are generalization relationships for ServiceFeature:

- UPDMElement

8.3.1.3.4.1.2 ServiceFunction

UPDM: A ServiceFunction describes the abstract behavior of ServiceOperations, regardless of the actual implementation.

MODAF: A type of activity describing the functionality of a service.

DoDAF: Information necessary to interact with the service in such terms as the service inputs, outputs, and associated semantics. The service description also conveys what is accomplished when the service is invoked and the conditions for using the service.

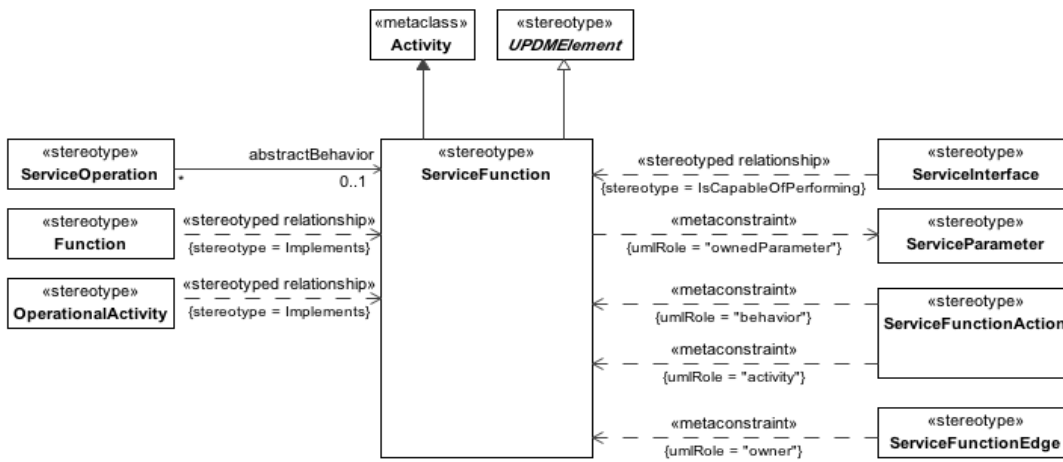

Figure 8.87 - ServiceFunction

Constraints

The following are constraints for ServiceFunction:

- ServiceFunction.ownedParameter - The values for the ownedParameter property must be stereotyped “ServiceParameter.”

Attribute

The following are attributes for ServiceFunction:

- defines : ServiceFeature[0..1] -
- transactionPoint : ServiceInterface[] -

Extensions

The following are extensions for ServiceFunction:

- Activity

Generalizations

The following are generalization relationships for ServiceFunction:

- UPDMElement

8.3.1.3.4.1.3 ServiceFunctionAction

UPDM: A call behavior action that invokes the ServiceFunction that needs to be preformed. This concept is required for mapping the architecture with UML and does not have a DoDAF or MODAF equivalent.

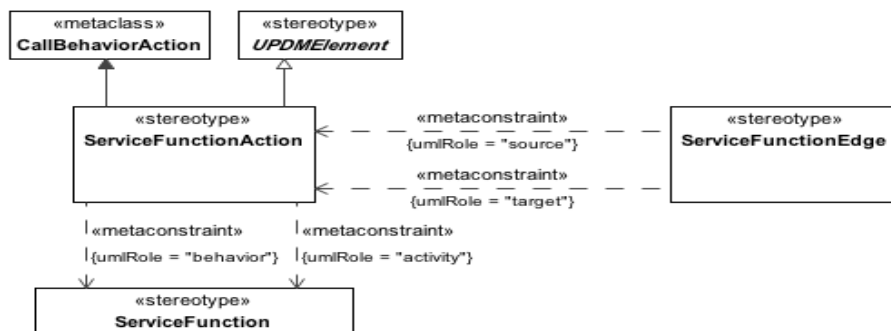

Figure 8.88 - ServiceFunctionAction

Constraints

The following are constraints for ServiceFunctionAction:

- ServiceFunctionAction.activity - Value for the behavior property must be stereotyped “ServiceFunction” or its specializations.
- ServiceFunctionAction.behavior - Value for the activity property must be stereotyped “ServiceFunction” or its specializations.

Extensions

The following are extensions for ServiceFunctionAction:

- CallBehaviorAction

Generalizations

The following are generalization relationships for ServiceFunctionAction:

- UPDMElement

8.3.1.3.4.1.4 ServiceFunctionEdge

UPDM: An extension of <<ActivityEdge>> that is used to model the flow of control/objects through a ServiceFunction.

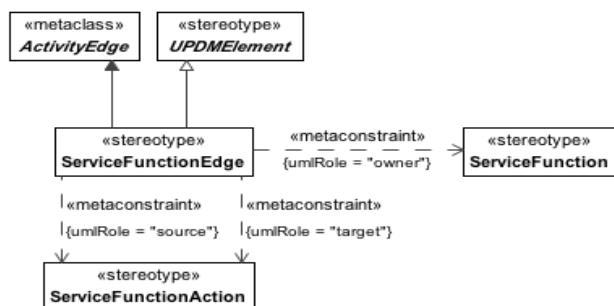

Figure 8.89 - ServiceFunctionEdge

Constraints

The following are constraints for ServiceFunctionEdge:

- ServiceFunctionEdge.owner - Value for the target property must be stereotyped “ServiceFunction” or its specializations.

Extensions

The following are extensions for ServiceFunctionEdge:

- ActivityEdge

Generalizations

The following are generalization relationships for ServiceFunctionEdge:

- UPDMElement

8.3.1.3.4.1.5 ServiceInteraction

UPDM: Interaction for a service interface

MODAF: A model representing how a set of Service classes interacts with one another (MODAF::ServiceInteractionSpecification).

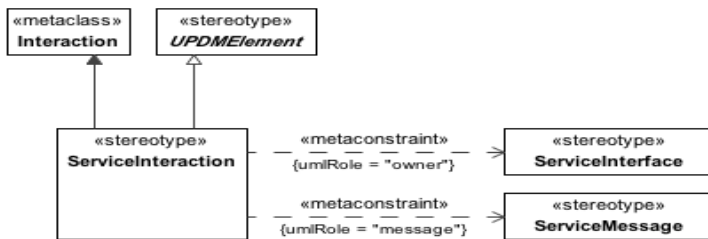

Figure 8.90 - ServiceInteraction

Constraints

The following are constraints for ServiceInteraction:

- ServiceInteraction.message - Values for the message property must be stereotyped with “ServiceMessage” or its specializations.
- ServiceInteraction.owner - Value for the target property must be stereotyped “ServiceInterface” or its specializations.

Extensions

The following are extensions for ServiceInteraction:

- Interaction

Generalizations

The following are generalization relationships for ServiceInteraction:

- UPDMElement

8.3.1.3.4.1.6 ServiceMessage

UPDM: Message for use in a Service Interaction Specification, implements a resourceInteraction or any of the subtypes.

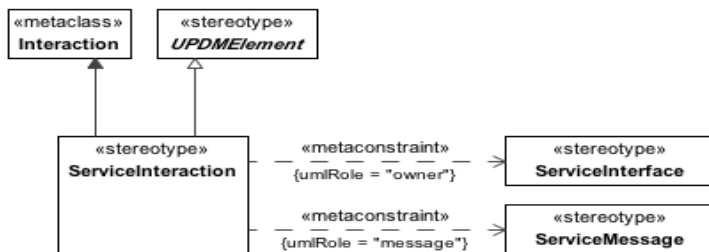

Figure 8.91 - ServiceMessage

Constraints

The following are constraints for ServiceMessage:

- ServiceMessage.receiveEvent.event.operation - Values for the receiveEvent.event.operation property must be stereotyped with “ServiceOperation” or its specializations.

Attribute

The following are attributes for ServiceMessage:

- carries : Exchange[*] - Carried ResourceInteraction.
- operation : ServiceOperation[0..1] -

Extensions

The following are extensions for ServiceMessage:

- Message

Generalizations

The following are generalization relationships for ServiceMessage:

- UPDMElement

8.3.1.3.4.1.7 ServiceMessageHandler

UPDM:An instance of an AsynchronousMessage, applied in the service domain.

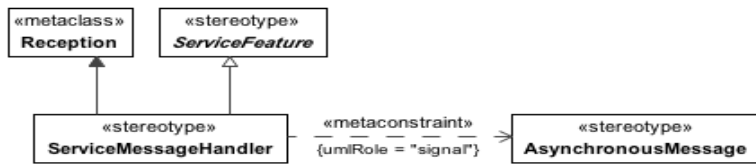

Figure 8.92 - ServiceMessageHandler

Constraints

The following are constraints for ServiceMessageHandler:

- ServiceMessageHandler.signal - Values for the signal property must be stereotyped with “AsynchronousMessage” or its specializations.

Extensions

The following are extensions for ServiceMessageHandler:

- Reception

Generalizations

The following are generalization relationships for ServiceMessageHandler:

- ServiceFeature

8.3.1.3.4.1.8 ServiceOperation

UPDM: A ServiceOperation provides the access point for invoking the behavior of a provided service. The ServiceOperations are defined on ServiceInterfaces and mirrored on the providing Resource to handle calls forwarded on by the interface.

MODAF: a function or procedure which enables programmatic communication with a Service via a ServiceInterface (MODAF:: ServiceInterfaceOperation).

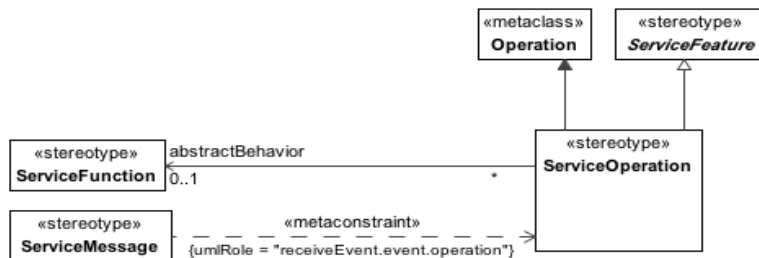

Figure 8.93 - ServiceOperation

Constraints

The following are constraints for ServiceOperation:

- ServiceOperation.ownedParameter - The values for the ownedParameter property must be stereotyped “ServiceParameter” or its specializations.

Attribute

The following are attributes for ServiceOperation:

- abstractBehavior : ServiceFunction[0..1] - Links a ServiceOperation to the abstract description of its behavior, as provided by a ServiceFunction.

Extensions

The following are extensions for ServiceOperation:

- Operation

Generalizations

The following are generalization relationships for ServiceOperation:

- ServiceFeature

8.3.1.3.4.1.9 ServiceParameter

UPDM: Represents inputs and outputs of Service. It is typed by ResourceInteractionItem.

MODAF: A constant or variable passed into or out of a ServiceInterface as part of the execution of a ServiceInterfaceOperation (MODAF:: ServiceInterfaceParameter).

DoDAF: NA

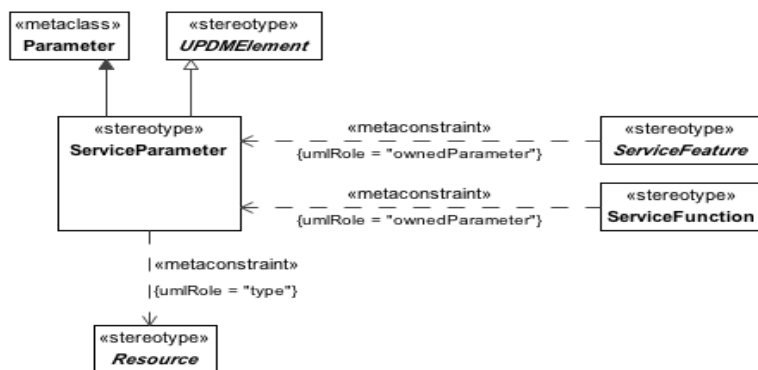

Figure 8.94 - ServiceParameter

Constraints

The following are constraints for ServiceParameter:

- ServiceParameter.type - The values for the type property must be stereotyped a specialization of “Resource.”

Extensions

The following are extensions for ServiceParameter:

- Parameter

Generalizations

The following are generalization relationships for ServiceParameter:

- UPDMElement

8.3.1.3.4.1.10 ServiceStateMachine

UPDM Artifact that extends a UML StateMachine.

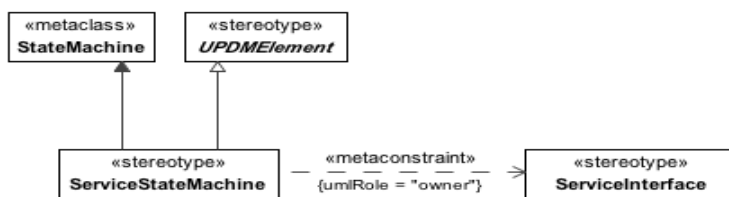

Figure 8.95 - ServiceStateMachine

Constraints

The following are constraints for ServiceStateMachine:

- ServiceStateMachine.owner - Values for the owner property must be stereotyped “ServiceInterface” or its specializations.

Extensions

The following are extensions for ServiceStateMachine:

- StateMachine

Generalizations

The following are generalization relationships for ServiceStateMachine:

- UPDMElement

8.3.1.3.4.2 UPDM L1::UPDM L0::Core::ServiceElements::Structure

Structure elements of the service oriented view.

8.3.1.3.4.2.1 AsynchronousMessage

MODAF: A signal which is transmitted irregularly with respect to time.

DoDAF: NA

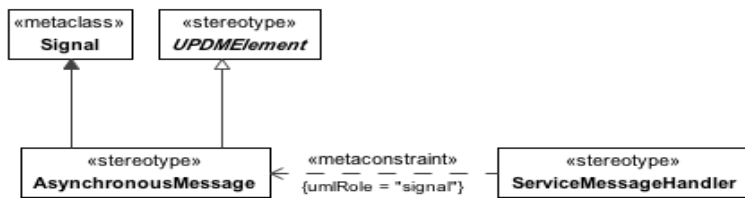

Figure 8.96 - AsynchronousMessage

Extensions

The following are extensions for AsynchronousMessage:

- Signal

Generalizations

The following are generalization relationships for AsynchronousMessage:

- UPDMElement

8.3.1.3.4.2.2 Request

UPDM:From SOAML A Request represents a feature of a Participant that is the consumption of a service by one participant provided by others using well-defined terms, conditions and interfaces. A Request designates ports that define the connection point through which a Participant meets its needs through the consumption of services provided by others.

MODAF:Similar to requires, Asserts that a Resource requires a Service to be provided in order to function correctly.

DoDAF: Similar to ServicePort, A part of a Performer that specifies a distinct interaction point through which the Performer interacts with other Performers. This isolates dependencies between performers to particular interaction points rather than to the performer as a whole.

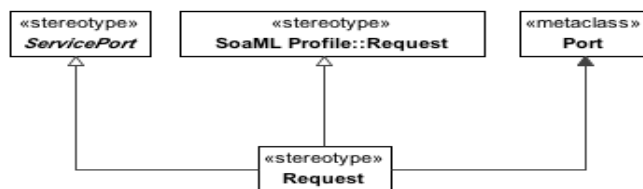

Figure 8.97 - Request

Extensions

The following are extensions for Request:

- Port

Generalizations

The following are generalization relationships for Request:

- Request
- ServicePort

8.3.1.3.4.2.3 Service

MODAF: A type of delivered functionality, specified independently of the resources that provide it.

DoDAF: mechanism to enable access to a set of one or more capabilities, where the access is provided using a prescribed interface and is exercised consistent with constraints and policies as specified by the service description. The mechanism is a Performer. The “capabilities” accessed are Resources -- Information, Data, Materiel, Performers, and Geo-political Extents.

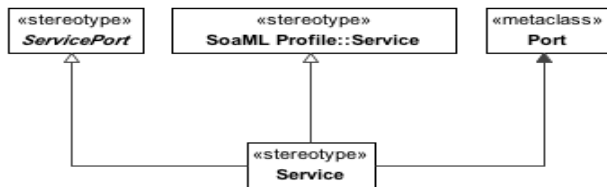

Figure 8.98 - Service

Extensions

The following are extensions for Service:

- Port

Generalizations

The following are generalization relationships for Service:

- Service
- ServicePort

8.3.1.3.4.2.4 ServiceAttribute

MODAF: A property of Service.

DoDAF: NA

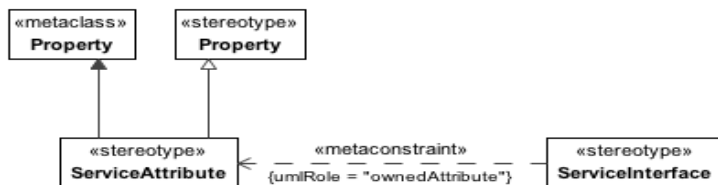

Figure 8.99 - ServiceAttribute

Constraints

The following are constraints for ServiceAttribute:

- ServiceAttribute.type - The values for the type property must be stereotyped “ServiceInterface” or its specialization.

Extensions

The following are extensions for ServiceAttribute:

- Property

Generalizations

The following are generalization relationships for ServiceAttribute:

- UPDMElement

8.3.1.3.4.2.5 ServiceInterface

UPDM: A contractual agreement between two resources that implement protocols through which the source service interacts to the destination resource. A physical connection between two resources that implements protocols through which the source resource can transmit items to the destination resource.

MODAF: The mechanism by which a Service communicates.

DoDAF: An overlap between Performers for the purpose of producing a Resource that is consumed by the other. (DoDAF::Interface).

SOAML: Defines the interface to a Service Point or Request Point and is the type of a role in a service contract.

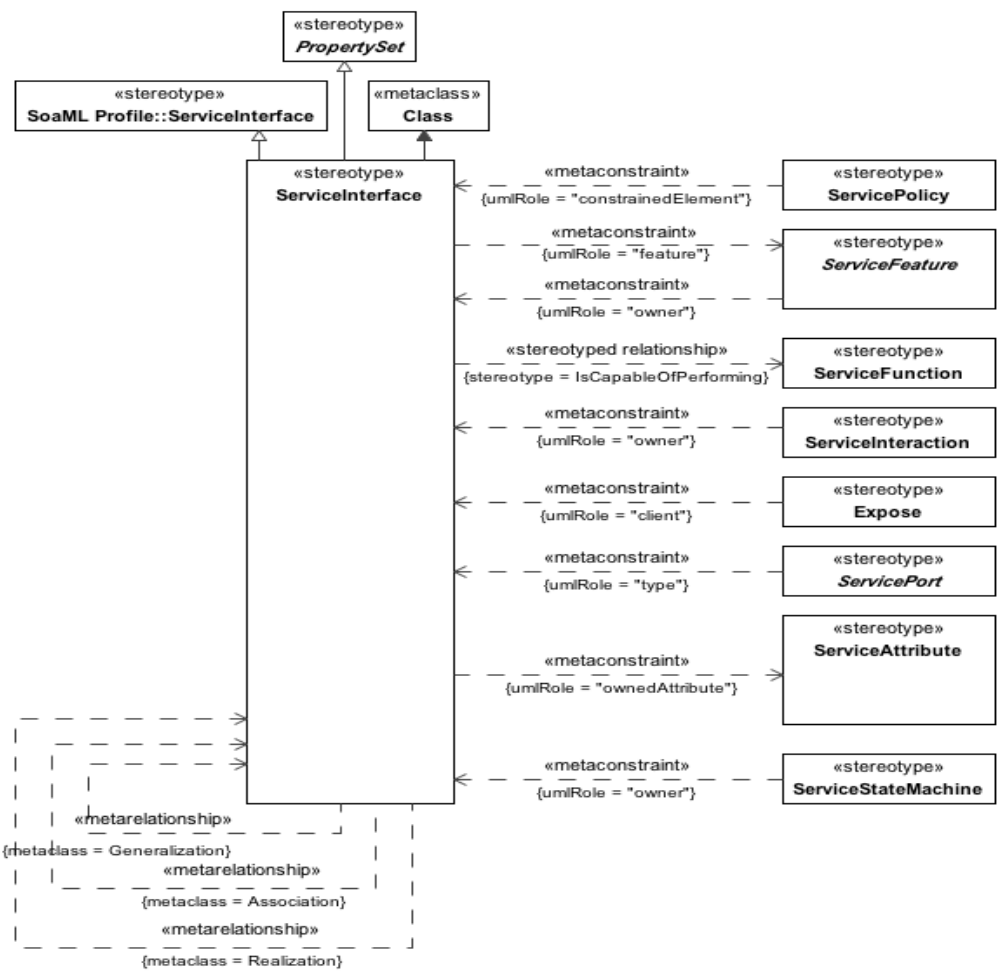

Figure 8.100 - ServiceInterface

Constraints

The following are constraints for ServiceInterface:

- ServiceInterface.feature - Value for the feature property must be stereotyped “ServiceFeature” or its specializations.
- ServiceInterface.ownedAttribute - Values for ownedAttribute property must be stereotyped “ServiceAttribute” or its specializations.

Attribute

The following are attributes for ServiceInterface:

- contract : ServiceFunction[] -
- Extensions

The following are extensions for ServiceInterface:

- Class

Generalizations

The following are generalization relationships for ServiceInterface:

- ServiceInterface
- PropertySet

8.3.1.3.4.2.6 ServiceLevelValue

MODAF:A ServiceAttributes indicating the level to which a Resource delivers a Service, in a particular environment.

DoDAF:NA

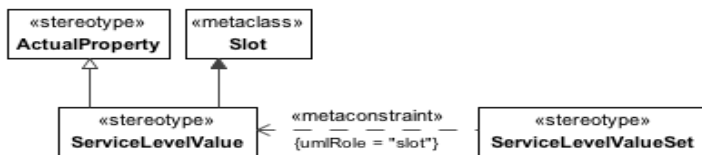

Figure 8.101 - ServiceLevelValue

Extensions

The following are extensions for ServiceLevelValue:

- Slot

Generalizations

The following are generalization relationships for ServiceLevelValue:

- ActualProperty

8.3.1.3.4.2.7 ServiceLevelValueSet

MODAF:A value specification for a set of ServiceAttributes indicating the level to which a Resource delivers a Service, in a particular environment.

DoDAF:NA

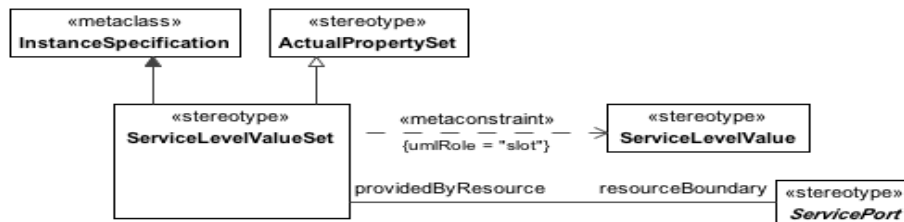

Figure 8.102 - ServiceLevelValueSet

Constraints

The following are constraints for ServiceLevelValueSet:

- ServiceLevelValueSet.slot - Slot property value must be stereotyped “ServiceLevelValue” or its specializations.

Attribute

The following are attributes for ServiceLevelValueSet:

- resourceBoundary : ServicePort[] -

Extensions

The following are extensions for ServiceLevelValueSet:

- InstanceSpecification

Generalizations

The following are generalization relationships for ServiceLevelValueSet:

- ActualPropertySet

8.3.1.3.4.2.8 ServicePolicy

UPDM: A constraint governing the consumers and providers of services

MODAF: A constraint governing one or more Services.

DoDAF: Agreement: A consent among parties regarding the terms and conditions of activities that said parties participate in.

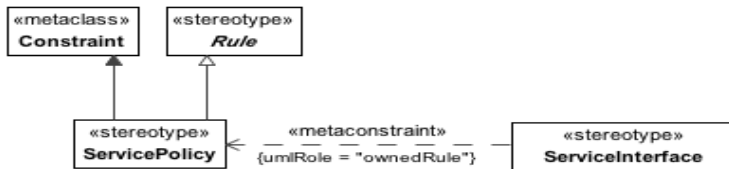

Figure 8.103 - ServicePolicy

Extensions

The following are extensions for ServicePolicy:

- Constraint

Generalizations

The following are generalization relationships for ServicePolicy:

- UPDMElement
- Rule

8.3.1.3.4.2.9 ServicePort

MODAF: ServiceInterface - The mechanism by which a Service communicates.

DoDAF: A part of a Performer that specifies a distinct interaction point through which the Performer interacts with other Performers. This isolates dependencies between performers to particular interaction points rather than to the performer as a whole.

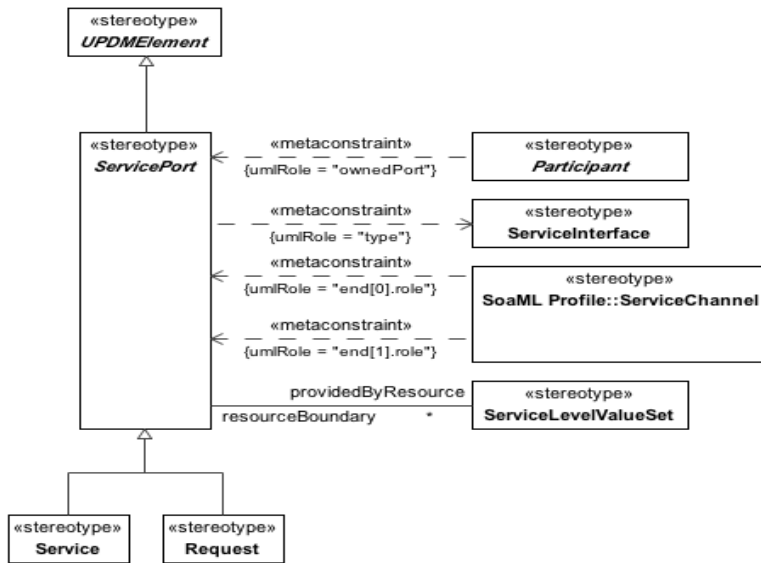

Figure 8.104 - ServicePort

Constraints

The following are constraints for ServicePort:

- ServicePort.actualPropertySets - Values for actualPropertySets property must be stereotyped “ServiceLevelValueSet” or its specializations.
- ServicePort.type - Values for type property must be stereotyped “ServiceInterface” or its specializations.

Attribute

The following are attributes for ServicePort:

- providedByResource : ServiceLevelValueSet[] -

Extensions

The following are extensions for ServicePort:

- Port

Generalizations

The following are generalization relationships for ServicePort:

- UPDMElement

8.3.1.3.5 UPDM L1::UPDM L0::Core::StrategicElements

The Strategic Elements are used in the Strategic View that provides an overall Enterprise Architecture assessment of the Capabilities and their relationships facilitating Capability Management (e.g., capability introduction, integration, re-alignment, and removal). While an Enterprise will have a number of UPDM Architecture Descriptions that have the Operational, System, Technical Standards, and All Views. Only one Strategic View will exist across a number of Architecture Descriptions.

8.3.1.3.5.1 UPDM L1::UPDM L0::Core::StrategicElements::Structure

Structural section of the StrategicElements profile.

8.3.1.3.5.1.1 Capability

MODAF: A high level specification of the enterprise’s ability.

DoDAF: The ability to achieve a desired effect under specified [performance] standards and conditions through combinations of ways and means [activities and resources] to perform a set of activities.

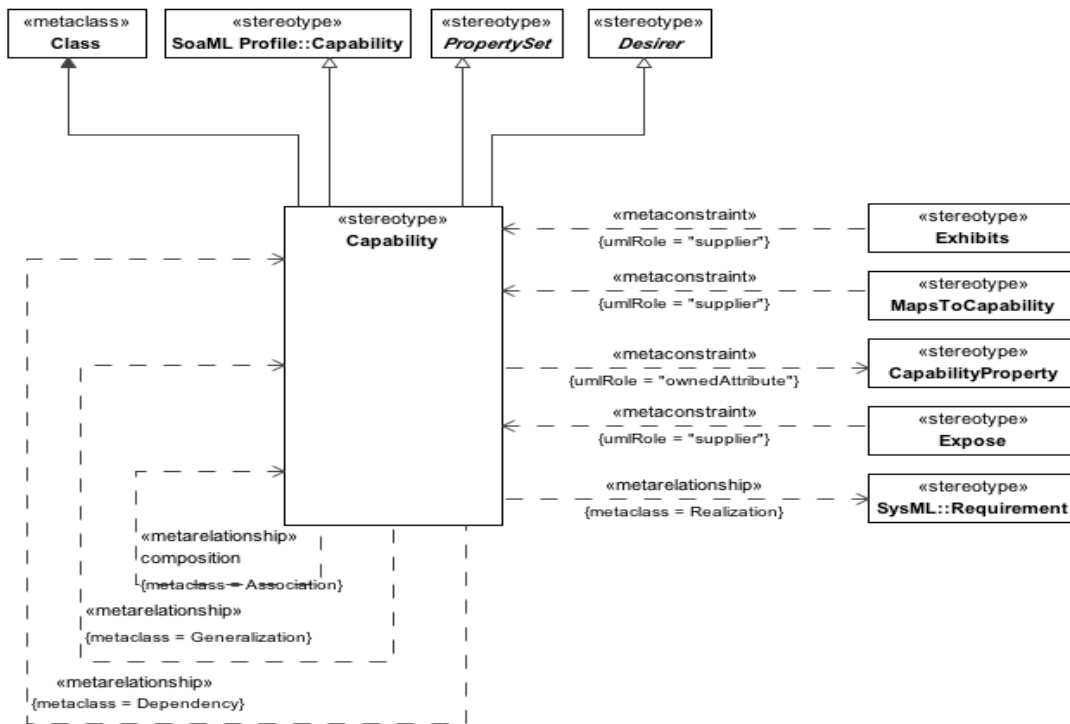

Figure 8.105 - Capability

Constraints

The following are constraints for Capability:

- Capability.ownedAttribute - Values for ownedAttribute property must be stereotyped “CapabilityProperty” or its specializations.

Extensions

The following are extensions for Capability:

- Class

Generalizations

The following are generalization relationships for Capability:

- Capability
- PropertySet
- Desirer

8.3.1.3.5.1.2 CapabilityProperty

UPDM: A property of a capability.

MODAF: NA

DoDAF: NA

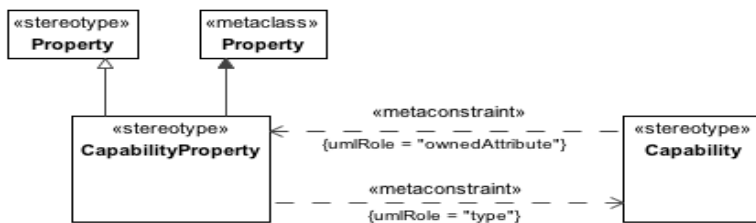

Figure 8.106 - CapabilityProperty

Constraints

The following are constraints for CapabilityProperty:

- CapabilityProperty.type - Value for type meta property must be stereotyped “Capability” or its specializations.

Extensions

The following are extensions for CapabilityProperty:

- Property

Generalizations

The following are generalization relationships for CapabilityProperty:

- Property

8.3.1.3.5.1.3 EnterpriseGoal

MODAF: A specific, required objective of the enterprise that the architecture represents.

DoDAF: NA

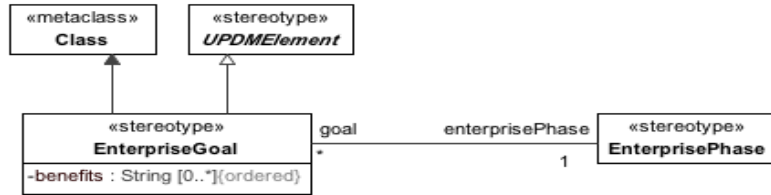

Figure 8.107 - EnterpriseGoal

Attribute

The following are attributes for EnterpriseGoal:

- benefits : String[0..*] - A description of the usefulness of the Goal in terms of why the state or condition of the Enterprise is worth attaining.
- enterprisePhase : EnterprisePhase[1] - Phase of the goal.

Extensions

The following are extensions for EnterpriseGoal:

- Class

Generalizations

The following are generalization relationships for EnterpriseGoal:

- UPDMElement

8.3.1.3.5.1.4 EnterprisePhase

MODAF: A specific, required objective of the enterprise that the architecture represents.

DoDAF: NA

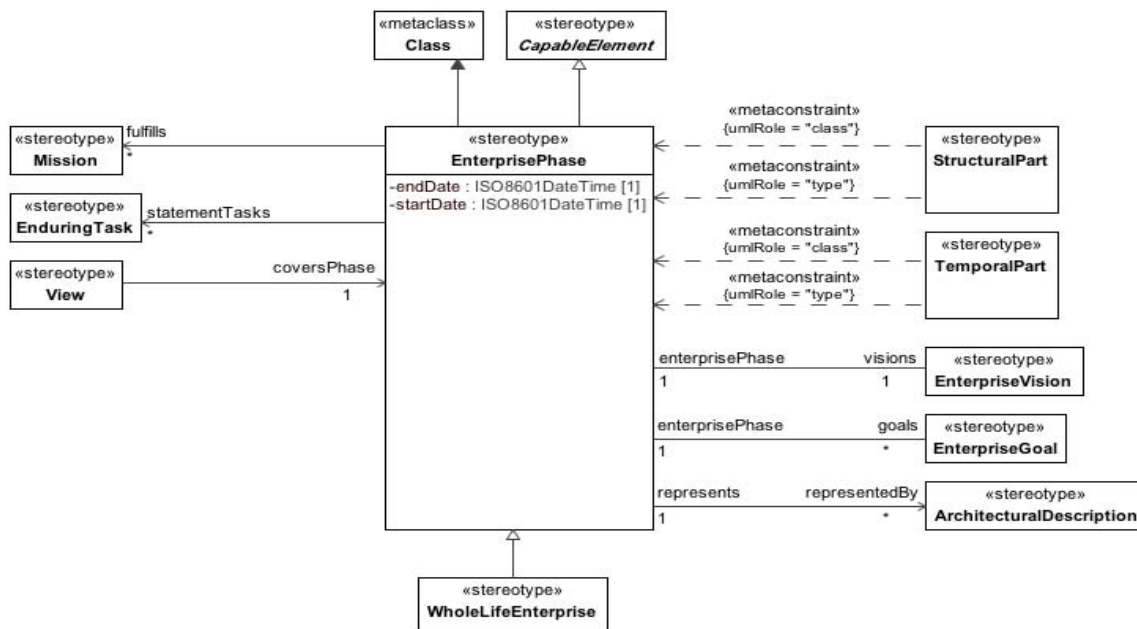

Figure 8.108 - EnterprisePhase

Constraints

The following are constraints for EnterprisePhase:

- Enterprise from/to - Must fall within the Enterprise to and from time, the complete lifecycle.
- EnterprisePhase.useCase - Values for the useCase property must be stereotyped “Mission.”

Attribute

The following are attributes for EnterprisePhase:

- endDate : ISO8601DateTime[1] - The time and date at which the Phase ends.
- fulfills : Mission[*] -
- goals : EnterpriseGoal[*] - The Goal towards which this Phase is directed and is in support of.
- representedBy : ArchitecturalDescription[*] -
- startDate : ISO8601DateTime[1] - The time and date at which the Phase starts.
- statementTasks : EnduringTask[*] - Collection of statement tasks.
- visions : EnterpriseVision[1] - The Vision towards which this Phase is directed and is in support of.

Extensions

The following are extensions for EnterprisePhase:

- Class

Generalizations

The following are generalization relationships for EnterprisePhase:

- UPDMElement
- CapableElement

8.3.1.3.5.1.5 EnterpriseVision

MODAF: The overall aims of an enterprise over a given period of time.

DoDAF: (DoDAF::Vision): An end that describes the future state of the enterprise, without regard to how it is to be achieved; a mental image of what the future will or could be like.

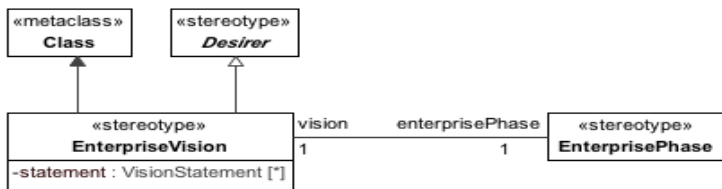

Figure 8.109 - EnterpriseVision

Attribute

The following are attributes for EnterpriseVision:

- enterprisePhase : EnterprisePhase[1] - The phase which temporally locates the Vision.
- statement : VisionStatement[*] - A description of the Vision.

Extensions

The following are extensions for EnterpriseVision:

- Class

Generalizations

The following are generalization relationships for EnterpriseVision:

- Desirer

8.3.1.3.5.1.6 Exhibits

UPDM: Relationship between a Node and a capability the node provides.

MODAF: (MODAF::CapabilityForNode): An assertion that a Node is required to have a Capability.

DoDAF: A couple that represents the capability that a performer manifests.

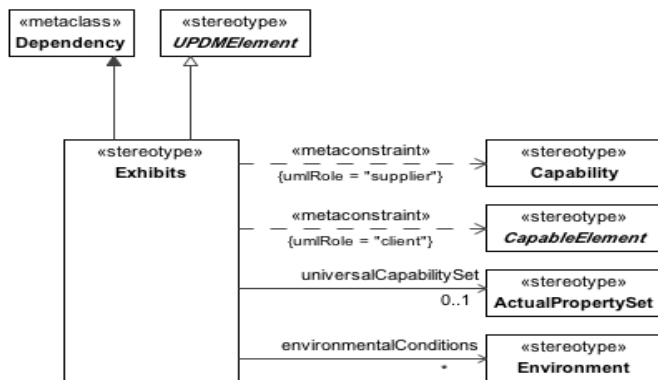

Figure 8.110 - Exhibits

Constraints

The following are constraints for Exhibits:

- ExhibitsCapability.client - Value for the client property must be stereotyped a specialization of “CapableElement.”
- ExhibitsCapability.supplier - Value for the supplier property must be stereotyped “Capability.”

Attribute

The following are attributes for Exhibits:

- environmentalConditions : Environment[*] - Asserts that a Capability's capabilityMetric (MeasureableProperty) is valid for a particular environment.
- universalCapabilitySet : ActualPropertySet[0..1] -

Extensions

The following are extensions for Exhibits:

- Dependency

Generalizations

The following are generalization relationships for Exhibits:

- UPDMElement

8.3.1.3.5.1.7 MapsToCapability

MODAF: Asserts that a StandardOperationalActivity is in some way part of a capability.

DoDAF: MapsToCapability (DoDAF::ActivityPartOfCapability) is a disposition to manifest an Activity. An Activity to be performed to achieve a desired effect under specified [performance] standards and conditions through combinations of ways and means.

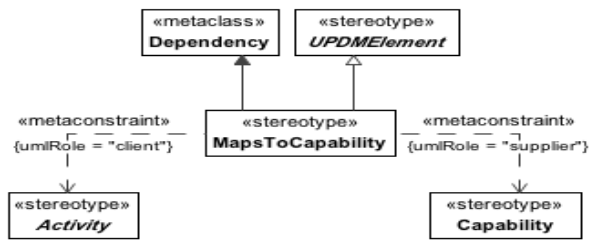

Figure 8.111 - MapsToCapability

Constraints

The following are constraints for MapsToCapability:

- MapsToCapability.client - Value for the client property must be stereotyped a specialization of “Activity.”
- MapsToCapability.supplier - Value for the supplier property must be stereotyped “Capability.”

Extensions

The following are extensions for MapsToCapability:

- Dependency

Generalizations

The following are generalization relationships for MapsToCapability:

- UPDMElement

8.3.1.3.5.1.8 StructuralPart

UPDM: An EnterprisePhase can be sub-divided into structural and temporal parts. StructuralPart describes the EnterprisePhase elements that describe the structure.

MODAF: Asserts that one EnterprisePhase is a spatial part of another, (MODAF::EnterpriseStructure).

NOTE:- This is a topological structuring relationship, hence the EnterprisePhase may be physically disjoint.

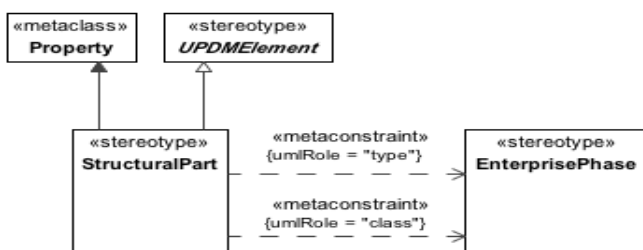

Figure 8.112 - StructuralPart

Constraints

The following are constraints for StructuralPart:

- StructuralPart.class - Value for class metaproperty must be stereotyped “EnterprisePhase” or its specializations.
- StructuralPart.type - Value for type metaproperty must be stereotyped “EnterprisePhase” or its specializations.

Extensions

The following are extensions for StructuralPart:

- Property

Generalizations

The following are generalization relationships for StructuralPart:

- UPDMElement

8.3.1.3.5.1.9 TemporalPart

UPDM Artifact: An EnterprisePhase can be sub-divided into structural and temporal parts. TemporalPart describes the EnterprisePhase elements that have a time based nature.

MODAF: Asserts that one EnterprisePhase is a temporal part of another. Note: This means that both EnterprisePhases have the same spatial extent (i.e., this is only a temporal structure (MODAF:: EnterpriseTemporalPart)).

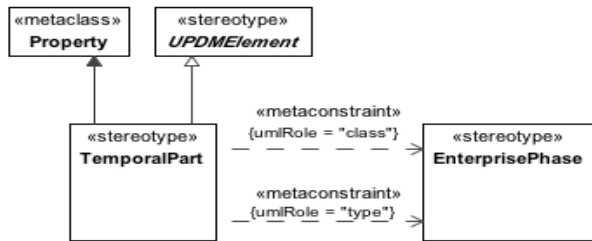

Figure 8.113 - TemporalPart

Constraints

The following are constraints for TemporalPart:

- TemporalPart.class - Value for class metaproperty must be stereotyped “EnterprisePhase” or its specializations.
- TemporalPart.type - Value for type metaproperty must be stereotyped “EnterprisePhase” or its specializations.

Extensions

The following are extensions for TemporalPart:

- Property

Generalizations

The following are generalization relationships for TemporalPart:

- UPDMElement

8.3.1.3.5.1.10 VisionStatement

MODAF: A high-level textual description of an EnterpriseVision.

DoDAF: An end that describes the future state of the enterprise, without regard to how it is to be achieved; a mental image of what the future will or could be like (DODAF::Vision).

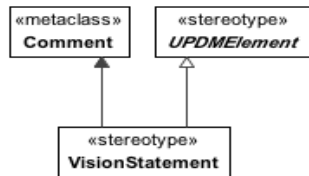

Figure 8.114 - VisionStatement

Extensions

The following are extensions for VisionStatement:

- Comment

Generalizations

The following are generalization relationships for VisionStatement:

- UPDMElement

Expose.client - Value for the client property must be stereotyped “ServiceInterface” or its specializations.
Expose.supplier - Value for the supplier property must be stereotyped “Capability.”

8.3.1.3.6 UPDM L1::UPDM L0::Core::SystemsElements

Models in the System Viewpoint represent alternate realizations in terms of equipment capability of the operational capabilities expressed through models in the Operational Viewpoint and in the User Requirements. The System Viewpoint primarily addresses the specification of the system capability needed (rather than implementation details). Significant changes originally made in MODAF improved the ability for modelers to represent configuration of capability that include people as well as systems and platforms.

8.3.1.3.6.1 UPDM L1::UPDM L0::Core::SystemsElements::Behavior

The Behavior section of the SystemsElements profile.

8.3.1.3.6.1.1 Function

MODAF: An activity that is specified in context of the resource (human or machine) that performs it.

DoDAF: Activity: Work, not specific to a single organization, weapon system or individual that transforms inputs (Resources) into outputs (Resources) or changes their state.

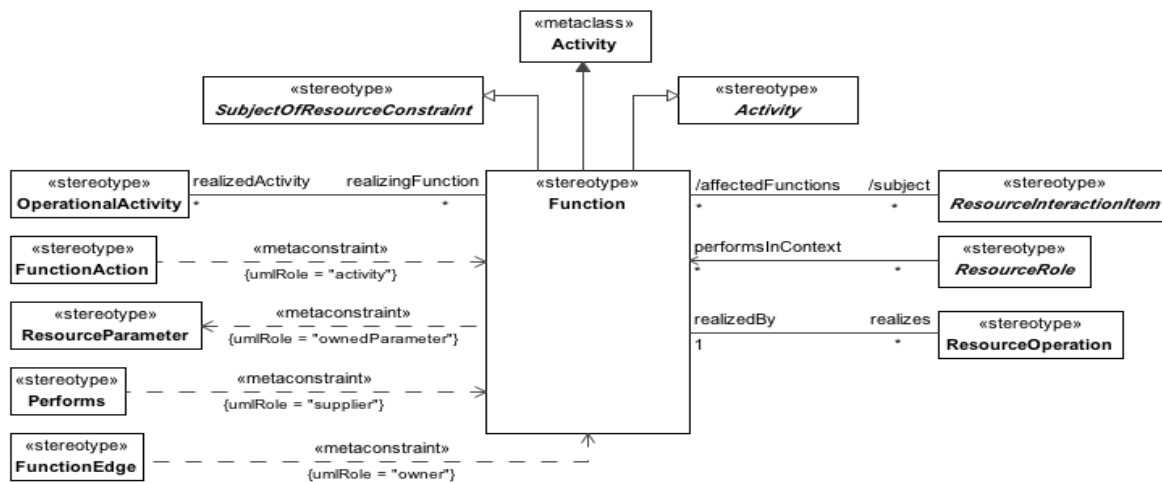

Figure 8.115 - Function

Constraints

The following are constraints for Function:

- Function.ownedParameter - The values for the ownedParameter property must be stereotyped “ResourceParameter.”

Attribute

The following are attributes for Function:

- realizedActivity : OperationalActivity[*] - The OperationalActivity that the Function realizes.
- realizes : ResourceOperation[*] -
- subject : ResourceInteractionItem[*] - The ResourceInteractionItem that is the subject of the Function.

Extensions

The following are extensions for Function:

- Activity

Generalizations

The following are generalization relationships for Function:

- Activity
- SubjectOfResourceConstraint

8.3.1.3.6.1.2 FunctionAction

UPDM Artifact: The FunctionAction is defined as a call behavior action that invokes the function that needs to be performed. This concept is required for mapping the architecture with UML and does not have a DoDAF or MODAF equivalent.

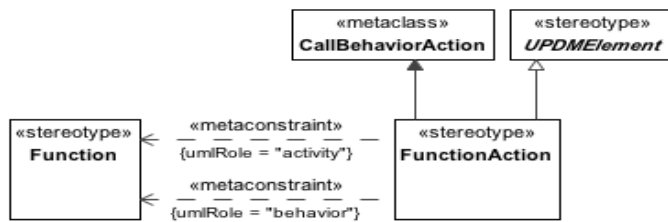

Figure 8.116 - FunctionAction

Constraints

The following are constraints for FunctionAction:

- FunctionAction.activity - Value for the activity property must be stereotyped “Function.”
- FunctionAction.behavior - Value for the behavior property must be stereotyped “Function.”

Extensions

The following are extensions for FunctionAction:

- CallBehaviorAction

Generalizations

The following are generalization relationships for FunctionAction:

- UPDMElement

8.3.1.3.6.1.3 FunctionEdge

UPDM: An extension of <<ActivityEdge>> that is used to model the flow of control/objects through a Function.

MODAF: A FunctionEdge (MODAF::FunctionFlow) is a UML::ObjectFlow between Functions.

NOTE: This has been extended in UPDM to additionally include UML::ControlFlows.

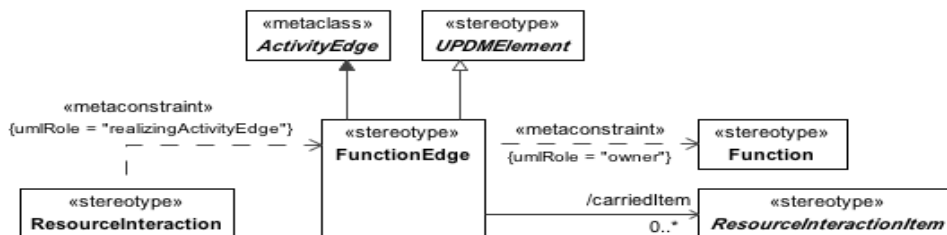

Figure 8.117 - FunctionEdge

Constraints

The following are constraints for FunctionEdge:

- FunctionEdge.owner - “FunctionEdge” must be owned directly or indirectly by “Function.”

Attribute

The following are attributes for FunctionEdge:

- carriedItem : ResourceInteractionItem[0..*] - The ResourceInteractionItem that is conveyed.

Extensions

The following are extensions for FunctionEdge:

- ActivityEdge

Generalizations

The following are generalization relationships for FunctionEdge:

- UPDMElement

8.3.1.3.6.1.4 ResourceEventTrace

UPDM: A UPDM artifact that extends a UML Interaction.

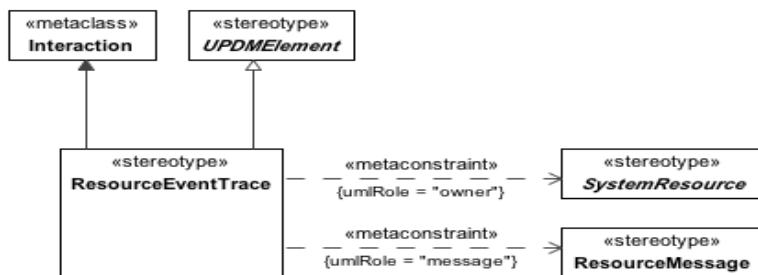

Figure 8.118 - ResourceEventTrace

Constraints

The following are constraints for ResourceEventTrace:

- ResourceEventTrace.message - Values for the message property must be stereotyped with “ResourceMessage” or its specializations.
- ResourceEventTrace.owner - Values for the owner property must be stereotyped with “SystemResource” or its specializations.

Extensions

The following are extensions for ResourceEventTrace:

- Interaction

Generalizations

The following are generalization relationships for ResourceEventTrace:

- UPDMElement

8.3.1.3.6.1.5 ResourceMessage

UPDM: Message for use in a Resource Event-Trace, implements a ResourceInteraction.

MODAF: A specification of the interactions between aspects of a Resources architecture (MODAF::ResourceInteractionSpecification).

DoDAF: An overlap of an Activity with a Resource, in particular a consuming or producing Activity that expresses an input, output, consumption, or production Activity of the Resource (DoDAF:: activityResourceOverlap).

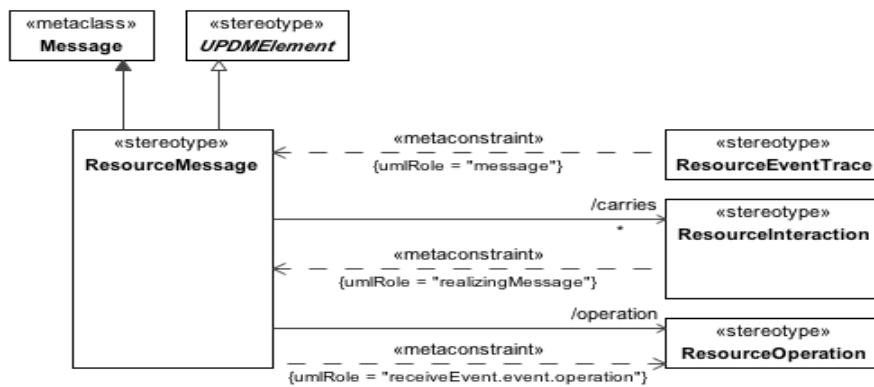

Figure 8.119 - ResourceMessage

Attribute

The following are attributes for ResourceMessage:

- carries : ResourceInteraction[*] - Carried ResourceInteraction
- operation : ResourceOperation[0..1] -

Extensions

The following are extensions for ResourceMessage:

- Message

Generalizations

The following are generalization relationships for ResourceMessage:

- UPDMElement

8.3.1.3.6.1.6 ResourceOperation

UPDM: A partial or full realization of Function.

MODAF: NA

DoDAF: NA

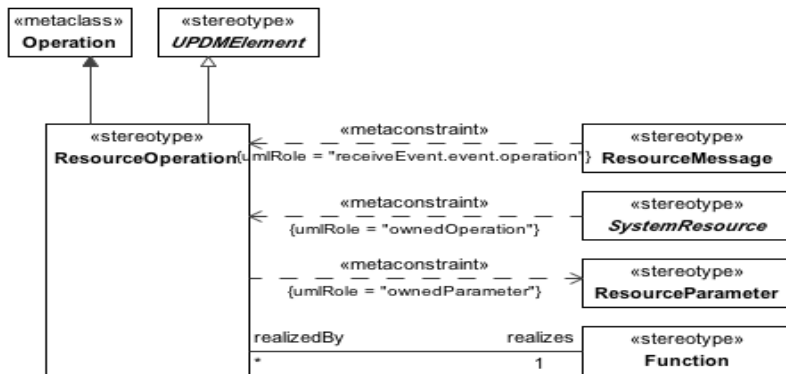

Figure 8.120 - ResourceOperation

Constraints

The following are constraints for ResourceOperation:

- ResourceOperation.ownedParameter - The values for the ownedParameter property must be stereotyped “ResourceParameter.”

Attribute

The following are attributes for ResourceOperation:

- realizedBy : Function[1] -

Extensions

The following are extensions for ResourceOperation:

- Operation

Generalizations

The following are generalization relationships for ResourceOperation:

- UPDMElement

8.3.1.3.6.1.7 ResourceParameter

UPDM: Represents inputs and outputs of Function. It is typed by ResourceInteractionItem.

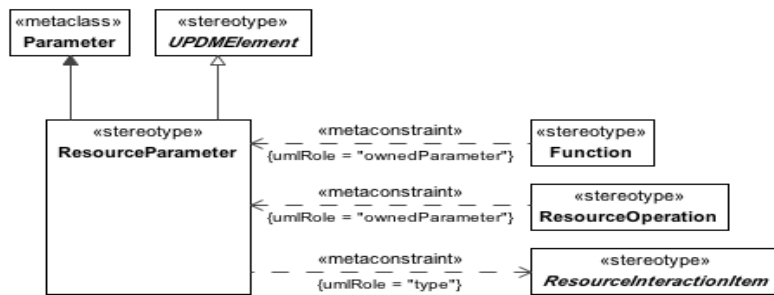

Figure 8.121 - ResourceParameter

Constraints

The following are constraints for ResourceParameter:

- ResourceParameter.type - Value for the type property must be stereotyped with specialization of “ResourceInteractionItem.”

Extensions

The following are extensions for ResourceParameter:

- Parameter

Generalizations

The following are generalization relationships for ResourceParameter:

- UPDMElement

8.3.1.3.6.1.8 ResourceStateMachine

UPDM Artifact that extends a UML StateMachine allied to Resources.

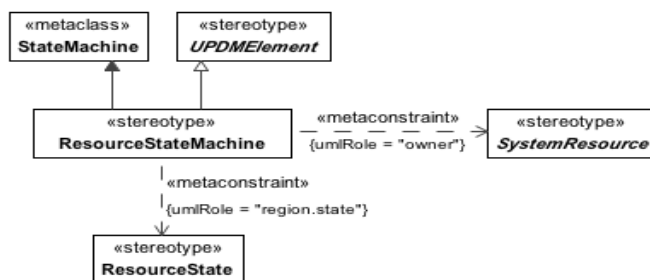

Figure 8.122 - ResourceStateMachine

Constraints

The following are constraints for ResourceStateMachine:

- ResourceStateMachine.owner - Values for the owner property must be stereotyped with “SystemResource” or its specializations.
- ResourceStateMachine.region.state - Values for the region.state property must be stereotyped with “ResourceState” or its specializations.

Extensions

The following are extensions for ResourceStateMachine:

- StateMachine

Generalizations

The following are generalization relationships for ResourceStateMachine:

- UPDMElement

8.3.1.3.6.1.9 ResourceState

UPDM: State identified in the context of an ResourceStateDescription.

MODAF:N/A

DoDAF:N/A

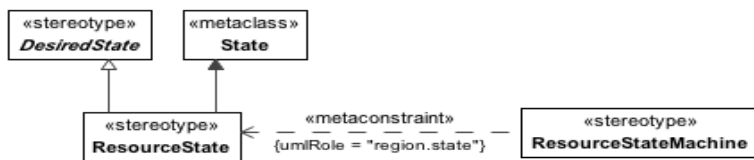

Figure 8.123 - ResourceState

Extensions

The following metaclasses are extended by ResourceState:

- State

Specializations

The ResourceState element is a specialization of:

- DesiredState

8.3.1.3.6.2 UPDM L1::UPDM L0::Core::SystemsElements::Data

The Data section of the SystemsElements profile.

8.3.1.3.6.2.1 DataModel

MODAF: A structural specification of data, showing classifications of data elements and relationships between them.

DoDAF: NA

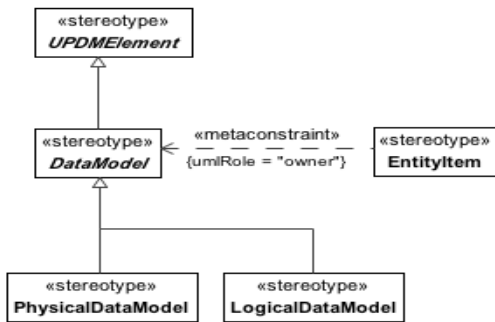

Figure 8.124 - DataModel

Constraints

The following are constraints for DataModel:

- DataModel.ownedElement - All classifiers owned by PhysicalDataModel must be stereotyped “EntityItem.”

Generalizations

The following are generalization relationships for DataModel:

- UPDMElement

8.3.1.3.6.2.2 PhysicalDataModel

MODAF: A PhysicalDataModel is an implementable specification of a data structure. A PhysicalDataModel realizes a LogicalDataModel, taking into account implementation restrictions and performance issues while still enforcing the constraints, relationships, and typing of the logical model.

DoDAF: A Physical Data Model defines the structure of the various kinds of system or service data that are utilized by the systems or services in the Architecture.

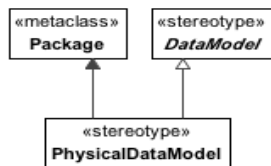

Figure 8.125 - PhysicalDataModel

Extensions

The following are extensions for PhysicalDataModel:

- Package

Generalizations

The following are generalization relationships for PhysicalDataModel:

- DataModel

8.3.1.3.6.3 UPDM L1::UPDM L0::Core::SystemsElements::Flows

The Flows section of the SystemsElements profile.

8.3.1.3.6.3.1 ResourceInteraction

UPDM: ResourceInteraction represents data that is exchanged between the resources.

MODAF: An assertion that two FunctionalResources interact. Examples : data exchange between systems, conversations between people, people using systems.

DoDAF: NA

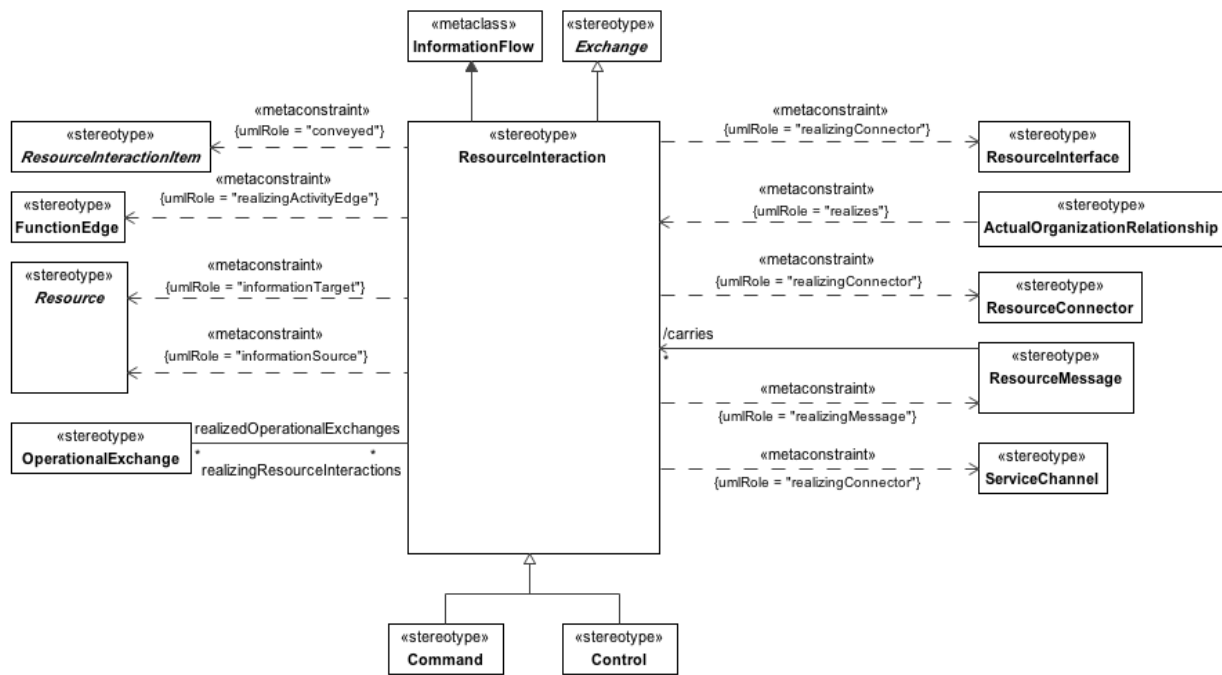

Figure 8.126 - ResourceInteraction

Constraints

The following are constraints for ResourceInteraction:

- ResourceInteraction.conveyedElement - Value for the conveyedElement property must be stereotyped “ResourceInteractionItem” or its specializations.
- ResourceInteraction.informationSource - Value for the informationSource property must be stereotyped “Resource” or its specializations.
- ResourceInteraction.informationTarget - Value for the informationTarget property must be stereotyped “Resource” or its specializations.

- ResourceInteraction.realization - Value for the realization property must be stereotyped “ResourceInterface,” “ActualOrganizationReationship,” or their specializations.
- ResourceInteraction.realizingActivityEdge - Value for the realizingActivityEdge property must be stereotyped “FunctionEdge” or its specializations.
- ResourceInteraction.realizingConnector - Value for the realizingConnector property must be stereotyped “ResourceInterface,” “ResourceConnector,” “ServiceChannel,” or their specializations.

Attribute

The following are attributes for ResourceInteraction:

- realizedOperationalExchanges : OperationalExchange[*] -

Extensions

The following are extensions for ResourceInteraction:

- InformationFlow

Generalizations

The following are generalization relationships for ResourceInteraction:

- Exchange

8.3.1.3.6.3.2 ResourceInteractionItem

UPDM Abstract: Represents the item(s) exchanged between the resources through a ResourceInteraction.

MODAF: Formalized representation of data that is managed by or exchanged between systems (MODAF::DataElement).

DoDAF: Representation of information in a formalized manner suitable for communication, interpretation, or processing by humans or by automatic means (DoDAF::Data).

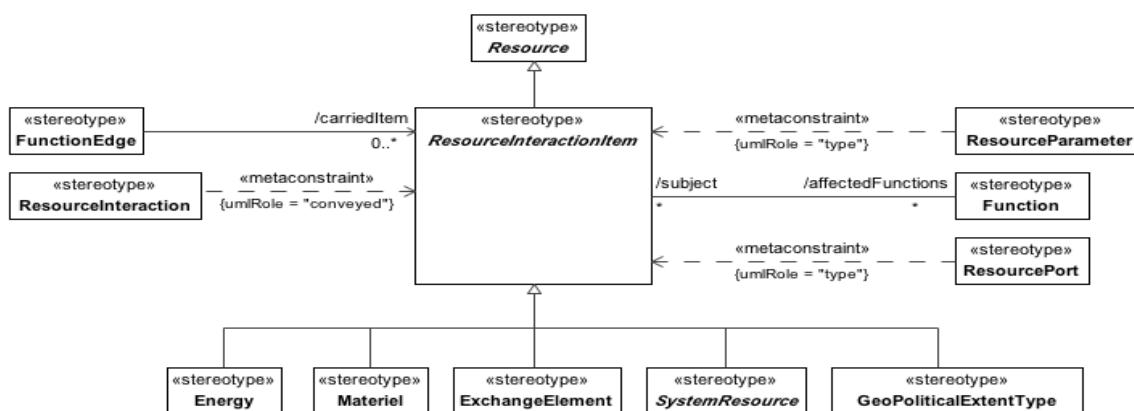

Figure 8.127 - ResourceInteractionItem

Attribute

The following are attributes for ResourceInteractionItem:

- affectedFunctions : Function[*] - The Functions affected by the ResourceInteractionItem.

Generalizations

The following are generalization relationships for ResourceInteractionItem:

- Resource

8.3.1.3.6.4 UPDM L1::UPDM L0::Core::SystemsElements::Structure

The Structure section of the SystemsElements profile.

8.3.1.3.6.4.1 CapabilityConfiguration

MODAF: A composite structure representing the physical and human resources (and their interactions) in an enterprise. A CapabilityConfiguration is a set of artefacts or an organization configured to provide a capability, and should be guided by [doctrine], which may take the form of Standard or OperationalConstraint stereotypes.

DoDAF: Any entity - human, automated, or any aggregation of human and/or automated - that performs an activity and provides a capability (Performer).

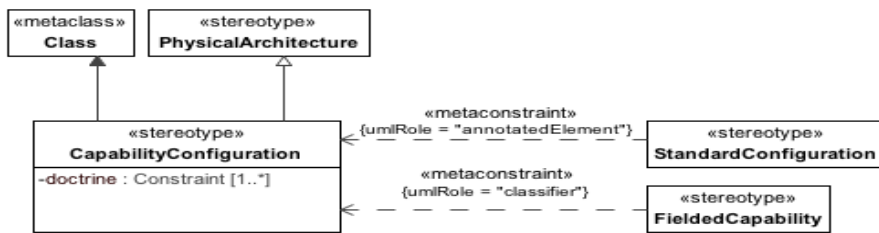

Figure 8.128 - CapabilityConfiguration

Attribute

The following are attributes for CapabilityConfiguration:

- doctrine : Constraint[1..*] - Represents the doctrinal line of development of the capability.

Extensions

The following are extensions for CapabilityConfiguration:

- Class

Generalizations

The following are generalization relationships for CapabilityConfiguration:

- PhysicalArchitecture

8.3.1.3.6.4.2 FieldedCapability

MODAF: An actual, fully-realized capability. A FieldedCapability must indicate its configuration CapabilityConfiguration.

DoDAF: NA

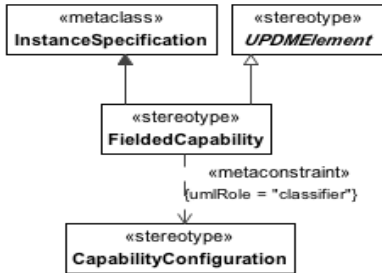

Figure 8.129 - FieldedCapability

Constraints

The following are constraints for FieldedCapability:

- FieldedCapability.classifier - Value for the classifier property must be stereotyped “CapabilityConfiguration” or its specializations.

Extensions

The following are extensions for FieldedCapability:

- InstanceSpecification

Generalizations

The following are generalization relationships for FieldedCapability:

- UPDMElement

8.3.1.3.6.4.3 Forecast

MODAF: A statement about the future state of one or more types of system or standard.

DoDAF: NA

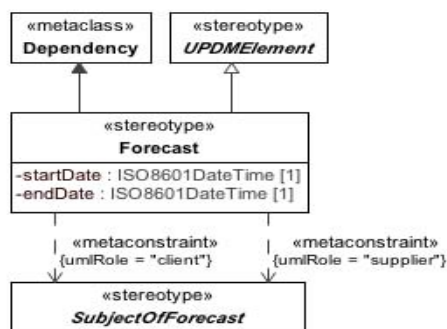

Figure 8.130 - Forecast

Constraints

The following are constraints for Forecast:

- Forecast.client - Value for the client property must be stereotyped “SubjectOfForecast” or its specializations.
- Forecast.pair - The client and supplier must be stereotyped by the same specialization of “SubjectOfForecast” (e.g., “Software” to “Software,” “Standard” to “Standard,” etc.).
- Forecast.supplier - Value for the supplier property must be stereotyped “SubjectOfForecast” or its specializations.

Attribute

The following are attributes for Forecast:

- endDate : ISO8601DateTime[1] - End date of the forecast.
- startDate : ISO8601DateTime[1] - Start date of the forecast.

Extensions

The following are extensions for Forecast:

- Dependency

Generalizations

The following are generalization relationships for Forecast:

- UPDMElement

8.3.1.3.6.4.4 PhysicalArchitecture

MODAF:A configuration of Resources for a purpose.

DoDAF:NA

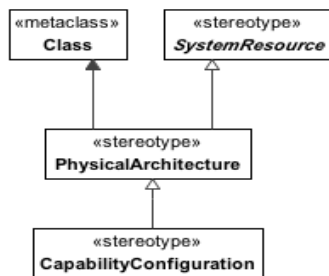

Figure 8.131 - PhysicalArchitecture

Extensions

The following are extensions for PhysicalArchitecture:

- DataType
- Class

Generalizations

The following are generalization relationships for PhysicalArchitecture:

- Resource

8.3.1.3.6.4.5 Resource

UPDM: Abstract supertype for physical resources such as OrganizationalResource.

MODAF: A PhysicalAsset, OrganizationalResource or FunctionalResource that can contribute towards fulfilling a capability (MODAF::ResourceType).

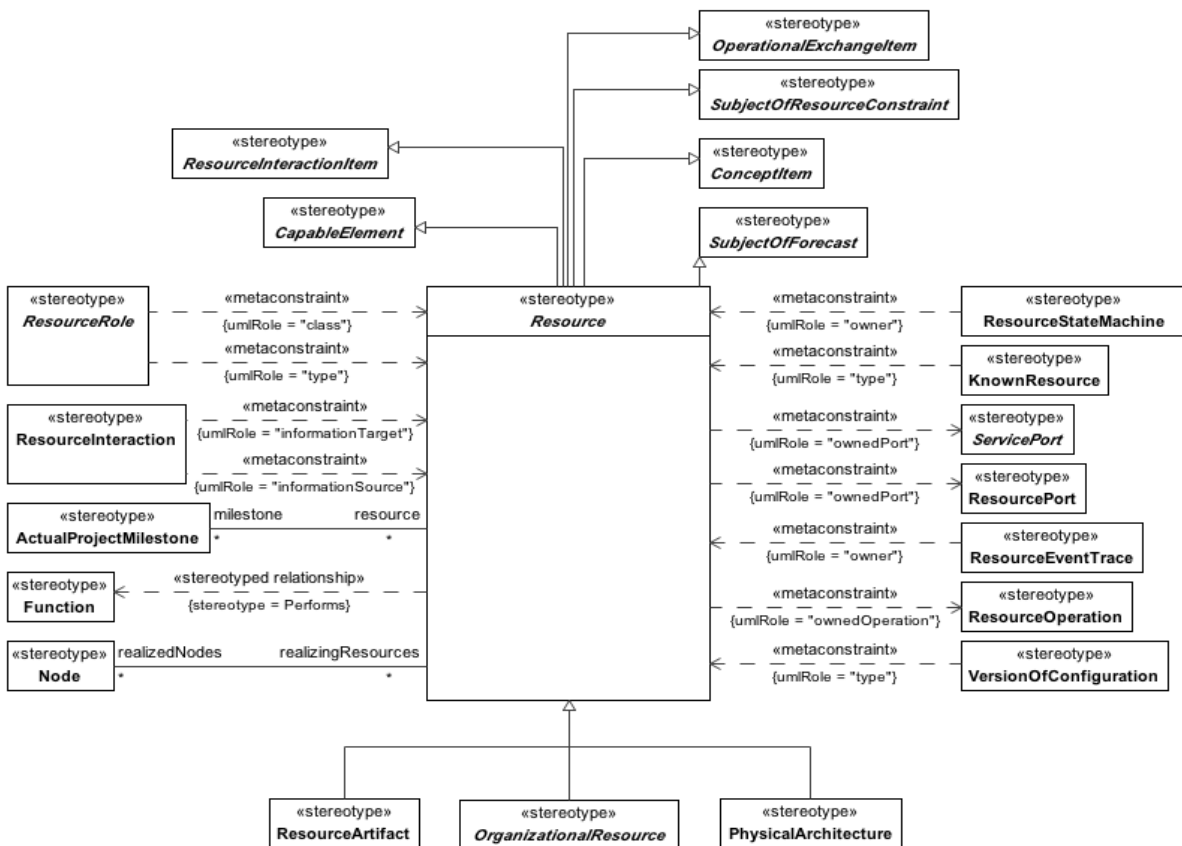

Figure 8.132 - Resource

Constraints

The following are constraints for Resource:

- Resource.ownedOperation - Values for the ownedOperation property must be stereotyped with “ResourceOperation” or its specializations.
- Resource.ownedPort - Values for the ownedPort property must be stereotyped with “ResourcePort”/“ServicePort” or its specializations.

- Resource.performs - Can perform only “Functions.”

Attribute

The following are attributes for Resource:

- milestone : ActualProjectMilestone[*] - A Linked milestone.
- realizedNodes : Node[*] -

Extensions

The following are extensions for Resource:

- Class

Generalizations

The following are generalization relationships for Resource:

- SubjectOfResourceConstraint
- SubjectOfForecast
- ResourceInteractionItem
- CapableElement
- ConceptItem
- UPDMElement
- OperationalExchangeItem

8.3.1.3.6.4.6 ResourceArtifact

UPDM: A combination of physical element, energy, and data that are combined used to accomplish a task or function.

MODAF: A type of man-made object. Examples are “car,” “radio,” “fuel,” etc. (MODAF:: Artefact).

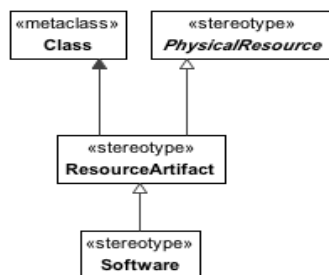

Figure 8.133 - ResourceArtifact

Extensions

The following are extensions for ResourceArtifact:

- Class

Generalizations

The following are generalization relationships for ResourceArtifact:

- PhysicalResource

8.3.1.3.6.4.7 ResourceConnector

UPDM: A physical connection between two resources that implements protocols through which the source resource can transmit items to the destination resource.

MODAF: Asserts that a connection exists between two ports belonging to parts in a system composite structure model (MODAF::SystemPortConnector).

DoDAF: NA

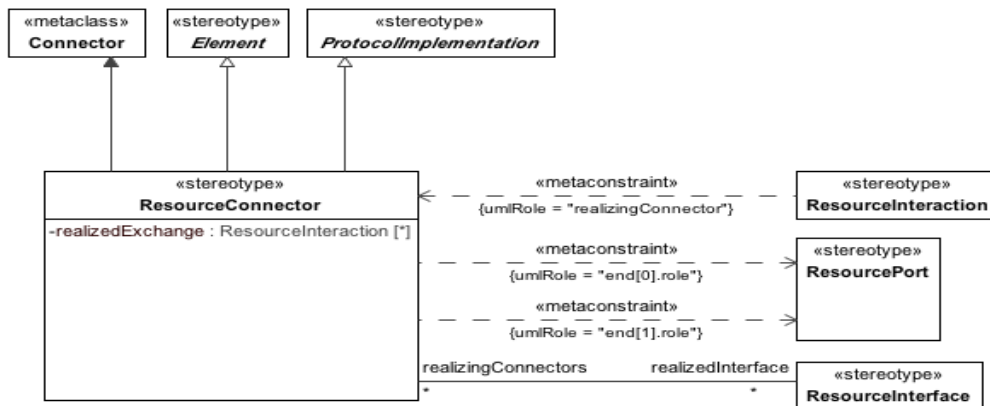

Figure 8.134 - ResourceConnector

Constraints

The following are constraints for ResourceConnector:

- ResourceConnector.end - The value for the role property for the owned ConnectorEnd must be stereotype “ResourcePort” or its specializations.

Attribute

The following are attributes for ResourceConnector:

- realizedExchange : ResourceInteraction[*] - A list of ResourceInteractions (or specializations) that realized by the ResourceInterface/ResourceConnector. This is derived by navigating from the ResourceInteraction to the ResourceInterfaces/ResourceConnectors using the inverse of the realization/realizingConnector roles.
- realizedInterface : ResourceInterface[*] - Realized ResourceInterfaces.

Extensions

The following are extensions for ResourceConnector:

- Connector

Generalizations

The following are generalization relationships for ResourceConnector:

- ProtocolImplementation
- UPDMElement

8.3.1.3.6.4.8 ResourceConstraint

MODAF: A rule governing the structural or functional aspects of an implementation - this may also include constraints on OrganizationalResources that are part of an implementation.

DoDAF: The range of permissible states for an object (DoDAF::Constraint).

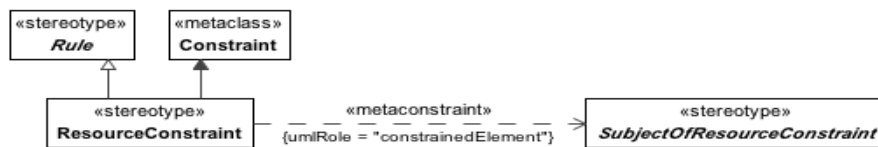

Figure 8.135 - ResourceConstraint

Constraints

The following are constraints for ResourceConstraint:

- ResourceConstraint.constrainedElement - Value for the constrainedElement property must be stereotyped “SubjectOfResourceConstraint” or its specializations.

Extensions

The following are extensions for ResourceConstraint:

- Constraint

Generalizations

The following are generalization relationships for ResourceConstraint:

- Rule

8.3.1.3.6.4.9 ResourceInterface

UPDM: ResourceInterface is a contractual agreement between two resources that implement protocols through which the source resource to the destination resource.

MODAF: NA

DoDAF: An overlap between Performers for the purpose of producing a Resource that is consumed by the other (DoDAF:: Interface).

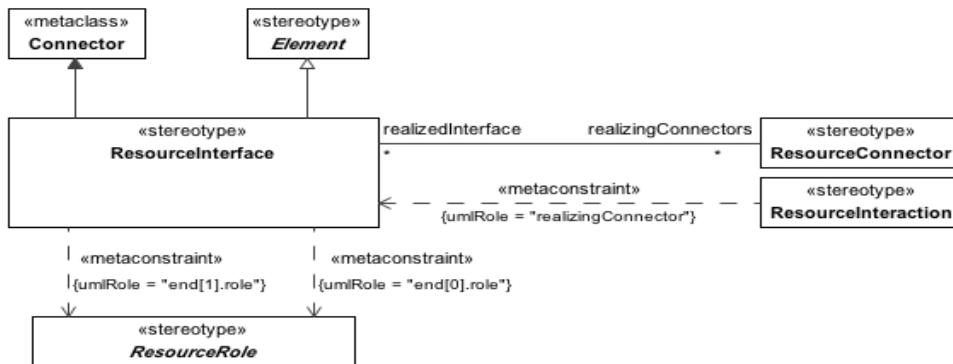

Figure 8.136 - ResourceInterface

Constraints

The following are constraints for ResourceInterface:

- ResourceInterface.end - the value for the role property for the owned ConnectorEnd must be stereotype “ResourceRole” or its specializations.

Attribute

The following are attributes for ResourceInterface:

- realizingConnectors : ResourceConnector[*] - Realizing ResourceConnectors.

Extensions

The following are extensions for ResourceInterface:

- Connector

Generalizations

The following are generalization relationships for ResourceInterface:

- UPDMElement

8.3.1.3.6.4.10 ResourcePort

UPDM: Port is an interaction point for a resource through which it can interact with the outside environment.

MODAF: An interface (logical or physical) provided by a System. A SystemPort may implement a PortType though there is no requirement for SystemPorts to be typed (MODAF:: SystemPort).

DoDAF: An interface (logical or physical) provided by a System (DoDAF::Port).

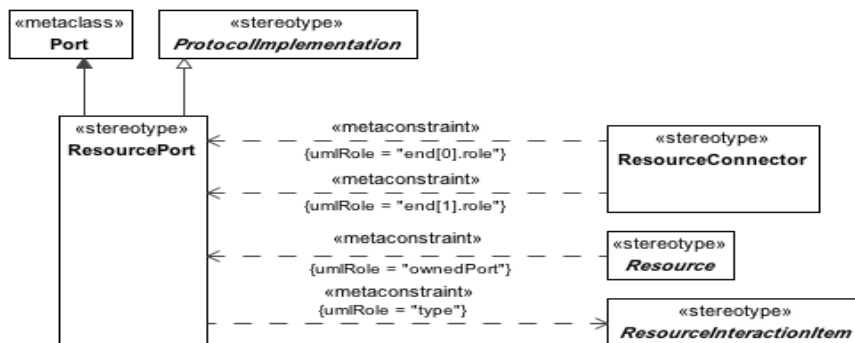

Figure 8.137 - ResourcePort

Constraints

The following are constraints for ResourcePort:

- ResourcePort.type - Value for the type property must be stereotyped “ResourceInteractionItem” or its specializations.

Extensions

The following are extensions for ResourcePort:

- Port

Generalizations

The following are generalization relationships for ResourcePort:

- ProtocolImplementation

8.3.1.3.6.4.11 ResourceRole

UPDM: abstract element.

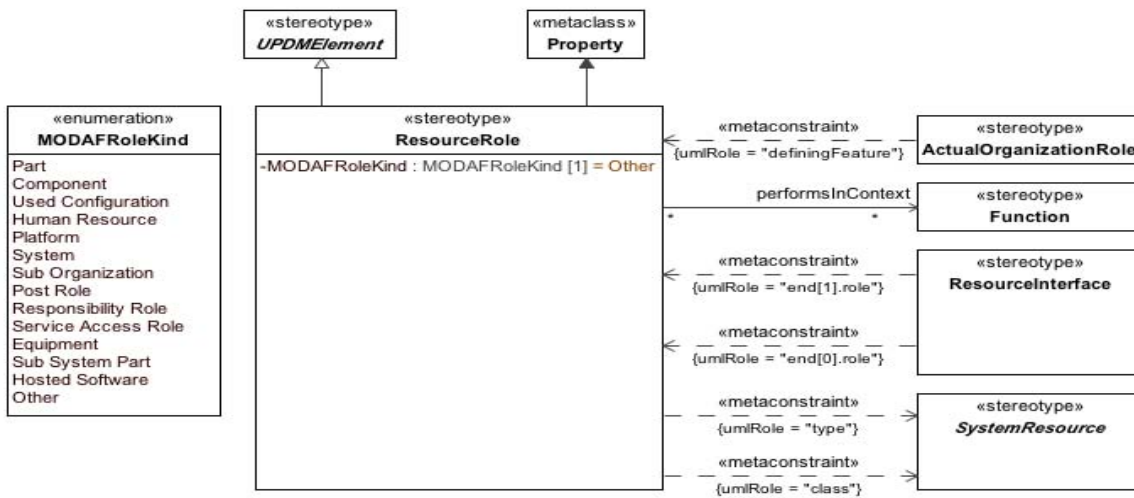

Figure 8.138 - ResourceRole

Constraints

The following are constraints for ResourceRole:

- ResourceRole.type - An element with the stereotype “ResourceRole” applied must have the “Resource” stereotype (or its specializations) applied to the targets of its extended metaclass property “type.”
- ResourceRole.class - Value for the class property must be stereotyped “Resource” or its specializations.

Attribute

The following are attributes for ResourceRole:

- performsInContext : Function[*] - Functions used by the ResourceRole.

Generalizations

The following are generalization relationships for ResourceRole:

- UPDMElement

8.3.1.3.6.4.12 Software

MODAF: An executable computer programme.

DoDAF: Materiel: Equipment, apparatus, or supplies that are of interest, without distinction as to its application for administrative or combat purposes.

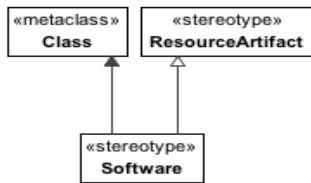

Figure 8.139 - Software

Extensions

The following are extensions for Software:

- Class

Generalizations

The following are generalization relationships for Software:

- ResourceArtifact

8.3.1.3.6.4.13 SubjectOfForecast

MODAF: Abstract Any element that may be subject to a Forecast.

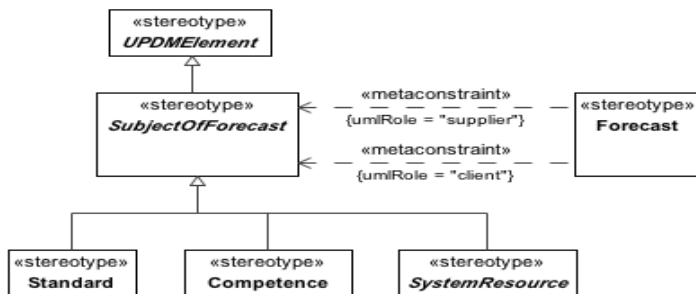

Figure 8.140 - SubjectOfForecast

Generalizations

The following are generalization relationships for SubjectOfForecast:

- UPDMElement

8.3.1.3.6.4.14 SubjectOfResourceConstraint

MODAF: Abstract. Anything that may be constrained by a ResourceConstraint.

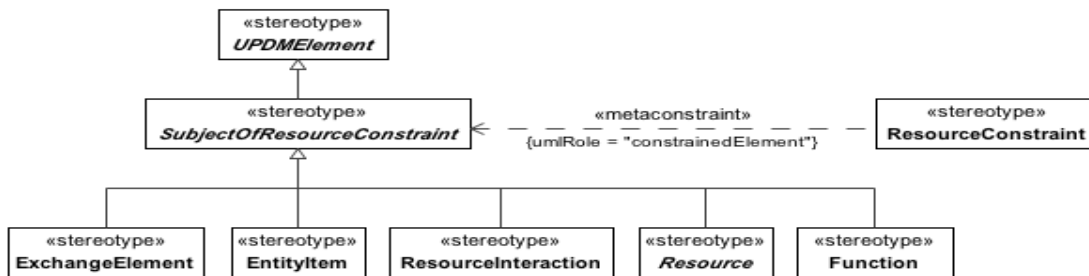

Figure 8.141 - SubjectOfResourceConstraint

Generalizations

The following are generalization relationships for SubjectOfResourceConstraint:

- UPDMElement

8.3.1.3.6.4.15 VersionOfConfiguration

MODAF: Asserts that a CapabilityConfiguration is a version of a WholeLifeConfiguration.

DoDAF: NA

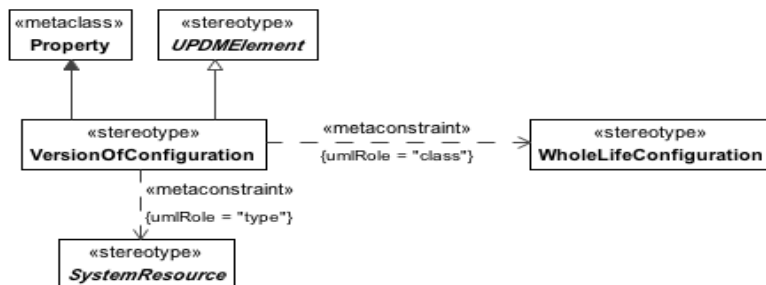

Figure 8.142 - VersionOfConfiguration

Constraints

The following are constraints for VersionOfConfiguration:

- VersionOfConfiguration.class - Value for the class property must be stereotyped “WholeLifeConfiguration” or its specializations.
- VersionOfConfiguration.type - Value for the type property must be stereotyped “Resource” or its specializations.

Extensions

The following are extensions for VersionOfConfiguration:

- Property

Generalizations

The following are generalization relationships for VersionOfConfiguration:

- UPDMElement

8.3.1.3.6.4.16 WholeLifeConfiguration

MODAF: A set of versions of a CapabilityConfiguration over time.

DoDAF: NA

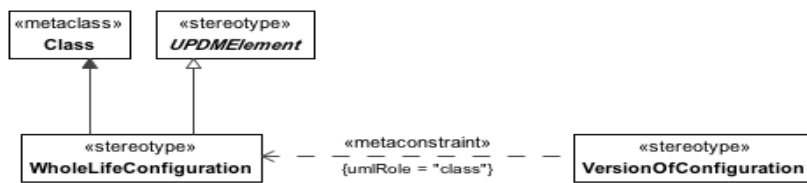

Figure 8.143 - WholeLifeConfiguration

Extensions

The following are extensions for WholeLifeConfiguration:

- Class

Generalizations

The following are generalization relationships for WholeLifeConfiguration:

- UPDMElement

8.3.1.3.6.4.17 SystemResource

UPDM: Abstract element used as placeholder for resource properties.

Note: SystemResource is abstract.

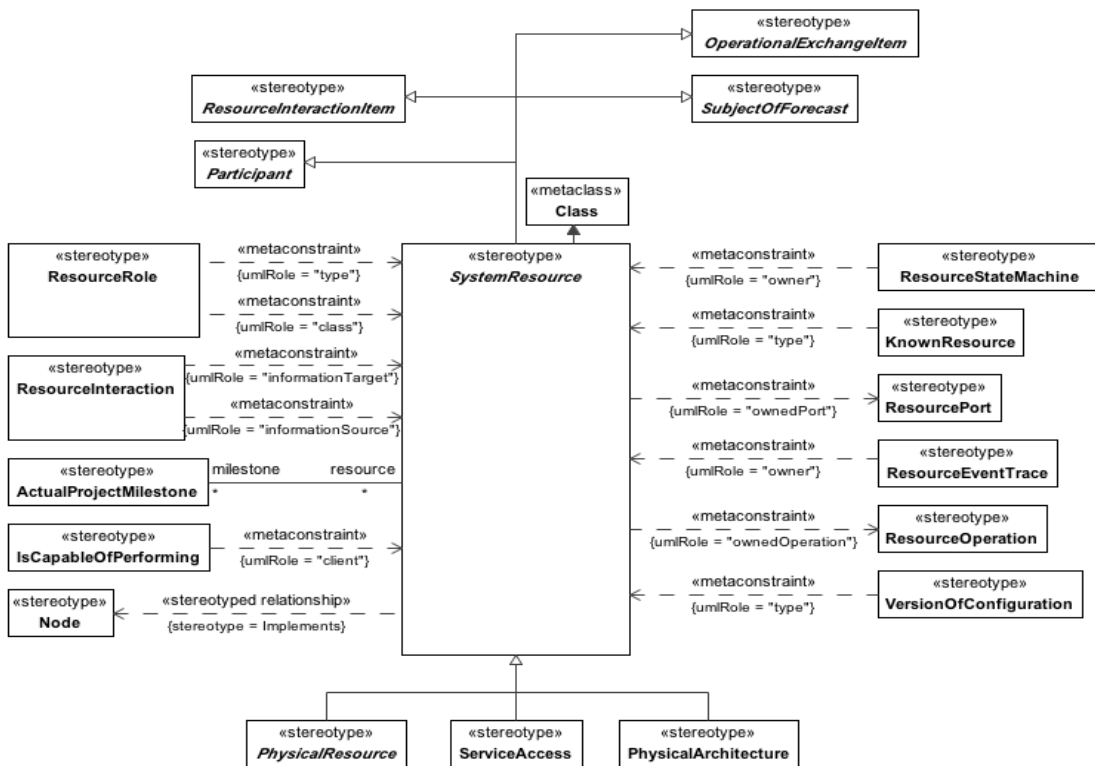

Figure 8.144 - SystemResource

Constraints

The following are constraints for SystemResource:

- Resource.ownedOperation - Values for the ownedOperation property must be stereotyped with “ResourceOperation” or its specializations.
- Resource.ownedPort - Values for the ownedPort property must be stereotyped with “ServicePort” or its specializations.
- Resource.performs - Can perform only “Functions.”

Extensions

The following metaclasses are extended by SystemResource:

- Class

Specializations

The SystemResource element is a specialization of:

- Participant
- ResourceInteractionItem
- SubjectOfForecast

- OperationalExchangeItem

8.3.1.3.6.4.18 Materiel

MODAF: Artifact, A type of man-made object. Examples are “car,” “radio,” “diesel,” etc.

DoDAF: Equipment, apparatus or supplies that are of interest, without distinction as to its application for administrative or combat purposes.

- Extensions

The following metaclasses are extended by Materiel:

- Class

Specializations

The Materiel element is a specialization of:

- ResourceInteractionItem

8.3.1.3.6.4.19 MODAFRoleKind

Enumeration of the roles that a ResourceRole may play in the context of a CapabilityConfiguration or System, derived from MODAF, used to support the MODAFRoleKind tag of a ResourceRole.

Enumeration Literals

The following are enumeration literals for MODAFRoleKind:

Component - (MODAF SoftwareComponent) Asserts that Software is a component of another Software.

Equipment - UPDM: Equipment is a physical resource that is used to accomplish a task or function in a system or an environment.

MODAF: (MODAF::PhysicalAsset): Usage of an ResourceArtifact (MODAF::Artefact) as a component of a ResourceConfiguration.

DoDAF: NA

Hosted Software - Asserts that Software is hosted on a ResourceArtifact (which means the artifact is some kind of computer system).

Human Resource - The role of an OrganizationalResource in a PhysicalArchitecture.

Other - Other MODAF Role kind that is not on the enumerated list.

Part - Usage of a ResourceArtifact as a part of another ResourceArtifact.

Platform - Usage of a ResourceArtifact as a platform (e.g., vessel, aircraft, etc.) in a particular PhysicalArchitecture.

Post Role - (MODAF Post) Asserts that a Post exists in an OrganizationType of the type specified by the related PostType.

Responsibility Role - (MODAF Role) A ResourceUsage that asserts a given PostType has a RoleType.

Service Access Role - A ResourceUsage that asserts a given ServiceAccess is used in the context of a particular service usage.

Sub Organization - Asserts that one OrganizationType is typically the parent of another (e.g., a squadron may be part of a battalion).

Sub System Part - UPDM: Indicates that a (sub)system is part of another system.

MODAF: Usage of an Artefact (UPDM::ResourceArtifact) as a part of another Artefact (UPDM::ResourceArtifact), equates to a MODAF::Part.

DoDAF: NA

System - The usage of a ResourceArtifact as a System in a PhysicalArchitecture.

Used Configuration - The usage of a PhysicalArchitecture in another PhysicalArchitecture.

8.3.1.3.7 UPDM L1::UPDM L0::Core::TechnicalStandardsElements

Section 1.4.4 of the DoDAF version 1.5 Definitions and Guidelines (Volume I): Define the purpose of the Technical View as follows:

“The TV is the minimal set of rules governing the arrangement, interaction, and interdependence of system parts or elements. Its purpose is to ensure that a system satisfies a specified set of operational requirements. The TV provides the technical systems implementation guidelines upon which engineering specifications are based, common building blocks are established, and product lines are developed. It includes a collection of the technical standards, implementation conventions, standards options, rules, and criteria that can be organized into profile(s) that govern systems and system or service elements for a given architecture.”

8.3.1.3.7.1 Protocol

MODAF: A Standard for communication. Protocols may be composite (i.e., a stack).

DoDAF: NA, See TechnicalStandard.

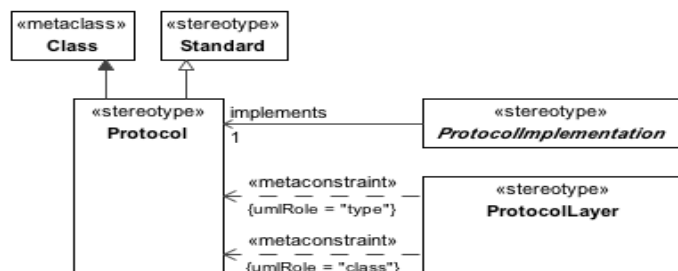

Figure 8.145 - Protocol

Extensions

The following are extensions for Protocol:

- Class

Generalizations

The following are generalization relationships for Protocol:

- Standard

8.3.1.3.7.2 ProtocolImplementation

UPDM: Abstract element: A connector that implements a specific Protocol.

MODAF: An element that can implement a Protocol.

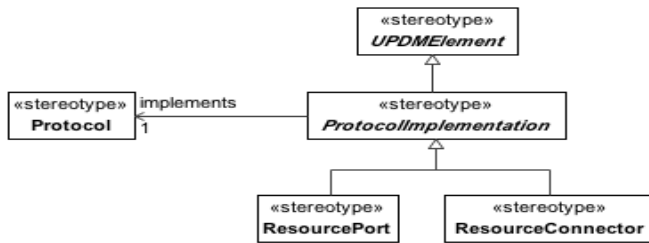

Figure 8.146 - ProtocolImplementation

Attribute

The following are attributes for ProtocolImplementation:

- implements : Protocol[1] - The <<Protocol>> that can be implemented by the Connector targets.

Generalizations

The following are generalization relationships for ProtocolImplementation:

- UPDMElement

8.3.1.3.7.3 Standard

MODAF: A ratified and peer-reviewed specification that is used to guide or constrain the architecture. A Standard may be applied to any element in the architecture via the [constrainedItem] property of UML::Constraint.

DoDAF: A formal agreement documenting generally accepted specifications or criteria for products, processes, procedures, policies, systems, and/or personnel.

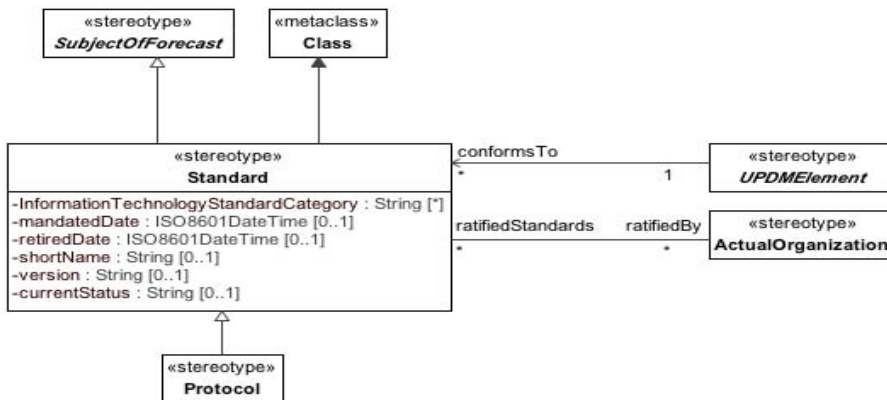

Figure 8.147 - Standard

Attribute

The following are attributes for Standard:

- `currentStatus` : `String[0..1]` - Current status of the Standard.
- `InformationTechnologyStandardCategory` : `String[*]` - The information technology standard category which the <<Standard>> belongs to.
- `mandatedDate` : `ISO8601DateTime[0..1]` - The date when this version of the Standard was published.
- `ratifiedBy` : `ActualOrganization[*]` - Organization that ratified this Standard.
- `retiredDate` : `ISO8601DateTime[0..1]` - The date when this version of the Standard was retired.
- `shortName` : `String[0..1]` - Short name of the Standard.
- `version` : `String[0..1]` - Represents the revision number of the Standard (e.g., “1.2.1,” “v2,” “:2004,” etc.).

Extensions

The following are extensions for Standard:

- Class

Generalizations

The following are generalization relationships for Standard:

- SubjectOfForecast

8.3.1.3.7.4 StandardConfiguration

MODAF: A UML::Comment that when attached to a CapabilityConfiguration indicates that it is a standard pattern for reuse in the architecture.

DoDAF: NA

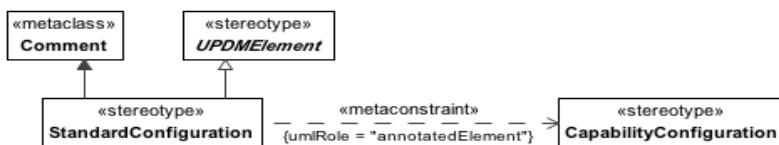

Figure 8.148 - StandardConfiguration

Constraints

The following are constraints for StandardConfiguration:

- `StandardConfiguration.annotatedElement` - Value for the `annotatedElement` property must be stereotyped “CapabilityConfiguration.”

Extensions

The following are extensions for StandardConfiguration:

- Comment

Generalizations

The following are generalization relationships for StandardConfiguration:

- UPDMElement

8.3.1.3.7.5 UPDM L1::UPDM L0::Core::TechnicalStandardsElements::Data

The data portion of the AllElements profile.

8.3.1.3.7.5.1 EntityAttribute

MODAF: A defined property of an EntityItem.

DoDAF: NA

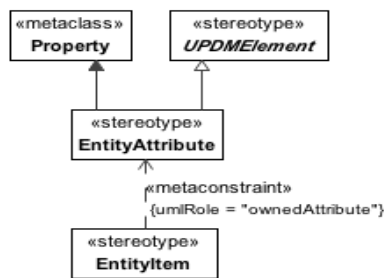

Figure 8.149 - EntityAttribute

Constraints

The following are constraints for EntityAttribute:

- Details.client - Value for the client property must be stereotyped a specialization of “EntityItem.”
- Details.supplier - Value for the supplier property must be stereotyped “ExchangeElement.”

Extensions

The following are extensions for EntityAttribute:

- Dependency

Generalizations

The following are generalization relationships for EntityAttribute:

- UPDMElement

8.3.1.3.7.5.2 EntityItem

MODAF: (MODAF::Entity): A definition (type) of an item of interest.

DoDAF: NA

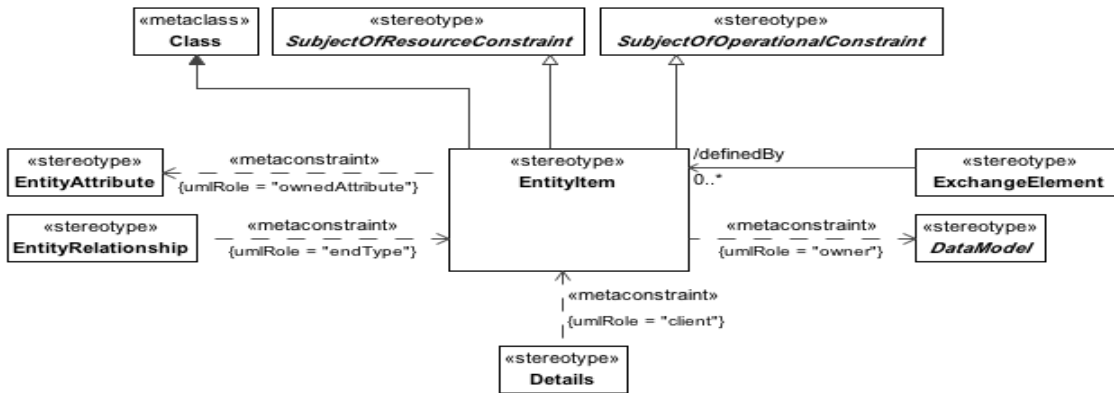

Figure 8.150 - EntityItem

Constraints

The following are constraints for EntityItem:

- EntityItem.ownedAttribute - Value for the slot property must be stereotyped “EntityAttribute” or its specializations.

Extensions

The following are extensions for EntityItem:

- Class

Generalizations

The following are generalization relationships for EntityItem:

- SubjectOfOperationalConstraint

8.3.1.3.7.5.3 EntityRelationship

MODAF: Asserts that there is a relationship between two EntityItems.

DoDAF: (DoDAF::DataAssociation): A relationship or association between two elements of proceduralized information.

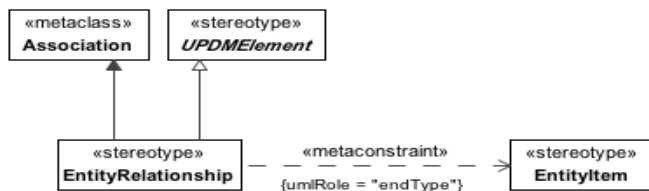

Figure 8.151 - EntityRelationship

Constraints

The following are constraints for EntityRelationship:

- EntityRelationship.endType - Values for the endType property must be stereotyped “EntityItem” or its specializations.

Extensions

The following are extensions for EntityRelationship:

- Association

Generalizations

The following are generalization relationships for EntityRelationship:

- UPDMElement

8.3.1.4 UPDM L1::UPDM L0::DoDAF

Elements that are not considered part of the Core architectural model, but necessary for DoDAF.

8.3.1.4.1 UPDM L1::UPDM L0::DoDAF::AcquisitionElements

This section of the specification contains the Acquisition elements of the DoDAF section.

8.3.1.4.1.1 Project

DoDAF: A temporary endeavor undertaken to create Resources or Desired Effects.



Figure 8.152 - Project

Extensions

The following are extensions for Project:

- InstanceSpecification

Generalizations

The following are generalization relationships for Project:

- ActualProject

8.3.1.4.1.2 ProjectActivity

MOAF: NA

DoDAF: An activity carried out during a project.

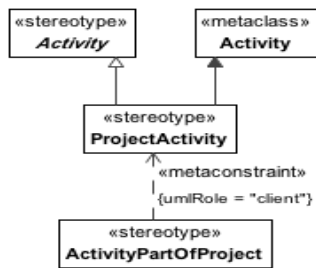

Figure 8.153 - ProjectActivity

Extensions

The following are extensions for ProjectActivity:

- Activity

Generalizations

The following are generalization relationships for ProjectActivity:

- Activity

8.3.1.4.1.3 ActivityPartOfProject

UPDM: As in DoDAF

DoDAF: A wholePart relationship between a Project and an Activity (Task) that is part of the Project.

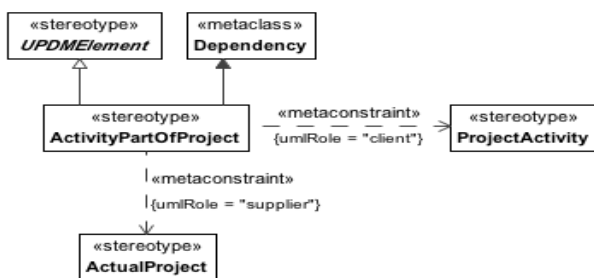

Figure 8.154 - ActivityPartOfProject

Constraints

The following are constraints for ActivityPartOfProject:

- ActivityPartOfProject.client - Value for the client property must be stereotyped a specialization of “ProjectActivity.”
- ActivityPartOfProject.supplier - Value for the supplier property must be stereotyped “ActualProject.”

Extensions

The following metaclasses are extended by ActivityPartOfProject:

- Dependency

Specializations

The ActivityPartOfProject element is a specialization of:

- UPDMElement

8.3.1.4.2 UPDM L1::UPDM L0::DoDAF::AllElements

The All View elements for DoDAF specific models. The All View elements provide information about the entire Architecture. They are used for support rather than architectural models.

8.3.1.4.2.1 Information

UPDM:As DoDAF

MODAF:N/A

DoDAF:Information is the state of a something of interest that is materialized, in any medium or form, and communicated or received.

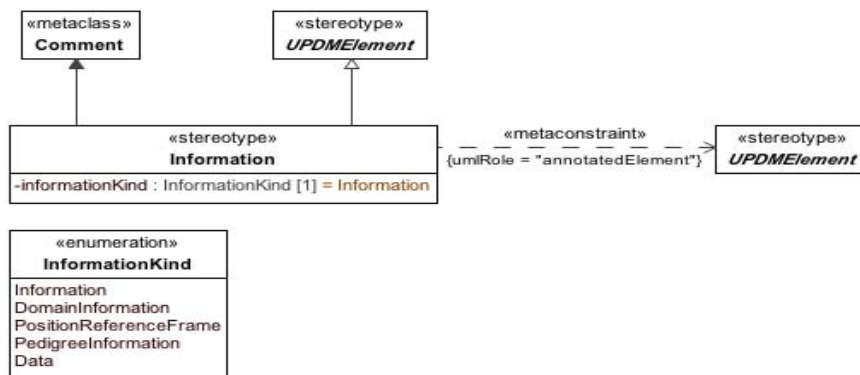

Figure 8.155 - Information

Constraints

The following are constraints for Information:

- Information.annotatedElement - Value for the annotatedElement property must be stereotyped “UPDMElement” or its specializations.

Extensions

The following metaclasses are extended by Information:

- Comment

Specializations

The Information element is a specialization of:

- UPDMElement

8.3.1.4.2.2 InformationKind

Enumeration of kinds of information, derived from MODAF and DoDAF, used to support the InformationKind tag of the Information stereotype.

Enumeration Literals

The following are enumeration literals for InformationKind:

- Data - Representation of information in a formalized manner suitable for communication, interpretation, or processing by humans or by automatic means. Examples could be whole models, packages, entities, attributes, classes, domain values, enumeration values, records, tables, rows, columns, and fields.
- DomainInformation - Types of information within the scope or domain of the architecture.
- Information - Information is the state of a something of interest that is materialized -- in any medium or form -- and communicated or received.
- PedigreeInformation - Information describing pedigree.
- PositionReferenceFrame - An arbitrary set of axes with reference to which the position or motion of something is described or physical laws are formulated.

8.3.1.4.2.3 UPDM L1::UPDM L0::DoDAF::AllElements::Behavior

This section of the specification contains the Behavior Elements of the DoDAF, All Elements section.

8.3.1.4.2.3.1 ActivityPerformedByPerformer

UPDM: Links a Performer to the behavior that it can perform

MODAF: NA

DoDAF: An overlap of an Activity with a Resource, in particular a consuming or producing Activity that expresses an input, output, consumption, or production Activity of the Resource.



Figure 8.156 - ActivityPerformedByPerformer

Extensions

The following are extensions for ActivityPerformedByPerformer:

- Dependency

Generalizations

The following are generalization relationships for ActivityPerformedByPerformer:

- IsCapableOfPerforming

8.3.1.4.2.4 UPDM L1::UPDM L0::DoDAF::AllElements::Environment

This section of the specification contains the Environmental Elements of the DoDAF, All Elements section.

8.3.1.4.2.4.1 Condition

MODAF: A definition of the conditions in which something exists or functions. An Environment may be specified in terms of LocationType (e.g., terrain), Climate (e.g., tropical), and LightCondition (e.g., dark, light, dusk, etc.)

DoDAF: An object that encompasses meteorological, geographic, and control features mission significance.

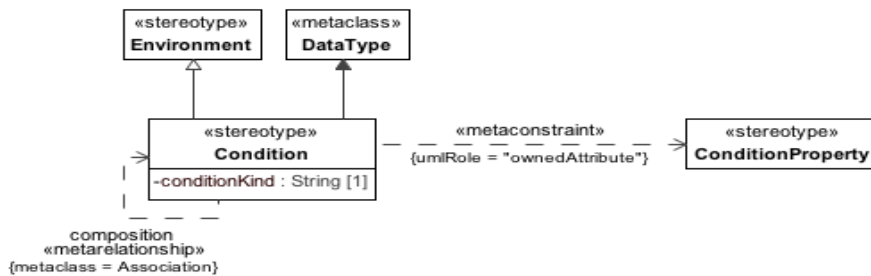

Figure 8.157 - Condition

Constraints

The following are constraints for Condition:

- Condition.ownedAttribute - Values for the ownedAttribute property must be stereotyped “ConditionProperty” or its specializations.

Attribute

The following are attributes for Condition:

- conditionKind : String[1] -

Extensions

The following are extensions for Condition:

- DataType

Generalizations

The following are generalization relationships for Condition:

- Environment

8.3.1.4.2.4.2 ConditionProperty

MODAF: EnvironmentalProperty: Asserts that an Environment has one or more properties. These may be Climate, LocationType, or LightCondition.

DoDAF: NA

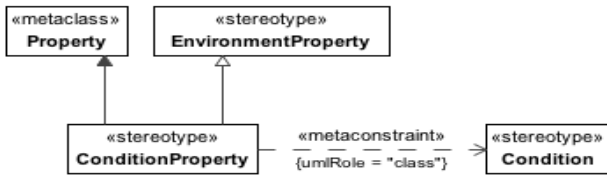

Figure 8.158 - ConditionProperty

Constraints

The following are constraints for ConditionProperty:

- ConditionProperty.class - Value for the class property must be stereotyped “Condition” or its specializations.
- ConditionProperty.type - Value for the type property must be stereotyped “Location” or its specializations.

Extensions

The following are extensions for ConditionProperty:

- Property

Generalizations

The following are generalization relationships for ConditionProperty:

- EnvironmentProperty

8.3.1.4.2.4.3 GeoPoliticalExtent

MODAF:NA

DoDAF:NA

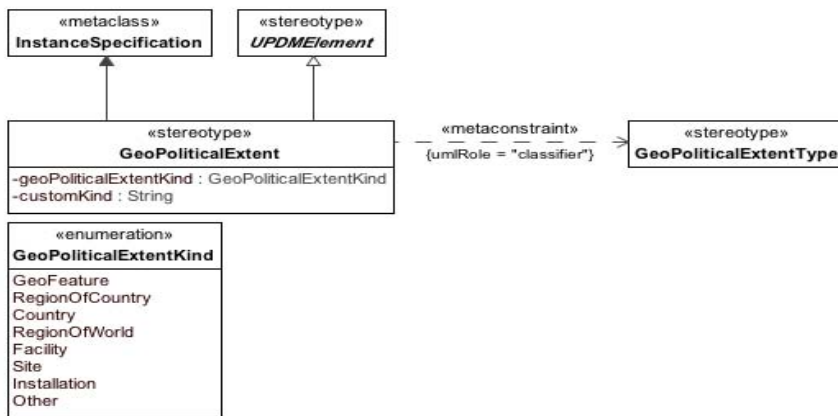

Figure 8.159 - GeoPoliticalExtent

Attribute

The following are attributes for GeoPoliticalExtent:

- geoPoliticalExtentKind : GeoPoliticalExtentKind[] -

Extensions

The following are extensions for GeoPoliticalExtent:

- InstanceSpecificationGeneralizations

The following are generalization relationships for GeoPoliticalExtent:

- UPDMElement

8.3.1.4.2.4.4 Location

DoDAF: All subtypes of << IndividualType >> Location, such as Facility, Site, etc.

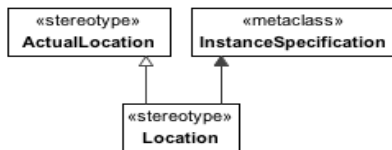

Figure 8.160 - Location

Extensions

The following are extensions for Location:

- InstanceSpecification

Generalizations

The following are generalization relationships for Location:

- ActualLocation

8.3.1.4.2.4.5 LocationType

MODAF: A general specification of the surroundings / scenario in which an operation may take place. Examples would be: “desert,” “arctic,” “at sea,” etc.

DoDAF: A point or extent in space that may be referred to physically or logically. Includes concepts such as: Facility, Installation, RealProperty, Site, and instances of conditions such as underwater (as specified in UJTLs).

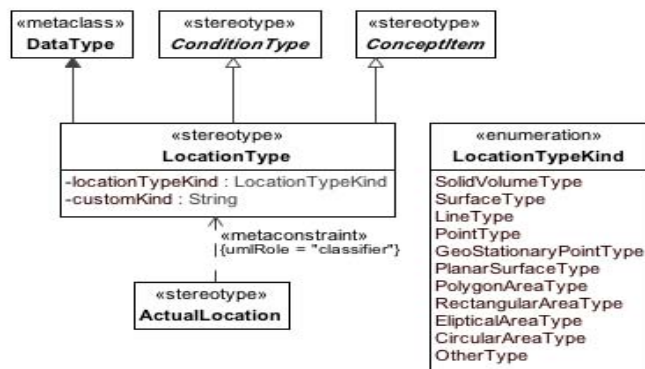

Figure 8.161 - LocationType

Extensions

The following are extensions for LocationType:

- DataType

Generalizations

The following are generalization relationships for LocationType:

- ConceptItem
- ConditionType

8.3.1.4.2.4.6 GeoPoliticalExtentKind

Enumeration of geopolitical extent kinds, used to support the geoPoliticalExtentKind tag of the geoPoliticalExtent stereotype, derived from DoDAF.

Enumeration Literals

The following are enumeration literals for GeoPoliticalExtentKind:

- Country - A political state or nation or its territory.
- Facility - A real property entity consisting of underlying land and one or more of the following: a building, a structure (including linear structures), a utility system, or pavement.
- GeoFeature - An object that encompasses meteorological, geographic, and control features mission significance.
- Installation - A base, camp, post, station, yard, center, or other activity, including leased facilities, without regard to the duration of operational control. An installation may include one or more sites.
- Other - Other GeoPoliticalExtent kind that is not on the enumerated list.
- RegionOfCountry - A large, usually continuous segment of a political state or nation or its territory.
- RegionOfWorld - A large, usually continuous segment of a surface or space; area.

- Site - Physical (geographic) location that is or was owned by, leased to, or otherwise possessed. Each site is assigned to a single installation. A site may exist in one of three forms: (1) Land only, where there are no facilities present and where the land consists of either a single land parcel or two or more contiguous land parcels. (2) Facility or facilities only, where the underlying land is neither owned nor controlled by the government. A stand-alone facility can be a site. If a facility is not a stand-alone facility, it must be assigned to a site. (3). Land and all the facilities thereon, where the land consists of either a single land parcel or two or more contiguous land parcels.

8.3.1.4.2.4.7 GeoPoliticalExtentType

MODAF:NA

DoDAF:A geospatial extent whose boundaries are by declaration or agreement by political parties.

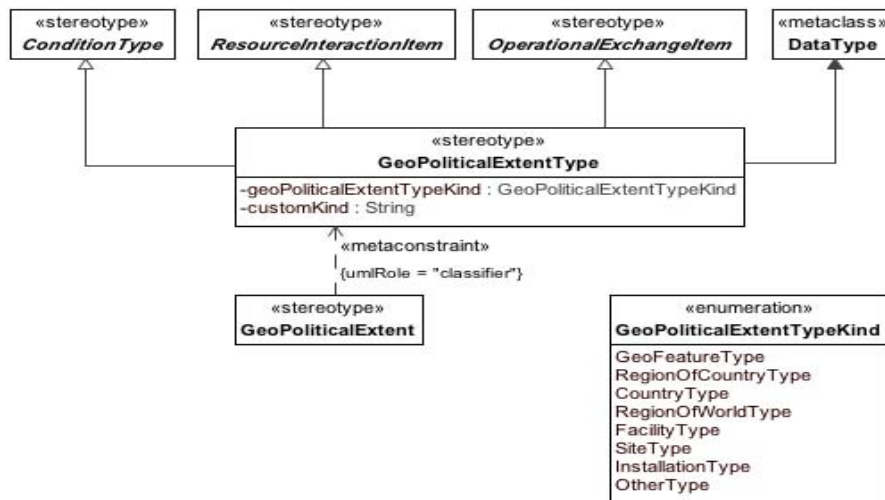

Figure 8.162 - GeoPoliticalExtentType

Extensions

The following metaclasses are extended by GeoPoliticalExtentType:

- DataType

Specializations

The GeoPoliticalExtentType element is a specialization of:

- ResourceInteractionItem
- OperationalExchangeItem
- ConditionType

8.3.1.4.2.5 UPDM L1::UPDM L0::DoDAF::AllElements::Measurements

This section of the specification contains the Measurement Elements of the DoDAF, All Elements section.

8.3.1.4.2.5.1 Measure

MODAF:NA

DoDAF:The magnitude of some attribute of an individual.

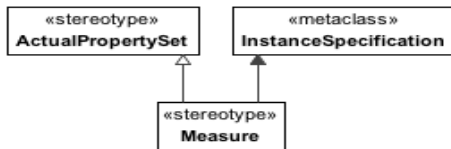

Figure 8.163 - Measure

Extensions

The following are extensions for Measure:

- InstanceSpecification

Generalizations

The following are generalization relationships for Measure:

- ActualPropertySet

8.3.1.4.2.5.2 MeasureType

MODAF:NA

DoDAF: A category of Measures.

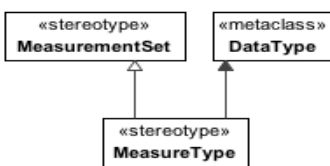

Figure 8.164 - MeasureType

Extensions

The following are extensions for MeasureType:

- Property

Generalizations

The following are generalization relationships for MeasureType:

- Measurement

8.3.1.4.3 UPDM L1::UPDM L0::DoDAF::OperationalElements

The Operational View elements for DoDAF specific models.

8.3.1.4.3.1 UPDM L1::UPDM L0::DoDAF::OperationalElements::Structure

Section of the OperationalElements profile that describe structural concepts for DoDAF.

8.3.1.4.3.1.1 Performer

MODAF:NA

DoDAF:Any entity - human, automated, or any aggregation of human and/or automated - that performs an activity and provides a capability. An alias for Node in DoDAF.

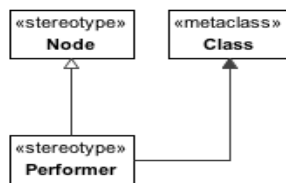

Figure 8.165 - Performer

Extensions

The following are extensions for Performer:

- Class

Generalizations

The following are generalization relationships for Performer:

- Node

8.3.1.4.3.1.2 UPDM L1::UPDM L0::DoDAF::OperationalElements::Structure::Organizational

This section of the specification contains the organizational Elements of the DoDAF, Operational Elements section.

8.3.1.4.3.1.2.1 IndividualPerson

UPDM: An individual person.

MODAF:NA

DoDAF: An Individual person.

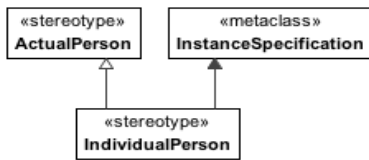

Figure 8.166 - IndividualPerson

Extensions

The following are extensions for IndividualPerson:

- InstanceSpecification

Generalizations

The following are generalization relationships for IndividualPerson:

- ActualPerson

8.3.1.4.3.1.2.2 Organization

DoDAF: A specific real-world assemblage of people and other resources organized for an on-going purpose.

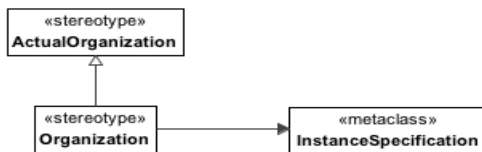

Figure 8.167 - Organization

Extensions

The following are extensions for Organization:

- InstanceSpecification

Generalizations

The following are generalization relationships for Organization:

- ActualOrganization

8.3.1.4.3.1.2.3 OrganizationType

DoDAF: A type of Organization.

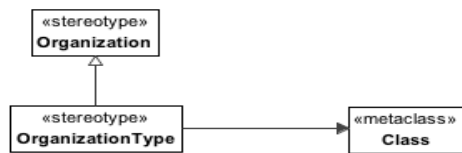

Figure 8.168 - OrganizationType

Extensions

The following are extensions for OrganizationType:

- Class

Generalizations

The following are generalization relationships for OrganizationType:

- Organization

8.3.1.4.3.1.2.4 PersonType

DoDAF: A category of persons defined by the role or roles they share that are relevant to an architecture (includes assigned materiel).

MODAF: NA

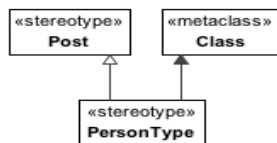

Figure 8.169 - PersonType

Extensions

The following are extensions for PersonType:

- Class

Generalizations

The following are generalization relationships for PersonType:

- Post

8.3.1.4.3.1.2.5 Skill

MODAF: A specific set of abilities defined by knowledge, skills and attitude (Competence).

DoDAF: The ability, coming from one's knowledge, practice, aptitude, etc., to do something well.

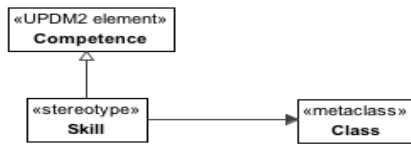

Figure 8.170 - Skill

Extensions

The following are extensions for Skill:

- Class

Generalizations

The following are generalization relationships for Skill:

- Competence

8.3.1.4.3.1.2.6 SkillOfPersonType

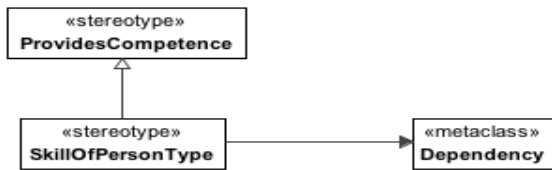

Figure 8.171 - SkillOfPersonType

Extensions

The following are extensions for SkillOfPersonType:

- Dependency

Generalizations

The following are generalization relationships for SkillOfPersonType:

- ProvidesCompetence

8.3.1.4.4 UPDM L1::UPDM L0::DoDAF::StrategicElements

This section of the specification contains the Strategic Elements of the DoDAF section.

8.3.1.4.4.1 ActivityPartOfCapability

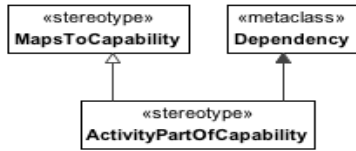

Figure 8.172 - ActivityPartOfCapability

Extensions

The following are extensions for ActivityPartOfCapability:

- Dependency

Generalizations

The following are generalization relationships for ActivityPartOfCapability:

- MapsToCapability

8.3.1.4.4.2 CapabilityOfPerformer

UPDM: A couple that represents the capability that a resource, node or enterprise phase exhibits (Exhibits).

MODAF: An assertion that a Node is required to have a Capability (Capability for node).

DoDAF: A couple that represents the capability that a performer has.

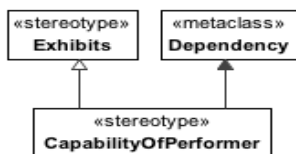

Figure 8.173 - CapabilityOfPerformer

Extensions

The following are extensions for CapabilityOfPerformer:

- Dependency

Generalizations

The following are generalization relationships for CapabilityOfPerformer:

- Exhibits

8.3.1.4.4.3 DesiredEffect

MODAF: NA

DoDAF:A desired state of a Resource.

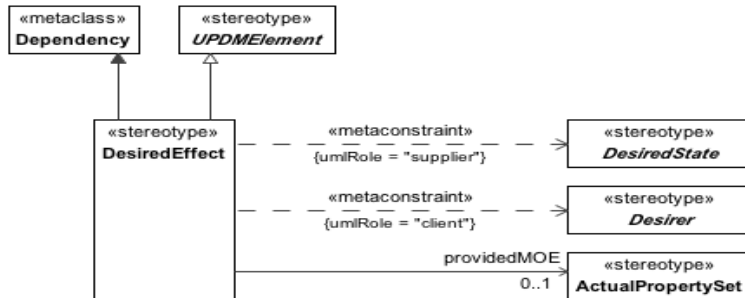

Figure 8.174 - DesiredEffect

Constraints

The following are constraints for DesiredEffect:

- DesiredEffect.client - Value for the client property must be stereotyped a specialization of “Desirer.”
- DesiredEffect.supplier - Value for the supplier property must be stereotyped a specialization of “DesiredState.”

Attribute

The following are attributes for DesiredEffect:

- desiredResourceFutureState : State[0..1] -
- providedMOE : ActualPropertySet[0..1] -
- realizesVision : EnterpriseVision[1] -

Extensions

The following are extensions for DesiredEffect:

- Dependency

Generalizations

The following are generalization relationships for DesiredEffect:

- UPDMElement

8.3.1.4.4.4 Vision

MODAF:The overall aims of an enterprise over a given period of time. (EnterpriseVision)

DoDAF:An end that describes the future state of the enterprise, without regard to how it is to be achieved; a mental image of what the future will or could be like.



Figure 8.175 - Vision

Extensions

The following are extensions for Vision:

- Class

Generalizations

The following are generalization relationships for Vision:

- EnterpriseVision

8.3.1.4.4.5 DesiredState

UPDM: Abstract element used to group Operational and Resource states.

Note: DesiredState is abstract.

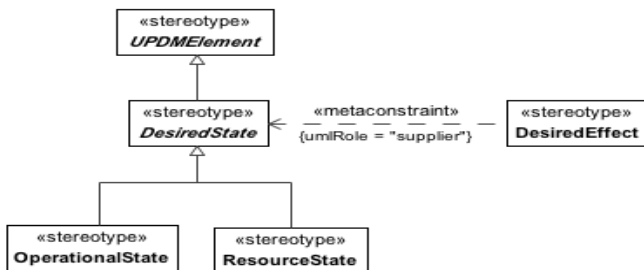

Figure 8.176 - DesiredState

Specializations

The DesiredState element is a specialization of:

- UPDMElement

8.3.1.4.4.6 Desirer

UPDM: Abstract element used to group UPDM elements that might desire a particular effect.

Note: Desirer is abstract.

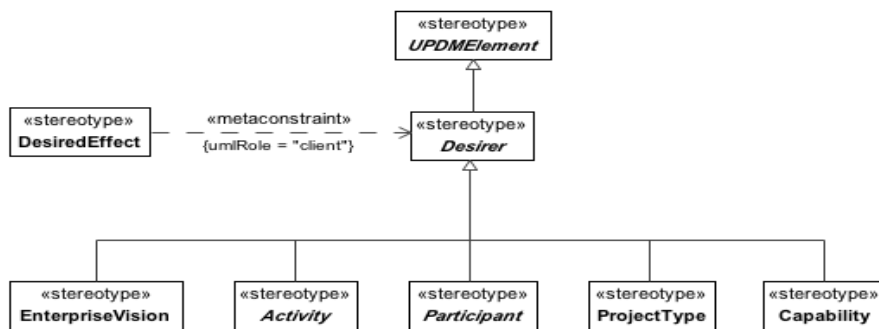

Figure 8.177 - Desirer

Specializations

The Desirer element is a specialization of:

- UPDMElement

8.3.1.4.5 UPDM L1::UPDM L0::DoDAF::SystemElements

The System View elements for DoDAF specific models.

8.3.1.4.5.1 UPDM L1::UPDM L0::DoDAF::SystemElements::Structure

Defines the structure parts of the system elements.

8.3.1.4.5.1.1 System

A DoDAF alias for ResourceArtifact.

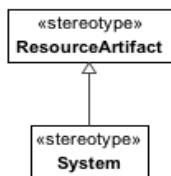

Figure 8.178 - System

Extensions

The following are extensions for System:

- Class

Generalizations

The following are generalization relationships for System:

- ResourceArtifact

8.3.1.4.5.1.2 SystemConnector

UPDM: A link between two systems.

MODAF: Asserts that a connection exists between two ports belonging to parts in a system composite structure model (MODAF:: SystemPortConnector).

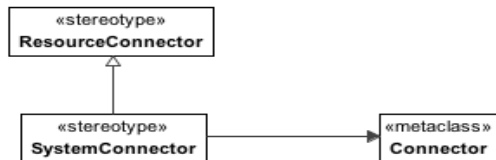

Figure 8.179 - SystemConnector

Extensions

The following are extensions for SystemConnector:

- Connector

Generalizations

The following are generalization relationships for SystemConnector:

- ResourceConnector

8.3.1.4.6 UPDM L1::UPDM L0::DoDAF::TechnicalStandardsElements

This section of the specification contains the Technical Standard Elements of the DoDAF section.

8.3.1.4.6.1 FunctionalStandard

MODAF:NA

DoDAF:Functional standards set forth rules, conditions, guidelines, and characteristics.

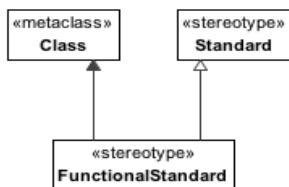

Figure 8.180 - FunctionalStandard

Extensions

The following are extensions for FunctionalStandard:

- Class

Generalizations

The following are generalization relationships for FunctionalStandard:

- Standard

8.3.1.4.6.2 TechnicalStandard

MODAF: A ratified and peer-reviewed specification that is used to guide or constrain the architecture. A Standard may be applied to any element in the architecture via the [constrainedItem] property of UML::Constraint (Standard).

DoDAF: Technical standards document specific technical methodologies and practices to design and implement.

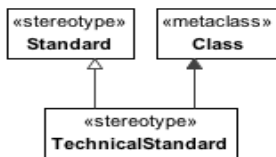

Figure 8.181 - TechnicalStandard

Extensions

The following are extensions for TechnicalStandard:

- Class

Generalizations

The following are generalization relationships for TechnicalStandard:

- Standard

8.3.1.4.6.3 UPDM L1::UPDM L0::DoDAF::TechnicalStandardsElements::Data

This section of the specification contains the Data elements of the DoDAF, Technical Standard Elements section.

8.3.1.4.6.3.1 AssociationOfInformation

MODAF: Asserts that there is a relationship between two entities (Entity Relationship).

DoDAF: A relationship or association between two elements of information.

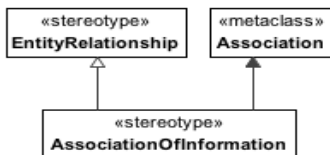

Figure 8.182 - AssociationOfInformation

Extensions

The following are extensions for AssociationOfInformation:

- Association

Generalizations

The following are generalization relationships for AssociationOfInformation:

- EntityRelationship

8.3.1.4.6.3.2 SecurityAttributesGroup

MODAF:NA

DoDAF:The group of Information Security Marking attributes in which the use of attributes ‘classification’ and ‘ownerProducer’ is required. This group is to be contrasted with group ‘SecurityAttributesOptionGroup’ in which use of those attributes is optional.

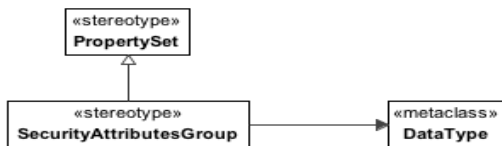

Figure 8.183 - SecurityAttributesGroup

Extensions

The following are extensions for SecurityAttributesGroup:

- DataType

Generalizations

The following are generalization relationships for SecurityAttributesGroup:

- PropertySet

8.3.1.4.7 UPDM L1::UPDM L0::DoDAF::ServiceElements

This section of the specification contains the Service Elements of the DoDAF section.

8.3.1.4.7.1 ServiceAccess

UPDM: The mechanism by which a service is accessed.

MODAF: NA

DoDAF: NA

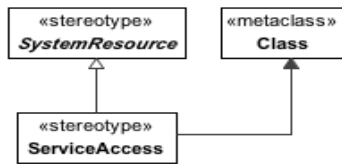

Figure 8.184 - ServiceAccess

Extensions

The following metaclasses are extended by ServiceAccess:

- Class

Specializations

The ServiceAccess element is a specialization of:

- SystemResource

8.3.1.4.7.1.1 ServiceDescription

UPDM: Package containing the elements that describe a service, from DoDAF 2.

DoDAF: Information necessary to interact with the service in such terms as the service inputs, outputs, and associated semantics. The service description also conveys what is accomplished when the service is invoked and the conditions for using the service.

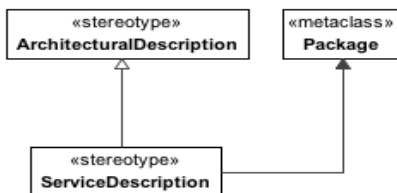

Figure 8.185 - ServiceDescription

Extensions

The following metaclasses are extended by ServiceDescription:

- Package

Specializations

The ServiceDescription element is a specialization of:

- ArchitecturalDescription

8.3.1.5 UPDM L1::UPDM L0::MODAF

Elements that are not considered part of the Core architectural model, but necessary for MODAF.

8.3.1.5.1 UPDM L1::UPDM L0::MODAF::AcquisitionElements

The Acquisition View elements for MODAF specific models.

8.3.1.5.1.1 UPDM L1::UPDM L0::MODAF::AcquisitionElements::Milestones

Milestones are an event in a Project by which progress is measured.

8.3.1.5.1.1.1 ActualProjectMilestone

MODAF: (ProjectMilestone): An event in a ActualProject (MODAF::Project) by which progress is measured. Note: in the case of an acquisition project, there are two key types of milestones which shall be represented using subtypes - IncrementMilestone (MODAF::CapabilityIncrement) and OutOfServiceMilestone (MODAF::OutOfService).

DoDAF: NA

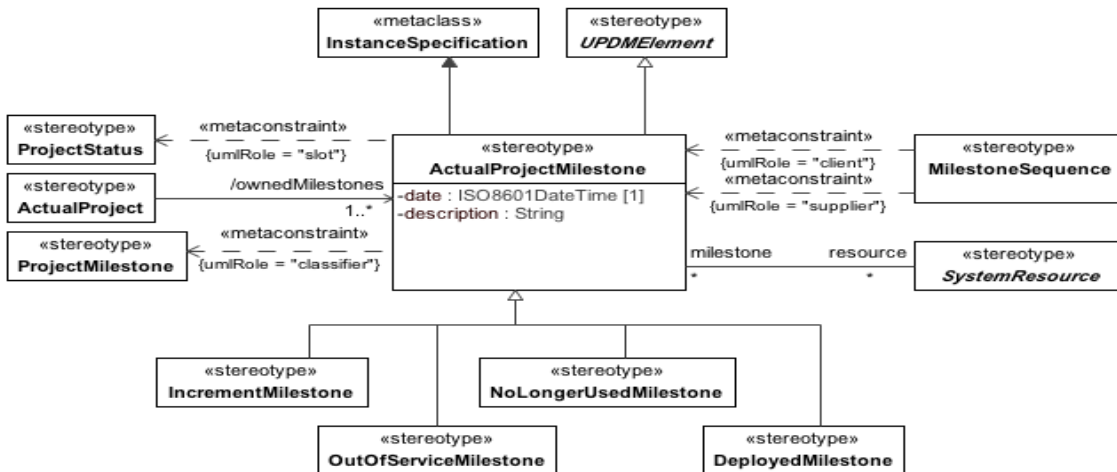

Figure 8.186 - ActualProjectMilestone

Constraints

The following are constraints for ActualProjectMilestone:

- ActualProjectMilestone.classifier - Value for the classifier property must be stereotyped “ProjectMilestone” or its specializations.
- ActualProjectMilestone.slot - Slot values have to be stereotyped “ProjectStatus” or its specializations.

Attribute

The following are attributes for ActualProjectMilestone:

- date : ISO8601DateTime[1] - Defines time for this ProjectMilestone.
- description : String[1] -
- resource : Resource[*] - Affected resource.

Extensions

The following are extensions for ActualProjectMilestone:

- InstanceSpecification

Generalizations

The following are generalization relationships for ActualProjectMilestone:

- UPDMElement

8.3.1.5.1.1.2 IncrementMilestone

MODAF: (MODAF::CapabilityIncrement): An ActualProjectMilestone (MODAF::ProjectMilestone) that indicates the point in time at which a project is predicted to deliver or has delivered a Capability.

DoDAF: NA

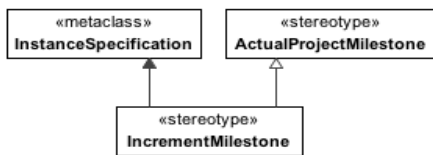

Figure 8.187 - IncrementMilestone

Elements related to the CapabilityIncrementMilestone stereotype.

Extensions

The following are extensions for IncrementMilestone:

- InstanceSpecification

Generalizations

The following are generalization relationships for IncrementMilestone:

- ActualProjectMilestone

8.3.1.5.1.1.3 MilestoneSequence

MODAF: A MilestoneSequence (MODAF::MilestoneRelationship) is a relationship between two milestones.

DoDAF: NA

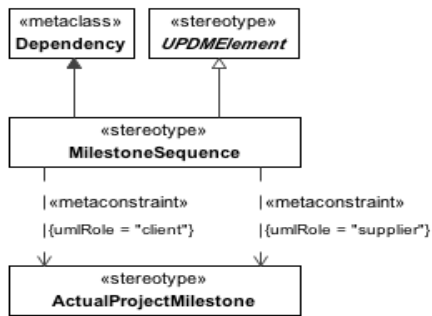

Figure 8.188 - MilestoneSequence

Elements related to the MileStoneSequence stereotype.

Constraints

The following are constraints for MilestoneSequence:

- MilestoneSequence.client - Client must be “ProjectMilestone.”
- MilestoneSequence.supplier - Supplier must be “ProjectMilestone.”

Extensions

The following are extensions for MilestoneSequence:

- Dependency

Generalizations

The following are generalization relationships for MilestoneSequence:

- UPDMElement

8.3.1.5.1.1.4 OutOfServiceMilestone

MODAF: An OutOfServiceMilestone (MODAF::OutOfService) is a ProjectMilestone that indicates a project’s deliverable is to go out of service.

DoDAF: NA

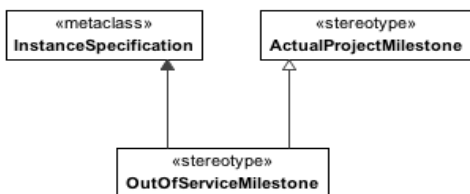

Figure 8.189 - OutOfServiceMilestone

Elements related to the OutOfServiceMilestone stereotype.

Extensions

The following are extensions for OutOfServiceMilestone:

- InstanceSpecification

Generalizations

The following are generalization relationships for OutOfServiceMilestone:

- ActualProjectMilestone

8.3.1.5.1.1.5 ProjectMilestone

UPDM: An element representing a collection of themes (e.g., DLOD or DOTMLPF) which is connected to a Project as part of a Project’s definition. This is used as a template for ActualProjectMilestones.

MODAF: An event in a Project by which progress is measured.

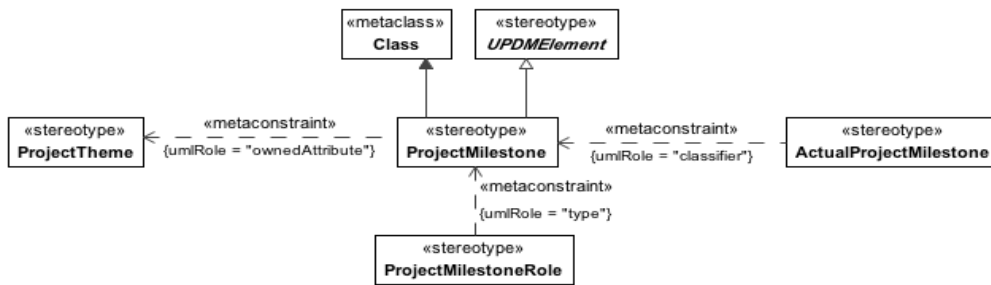

Figure 8.190 - ProjectMilestone

Elements related to the ProjectMilestoneType stereotype.

Constraints

The following are constraints for ProjectMilestone:

- ProjectMilestone.ownedAttributes - Owned attributes have to be stereotyped <<ProjectTheme>>.
- ProjectMilestone.ownedThemes - All of the ProjectThemes, owned by a ProjectMilestone, must be typed by the same StatusIndicators.

Extensions

The following are extensions for ProjectMilestone:

- Class

Generalizations

The following are generalization relationships for ProjectMilestone:

- UPDMElement

8.3.1.5.1.1.6 ProjectOwnership

MODAF: A type of OrganizationProjectRelationship where the organization is the party responsible for the project.

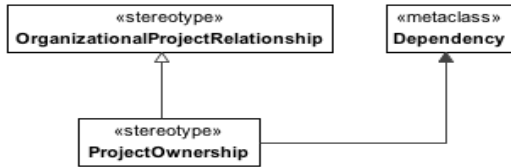

Figure 8.191 - ProjectOwnership

Extensions

The following are extensions for ProjectOwnership:

- Dependency

Generalizations

The following are generalization relationships for ProjectOwnership:

- OrganizationalProjectRelationship

8.3.1.5.1.1.7 ProjectSequence

MODAF: Asserts that one ActualProject (MODAF::Project) follows from another (i.e., the target ActualProject cannot start until the source ActualProject has ended).

DoDAF: NA

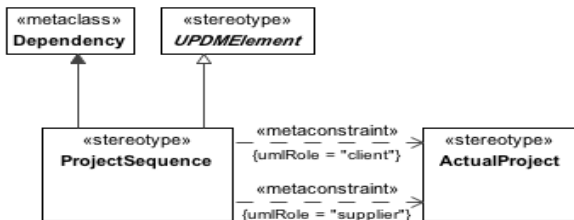

Figure 8.192 - ProjectSequence

Elements related to the ProjectSequence stereotype.

Constraints

The following are constraints for ProjectSequence:

- ProjectSequence.client - Client property value must be stereotyped “ActualProject” or its specializations.
- ProjectSequence.supplier - Supplier property value must be stereotyped “ActualProject” or its specializations.

Extensions

The following are extensions for ProjectSequence:

- Dependency

Generalizations

The following are generalization relationships for ProjectSequence:

- UPDMElement

8.3.1.5.1.2 UPDM L1::UPDM L0::MODAF::AcquisitionElements::Structure

Structure for Acquisition View elements for MODAF specific models.

8.3.1.5.1.2.1 ProjectStatus

MODAF: A ProjectStatus (MODAF::StatusAtMilestone) is a relationship between a Status and a milestone that asserts the status (i.e., level of progress) of a ProjectTheme for the project at the time of the ActualProjectMilestone (MODAF::Milestone).

DoDAF: NA

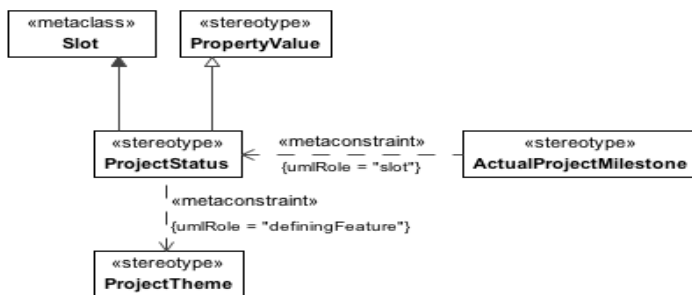

Figure 8.193 - ProjectStatus

Elements related to the ProjectStatus stereotype.

Constraints

The following are constraints for ProjectStatus:

- ProjectStatus.definingFeature - DefiningFeature value must be stereotyped “ProjectTheme” or its specializations.

Extensions

The following are extensions for ProjectStatus:

- Slot

Generalizations

The following are generalization relationships for ProjectStatus:

- PropertyValue

8.3.1.5.1.2.2 ProjectTheme

MODAF: An aspect by which the progress of various Projects may be measured. In UK MOD, this could be one of the defense lines of development (DLOD), or DOTMLPF in the US.

DoDAF: NA

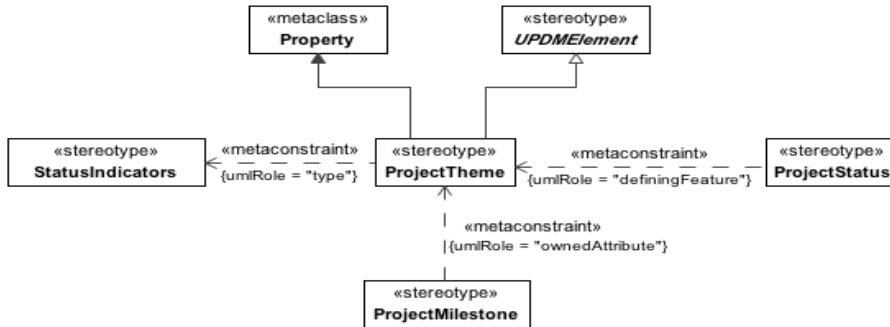

Figure 8.194 - ProjectTheme

Elements related to the ProjectTheme stereotype.

Constraints

The following are constraints for ProjectTheme:

- ProjectTheme.type - Value for the type property must be stereotyped “ProjectThemeStatus” or its specializations.

Extensions

The following are extensions for ProjectTheme:

- Property

Generalizations

The following are generalization relationships for ProjectTheme:

- UPDMElement

8.3.1.5.1.2.3 StatusIndicators

UPDM: Specifies a status for a ProjectTheme (such as training status).

MODAF: An enumeration of the possible statuses (MODAF::StatusIndicator) for one of more ProjectThemes.

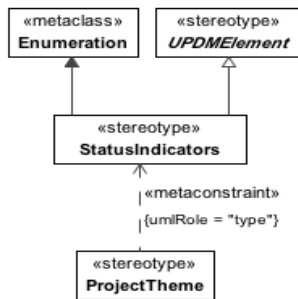

Figure 8.195 - StatusIndicators

Extensions

The following are extensions for StatusIndicators:

- Enumeration

Generalizations

The following are generalization relationships for StatusIndicators:

- UPDMElement

8.3.1.5.2 UPDM L1::UPDM L0::MODAF::AllElements

The All View elements for MODAF specific models.

8.3.1.5.2.1 UPDM L1::UPDM L0::MODAF::AllElements::Environment

This section of the specification contains the Environment elements of the MODAF,All Elements section.

8.3.1.5.2.1.1 Climate

MODAF: A type of weather condition, or combination of weather conditions (e.g., high temperature & dry).

DoDAF: NA

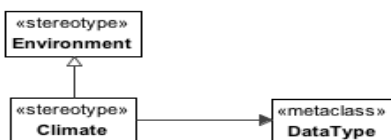

Figure 8.196 - Climate

Extensions

The following are extensions for Climate:

- DataType

Generalizations

The following are generalization relationships for Climate:

- Environmental

8.3.1.5.2.1.2 LightCondition

MODAF: a specification of environmental lighting conditions.

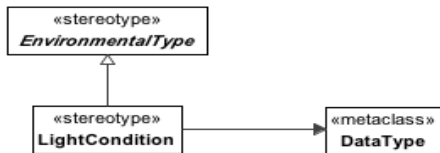

Figure 8.197 - LightCondition

Extensions

The following are extensions for LightCondition:

- DataType

Generalizations

The following are generalization relationships for LightCondition:

- EnvironmentalType

8.3.1.5.2.2 UPDM L1::UPDM L0::MODAF::AllElements::Ontology

Ontology elements from All Elements.

8.3.1.5.2.2.1 Alias

A UPDM Artifact used to define an alternative name for an element as used by DoDAF or MODAF.

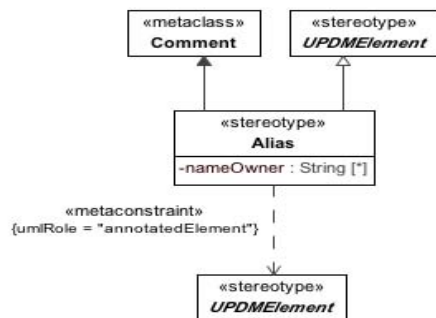

Figure 8.198 - Alias

Constraints

The following are constraints for Alias:

- Alias.annotatedElement - Value for the annotatedElement property must be stereotyped “UPDMElement” or its specializations.

Attribute

The following are attributes for Alias:

- nameOwner : String[*] - The person or organization that uses this alternative name.

Extensions

The following are extensions for Alias:

- Comment

Generalizations

The following are generalization relationships for Alias:

- UPDMElement

8.3.1.5.2.2.2 Definition

MODAF: A definition of an element in the architecture.

DoDAF:NA

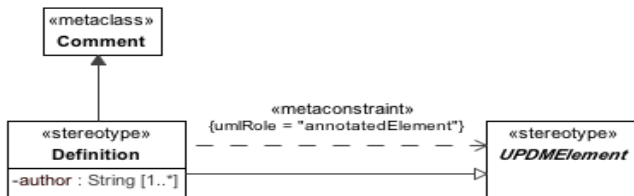

Figure 8.199 - Definition

Constraints

The following are constraints for Definition:

- Definition.annotatedElement - Value for the annotatedElement property must be stereotyped “UPDMElement” or its specializations.

Attribute

The following are attributes for Definition:

- author : String[1..*] - The original or current person (architect) responsible for the element.

Extensions

The following are extensions for Definition:

- Comment

Generalizations

The following are generalization relationships for Definition:

- UPDMElement

8.3.1.5.2.3 ExternalIndividual

MODAF: An individual (i.e., something which has spatial and temporal extent) defined by an external ontology.

DoDAF: NA

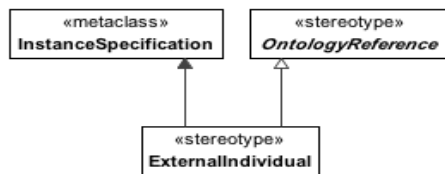

Figure 8.200 - ExternalIndividual

Extensions

The following are extensions for ExternalIndividual:

- InstanceSpecification

Generalizations

The following are generalization relationships for ExternalIndividual:

- OntologyReference

8.3.1.5.2.4 ExternalTuple

UPDM: An instance of ExternalTupleType defined in an external Ontology.

MODAF:NA

DoDAF:NA

Extensions

The following are extensions for ExternalTuple:

- Class

Generalizations

The following are generalization relationships for ExternalTuple:

- OntologyReference

8.3.1.5.2.2.5 ExternalTupleType

UPDM: A TupleType defined in an external Ontology.

MODAF:NA

DoDAF:NA

Extensions

The following are extensions for ExternalTupleType:

- Class

Generalizations

The following are generalization relationships for ExternalTupleType:

- ExternalType

8.3.1.5.2.2.6 ExternalType

MODAF: A type defined by an external ontology.

DoDAF: NA

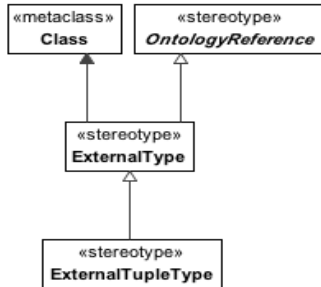

Figure 8.201 - ExternalType

Extensions

The following are extensions for ExternalType:

- Class

Generalizations

The following are generalization relationships for ExternalType:

- OntologyReference

8.3.1.5.2.2.7 OntologyReference

MODAF: A reference to an element in a recognized external ontology or taxonomy.

DoDAF:NA

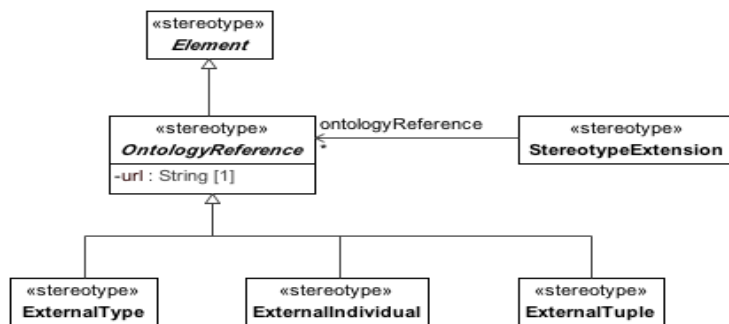

Figure 8.202 - OntologyReference

Attribute

The following are attributes for OntologyReference:

- url : String[1] - Unique identifier for the element.

Generalizations

The following are generalization relationships for OntologyReference:

- UPDMElement

8.3.1.5.2.2.8 Overlap

IDEAS:A couple of wholePart couples where the part in each couple is the same.

Constraints

The following are constraints for Overlap:

- Overlap.client - Values for the client property must be stereotyped “UPDMElement” or its specializations.
- Overlap.supplier - Values for the supplier property must be stereotyped “UPDMElement” or its specializations.

Extensions

The following are extensions for Overlap:

- Dependency

Generalizations

The following are generalization relationships for Overlap:

- UPDMElement

8.3.1.5.2.2.9 SameAs

MODAF: Asserts that two elements refer to the same real-world thing.

DoDAF: NA

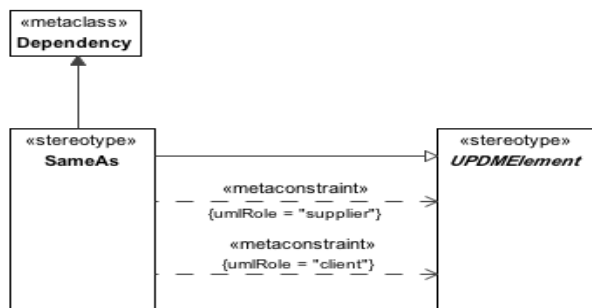

Figure 8.203 - SameAs

Constraints

The following are constraints for SameAs:

- SameAs.client - Values for the client property must be stereotyped “UPDMElement” or its specializations.
- SameAs.supplier - Values for the supplier property must be stereotyped “UPDMElement” or its specializations.

Extensions

The following are extensions for SameAs:

- Dependency

Generalizations

The following are generalization relationships for SameAs:

- UPDMElement

8.3.1.5.2.2.10 StereotypeExtension

MODAF: Defines an additional stereotype used in the architecture which is not defined in this meta-model. The body attribute contains the name of the new stereotype. The extendedStereotype tagged value shall contain the name of the meta-model stereotype which is extended. The ontologyReference tagged value shall be populated with a reference to the external ontology element represented by the new stereotype.

DoDAF: NA

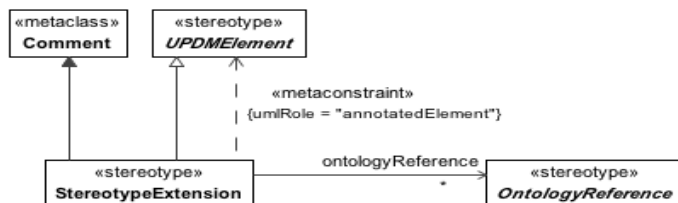

Figure 8.204 - StereotypeExtension

Constraints

The following are constraints for StereotypeExtension:

- StereotypeExtension.annotatedElement - Values for the annotatedElement property must be stereotyped “UPDMElement” or its specializations.

Attribute

The following are attributes for StereotypeExtension:

- ontologyReference : OntologyReference[*] -

Extensions

The following are extensions for StereotypeExtension:

- Comment

Generalizations

The following are generalization relationships for StereotypeExtension:

- UPDMElement

8.3.1.5.3 UPDM L1::UPDM L0::MODAF::OperationalElements

The Operational View elements for MODAF specific models.

8.3.1.5.3.1 UPDM L1::UPDM L0::MODAF::OperationalElements::Behavior

Behavior for Operational View elements for MODAF specific models.

8.3.1.5.3.1.1 ActivitySubject

MODAF: Anything that is acted upon by an OperationalActivity.

DoDAF: NA

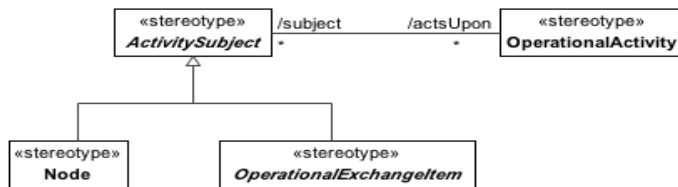

Figure 8.205 - ActivitySubject

Attribute

The following are attributes for ActivitySubject:

- actsUpon : OperationalActivity[*] - OperationalActivities that this ActivitySubject is acting upon.

Generalizations

The following are generalization relationships for ActivitySubject:

- UPDMElement

8.3.1.5.3.1.2 OwnsProcess

UPDM: Asserts that an ActualOrganizationalResource owns a Process.

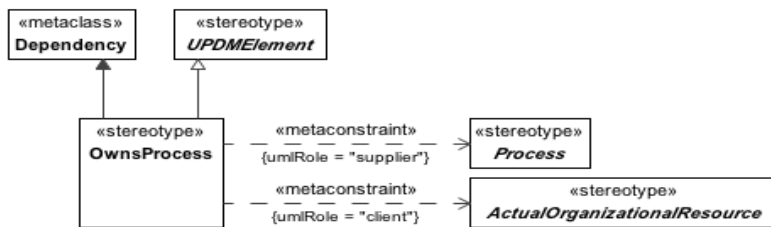

Figure 8.206 - OwnsProcess

Constraints

The following are constraints for OwnsProcess:

- OwnsProcess.client - Value for the client property must be stereotyped “ActualOrganizationalResource” or its specializations.
- OwnsProcess.supplier - Value for the supplier property must be stereotyped a specialization of “Process.”

Extensions

The following are extensions for OwnsProcess:

- Dependency

Generalizations

The following are generalization relationships for OwnsProcess:

- UPDMElement

8.3.1.5.3.1.3 Process

MODAF: The abstract supertype of OperationalActivity and EnduringTask.

DoDAF: NA

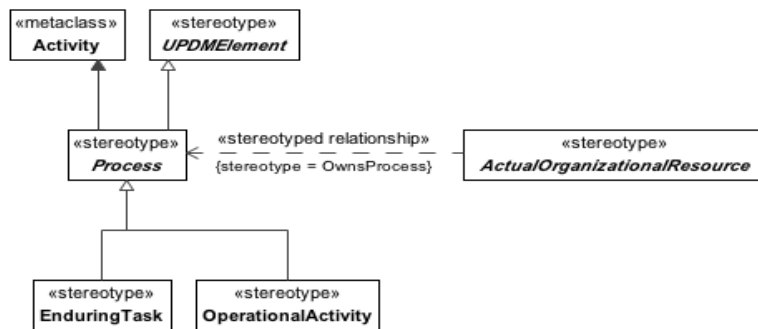

Figure 8.207 - Process

Extensions

The following are extensions for Process:

- Activity

Generalizations

The following are generalization relationships for Process:

- UPDMElement

8.3.1.5.3.1.4 StandardOperationalActivity

MODAF: An OperationalActivity that is a standard procedure that is doctrinal. Note: This is equivalent to what some defence organizations call JETLs.

DoDAF: Work, not specific to a single organization, weapon system or individual, that transforms inputs into outputs or changes their state (DoDAF:: Activity).



Figure 8.208 - StandardOperationalActivity

Extensions

The following are extensions for StandardOperationalActivity:

- Activity

Generalizations

The following are generalization relationships for StandardOperationalActivity:

- OperationalActivity

8.3.1.5.3.2 UPDM L1::UPDM L0::MODAF::OperationalElements::Flows

Flows for Operational View elements for MODAF specific models.

8.3.1.5.3.2.1 Control

MODAF: A type of ResourceInteraction where one Resource (source) controls another (target). Examples - the driver of a tank, one organization having operational control of another, a fire control system controlling a weapons system.

DoDAF: NA

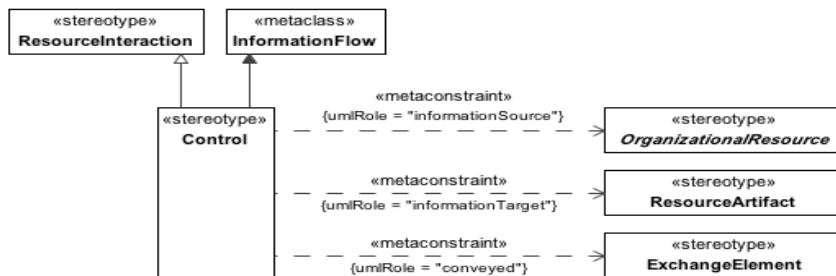

Figure 8.209 - Control

Constraints

The following are constraints for Control:

- Controls.conveyed - Value for the conveyed property must be stereotyped “ExchangeElement” or its specializations.
- Controls.informationSource - Value for the informationSource property must be stereotyped “OrganizationalResource” or its specializations.
- Controls.informationTarget - Value for the informationTarget property must be stereotyped “ResourceArtifact” or its specializations.

Extensions

The following are extensions for Control:

- InformationFlow

Generalizations

The following are generalization relationships for Control:

- ResourceInteraction

8.3.1.5.3.3 UPDM L1::UPDM L0::MODAF::OperationalElements::Structure

Structure for Operational View elements for MODAF specific models.

8.3.1.5.3.3.1 Energy

UPDM: Energy to be exchanged between Nodes.

MODAF: A unit of energy that flows along an EnergyFlow or OperationalActivityEnergyFlow.

DoDAF: NA

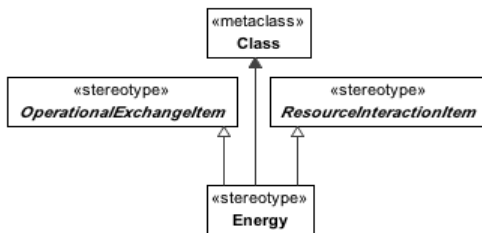

Figure 8.210 - Energy

Extensions

The following are extensions for Energy:

- Class

Generalizations

The following are generalization relationships for Energy:

- ResourceInteractionItem
- OperationalExchangeItem

8.3.1.5.3.3.2 ProblemDomain

MODAF: The boundary containing those Nodes that may be realized by functional resources specified in SV-1. There may be more than one alternative solution for a given ProblemDomain specified as a set of SV suites. There may be only one ProblemDomain in a LogicalArchitecture.

DoDAF: NA - covered by the more general temporalWholePart element.

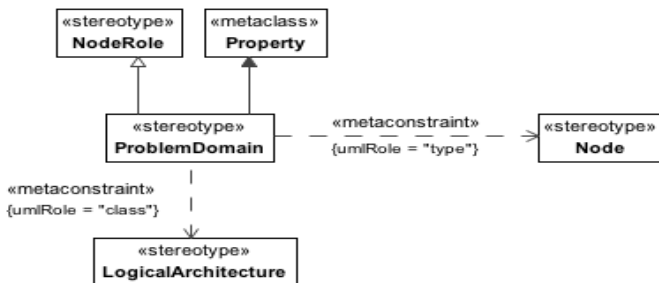

Figure 8.211 - ProblemDomain

Constraints

The following are constraints for ProblemDomain:

- ProblemDomain.class - Value for the class property must be stereotyped “LogicalArchitecture” or its specializations.
- ProblemDomain.type - Value for the type property must be stereotyped “Node” or its specializations.

Extensions

The following are extensions for ProblemDomain:

- Property

Generalizations

The following are generalization relationships for ProblemDomain:

- NodeRole

8.3.1.5.3.3.3 Trustline

MODAF: Asserts that the trustingParty (either a Node or a KnownResource) trusts the trustedParty to a given level (indicated by the level attribute). Note: No unit of measure is associated with the level - security architects must define their own scale of trust levels for a given architecture or set of architectures.

DoDAF: NA

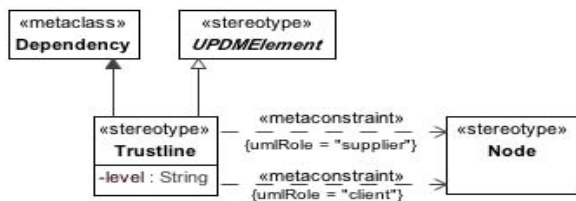

Figure 8.212 - Trustline

Constraints

The following are constraints for Trustline:

- Trustline.client - Values for the client property must be stereotyped “Node” or its specializations.
- Trustline.supplier - Values for the supplier property must be stereotyped “Node” or its specializations.

Attribute

The following are attributes for Trustline:

- level : String

Extensions

The following are extensions for Trustline:

- Dependency

Generalizations

The following are generalization relationships for Trustline:

- UPDMElement

8.3.1.5.3.3.4 UPDM L1::UPDM L0::MODAF::OperationalElements::Structure::Organizational

This section of the specification contains the organizational Elements of the MODAF, Operational Elements section.

8.3.1.5.3.3.4.1 RoleType

MODAF: An aspect of a person or organization that enables them to fulfill a particular function.

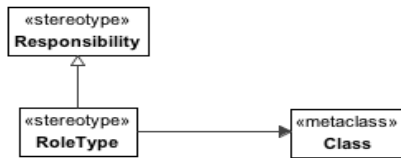

Figure 8.213 - RoleType

Extensions

The following are extensions for RoleType:

- Class

Generalizations

The following are generalization relationships for RoleType:

- Responsibility

8.3.1.5.4 UPDM L1::UPDM L0::MODAF::StrategicElements

The Strategic View elements for MODAF specific models.

8.3.1.5.4.1 UPDM L1::UPDM L0::MODAF::StrategicElements::Milestones

Milestone elements for Strategic View elements for MODAF specific models.

8.3.1.5.4.1.1 DeployedMilestone

MODAF: Asserts that an ActualOrganizationResource started to use, or is slated to start using a CapabilityConfiguration from a specific point in time. This is used to describe capabilities going into service with specific organizations or posts.

DoDAF: NA

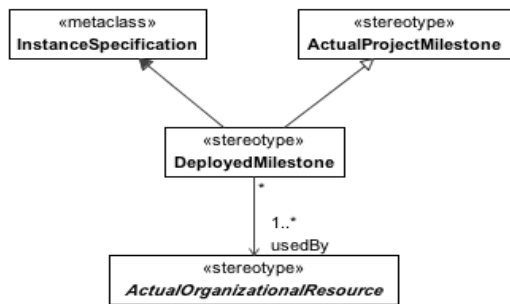

Figure 8.214 - DeployedMilestone

Attribute

The following are attributes for DeployedMilestone:

- usedBy : ActualOrganizationalResource[1..*] - ActualOrganizationalResources using CapabilityConfiguration deployed at this Milestone.

Extensions

The following are extensions for DeployedMilestone:

- InstanceSpecification

Generalizations

The following are generalization relationships for DeployedMilestone:

- ActualProjectMilestone

8.3.1.5.4.1.2 NoLongerUsedMilestone

MODAF: Asserts that an ActualOrganizationResource ceased to use or is slated to cease using a CapabilityConfiguration from a specific point in time. This is used to describe capabilities going out of service with specific organizations or posts.

DoDAF:NA

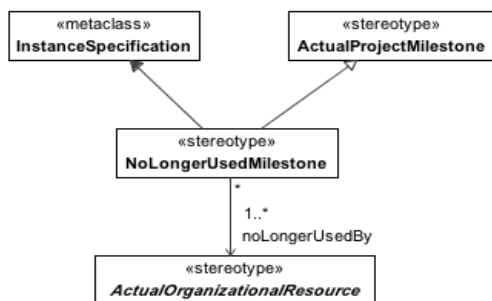

Figure 8.215 - NoLongerUsedMilestone

Attribute

The following are attributes for NoLongerUsedMilestone:

- noLongerUsedBy : ActualOrganizationalResource[1..*] - ActualOrganizationalResources that are no longer using CapabilityConfiguration that went out of service at this Milestone.

Extensions

The following are extensions for NoLongerUsedMilestone:

- InstanceSpecification

Generalizations

The following are generalization relationships for NoLongerUsedMilestone:

- ActualProjectMilestone

8.3.1.5.4.2 UPDM L1::UPDM L0::MODAF::StrategicElements::Structure

Structure elements for Strategic View elements for MODAF specific models.

8.3.1.5.4.2.1 EnduringTask

MODAF: A type of behavior recognized by an enterprise as being essential to achieving its goals (i.e., a strategic specification of what the enterprise does).

DoDAF: NA

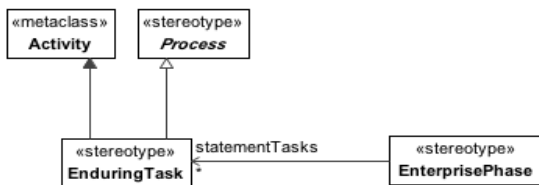

Figure 8.216 - EnduringTask

Extensions

The following are extensions for EnduringTask:

- Activity

Generalizations

The following are generalization relationships for EnduringTask:

- Process

8.3.1.5.4.2.2 WholeLifeEnterprise

UPDM: A WholeLifeEnterprise is a purposeful endeavor of any size involving people, organizations, and supporting systems (including physical systems and/or processes).

MODAF: An EnterprisePhase that represents the whole existence of an enterprise.

DoDAF: NA

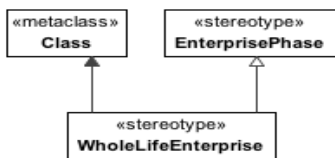

Figure 8.217 - WholeLifeEnterprise

Extensions

The following are extensions for WholeLifeEnterprise:

- Class

Generalizations

The following are generalization relationships for WholeLifeEnterprise:

- EnterprisePhase

8.3.1.5.5 UPDM L1::UPDM L0::MODAF::TechnicalStandardsElements

This section of the specification contains the Technical Standard Elements of the MODAF section.

8.3.1.5.5.1 ProtocolLayer

MODAF: Asserts that a Protocol (upperLayer) uses another Protocol (lowerLayer)

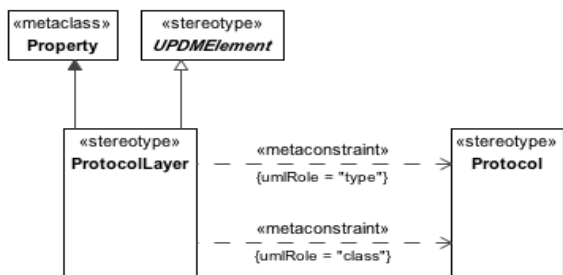

Figure 8.218 - ProtocolLayer

Constraints

The following are constraints for ProtocolLayer:

- ProtocolLayer.class - Value for the class property must be stereotyped “Protocol” or its specializations.
- ProtocolLayer.type - Value for the type property must be stereotyped “Protocol” or its specializations.

Extensions

The following are extensions for ProtocolLayer:

- Property

Generalizations

The following are generalization relationships for ProtocolLayer:

- UPDMElement

8.3.1.6 UPDM L1::UPDM L0::SOPES

The SOPES profile comprises the core elements of the Shared Operational Picture Exchange Services (SOPES) Information Exchange Data Model (IEDM) modeling profile described in the Annex A of the OMG SOPES IEDM Specification. The modeling profile seeks to use UML to express the policies, rules, and constraints governing the release and exchange of information between information systems. The UML models provide a means to express these exchange policies in a manner that can be encoded as a set of human and machine readable policies that can be enforced by software applications and services.

The goal for adding SOPES to the UPDM is to provide greater fidelity for architecture modeling of information exchange requirements within the DoDAF, MODAF, and NAF.

Additional elements in the SOPES modeling profiles can be accomplished using standard UML Class diagram constructs and not specifically integrated into the UPDM Specification.

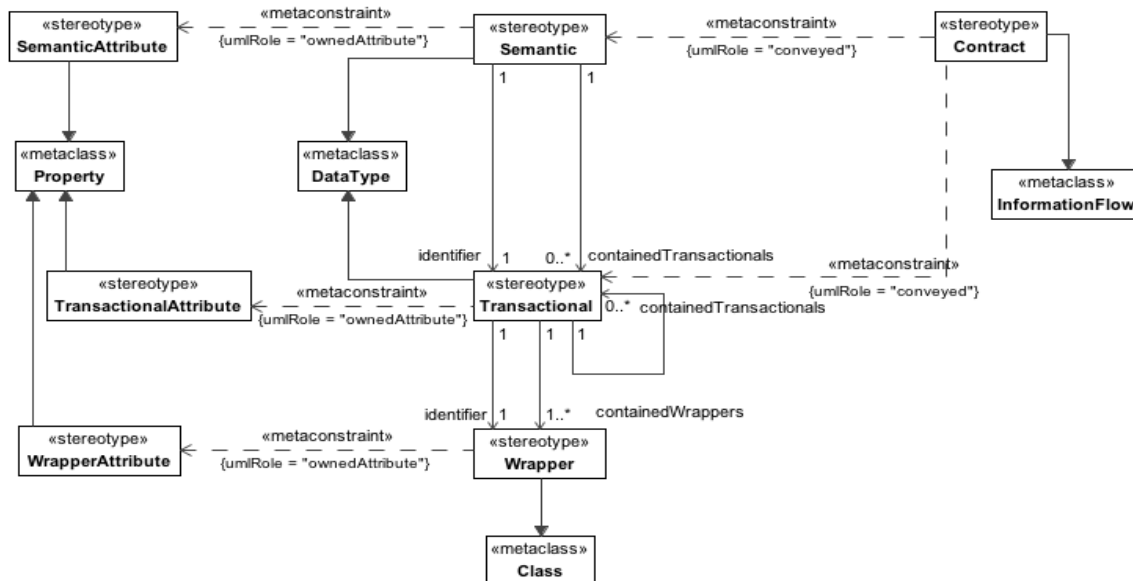

Figure 8.219 - SOPES elements

8.3.1.6.1 Contract

Constraints

The following are constraints for Contract:

- Contract.conveyed - conveyed property value must be stereotyped “Semantic,” “Transactional,” or their specializations.

Extensions

The following are extensions for Contract:

- InformationFlow

8.3.1.6.2 Semantic

Constraints

The following are constraints for Semantic:

- Semantic.ownedAttribute - ownedAttribute property value must be stereotyped “SemanticAttribute” or its specializations.

Attribute

The following are attributes for Semantic:

- containedTransactionals : Transactional[0..*] -
- identifier : Transactional[1] -

Extensions

The following are extensions for Semantic:

- DataType

8.3.1.6.3 SemanticAttribute

Extensions

The following are extensions for SemanticAttribute:

- Property

8.3.1.6.4 Transactional

Constraints

The following are constraints for Transactional:

- Transactional.ownedAttribute - ownedAttribute property value must be stereotyped “TransactionalAttribute” or its specializations.

Attribute

The following are attributes for Transactional:

- containedTransactionals : Transactional[0..*] -
- identifier : Wrapper[1] -
- representedWrappers : Wrapper[1..*] -

Extensions

The following are extensions for Transactional:

- DataType

8.3.1.6.5 TransactionalAttribute

Extensions

The following are extensions for TransactionalAttribute:

- Property

8.3.1.6.6 Wrapper

Constraints

The following are constraints for Wrapper:

- Wrapper.ownedAttribute - ownedAttribute property value must be stereotyped “WrapperAttribute” or its specializations.

Extensions

The following are extensions for Wrapper:

- Class

8.3.1.6.7 WrapperAttribute

Extensions

The following are extensions for WrapperAttribute:

- Property

8.3.1.7 UPDM L1::UPDM L0::SwAF

The SWAF section defines the design rules being used by the Swedish Armed Forces and NATO that aid in the development and implementation of information Integration.

The design rule describes how military organizations can develop and implement the ability to exchange information with each other to support interoperability issues. Much of this design rule can also be applied when exchanging information with other actors than military organizations.

Definition of interoperability in this context: The ability of technical systems and/or organizations using technical systems to operate together by making (necessary) data & information and/or services produced by one system or organization available to the others, in an agreed format.

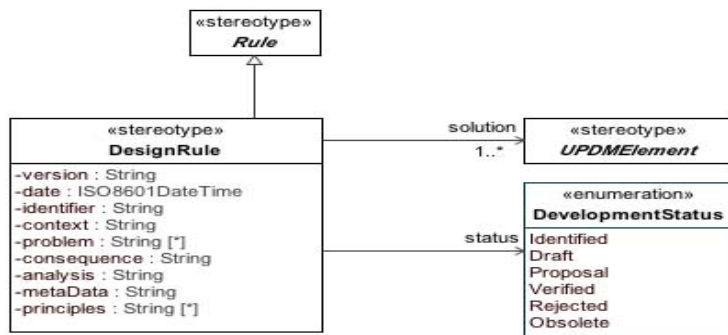

Figure 8.220 - Design Rule Elements

The Design Rule Elements diagram shows the UPDM elements and the relationships that map to the concepts of the Design Rules metamodel from NISP as submitted by Swedish Armed Forces (SWAF).

DesignRule

A design rule is a solution to a problem in a specific context with the following characteristics:

- belongs to a problem domain,
- packages knowledge in a reusable form,
- standardize solutions to design problems within NBD,
- gives value to the re-user.

Constraints

The following are constraints for DesignRule:

- DesignRule.ruleKind - Guidance

Attribute

The following are attributes for DesignRule:

- analysis : String[] -
- consequence : String[] -
- context : String[] -
- date : ISO8601DateTime[] -
- identifier : String[] -
- metaData : String[] -
- principles : String[*] -
- problem : String[*] -
- solution : UPDMElement[1..*] -

- status : DevelopmentStatus[] -
- version : String[] -

Extensions

The following are extensions for DesignRule:

- Class

Generalizations

The following are generalization relationships for DesignRule:

- Rule

8.3.1.7.1 DevelopmentStatus

Enumeration of development statuses, used to support the status tag of the DesignRule stereotype.

Enumeration Literals

The following are enumeration literals for DevelopmentStatus:

- Draft - Indicates that the development of the design rule is in Draft state.
- Identified - Indicates that the development of the design rule is in Identified state.
- Obsolete - Indicates that the development of the design rule is in Obsolete state.
- Proposal - Indicates that the development of the design rule is in Proposal state.
- Rejected - Indicates that the development of the design rule is in Rejected state.
- Verified - Indicates that the development of the design rule is in Verified state.

Subpart IV - Annexes

This part contains the following annexes:

A - Domain Metamodel

B - UPDM Views (Profile)

C- UPDM Elements Traceability to DoDAF/MODAF Elements

D- Sample Problem

E- Bibliography

Annex A - Domain Metamodel (DMM)

(non-normative)

This Annex comprises various diagrams which document the Domain Metamodel (DMM) that document the MoDAF 1.5 and MoDAF 1.2 integrated model. This model was used as a basis for creating the UPDM profile.

Note that the diagrams rely on color to aid the reader in understanding the model. Please refer to the legend in the various diagrams to understand the specific definitions.

A.1 Products

This section documents each of the products of the DMM.

A.1.1 AcV/PV

The AcquisitionElements describe project details, including dependencies between projects and capability integration. These Views guide the acquisition and fielding processes.

A.1.1.1 AcV-1/PV-1 - DMM

MODAF: AcV-1 view products represent an organizational perspective on projects.

DoDAF: AcV-1 view [DoDAF::Project Portfolio Relationships (PV-1) DoDAF-described View] represents an organizational perspective on programs, projects, or a portfolio of projects.

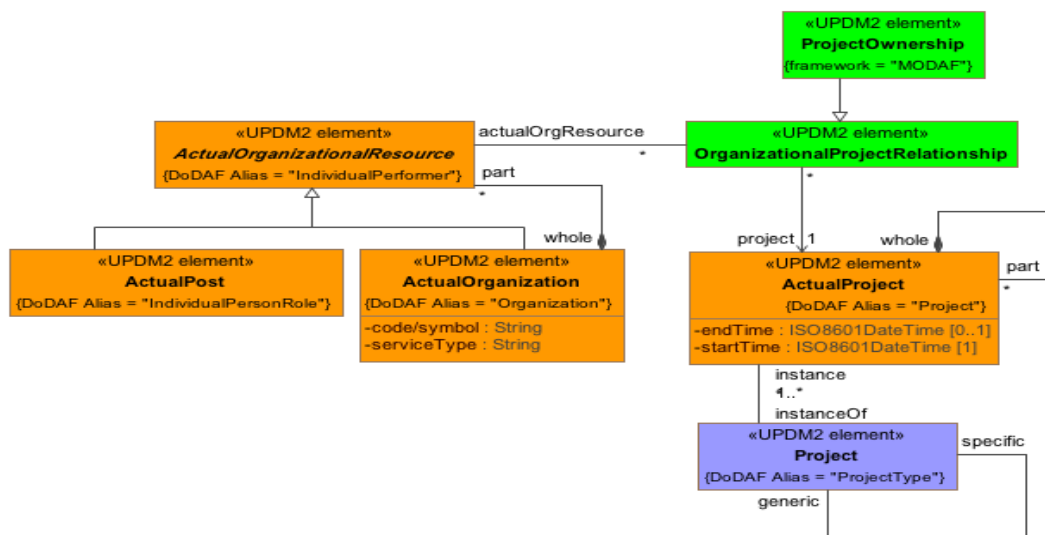

Figure A.1 - AcV-1/PV-1 - DMM

A.1.2 AcV-2/PV-2 - DMM

MODAF: AcV-2 view products provide a timeline perspective on projects.

DoDAF: AcV-2 (DoDAF::PV-2: Project Timelines DoDAF-described View) provides a timeline perspective on programs or projects.

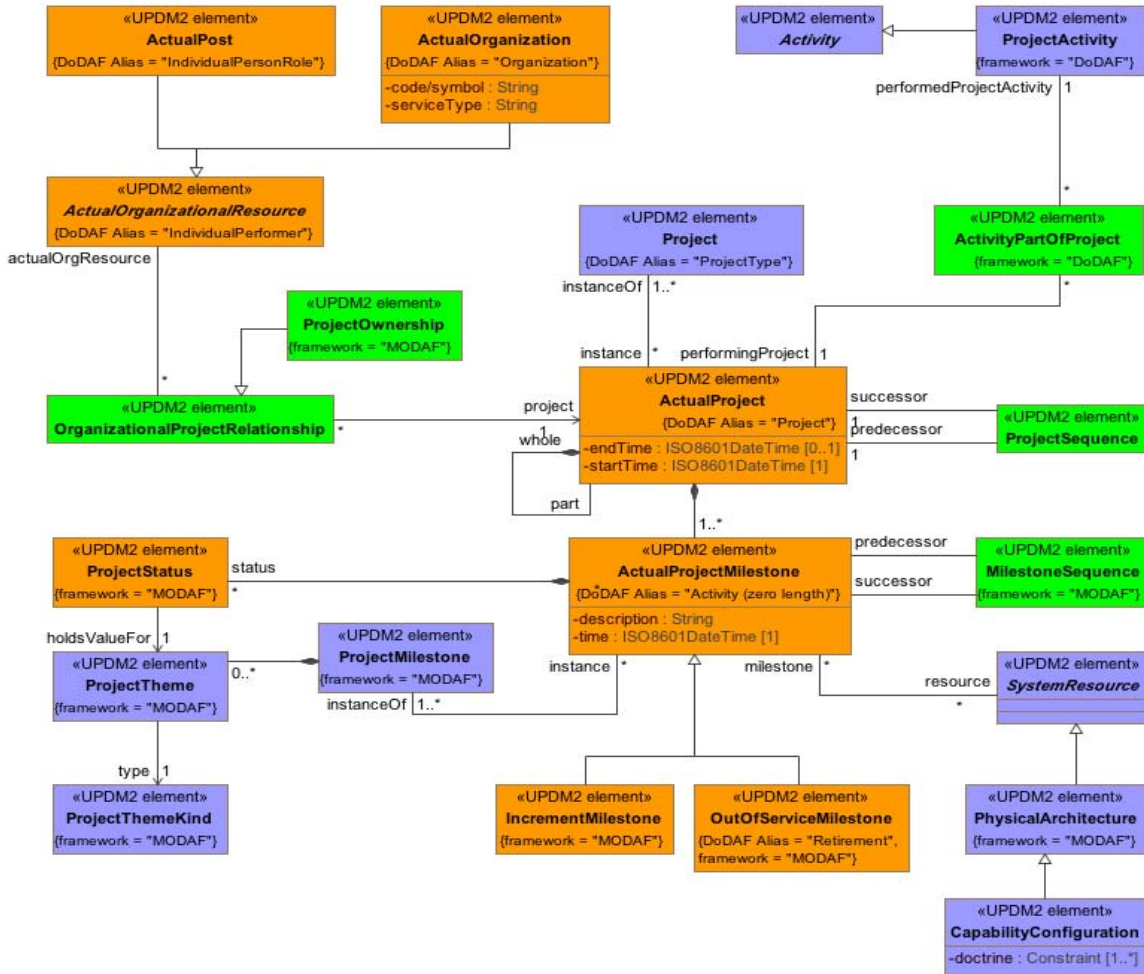

Figure A.2 - AcV-2/PV-2 - DMM

A.1.3 PV-3 - DMM

MODAF: NA

DoDAF: PV-3 diagram indicates the Capabilities that are realized by a particular project.

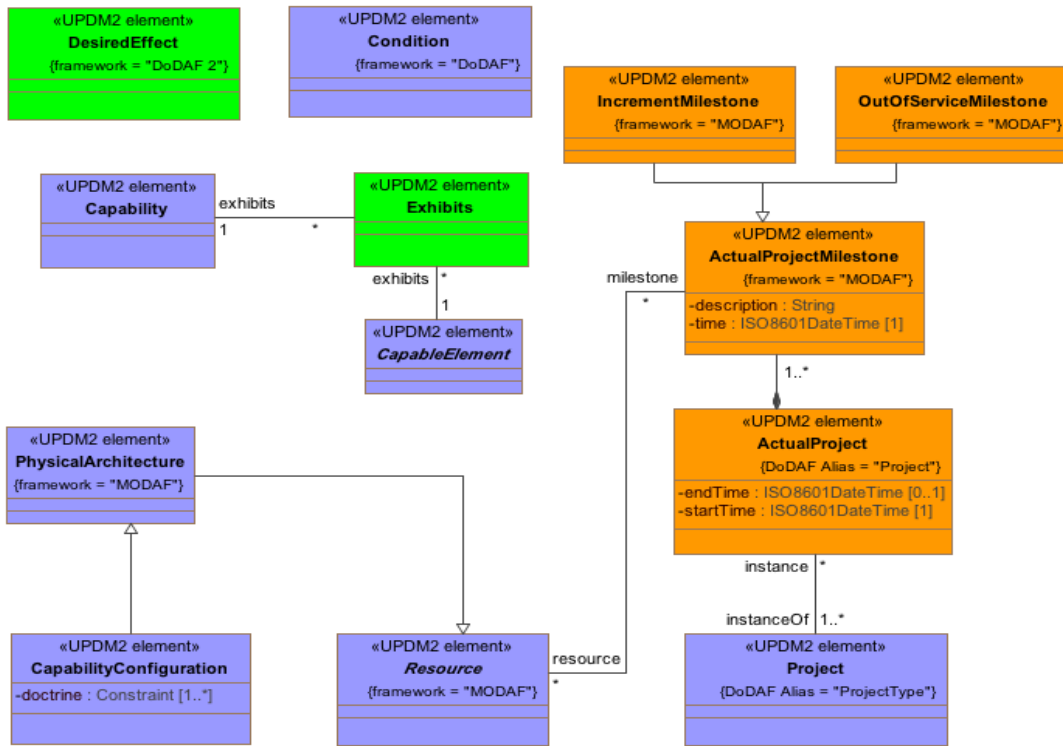

Figure A.3 - PV-3 - DMM

A.2 AV

Elements that are part of the All View. The All-Views (AVs) provide an overarching description of the architecture, its scope, ownership, timeframe and all of the other meta data that is required in order to effectively search and query architectural models. They also provide a place to record any findings arising from the architecting process. The AVs include a dictionary of the terms used in the construction of the architecture - which helps others fully understand its meaning at a later date. Since the AVs provide critical information for the future access and exploitation of an architectural model their population is essential whenever an architecture is created or modified. The AVs provide a critical input into the processes that provide architectural governance.

A.2.1 AV-1 - DMM

MODAF: The overview and summary information contained within the AV-1 product provides executive-level summary information in a consistent form that allows quick reference and comparison between architectural descriptions. AV-1 includes assumptions, constraints, and limitations that may affect high-level decisions relating to an architecture-based work programme.

DoDAF: The overview and summary information contained within the AV-1 DoDAF-described View provides executive-level summary information in a consistent form that allows quick reference and comparison between architectural descriptions. The AV-1 includes assumptions, constraints, and limitations that may affect high-level decisions relating to an architecture-based work program.

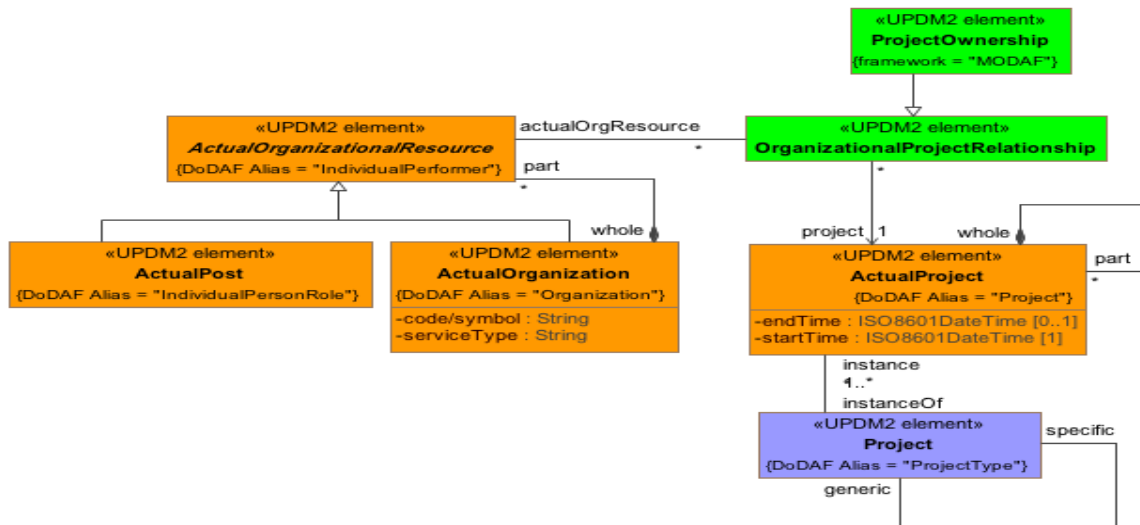

Figure A.4 - AV-1 - DMM

A.2.2 AV-2 - DMM

MODAF: AV-2 presents all the Elements used in an architecture as a stand alone structure. An AV-2 presents all the Elements as a specialization hierarchy, provides a text definition for each one and references the source of the element (e.g., MODAF Ontology, IDEAS Model, local, etc.). An AV-2 shows elements from the MODAF Ontology that have been used in the architecture and new elements (i.e., not in the MODAF Ontology) that have been introduced by the architecture.

DoDAF: The AV-2 presents all the metadata used in an architecture as a standalone structure. An AV-2 presents all the metadata as a specialization hierarchy, provides a text definition for each one and references the source of the element (e.g., DoDAF Meta-model, IDEAS, a published document or policy). An AV-2 shows elements from the DoDAF Meta-model that have been used in the architecture and new elements (i.e., not in the DoDAF Meta-model) that have been introduced by the architecture.

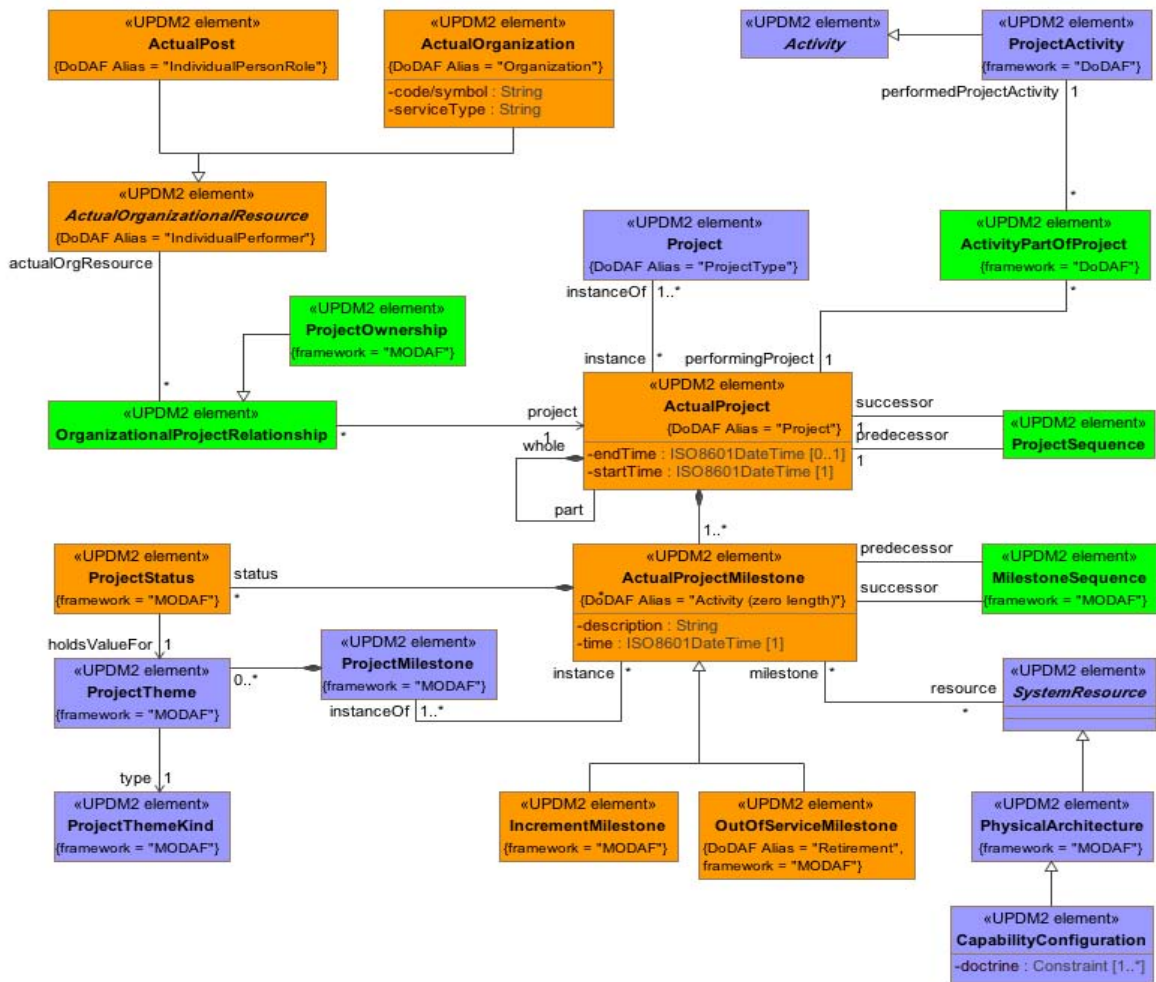

Figure A.5 - AV-2 - DMM

A.3 OV

The Operational View is about real-world activities, the people and machinery that perform them, and the means by which they are performed. The Operational View is divided into nine products intended to answer the “who,” “what,” “when,” “where,” “why,” and “how” of a mission. They are summarized in the table below.

A.3.1 OV-1 - DMM

MODAF: OV-1 addresses the high level operational concepts related to one or more missions. An OV-1 describes a mission, class of mission, or scenario; and highlights the main operational elements and interesting or unique aspects of operations.

The OV-1 has two purposes. First, it provides a means of organizing the operational architecture models into distinct groups based on scenario context. Second, it communicates the essence of the scenario context in an essentially graphical form.

DoDAF: The OV-1 DoDAF-described View describes a mission, class of mission, or scenario. It shows the main operational concepts and interesting or unique aspects of operations. It describes the interactions between the subject architecture and its environment, and between the architecture and external systems. A textual description accompanying the graphic is crucial. Graphics alone are not sufficient for capturing the necessary architecture data.

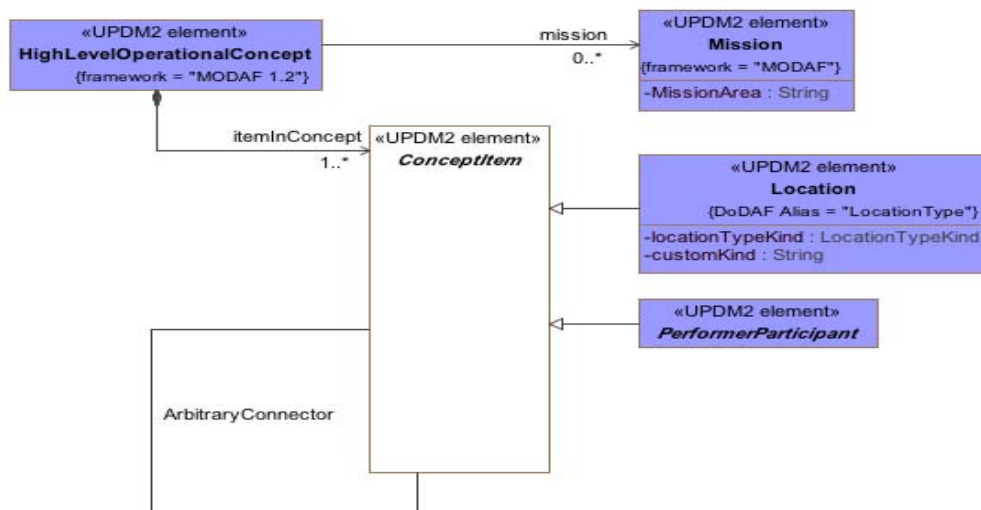

Figure A.6 - OV - 1 - DMM

A.3.2 OV-2 - DMM

MODAF: The Operational Node Relationships Description (OV-2) addresses localization of operational capability.

DoDAF: The Operational Resource Description (OV-2) DoDAF-described View applies the context of the operational capability to a community of anticipated users.

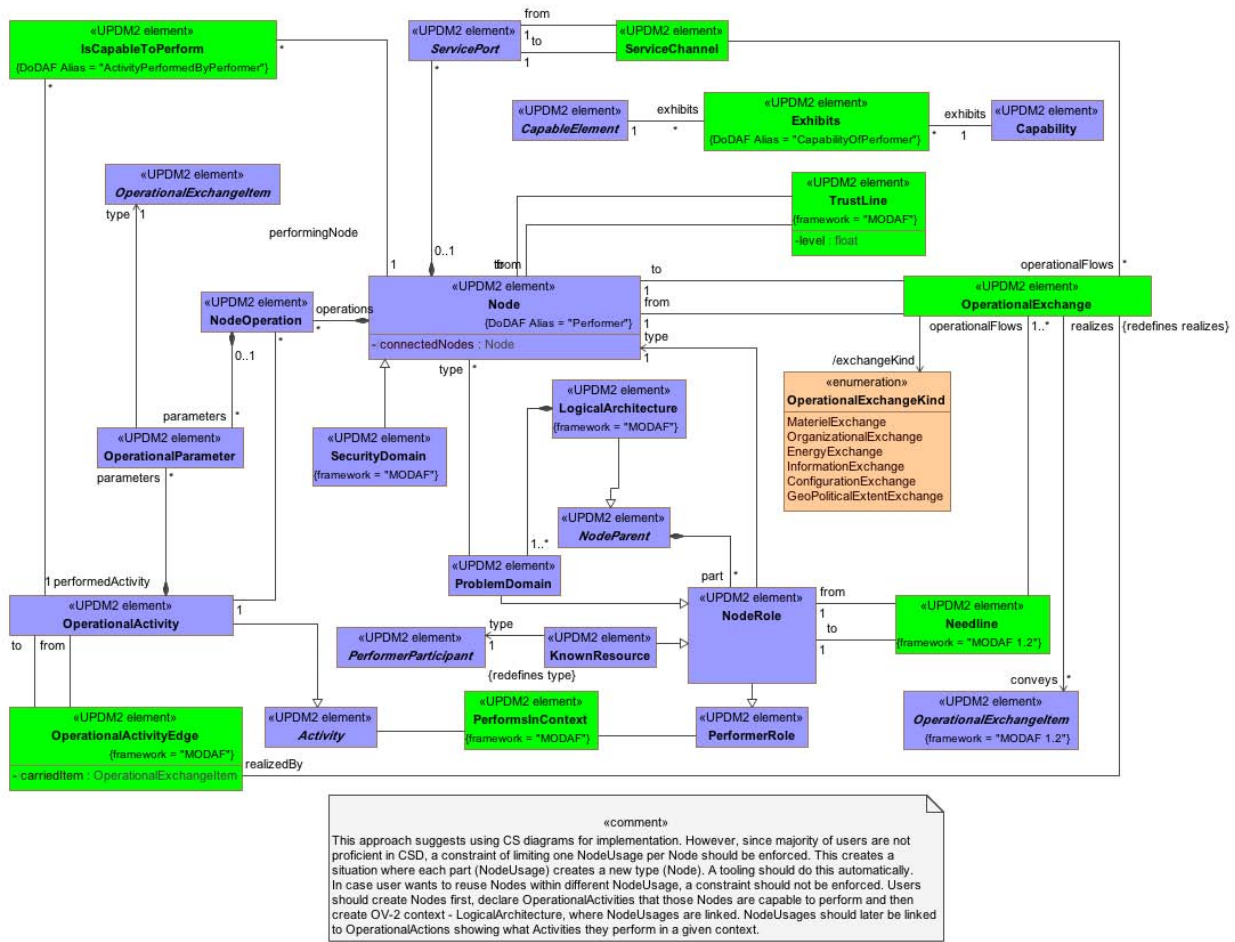

Figure A.7 - OV-2 - DMM

A.3.3 OV-3 - DMM

MODAF: The Operational Information Exchange Matrix (OV-3) addresses operational information exchanges between nodes.

DoDAF: The Operational Resource Flow Matrix (OV-3) DoDAF-described addresses operational resource flows exchanged between Operational Activities and locations.

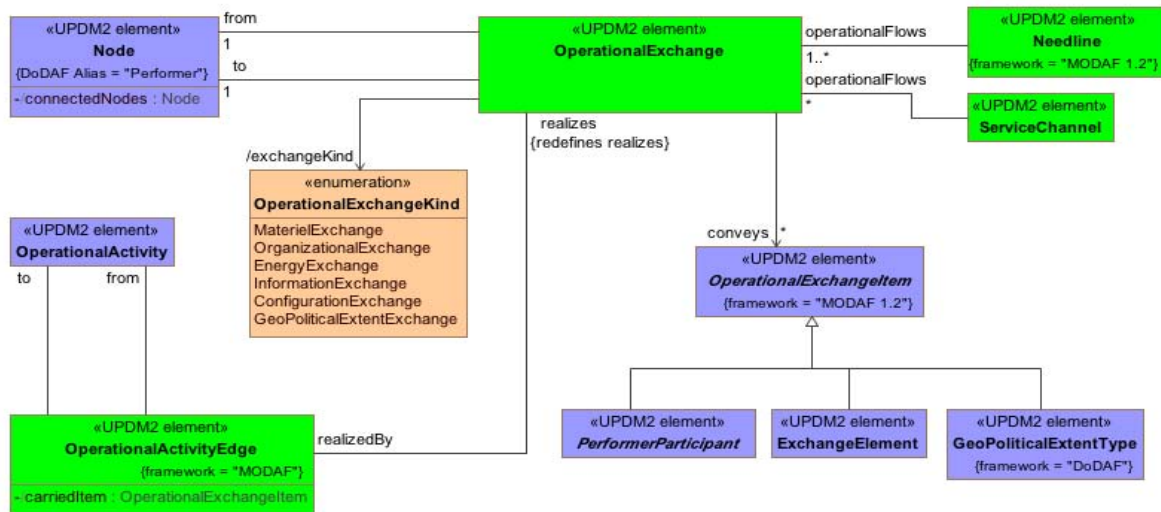

Figure A.8 - OV-3 - DMM

A.3.4 OV-4 Actual - DMM

This is the OV-4 Actual View. The Organizational Relationships Chart illustrates the command structure or relationships (as opposed to relationships with respect to a business process flow) among human roles, organizations, or organization types that are the key players in architecture. MODAF divides the OV-4 into two views, an OV-4 Typical and an OV-4 Actual. The former is exactly as the DoDAF OV-4, while the latter is a special form of the SV-1; where the resources are restricted to being organizational.

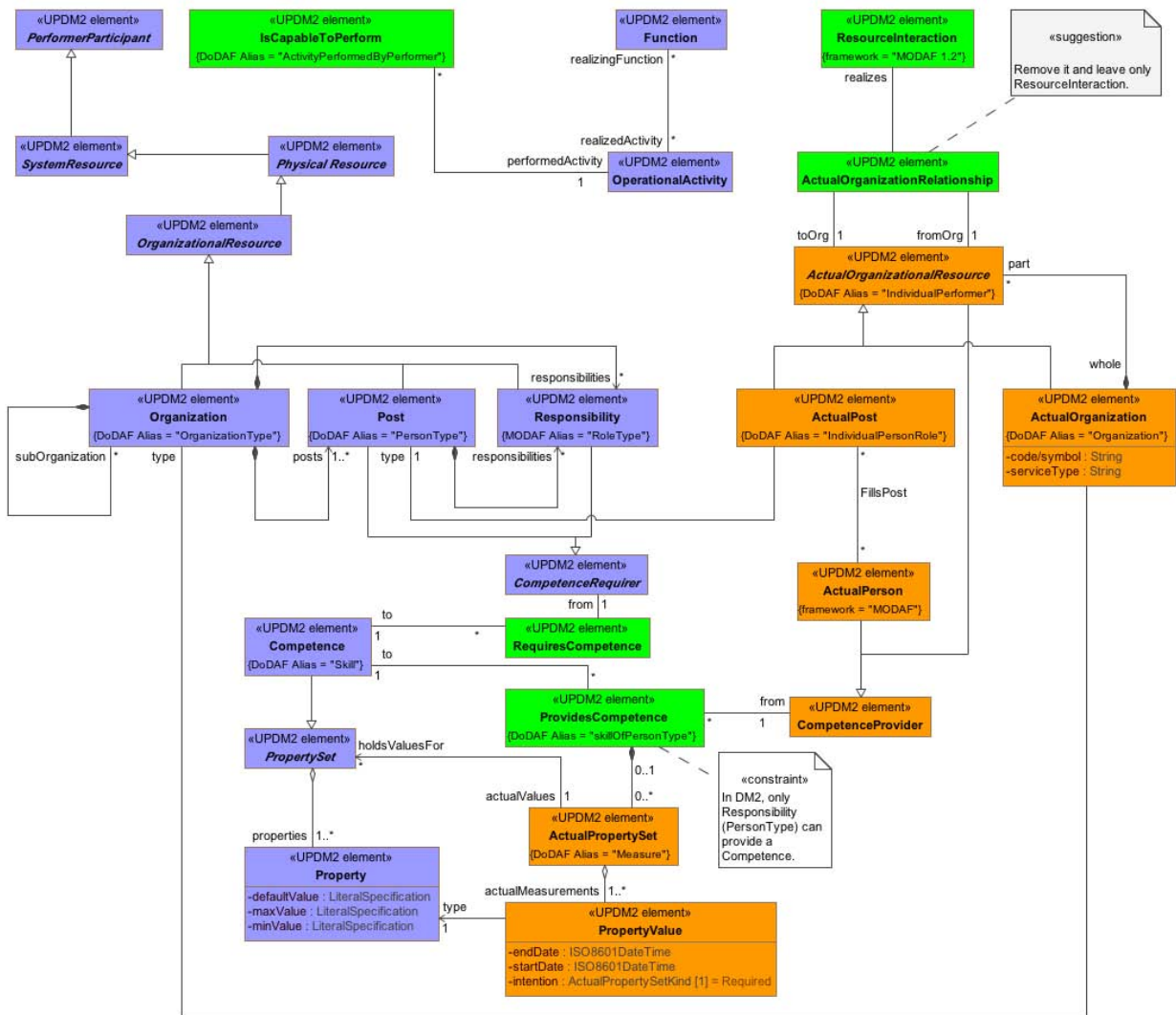

Figure A.9 - OV-4-Actual - DMM

A.3.5 OV-4 Typical - DMM

MODAF: The OV-4 shows organizational structures and interactions. The organizations shown may be civil or military. A typical OV-4 shows the possible relationships between organizational resources (organizations and posts).

DoDAF: DoDAF: The OV-4 DoDAF-described View shows organizational structures and interactions. The organizations shown may be civil or military. A typical OV-4 shows the possible relationships between organizational resources.

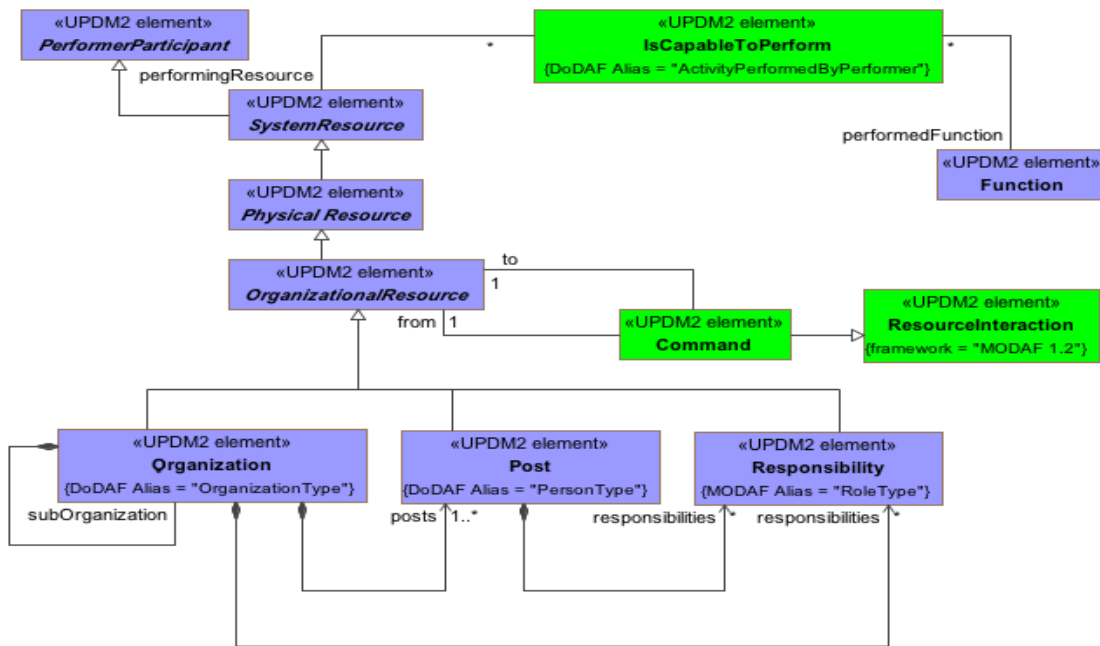

Figure A.10 - OV-4 Typical - DMM

A.3.6 OV-5 - DMM

MODAF: The Operational Activity Model (OV-5) describes the operations that are normally conducted in the course of achieving a mission or a business goal. It describes operational activities (or tasks), Input/Output flows between activities and to/from activities that are outside the scope of the Architecture.

DoDAF: The Operational Activity Model DoDAF-described View describes the operations that are normally conducted in the course of achieving a mission or a business goal. It describes operational activities (or tasks); Input/Output flows between activities, and to/from activities that are outside the scope of the Architecture.

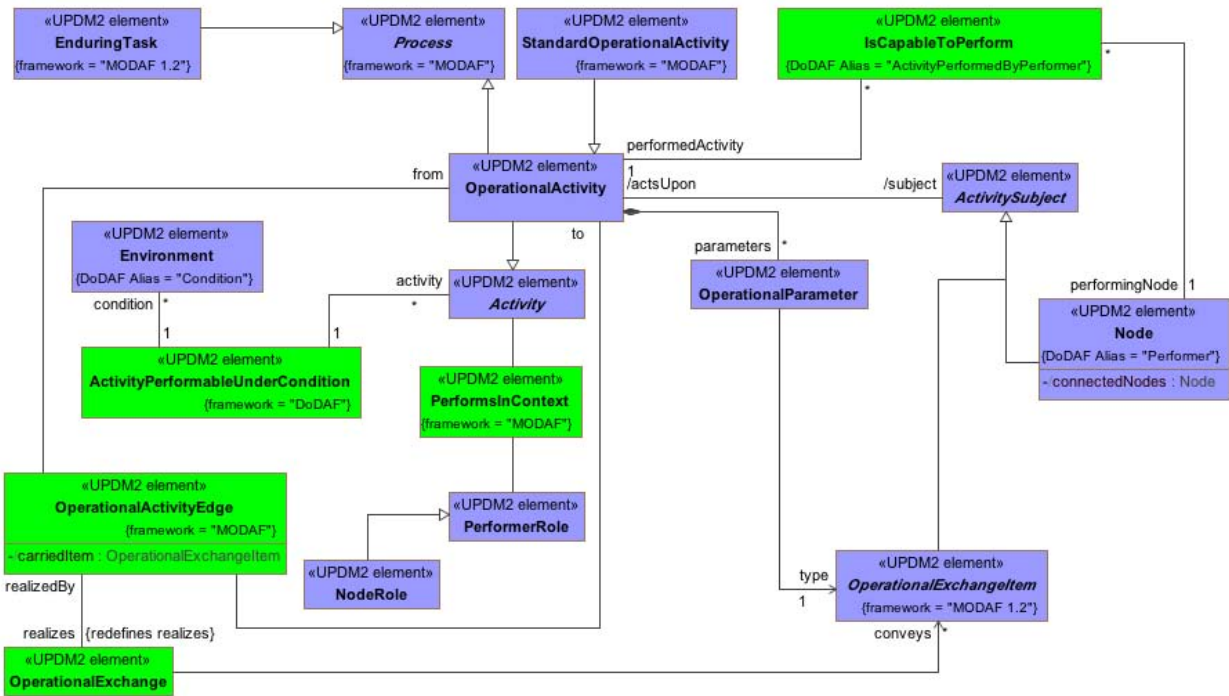

Figure A.11 - OV-5 - DMM

A.3.7 OV-6a - DMM

MODAF: An Operational Rules Model (OV-6a) specifies operational or business rules that are constraints on the way that business is done in the enterprise.

DoDAF: An Operational Rules Model (OV-6a) DoDAF-described View specifies operational or business rules that are constraints on the way that business is done in the enterprise.

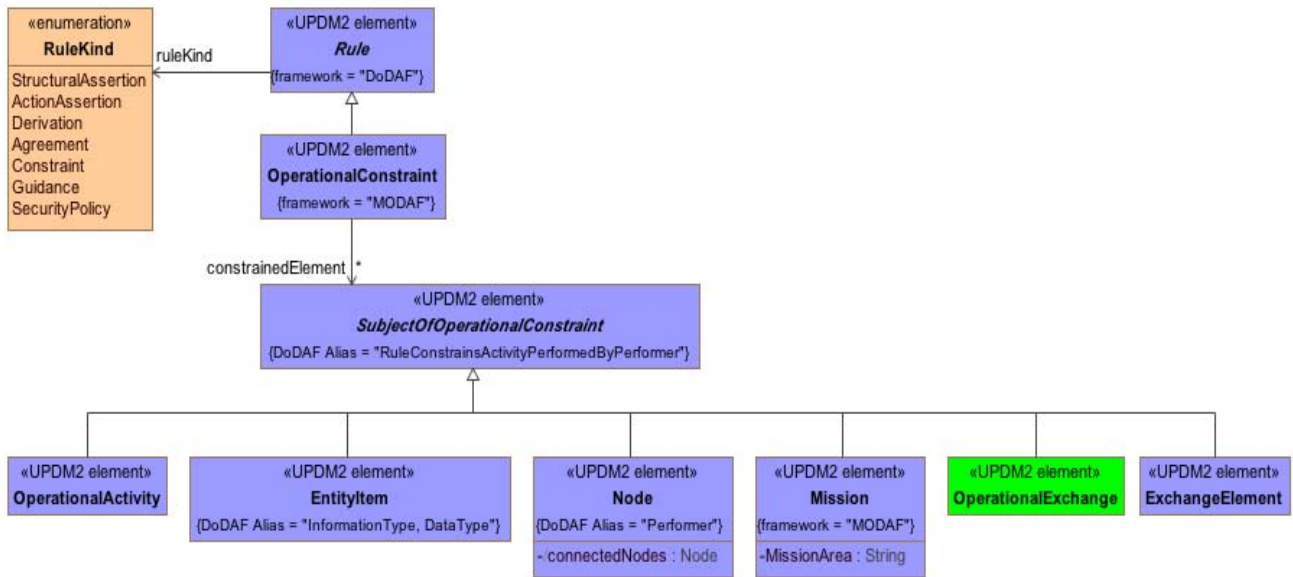

Figure A.12 - OV-6a - DMM

A.3.8 OV-6b - DMM

MODAF: OV-6b: The Operational State Transition Description is a graphical method of describing how an Operational Node or activity responds to various events by changing its state. The diagram represents the sets of events to which the Architecture will respond (by taking an action to move to a new state) as a function of its current state. Each transition specifies an event and an action.

DoDAF: The Operational State Transition Description (OV-6b) DoDAF-described View is a graphical method of describing how an Operational Activity responds to various events by changing its state. The diagram represents the sets of events to which the Architecture will respond (by taking an action to move to a new state) as a function of its current state. Each transition specifies an event and an action.

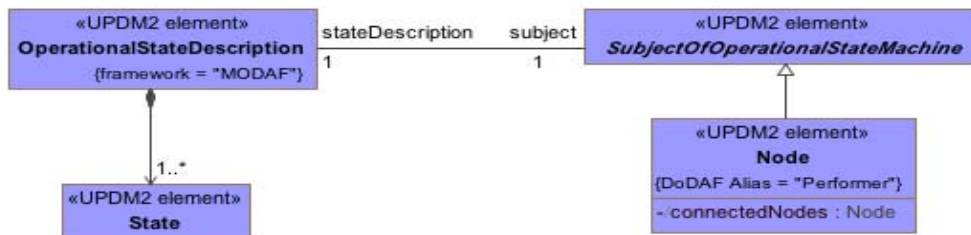

Figure A.13 - OV-6b - DMM

A.3.9 OV-6c - DMM

MODAF: OV-6c: The Operational Event-Trace Description provides a time-ordered examination of the information exchanges between participating Operational Nodes as a result of a particular scenario. Each event-trace diagram will have an accompanying description that defines the particular scenario or situation.

DoDAF: The Operational Event-Trace Description (OV-6c) DoDAF-described View provides a time ordered examination of the resource flows as a result of a particular scenario. Each event-trace diagram will have an accompanying description that defines the particular scenario or situation.

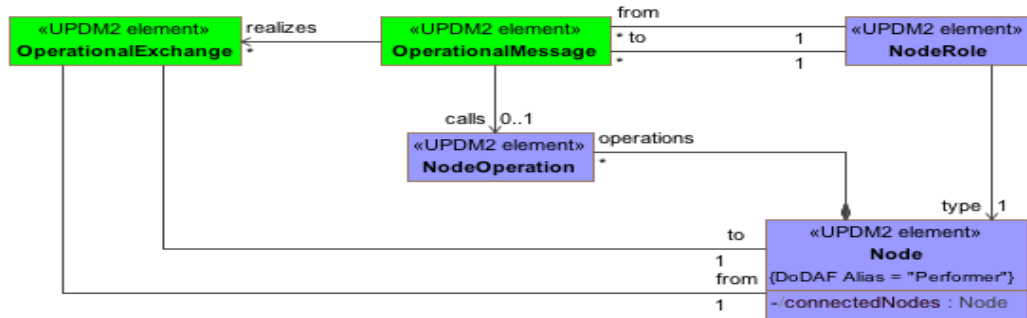

Figure A.14 - OV-6c - DMM

A.3.10 OV-7 - DMM

MODAF: Information Models (OV-7) address the information perspective on an operational architecture.

DoDAF: The Conceptual Data Model (DIV-1), a new DoDAF-described View in DoDAF V2.0, addresses the information concepts at a high-level on an operational architecture.

The Logical Data Model (DIV-2) DoDAF-described View allows analysis of an architecture’s data definition aspect, without consideration of implementation specific or product specific issues.

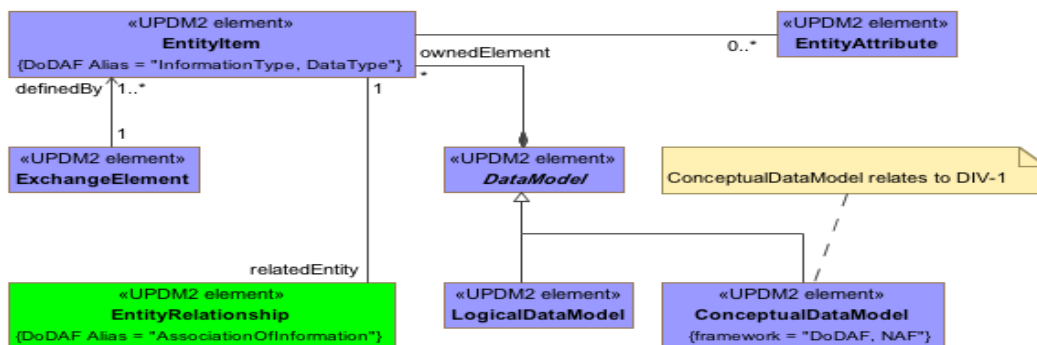

Figure A.15 OV-7/DIV-1/DIV-2 - DMM

A.4 SOV

The Service-Orientated View (SOV) is a description of services needed to directly support the operational domain as described in the OperationalView. A service is described as a unit of work through which a particular Resource provides a useful result to a consuming Resource.

The direction taken by UPDM in modeling services is heavily based on a simplified version of the UPMS profile. Only those elements that are compatible with existing DoDAF/MODAF concepts have been used. A full integration with UPMS will be assessed at a later date.

A.4.1 SOV-1 - DMM

The Service Taxonomy View (SOV-1) specifies a hierarchy of services. The elements in the hierarchy are service specifications (i.e., service interfaces), and the relationships between the elements are specializations (i.e., one Service is a special type of another). Along with SOV-2, it specifies a standard library of Service specifications for an enterprise, which Service implementers are expected to conform to.

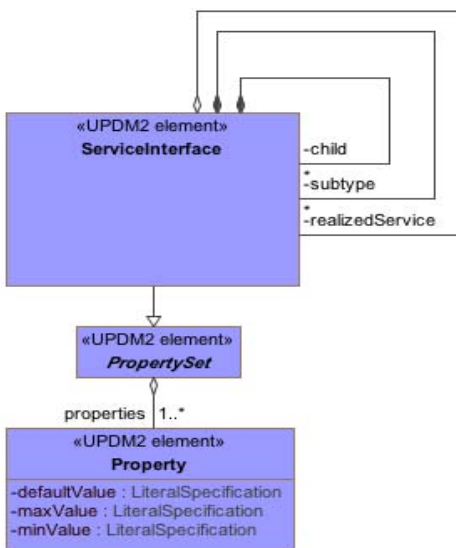

Figure A.16 - SOV-1 - DMM

A.4.2 SOV-2 - DMM

MODAF: The Service Taxonomy View (SOV-1) specifies a hierarchy of services. The elements in the hierarchy are service specifications (rather than service implementations), and the relationships between the elements are specializations (i.e., one Service is a special type of another).

DoDAF: NA

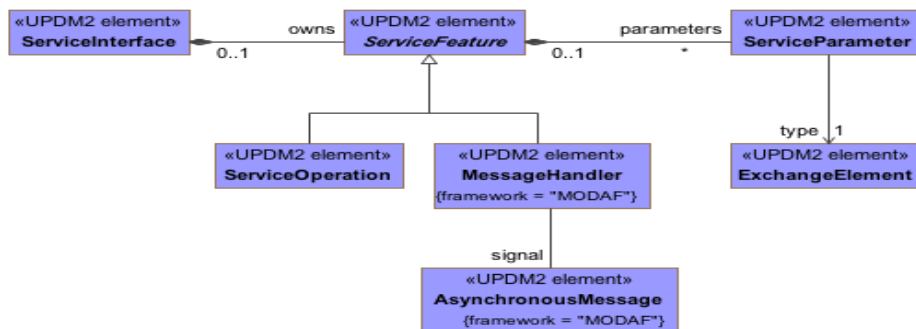

Figure A.17 - SOV-2 - DMM

A.4.3 SOV-3 - DMM

MODAF: The Capability to Service Mapping View (SOV-3) depicts which services contribute to the achievement of a capability.

DoDAF: The Operational Activity to Services Function Traceability Matrix (SvcV-5) DoDAF-described View addresses the linkage between service functions described in SvcV-4 and Operational Activities specified in OV-5.

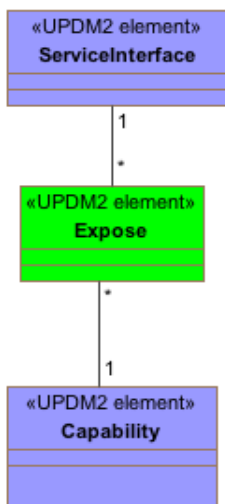

Figure A.18 - SOV-3 - DMM

A.4.4 SOV-4a - DMM

MODAF: The purpose of the Service Constraints View (SOV-4a) is to specify constraints that apply to implementations of services.

DoDAF: The SvcV-10a DoDAF-described View describes constraints on the resources, functions, data, and ports that make up the Service View physical architecture. The constraints are specified in text and may be functional or structural (i.e., non-functional).

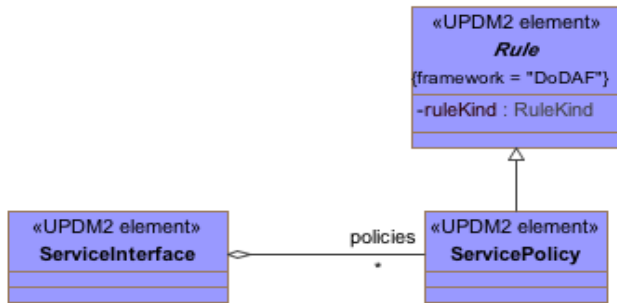

Figure A.19 - SOV-4a - DMM

A.4.5 SOV-4b - DMM

MODAF: The purpose of the Service State Model View (SOV-4b) is to specify the possible states a service may have, and the possible transitions between those states.

DoDAF: The Services State Transition Description DoDAF-described View is a graphical method of describing a resource (or function) response to various events by changing its state. The diagram basically represents the sets of events to which the resources in the Architecture will respond (by taking an action to move to a new state) as a function of its current state. Each transition specifies an event and an action.



Figure A.20 - SOV-4b - DMM

A.4.6 SOV-4c - DMM

The purpose of the Service Interaction Specification View (SOV-4c) is to specify how a service interacts with external agents, and the sequence and dependencies of those interactions. An SOV-4c product does not specify the sequencing of an orchestrated set of services (see OV-6c). Its purpose is to specify the general sequence of interactions that are possible for a given service.

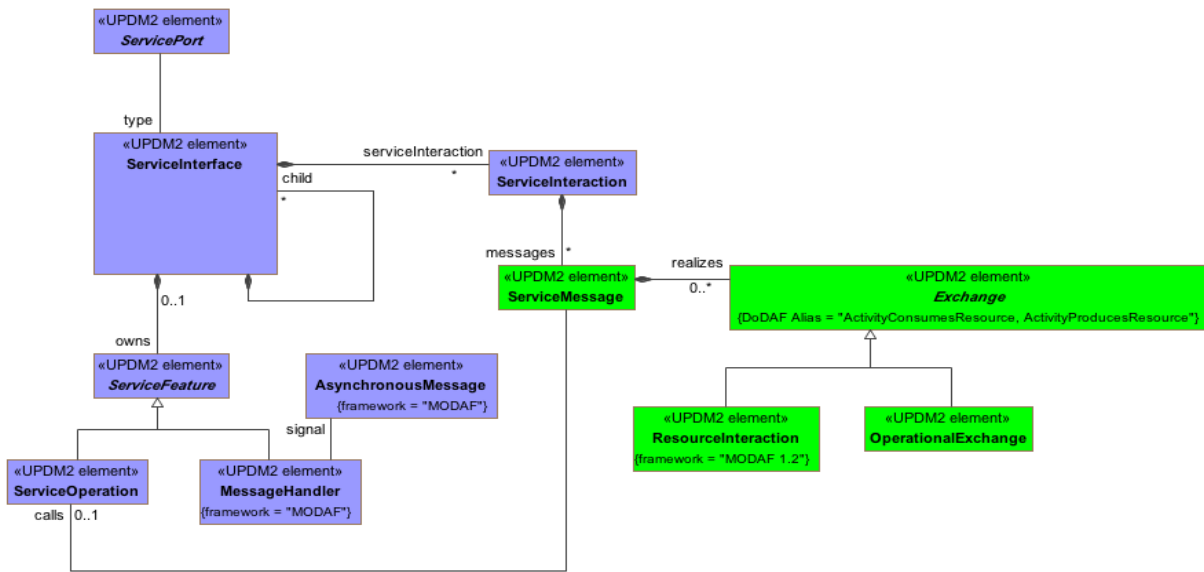

Figure A.21 - SOV-4c - DMM

A.4.7 SOV-5 - DMM

MODAF: The Service Functionality View (SOV-5) defines the behavior of a service in terms of the functions it is expected to perform.

DoDAF: The Services Functionality Description provides detailed information regarding the: Allocation of service functions to resources, and Flow of resources between service functions.

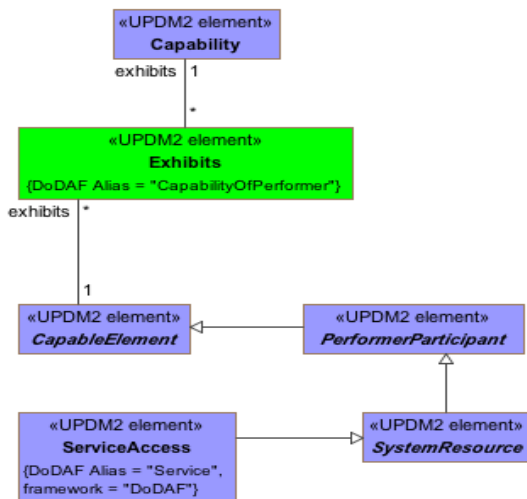

Figure A.22 - SOV-5 - DMM

A.5 StV

The Strategic Elements are used in the Strategic View which provides an overall Enterprise Architecture assessment of the Capabilities and their relationships facilitating Capability Management (e.g., capability introduction, integration, re-alignment and removal). While an Enterprise will have a number of UPDM Architecture Descriptions that have the Operational, System, Technical Standards, and All Views, only one Strategic View will exist across a number of Architecture Descriptions.

A.5.1 CV-7 - DMM

MODAF: NA

DoDAF: CV-7 details the mapping between DoDAF services (ServiceAccess) and the Capability that they realize.

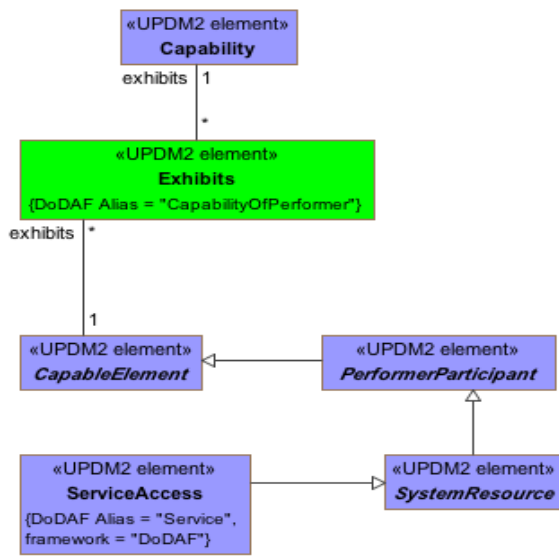

Figure A.23 - CV-7 - DMM

A.5.2 StV-1 - DMM

MODAF: StV-1 addresses the enterprise concerns associated with the overall vision for transformational endeavors and thus defines the strategic context for a group of Enterprise capabilities.

DoDAF: CV-1: Vision: addresses the enterprise concerns associated with the overall vision for transformational endeavors and thus defines the strategic context for a group of capabilities.

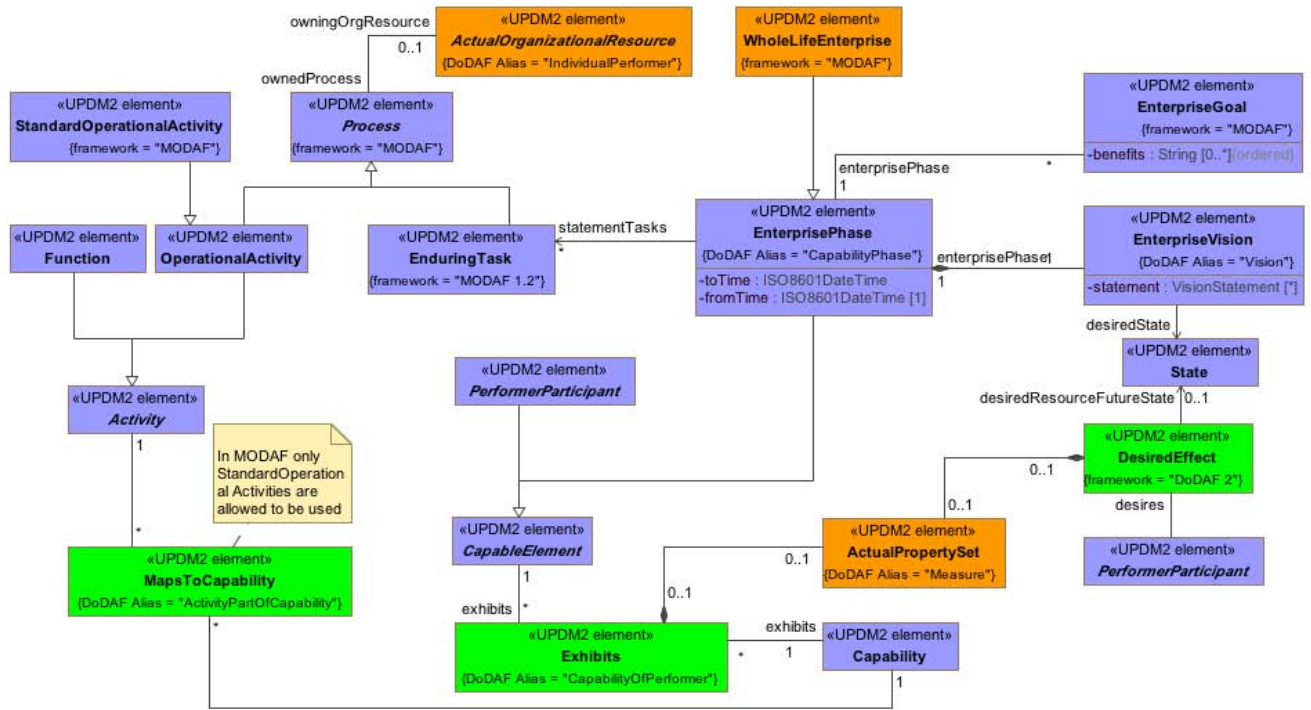

Figure A.24 - StV-1/CV-1 - DMM

A.5.3 StV-2 - DMM

MODAF: The StV-2 Product models capability taxonomies.

DoDAF: The CV-2 DoDAF-described View models capability taxonomies.

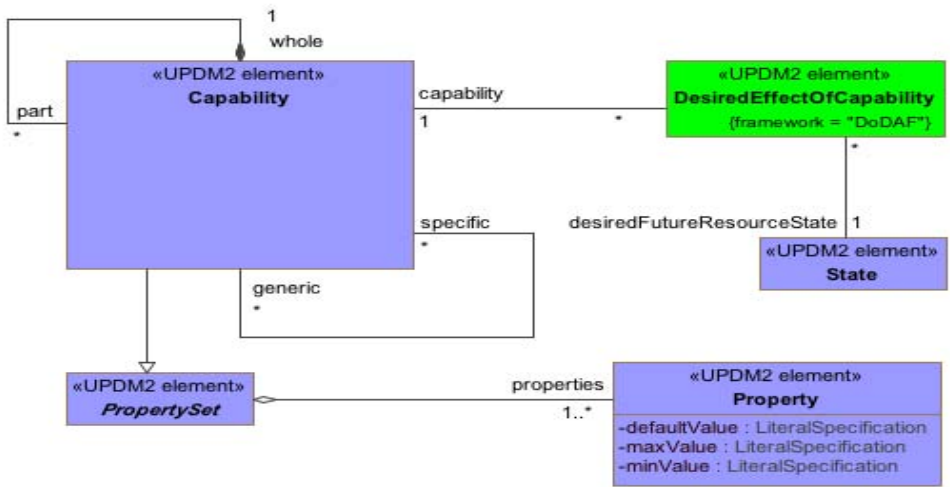

Figure A.25 - StV-2/CV-2 - DMM

A.5.4 StV-3 - DMM

MODAF: StV-3 addresses the planned achievement of capability at different points in time or during specific periods of time, i.e. capability phasing.

DoDAF: CV-3: Capability Phasing The CV-3 addresses the planned achievement of capability at different points in time or during specific periods of time, i.e., capability phasing.

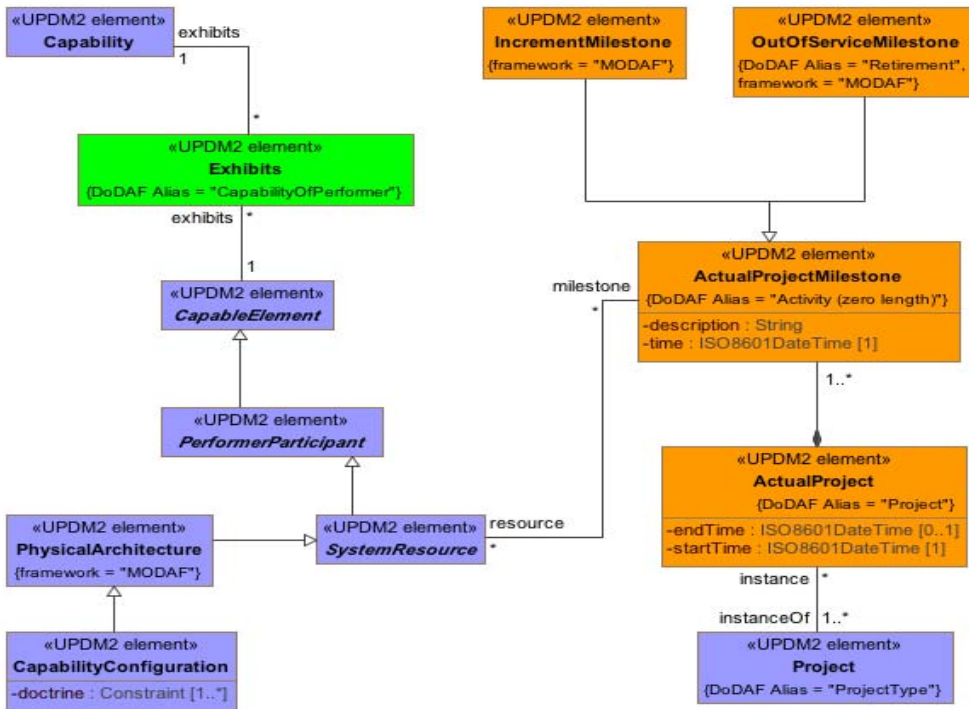

Figure A.26 - StV-3/ CV-3 - DMM

A.5.5 StV-4 - DMM

MODAF: The StV-4 Product describes the dependencies between planned capabilities. It also defines logical groupings of capabilities (capability clusters).

DoDAF: CV-4: Capability Dependencies: The CV-4 DoDAF-described View describes the dependencies between planned capabilities. It also defines logical groupings of capabilities.

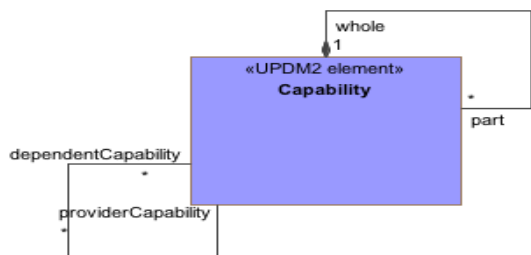

Figure A.27 - StV-4/CV-4 - DMM

A.5.6 StV-5 - DMM

MODAF: StV-5 addresses the fulfilment of capability requirements, in particular by network enabled capabilities.

DoDAF: CV-5: Capability to Organizational Development Mapping: The CV-5 addresses the fulfillment of capability requirements.

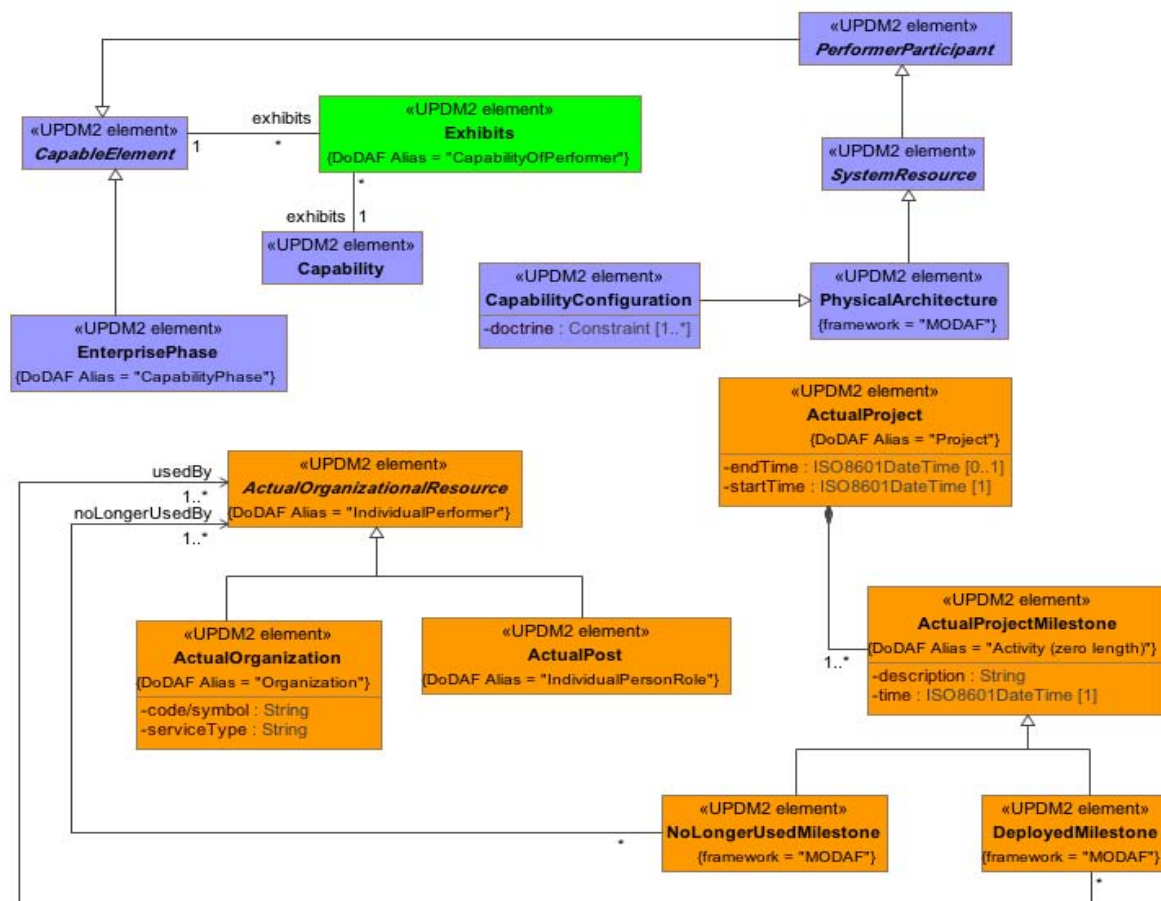

Figure A.28 - StV-5/CV-5 - DMM

A.5.7 StV-6 - DMM

MODAF: The StV-6 Product describes the mapping between the capabilities required by an Enterprise and the operational activities that those capabilities support.

DoDAF: CV-6: Capability to Operational Activities Mapping: The CV-6 DoDAF-described View describes the mapping between the capabilities required and the operational activities that those capabilities support.

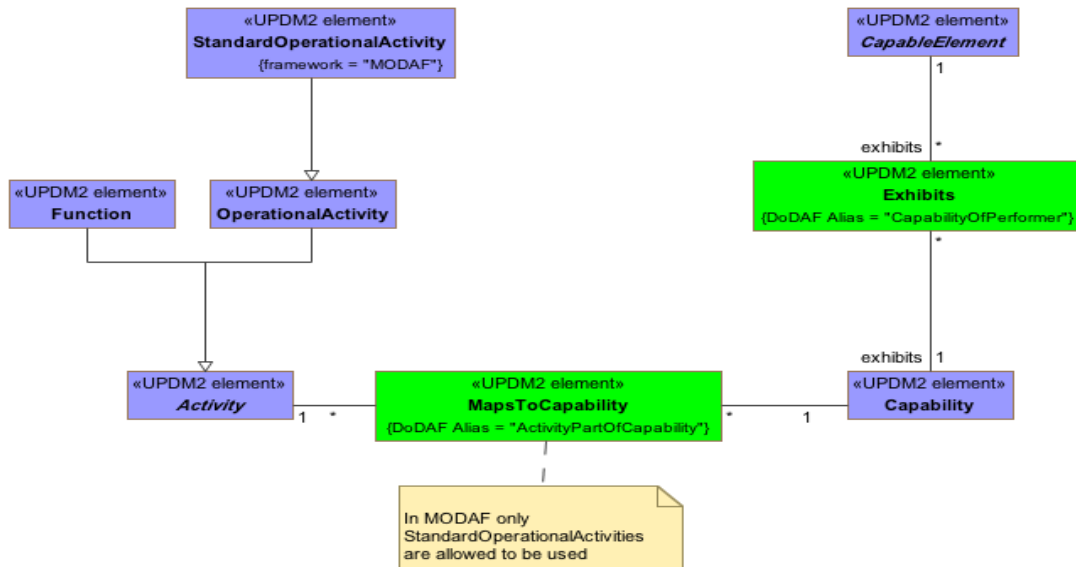

Figure A.29 - StV-6/CV-6 - DMM

A.6 SV

Models in the System Viewpoint represent alternate realizations in terms of equipment capability of the operational capabilities expressed through models in the Operational Viewpoint and in the User Requirements. The System Viewpoint primarily addresses the specification of the system capability needed (rather than implementation details). Significant changes originally made in MODAF improved the ability for modelers to represent configuration of capability that include people as well as systems and platforms.

A.6.1 SV-1/SvcV-1 - DMM

MODAF: Resource Interaction Specification (SV-1) address the composition and interaction of resources. From MODAF v1.1, SV-1 incorporates the human elements - Posts, Organizations, and Roles.

DoDAF: The Systems Interface Description (SV-1) DoDAF-described View addresses the composition and interaction of Systems. For DoDAF v2.0, the SV-1 incorporates the human elements as types of Performers - Organizations and Personnel Types.

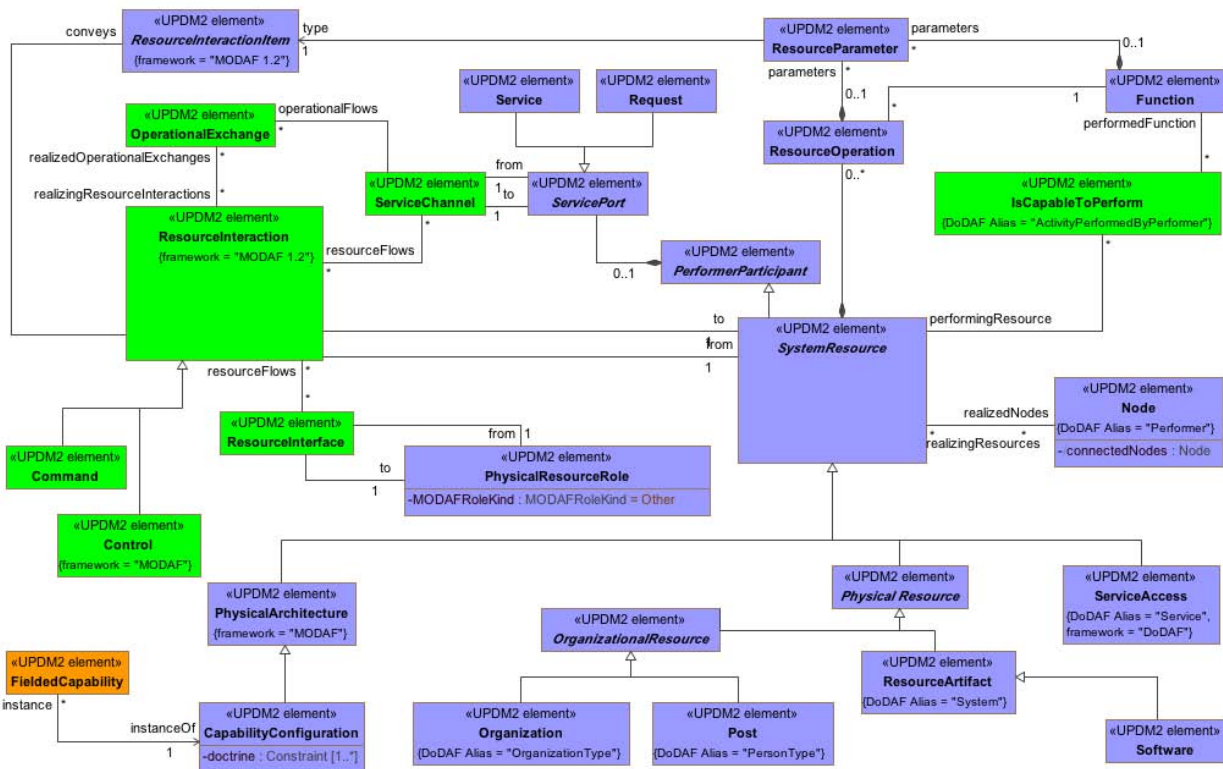

Figure A.30 - SV-1/SvcV-1 - DMM

A.6.2 SV-10a/SvcV-10a - DMM

MODAF: The purpose of this Product is to specify functional and non-functional constraints on the implementation aspects of the architecture (i.e. the structural and behavioral elements of the SV viewpoint).

DoDAF: The SV-10a Systems Rules Model DoDAF-described View describes constraints on the resources, functions, data, and ports that make up the SV physical architecture. The constraints are specified in text and may be functional or structural (i.e., non-functional).

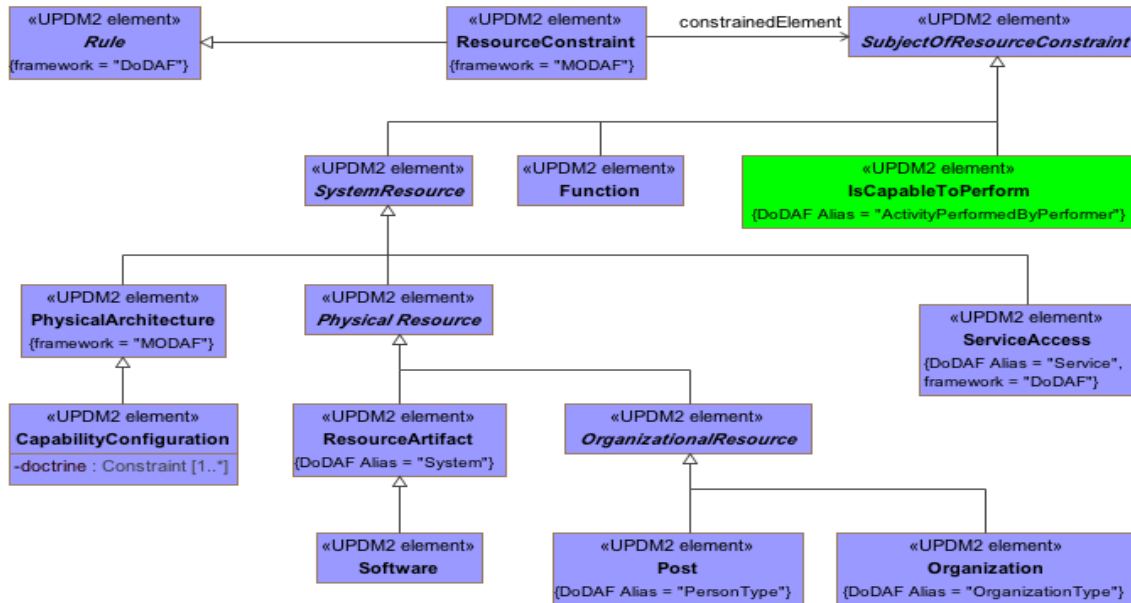

Figure A.31 - SV-10a/SvcV-10a - DMM

A.6.3 SV-10b/SvcV-10b - DMM

MODAF: The Resource State Transition Description is a graphical method of describing a resource (or function) response to various events by changing its state. The diagram basically represents the sets of events to which the Resources in the Architecture will respond (by taking an action to move to a new state) as a function of its current state. Each transition specifies an event and an action.

DoDAF: The Systems State Transition Description DoDAF-described View is a graphical method of describing a resource (or system function) response to various events by changing its state. The diagram basically represents the sets of events to which the resources in the Architecture will respond (by taking an action to move to a new state) as a function of its current state. Each transition specifies an event and an action.

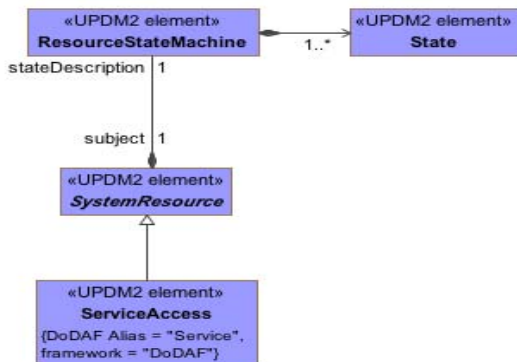

Figure A.32 - SV-10b/SvcV-10b - DMM

A.6.4 SV-10c/SvcV-10c - DMM

MODAF: The Resource Event-Trace Description provides a time-ordered examination of the interactions between resources. Each event-trace diagram will have an accompanying description that defines the particular scenario or situation.

DoDAF: The Systems Event-Trace Description provides a time-ordered examination of the interactions between functional resources. Each event-trace diagram will have an accompanying description that defines the particular scenario or situation.

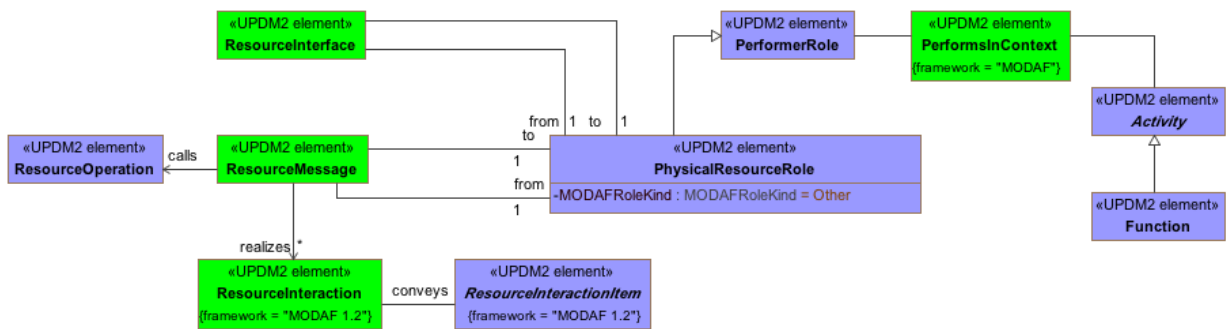

Figure A.33 - SV-10c/SvcV-10c - DMM

A.6.5 SV-11/DIV-3 - DMM

MODAF: The SV-11 View defines the structure of the various kinds of system data that are utilized by the systems in the Architecture.

DoDAF: The DIV-3 Physical Data Model DoDAF-described view defines the structure of the various kinds of system or service data that are utilized by the systems or services in the Architecture.

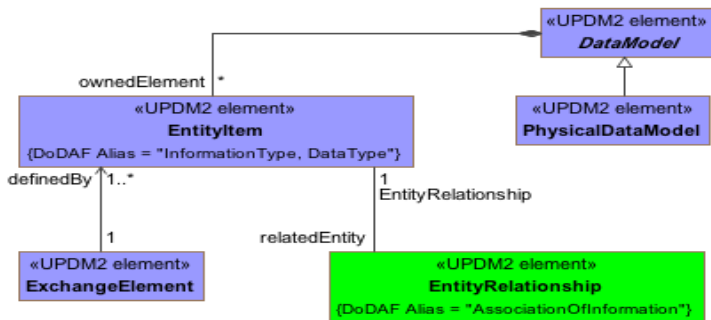

Figure A.34 - SV-11 - DMM

A.6.6 SV-12 - DMM

MODAF: The Service Provision View (SV-12) specifies configurations of resources that can deliver a service, and the levels of service those resources can deliver in different environments.

DoDAF: NA

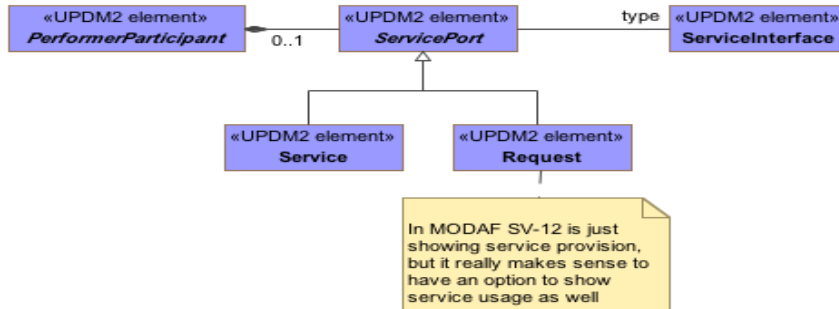

Figure A.35 - SV-12 - DMM

A.6.7 SV-2/SvcV-2 - DMM

MODAF: The Systems Communications Description (SV-2a/2b/2c) series of views is intended for the representation of communications networks and pathways that link communications systems, and provides details regarding their configuration.

DoDAF: A Systems Resource Flow Description (SV-2) DoDAF-described View specifies the resource flows between Systems and may also list the protocol stacks used in connections.

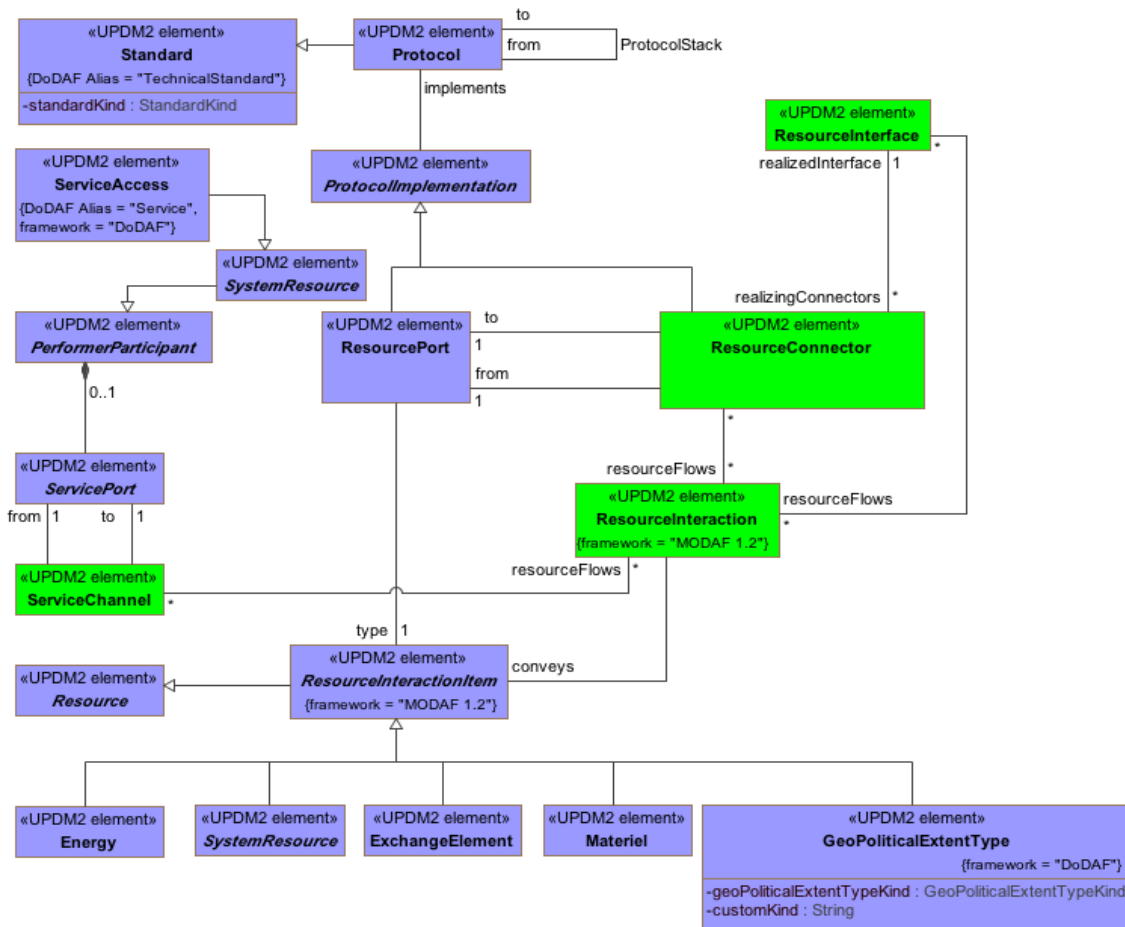

Figure A.36 - SV-2/SvcV-2 - DMM

A.6.8 SV-3/SvcV-3a/SvcV-3b - DMM

MODAF: The Resource Interaction Matrix provides a tabular summary of the resource interactions specified in the SV-1 for the Architecture.

DoDAF: The Systems - Systems Matrix (SV-3) DoDAF-described View provides a tabular summary of the system interactions specified in the SV-1 for the Architecture.

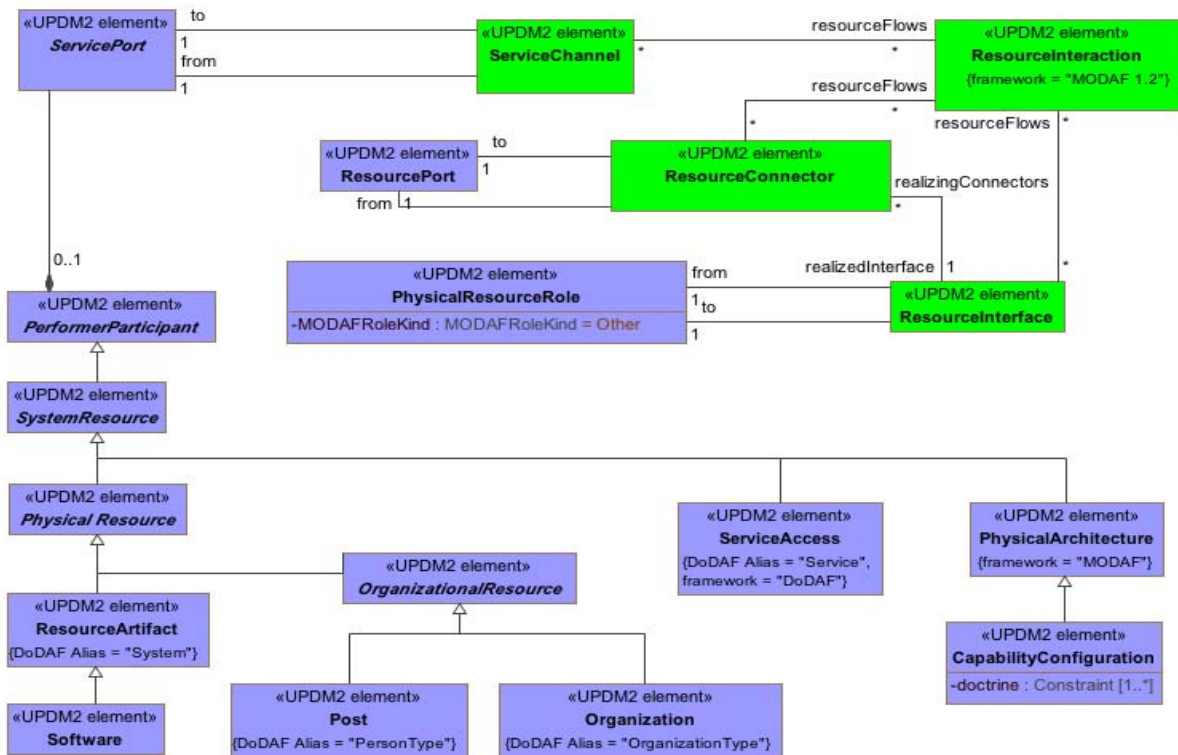

Figure A.37 - SV-3/SvcV-3a/SvcV-3b - DMM

A.6.9 SV-4/SvcV-4 - DMM

MODAF: Functionality Descriptions (SV-4) address human and system functionality.

DoDAF: The Systems Functionality Description (SV-4) DoDAF-described View addresses human and system functionality.

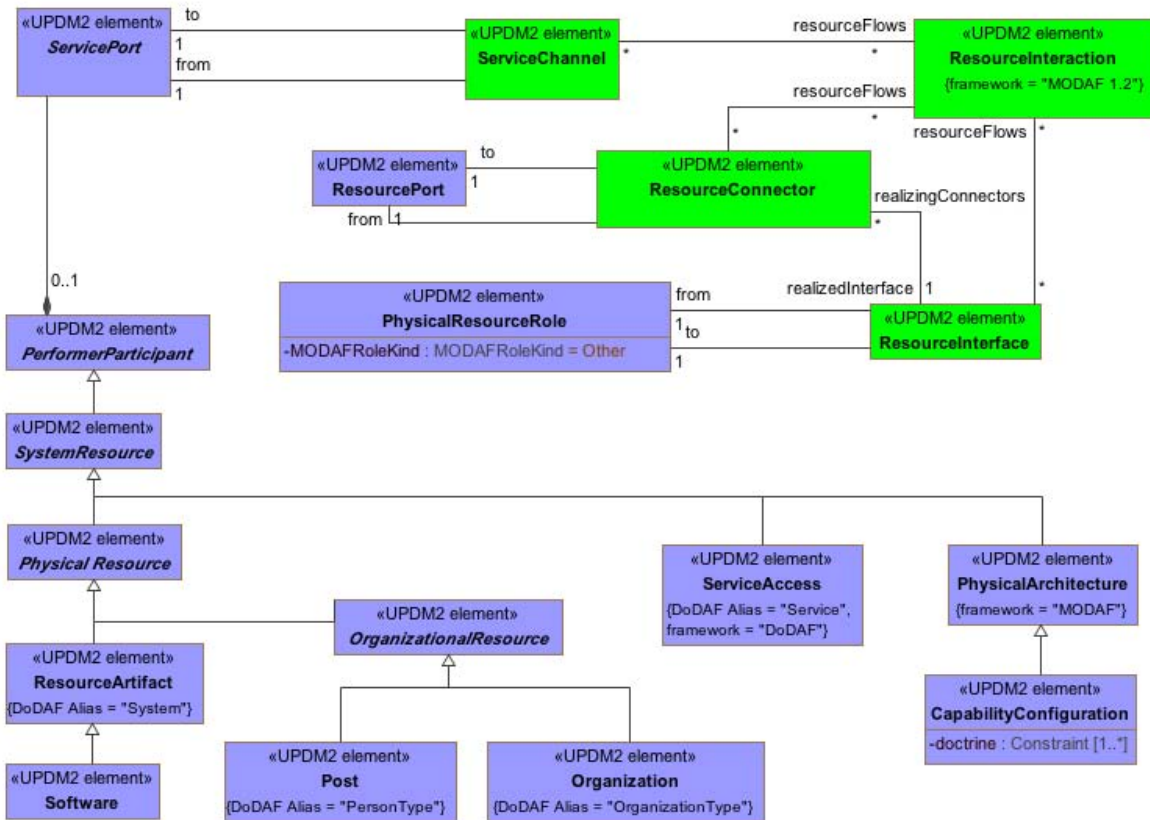

Figure A.38 - SV-4/SvcV-4 - DMM

A.6.10 SV-5/SvcV-5 - DMM

MODAF: SV-5 shows the Functions that are implement the behavior of the OperationalActivities

DoDAF: SV-5/ScvV Shows the SystemFunctions and Service that implement the behavior of the OperationalActivities.

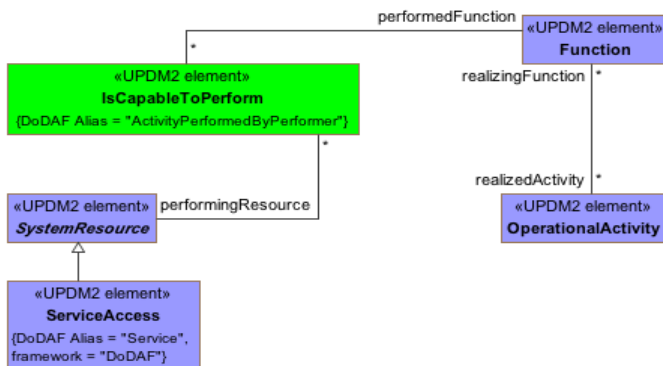

Figure A.39 - SV-5/SvcV-5 - DMM

A.6.11 SV-6 /SvcV-6 - DMM

MODAF: The Systems Data Exchange Matrix specifies the characteristics of the system data exchanged between systems. The focus is on data crossing the system boundary.

DoDAF: The Systems Resource Flow Exchange Matrix DoDAF-described View specifies the characteristics of the system resource flows exchanged between systems. The focus is on resource crossing the system boundary.

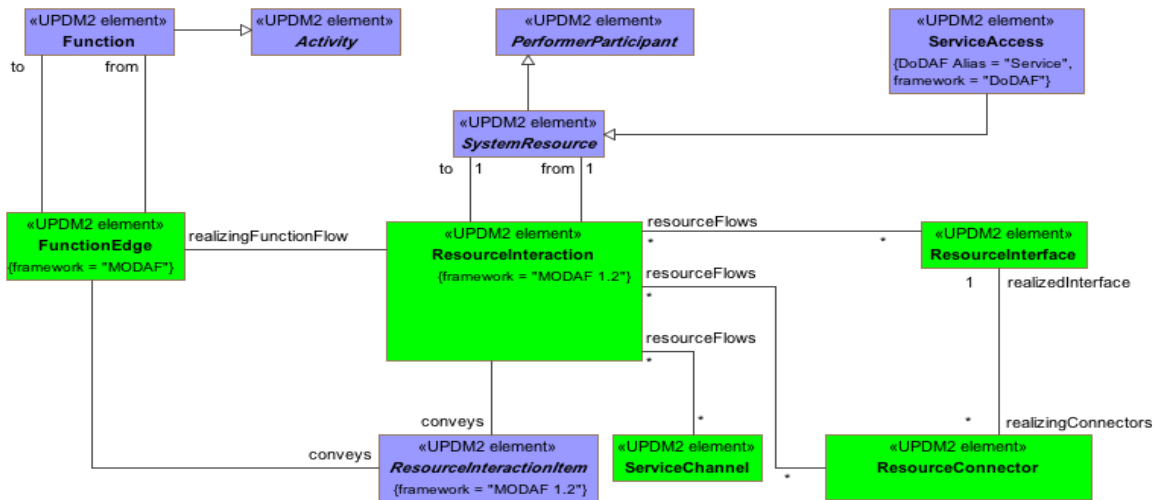

Figure A.40 - SV-6/SvcV-6 - DMM

A.6.12 SV-7/SvcV-7 - DMM

MODAF: The SV-7 is the Resource Performance Parameters Matrix and depicts the performance characteristics of a Resource (e.g., system, role or capability configuration).

DoDAF: The SV-7 DoDAF-described View is the Systems Measures Matrix and depicts the measures (metrics) of resources.

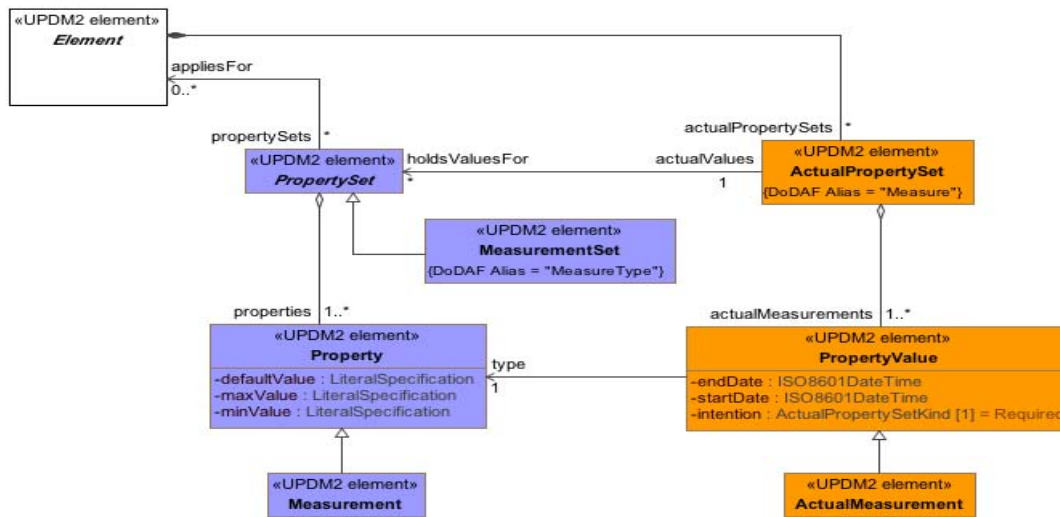

Figure A.41 - SV-7/SvcV-7 - DMM

A.6.13 SV-8/SvcV-8 - DMM

MODAF: The SV-8 provides an overview of how a capability configuration structure changes over time. It shows the structure of several capability configurations mapped against a timeline.

DoDAF: The Systems Evolution Description DoDAF-described View presents a whole lifecycle view of resources (systems), describing how it changes over time. It shows the structure of several resources mapped against a timeline.

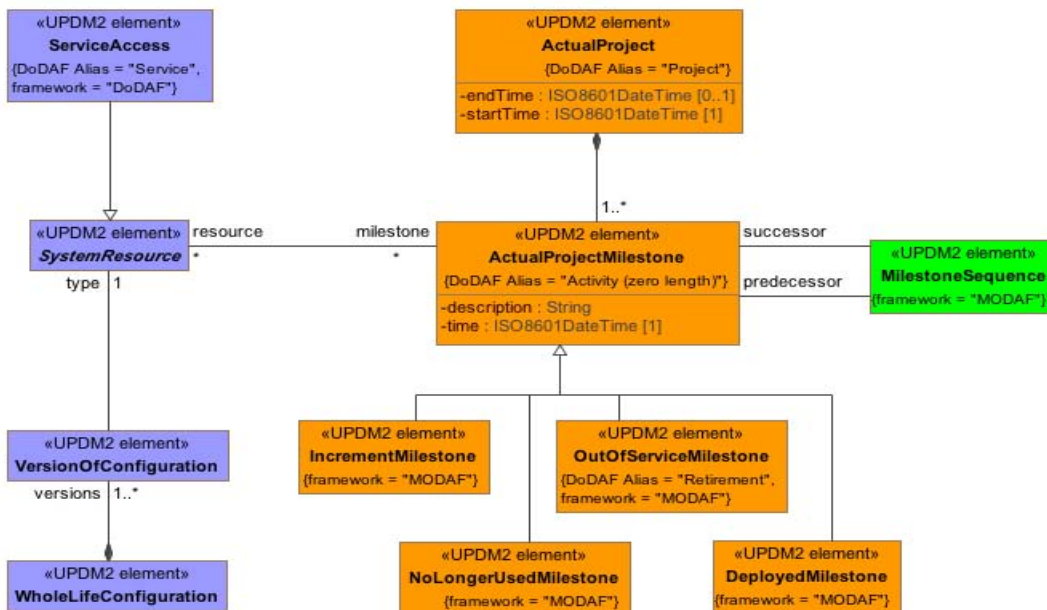

Figure A.42 - SV-8/SvcV-8 - DMM

A.6.14 SV-9/SvcV-9 - DMM

MODAF: The Technology & Skills Forecast defines the underlying current and expected supporting technologies and skills. Expected supporting technologies and skills are those that can be reasonably forecast given the current state of technology and skills, and expected improvements / trends. New technologies and skills will be tied to specific time periods, which can correlate against the time periods used in SV-8 milestones and linked to Enterprise Phases.

DoDAF: The Technology & Skills Forecast defines the underlying current and expected supporting technologies and skills. Expected supporting technologies and skills are those that can be reasonably forecast given the current state of technology and skills, and expected improvements / trends. New technologies and skills will be tied to specific time periods, which can correlate against the time periods used in SV-8 milestones and linked to Enterprise Phases.

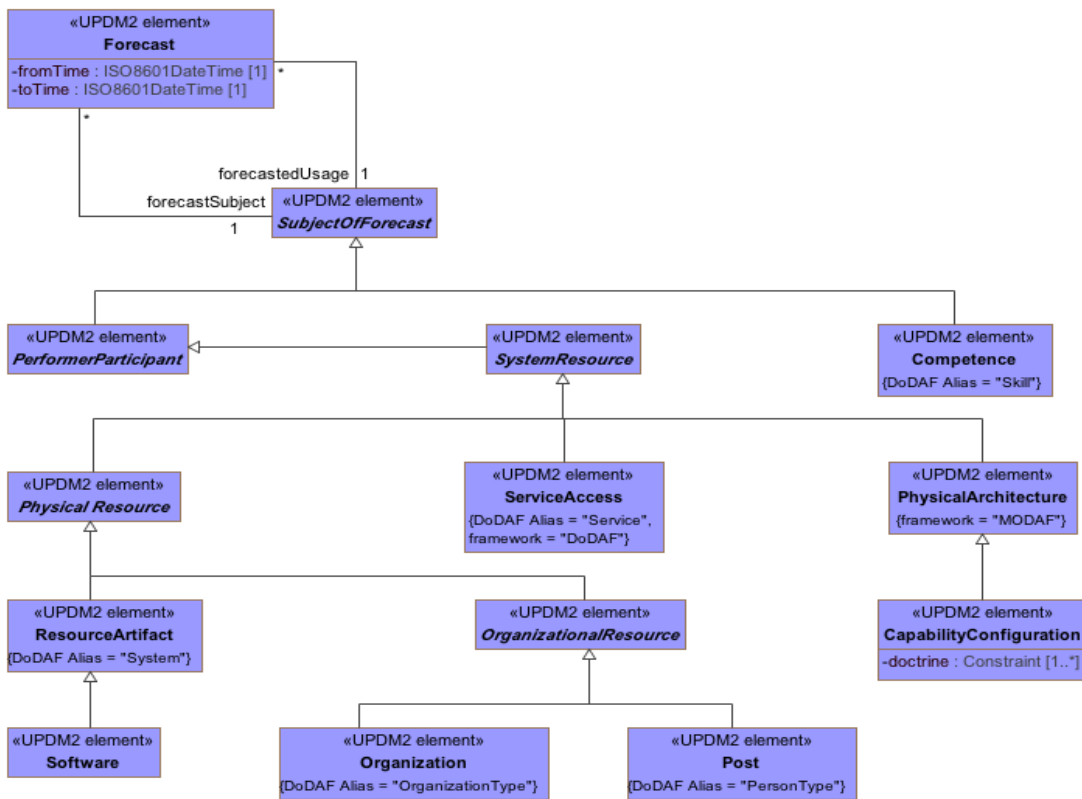

Figure A.43 - SV-9/SvcV-9 - DMM

A.7 TV - DMM

The Technical View is a set of products delineating standards, rules, notations, and conventions that apply to the implementation of the system architecture. When the standards profile is tied to the system elements to which they apply, TV-1 serves as the bridge between the SV and TV. SV-9 forecasts relate to the TV-1 in that a timed technology forecast may contribute to the decision to retire or phase out the use of a certain standard in connection with a system element. Similarly, SV-9 forecasts relate to TV-2 standards forecasts in that a certain standard may be adopted depending on a certain technology becoming available (e.g., the availability of Java Script may influence the decision to adopt a new HTML standard).

MODAF extends the core DoDAF Technical Standards Views to include non-technical standards and policies applicable to the architecture such as operational doctrine, industry process standards, etc. Additionally, the TV-1 may also document policies and standards applicable to the operational or business context. MODAF also distinguishes between “applicability” and “conformance” with regard to architectural elements. If a standard is applicable to a given architecture, that architecture need not be fully conformant with the standard. The degree of conformance to a given standard may be judged on a risk basis at an approval point. An association between a Standard and an architectural element is not to be interpreted as stating the level of compliance of the element is fully compliant with that Standard. Additional evidences would need to be given (outside MODAF) to confirm the level of compliance. Finally, MODAF adds the explicit requirement that any Standards cited in TV-1 View must, where appropriate, be in accordance with the trend towards open architectures (i.e., standards which encourage stove-piped systems are expressly prohibited).

A.7.1 TV-1&2&3 - DMM

MODAF: Standards Profile (TV-1) defines the technical and non-technical standards, guidance, and policy applicable to the architecture.

The Standards Forecast (TV-2) contains expected changes in technology-related standards and conventions, which are documented in the TV-1 Product.

DoDAF: The Standards Profile StdV-1 DoDAF-described View defines the technical, operational, and business standards, guidance and policy applicable to the architecture.

The StdV-2 Standards Forecast DoDAF-described View contains expected changes in technology related standards, operational standards, or business standards and conventions, which are documented in the StdV-1 view.

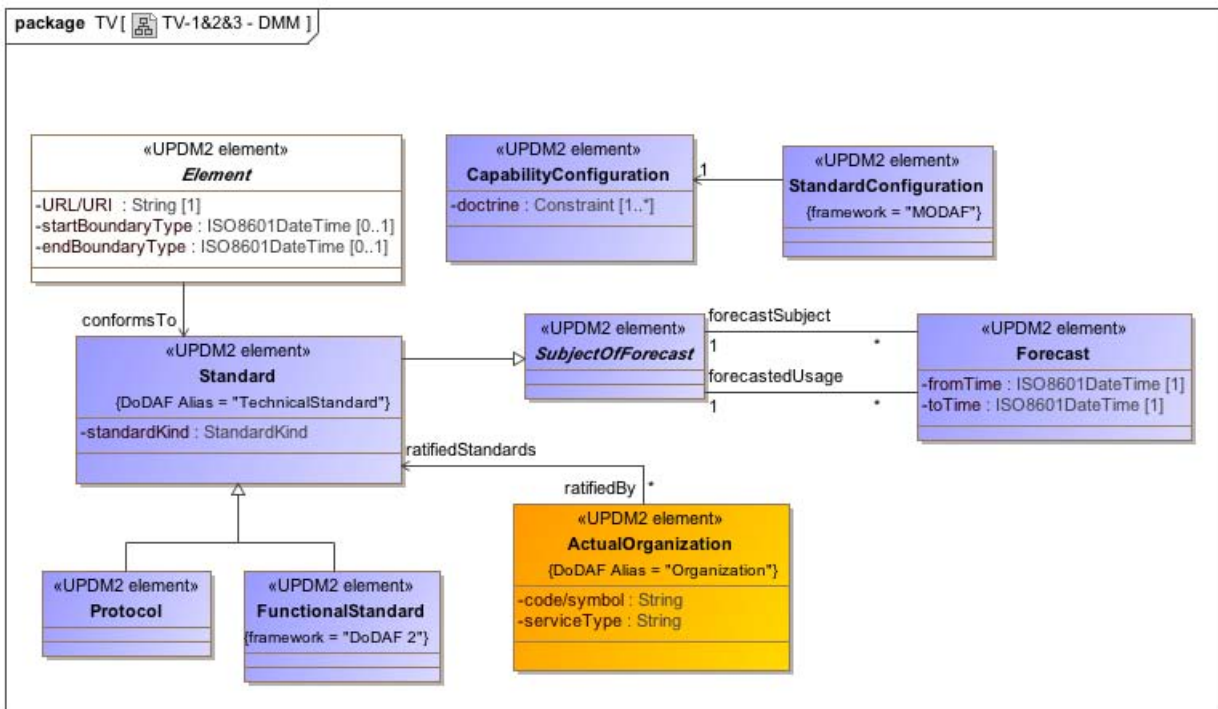

Figure A.44 - TV-1&2&3 - DMM

A.8 SOPES

This section shows the UPDM elements and relationships that are used to represent the SOPES metamodel in UPDM.

A.8.1 SOPES - DMM

The SOPES diagram shows the UPDM elements and the relationships that map to the concepts of the SOPES Metamodel.

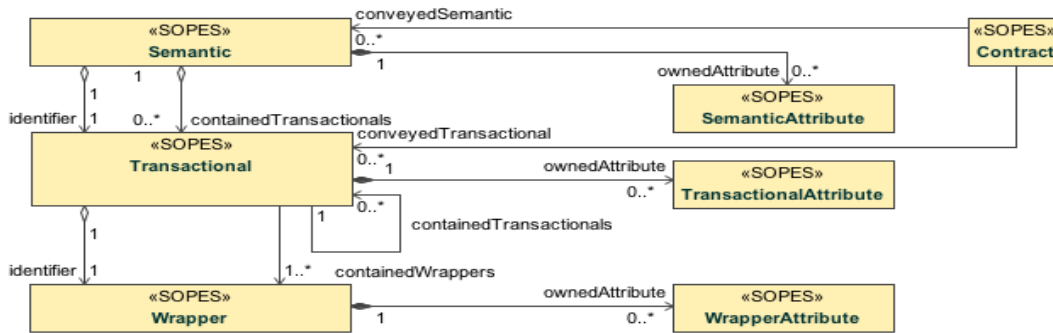

Figure A.45 - SOPES - DMM

A.9 SwAF

This section shows the UPDM elements and relationships that are used to represent the Design Rules metamodel from NISP as submitted by Swedish Armed Forces (SWAF).

A.9.1 Design Rule - DMM

The Design Rule diagram shows the UPDM elements and the relationships that map to the concepts of the Design Rules metamodel from NISP as submitted by Swedish Armed Forces (SWAF).

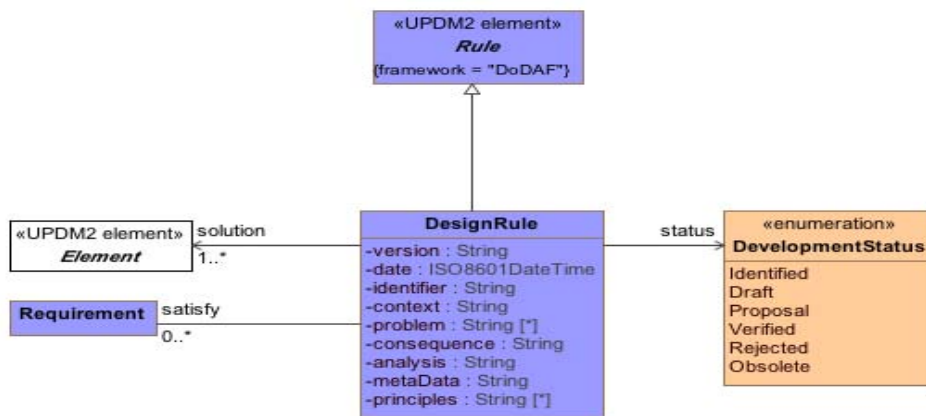

Figure A.46 - Design Rule - DMM

A.10 DM2

The DM2 section gathers together UPDM Domain Meta Model elements and relationships into the same groupings of as detailed in the DoDAF 2.0.2 metamodel.

A.10.1 Activity - DM2

The Activity diagram shows the UPDM elements and the relationships that map to the concepts of Activity from the DoDAF 2.0.2 Metamodel.

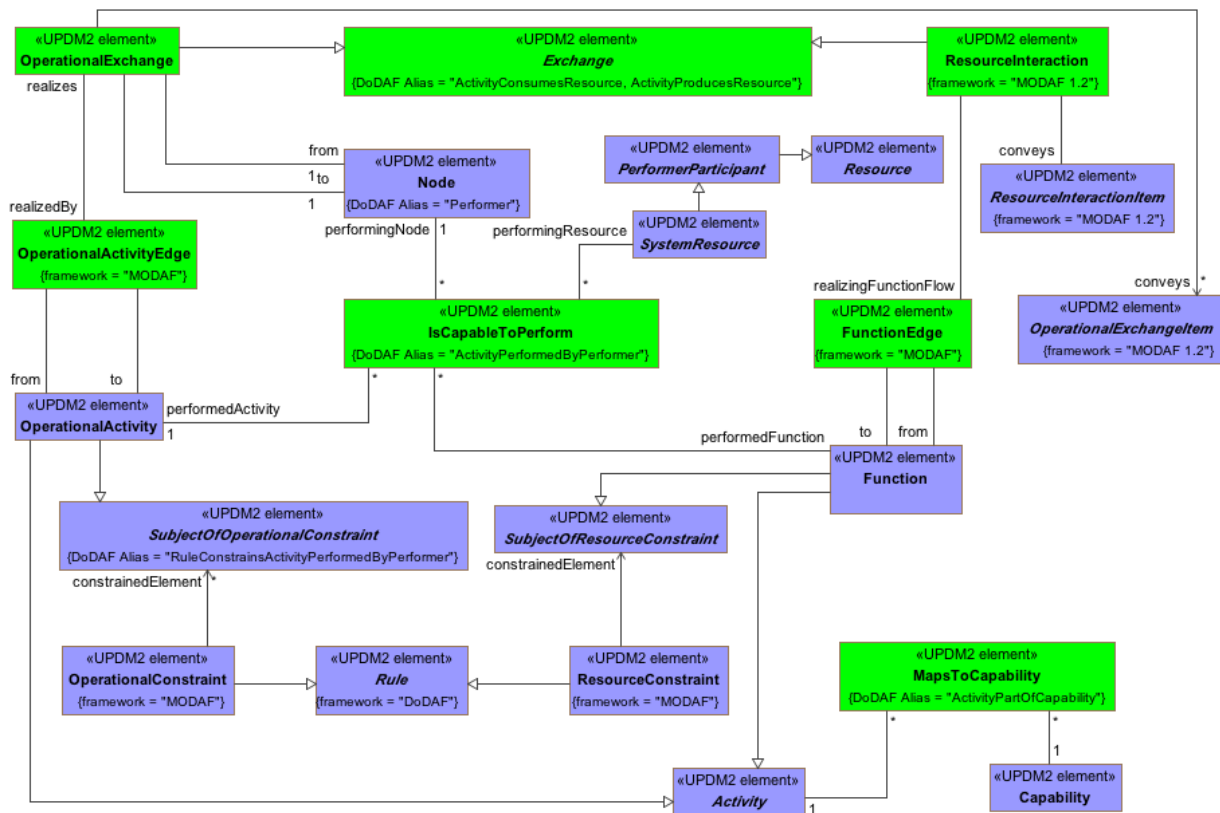

Figure A.47 - Activity - DM2

A.10.2 Capability - DM2

The Capability diagram shows the UPDM elements and the relationships that map to the concepts of Capability from the DoDAF 2.0.2 Metamodel.

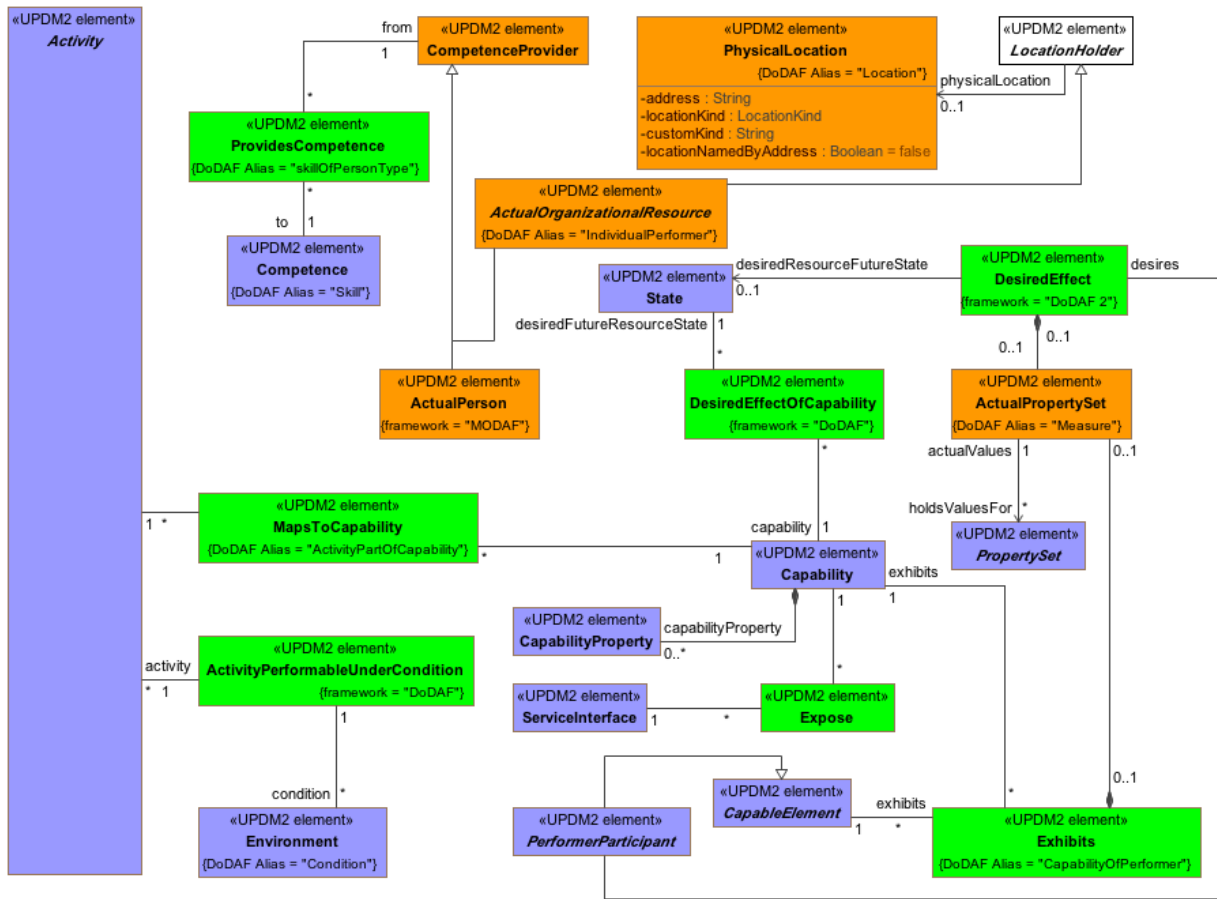

Figure A.48 - Capability - DM2

A.10.3 Goals - DM2

The Goals diagram shows the UPDM elements and the relationships that map to the concepts of Goals from the DoDAF 2.0.2 Metamodel.

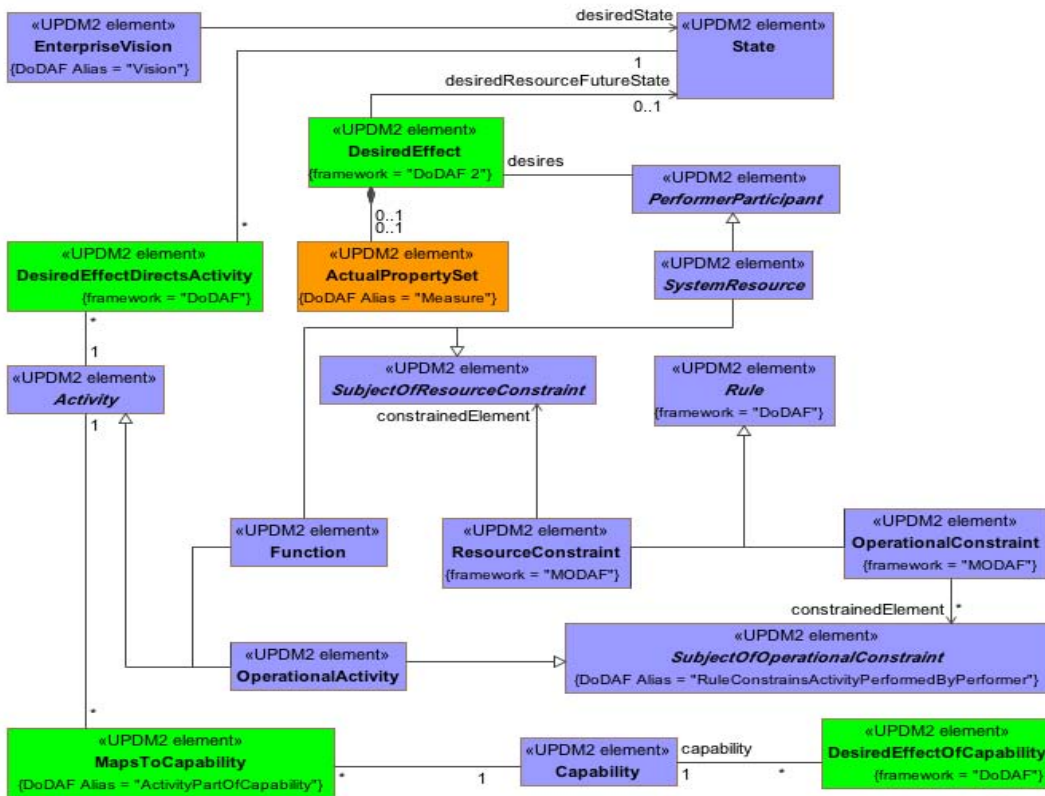

Figure A.49 - Goals - DM2

A.10.4 Information and Data - DM2

The Information and Data diagram shows the UPDM elements and the relationships that map to the concepts of Information and Data from the DoDAF 2.0.2 Metamodel.

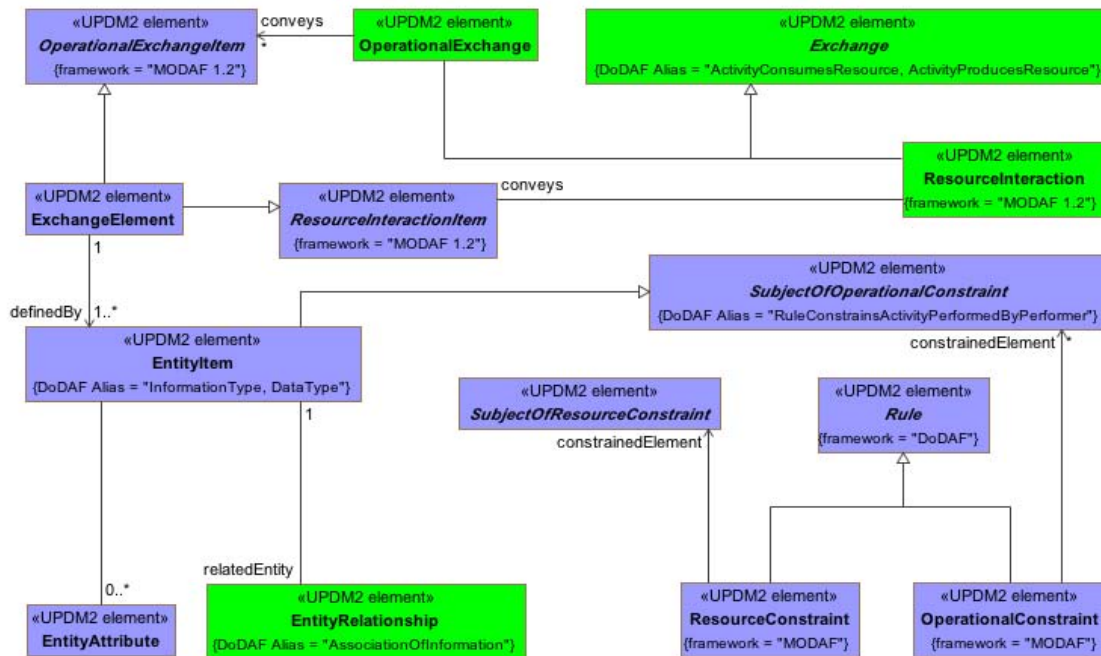

Figure A.50 - Information and Data - DM2

A.10.5 Information Pedigree - DM2

The Information Pedigree diagram shows the UPDM elements and the relationships that map to the concepts of Information Pedigree from the DoDAF 2.0.2 Metamodel.

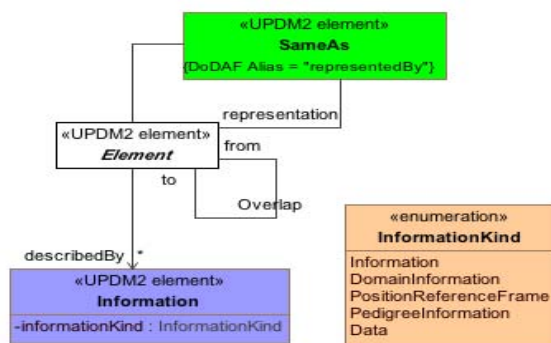

Figure A.51 - Information Pedigree - DM2

A.10.6 Location - DM2

The Location diagram shows the UPDM elements and the relationships that map to the concepts of Location from the DoDAF 2.0.2 Metamodel.

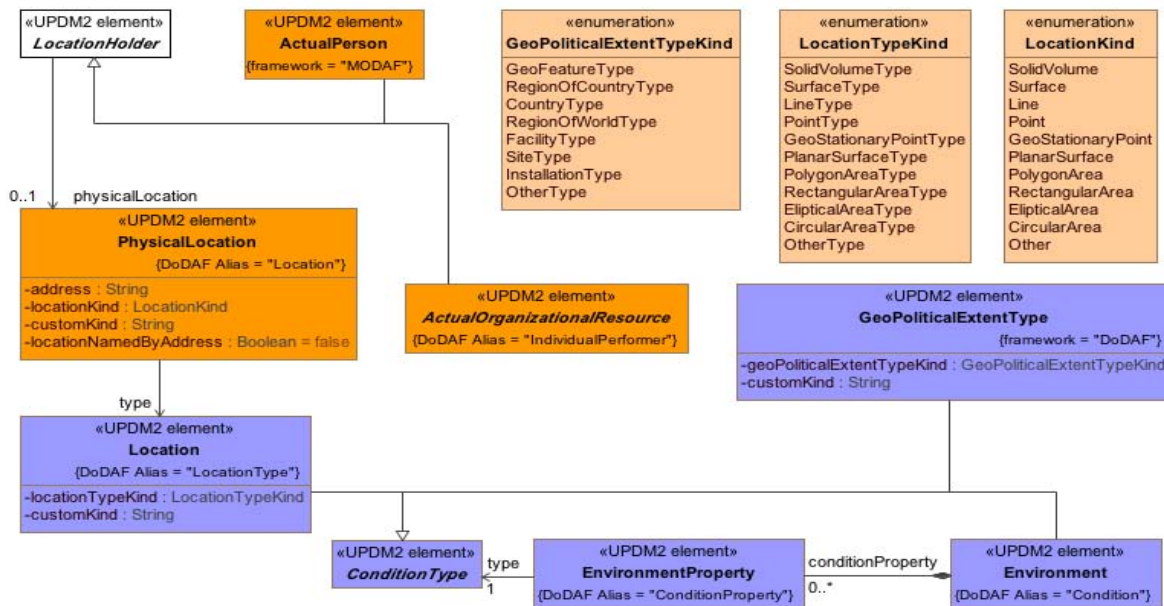

Figure A.52 - Location - DM2

A.10.7 Measure - DM2

The Measure diagram shows the UPDM elements and the relationships that map to the concepts of Measure from the DoDAF 2.0.2 Metamodel.

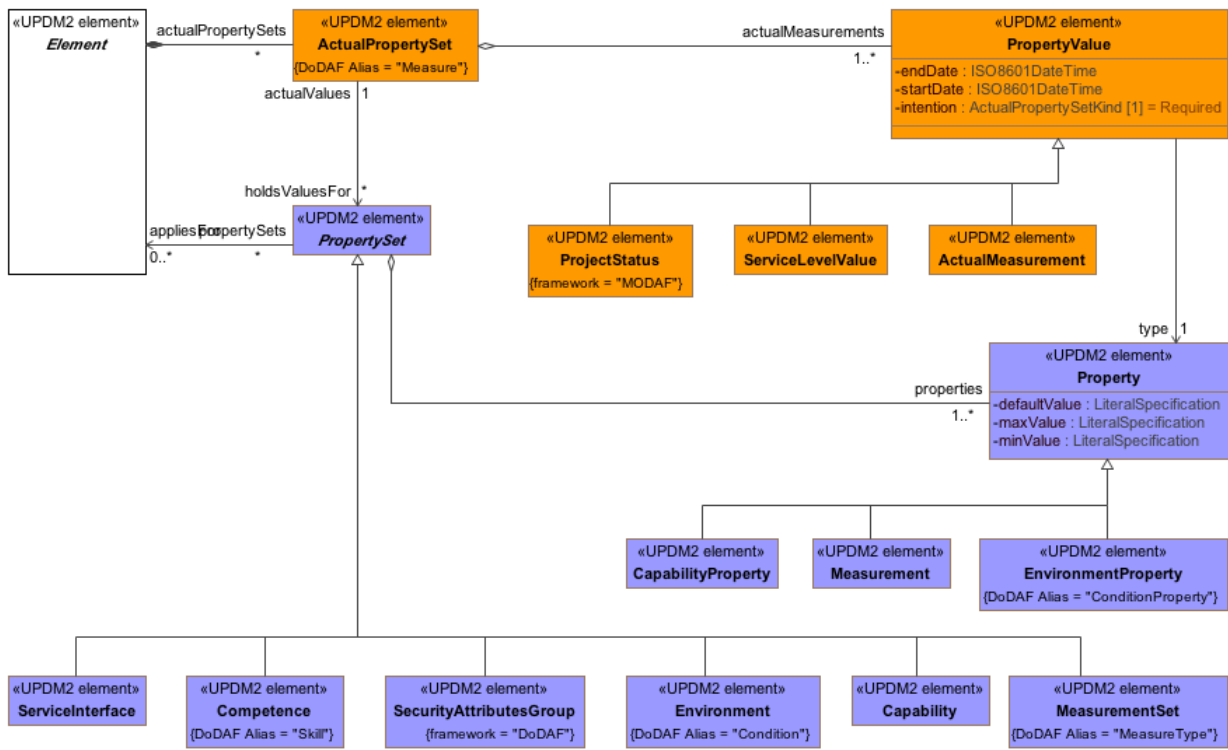

Figure A.53 - Measure - DM2

A.10.8 Organizational Structure - DM2

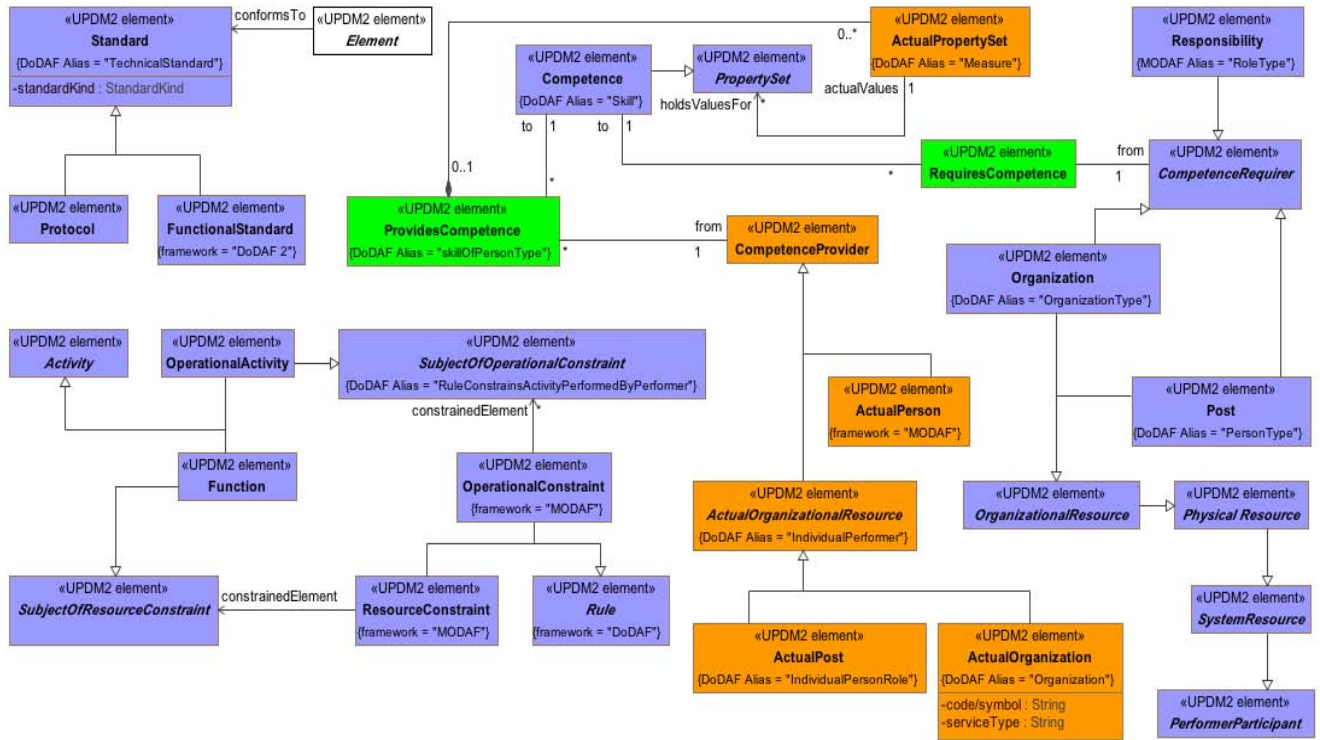

Figure A.54 - Organizational Structure - DM2

A.10.9 Performer - DM2

The Performer diagram shows the UPDM elements and the relationships that map to the concepts of Performer from the DoDAF 2.0.2 Metamodel.

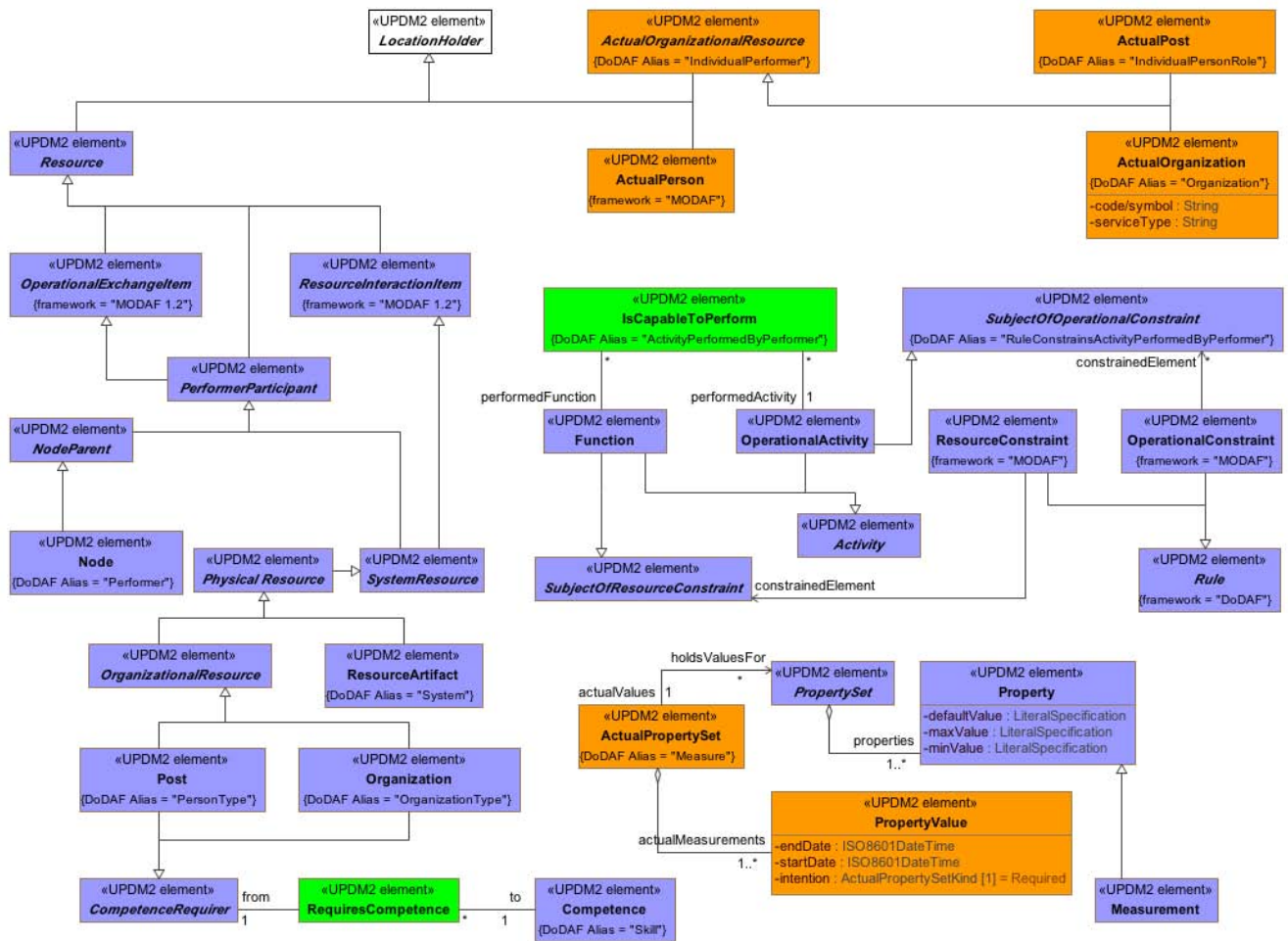

Figure A.55 - Performer - DM2

A.10.10 Project - DM2

The Project diagram shows the UPDM elements and the relationships that map to the concepts of Project from the DoDAF 2.0.2 Metamodel.

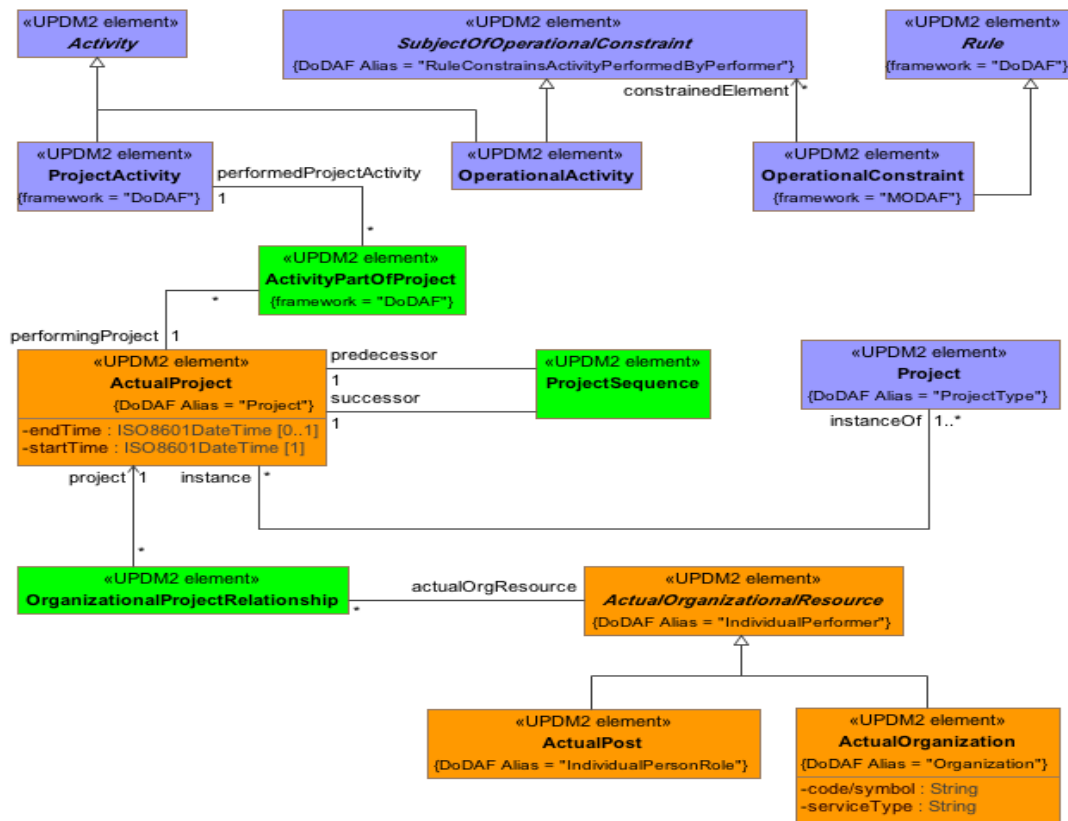

Figure A.56 - Project - DM2

A.10.11 Resource Flow - DM2

The Resource Flow diagram shows the UPDM elements and the relationships that map to the concepts of Resource Flow from the DoDAF 2.0.2 Metamodel.

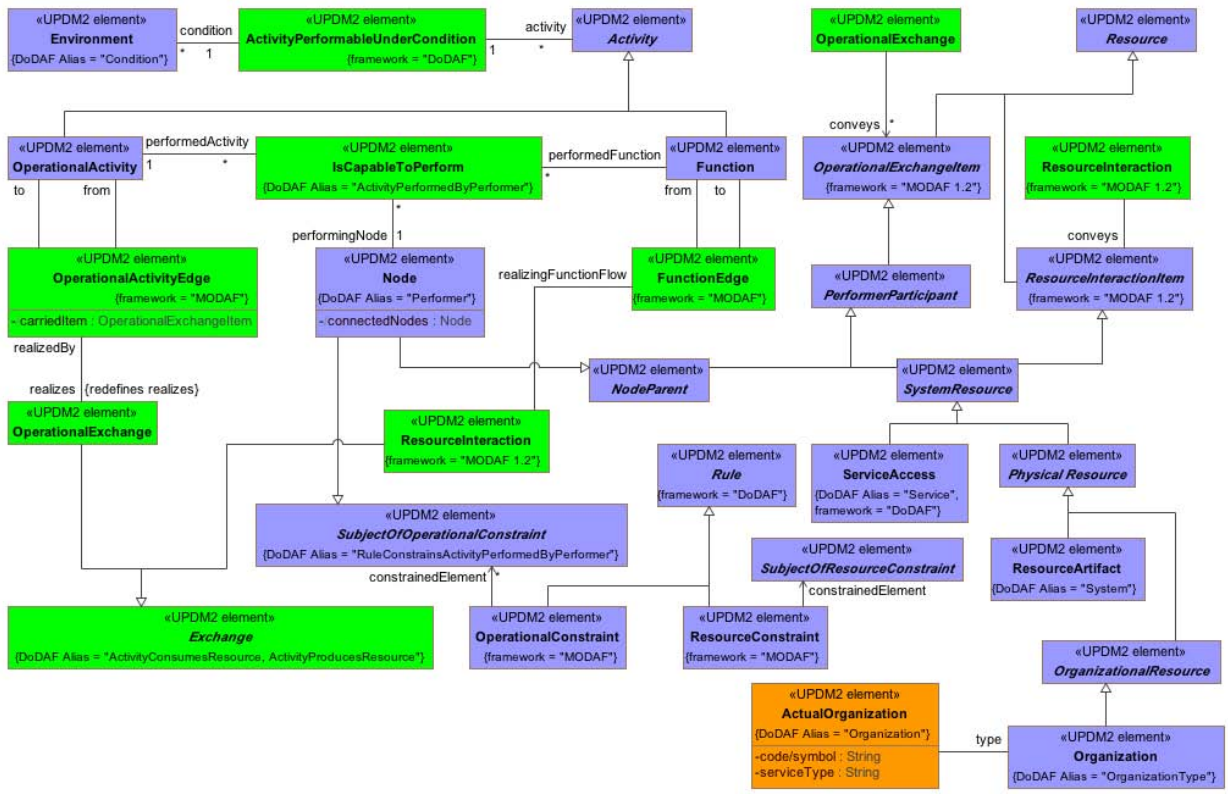

Figure A.57 - Resource Flow - DM2

A.10.12 Rules - DM2

The Rules diagram shows the UPDM elements and the relationships that map to the concepts of Rules from the DoDAF 2.0.2 Metamodel.

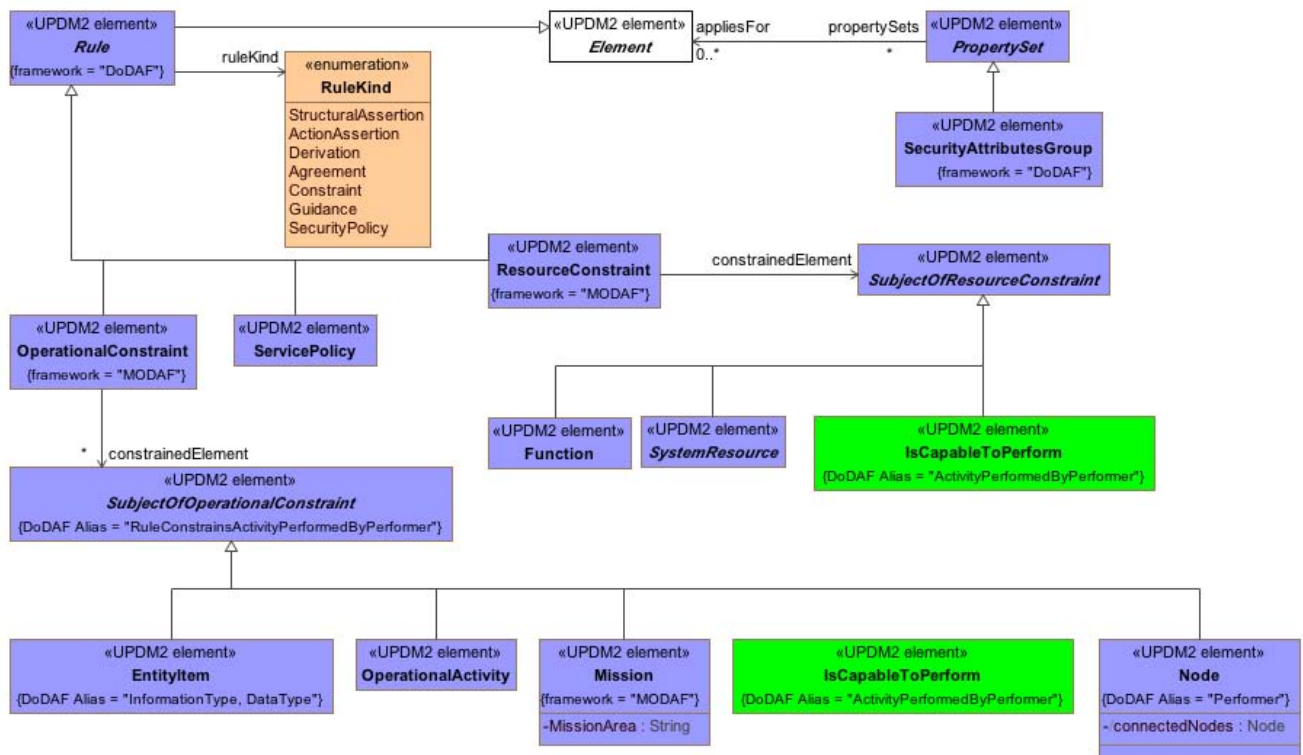

Figure A.58 - Rules - DM2

A.10.13 Services - DM2

The Services diagram shows the UPDM elements and the relationships that map to the concepts of Services from the DoDAF 2.0.2 Metamodel.

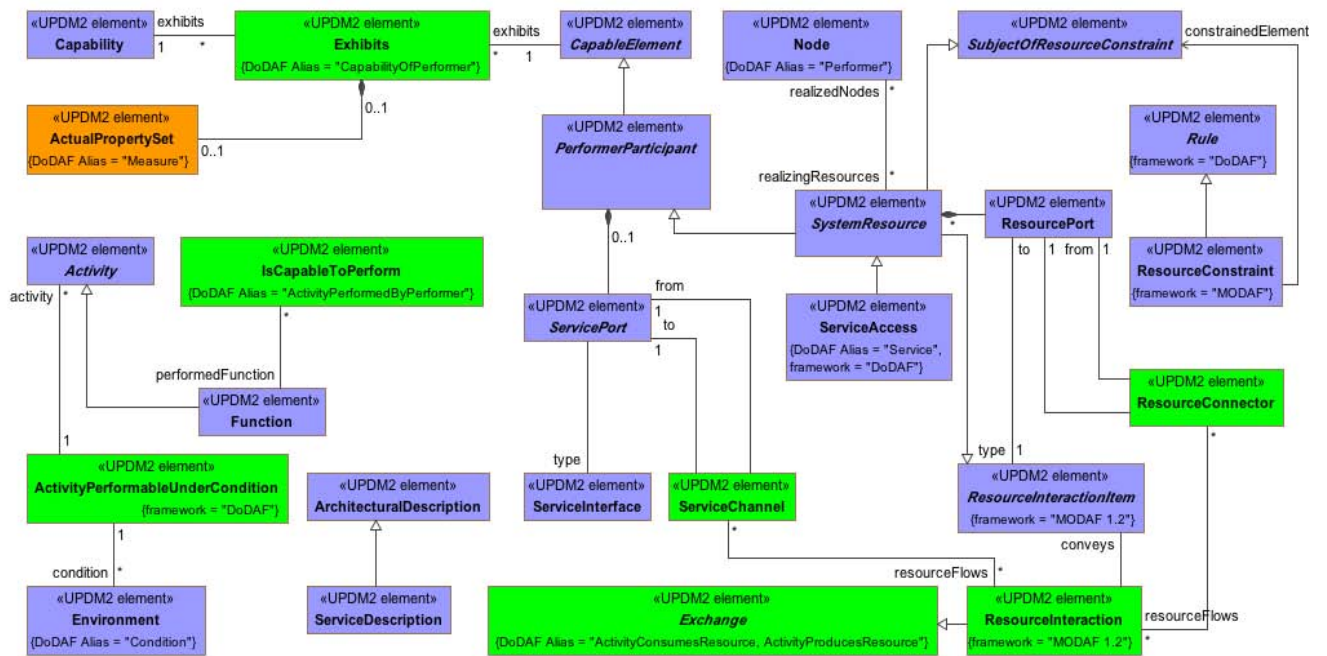

Figure A.59 - Services - DM2

Annex B - UPDM Views (Profile)

(non-normative)

This Annex is intended as non-normative guidance for developers and users as to what UPDM elements and relationships are applicable for each of the UPDM Views.

B.1 Products

MODAF: A connected and coherent set of Architectural Elements which conform to a View.

DoDAF Alias: View: DoDAF divides the problem space into manageable pieces, according to the stakeholder's Viewpoint, further defined in the framework as "Views."

B.1.1 AcV/PV

MODAF: The Acquisition Views (AcVs) describe programmatic details, including dependencies between projects and capability integration across the all the DLODs. These Views guide the acquisition and fielding processes.

DoDAF: Project Views (PV) within the Project Viewpoint describe projects, how those projects deliver capabilities, the organizations contributing to the projects and dependencies between projects.

B.1.1.1 AcV-1/PV-1

MODAF: AcV-1 view products represent an organizational perspective on projects.

DoDAF: AcV-1 view [DoDAF::Project Portfolio Relationships (PV-1) DoDAF-described View] represents an organizational perspective on programs, projects, or a portfolio of projects.

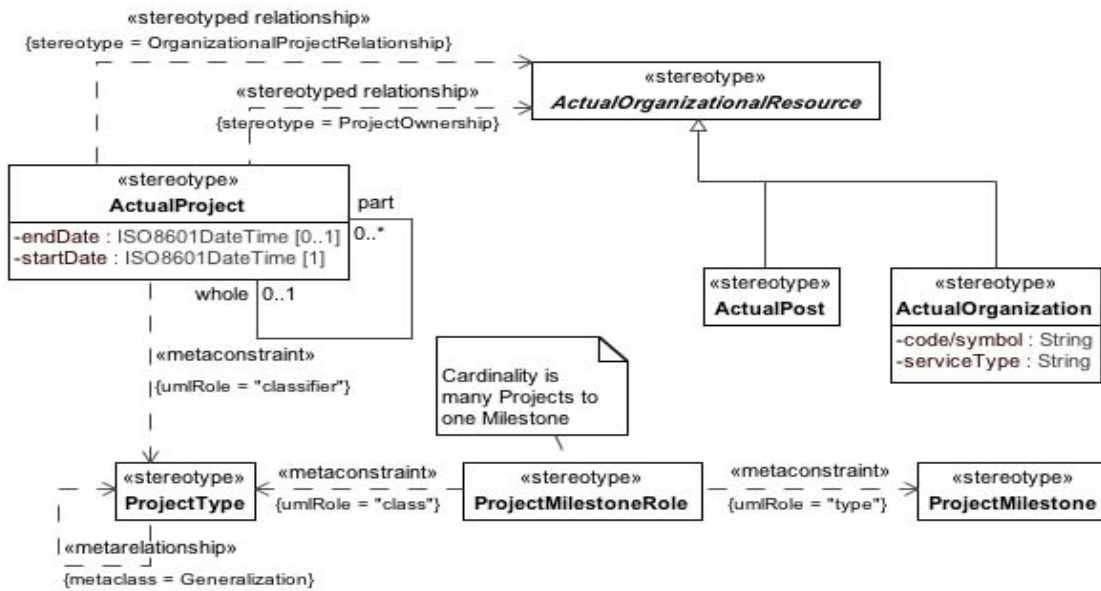

Figure B.1 - AcV-1/PV-1

B.1.1.2 AcV-2/PV-2

MODAF: AcV-2 view products provide a timeline perspective on projects.

DoDAF: AcV-2 (DoDAF::PV-2: Project Timelines DoDAF-described View) provides a timeline perspective on programs or projects.

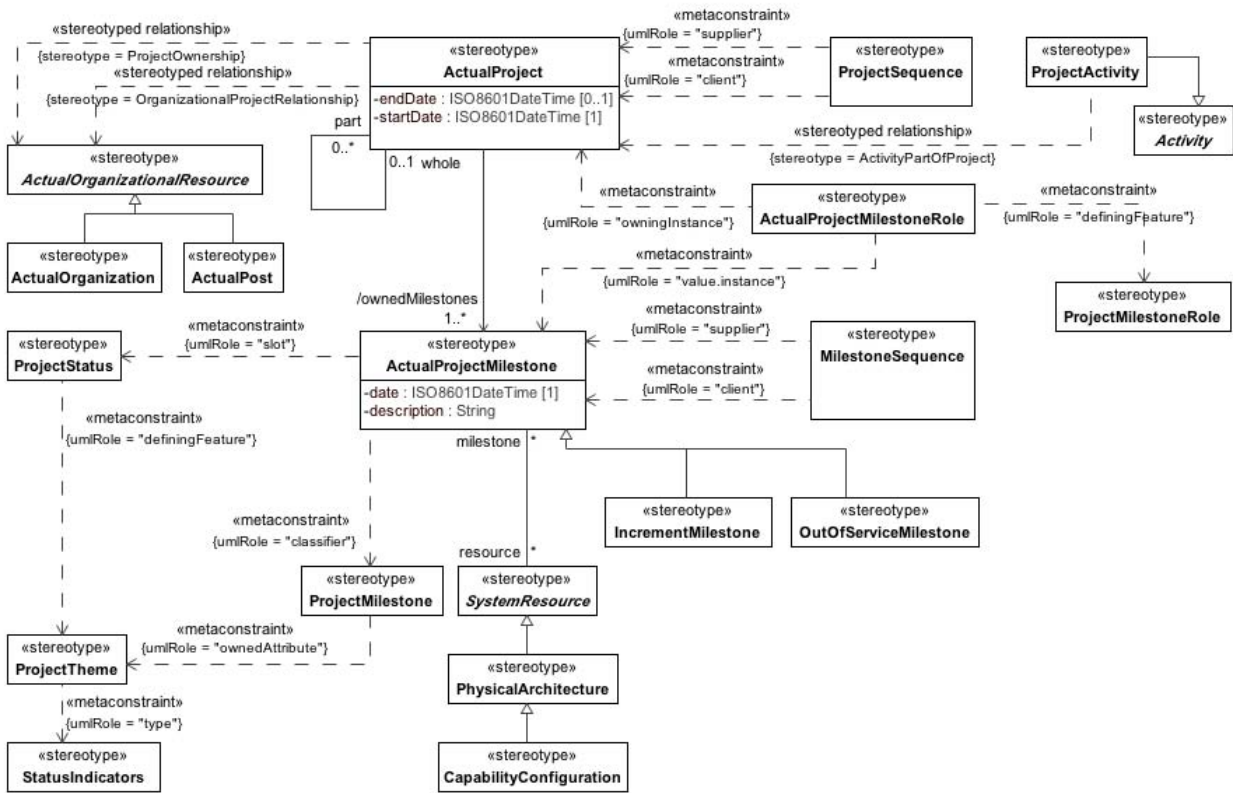

Figure B.2 - AcV-2/PV-2

B.1.1.3 PV-3

MODAF: NA

DoDAF: PV-3 diagram indicates the Capabilities that are realized by a particular project.

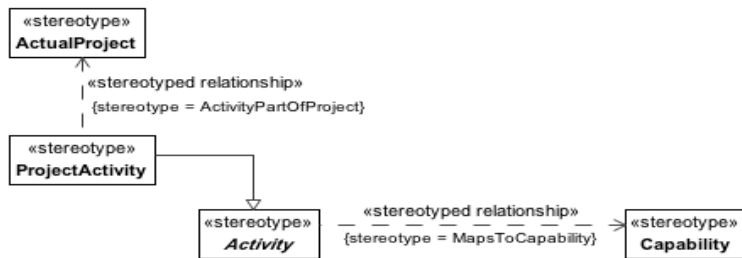

Figure B.3 - PV-3

B.1.2 AV

MODAF: All View products provide information pertinent to the entire Architecture. They present supporting information rather than architectural models.

DoDAF: There are some overarching aspects of an architecture that relate to the entire architecture being developed. These overarching aspects are captured in the All Viewpoint (AV) DoDAF-described views.

B.1.2.1 AV-1

MODAF: The overview and summary information contained within the AV-1 product provides executive-level summary information in a consistent form that allows quick reference and comparison between architectural descriptions. AV-1 includes assumptions, constraints, and limitations that may affect high-level decisions relating to an architecture-based work programme.

DoDAF: The overview and summary information contained within the AV-1 DoDAF-described View provides executive-level summary information in a consistent form that allows quick reference and comparison between architectural descriptions. The AV-1 includes assumptions, constraints, and limitations that may affect high-level decisions relating to an architecture-based work program.

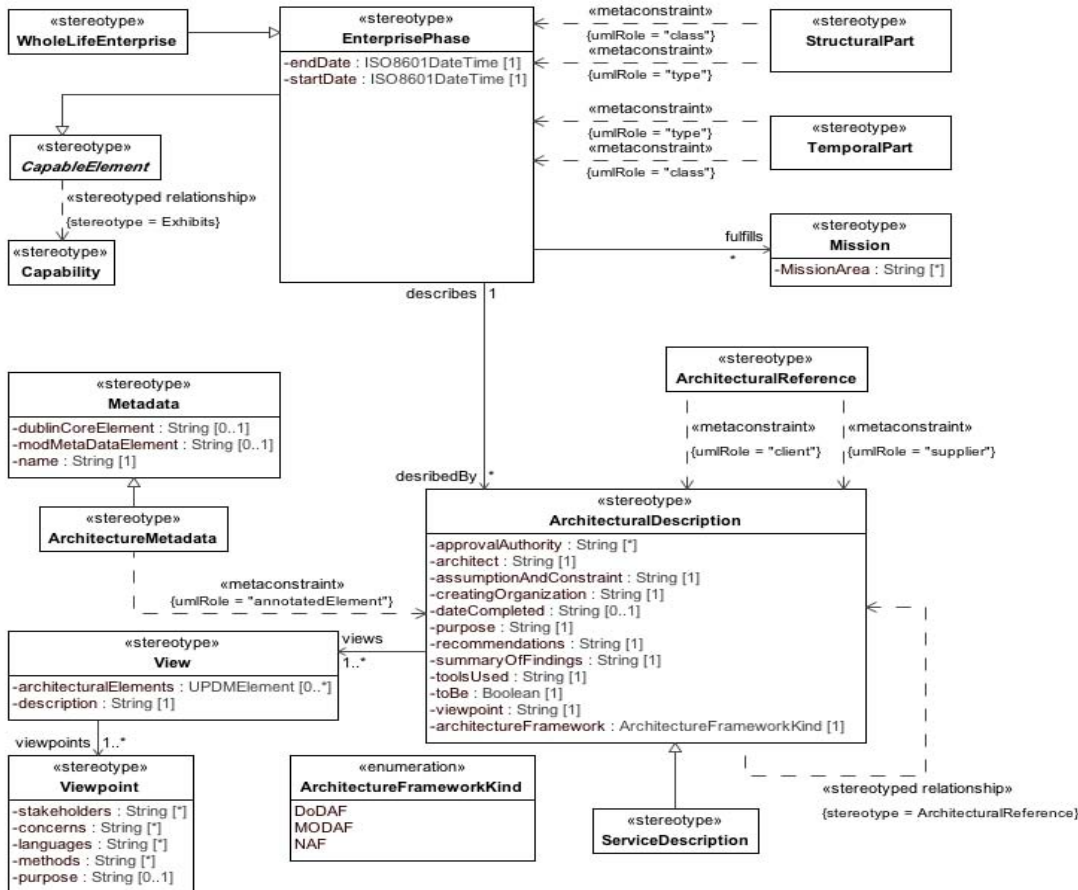

Figure B.4 - AV-1

B.1.2.2 AV-2

MODAF: AV-2 presents all the Elements used in an architecture as a stand alone structure. An AV-2 presents all the Elements as a specialization hierarchy, provides a text definition for each one and references the source of the element (e.g., MODAF Ontology, IDEAS Model, local, etc.). An AV-2 shows elements from the MODAF Ontology that have been used in the architecture and new elements (i.e., not in the MODAF Ontology) that have been introduced by the architecture.

DoDAF: The AV-2 presents all the metadata used in an architecture as a standalone structure. An AV-2 presents all the metadata as a specialization hierarchy, provides a text definition for each one and references the source of the element (e.g., DoDAF Meta-model, IDEAS, a published document or policy). An AV-2 shows elements from the DoDAF Meta-model that have been used in the architecture and new elements (i.e., not in the DoDAF Meta-model) that have been introduced by the architecture.

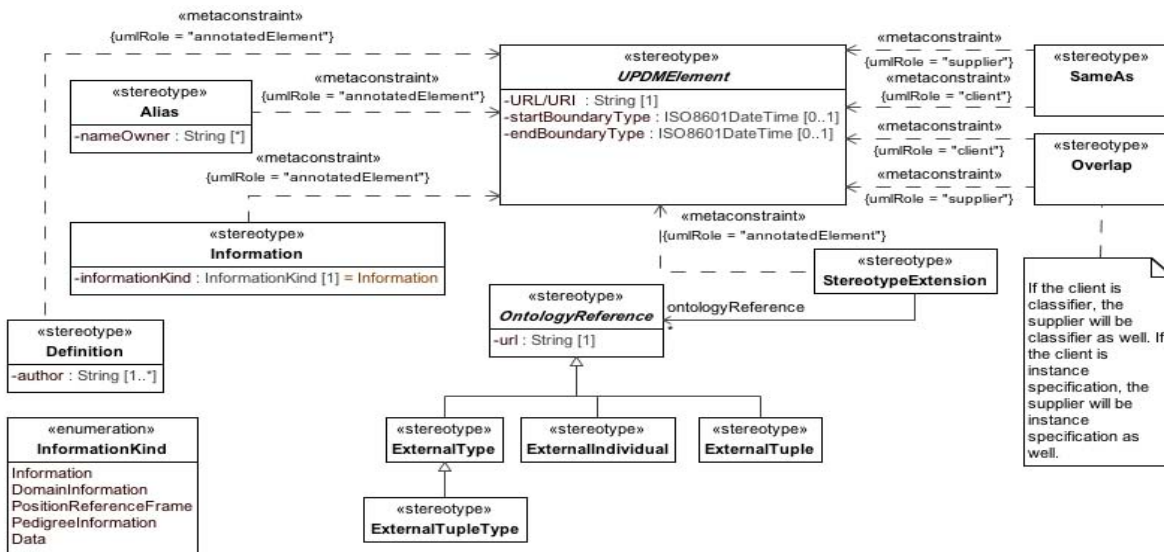

Figure B.5 - AV-2

B.1.2.3 Environment Elements

The Environments diagram shows the elements and relationships that are involved in defining the environments applicable to capability, operational concept, or set of systems.

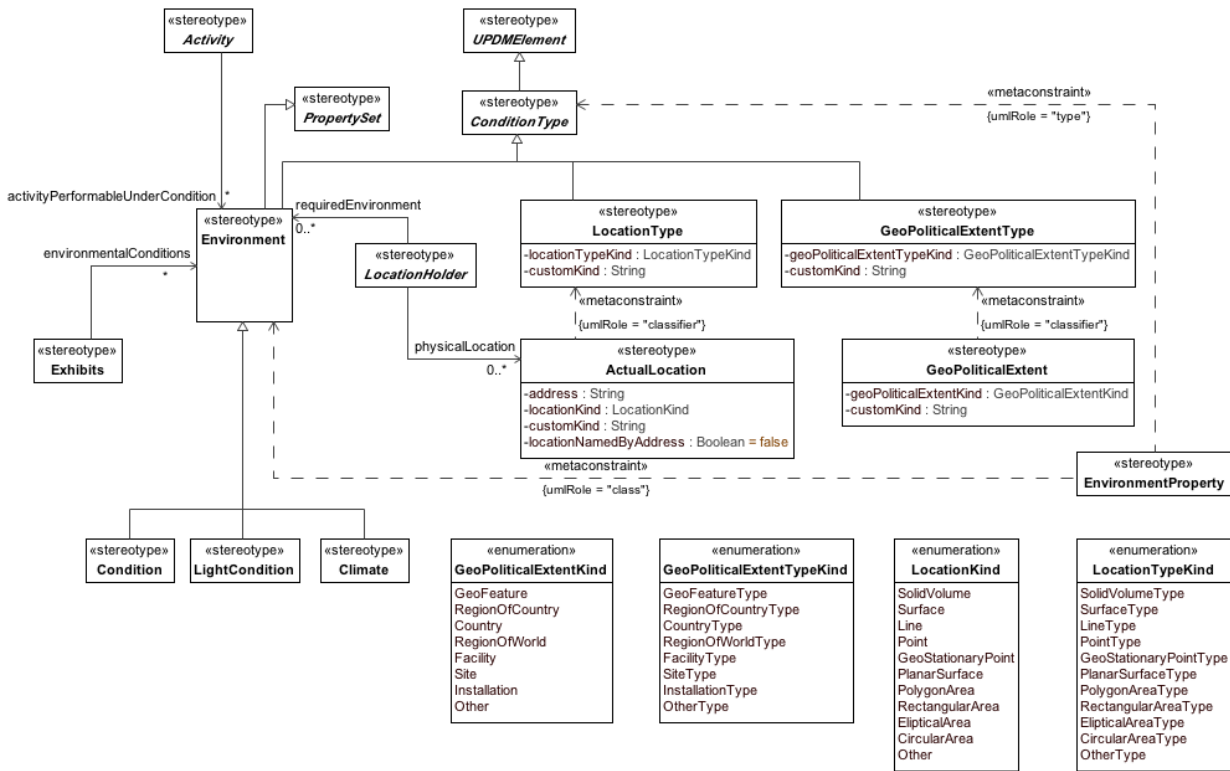

Figure B.6 - Environment Elements

B.1.2.4 Measurements

Shows the measurable properties of something in the physical world, expressed in amounts of a unit of measure that can be associated with a UPDMElement.

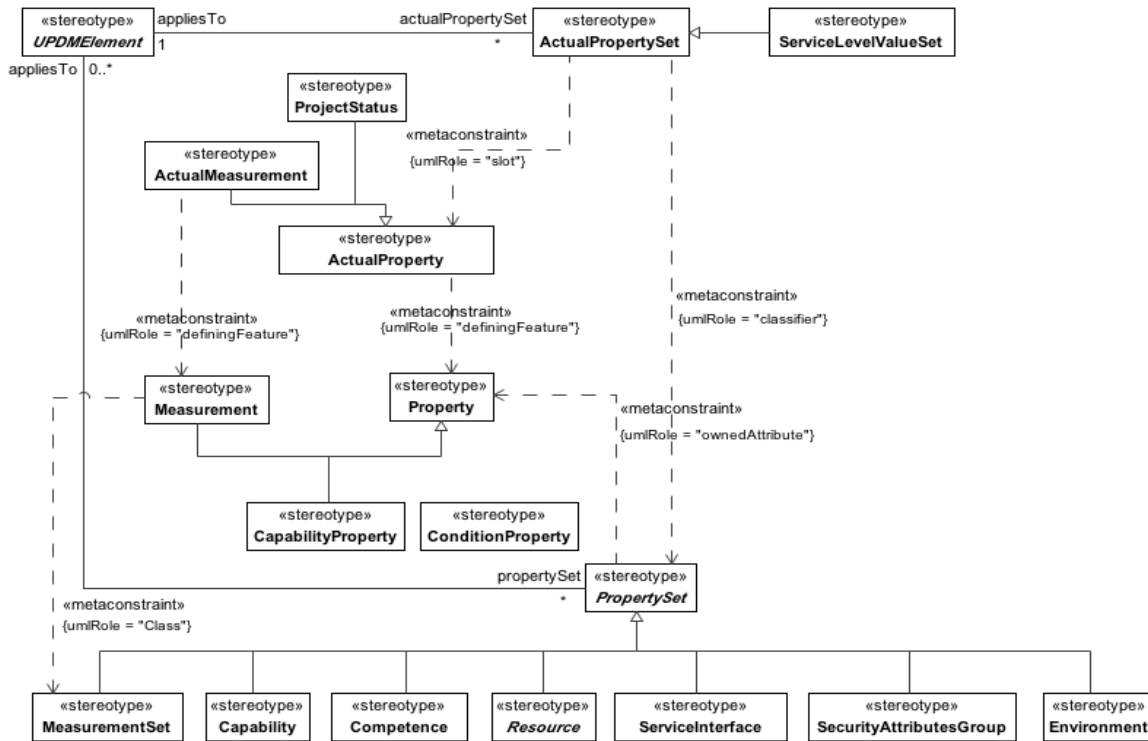

Figure B.7 - Measurements

B.1.3 OV

MODAF: Operational Views describe the tasks and activities, operational elements, and information exchanges required to conduct operations. In MODAF thinking, the OV Views are considered to illustrate the Logical Architecture of the enterprise.

DoDAF: Operational Views within the Operational Viewpoint describe the tasks and activities, operational elements, and resource flow exchanges required to conduct operations. A pure operational view is materiel independent.

B.1.3.1 OV-1

MODAF: OV-1 addresses the high level operational concepts related to one or more missions. An OV-1 describes a mission, class of mission, or scenario; and highlights the main operational elements and interesting or unique aspects of operations.

The OV-1 has two purposes. First, it provides a means of organizing the operational architecture models into distinct groups based on scenario context. Second, it communicates the essence of the scenario context in an essentially graphical form.

DoDAF: The OV-1 DoDAF-described View describes a mission, class of mission, or scenario. It shows the main operational concepts and interesting or unique aspects of operations. It describes the interactions between the subject architecture and its environment, and between the architecture and external systems. A textual description accompanying the graphic is crucial. Graphics alone are not sufficient for capturing the necessary architecture data.

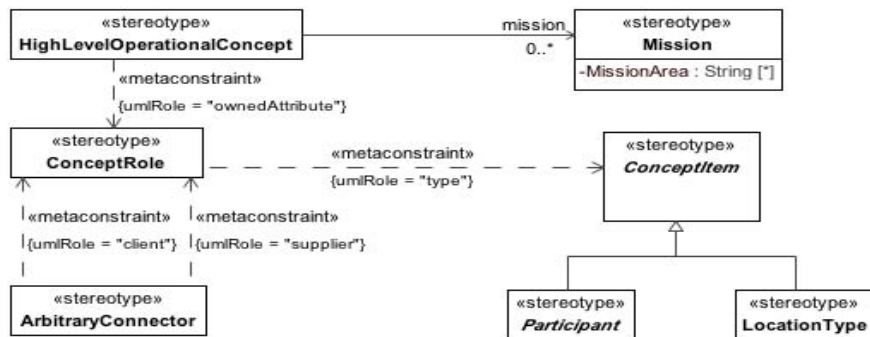

Figure B.8 - OV-1

B.1.3.2 OV-2

MODAF: The Operational Node Relationships Description (OV-2) addresses localization of operational capability.

DoDAF: The Operational Resource Description (OV-2) DoDAF-described View applies the context of the operational capability to a community of anticipated users.

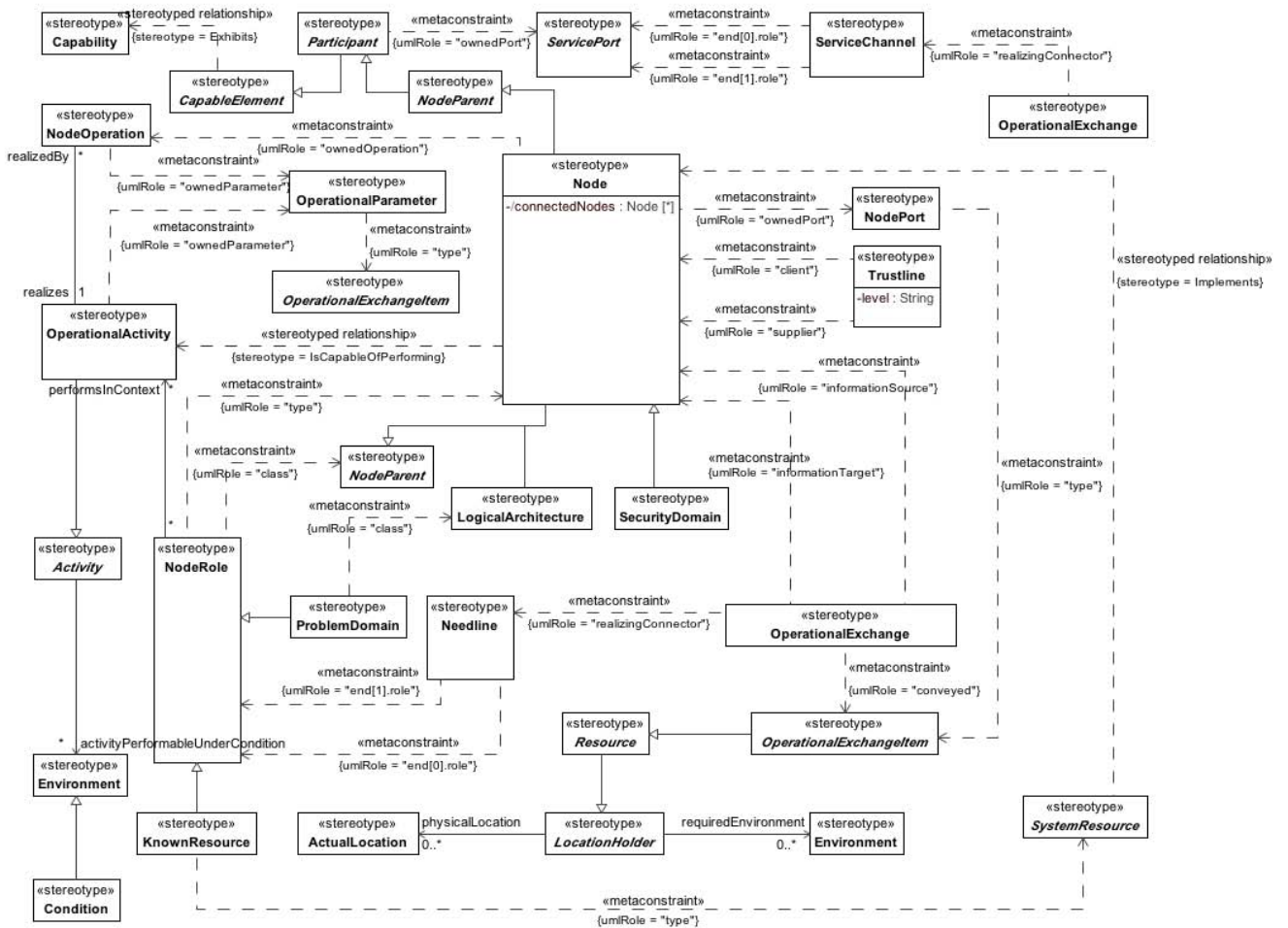

Figure B.9 - OV-3

MODAF: The Operational Information Exchange Matrix (OV-3) addresses operational information exchanges between nodes.

DoDAF: The Operational Resource Flow Matrix (OV-3) DoDAF-described addresses operational resource flows exchanged between Operational Activities and locations.

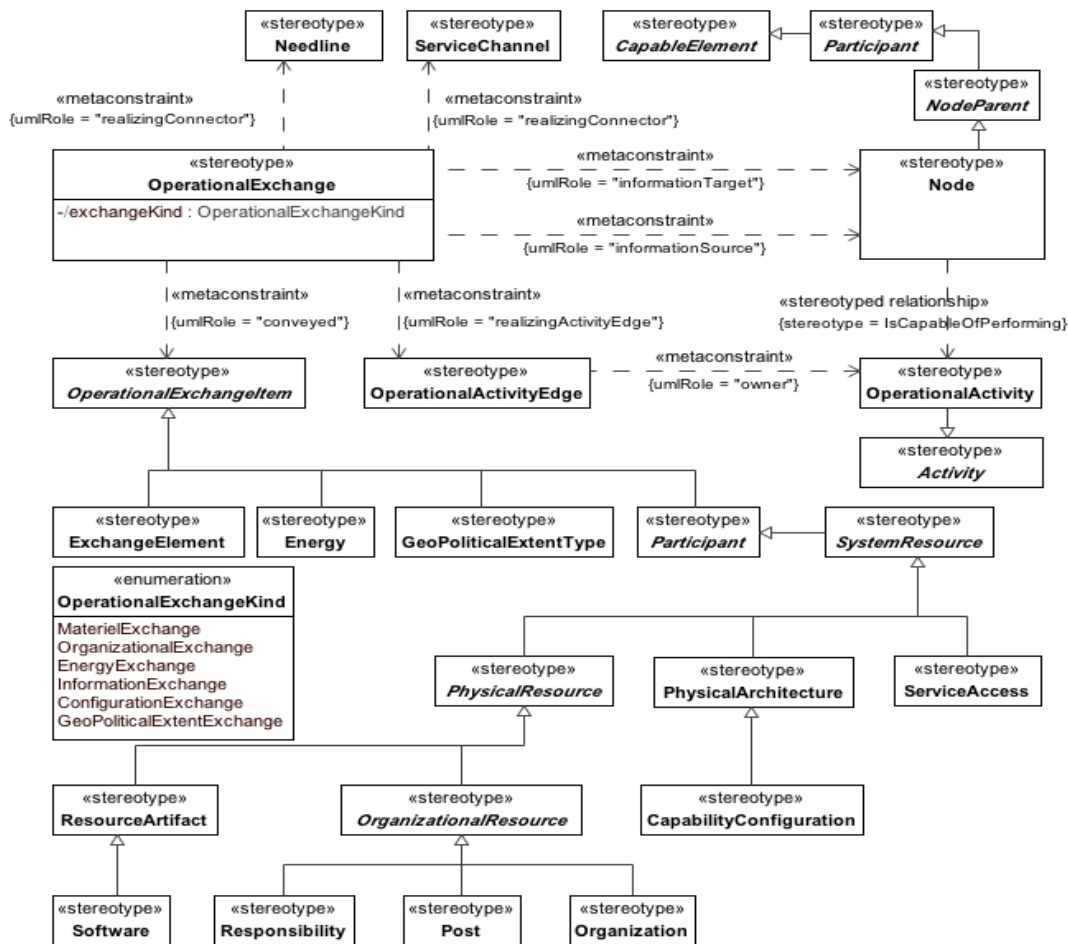

Figure B.10 - OV-3

B.1.3.3 OV-4 Actual

This is the OV-4 Actual View. The Organizational Relationships Chart illustrates the command structure or relationships (as opposed to relationships with respect to a business process flow) among human roles, organizations, or organization types that are the key players in architecture. MoDAF divides the OV-4 two views, an OV-4 Typical and an OV-4 Actual. The former is exactly as the DoDAF OV-4, while the latter is a special form of the SV-1; where the resources are restricted to being organizational.

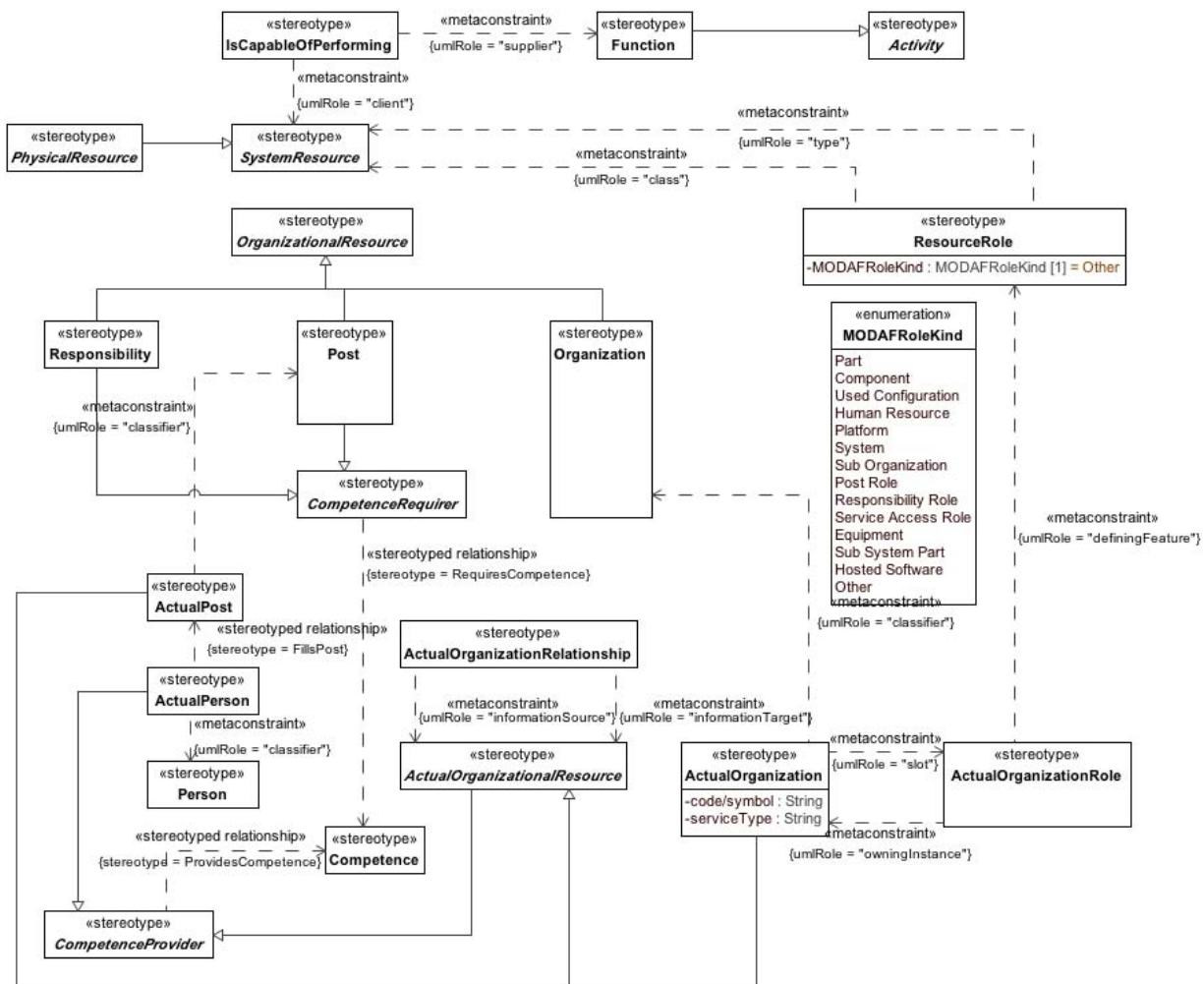

Figure B.11 - OV-4 Actual

B.1.3.4 OV-4 Typical

MODAF: The OV-4 shows organizational structures and interactions. The organizations shown may be civil or military. A typical OV-4 shows the possible relationships between organizational resources (organizations and posts).

DoDAF: DoDAF: The OV-4 DoDAF-described View shows organizational structures and interactions. The organizations shown may be civil or military. A typical OV-4 shows the possible relationships between organizational resources.

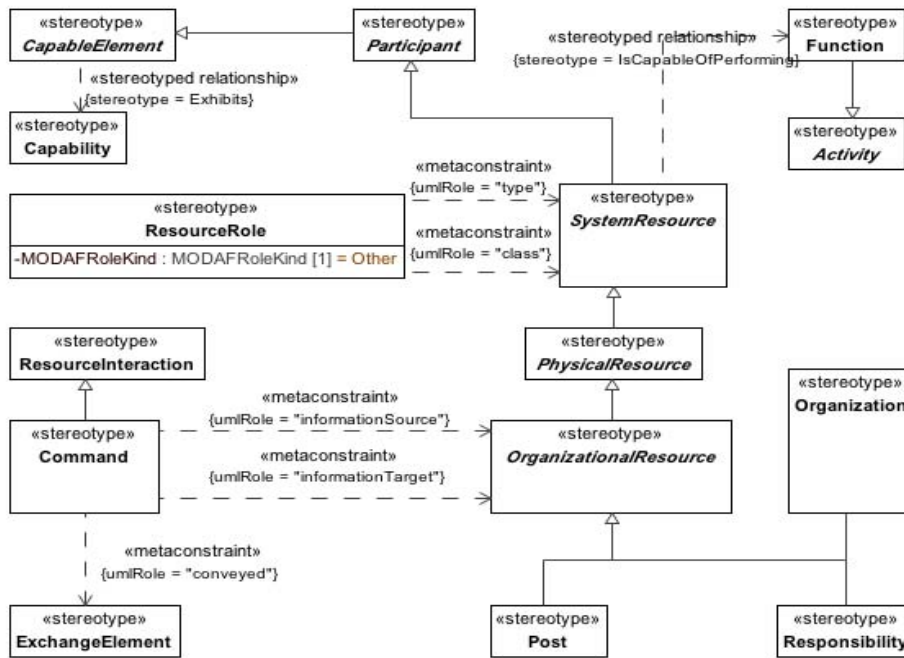

Figure B.12 - OV-4 Typical

B.1.3.5 OV-5

MODAF: The Operational Activity Model (OV-5) describes the operations that are normally conducted in the course of achieving a mission or a business goal. It describes operational activities (or tasks), Input/Output flows between activities and to/from activities that are outside the scope of the Architecture.

DoDAF: The Operational Activity Model DoDAF-described View describes the operations that are normally conducted in the course of achieving a mission or a business goal. It describes operational activities (or tasks); Input/Output flows between activities, and to/from activities that are outside the scope of the Architecture.

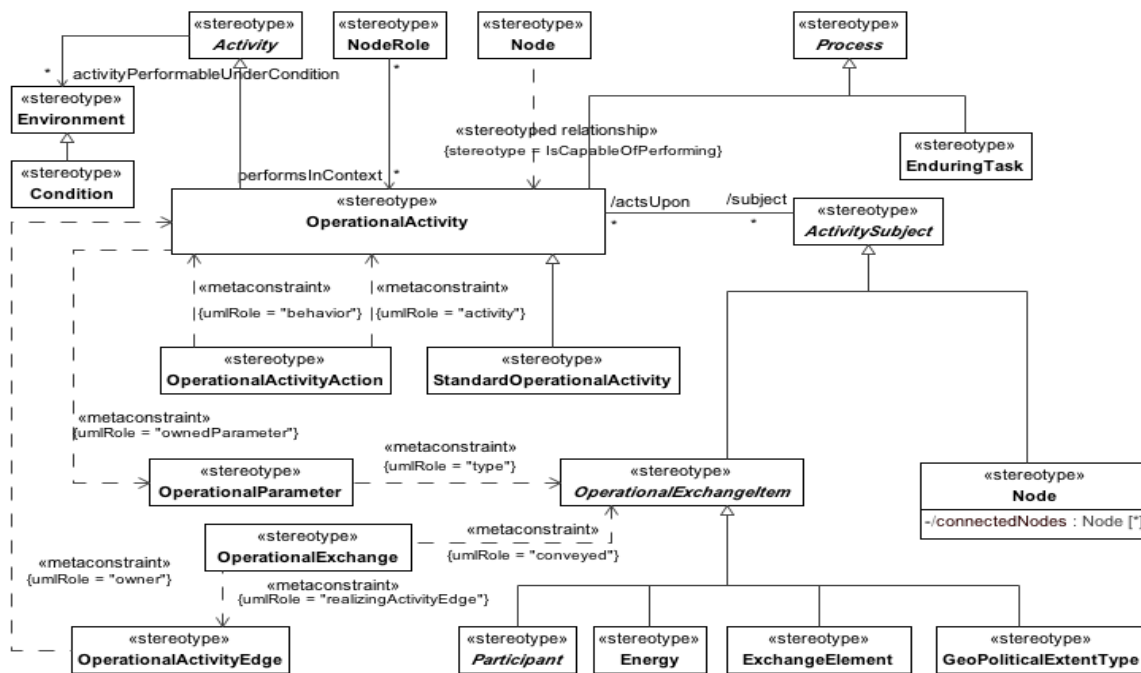

Figure B.13 - OV-5

B.1.3.6 OV-6a

MODAF: An Operational Rules Model (OV-6a) specifies operational or business rules that are constraints on the way that business is done in the enterprise.

DoDAF: An Operational Rules Model (OV-6a) DoDAF-described View specifies operational or business rules that are constraints on the way that business is done in the enterprise.

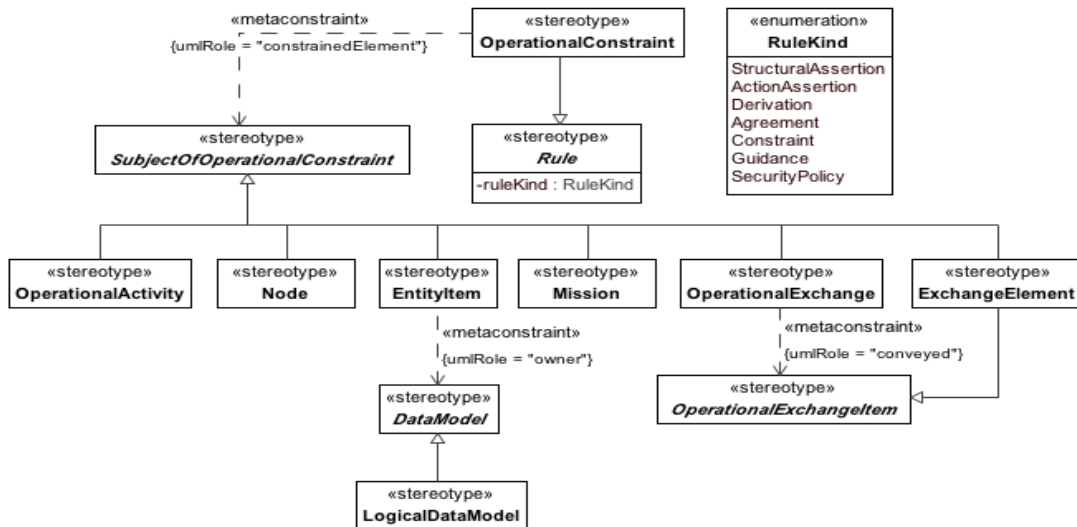

Figure B.14 - OV-6a

B.1.3.7 OV-6b

MODAF: OV-6b: The Operational State Transition Description is a graphical method of describing how an Operational Node or activity responds to various events by changing its state. The diagram represents the sets of events to which the Architecture will respond (by taking an action to move to a new state) as a function of its current state. Each transition specifies an event and an action.

DoDAF: The Operational State Transition Description (OV-6b) DoDAF-described View is a graphical method of describing how an Operational Activity responds to various events by changing its state. The diagram represents the sets of events to which the Architecture will respond (by taking an action to move to a new state) as a function of its current state. Each transition specifies an event and an action.

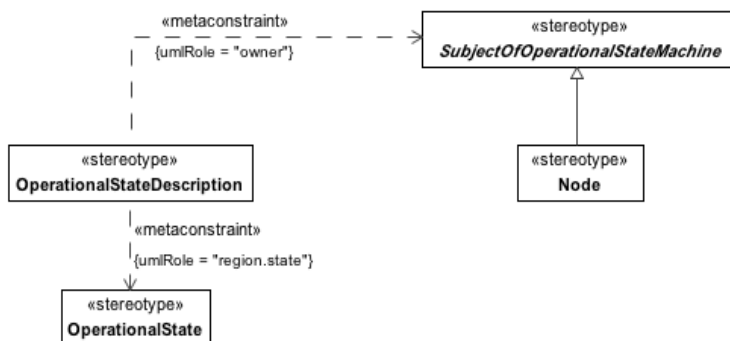

Figure B.15 - OV-6b

B.1.3.8 OV-6c

MODAF: OV-6c: The Operational Event-Trace Description provides a time-ordered examination of the information exchanges between participating Operational Nodes as a result of a particular scenario. Each event-trace diagram will have an accompanying description that defines the particular scenario or situation.

DoDAF: The Operational Event-Trace Description (OV-6c) DoDAF-described View provides a time ordered examination of the resource flows as a result of a particular scenario. Each event-trace diagram will have an accompanying description that defines the particular scenario or situation.

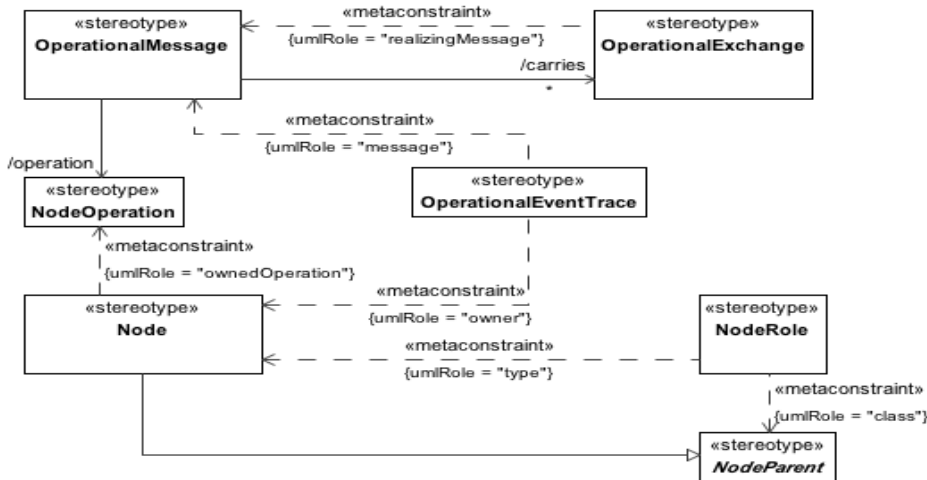

Figure B.16 - OV-6c

B.1.3.9 OV-7/DIV-1/DIV-2

MODAF: Information Models (OV-7) address the information perspective on an operational architecture.

DoDAF: The Conceptual Data Model (DIV-1), a new DoDAF-described View in DoDAF V2.0, addresses the information concepts at a high-level on an operational architecture.

The Logical Data Model (DIV-2) DoDAF-described View allows analysis of an architecture’s data definition aspect, without consideration of implementation specific or product specific issues.

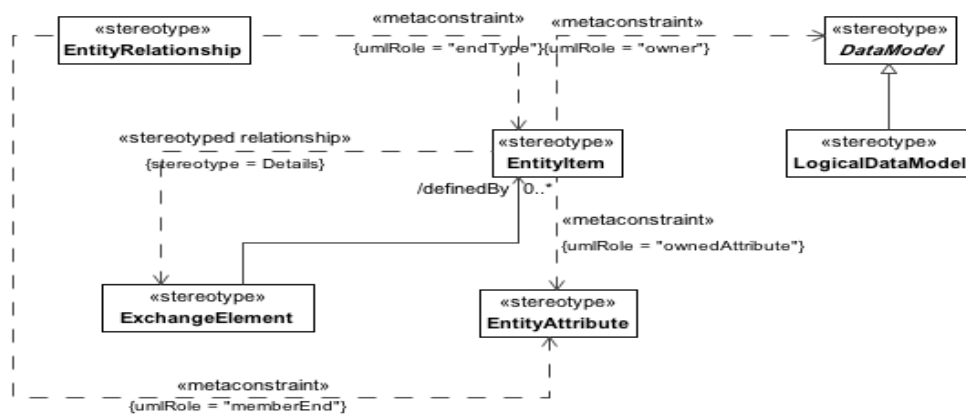

Figure B.17 - OV-7/DIV-1/DIV-2

B.1.4 SOV

MODAF: The Service-Orientated View (SOV) is a description of services needed to directly support the operational domain as described in the Operational View. A service within MODAF is understood in its broadest sense, as a unit of work through which a provider provides a useful result to a consumer.

DoDAF: The Service Views within the Services Viewpoint describe the design for service-based solutions to support operational development processes (JCIDS) and Defense Acquisition System or capability development within the Joint Capability Areas.

The relationship between architecture data elements across the Service Viewpoint to the Operational Viewpoint and Capability Viewpoint can be exemplified as services are procured and fielded to support organizations and their operations or a capability.

B.1.4.1 SOV-1

MODAF: The Service Taxonomy View (SOV-1) specifies a hierarchy of services. The elements in the hierarchy are service specifications (rather than service implementations), and the relationships between the elements are specializations (i.e., one Service is a special type of another).

DoDAF: NA

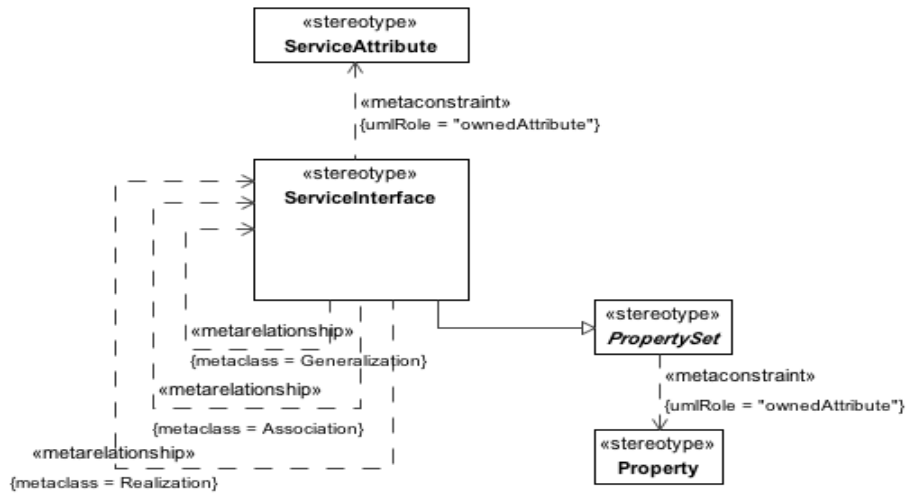

Figure B.18 - SOV-1

B.1.4.2 SOV-2

MODAF: The Service Taxonomy View (SOV-1) specifies a hierarchy of services. The elements in the hierarchy are service specifications (rather than service implementations), and the relationships between the elements are specializations (i.e., one Service is a special type of another).

DoDAF: NA

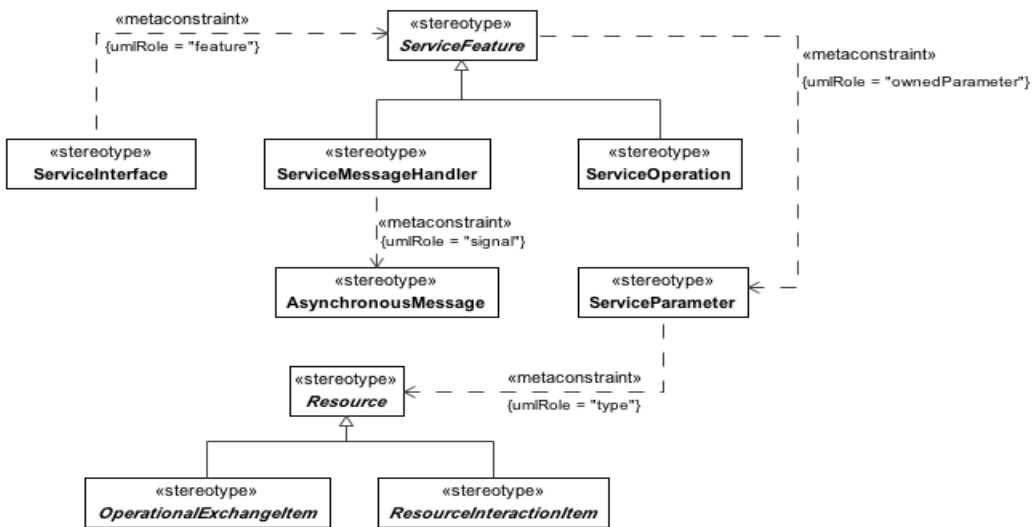

Figure B.19 - SOV-2

B.1.4.3 SOV-3

MODAF: The Capability to Service Mapping View (SOV-3) depicts which services contribute to the achievement of a capability.

DoDAF: CV-7 A mapping between the capabilities and the services that these capabilities enable.

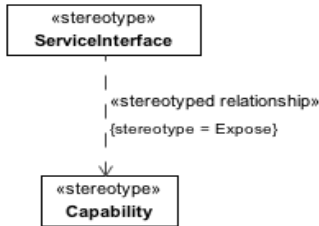

Figure B.20 - SOV-3

B.1.4.4 SOV-4a

MODAF: The purpose of the Service Constraints View (SOV-4a) is to specify constraints that apply to implementations of services.

DoDAF: The SvcV-10a DoDAF-described View describes constraints on the resources, functions, data and ports that make up the Service View physical architecture. The constraints are specified in text and may be functional or structural (i.e., non-functional).

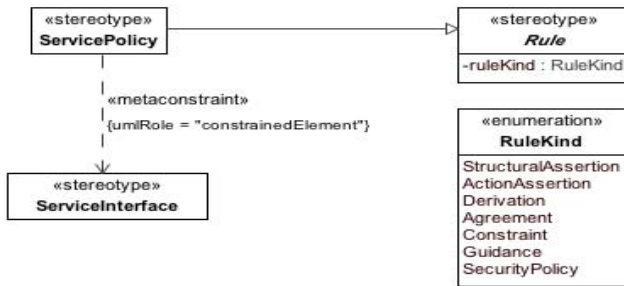

Figure B.21 - SOV-4a

B.1.4.5 SOV-4b

MODAF: The purpose of the Service State Model View (SOV-4b) is to specify the possible states a service may have, and the possible transitions between those states.

DoDAF: The Services State Transition Description DoDAF-described View is a graphical method of describing a resource (or function) response to various events by changing its state. The diagram basically represents the sets of events to which the resources in the Architecture will respond (by taking an action to move to a new state) as a function of its current state. Each transition specifies an event and an action.

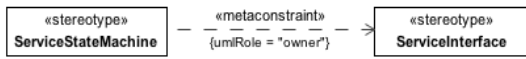

Figure B.22 - SOV-4b

B.1.4.6 SOV-4c

MODAF: The purpose of the Service Interaction Specification View (SOV-4c) is to specify how a service interacts with external agents, and the sequence and dependencies of those interactions.

DoDAF: The Services Event-Trace Description DoDAF-described View provides a time-ordered examination of the interactions between services functional resources. Each event-trace diagram will have an accompanying description that defines the particular scenario or situation.

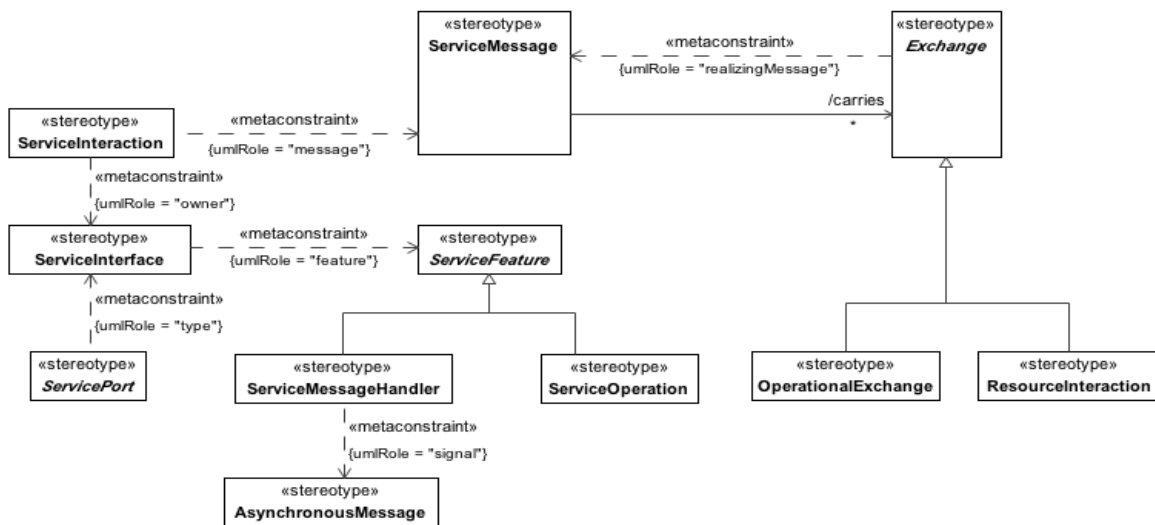

Figure B.23 - SOV-4c

B.1.4.7 SOV-5

MODAF: The Service Functionality View (SOV-5) defines the behavior of a service in terms of the functions it is expected to perform.

DoDAF: The Services Functionality Description provides detailed information regarding the: Allocation of service functions to resources, and Flow of resources between service functions.

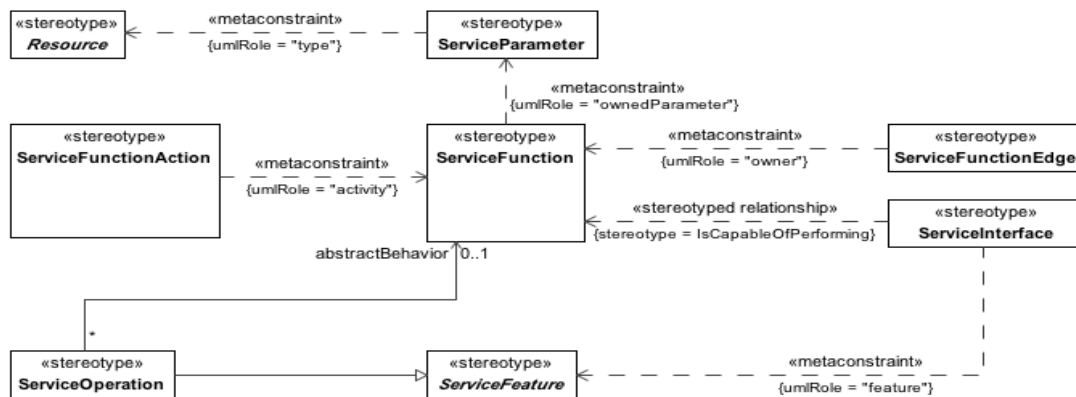

Figure B.24 - SOV-5

B.1.5 StV/CV

MODAF: The Strategic Views (StVs) have been introduced to support the capability management process.

DoDAF: The Capability Views within the Capability Viewpoint are introduced into DoDAF V2.0 to address the concerns of Capability Portfolio Managers. In particular, Capability Views describe capability taxonomy and capability evolution.

B.1.5.1 CV-7

MODAF: NA

DoDAF: CV-7 details the mapping between DoDAF services (ServiceAccess) and the Capability that they realize.

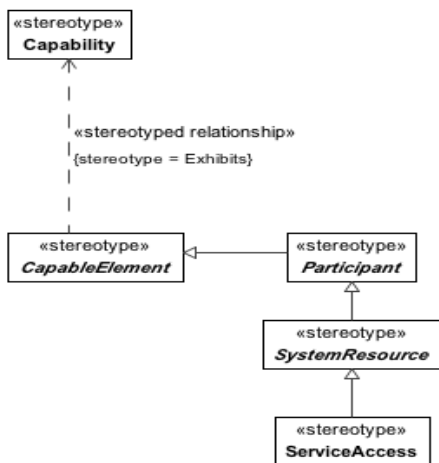

Figure B.25 - CV-7

B.1.5.2 StV-1/CV-1

MODAF: StV-1 addresses the enterprise concerns associated with the overall vision for transformational endeavors and thus defines the strategic context for a group of Enterprise capabilities.

DoDAF: CV-1: Vision: addresses the enterprise concerns associated with the overall vision for transformational endeavors and thus defines the strategic context for a group of capabilities.

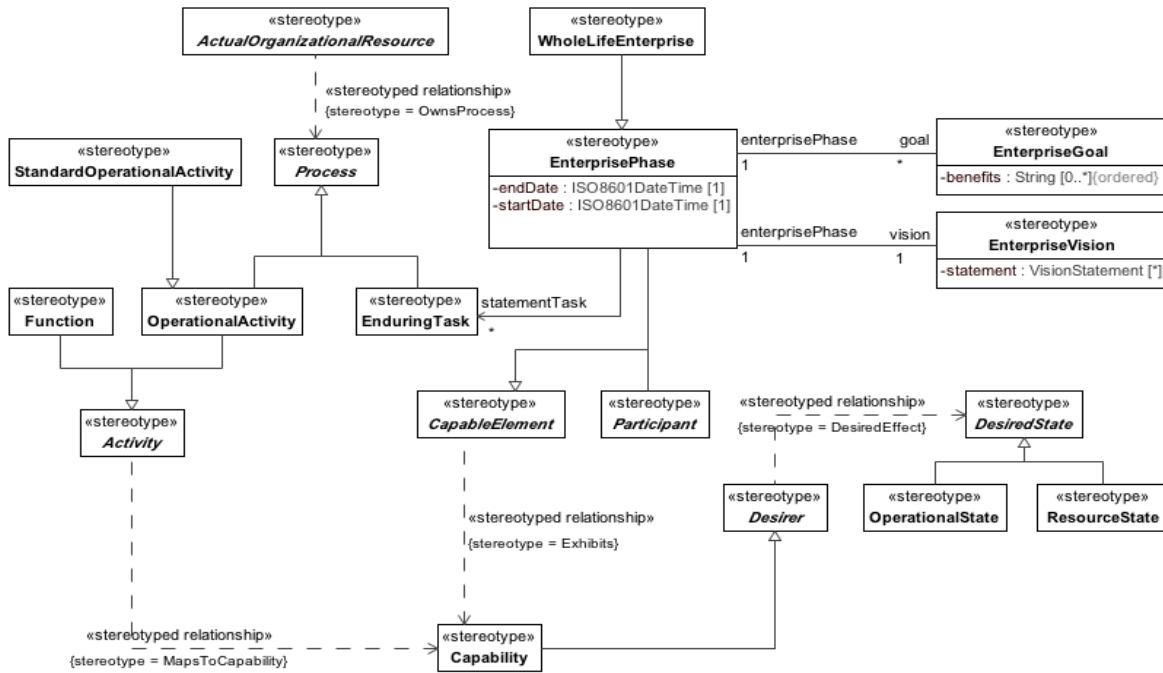

Figure B.26 - StV-1/CV-1

B.1.5.3 StV-2/CV-2

MODAF: The StV-2 Product models capability taxonomies.

DoDAF: The CV-2 DoDAF-described View models capability taxonomies.

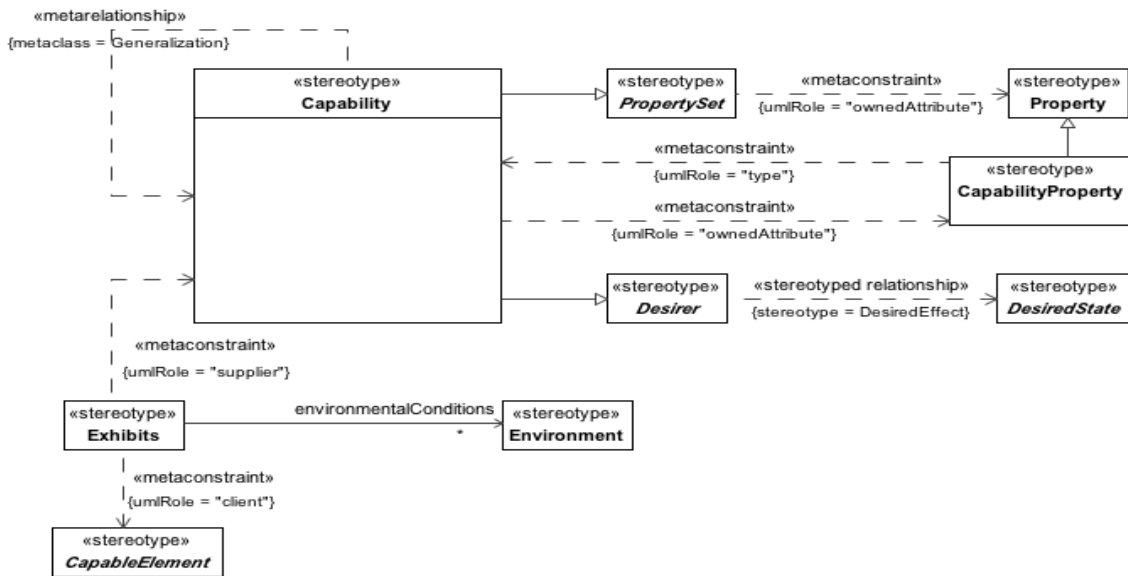

Figure B.27 - StV-2/CV-2

B.1.5.4 StV-3/CV-3

MODAF: StV-3 addresses the planned achievement of capability at different points in time or during specific periods of time (i.e., capability phasing).

DoDAF: CV-3: Capability Phasing The CV-3 addresses the planned achievement of capability at different points in time or during specific periods of time (i.e., capability phasing).

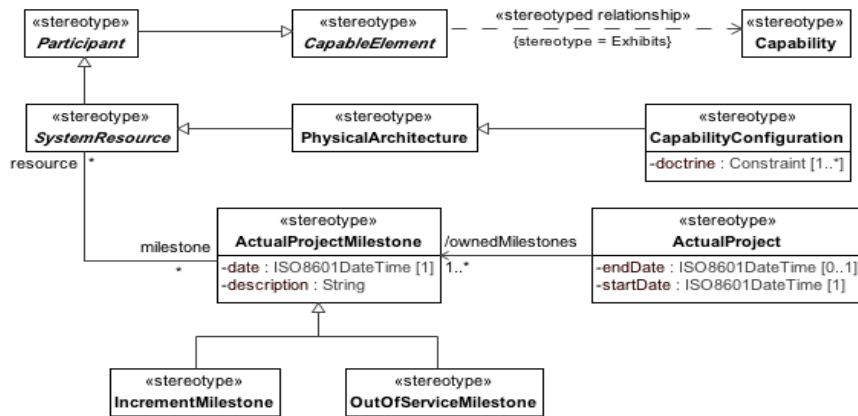

Figure B.28 - StV-3/CV-3

B.1.5.5 StV-4/CV-4

MODAF: The StV-4 Product describes the dependencies between planned capabilities. It also defines logical groupings of capabilities (capability clusters).

DoDAF: CV-4: Capability Dependencies: The CV-4 DoDAF-described View describes the dependencies between planned capabilities. It also defines logical groupings of capabilities.

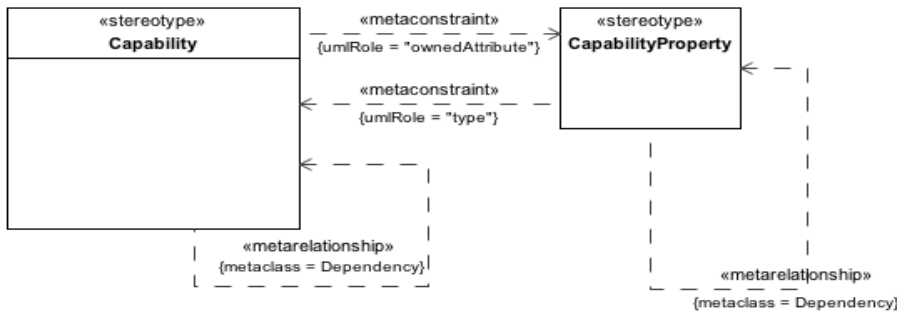

Figure B.29 - StV-4/CV-4

B.1.5.6 StV-5/CV-5

MODAF: StV-5 addresses the fulfilment of capability requirements, in particular by network enabled capabilities.

DoDAF: CV-5: Capability to Organizational Development Mapping: The CV-5 addresses the fulfillment of capability requirements.

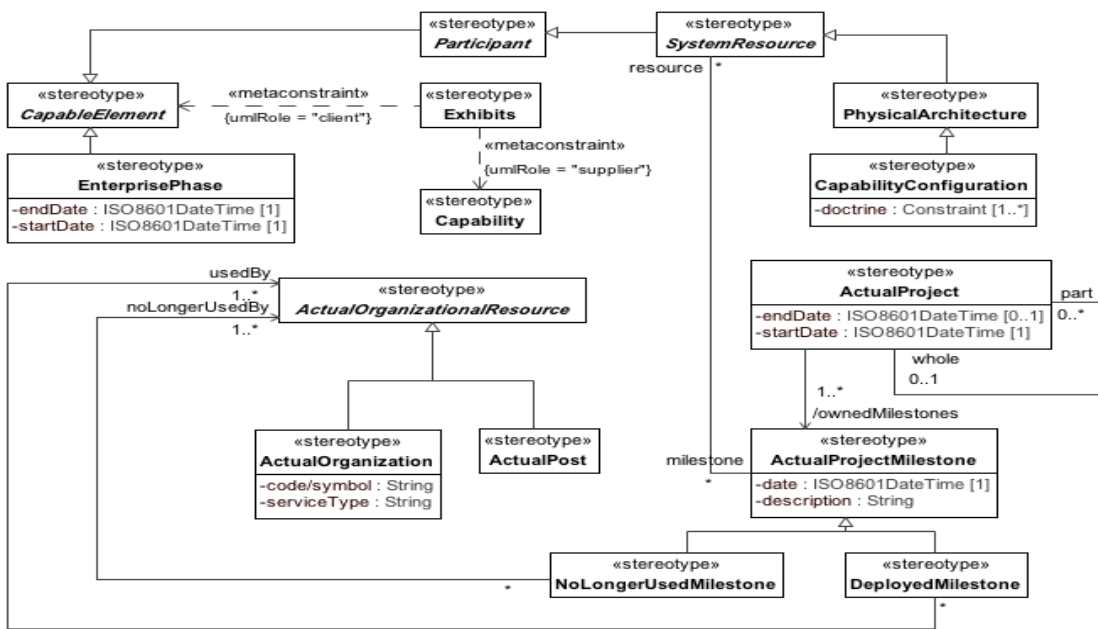

Figure B.30 - StV-5/CV-5

B.1.5.7 StV-6/CV-6

MODAF: The StV-6 Product describes the mapping between the capabilities required by an Enterprise and the operational activities that those capabilities support.

DoDAF: CV-6: Capability to Operational Activities Mapping: The CV-6 DoDAF-described View describes the mapping between the capabilities required and the operational activities that those capabilities support.

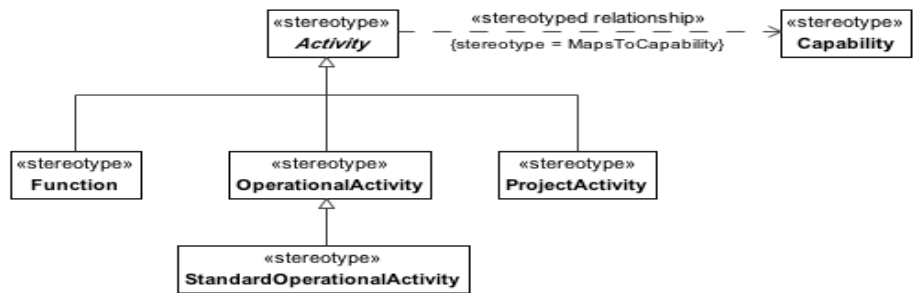

Figure B.31 - StV-6/CV-6

B.1.6 SV/SvcV

MODAF: A better name for these views in MODAF would be Solution or Specification View. In essence they should specify a requirement for a system or present the solution, without delving into the design elements of the system.

DoDAF: The Systems Views within the Systems Viewpoint describe systems and interconnections providing for, or supporting, DoD functions.

B.1.6.1 SV-1/SvcV-1

MODAF: Resource Interaction Specification (SV-1) address the composition and interaction of resources. From MODAF v1.1, SV-1 incorporates the human elements - Posts, Organizations, and Roles.

DoDAF: The Systems Interface Description (SV-1) DoDAF-described View addresses the composition and interaction of Systems. For DoDAF v2.0, the SV-1 incorporates the human elements as types of Performers- Organizations and Personnel Types.

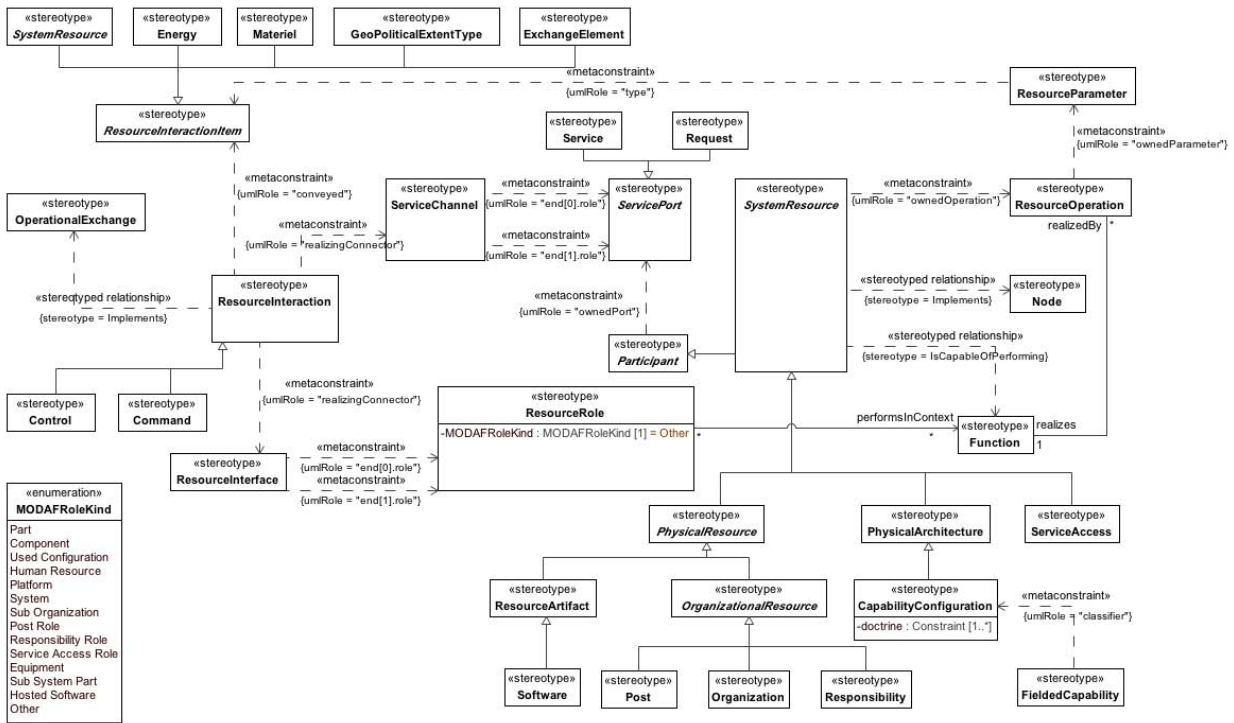

Figure B.32 - SV-1/SvcV-1

B.1.6.2 SV-10a/SvcV-10a

MODAF: The purpose of this Product is to specify functional and non-functional constraints on the implementation aspects of the architecture (i.e., the structural and behavioral elements of the SV viewpoint).

DoDAF: The SV-10a Systems Rules Model DoDAF-described View describes constraints on the resources, functions, data and ports that make up the SV physical architecture. The constraints are specified in text and may be functional or structural (i.e., non-functional).

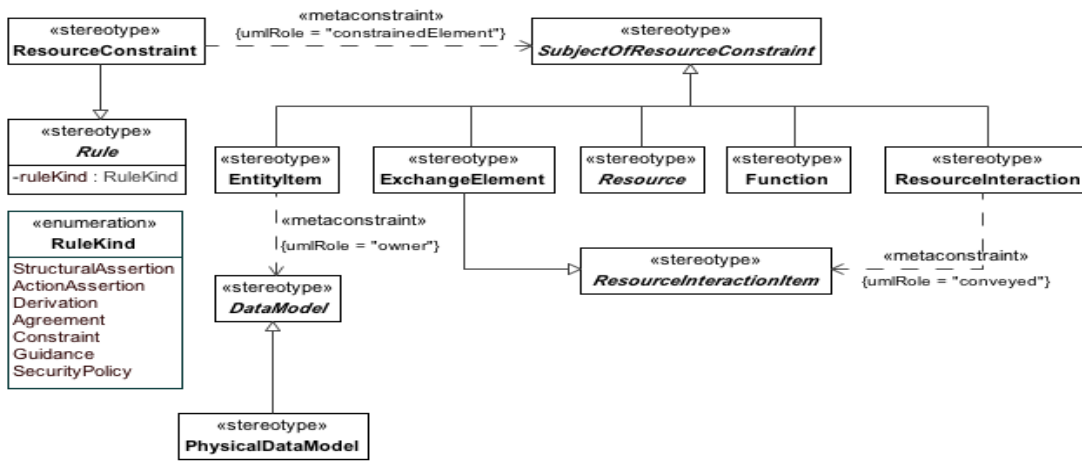

Figure B.33 - SV-10a/SvcV-10a

B.1.6.3 SV-10b/SvcV-10b

MODAF: The Resource State Transition Description is a graphical method of describing a resource (or function) response to various events by changing its state. The diagram basically represents the sets of events to which the Resources in the Architecture will respond (by taking an action to move to a new state) as a function of its current state. Each transition specifies an event and an action.

DoDAF: The Systems State Transition Description DoDAF-described View is a graphical method of describing a resource (or system function) response to various events by changing its state. The diagram basically represents the sets of events to which the resources in the Architecture will respond (by taking an action to move to a new state) as a function of its current state. Each transition specifies an event and an action.

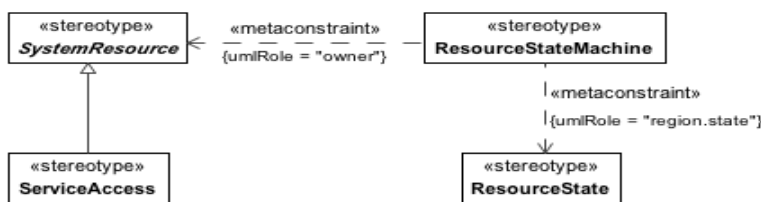

Figure B.34 - SV-10b/SvcV-10b

B.1.6.4 SV-10c/SvcV-10c

MODAF: The Resource Event-Trace Description provides a time-ordered examination of the interactions between resources. Each event-trace diagram will have an accompanying description that defines the particular scenario or situation.

DoDAF: The Systems Event-Trace Description provides a time-ordered examination of the interactions between functional resources. Each event-trace diagram will have an accompanying description that defines the particular scenario or situation.

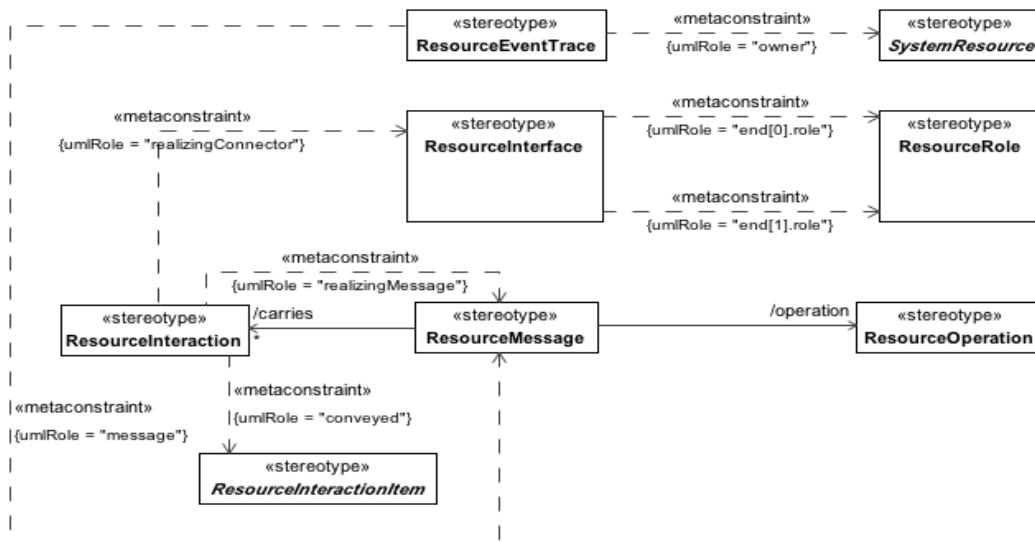

Figure B.35 - SV-10c/SvcV-10c

B.1.6.5 SV-11/DIV-3

MODAF: The SV-11 View defines the structure of the various kinds of system data that are utilized by the systems in the Architecture.

DoDAF: The DIV-3 Physical Data Model DoDAF-described view defines the structure of the various kinds of system or service data that are utilized by the systems or services in the Architecture.

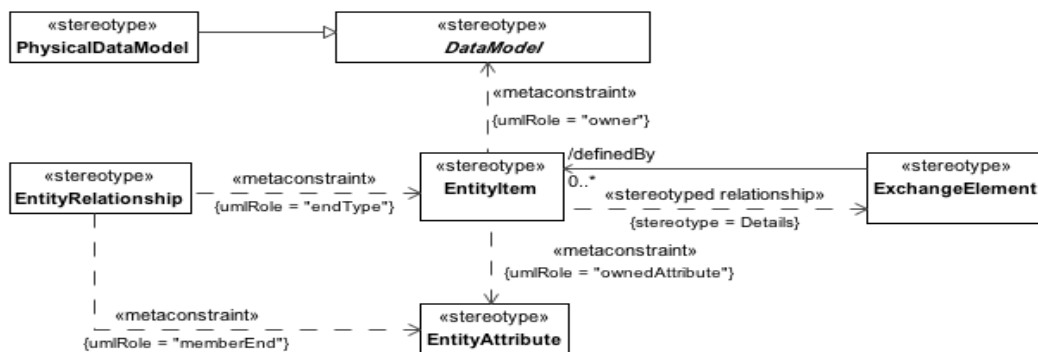

Figure B.36 - SV-11/DIV-3

B.1.6.6 SV-12

MODAF: The Service Provision View (SV-12) specifies configurations of resources that can deliver a service, and the levels of service those resources can deliver in different environments.

DoDAF: NA

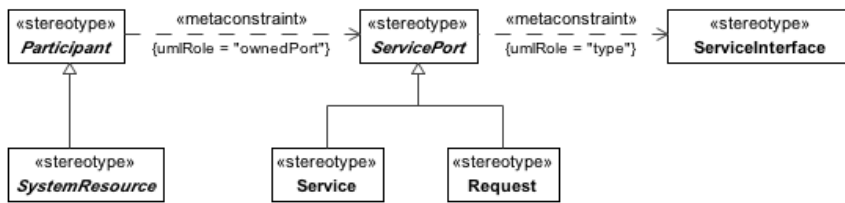

Figure B.37 - SV-12

B.1.6.7 SV-2/SvcV-2

MODAF: The Systems Communications Description (SV-2a/2b/2c) series of views is intended for the representation of communications networks and pathways that link communications systems, and provides details regarding their configuration.

DoDAF: A Systems Resource Flow Description (SV-2) DoDAF-described View specifies the resource flows between Systems and may also list the protocol stacks used in connections.

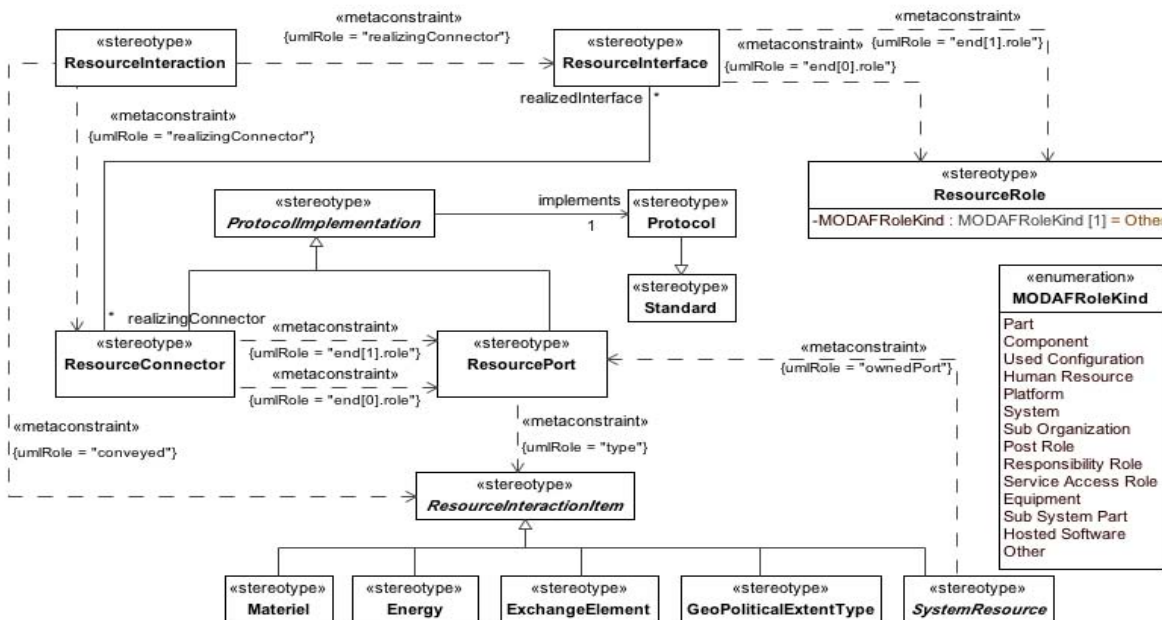

Figure B.38 - SV-2/SvcV-2

B.1.6.8 SV-3/SvcV-3a/SvcV-3b

MODAF: The Resource Interaction Matrix provides a tabular summary of the resource interactions specified in the SV-1 for the Architecture.

DoDAF: The Systems - Systems Matrix (SV-3) DoDAF-described View provides a tabular summary of the system interactions specified in the SV-1 for the Architecture.

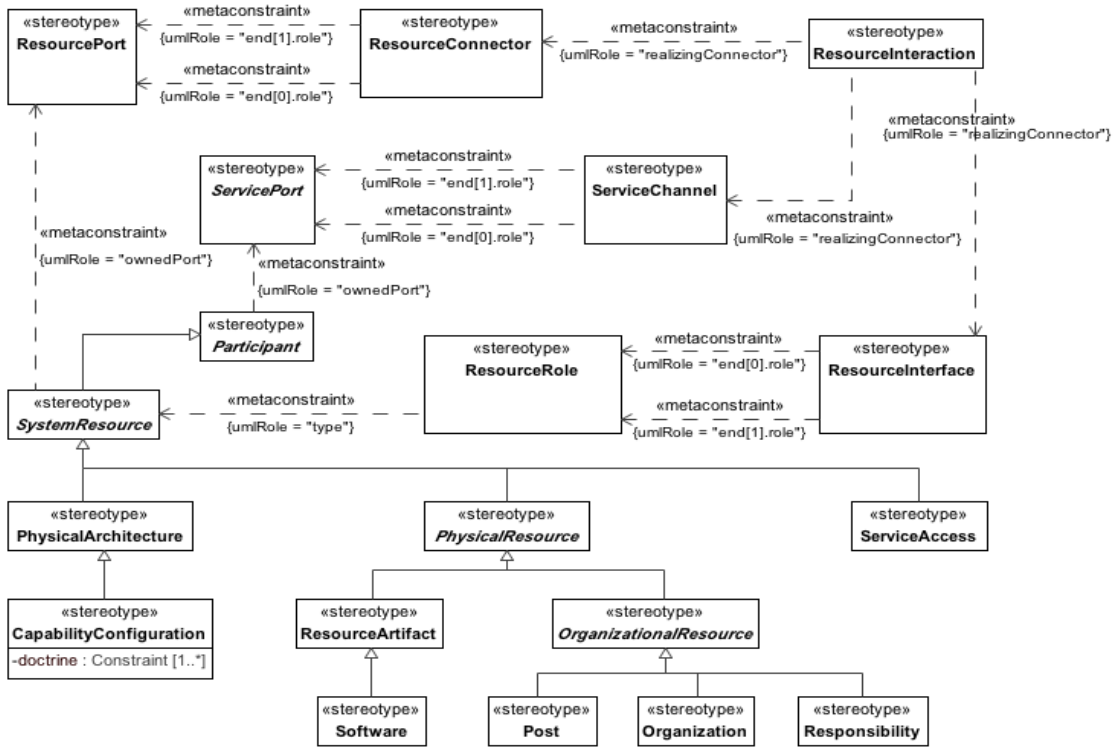

Figure B.39 - SV-3/SvcV-3a/SvcV-3b

B.1.6.9 SV-4/SvcV-4

MODAF: Functionality Descriptions (SV-4) address human and system functionality.

DoDAF: The Systems Functionality Description (SV-4) DoDAF-described View addresses human and system functionality.

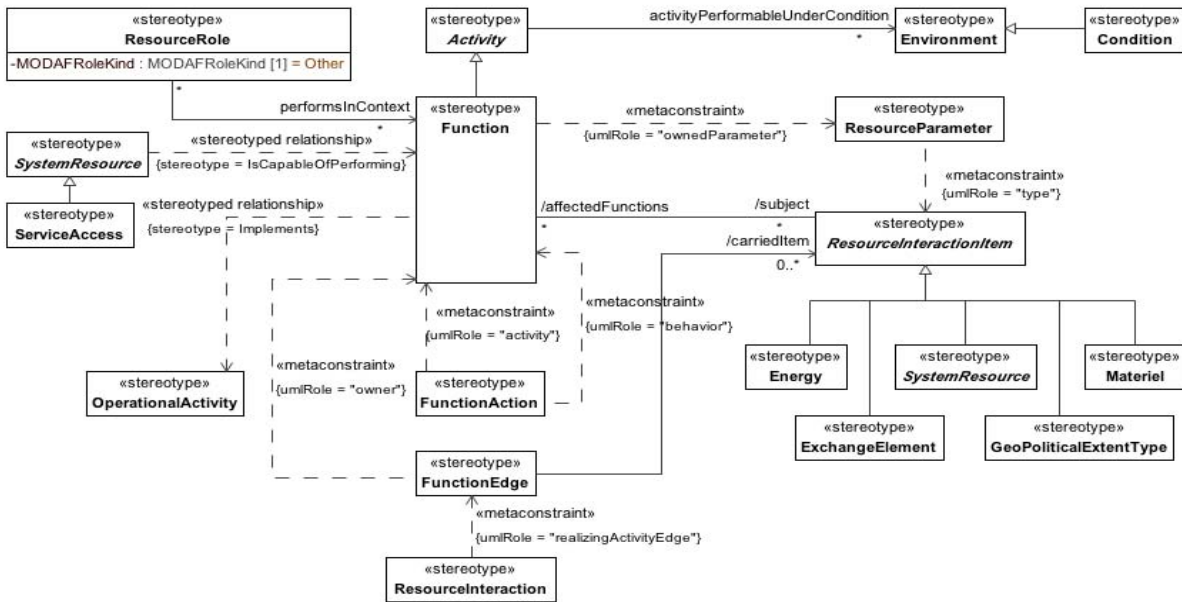

Figure B.40 - SV-4/SvcV-4

B.1.6.10 SV-5/SvcV-5

MODAF: This view has been expanded for the Service Orientated community by allowing for Service Functions as well as Operational Activities.

DoDAF: The Operational Activity to Systems Function Traceability Matrix (SV-5a) DoDAF-described View depicts the mapping of system functions (and, optionally, the capabilities and performers that provide them) to operational activities and thus identifies the transformation of an operational need into a purposeful action performed by a system or solution.

The Operational Activity to Systems Traceability Matrix (SV-5b) DoDAF-described View depicts the mapping of systems (and, optionally, the capabilities and performers that provide them) to operational activities and thus identifies the transformation of an operational need into a purposeful action performed by a system or solution.

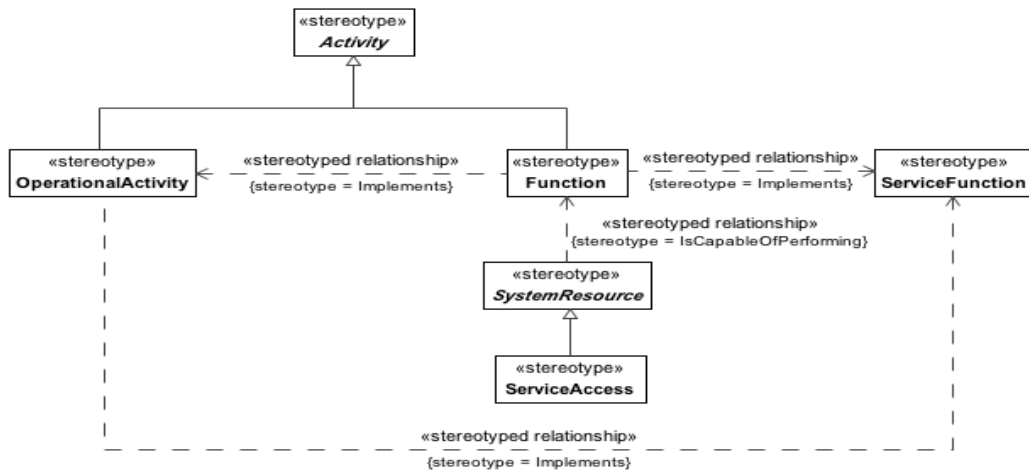

Figure B.41 - SV-5/SvcV-5

B.1.6.11 SV-6/SvcV-6

MODAF: The Systems Data Exchange Matrix specifies the characteristics of the system data exchanged between systems. The focus is on data crossing the system boundary.

DoDAF: The Systems Resource Flow Exchange Matrix DoDAF-described View specifies the characteristics of the system resource flows exchanged between systems. The focus is on resource crossing the system boundary.

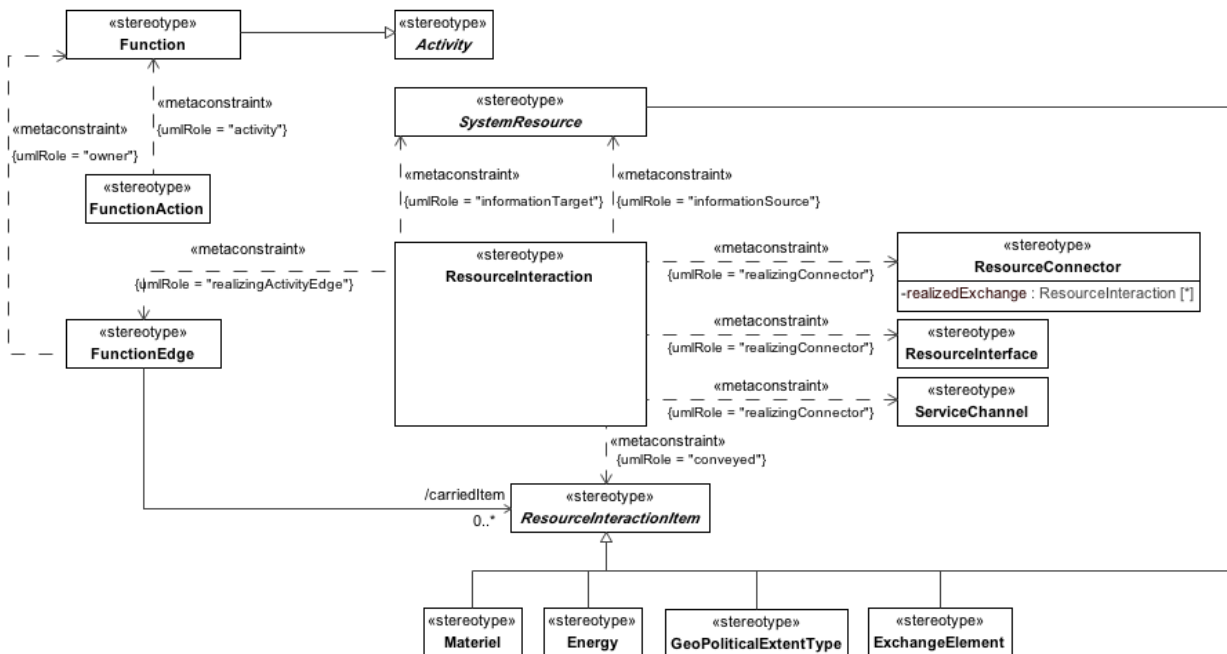

Figure B.42 - SV-6/SvcV-6

B.1.6.12 SV-7/SvcV-7

MODAF: The SV-7 is the Resource Performance Parameters Matrix and depicts the performance characteristics of a Resource (e.g., system, role or capability configuration).

DoDAF: The SV-7 DoDAF-described View is the Systems Measures Matrix and depicts the measures (metrics) of resources.

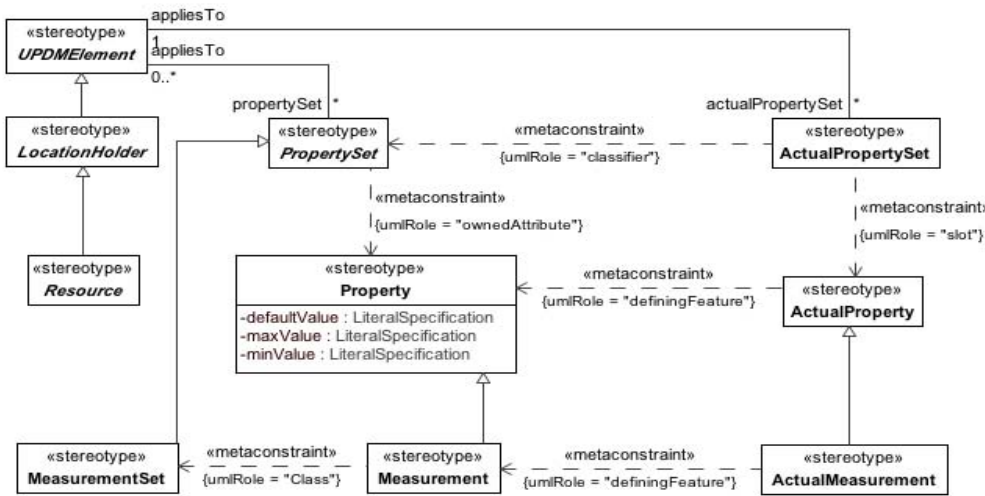

Figure B.43 - SV-7/SvcV-7

B.1.6.13 SV-8/SvcV-8

MODAF: The SV-8 provides an overview of how a capability configuration structure changes over time. It shows the structure of several capability configurations mapped against a timeline.

DoDAF: The Systems Evolution Description DoDAF-described View presents a whole lifecycle view of resources (systems), describing how it changes over time. It shows the structure of several resources mapped against a timeline.

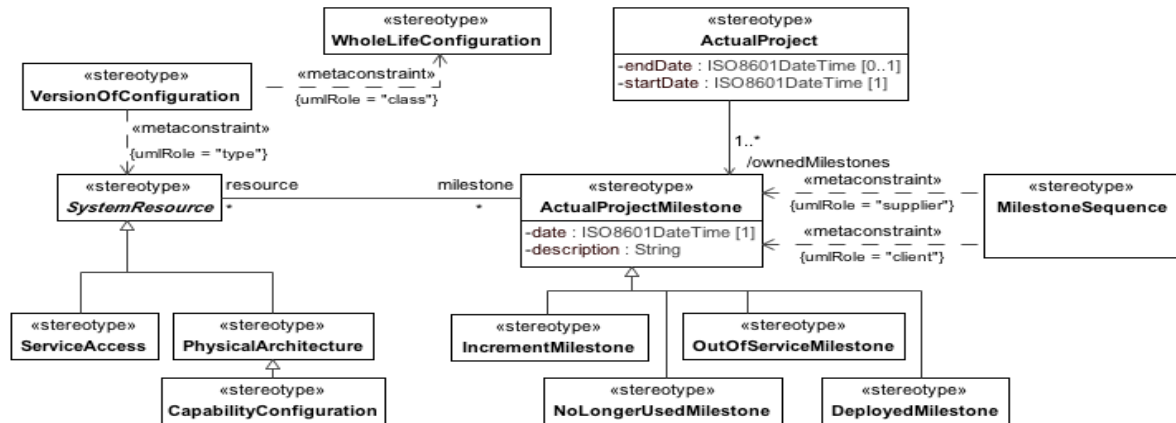

Figure B.44 - SV-8/SvcV-8

B.1.6.14 SV-9/SvcV-9

MODAF: The Technology & Skills Forecast defines the underlying current and expected supporting technologies and skills. Expected supporting technologies and skills are those that can be reasonably forecast given the current state of technology and skills, and expected improvements / trends. New technologies and skills will be tied to specific time periods, which can correlate against the time periods used in SV-8 milestones and linked to Enterprise Phases.

DoDAF: The Technology & Skills Forecast defines the underlying current and expected supporting technologies and skills. Expected supporting technologies and skills are those that can be reasonably forecast given the current state of technology and skills, and expected improvements / trends. New technologies and skills will be tied to specific time periods, which can correlate against the time periods used in SV-8 milestones and linked to Enterprise Phases.

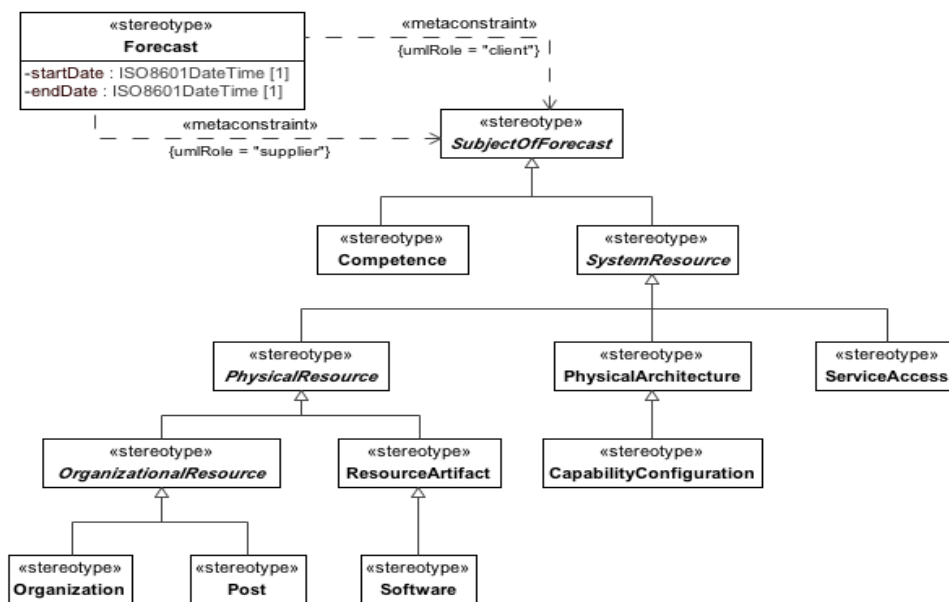

Figure B.45 - SV-9/SvcV-9

B.1.7 TV/StdV

MODAF: Technical Standards Views are extended from the core DoDAF views to include non-technical standards such as operational doctrine, industry process standards, etc.

DoDAF: The Standards Views within the Standards Viewpoint are the set of rules governing the arrangement, interaction, and interdependence of solution parts or elements.

B.1.7.1 TV-1&2&3/StdV-1&2

MODAF: Standards Profile (TV-1) defines the technical and non-technical standards, guidance and policy applicable to the architecture.

The Standards Forecast (TV-2) contains expected changes in technology-related standards and conventions, which are documented in the TV-1 Product.

DoDAF: The Standards Profile StdV-1 DoDAF-described View defines the technical, operational, and business standards, guidance and policy applicable to the architecture.

The StdV-2 Standards Forecast DoDAF-described View contains expected changes in technology related standards, operational standards, or business standards and conventions, which are documented in the StdV-1 view.

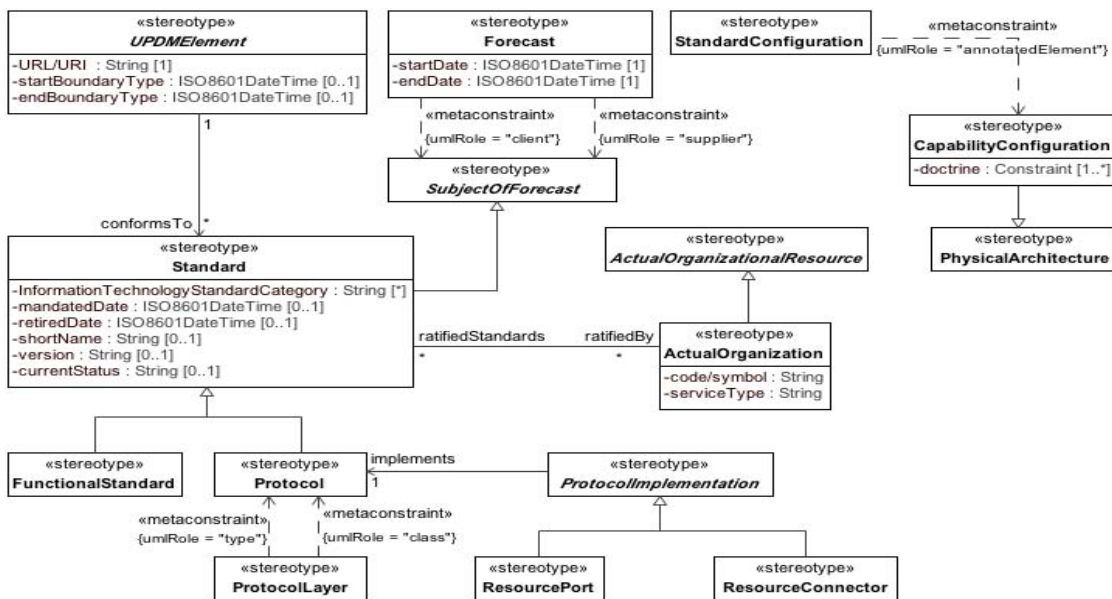

Figure B.46 - TV-1&2&3/StdV-1&2

Annex C - UPDM Elements Traceability

(non-normative)

This Annex shows the traceability among UPDM stereotypes and DODAF/MODAF/NAF elements. There are different tables for the different mapping.

This mapping does not show all the elements in UPDM 2.0 or DoDAF 2.0.2. the elements not shown relate to:

- Abstract elements in UPDM .
- Elements that map to PowerTypes or PowerTypeTypes in DoDAF 2.0 as these are collections of sets that are derived from Types.
- Elements from the IDEAS foundation model that should not appear as part of DoDAF 2.0 architecture.

C.1 DoDAF-DM2, UPDM, and MODAF Mapping

Table C.1 - DoDAF-DM2, UPDM, and MODAF Mapping

DoDAF-DM2 Term	UPDM Profile element	MODAF
Activity	Activity	Activity Composition
activityPartOfCapability	ActivityPartOfCapability	N/A
activityPartOfProjectType	ActivityPartOfProject	N/A
activityPerformableUnderCondition	activityPerformableUnderCondition	OperationalConstraint/ ResourceConstraint
instance of a Measure	ActualMeasurement	MeasurableProperty
Organization	ActualOrganization	ActualOrganisation
Organization	ActualOrganization	ActualOrganisation
N/A	ActualOrganizationRelationship	ActualOrganisationRelationship
N/A	ActualOrganizationRole	ActualOrganizationComposition
N/A	actualOrganizationRole for actualOrganization and actualPost.: broken down into three rows	ActualOrganisation/ ActualOrganizationComposition/ ActualPost
N/A	ActualPerson	N/A
N/A	ActualPost	ActualPost
IndividualPersonRole	ActualPost/ IndividualPersonRole	ActualPost
Project	ActualProject	Project
N/A	ActualProjectMilestone	ProjectMilestone
N/A	ActualProjectMilestoneRole	ProjectWholePart

Table C.1 - DoDAF-DM2, UPDM, and MODAF Mapping

N/A	ActualProperty	N/A
N/A	ActualPropertySet	N/A
Representation	Alias	Alias
informationPedigree	Annotated UPDM element	N/A
N/A	ArbitraryConnector	ArbitraryConnection
ArchitecturalDescription	ArchitecturalDescription	ArchitecturalDescription
N/A	ArchitecturalReference	ArchitecturalReference
Information	ArchitectureMetadata	ArchitectureMetadata
N/A	AsynchronousMessage	AsynchronousMessage
Capability	Capability	Capability
System	CapabilityConfiguration (MODAF) System (DoDAF)	CapabilityConfiguration
N/A	Climate	Climate
N/A	Command	Command
Skill	Competence	Competence
N/A	CompetenceProvider	N/A
SkillOfPersonRoleType	CompetenceRequirer	CompetenceForRole
wholePart	composition relationship	WholePart
Instance of a Performer in an operational context	ConceptRole	ItemInConcept
IndividualPerformer	ConceptRole/NodeRole/ResourceRole	Node/ExternalIndividual/ItemInConcept/ ResourceUsage
Condition	Condition	Condition
N/A	ConditionProperty	EnvironmentalProperty
measureTypeApplicableTo Activity	Constraint	N/A
N/A	Control	Control
activityProducesResource	Conveyed tag on System and FunctionEdges, implicit through direction	carried tag on OperationalActivityFlows
activityConsumesResource	Conveyed tag on System and FunctionEdges, implicit through direction	carried tag on OperationalActivityFlows
locationNamedByAddress	customkind on GeopoliticalExtent or LocationKind	N/A
N/A	DeployedMilestone	DeployedMilestone
representedBy	DescribedBy	Definition
desiredEffect	desiredEffect	N/A
desiredEffectDirectsActivity	desiredEffect	N/A

Table C.1 - DoDAF-DM2, UPDM, and MODAF Mapping

desiredEffectIsRealizedBy ProjectType	desiredEffect	N/A
desiredEffectOfCapability	desiredEffect	N/A
visionIsRealizedByDesired Effect	DesiredEffect	N/A
N/A	Details	definedBy
endBoundary	endBoundary tag	N/A
N/A	EnduringTask	EnduringTask
Materiel	Energy	Energy
N/A	EnterpriseGoal	EnterpriseGoal
N/A	EnterprisePhase	EnterpriseStructure
N/A	EnterprisePhase	EnterpriseStructure
N/A	EnterpriseVision	EnterpriseVision
N/A	EntityAttribute	Attribute
N/A	EntityItem	Entity
associationOfInformation	EntityRelationship	EntityRelationship
N/A	EntityRelationship	EntityRelationship
AssociationOfInformation	EntityRelationship/ AssociationOfInformation	EntityRelationship
Data	enumeration of information kind	DataElement
DomainInformation	Enumeration of InformationKind	N/A
PedigreeInformation	Enumeration of InformationKind	N/A
partiesToAnAgreement	Enumeration of Rulekind	N/A
Agreement	Enumeration of Rulekind applied to constraint	OperationalCosntraint, ResourceConstraint, ServicePolicy
Constraint	Enumeration of Rulekind applied to constraint	OperationalCosntraint, ResourceConstraint, ServicePolicy
Guidance	Enumeration of Rulekind applied to constraint	OperationalCosntraint, ResourceConstraint, ServicePolicy
N/A	Environment	Environment
N/A	EnvironmentProperty	EnvironmentalProperty
Resource	ExchangeElement	ResourceType
capabilityOfPerformer	Exhibits/CapabilityOfPerformer	CapabilityForNode
N/A	ExternalTuple	N/A
N/A	ExternalTupleType	N/A
N/A	ExternalType	ExternalType
N/A	FieldedCapability	FieldedCapability
N/A	FillsPost	N/A
N/A	Forecast	Forecast

Table C.1 - DoDAF-DM2, UPDM, and MODAF Mapping

Activity	Function	Function
N/A	FunctionAction	N/A
FunctionalStandard	FunctionalStandard	N/A
activityProducesResource / activityConsumesResource	FunctionEdge	FunctionEdge
GeoPoliticalExtent	GeoPoliticalExtent	NA
RealProperty	GeoPoliticalExtent with its GeoPoliticalExtentKind.	N/A
RealPropertyType	GeoPoliticalExtent with its GeoPoliticalExtentKind.	N/A
RegionOfCountry	GeoPoliticalExtent with its GeoPoliticalExtentKind.	N/A
regionOfCountryPartOfCountry	GeoPoliticalExtent with its GeoPoliticalExtentKind.	N/A
RegionOfCountryType	GeoPoliticalExtent with its GeoPoliticalExtentKind.	N/A
RegionOfWorld	GeoPoliticalExtent with its GeoPoliticalExtentKind.	N/A
RegionOfWorldType	GeoPoliticalExtent with its GeoPoliticalExtentKind.	N/A
Site	GeoPoliticalExtent with its GeoPoliticalExtentKind.	N/A
sitePartOfInstallation	GeoPoliticalExtent with its GeoPoliticalExtentKind.	N/A
SiteType	GeoPoliticalExtent with its GeoPoliticalExtentKind.	N/A
GeoPoliticalExtentType	GeoPoliticalExtentType	N/A
N/A	HighLevelOperationalConcept	HighLevelOperationalConcept
personRoleTypePartOf Performer	HumanResource or Organisation type as part of a Performer	N/A
N/A	Implements	ActivityToFunctionMapping
namedBy	implicit in Tools	N/A
portPartOfPerformer	Implicit in UML.	N/A
typeInstance	Implicit Type usage relationship in Tools	N/A
WholePart of Capability	IncrementMilestone	CapabilityIncrement
Information	Information	N/A
InformationType	InformationType	N/A
GeoStationaryPoint	Location with specific use of locationKind.	Location

Table C.1 - DoDAF-DM2, UPDM, and MODAF Mapping

Line	Location with specific use of locationTypeKind.	N/A
linePartOfPlanarSurface	Location with specific use of locationTypeKind.	N/A
Location (and all subtypes)	Location, ActualLocation and LocationTypeKind	ActualLocation
resourceInLocationType	LocationHolder (abstract)	N/A
LocationType	LocationType	Location
axesDescribedBy	LocationType with specific use of locationTypeKind.	Location
CircularArea	LocationType with specific use of locationTypeKind.	Location
CircularAreaType	LocationType with specific use of locationTypeKind.	Location
coordinateCenterDescribedBy	LocationType with specific use of locationTypeKind.	Location
EllipticalArea	LocationType with specific use of locationTypeKind.	Location
EllipticalAreaType	LocationType with specific use of locationTypeKind.	Location
Facility	LocationType with specific use of locationTypeKind.	Location
facilityPartOfSite	LocationType with specific use of locationTypeKind.	Location
FacilityType	LocationType with specific use of locationTypeKind.	Location
GeoStationaryPointType	LocationType with specific use of locationTypeKind.	Location
LineType	LocationType with specific use of locationTypeKind.	N/A
PlanarSurface	LocationType with specific use of locationTypeKind.	Location
PlanarSurfaceType	LocationType with specific use of locationTypeKind.	N/A
Point	LocationType with specific use of locationTypeKind.	Location
pointPartOfLine	LocationType with specific use of locationTypeKind.	Location
pointPartOfPlanarSurface	LocationType with specific use of locationTypeKind.	Location
PointType	LocationType with specific use of locationTypeKind.	Location

Table C.1 - DoDAF-DM2, UPDM, and MODAF Mapping

PolygonArea	LocationType with specific use of locationTypeKind.	Location
PolygonAreaType	LocationType with specific use of locationTypeKind.	Location
PositionReferenceFrame	LocationType with specific use of locationTypeKind.	Location
RectangularArea	LocationType with specific use of locationTypeKind.	Location
RectangularAreaType	LocationType with specific use of locationTypeKind.	Location
RectangularAreaTypeType	LocationType with specific use of locationTypeKind.	Location
SolidVolume	LocationType with specific use of locationTypeKind.	Location
SolidVolumeType	LocationType with specific use of locationTypeKind.	Location
Surface	LocationType with specific use of locationTypeKind.	Location
SurfaceType	LocationType with specific use of locationTypeKind.	Location
Performer	LogicalArchitecture	LogicalArchitecture
DiV-1/Div-2	LogicalDataModel	LogicalDataModel
activityMapsToCapability	MapsToCapability	ActivityMapsToCapability
Materiel	Materiel	Artefact
AdaptabilityMeasure	Measurement	MeasurableProperty
MaintainabilityMeasure	Measurement	MeasurableProperty
Measure	Measurement	MeasurableProperty
NeedsSatisfactionMeasure	Measurement	MeasurableProperty
OrganizationalMeasure	Measurement	MeasurableProperty
PerformanceMeasure	Measurement	MeasurableProperty
PhysicalMeasure	Measurement	MeasurableProperty
ServiceLevel	Measurement	MeasurableProperty
SpatialMeasure	Measurement	MeasurableProperty
TemporalMeasure	Measurement	MeasurableProperty
desireMeasure	MeasurementSet	N/A
effectMeasure	MeasurementSet	N/A
MeasureableSkill	MeasurementSet	N/A
measureableSkillOfPersonRole Type	MeasurementSet	N/A
MeasureOfEffect	MeasurementSet	N/A

Table C.1 - DoDAF-DM2, UPDM, and MODAF Mapping

measureOfIndividual	MeasurementSet	N/A
measureOfIndividualEnd Boundary	MeasurementSet	N/A
measureOfIndividualPoint	MeasurementSet	N/A
measureOfIndividualStart Boundary	MeasurementSet	N/A
measureOfType	MeasurementSet	N/A
measureOfTypeActivity	MeasurementSet	N/A
measureOfTypeCondition	MeasurementSet	N/A
measureOfTypeProjectType	MeasurementSet	N/A
measureOfTypeResource	MeasurementSet	N/A
MeasureOfDesire	MeasuremetSet	N/A
MeasureType	MeasureType	N/A
Information	Metadata	Metadata
N/A	MilestoneSequence	MilestoneSequence
Mission	Mission	Mission
Name	Name is implicit in Tools	N/A
Needline (but not officially in DM2)	Needline	Needline
Node	Node	Node
N/A	NodeOperation	N/A
N/A	NodeParent	NodeParent
Port	NodePort, ResourcePort	ResourcePort/SystemPort
IndividualPerformer	NodeRole	N/A
N/A	NoLongerUsedMilestone	StatusAtMilestone
PedigreeInformation	OntologyReference	OntologyReference
Activity	OperationalActivity	OperationalActivity
Activity	OperationalActivityAction	OperationalActivityAction
activityProducesResource / activityConsumesResource	OperationalActivityEdge	OperationalActivityEdge
Rule	OperationalConstraint	OperationalConstraint
N/A	OperationalEventTrace	OperationalEventTrace
N/A	OperationalExchange	OrganizationalExchange, EnergyExchange, MaterielExchange, ConfigurationExchange, GeoPoliticalExtent
N/A	OperationalParameter	N/A
N/A	OperationalState	N/A
N/A	OperationalStateDescription	OperationalStateDescription

Table C.1 - DoDAF-DM2, UPDM, and MODAF Mapping

Organization	Organization	ActualOrganisation
N/A	OrganizationalProjectRelationship	OrganizationalProjectRelationship
OrganizationType	OrganizationType	OrganisationType
N/A	OutOfServiceMilestone	N/A
describedBy	ownedelement description in UML	N/A
activityPerformedByPerformer	OwnsProcess	ProcessOwner
Performer	Participant	N/A
Performer	Performer	Node
activityPerformedByPerformer	Performs/ ActivityPerformedByPerformer	NodeHasBehaviour/FunctionsUpon/ ActsUpon
N/A	Person	N/A
whole part of a PersonRoleType	PersonType	N/A
System	PhysicalArchitecture	PhysicalArchitecture
DIV-3	PhysicalDataModel	PhysicalDataModel
Performer	PhysicalResource	PhysicalAsset
PersonRoleType	Post	PostType
N/A	Process	Process
Project	Project	Project
Activity	ProjectActivity	N/A
N/A	ProjectMilestone	ProjectMilestone
N/A	ProjectMilestoneRole	N/A
N/A	ProjectOwnership	ProjectOwnership
N/A	ProjectSequence	ProjectSequence
N/A	ProjectStatus	ProjectStatus
N/A	ProjectTheme	ProjectTheme
ProjectType	ProjectType	ProjectType
N/A	Property	N/A
N/A	PropertySet	N/A
N/A	Protocol	Protocol
TechnicalStandard	ProtocolImplementation	ProtocolImplementation
TechnicalStandard	ProtocolLayer	ProtocolLayer
skillOfPersonRoleType	ProvidesCompetence	ProvidesCompetence
ServicePort	Request	Requires
skillOfPersonRoleType	RequiresCompetence	CompetenceForRole
Materiel	ResourceArtifact	Artefact
N/A	ResourceConnector	SystemPortConnector
N/A	ResourceEventTrace	N/A

Table C.1 - DoDAF-DM2, UPDM, and MODAF Mapping

N/A	ResourceInteraction	ResourceInteraction
Data	ResourceInteractionItem	DataElement
portPartOfPerformer/ Port	ResourceInterface	N/A
N/A	ResourceOperation	N/A
N/A	ResourceParameter	N/A
materielPartOfPerformer	ResourceRole of Performer	N/A
N/A	ResourceState	N/A
N/A	ResourceStateMachine	N/A
N/A	Responsibility	N/A
PersonRoleType	RoleType	
Rule	Rule	Standard
ruleConstrainsActivity	Rule with specific RuleKind	OperationalConstraint/ ResourceConstraint
N/A	SameAs	SameAs
SecurityAttributesGroup	SecurityAttributesGroup	N/A
Grouping of organisations sharing a common security policy	SecurityDomain	N/A
Service	Service/Request	Service
serviceEnablesAccessToResource	Service/Request through ownedPort	ProvideService/RequiredService
ServicePort	ServiceAccess	N/A
ServicePort	ServiceAccess (DoDAF)	N/A
N/A	ServiceAttribute	ServiceAttribute
ServiceDescription	ServiceDescription	N/A
servicePortDescribedBy	Servicedescription, service interface, ServiceLevel	N/A
N/A	ServiceFeature	N/A
Activity	ServiceFunction	ServiceFunction
N/A	ServiceFunctionAction	N/A
activityProducesResource / activityConsumesResource	ServiceFunctionEdge	N/A
ServiceInteractionSpecification	ServiceInteraction	ServiceInteractionSpecification
ServiceDescription	ServiceInterface	ServiceInterface
ServiceLevel	ServiceLevelValue	ServiceLevelValue
N/A	ServiceLevelValueSet	ServiceLevelValueSet
N/A	ServiceMessage	N/A
N/A	ServiceMessageHandler	N/A
N/A	ServiceOperation	ServiceInterfaceOpration

Table C.1 - DoDAF-DM2, UPDM, and MODAF Mapping

N/A	ServiceParameter	ServiceInterfaceParameter
Agreement	ServicePolicy	ServicePolicy
ServicePort	ServicePort	ServiceInterface
N/A	ServiceStateMachine	N/A
Skill	Skill	Competence
Skill	Skill	Skill
skillOfPersonRoleType	SkillOfPersonType	ProvidesCompetence/ RequiresCompetence
Materiel	Software	Software
FunctionalStandard	Standard	Standard
Standard	Standard	Standard
N/A	StandardConfiguration	StandardConfiguration
Activity	StandardOperationalActivity	StandardOperationalActivity
startBoundary	startBoundary tag	N/A
N/A	StatusIndicators	StatusIndicator
N/A	StereotypeExtension	StereotypeExtension
Address	String on ActualLocation	Location
MeasureTypeUnitsOfMeasure	SysML DimensionType	N/A
System	System	ResourceArtifact/ Capability Configuration
TechnicalStandard	TechnicalStandard	Standard
N/A	TemporalPart	EnterpriseTemporalPart
N/A	Trustline	Trustline
N/A	Trustline	Trustline
superSubType	UML inheritance	N/A
Country	Use GeoPoliticalExtent with appropriate geopoliticalExtentKind	N/A
GeoFeature	Use GeoPoliticalExtent with appropriate geopoliticalExtentKind	Location
Installation	Use GeoPoliticalExtent with appropriate geopoliticalExtentKind	N/A
InstallationType	Use GeoPoliticalExtent with appropriate geopoliticalExtentKind	N/A
CountryType	Use GeoPoliticalExtenttype with appropriate geopoliticalExtentTypeKind	N/A
GeoFeatureType	Use GeoPoliticalExtenttype with appropriate geopoliticalExtentTypeKind	Location
N/A	VersionOfConfiguration	VersionOfConfiguration

Table C.1 - DoDAF-DM2, UPDM, and MODAF Mapping

N/A	View	View
N/A	Viewpoint	Viewpoint
Vision	Vision	EnterpriseVision/ VisionStatement
Vision	VisionStatement	VisionStatement
N/A	WholeLifeConfiguration	WholeLifeConfiguration
N/A	WholeLifeEnterprise	WholeLifeEnterprise

C.2 UPDM to NAF Elements Traceability

NAF 3.1 was based on MODAF 1.2.003 and contains a few additions compared to MODAF. If it is compared with MODAF 1.2.004 the number of differences increases. However, the intent of the differences are approximately the same as the additions made in 1.2.004 with some exceptions such as security handling etc. Based on the limited number of difference between the two meta-models, it is a simple statement of fact that UPDM fully supports NAF.

The list below itemizes the differences between NAF 3.1 and MODAF 1.2.003 with some explanations as to why they are there.

Table C.2 shows the traceability among UPDM stereotypes and NAF 3.1 elements.

Table C.2 - NAF 3.1 and MODAF View Comparison

NAF View/Element	MODAF View/Element
NAV-1 Overview and summary information	AV-1 Overview and summary information
NAV-1 Architectural Product	AV-1 Architectural product
NAV-2 Integrated dictionary	AV-2
NAV-3 Metadata	-
The following two views contain elements that are already in AV-2 in MODAF and a specific view in order to textually describe architecture compliance	
NAV-3a Architecture compliance statement	
NAV-3b Metadata extensions	
NAV Effectivity	Effectivity
NAV Environment	Environment
NAV Measurable properties	Measurable properties

Table C.2 - NAF 3.1 and MODAF View Comparison

NAV Requirements	Requirements
NCV-1 Capability vision	StV-1
NCV-2 Capability taxonomy	StV-2
NCV-3 Capability phasing	StV-3
NCV-4 Capability dependencies	StV-4
NCV-5 Capability to organizational deployment mapping	StV-5
NCV-6 Operational activity to capability mapping	StV-6
NOV-1 High level operational concept description	OV-1
NOV-2 Operational node relationship description	OV-2
NOV-3 Operational information exchange matrix	OV-3
NOV-4 Organizational relationships chart Typical	OV-4 Typical
NOV-4 Organizational relationships chart Actual	OV-4 actual
NOV-5 Operational activity model	OV-5
NOV-6 Operational activity sequence and timing description	OV-6
NOV-6a Operational rule model	OV-6a
NOV-6b Operational state transition description	OV-6b
NOV-6c Operational event-trace description	OV-6c
NOV-7 Information model	OV-7
NSOV-1 Service taxonomy	SOV-1
NSOV-2 Service definition	SOV-2
NSOV-3 Capability to service mapping	SOV-3
NSOV-4 Service constraints, state model and interaction specification	SOV-4

Table C.2 - NAF 3.1 and MODAF View Comparison

SOV-5 Service functionality	SOV-5
NSOV-6 Service composition	-
<p>The NSOV-6 Service composition view has a complicated history. When the service views were created in MODAF 1.1 and included as proposed it was placed as SOV-3. When MODAF 1.2 was created it was not included since the appreciation of what the intent was less than clear in MOD. The elements that were needed to create it still exist in the MODAF meta-model and this is still the case in MODAF 1.2.004. When NAF 3.1 as created the view was retained but in order to align with MODAF 1.2.003 it was moved from its original place and became view NSOV-6 instead of 3. The reasoning behind this view has to do with reuse of existing specifications of services and therefore ties together with any discussion concerning the separation of the SoaML concept of service and the specification of services which is what both the NAF and MODAF views are about.</p>	
NSV-1 Resource Interaction specification	SV-1
NSV-1 Resources specification	SV-1
NSV Competence	Competence
NSV-2 Systems communications description	
NSV-2a System port specification	SV-2a
NSV-2b System port connectivity	SV-2b
NSV-2c System connectivity clusters	SV-2c
NSV-2d Systems communications quality requirements -	
<p>The NSV-2d Systems communications quality requirements view contains exactly the same elements as NSV-2b with the exception of one additional element namely Network. This is unique to NAF and is a specialization of System. Since it has no additional relationships or attributes, it is essentially equivalent to System.</p>	
NSV-3 Resource Interaction Matrix	SV-3
NSV-4 System Functionality description	SV-4
NSV-5 System function to operational activity traceability matrix	SV-5
NSV-6 Systems data exchange matrix	SV-6
NSV-7 System quality requirements description	SV-7
NSV-8 System configuration management	SV-8
NSV-9 Technology and skills forecast	SV-9

Table C.2 - NAF 3.1 and MODAF View Comparison

NSV-10 Resource constraints, state transitions and even-trace description	SV-10
NSV-10a Resource constraints specification	SV-10a
NSV-10b Resource state transition description	SV-10b
NSV-10c Resource event trace description	SV-10c
NSV-11 System data model -	
NSV-11a Logical data model -	The meta-model for this is the same as for NOV-7. The level of detail differs however.
NSV-11b Physical data model	SV-11
NSV-12 Service provision	SV-12
NTV-1&2 Standards profile and standards forecast	TV-1&2
NTV-3 Standard configurations	TV-3
NPV-1 Programme portfolio relationships	AcV-1
NPV-2 Programme to capability mapping	AcV-2

C.2.1 Element additions in NAF 3.1 compared to MODAF 1.2.003

AV: ArchitectureComplianceStatement - A comment stereotype enabling statements of architectural compliance that can be attached to various elements.

OV: OperationalActivityFlowItem - An element created in order to allow transfer of other things between activities than information elements. A slightly different way was used to achieve the same purpose in MODAF 1.2.004. Supported in UPDM.

OperationalExchangeMessage - An element intended to allow the handling of messages in an NOV-6c showing other things than just information elements. A slightly different mechanism was used to achieve the same purpose in MODAF 1.2.004. Supported in UPDM.

SV: Energy (Class) - Inserted to handle UPDM 1.0 Energy. Is contained in MODAF 1.2.004. Supported in UPDM.

FunctionAction (CallBehaviorAction) - Inserted to make NSV-4 equivalent to NOV-5. Done in MODAF 1.2.004 but differently. Supported in UPDM.

FunctionComposition (Association) - Inserted to allow decomposition of functions. Not included explicitly in MODAF 1.2.004. Supported in UPDM.

FunctionFlowItem - A system equivalent of OperationalActivityFlowItem. Done in MODAF 1.2.004 but differently. Supported in UPDM.

FunctionInputPin - Inserted to make NSV-4 equivalent to NOV-5. Done in MODAF 1.2.004 but differently. Supported in UPDM.

FunctionOutputPin - Inserted to make NSV-4 equivalent to NOV-5. Done in MODAF 1.2.004 but differently. Supported in UPDM.

Network (Property) - A specialization of System desired by NATO. Not included in MODAF 1.2.004. Not supported in UPDM.

ResourceExchangeMessage (Message) - Inserted in order to allow sequence diagrams to show something other than information elements. Done in MODAF 1.2.004 but differently. Supported in UPDM.

ResourcesWithMaterielContent (Class) - Inserted as a container for various items enabling exchange of material as well as whole capability configurations. Not done in MODAF 1.2.004 implying that physical architectures or capability configurations cannot be exchanged in MODAF 1.2.004. Supported in UPDM.

C.2.2 DoDAF 2.0 to MODAF 1.2 Views Traceability

Table C.3 shows the traceability between the DoDAF 2.0 and MODAF 1.2 views. It is evident from the table that there is sufficient mapping between the vast majority of the views.

Table C.3

DoDAF 2 views	MODAF 1.2 views	Comment
AV-1 Overview and summary	AV-1 Overview and summary information	-
AV-2 Integrated dictionary	AV-2 Integrated dictionary	-
OV-1 High level operational concept graphic description	OV-1a High Level Operational Concept Graphics, OV-1b Operational Concept Description, OV-1c Operational Performance attributes	-
OV-2 Operational resource flow description	OV-2 Operational Node Relationships Description	-
OV-3 Operational Resource flow matrix	OV-3 Operational Information Exchange Matrix	-
OV-4 Organisational relationships chart	OV-4 Organisational Relationships Chart	-
OV-5a Operational activity decomposition tree	OV-5 Operational Activity Model	Both DoDAF diagrams is dealt with in the same MODAF diagram
OV-5b Operational activity model	OV-5 Operational Activity Model	Both DoDAF diagrams is dealt with in the same MODAF diagram
OV-6a Operational rules model	OV-6a Operational Rules Model	-

Table C.3

OV-6b State transition description	OV-6b Operational state transition description	-
OV-6c Event-trace description	OV-6b Operational event-trace description	-
StdV-1 Standards profile	TV-1 Standards profile	-
StdV-2 Standards forecast	TV-2 Standards forecast	-
PV-1 Project portfolio relationships	AcV-1 Acquisition clusters	-
PV-2 Project timelines	AcV-2 Programme timelines	-
PV-3 Project to capability mapping	-	It is difficult to see any difference to this and CV-3 Capability phasing. At least it is covered by StV-3 Capability phasing.
CV-1 Vision	StV-1 Enterprise vision	-
CV-2 Capability taxonomy	StV-2 Capability taxonomy	-
CV-3 Capability phasing	StV-3 Capability phasing	-
CV-4 Capability dependencies	StV-4 Capability dependencies	-
CV-5 Capability to organisational mapping	StV-5 Capability to organisation deployment mapping	-
CV-6 Capability to operational activities mapping	StV-6 Operational activity to capability mapping	It should be noted that DoDAF has no counterpart of StandardOperationalActivities which is the reason behind this view in MODAF.
CV-7 Capability to services mapping	SOV-3 Capability to service mapping	See handling of services below since this is where the connection break down between MODAF and DoDAF 2.0 to a large extent.
DIV-1 Conceptual data model	-	This looks like the NAF 3.1 NOV-7 concept but has no direct counterpart in MODAF.
DIV-2 Logical data model	OV-7 Information Model	-
DIV-3 Physical data model	SV-11 Physical schema	-
SV-1 Systems interface description	SV-1 Resources interaction specification	-

Table C.3

SV-2 Systems resource flow description	SV-2a System port specification, SV-2b System to system port connectivity description, SV-2c System connectivity clusters	-
SV-3 Systems - systems matrix	SV-3 Resource interaction matrix	-
SV-4 Systems functionality description	SV-4 Functionality description	-
SV-5a Operational activity to systems traceability matrix	-	There is no direct counterpart to this traceability in a direct form in MODAF.
SV-5b Operational activity to systems function traceability matrix	SV-5 Function to Operational activity traceability matrix	-
SV-6 Systems resource flow matrix	SV-6 Systems data exchange matrix	-
SV-7 Systems measures matrix	SV-7 Resource performance parameters matrix	-
SV-8 Systems - systems evolution matrix	SV-8 Capability configuration management	-
SV-9 Systems technology & skills forecast	SV-9 Technology and skills forecast	-
SV-10a Systems rules model	SV-10a Resource constraints specification	-
SV-10b Systems state transition description	SV-10b Resource state transitions description	-
SV-10c Systems event-trace description	SV-10c Resource event-trace description	-
Services handling in MODAF 1.2.004 and DoDAF 2.0	The services concept in MODAF and DoDAF differ significantly, they are therefore treated differently in this table with connections shown only when a limited semblance exists. The MODAF or DoDAF counterparts here are written in italics.	
-	SOV-1 Service taxonomy	No formal taxonomy view for services exist in DoDAF 2.0
-	SOV-2 Service interface specification	SvcV-2 is a possible candidate but the definitions in MODAF go a lot deeper than in DoDAF 2.0. The comparison also disregards the fact that services in MODAF are specifications of services whereas services in DoDAF seems to describe implementations in specific performers, albeit somewhat more abstract than real implementation descriptions. This is a general caveat and applies to all MODAF view comments below.

Table C.3

-	SOV-3 Capability to service mapping	Presumably this maps somewhat to CV-7 in DoDAF 2. The general caveat applies.
-	SOV-4a Service constraints	This maps somewhat to SvcV-10a in DoDAF 2. The general caveat applies.
-	SOV-4b Service state model	This maps somewhat to SvcV-10b in DoDAF 2. The general caveat applies.
-	SOV-4c Service interaction specification	This maps somewhat to SvcV-10c in DoDAF 2. The general caveat applies.
-	SOV-5 Service functionality	This maps somewhat to SvcV-4 in DoDAF 2. The general caveat applies.
-	SV-12a Service provision	This maps somewhat to SvcV-1 in DoDAF 2. Since this discusses realisations of services the mapping may well be somewhat stronger than previously described. DoDAF Service would here be viewed as ServiceLevel in MODAF.
-	SV-12b Service composition	This maps somewhat to SvcV-2 in DoDAF 2. Since this discusses realisations of services the mapping may well be somewhat stronger than previously described. DoDAF Service would here be viewed as ServiceLevel in MODAF.
SvcV-1 Services context description	SV-12a Service provision	See above
SvcV-2 Services resource flow description	SV-12b Service composition	See above
SvcV-3a Systems - services matrix	SV-12a Service provision	The MODAF reference is not a Matrix, the data intended should be derivable from this MODAF view however.
SvcV-3b Services - services matrix	SV-12b Service composition	The MODAF reference is not a Matrix, the data intended should be derivable from this MODAF view however.
SvcV-4 Services functionality description	SOV-5 Service functionality, (perhaps more SV-4)	The general caveat applies.
SvcV-5 Operational activity to services traceability	SV-5 Service function to Operational activity traceability matrix.	The general caveat applies.
SvcV-6 Services resource flow matrix	SV-12a Service provision	See above
SvcV-7 Services measures matrix	SV-7 Resource performance parameters matrix	The general caveat applies.

Table C.3

SvcV-8 Services evolution description	SV-8 Capability configuration management	The general caveat applies.
SvcV-9 Services technology & skills forecast	SV-9 Technology and skills forecast	The general caveat applies.
SvcV-10a Services rules model	SOV-4a Service constraints perhaps more SV-10a.	The general caveat applies.
SvcV-10b Services state transition description	SOV-4b Service state model perhaps more SV-10b	The general caveat applies.
SvcV-10c Services event-trace description	SOV-4c Service interaction specification perhaps more SV-10c	The general caveat applies.

Annex D - Sample Problem

(non-normative)

D.1 Purpose

The purpose of this annex is to illustrate how UPDM can support DODAF and MODAF requirements for organizations developing Network Enabled Capability (NEC) systems using some of the basic features of the specification. This example provides a model which illustrates a sample of DoDAF and MODAF views addressing the problem space described below.

D.2 Scope

The scope of this example is to provide diagrams for the views (DoDAF Models) that are most used and most requested by the defense community. The intent is to select portions of the sample problem to illustrate how the diagrams can be applied, and demonstrate some of the possible interrelationships among the model elements in the different diagrams. The sample problem does not highlight all of the features of the specification as that would take several hundred pages.

D.3 Problem Scenario

D.3.1 Problem Domain Suitability

The problem domain is civilian maritime search and rescue (SAR). Civilian SAR was selected for several reasons:

- UK MODAF 1.1 has previously used this domain to illustrate its framework¹.
- The scenario and modeling was easily updated to include UPDM concepts including US DoDAF 2.0.
- SAR is internationally recognized problem domain with easy-to-recognize typical scenarios.
- SAR is based on publicly available International Agreements² and implementing or conforming National Plans including the US³ and the UK⁴.

-
1. See Acknowledgements
 2. See for example, International Aeronautical and Maritime Search and Rescue (IAMSAR) Manual, 2007 ed., 6th ed. London: IMO; Montreal: ICAO, 2007. IAMSAR Manual is by jointly published by the International Maritime Organization (IMO) and the International Civil Aviation Organization (ICAO). It consists of a three volume set: Volume I is Organization and Management; Volume II is Mission Coordination; & Volume III is Mobile Facilities.
 3. See for example, U.S.National Search and Rescue Supplement (NSS) to the International Aeronautical and Maritime Search and Rescue Manual. National Search and Rescue Plan of the United States (US National SAR Plan). [http://www.uscg.mil/hq/cg5/cg534/manuals/Natl_SAR_Plan\(2007\).pdf](http://www.uscg.mil/hq/cg5/cg534/manuals/Natl_SAR_Plan(2007).pdf)
 4. See for example, Search and Rescue Framework for the United Kingdom of Great Britain and Northern Ireland, Queen's Printer and Controller, June 2002. (Published by MCGA - Maritime & Coastguard Agency, Spring Place, 105 Commercial Road, Southampton. SO15 IEG.) "The organization for Search and Rescue (SAR) in the UK is an amalgam of separate Governments Departments, the emergency services, and other organizations. A number of charities and voluntary organizations dedicated to SAR also play a significant role. The purpose of this document is to provide a management framework for SAR in the UK. (back cover)" http://www.mcga.gov.uk/c4mca-uk/mcga-uk_sar_framework_document.pdf

- The documentation is generally unclassified as opposed to many equivalent defense or military plans.
- Subject matter experts and periodicals are readily available.¹
- The domain is sufficiently large and complex involving mixed human, software, and hardware solutions. As such, it will support the current specification that includes parametric modeling from systems engineering (SysML)² as well as future evolutions of UPDM that may include more national and multinational architecture frameworks. Several of the countries share usage of the same automated information systems and sensors.

D.3.2 Acknowledgements

The scenario is derived from the UK Search and Rescue framework, which is publicly available on the internet³. The sample problem is based on a concept derived by VEGA under contract for the UK MOD.⁴ The UPDM Group acknowledges its debt owed to the authors of the original problem:

- Ian Bailey of Model Futures,
- Peter Bryant of Logica, and
- Paul King of Vega

We have modified it to make it more generic in order to allow it to apply to SAR architecture for any country. This allows us to communicate the use of UPDM without the need for too much detail or getting involved in the particular procedures of any given country. Consequently, there will be “errors” in the specifics of the procedures. Any suggestions on how to improve the model would of course be gratefully received by the UPDM group.

D.3.3 Summary

We have included as many of the UPDM diagrams as is possible given that the tools for creating diagrams compliant with UPDM 2.0 will not be created until after the release of this specification. In addition, presenting an architecture is something like telling a story with the exception that in this case the elements interrelate to an extent that it is difficult to pick a natural order. Consequently we have decided to present them by view as that will at least make them easier to find when attempting to cross reference them. As UPDM 1.0 has more in common with MODAF 1.2, the models were created in the MODAF version of UPDM and the labels changed to correspond to DoDAF 2.0 terminology.

Anyone familiar with the terminology in DoDAF 2.0 and MODAF 1.2 is aware that the two architecture frameworks are different. In order to avoid having to show a MODAF and a DODAF diagram for each example, simple variants for each diagram are described. Where they are significantly different duplicate diagrams are shown.

-
1. See for example, ON SCENE - The Journal of U.S. Coast Guard Search and Rescue. Summer 2008, “Exceptional SAR Stories,” pp. 29-40 for more detailed scenarios similar to the Problem Scenario and Fall 2003, “SPECIAL SECTION - SAR Case Studies: A Review,” pp. 18-28 regarding performance standards.
 2. See USCG, “SAR System Performance Benchmark” - “Percent of lives saved from imminent danger in the maritime environment” and sub benchmarks. http://uscg.mil/hq/cg5/cg534/SAR_Program_Info.asp (Current as of 29 April 2009).
 3. See “MODAF: Examples: Search and Rescue Example: and the corresponding files are at http://www.modaf.org.uk/file_download/33/SAR.zip (as of 29 April 2009)
 4. <http://www.modaf.org.uk/vExamples/163/search-and-rescue-example>

D.3.4 The “Yacht in Distress” Scenario

The Sample Problem applies UPDM to a common scenario in civilian maritime Search and Rescue (SAR) operations -- a yacht in distress. A monitoring unit picks up the distress signal from the yacht and passes it on to the Command and Control (C2) Center. The C2 Center coordinates the search and rescue operation among helicopters, a naval ship and a civilian voluntary sea rescue organization. This section is structured to show each diagram in the context of how it might be used in such an example problem.

D.4 Diagrams

D.4.1 Package Overview (Structure of the Sample Model)

The table below provides definitions for acronyms used in this sample problem.

Table D.1 - Acronyms

DoT	Department of Transport
NIMROD	Aircraft name
MRA	Maritime Role Aircraft
ESM	Electronic Signal Monitoring
TDM	Time Division Multiplex
MRT	Maritime Rescue Team
SAR	Search and Rescue
C2	Command and Control

D.4.2 Flow of SAR Example Models

Figure D.1 shows the flow of the SAR example models through the different viewpoints. Beginning with the All Viewpoint, the natural progression is through the key Strategic Views, the key Operational Views, the key Service Oriented Views, the key Systems Views and finally to the Acquisition Views. Following that are some fit for purpose views to demonstrate additional analysis and definition capabilities.

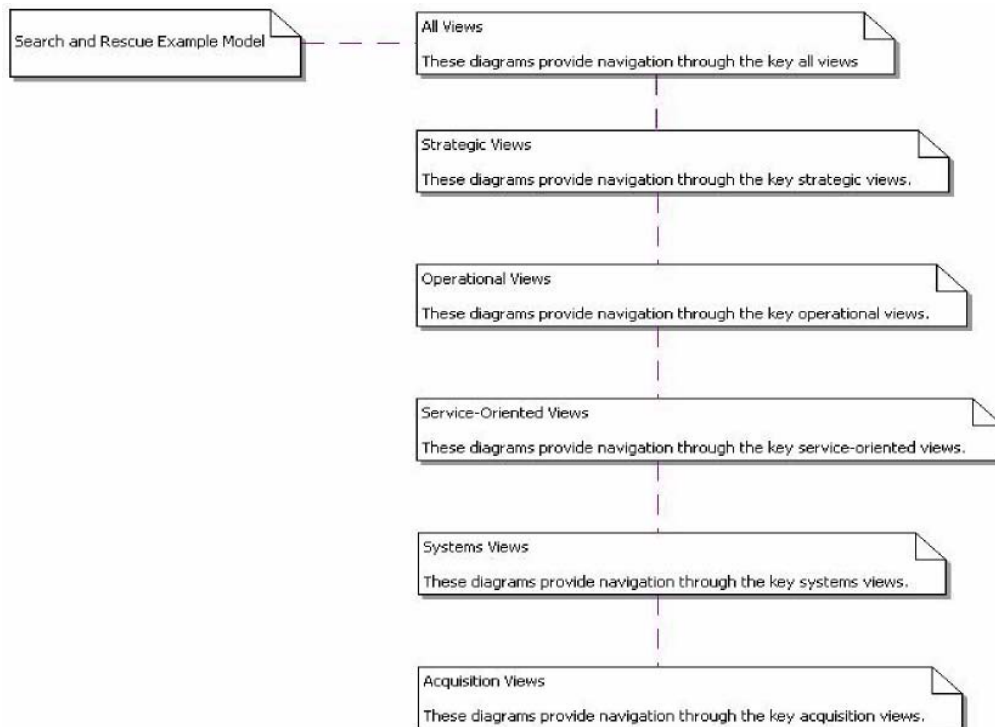

Figure D.1 - Diagram Flow

D.5 All Views

The All Views provide overview and summary information as well as an integrated dictionary. This information is provided in a consistent form that allows quick reference and comparison among architectures.

D.5.1 AV-1 Enterprise Definition

The text shown in Figure D.2 below provides executive-level summary information in a consistent form that allows quick reference and comparison between architectural descriptions. It includes assumptions, constraints, and limitations that may affect high-level decisions relating to an architecture-based work program.

Architecture Project Identification

- Name: SAR Architecture
- Architect: Bill Firenz
- Developing Organization: Maritime & Coastguard Agency
- Assumptions and Constraints: None
- Approval Authority: Howard Overtree, Project Manager
- Date Completed: TBD

Scope

- Views & Products Developed:

- Acquisition views: AcV-1, AcV-2, AcV-3
- All views: AV-1, AV-2, AV-3
- Operational views: OV-1a, OV-1b, OV-1c, OV-1d, OV-2, OV-3, OV-4, OV-5, OV-6a, OV-6b, OV-6c, OV-7
- Service Orientated views: SOV-1, SOV-2, SOV-3, SOV-4a, SOV-4b, SOV-5
- Strategic views: StV-1, StV-2, StV-3, StV-4, StV-5, StV-6
- System views: SV-1, SV-2, SV-3, SV-4, SV-5, SV-6, SV-7, SV-8, SV-9, SV-10a, SV-10b, SV-10c, SV-11, SV-12
- Technical views: TV-1, TV-2, TV-3
- Time Frames Addressed: Present
- Organizations Involved: Dept. of Transport, Maritime & Coastguard Agency

Purpose and Viewpoint

- Purpose of the Architecture: To detect and locate mariners, aviators and recreational enthusiasts in distress
- Architecture Viewpoint: Users of the system

Context

- Mission: Manage, coordinate and implement SAR activities
- Doctrine, Goals & Vision: TBD
- Rules, Criteria & Conventions: TBD
- Tools and File Formats:
 - Tools: UML, IDE, Word, and Excel
 - File Formats: DOCX, XLS and UML IDE Models

Findings

- Analysis Results: TBD
- Recommendations: TBD

Figure D.2 - AV-1

D.5.2 AV-2 Architecture Dictionary

Architecture development projects not using model-based techniques would often create an initial dictionary defining terms and names for the different model elements. Diagrams created in Microsoft PowerPoint or Visio would then be checked against this dictionary to ensure compliance. A model-based architecture using UPDM has in-built consistency in that elements appearing on different diagrams will have the same name as they are the same object. Consequently, the AV-2 diagrams are reports generated from the model, which itself is the architecture dictionary. Table D.2 shows a generated report of the operational activities in the model. There are fields for the name, the complete name in the model package hierarchy, the definition of the activity, the alias, and any elements for which this is the same.

DoDAF 2.0 variant: In DoDAF 2.0 the Operational Activity would simply be called an Activity.

Table D.2 - AV-2 Operational Activity Dictionary report

OperationalActivity				
Name	Full Scoped Name	Definition	Alias	Same As
Monitor For Distress Signal	SAR Architecture::Operational Activities::Monitor For Distress Signal			
Process Warning Order	SAR Architecture::Operational Activities::Process Warning Order			
Receive Distress Signal	SAR Architecture::Operational Activities::Receive Distress Signal			
Rescue	SAR Architecture::Operational Activities::Rescue			
Search	SAR Architecture::Operational Activities::Search			
Send Distress Signal	SAR Architecture::Operational Activities::Send Distress Signal			
Send Warning Order	SAR Architecture::Operational Activities::Send Warning Order			
Transit To SAR Operation	SAR Architecture::Operational Activities::Transit To SAR Operation			

Table D.3 shows the generated report of the Capability Configurations in the model. The fields are the same as the previous report in Table D.2.

DoDAF 2.0 Variant: In DoDAF 2.0 the Capability Configuration would be a performer.

Table D.3 - AV-2 Capability Configuration Dictionary report

CapabilityConfiguration				
Name	Full Scoped Name	Definition	Alias	Same As
Automated Rescue Unit v1	SAR Architecture::Resources::Capability Configurations::Automated Rescue Unit v1			
Control Center	SAR Architecture::Resources::Capability Configurations::Control Center			
Maritime Rescue Architecture v1	SAR Architecture::Resources::Capability Configurations::Maritime Rescue Architecture v1			
Maritime Rescue Unit v1	SAR Architecture::Resources::Capability Configurations::Maritime Rescue Unit v1			
Maritime Rescue Unit v2	SAR Architecture::Resources::Capability Configurations::Maritime Rescue Unit v2			
Monitor	SAR Architecture::Resources::Capability Configurations::Monitor			

D.5.3 AV Measurements Definition (Fit for Purpose)

Figure D.3 shows the class diagram version of the measurements diagram. This provides a means of defining types of measurements that are important to the system. These consist of measurable quantitative measurements. It defines the measurements that are important to the capabilities in the strategic view such as find time and persistence, shown later.

These concepts are defined in All Views, as they can pertain to all elements in all views of the model. Metrics specific to System elements are addressed in the SV-7. As there is no diagram MODAF or DoDAF in All Views for expressing this information, we have created a new diagram. This could be called AV-n, Measurements Definition or other suitable name. This is an example of the extensibility features provided by UML and SysML enabling the easy creation of fit for purpose views.

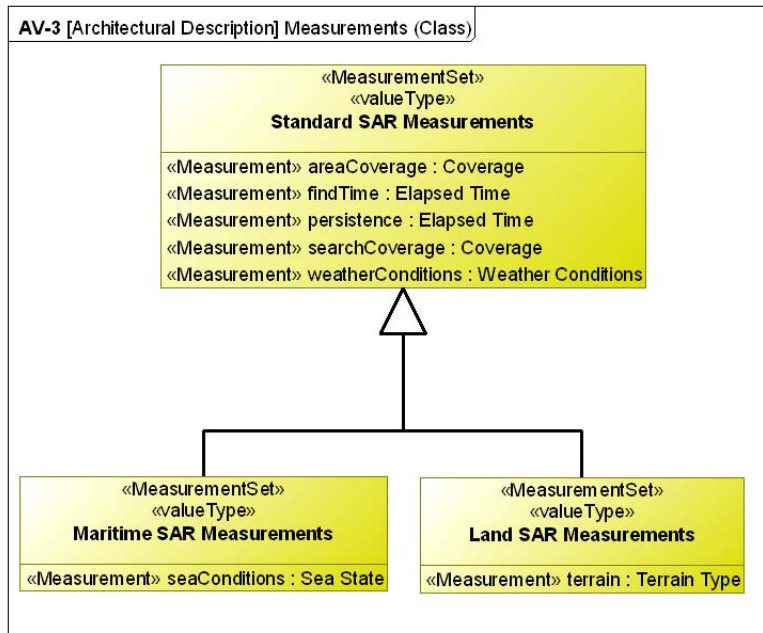

Figure D.3 - AV Measurements Class Diagram

D.5.4 AV Measurements Instances (Fit For Purpose)

Figure D.4 shows the instance diagram version of the measurements diagram. Instances of the measurements can be created and associated with architecture elements. In this case, they define the initial, required, and final values for SAR capabilities.

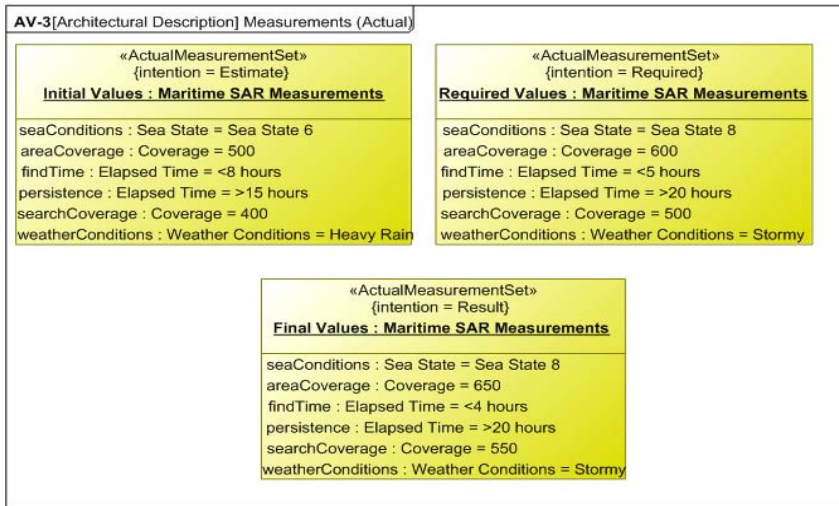

Figure D.4 - AV Measurements Instance Diagram

D.5.5 SysML Value Definitions - Fit For Purpose View

This SysML Block Definition Diagram (BDD) in Figure D.5 is used to define the value types, units and dimensions used in the measurements for the typical and actual measurements. This allows a more precise definition of the values and eliminates ambiguity. This is another example of a fit for purpose view.

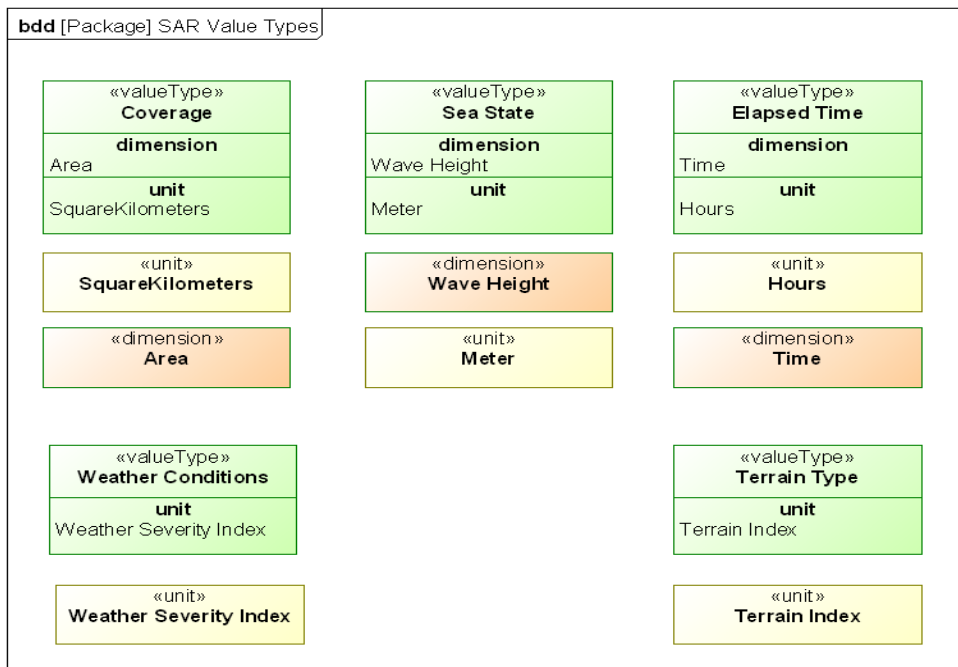

Figure D.5 - SysML BDD Units, Dimensions, and Value Types

D.5.6 SysML Requirements - Fit For Purpose View

One of the two principal extensions to OMG SysML is support for requirements. The “requirement” stereotype extends class to specify the textual “shall” statement and capture the requirement id#. The requirement diagram is used to integrate the system models with text based requirements that are typically captured in requirements management tools. The UML containment relationship (circle with a plus sign) is used to decompose a requirement into its constituent requirements. A requirement is related to other key modeling artifacts via a set of stereotyped dependencies. The “deriveReq” and “satisfy” dependencies describe the derivation of requirements from other requirements and the satisfaction of requirements by design, respectively. The “verify” dependency shows the link from a test case to the requirement or requirements it verifies. In addition, the UML “refine” dependency is used to indicate that an OMG SysML model element is a refinement of a textual requirement, and “a copy” relationship is used to show reuse of a requirement within a different requirement hierarchy. The “rationale” concept can be used to annotate any model element to identify supporting rationale including analysis and trade studies for a derived requirement, a design or some other decision.

As UPDM level L1 has been built upon SysML, requirements can be integrated into the model. SysML traceability relationships can be used as shown in Figure D.6. The capabilities trace to the requirements and the Activities refine the requirements. System elements developed later in the design cycle will satisfy these requirements.

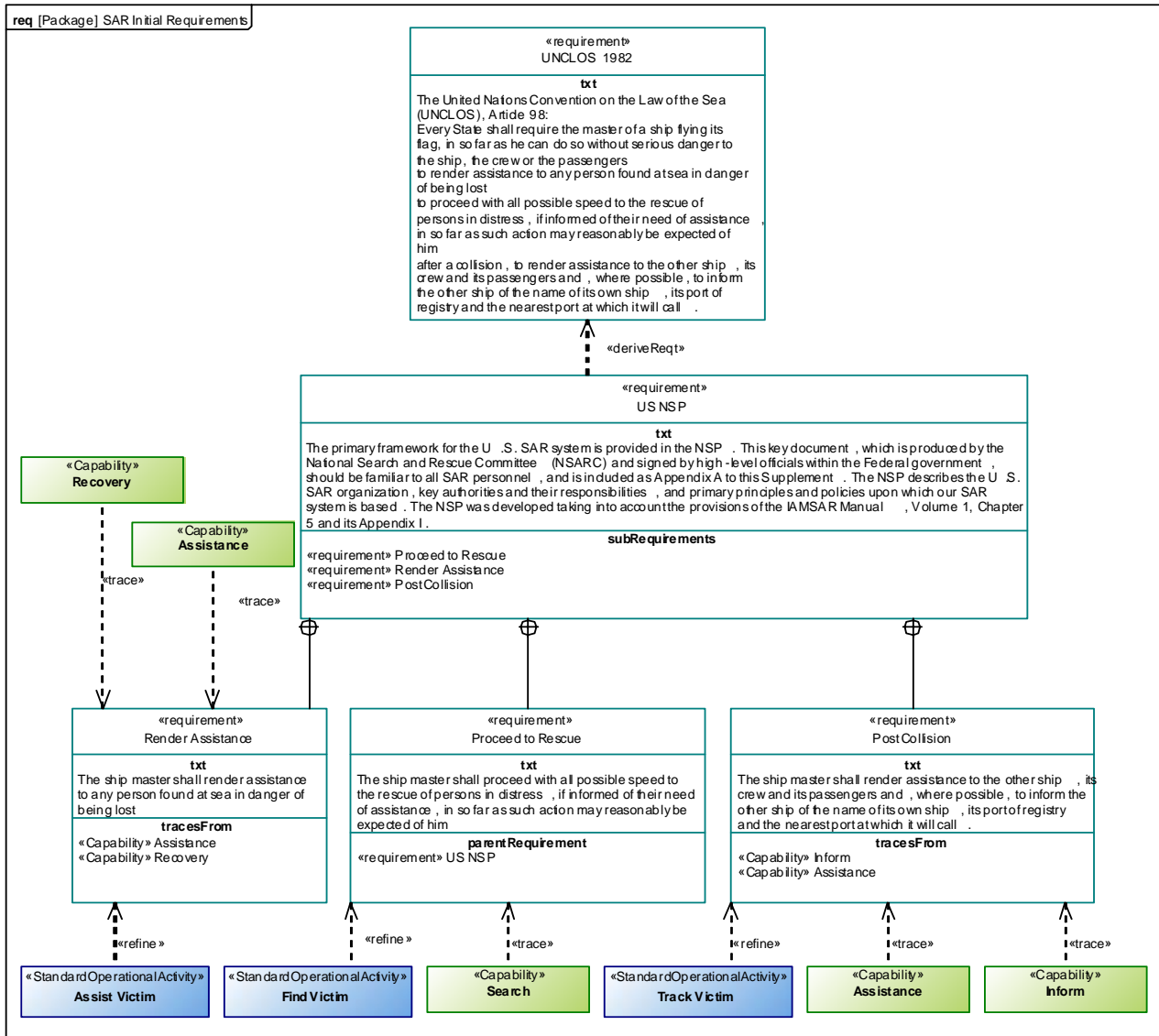

Figure D.6 - SysML Requirements

D.6 Strategic/Capability Views

The diagrams in the Strategic View (DoDAF 2.0 Capability Model) provide a capability view of the SAR operation. These views will show the relationships between these capabilities and between the capabilities and the resources required to realize them.

D.6.1 StV-1 Capability Vision (DoDAF CV-1)

Figure D.7 describes the strategic context for Search and Rescue Capabilities. It outlines the vision for a capability area over a specified period of time. It describes how high level goals and strategy are to be delivered in terms of capability. The concepts of the Whole Life Enterprise and Enterprise Phase are not elements in DoDAF 2.0.

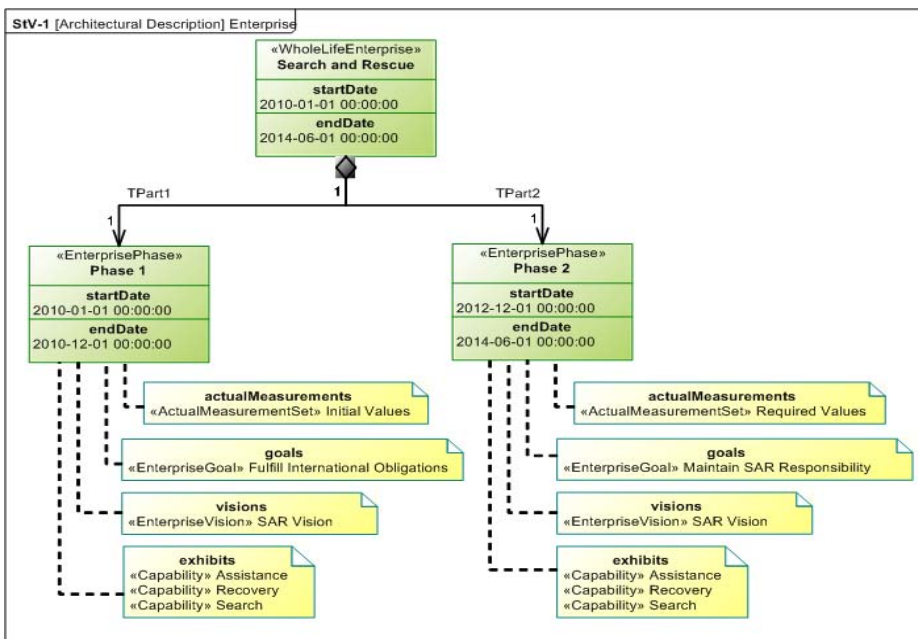

Figure D.7 - StV-1 Enterprise View

D.6.2 StV-2 Capability Taxonomy (DoDAF CV-2)

Capabilities need to be characterized in terms of the properties they need to exhibit which enable the enterprise to use them to achieve the enterprise goals, as well as their relationships in an inheritance hierarchy. In Figure D.8 we have characterized Maritime SAR in terms of required values. These are defined in Figure D.8 and include the length of a Maritime SAR operation, the sea conditions in which Maritime SAR must be deliverable, the search area covered by an operation and the time to find a victim.

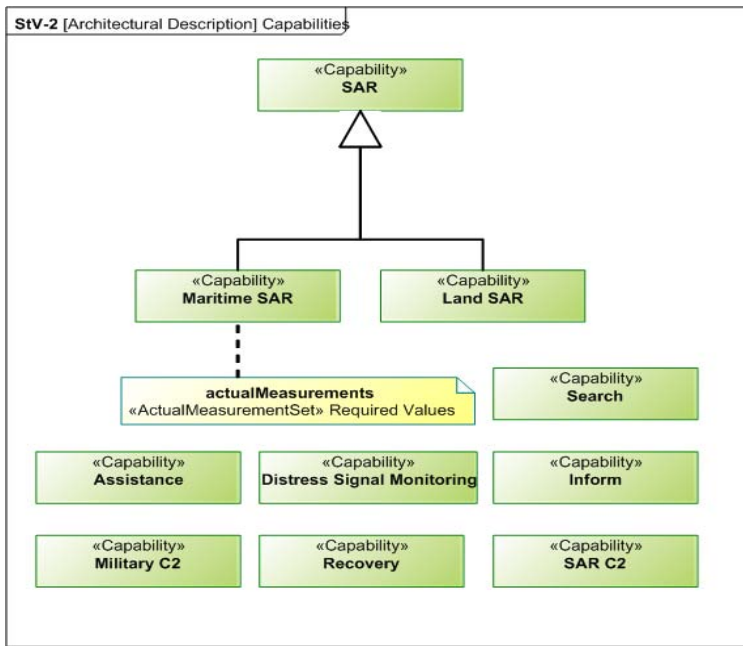

Figure D.8 - StV-2 Capability Taxonomy

D.6.3 StV-3 Capability Phasing (DoDAF CV-3)

StV-3 addresses the planned achievement of capability at different points in time or during specific periods of time, i.e., capability phasing. The example shown in Table D.4 is a generated report showing the capabilities, the systems that realize these capabilities and when they will be deployed and taken out of service, and the measurements that they are expected to achieve. Information for this report is defined using the AcV-3 Actual Projects diagram, the AV-3 measurements diagram, and the StV-2 Capability Taxonomy diagram.

Table D.4 - StV-3 Capability Phasing

	2010												2011											
	J	F	M	A	M	J	J	A	S	O	N	D	J	F	M	A	M	J	J	A	S	O	N	D
Assistance																								
seaConditions = Sea State 6 areaCoverage = 500 findTime = <8 hours persistence = >15 hours searchCoverage = 400 weatherConditions = Heavy Rain	Maritime Rescue Unit v1 (SAR Manual Project I)																							
[no measurements]							Automated Rescue Unit v1 (SAR Automation Project)																	
seaConditions = Sea State 8 areaCoverage = 600 findTime = <5 hours persistence = >20 hours searchCoverage = 500 weatherConditions = Stormy							Maritime Rescue Unit v2 (SAR Manual Project II)																	
Search																								
seaConditions = Sea State 6 areaCoverage = 500 findTime = <8 hours persistence = >15 hours searchCoverage = 400 weatherConditions = Heavy Rain	Maritime Rescue Unit v1 (SAR Manual Project I)																							
[no measurements]							Automated Rescue Unit v1 (SAR Automation Project)																	
seaConditions = Sea State 8 areaCoverage = 600 findTime = <5 hours persistence = >20 hours searchCoverage = 500 weatherConditions = Stormy							Maritime Rescue Unit v2 (SAR Manual Project II)																	

D.6.4 StV-4 Capability Clusters (DoDAF CV-4)

This StV-4 view addresses the logical grouping of capabilities and the dependencies between them. In Figure D.9, SAR Command and Control depends on the Military C2 Capability. Similarly, the Assistance, Search and Recovery Capabilities are dependent upon the SAR C2 Capability, which in turn is dependent upon the Distress Signal Monitoring Capability. The UML composite structure diagram in Figure D.9 provides a means to define capabilities within a specific context, in this case search and rescue. The dependencies are scoped to this context.

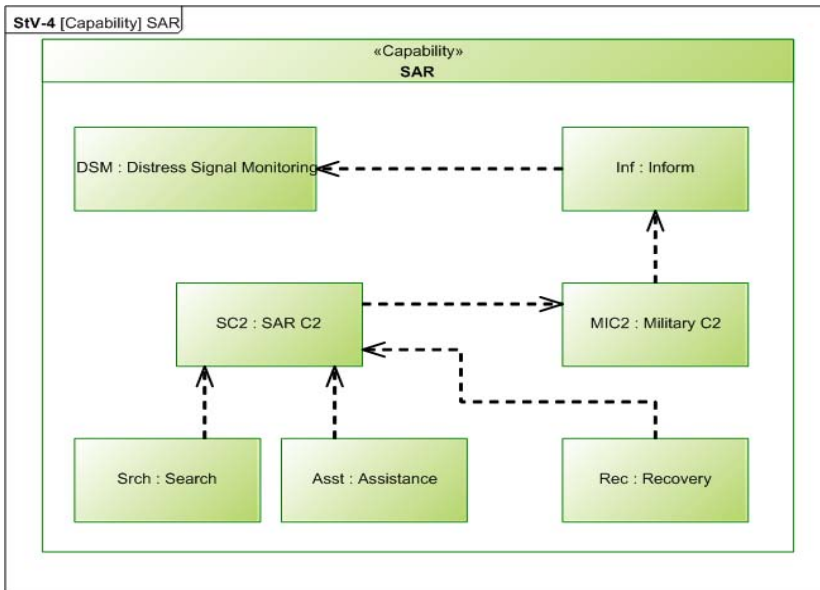

Figure D.9 - StV-4

D.6.5 StV-4 Capability Clusters Class Diagram (DoDAF CV-4)

Figure D.10 shows the class diagram version of the capability clusters. Dependencies can be defined between the capabilities, but there is no means to define a specific context.

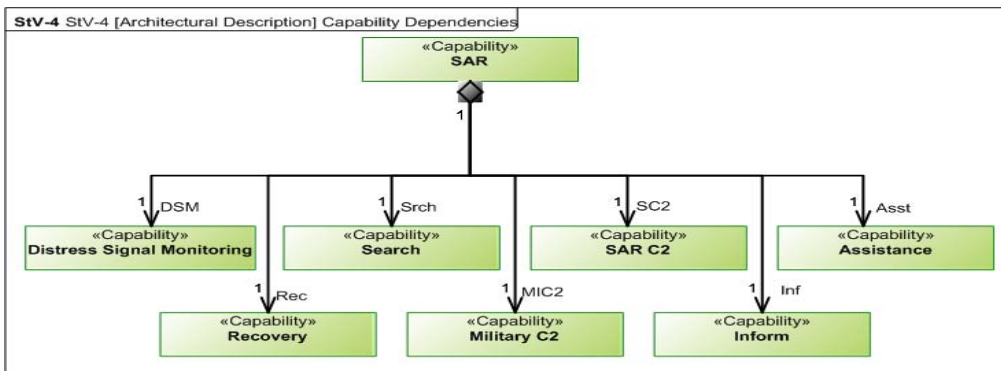

Figure D.10 - StV-4 Alternative View

D.6.6 StV-5 Capability to Organization Deployment (DoDAF CV-5)

Table D.5 shows the generated StV-5 table. The StV-5 defines Capability to Organization Deployment Mapping. It shows the planned capability deployment for a resource and the responsible organization. The StV-5 View is used to support the capability management process and, in particular, assist the planning of fielding. For example, the Assistance Capability is supported by the Maritime Rescue Unit. The Volunteer Rescue Organization and Maritime and Coastguard Agency are responsible for them.

Table D.5 - StV-5

		<u>Capabilities</u>			
		Assistance	Inform	Recovery	Search
Organizational Resources	«ActualOrganization» Coastguard	Maritime Rescue Unit v1	Maritime Rescue Unit v1	Maritime Rescue Unit v1	Maritime Rescue Unit v1
	Maritime Rescue Unit v2	Maritime Rescue Unit v2	Maritime Rescue Unit v2	Maritime Rescue Unit v2	
	«ActualOrganization» Maritime & Coastguard Agency	Maritime Rescue Unit v1	Maritime Rescue Unit v1	Maritime Rescue Unit v1	Maritime Rescue Unit v1
	Maritime Rescue Unit v2	Maritime Rescue Unit v2	Maritime Rescue Unit v2	Maritime Rescue Unit v2	
	«ActualOrganization» Volunteer Rescue Organization	Maritime Rescue Unit v1	Maritime Rescue Unit v1	Maritime Rescue Unit v1	Maritime Rescue Unit v1
	Maritime Rescue Unit v2	Maritime Rescue Unit v2	Maritime Rescue Unit v2	Maritime Rescue Unit v2	

D.6.7 StV-6 Operational Activity to Capability Mapping (DoDAF CV-6)

This view, Figure D.11, identifies how operational activities support capabilities. Figure D.11 shows that in order to achieve Search and Assistance Capabilities, certain Standard Operational Activities must be performed, including Monitor Health and Provide Medical Assistance.

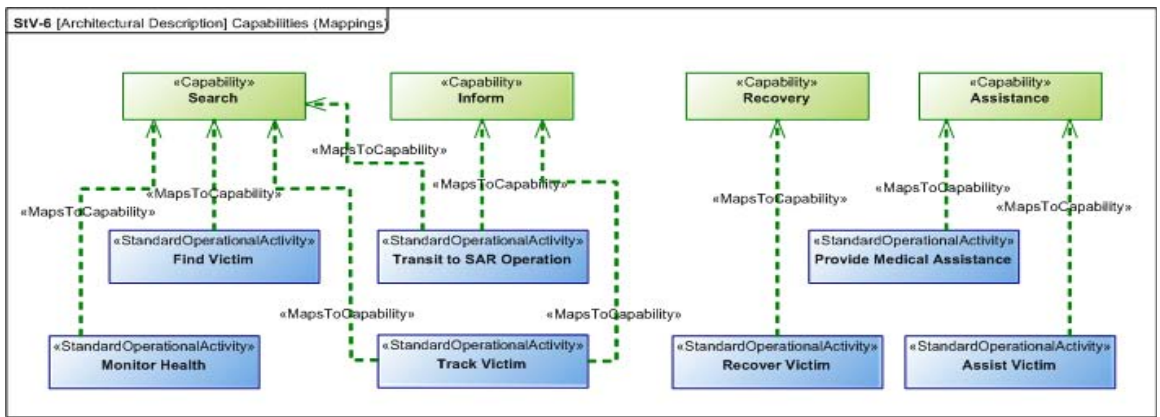

Figure D.11 - StV-6

D.7 Operational Views

The Operational Views identify what needs to be accomplished in the SAR operation and who needs to accomplish it. These views describe the tasks and activities, operational elements and exchanges of information, systems and energy that are required to conduct the operations.

D.7.1 OV-1a Operational Context Graphic

This diagram, Figure D.12, of the Maritime rescue sets the context by illustrating the search and rescue operation at sea involving a yacht in distress. The diagram shows that the monitoring unit picks up the distress calls of the yacht and sends them to a Command and Control (C2) center, which coordinates the operation among helicopters, a naval ship and a rescue boat.

In the OV-1a, each model element depicted may include a graphical depiction to help convey its intended meaning. The spatial relationships of the elements on the diagram sometimes convey their relative position, although this is not specifically captured in the semantics. A brief description of the interactions between the elements is provided. It may represent abstract conceptual relationships and will be refined in subsequent diagrams.

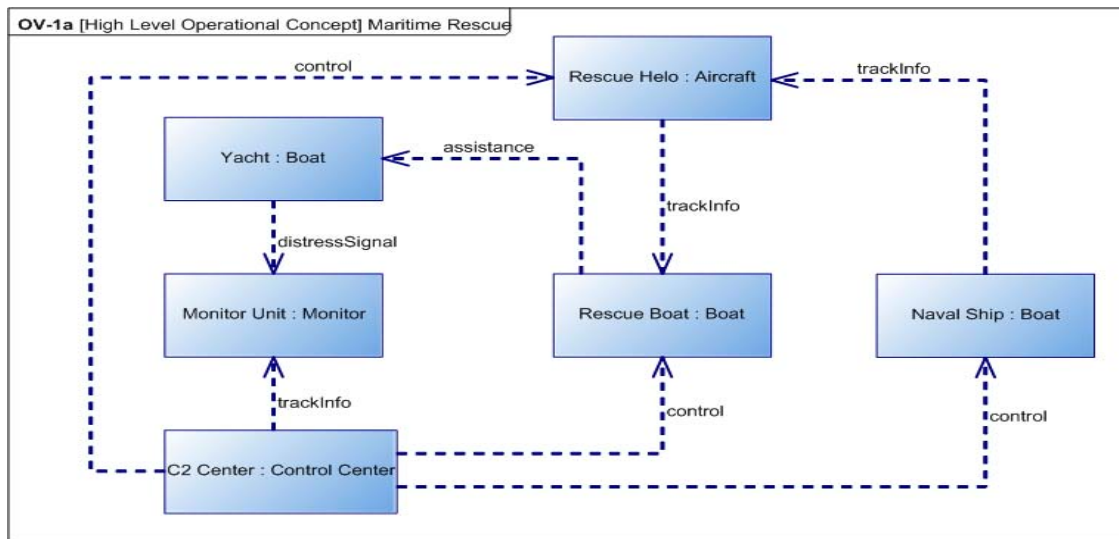

Figure D.12 - OV-1a

As shown below in Figure D.13, a pictorial background can be included to provide additional context. The elements on the diagram are exactly the same. They are simply represented as graphics rather than boxes. This helps to communicate with domain experts who may not be familiar with architectural frameworks. They are also shown as graphics, symbols, and photos to demonstrate that any graphic can be used. The yacht is shown pictured as a lifeboat to emphasize that they are in distress.

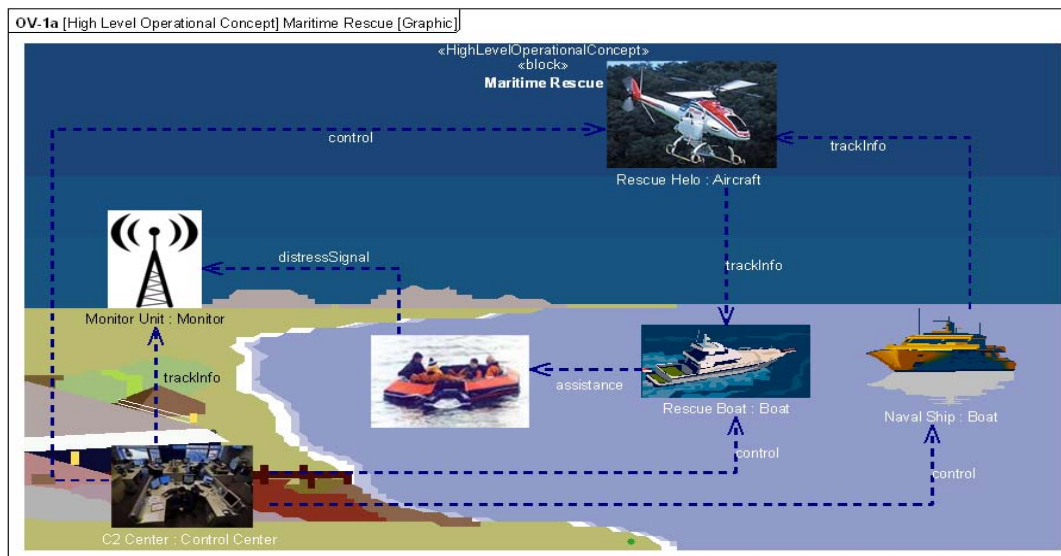

Figure D.13 - Alternate OV-1a

D.7.2 OV-1b Operational Context Description

The text shown below in Figure D.14 describes the scenario depicted in Figure D.14. There is normally an OV-1b associated with each OV-1a.

The “Yacht in Distress” Scenario

The Sample Problem applies UPDM to a common scenario in civilian maritime Search and Rescue (SAR) operations -- a Yacht in distress. A Monitor Unit picks up the distressSignal from the Yacht and passes it on to the Command and Control (C2 Center). The C2 Center coordinates the search and rescue operation among the Rescue Helo, a Naval Ship and a Rescue Boat.

This model is based on a UK MOD example model.

D.7.3 OV-1c Operational Context Measurements

The OV-1c shown in Table D.6 provides a summary of the measures that the architecture is expected to achieve. These measures are defined in the AV-3 actual measurements diagram. The units and dimensions attached to the measurements were defined using the SysML BDD shown in Figure D.5. This view is not found in DoDAF 2.0, but could be a fit for purpose view.

Table D.6 - OV-1c

Actual Measurement Set								
Name	Name	Intention	Measurement	Minimum Value	Actual Value	Maximum Value	Unit	Dimension
Maritime Rescue	Initial Values	Estimate	seaConditions	Sea State 1	Sea State 6	Sea State 10	Meter	Wave Height
			areaCoverage	100	500	1000	SquareKilometers	Area
			findTime	4	<8 hours	8	Hours	Time
			persistence	5	>15 hours	22	Hours	Time
			searchCoverage	200	400	600	SquareKilometers	Area
		weatherConditions	Calm	Heavy Rain	Hurricane	Weather Severity Index		
	Required Values	Required	seaConditions	Sea State 1	Sea State 8	Sea State 10	Meter	Wave Height
			areaCoverage	100	600	1000	SquareKilometers	Area
			findTime	4	<5 hours	8	Hours	Time
			persistence	5	>20 hours	22	Hours	Time
			searchCoverage	200	500	600	SquareKilometers	Area
		weatherConditions	Calm	Stormy	Hurricane	Weather Severity Index		
	Final Values	Result	seaConditions	Sea State 1	Sea State 8	Sea State 10	Meter	Wave Height
			areaCoverage	100	650	1000	SquareKilometers	Area
			findTime	4	<4 hours	8	Hours	Time
		persistence	5	>20 hours	22	Hours	Time	
		searchCoverage	200	550	600	SquareKilometers	Area	
	weatherConditions	Calm	Stormy	Hurricane	Weather Severity Index			

D.7.4 OV-1d Operational Context Use Cases (Fit for Purpose)

A Mission defines a functional goal that the stakeholders have. This aligns well with the definition of a Use Case. As UPDM is built on UML and SysML, it is possible to create Use Case diagrams showing the missions, their relationships, and the stakeholders involved in the mission. Figure D.14 defines the missions required for search and rescue.

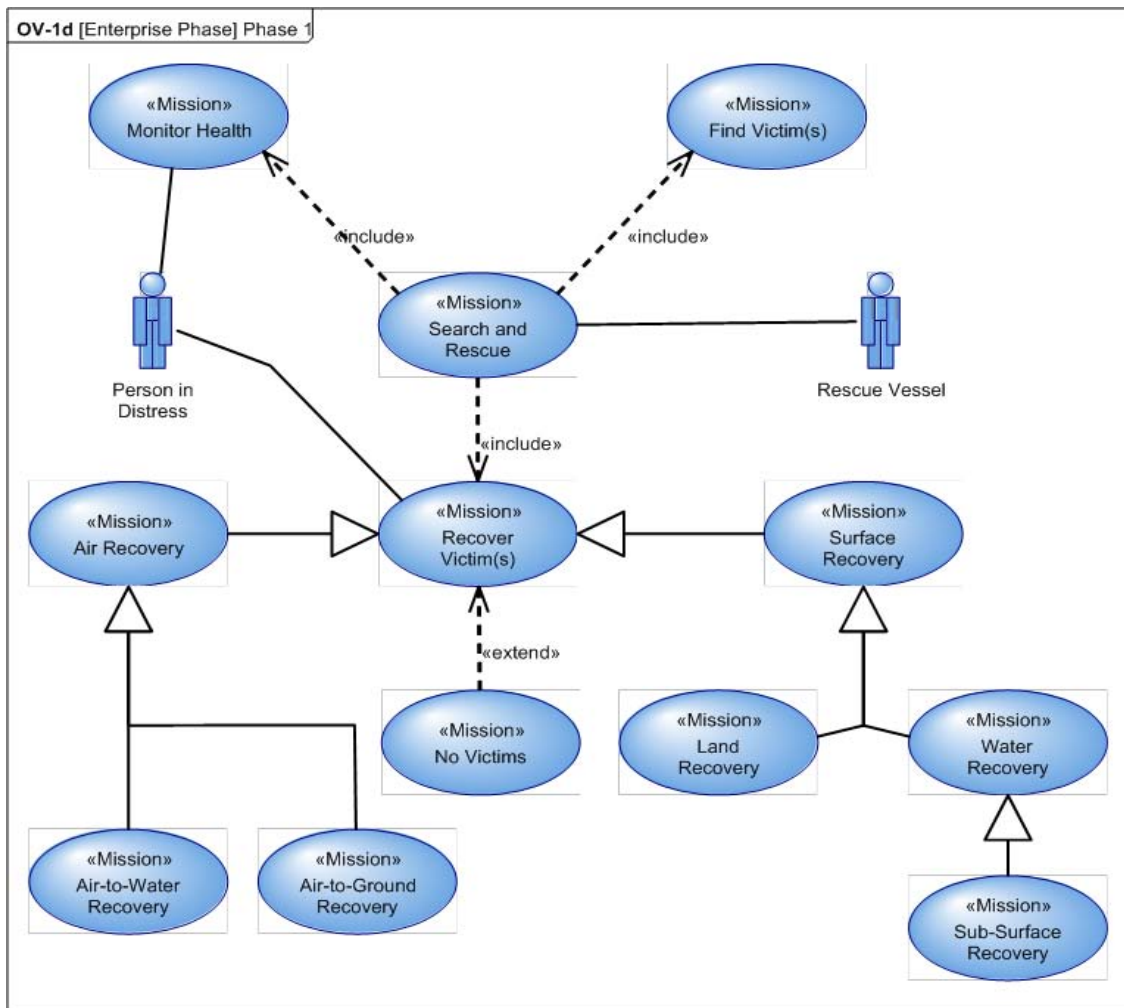

Figure D.14 - OV-1d

D.7.5 OV-2 Operational Node Connectivity Description (DoDAF Operational Resource Flow Description)

The OV-2 diagrams in Figures D.16, D.17, and D.18 depict the key players in the SAR operation and the interactions for information exchange. It identifies the different types of nodes (Performer in DoDAF) in the SAR operation: Person in Distress, Monitoring Node, Tactical C2 Node, SAR Asset Controller, Search Node, Rescue Node, and Place of Safety. This diagram indicates the need to exchange information between the operational nodes and also shows the interactions between these nodes. Other interactions can be exchanged between the nodes such as equipment, energy, and so forth. The OV-5 view shows the operational activities undertaken by a few select nodes. Figure D.15 is the class diagram version of the OV-2.

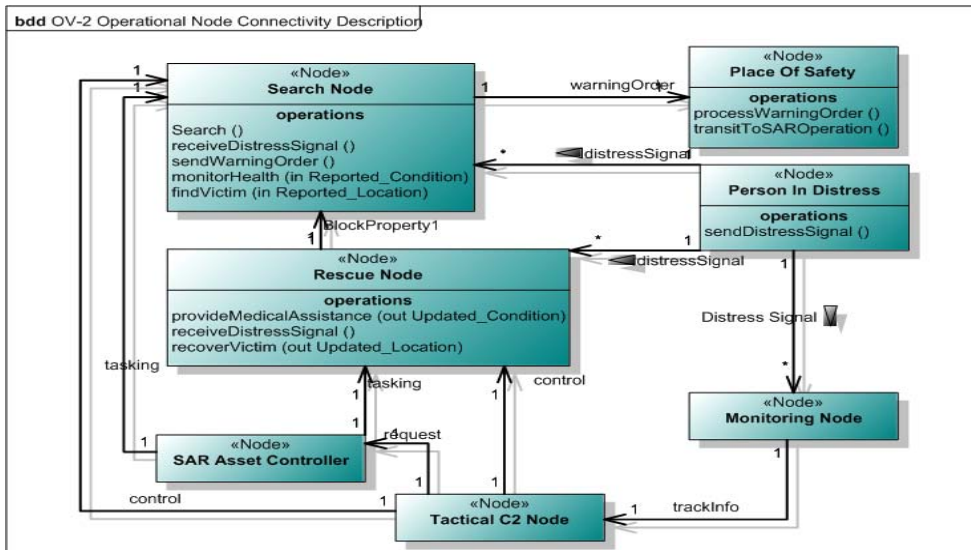

Figure D.15 - OV-2 Class Diagram

Figure D.16 shows an alternate way to display the OV-2. It can be illustrated as above with IO associations or as below using connectors and SysML Item Flows without flow ports as in Figure D.16 or with flow ports as in Figure D.17. Figure D.17 also shows the service ports. These define services that are required or provided by these nodes.

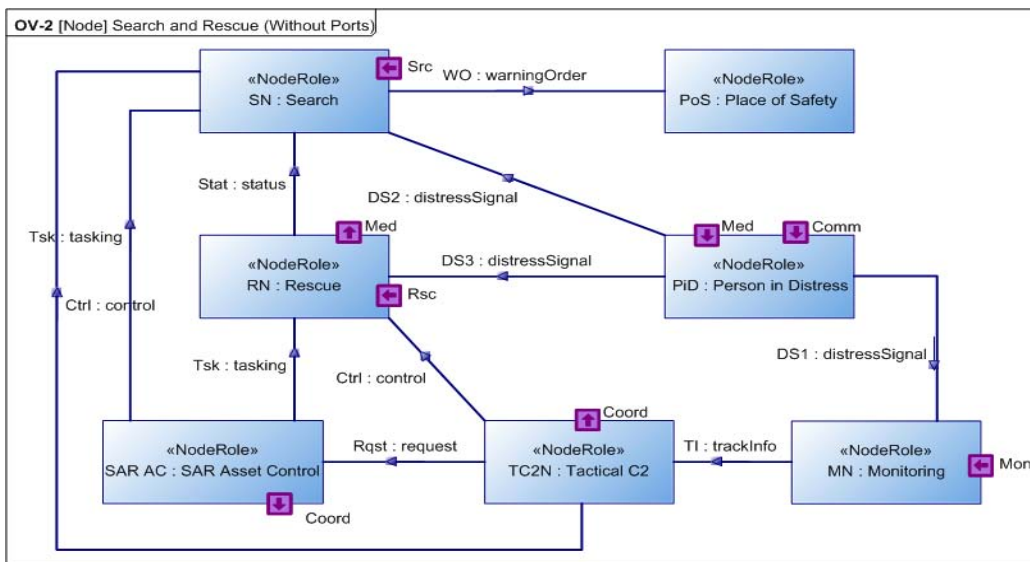

Figure D.16 - Alternate OV-2 SysML Version without Service Ports

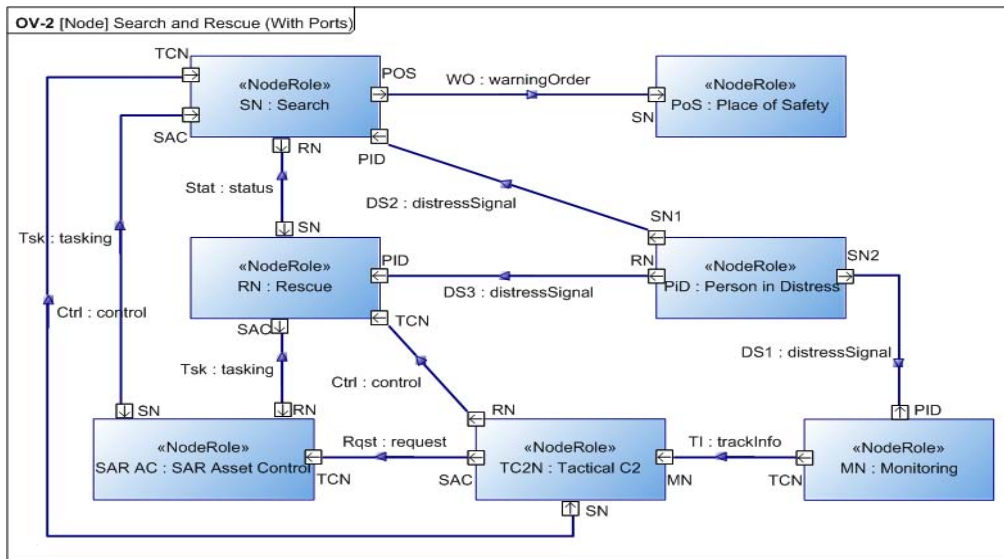

Figure D.17 - Alternate OV-2 with SysML Flow Ports

Figure D.17 shows the SysML version with Flow Ports and Item Flows. The typed ports mean that the user can constrain the elements that can flow in and out of the port. This means that consistency checks can be performed on the ports to ensure that the flows correspond to the allowed elements. The stereotypes have also been removed to aid readability.

D.7.6 OV-3 Operational Exchange Summary (DoDAF Operational Resource Flow Matrix)

Table D.7 shows the operational exchanges between nodes. The OV-3 can include Information Exchanges associated with a Needline as well as Information Elements carried by one or more Information Exchange. Reports can also be generated summarizing other types of exchanges. The report show the producing and consuming nodes, and the activities performed by those nodes that produced and consumed the interchange. This provides a validation capability for the architecture in that the blank boxes for the producing and consuming activities indicates that further work needs to be done on the architecture: exchanges are being made for no apparent purpose. There is an important distinction between DoDAF and MODAF in this regard. Exchanges (activityConsumesResource in DoDAF) can only take place as a result of an activity.

Table D.7 - OV-3

Information		Producer		Needline	Consumer	
Name	Conveyed	Node	Operational Activity	Name	Node	Operational Activity
Ctrl	control	Tactical C2		TC2N - RN	Rescue	
Ctrl	control	Tactical C2		TC2N - SN	Search	
DS1	distressSignal	Person in Distress		PID - MN	Monitoring	
DS2	distressSignal	Person in Distress	Send Distress Signal	SN1 - PID	Search	Receive Distress Signal
DS3	distressSignal	Person in Distress	Send Distress Signal	RN - PID	Rescue	Receive Distress Signal
Rqst	request	Tactical C2		SAC - TCN	SAR Asset Control	
Stat	status	Rescue		RN - SN	Search	
TI	trackInfo	Monitoring		TCN - MN	Tactical C2	
Tsk	tasking	SAR Asset Control		RN - SAC	Rescue	
Tsk	tasking	SAR Asset Control		SAR AC - SN	Search	
WO	warningOrder	Search	Send Warning Order	SN - PoS	Place of Safety	Process Warning Order

D.7.7 OV-4 Organizational Relationships Chart

The OV-4 illustrates the command structure or relationships (as opposed to relationships with respect to a business process flow) among human roles, organizations, or organization types that are the key players in the SAR operation.

The OV-4 exists in two forms - typical (typical command structure) and actual (organization chart for a department or agency). Figure D.18, the typical OV-4, shows the possible relationships between organizations and posts. It is also possible to define types of people who are capable of filling these posts. For example, a Qualified Lifeguard could become an MRT Swimmer. The class diagram defines a template from which the actual organization will be created. The actual organizations, posts, and relationships must comply with this template. In fact, it is not possible to add an element not defined in the template. This ensures a consistent model. Matrix organizations can also be created as multiple structures can be created. This provides both flexibility and structure.

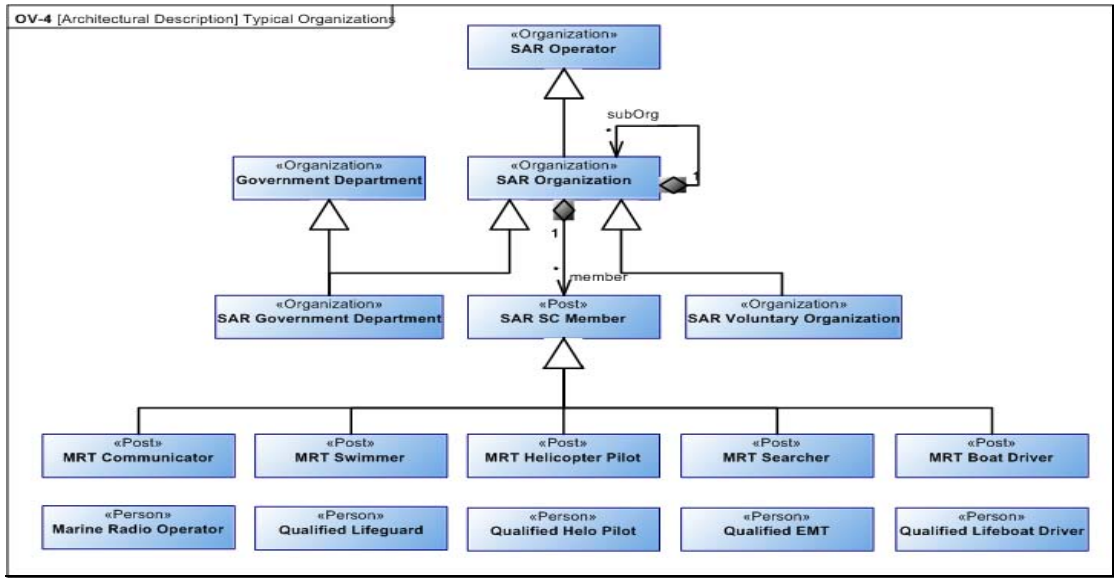

Figure D.18 - OV-4 Typical

The actual OV-4, shown in Figure D.19, depicts the structure of the organization, the actual posts (Person Type in DoDAF) and the actual persons (IndividualPerson in DoDAF) who fill those posts. The diagram can also be annotated with the start and end dates for this for the people filling those posts. For example, Peter Pilot fills the post of Rescue Helo Pilot, which is a member of the Coast Guard, which is a sub organization of the Maritime and Coastguard Agency.

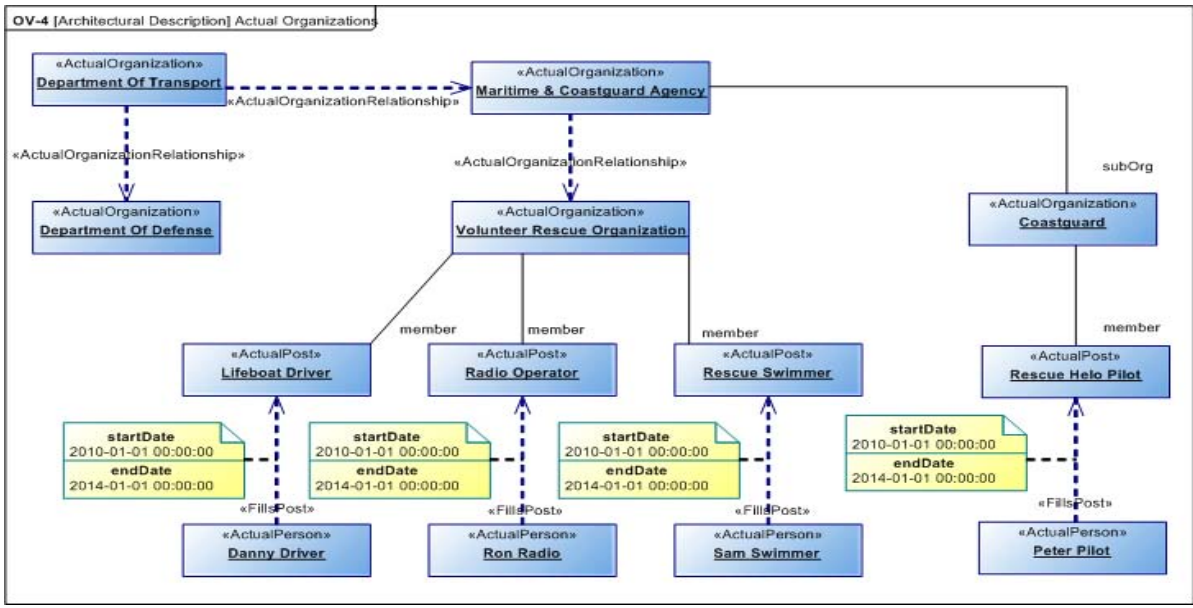

Figure D.19 - OV-4 Actual

D.7.8 OV-5 Operational Activity Model (DoDAF Operational Activity Decomposition Tree - OV-5A)

Figure D.20 describes the operations that are normally conducted in the different nodes of a Search and Rescue operation. This view shows the operational activities which are performed by the Search Node and Rescue Node. The class diagram views provides a means of breaking down activities to lower level activities as well as indicating the nodes that perform the activities.

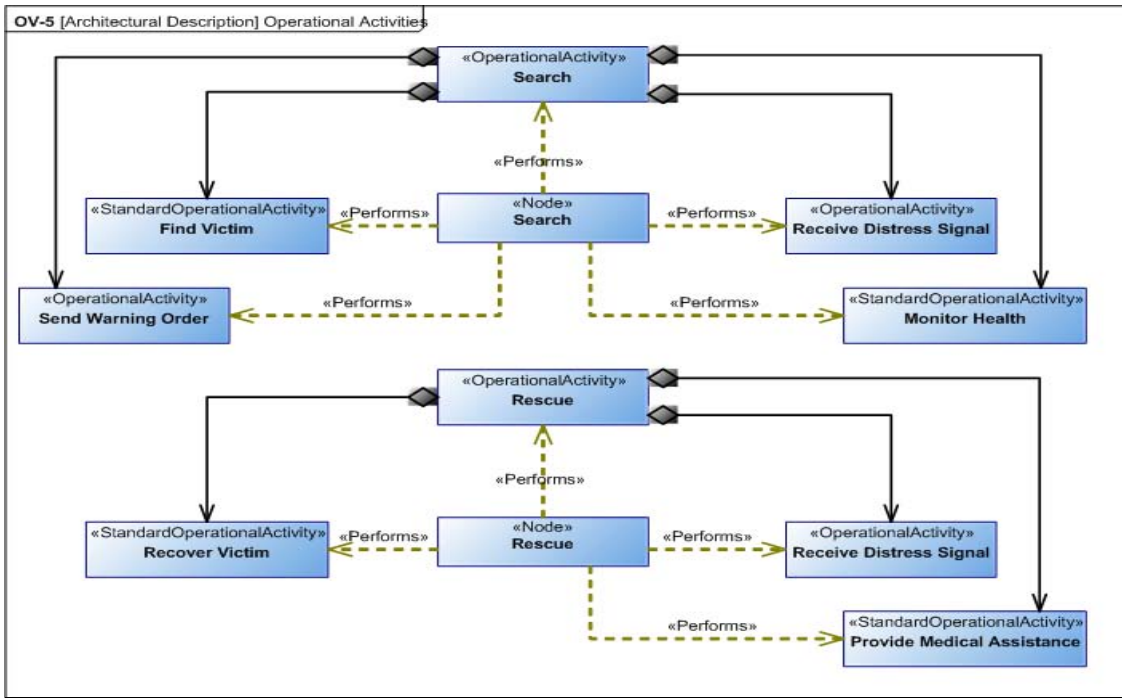

Figure D.20 - OV-5

Figure D.21 shows the OV-5 as an activity diagram. It describes Operational Activity Actions, Input/Output flows between activities and to/from activities that are outside the scope of the context of the activity diagram. The example shows the execution of the search activity. There is a horizontally nested swim lane which is the search and rescue context. Inside this context are the nodes that were defined within the OV-2. This is an example of how UPDM ensures structural consistency across the model. Activities displayed within the swimlanes are allocated to the node that owns the swim lane.

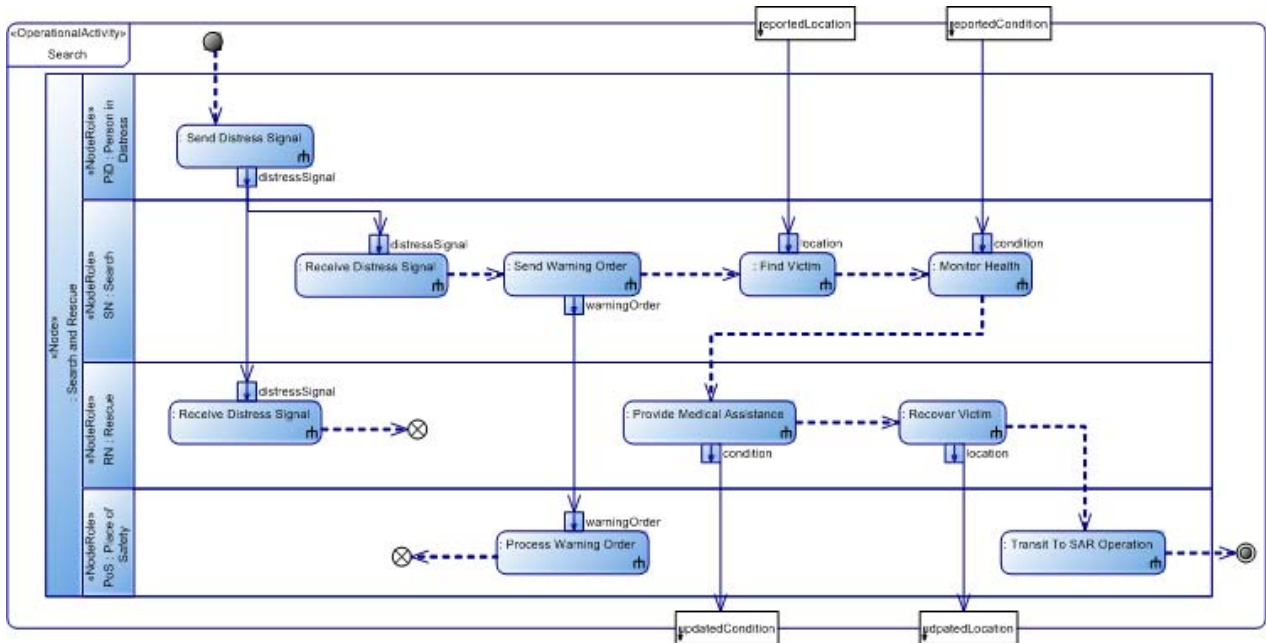

Figure D.21 - Alternate OV-5

D.7.9 OV-6a Operational Rules Model (Same in DoDAF)

Table D.8 is a generated report showing the operational constraints associated with operational elements such as nodes, organizations, Activities, etc.

Table D.8 - OV-6a Operational Constraints

Operational Element		Operational Constraint	
Type	Name	Name	Text
«Node»	Place of Safety	Location Constraints	The place of safety shall be isolated from the weather to ensure safety of the person in Distress.
«OperationalActivity»	Monitor For Distress Signal	Distress Signal Monitoring	Distress signals shall be monitored 24/7.
«OperationalActivity»	Search	Personnel Safety	Search personnel shall operate on a shift system to ensure that they can perform to maximum efficiency.
«OperationalActivity»	Send Distress Signal	Distress Signal Range	The maximum range for distress signals shall be posted at all ports and marinas.
«OperationalActivity»	Transit To SAR Operation	[none]	[none]

D.7.10 OV-6b Operational State Transition Description

Figure D.22 describes the operational states of the Search Node, the behaviors that take place within those states, the transitions between the states and the events and guards that cause those transitions to take place. For example, the search node is waiting for a distress signal. When one is received, the warning order is sent out and the search node transitions to searching for victim. When a victim is found, the search node transitions to monitoring the victim. If the victim is stable, the search node transitions to rescuing the victim. If the victim is not stable, the search node transitions to monitoring the victim. If the search is cancelled, the search node transitions back to waiting for a distress signal. If no assistance is required, the search node transitions back to waiting for a distress signal. If assistance is required, the search node transitions to monitoring the victim. If the victim is secure, the search node transitions back to waiting for a distress signal.

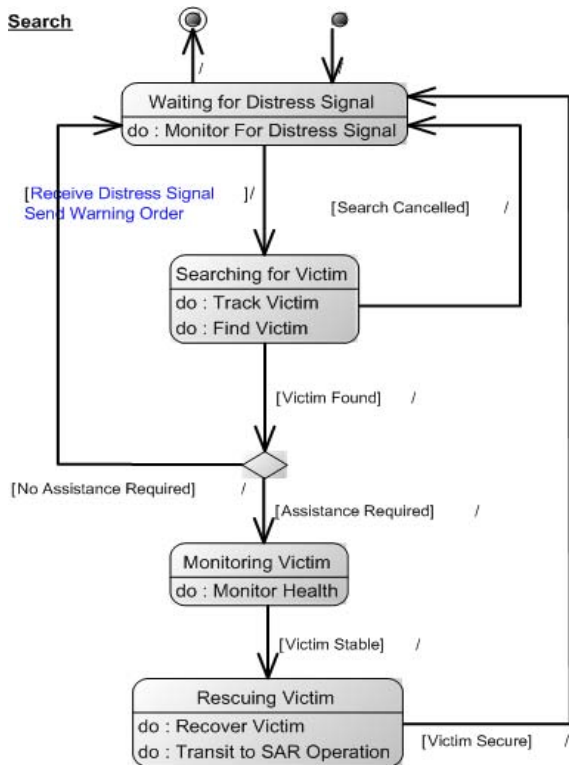

Figure D.22 - OV-6b

D.7.11 OV-6c Operational Event Trace Description

The OV-6c is used to define time based behavioral scenarios between operational elements. The interactions can be service operations as well as the interactions defined on the OV-2 and OV-5 diagrams. Figure D.23 shows the sequence of interactions for a search and rescue scenario.

Search and Rescue

Description

```

PID broadcasts distressSignal
MN station detects PID distressSignal, triangulates
location of source and transmits trackInfo to TC2N
TC2N sends request to SAR AC
par
  SAR AC transmits tasking orders SN assets in
  vicinity of trackInfo
  SAR AC (also) transmits tasking orders RN
  assets in vicinity of trackInfo
also par
  TC2N assumes & maintains Command &
  Control of tasked SN assets throughout current
  SAR operation.
  TC2N assumes & maintains Command &
  Control of tasked RN assets throughout current
  SAR operation.
  ...
end par
loop until each PD reaches PoS DO:
  par
    Continually monitor distressSignal and
    locate victims
    Continually monitor distressSignal, locate
    victims and render aid
  also par
    Update SN assets of status of victims and
    vessels in operation
    Transmit warningOrder to PoS on status of
    operation and victims
  end par
end par
end loop

```

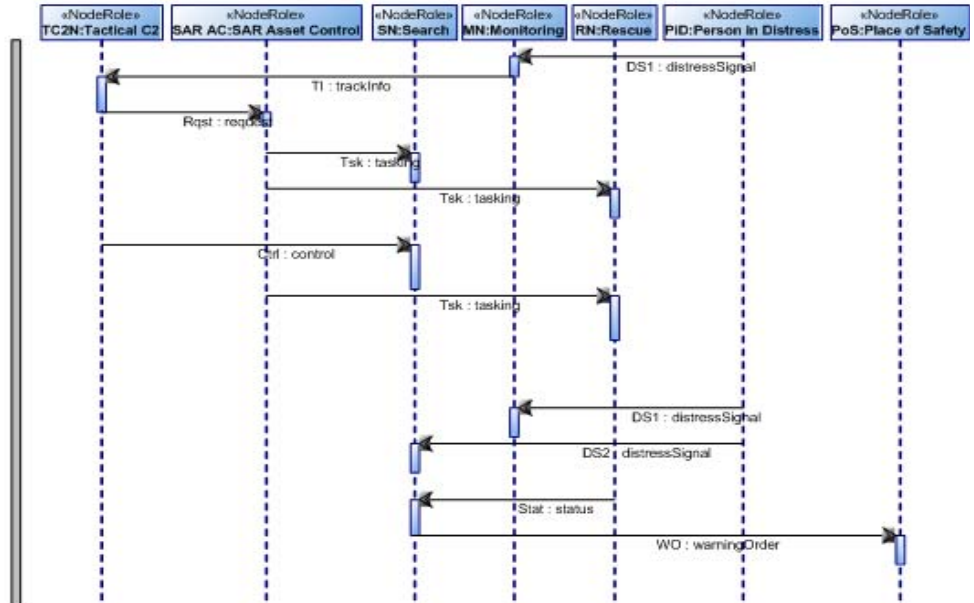

Figure D.23 - OV-6c

D.7.12 OV-7 Logical Data Model (DoDAF DIV-1/DIV-2)

The OV-7 view shown in Figure D.24 describes the information elements and entities used in the operational context. The boxes show the information items and the lines represent their inter-relationships. Attributes can be used to show the characteristics of the information items. The “represents entity” dependencies show the information elements that represent the entity items. These are used on the OV-2 and other diagrams.

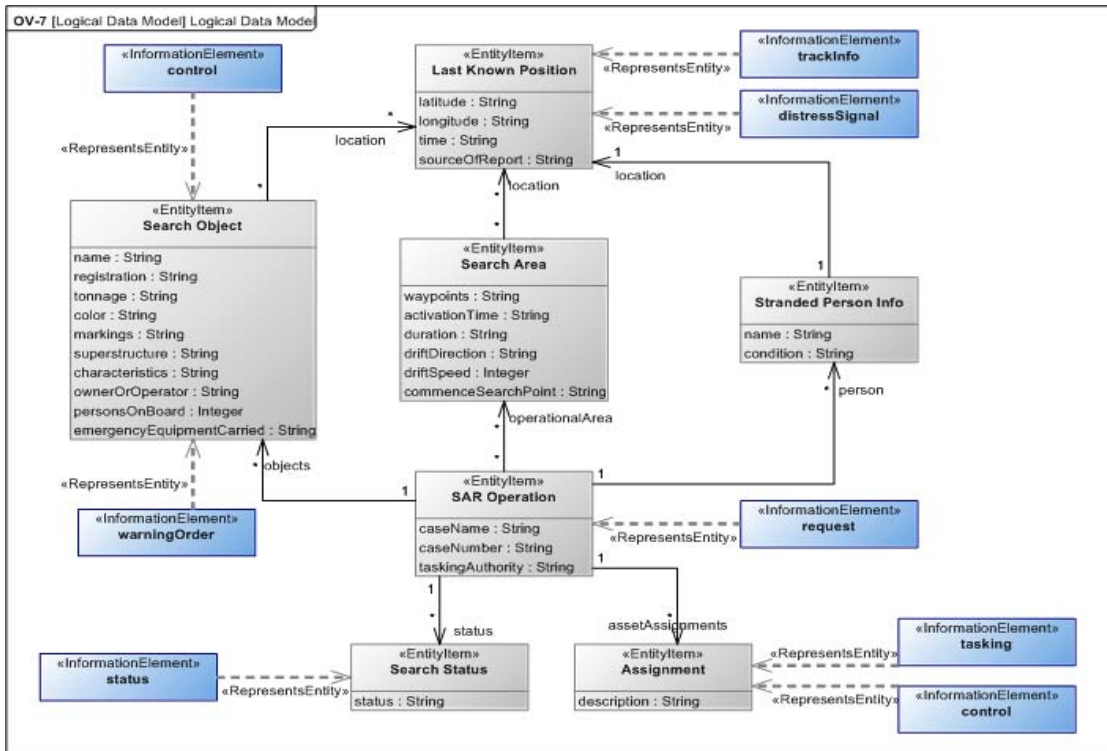

Figure D.24 - OV-7

D.8 Service Oriented Views (DoDAF SvcV-1)

The Service Oriented views describe the services needed to directly support the Search and Rescue operations described in the Operational View and System View. They are normally used when creating Service Oriented Architectures (SOA). The Service Oriented Views do not specify how the service is to be implemented, but the requirements for the services. The implementation of the services is normally implemented by the Systems Views. In this example, various services are defined to support Search and Rescue capabilities.

D.8.1 SOV-1 Service Taxonomy

The SOV-1 view specifies the hierarchy of services as well as the relationships between them. Figure D.25 shows the hierarchy of services within the Search and Rescue Service with Land and Maritime Search and Rescue Services as specializations of the SAR Service. Additional services are also defined to support SAR such as Communications, Coordination and so forth. These will be used in the rest of the SOVs as well as the OV and SV.

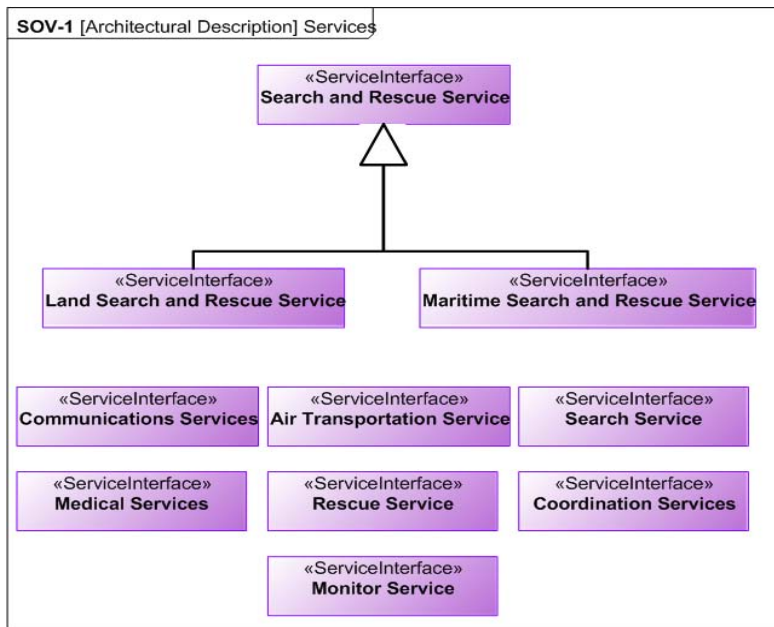

Figure D.25 - SOV-1

D.8.2 SOV-2 Service Interface Specification (DoDAF SvcV-2)

Figure D.26 defines the interfaces that will provide access to the services and those required by services. Many UPDM elements can provide and consume services. Specifying the interface for the service provides a means of determining compatibility between service consumers and providers. Service operations and attributes can also be defined on the SOV-2. Figure D.26 shows the interfaces for the services defined on the SOV-1, and the operations and parameters of the operations provided by the interfaces.

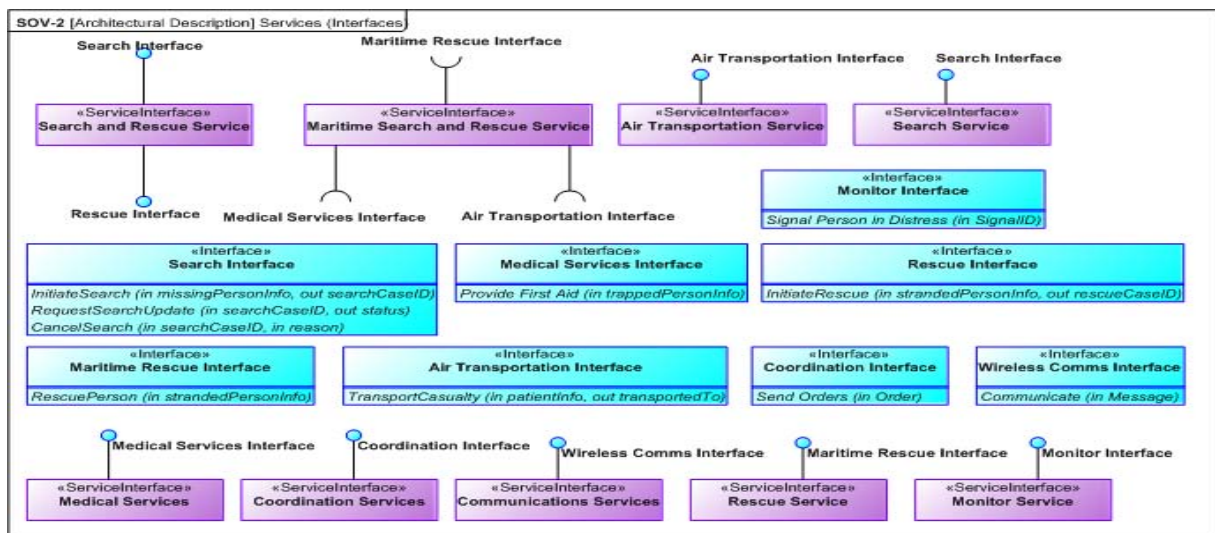

Figure D.26 - SOV-2

D.8.3 SOV-3 Capability to Service Mapping (DoDAF CV-7)

Figure D.27 shows which services contribute to the achievement of a capability. In this example, the Land Search and Rescue Service exposes (supports/realizes) the Land SAR Capability. Likewise, the Maritime Search and Rescue Service exposes the Maritime SAR Service. MODAF 1.2.004 specifies that the service must completely realize the capability it exposes. Additional services and capabilities are also shown.

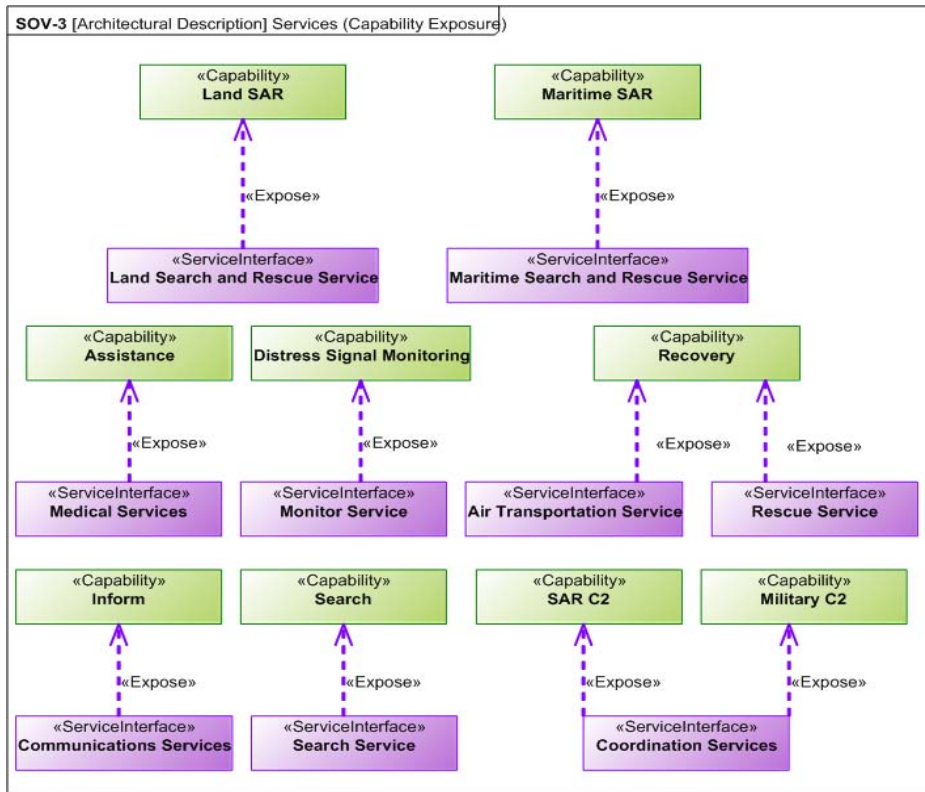

Figure D.27 - SOV-3

D.8.4 SOV-4a Service Behaviors and Constraints (DoDAF SvcV-10a)

The SOV-4a defines constraints that must be adhered to by Consumers and Providers of the Services via Service Policies. This also provides a means of performing trade-off analysis of the possible service providers. As a minimum it defines a set of criteria to determine whether or not the service provider meets the provision requirements defined by the constraints. Table D.9 shows a sample of the services and their associated service policies.

Table D.9 - SOV-4a Service Policies

Service Interface		Service Policy
Name	Name	Text
Land Search and Rescue Service	Driving Record	Any member involved in the operation of road vehicles must have a clean driving record.
Maritime Search and Rescue Service	Swim	All members of the rescue team must be able to swim.
Search and Rescue Service	First Aid	All members of the rescue team must be able to perform basic first aid.
	Danger	No member of the search and rescue team should put themselves in unnecessary danger.

D.8.5 SOV-4b Service Behaviors and Constraints (DoDAF SvcV-10b)

The SOV-4b defines behavioral constraints that must be adhered to by Consumers and Providers of the Services. Specifically it defines the state based behavior of the service defining the states, transitions between those states, the events that cause those transitions to take place and behaviors within those states. Figure D.28 shows the state diagram describing the state based behavior of the Maritime Search and Rescue Service.

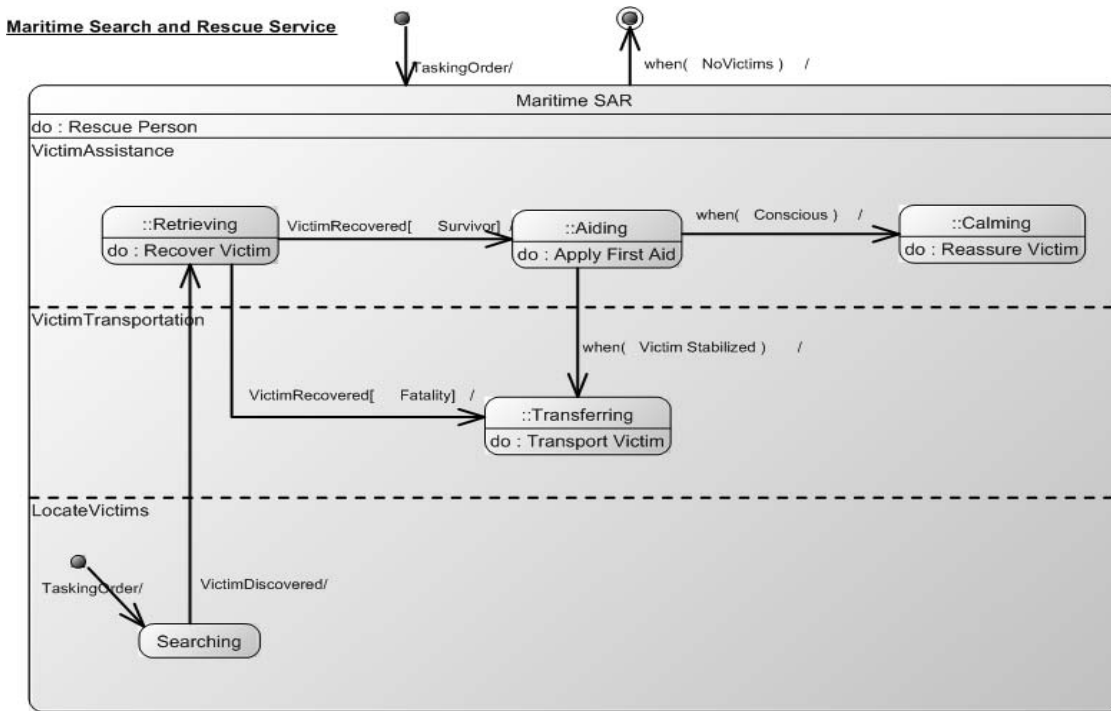

Figure D.28 - SOV-4b

D.8.6 SOV-5 Service Functionality (DoDAF SvcV-4)

Figure D.29 defines the Service Functions to describe the abstract behavior of each Service Operation. It specifies the set of functions that the service implementation is expected to perform. In this example, the Maritime Search and Rescue service provides the rescue function. This function is further decomposed to its sub-functions.

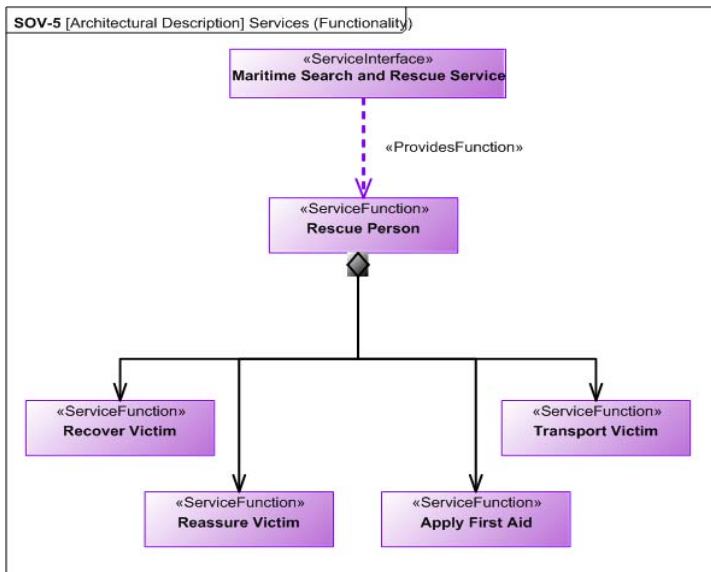

Figure D.29 - SOV-5

D.9 Systems Views

These views describe the resources that realize the SAR capabilities or implement services. They describe resource functions, interactions between resources, and can provide detailed system interface models. System views can describe the “as-is” and/or “to-be” configuration. In addition, several different configurations can be created to perform trade-off analysis. When used in conjunction with SysML, the systems should be developed to the degree that they define the requirements for actual systems that will be implemented. Developing the system views to too much detail will unnecessarily constrain the solution and will involve duplication of work.

System elements can include more than just physical systems. They can include software, organizational resources such as organizations, posts and roles. MODAF defines the concept of a Capability Configuration which is a composition of resources that can deliver a capability. As in the operational views, interactions can consist of more than just information and can include Posts, organizations, capability configurations, energy and software.

D.9.1 SV-1 Resource Interaction Specification (DoDAF Systems Interface Description)

The SV-1 defines the structure and internal flows of the system architectures to demonstrate how they realize the logical architecture defined in the operational views. The interfaces and interactions are defined at the level of specifying a need for the systems to interact and the way in which they do so. These systems can be decomposed to any level required. Figure D.30 shows the Capability Configuration of a Maritime Rescue Unit. The Maritime Rescue Unit is comprised of the Maritime Rescue Team (MRT), and the roles that make up the MRT, as well as the components that enable them to fulfill their role. This example shows that the Role of Driver is filled by a MRT Member who must interact with a MR Boat.

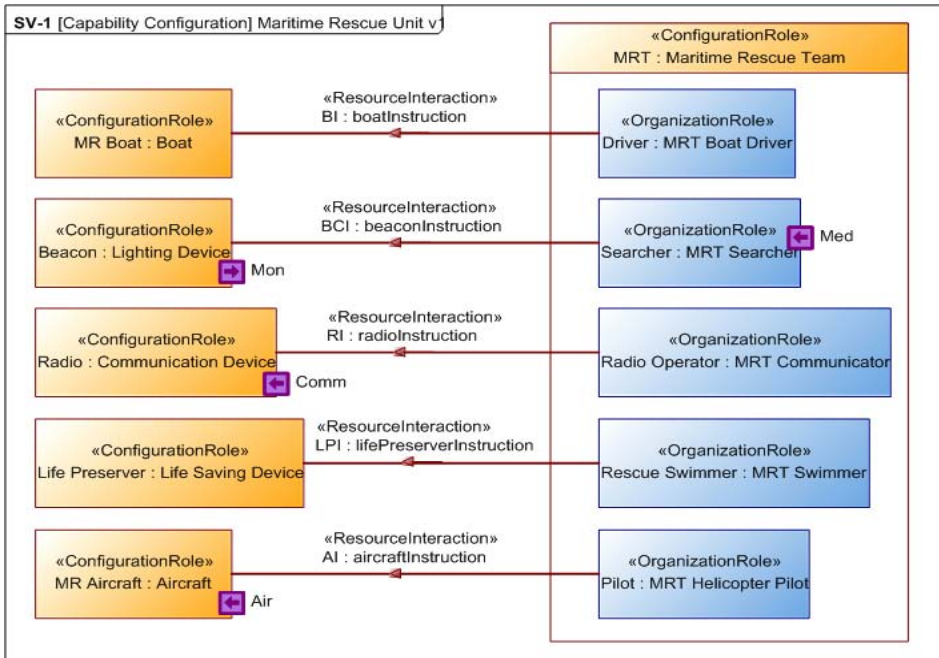

Figure D.30 - SV-1 Maritime Rescue Unit

D.9.2 SV-2 Systems Communications Description (DoDAF System Resource Flow Description)

The SV-2 defines the communications networks and pathways that link the systems as well as providing details about the configuration. MODAF defines 3 separate views for Port Specification (SV-2a), System to System Port Connectivity (SV-2b), and System Connectivity Clusters (SV-2c). All these details can be shown by using the Internal Block Diagram as has been implemented in UPDM. System Protocols and Standards can also be shown. Figure D.31 shows systems interconnections for a number of entities in a maritime search and rescue scenario.

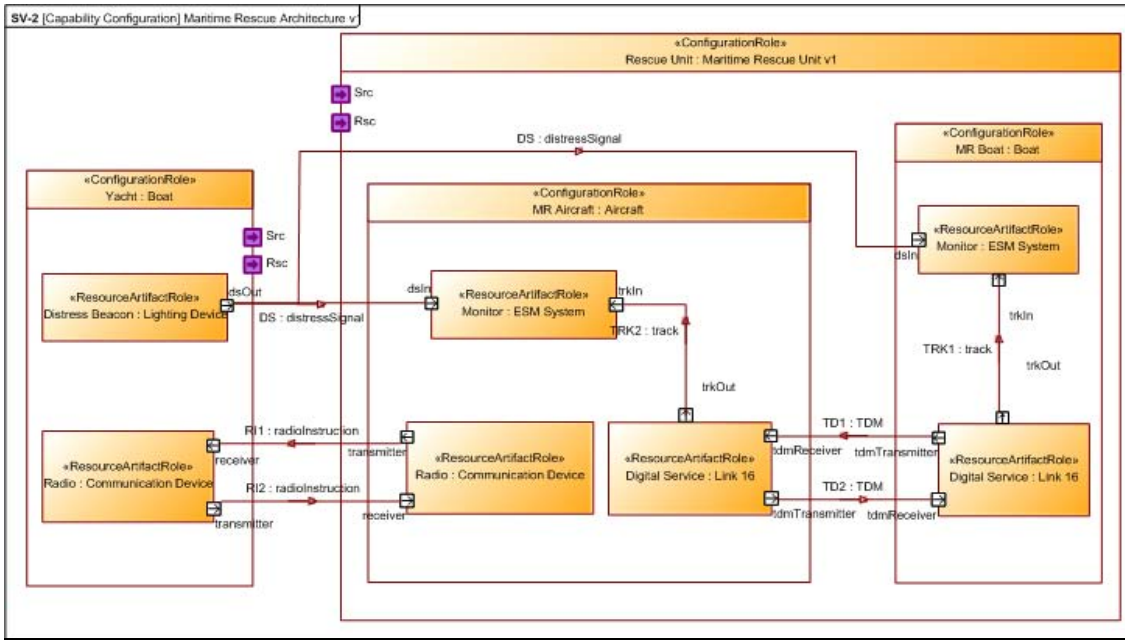

Figure D.31 - SV-2

D.9.3 SV-3 Resource Interaction Matrix (DoDAF Systems - Systems Matrix)

The SV-3 is a summary report of the interactions defined in the SV-1. It expresses the connections between the system elements. Table D.10 does this in the form of a matrix. For simplicity and readability, the matrix has been reduced to show only those systems that are connected.

Table D.10 - SV-3 System Connectivity Matrix

	«Resource Artifact» Aircraft	«Resource Artifact» Boat	«Resource Artifact» Communication Device	«Resource Artifact» ESM System	«Resource Artifact» Life Saving Device	«Resource Artifact» Lighting Device	«Resource Artifact» Link 16	«Resource Artifact» Safety Device
«Post» MRT Boat Driver		X						
«Post» MRT Communicator			X					
«Post» MRT Helicopter Pilot	X							
«Post» MRT Searcher						X		
«Post» MRT Swimmer					X			
«ResourceArtifact» Communication Device			X					
«ResourceArtifact» Lighting Device				X				
«ResourceArtifact» Link 16				X			X	
«ResourceArtifact» Safety Device								

D.9.4 SV-4 Functionality Description (DoDAF Systems Functionality Description)

The SV-4 defines the functions carried out by the different types of Resources. This includes organizational resources such as posts and organizations. Two forms can be used. Figure D.32 shows a hierarchical breakdown of the Rescue Victim function. It is also possible to show the resource that is performing the action. This provides a mapping of resource usage to function.

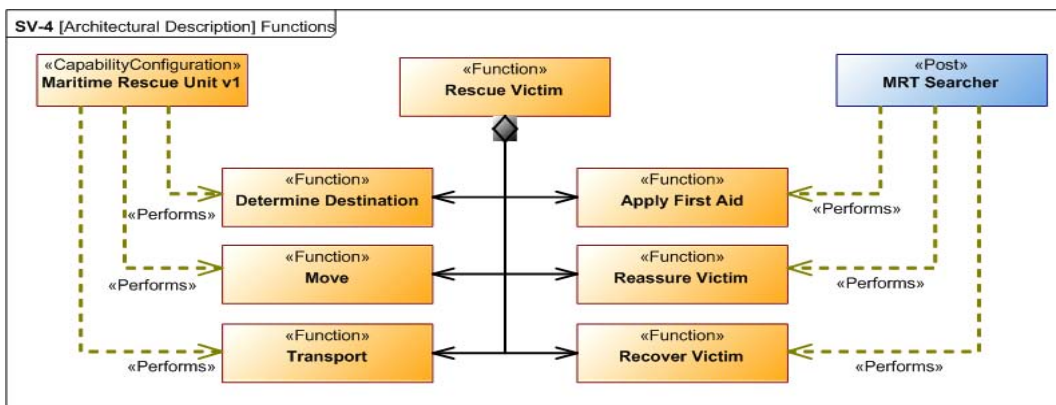

Figure D.32 - SV-4

Figure D.33 is the other type of SV-4 and takes the format of an activity diagram. It shows the Resources using Functions, the operational step-by-step workflows and the overall flow of control. The Maritime Rescue Unit v1 and the MRT Searcher are represented as swim lanes. It shows the functions used by these Resources, the order in which they take place, and the interactions between them to implement the Rescue Victim Activity.

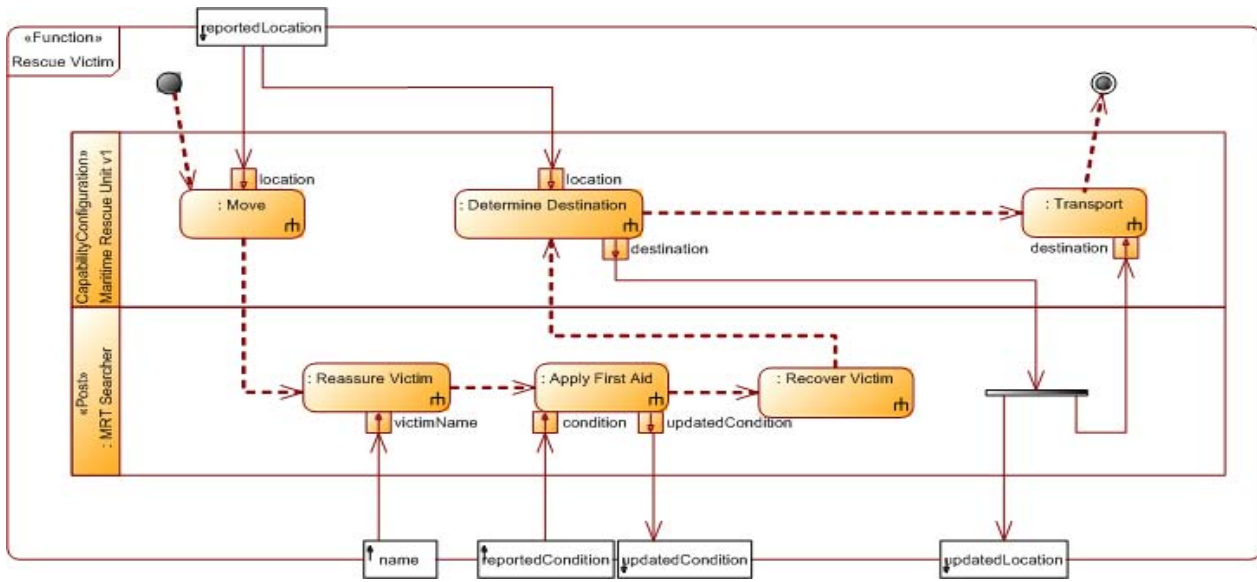

Figure D.33 - SV-4 Activity Diagram

D.9.5 SV-5 Function to Operational Activity/Service Function Traceability

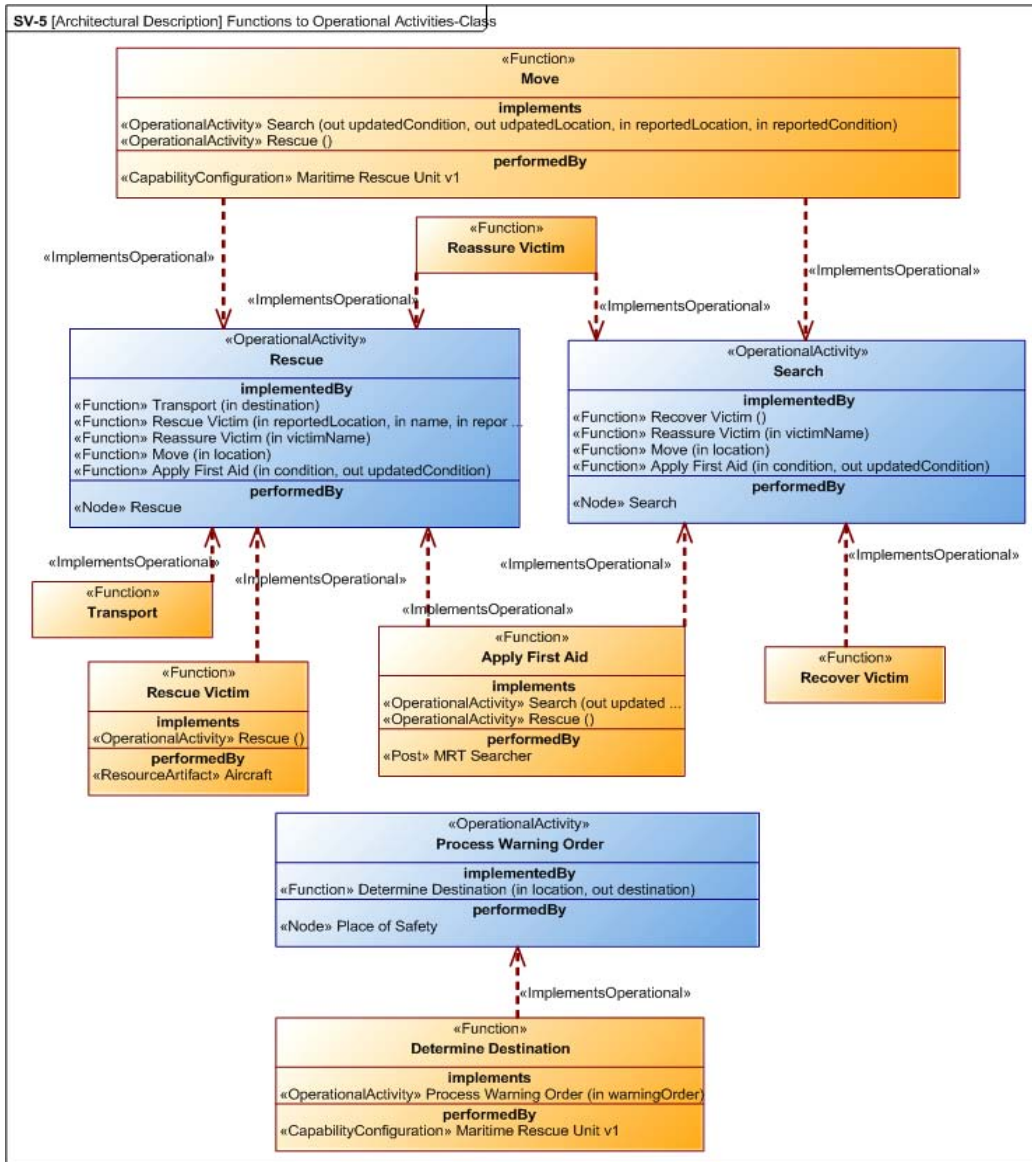

Figure D.34 - SV-5

The SV-5 view is used to show how System Functions support Operational Activities and Service Functions. UPDM also provides a graphical view to define these relationships. Figure D.34 shows the SAR Activities and those System Functions that implement them. This provides an essential requirements traceability capability as well as a means of validating the overall architecture. Functions that do not implement operational activities may be superfluous, and operational activities that are not implemented by functions have not been fully analyzed.

D.9.6 SV-5 System Function to Operational Activity/Service Function Traceability Matrix

Table D.11 summarizes the traceability between the system functions and operational activities in matrix form. It has been simplified for readability.

Table D.11 - SV-5

Realizing Function	Monitor For Distress Signal	Process Warning Order	Rescue	Search
	Apply First Aid			X
Determine Destination		X		
Move			X	X
Reassure Victim			X	X
Recover Victim				X
Rescue Victim			X	
Search				
Transport			X	

D.9.7 SV-6 System Exchange Matrix (DoDAF Systems Resource Flow Matrix)

The SV-6 summarizes the interactions between the resources in the SV-1 and SV-2. Table D.12 shows the interactions between the SAR resources. Additional fields can also be included such as measurements associated with the exchange.

Table D.12 - SV-6

Resource Interaction		Producer	Connector / Interface	Consumer
Name	Conveyed	Resource	Name	Resource
AI	aircraftInstruction	MRT HelicopterPilot	Resource Interface	Aircraft
BCI	beaconInstruction	MRT Searcher	Resource Interface	Lighting Device
BI	boatInstruction	MRT Boat Driver	Resource Interface	Boat
DS	distressSignal	Lighting Device	Resource Connector	ESM System
DS	distressSignal	Lighting Device	Resource Connector	ESM System
LPI	lifePreserverInstruction	MRT Swimmer	Resource Interface	Life Saving Device
RI	radiInstruction	MRT Communicator	Resource Interface	Communication Device
RI1	radiInstruction	Communication Device	Resource Connector	Communication Device
RI2	radiInstruction	Communication Device	Resource Connector	Communication Device
TD1	TDM	Link 16	Resource Connector	Link 16
TD2	TDM	Link 16	Resource Connector	Link 16
TRK1	track	Link 16	Resource Connector	ESM System
TRK2	track	Link 16	Resource Connector	ESM System

D.9.8 SV-7 Resource Performance Parameters (DoDAF Systems Measures Matrix)

This view defines the types of measurements that are important to the system resources. It consists of measurable, qualitative properties. It is normally shown in tabular form. Figure D.35 shows the Capability Configurations that are linked to the various measurements.

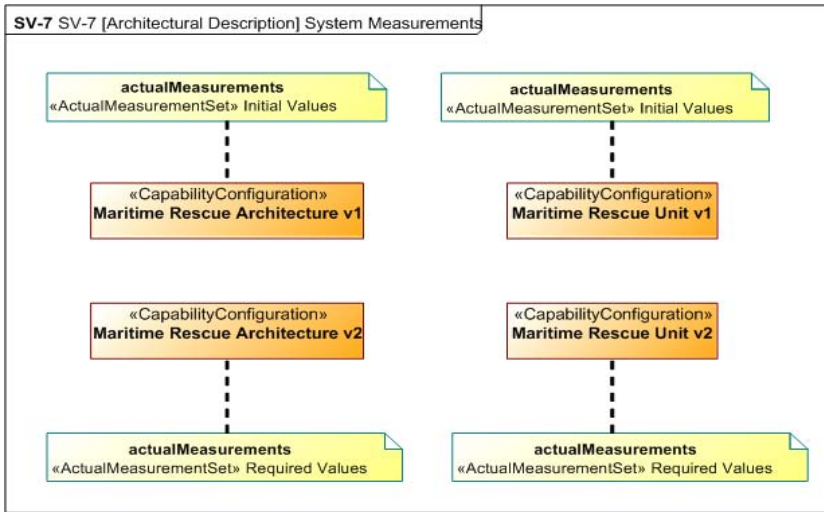

Figure D.35 - SV-7

Table D.13 shows the SV-7 in tabular format, specifying qualitative and quantitative characteristics of resources. These are the same measurements that were defined in Figure D.3 and Figure D.4. This is a generated report.

Table D.13 - SV-7 in Tabular Format

		Actual Measurement Set						
Name	Name	Intention	Measurement	Minimum Value	Actual Value	Maximum Value	Unit	Dimension
Maritime Rescue Unit v1	Initial Values	Estimate	seaConditions	Sea State 1	Sea State 6	Sea State 10	Meter	Wave Height
			areaCoverage	100	500	1000	SquareKilometers	Area
			findTime	4	<8 hours	8	Hours	Time
			persistence	5	>15 hours	22	Hours	Time
			searchCoverage	200	400	600	SquareKilometers	Area
			weatherConditions	Calm	Heavy Rain	Hurricane	Weather Severity Index	
Maritime Rescue Unit v2	Required Values	Required	seaConditions	Sea State 1	Sea State 8	Sea State 10	Meter	Wave Height
			areaCoverage	100	600	1000	SquareKilometers	Area
			findTime	4	<5 hours	8	Hours	Time
			persistence	5	>20 hours	22	Hours	Time
			searchCoverage	200	500	600	SquareKilometers	Area
			weatherConditions	Calm	Stormy	Hurricane	Weather Severity Index	
	Final Values	Result	seaConditions	Sea State 1	Sea State 8	Sea State 10	Meter	Wave Height
			areaCoverage	100	650	1000	SquareKilometers	Area
			findTime	4	<4 hours	8	Hours	Time
			persistence	5	>20 hours	22	Hours	Time
			searchCoverage	200	550	600	SquareKilometers	Area
			weatherConditions	Calm	Stormy	Hurricane	Weather Severity Index	
Monitor								

D.9.9 SV-8 System Capability Configuration Management (DoDAF Systems Evolution Matrix)

The SV-8 view is used to show the whole lifecycle of a resource showing how its configuration changes over time. It shows the capabilities, the resources that implement those capabilities, and any constituent components. Table D.14 shows the lifecycles for Assistance, Search, and Distress Signal Monitoring. Note that Distress Signal Monitoring does not have any implementing resources. This is also useful information.

Table D.14 - SV-8

Capability	Realizing Resource		Milestone Dates					
	Name	Components	2010-01-01	2010-07-01	2010-08-01	2010-11-01	2011-01-01	2011-05-01
Assistance	«Capability Configuration» Maritime Rescue Unit v2				Increment			Out Of Service
	«Capability Configuration» Maritime Rescue Unit v1	«Resource Artifact» Lighting Device	Increment				Out Of Service	
		«Resource Artifact» Life Saving Device						
		«Resource Artifact» Aircraft						
		«Resource Artifact» Boat						
		«Organization» Maritime Rescue Team						
		«Resource Artifact» Communication Device						
«Capability Configuration» Automated Rescue Unit v1			Increment			Out Of Service		
Distress Signal Monitoring								
Search	«Capability Configuration» Maritime Rescue Unit v2				Increment			Out Of Service
	«Capability Configuration» Maritime Rescue Unit v1	«Resource Artifact» Lighting Device	Increment				Out Of Service	
		«Resource Artifact» Life Saving Device						
		«Resource Artifact» Aircraft						
		«Resource Artifact» Boat						
		«Organization» Maritime Rescue Team						
		«Resource Artifact» Communication Device						
«Capability Configuration» Automated Rescue Unit v1			Increment			Out Of Service		

D.9.10 SV-9 Technology and Skills Forecast (DoDAF Systems Technology and Skills Forecast)

The SV-9 provides a summary of the current and emerging technologies and skills that impact on the Resources that constitute the architecture. The example shown in Figure D.36 and Table D.15 show the technology forecasts for the resource artifacts used in the systems views. Reports can also be created for competencies (Skill in DoDAF), posts (PersonType in DoDAF), organizations (OrganizationType in DoDAF), etc.

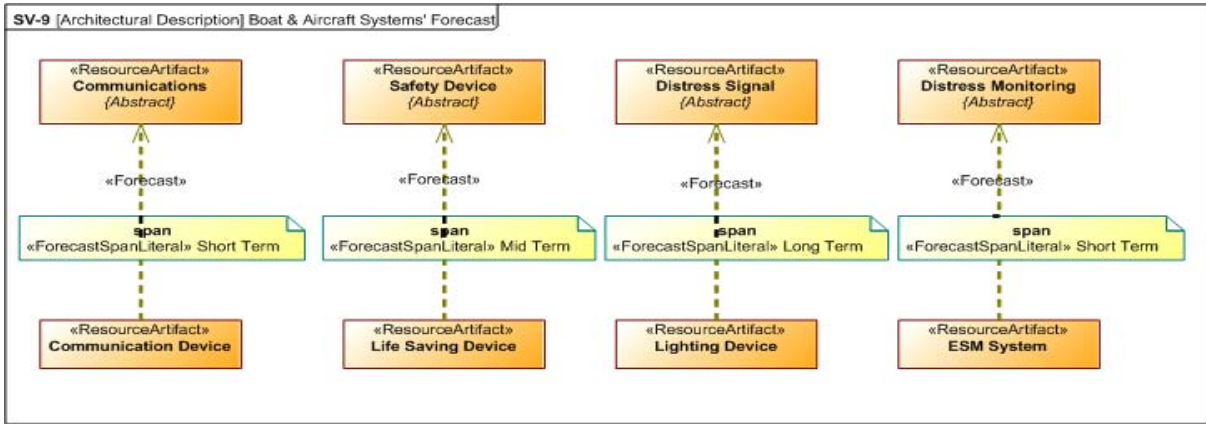

Figure D.36 - SV-9

D.9.11 SV-9 Technology and Skills Forecast

Table D.15 shows the tabular view of the technology forecast for the system resources.

Table D.15 - SV-9

Category Type	Category	Short Term	Long Term	Mid Term
«ResourceArtifact»	Communications	Communication Device		
«ResourceArtifact»	Distress Monitoring	ESM System		
«ResourceArtifact»	Distress Signal		Lighting Device	
«ResourceArtifact»	Safety Device			Life Saving Device

D.9.12 SV-10a System Rules and Constraints (DoDAF Systems Rules Model)

The SV-4 defines the functional specification of the behavior of the system resources. The SV-10a, SV-10b, and SV-10c augment this by defining the constraints, state behavior, and sequence of interactions of the resources. Table D.16 defines the constraints on a sample of system resources.

Table D.16

Resource Constraint		
Name	Name	Text
Boat	GMDSS Vessel Requirements	Ships subject to Title II Part II and Part III of the Communications Act of 1934, as amended have to fit GMDSS equipment under FCC Regulation 47 CFR 80 Subpart W. These include all ships, including fishing vessels, to be navigated in the open sea outside of a harbor or port, except: Ships other than passenger vessels less than 300 gross tonnage, Passenger ships having six passengers or less, U.S. government ships, Yachts of less than 600 gross tons, Vessels in tow, Ships navigating solely on any bays, sounds, rivers or protected waters within the U.S., Ships being navigated within the Great Lakes of North America, and Small passenger ships meeting the requirements of 47 CFR 80 Subpart S.
	Marine Vessel Communications	Mariners need to be able to communicate with other ships of any size or nationality. Mariners need to be able to receive and send urgent maritime safety information. Mariners need to be able to send or receive distress alerts in an emergency to or from rescue coordination centers ashore and nearby ships anywhere in the world.
	Radio Watch Keeping	In general, any vessel equipped with a VHF marine radiotelephone (whether voluntarily or required to) must maintain a watch on channel 16 (156.800 MHz) whenever the radiotelephone is not being used to communicate.
Communication Device	Distress System Usage	The radiotelephone alarm signal is used only in a distress, including when a person has been lost overboard and the assistance of other vessels is required.
	GMDSS Equipment Operation	A GMDSS Radio Operator's License is necessary for a person to use required GMDSS equipment.
Lighting Device	Distress System Usage	The radiotelephone alarm signal is used only in a distress, including when a person has been lost overboard and the assistance of other vessels is required.
Safety Device	[none]	[none]

D.9.13 SV-10b Resource State Transition Description (DoDAF System State Transition Description)

The SV-10b uses a state diagram to describe the resource’s responses to the various events that it can receive. It can also be to show the operational states of the resource. Figure D.37 shows the state based behavior for the aircraft.

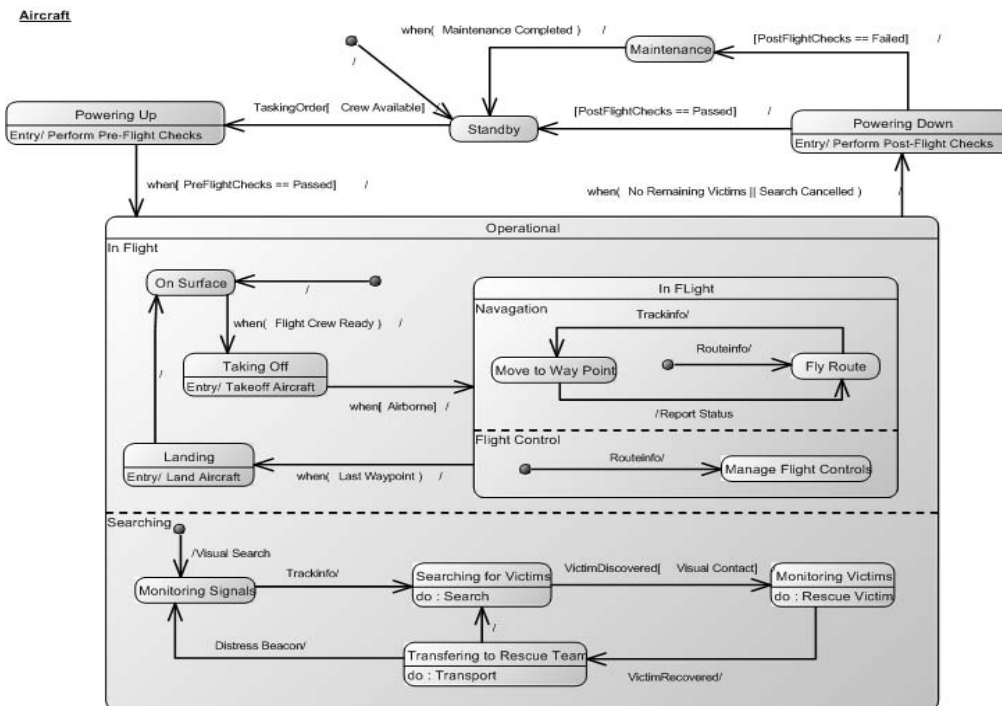

Figure D.37 - SV-10b

D.9.14 SV-10c Resource Event Trace Description (DoDAF System Event Trace Description)

The SV-10c defines a sequence of interaction between system resources in time order normally to execute a scenario or to fulfill some other functional requirement. This diagram is normally used once the architecture has been well defined. It is useful as a means of determining if sufficient interactions and system resources have been defined to allow the architecture to fulfill its functional requirements. Figure D.38 shows a search and rescue scenario.

Maritime Rescue Architecture of Description

```

par Yacht broadcasts distIn Distress Beacon
MR Aircraft receives data Distress Beacon from Yacht
MR Boat receives data Distress Beacon from Yacht
end par
par
MR Aircraft transmits radio instructions to Yacht
also par
IdmTransmitter propagates InOut to Monitor link
IdmTransmitter propagates InOut to Monitor link
end par
Until all victims are rescued
Do:
MR Boat Digital Service link IdmTransmitter transmits to MR Aircraft
MR Aircraft Digital Service link IdmTransmitter transmits to MR Boat
MR Aircraft transmits radio instructions to Yacht
Yacht transmits radio instructions back to MR Aircraft
end loop

```

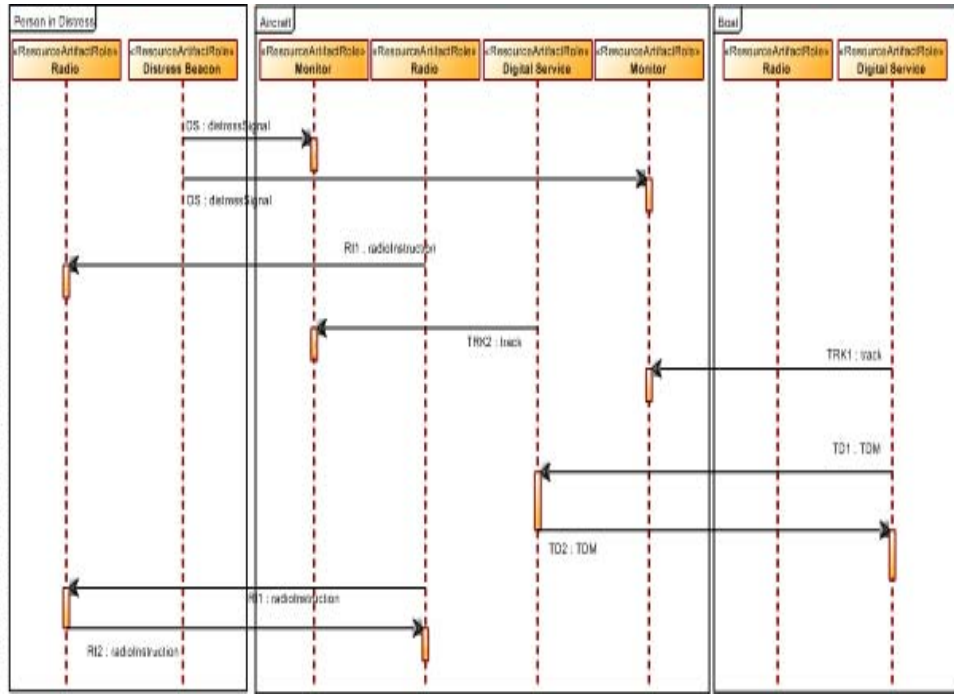

Figure D.38 - SV-10c

D.9.15 Physical Schema (DoDAF DIV-3)

The SV-11 defines the structure of various kinds of system data that are utilized by the system resources. These are the data elements used by the SV-1, SV-2, SV-4, and SV-10c interactions. Data elements are defined that are defined by entities. These entities can have complex structures. Figure D.39 shows the initial stages of the definition of the SAR data model.

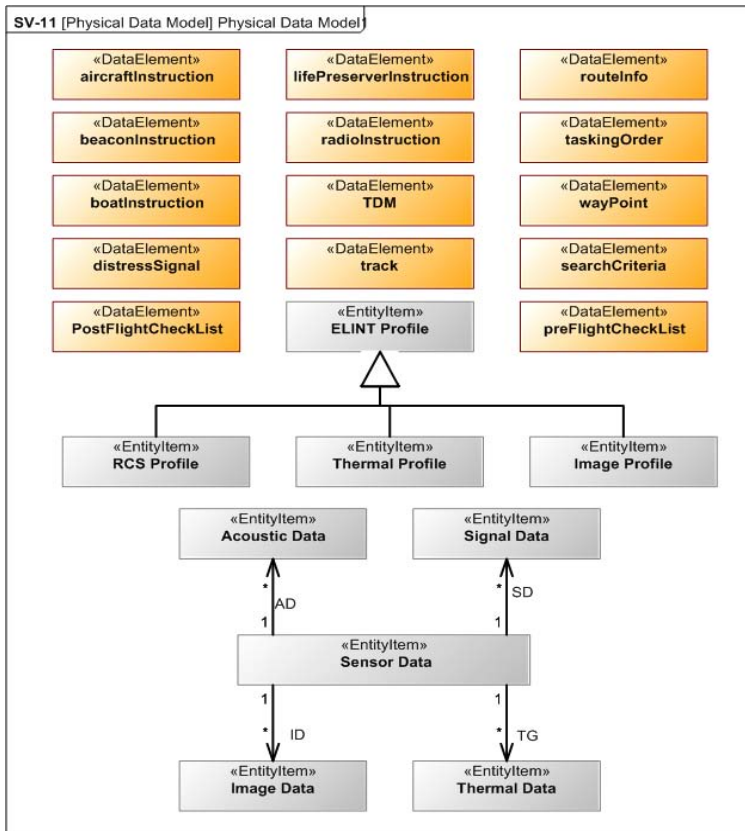

Figure D.39 - SV-11

D.9.16 System Service Provision

The SV-12 is used to describe the system resources that deliver services. This takes the form of a matrix report. The service provision relationship is provided by the service point on the SV-1 and SV-2 diagrams. Table D.17 shows the system resources that provide these services. Note that they can be Posts, System Artifacts, Capability Configurations, etc.

Table D.17 - SV-12

	Air Transportation Service	Communications Services	Medical Services	Rescue Service	Search Service
«CapabilityConfiguration» Maritime Rescue Unit v1				X	X
«Post» MRT Searcher			X		
«ResourceArtifact» Aircraft	X				
«ResourceArtifact» Boat					
«ResourceArtifact» Communication Device		X			

D.10 Acquisition Views (DoDAF Project Views)

The Acquisition views identify top-level tasks in the acquisition process. They help you understand how resources, assets and capabilities are acquired during the life of the project. It gives you the ability to perform analysis to determine if the resources can be obtained, if they are available in the time they are needed, and the overall effect on the schedule. They can also show whether or not complete coverage of the Defence Lines of Development (DLOD) (known as DOTMLPF in the DoD) are fully covered.

D.10.1 AcV-1 System of Systems Acquisition Clusters (DoDAF PV-1)

The AcV- 1 represents an organizational perspective of the program. It allows the user to model the organizational structures needed to manage a portfolio of projects. Table D.18 shows who is responsible for the SAR Project, as well as the project type.

Table D.18 - AcV-1

Project Owner	Actual Project
Department Of Transport	SAR Manual Project I
	SAR Automation Project
	SAR Manual Project II

D.10.2 AcV-2 Program Timeline (DoDAF PV-2)

The AcV-2 Program Timeline diagram allows management the ability to view a summary of project status across the complete program timeline. It also provides a means of viewing the DLOD status for each of the defined milestones for the project. This and the AcV-3 diagram provide much of the information for the StV-3 (DoDAF CV-3) view. Figure D.40 shows the 3 projects and their associated milestones. They are spaced according to time order. The pie charts represent the DLODs and their meaning is defined on the key to the right. The example is somewhat artificial in that the milestones are all spaced 6 months apart. This has been done for clarity of reading.

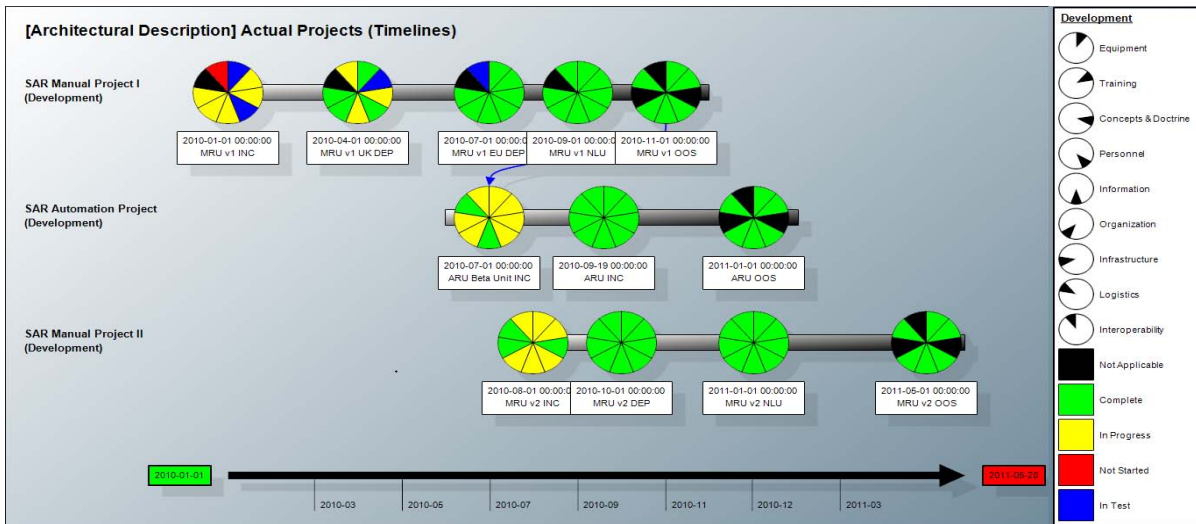

Figure D.40 - AcV-2

D.10.3 AcV-3 Typical Project (DoDAF PV-3)

The AcV-3 class diagram provides a means of defining projects and project types. In Figure D.41, the development project can contain other development projects. Development projects contain milestones containing project themes corresponding to DLOD (DoD DOTMLPF) themes.

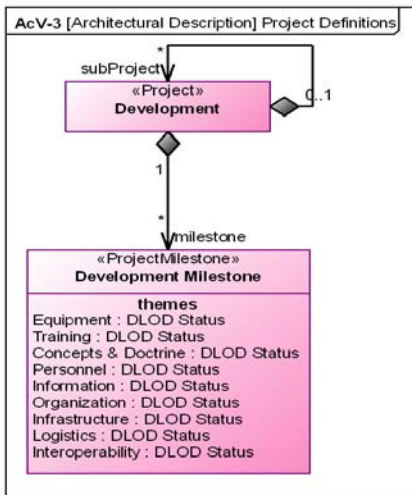

Figure D.41 - AcV-3 Class Diagram

D.10.4 AcV-3 Actual Project Instance (DoDAF PV-3)

The AcV-3 provides a means of defining actual projects and actual project milestones. In Figure D.42 three SAR projects and their project milestones are shown.

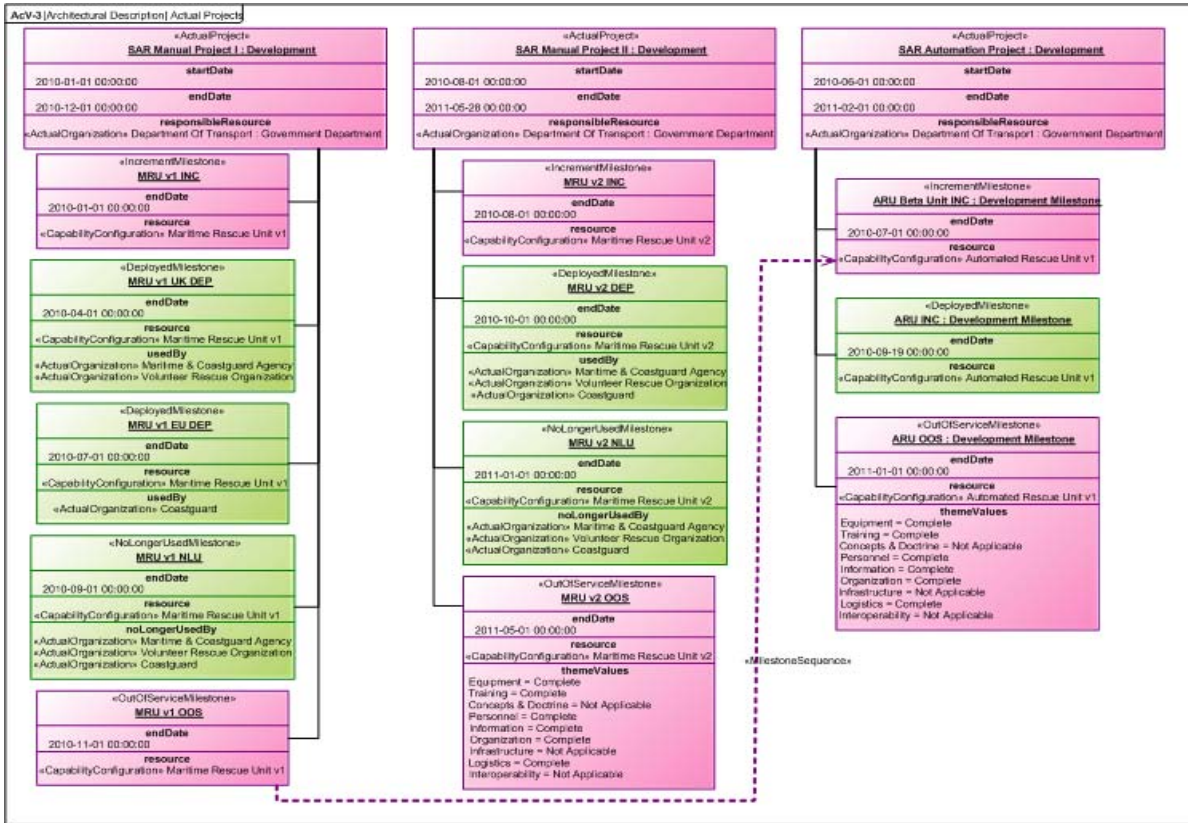

Figure D.42 - AcV-3 Actual

The project also contains increment and deployment milestones that provide a means of showing when resources are deployed and rendered out of service as well as capability increments. An example out of service milestone is shown in Figure D.43.

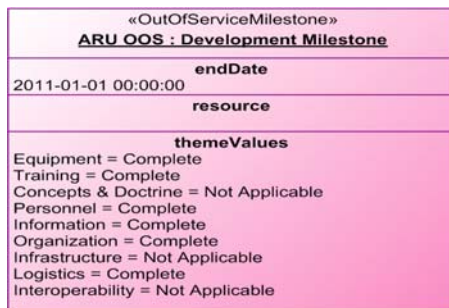

Figure D.43 - AcV-3 Additional Milestone Types

D.11 Technical Views (DoDAF Standards Views)

The Technical views identify the standards, rules, policy and guidance that are applicable to parts of the architecture and the architecture as a whole. Communications protocols can also be defined.

D.11.1 TV-1 Standards Profile (DoDAF StdV-1)

The TV-1 report is in the form of a matrix and summarizes the architecture elements that conform to the various defined standards. Table D.19 shows the conforming elements on the left and the applicable standards across the top. Systems can conform to multiple standards as in the Link 16.

Table D.19 - TV-1

	«Standard» Global Maritime Distress and Safety System (GMDSS)	«Standard» MGN 324 Operational Guidance on the Use Of VHF Radio and Automatic Identification Systems	«Standard» MIL-STD-6016	«Standard» STANAG 5516	«Standard» USCG Marine Radio Information For Boaters
«ResourceArtifact» Communication Device (SAR Architecture::Resources::Resource Artifacts)		X			X
«ResourceArtifact» ESM System (SAR Architecture::Resources::Resource Artifacts)	X				
«ResourceArtifact» Lighting Device (SAR Architecture::Resources::Resource Artifacts)	X				
«ResourceArtifact» Link 16 (SAR Architecture::Resources::Resource Artifacts)			X	X	
«ResourcePort» dsIn (SAR Architecture::Resources::Resource Artifacts::ESM System)	X				
«ResourcePort» dsOut (SAR Architecture::Resources::Resource Artifacts::Lighting Device)	X				
«ResourcePort» receiver (SAR Architecture::Resources::Resource Artifacts::Communication Device)		X			X
«ResourcePort» tdmReceiver (SAR Architecture::Resources::Resource Artifacts::Link 16)			X	X	
«ResourcePort» tdmTransmitter (SAR Architecture::Resources::Resource Artifacts::Link 16)			X	X	
«ResourcePort» transmitter (SAR Architecture::Resources::Resource Artifacts::Communication Device)		X			X

Conforming Elements

D.11.2 TV-2 Standards Forecast (DoDAF StdV-2)

UPDM provides a class diagram and report format for the TV-2. The class diagram form provides a means of defining the standards and their attributes as well as linking the standards forecasts to them. Figure D.44 shows the various SAR standards provided by ASTM. ASTM International, originally known as the American Society for Testing and Materials (ASTM) is now an international standards body with standards ranging from safety in recreational aviation, to fiber optic cable installations in underground utilities, to homeland security. More information on them can be found at www.ASTM.org. The spans shown are for illustration purposes only. They are normally shown to denote emerging standards.

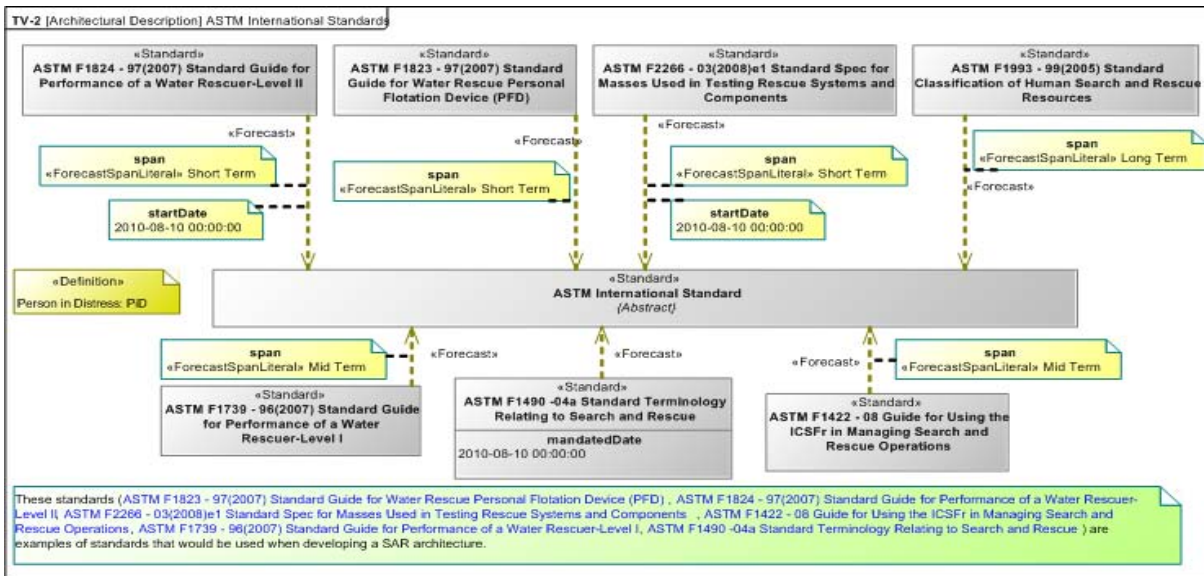

Figure D.44 - TV-2

Figure D.45 shows a variety of standards for marine radio, Link 16, and distress monitoring. These are part of the Capability Configuration shown in the SV-2 diagram.

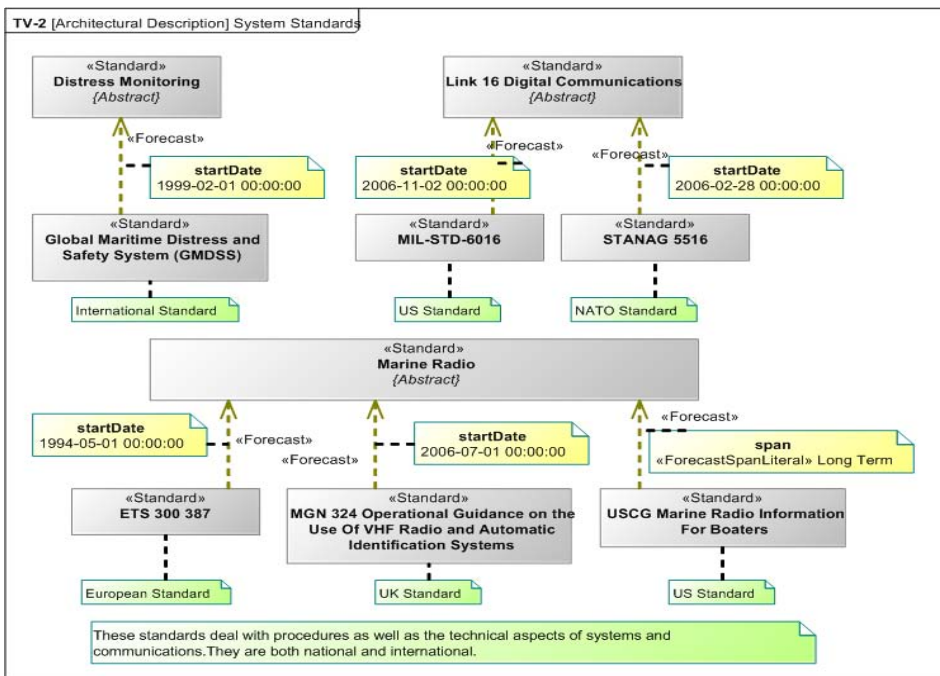

Figure D.45 - TV-2

D.11.3 TV-2 Standards Forecast Tabular Form (DoDAF StdV-2)

Table D.20 shows a summary of the ASTM international standards.

Table D.20 - TV-2

Category Type	Category	Mid Term	Short Term	Long Term	[Undefined]
«Standard»	ASTM International Standard	ASTM F1422 - 08 Guide for Using the ICSFr in Managing Search and Rescue Operations ASTM F1739 - 96(2007) Standard Guide for Performance of a Water Rescuer-Level I	ASTM F2266 - 03(2008)e1 Standard Spec for Masses Used in Testing Rescue Systems and Components ASTM F1823 - 97(2007) Standard Guide for Water Rescue Personal Flotation Device (PFD) ASTM F1824 - 97(2007) Standard Guide for Performance of a Water Rescuer-Level II	ASTM F1993 - 99(2005) Standard Classification of Human Search and Rescue Resources	ASTM F1490 -04a Standard Terminology Relating to Search and Rescue

D.12 A Simple Example of SysML Parametrics

D.12.1 SysML Parametrics

Parametric diagrams are used to describe constraints on system properties to support engineering analysis. In order to support this type of modeling a ConstraintBlock has been introduced into OMG SysML. A ConstraintBlock defines a set of parameters and one or more constraints on the parameters. The parameters and the connectors do not have direction by default. Hence, the constraint relationships are acausal in nature. Causality can be automatically interpreted based on the state of the model (i.e., what variables are known and what are unknown). These ConstraintBlocks are used in a parametric diagram to constrain system properties. ConstraintBlocks may be used to express mathematical equations such as ‘ $F=moa$ ’ and ‘ $a = dv/dt,$ ’ or statistical values and utility functions such as might be used in trade studies. Based on the reusable concept of a block new ConstraintBlocks can be built by reusing more primitive ConstraintBlocks such as basic mathematical operators. As shown in Figure D.46, blocks can also own constraint blocks. Blocks can also own parametric diagrams. This is in fact a more consistent, more scalable, more persistent, and can be less confusing for people new to parametric diagrams.

SysML also defines a model of value types that can have units and dimensions and probability distributions. The value types are used to type properties of blocks. The Parametric Diagram is a specialized variant of an internal block diagram that restricts diagram elements to represent constraint blocks, their parameters and the block properties that they bind to. Both parameters and properties may be represented as small “pin-like” boxes to help make the diagrams more scalable.

For more information on Parametric diagrams and SysML, refer to the following documents:

<http://eislabs.gatech.edu/pubs/conferences/2007-incose-is-1-peak-primer/>

[http://eislabs.gatech.edu/pubs/conferences/2007-incose-is-2-peak-diversity /](http://eislabs.gatech.edu/pubs/conferences/2007-incose-is-2-peak-diversity/)

D.12.2 Scenario Overview

The search and rescue organization is considering using Unmanned Aerial Vehicles (UAV) to perform set search patterns. One of the parameters of search and rescue is to determine how long it will take to cover a specific search area. Various parameters are number of aircraft, crew availability, aircraft speed, aircraft total flight time, etc. With this information they can budget how many aircraft, crew, etc. they will need to help them achieve their goals. The Little Eye model was created by InterCAX to define such a scenario and demonstrate how parametrics can be used to provide trade-off analysis to answer these questions. We are grateful to them for letting us use their example.

D.12.3 SV-3 System Context

The Little System Block Definition Diagram (BDD) shown in Figure D.46 defines the context of the problem definition. It contains the Aircraft, Crew, and Fuel. They each have a set of values corresponding to the properties to be used in the trade-off analysis. For example, the crew has properties of Crew Time On, Number Available Crews, and Number Crews. These will be used as parameters for the parametric equations. The System Availability Equation and the Scanning Equation are owned by the Little Eye System defining the context. The crew has the Crew Availability Equation; the Fuel has the Fuel Availability Equation. Finally, Aircraft has the Aircraft, Night Camera, and Day Camera Availability Equations and the Aircraft Duty Cycle Equation. These equations used together will determine the optimum values for the system configurations.

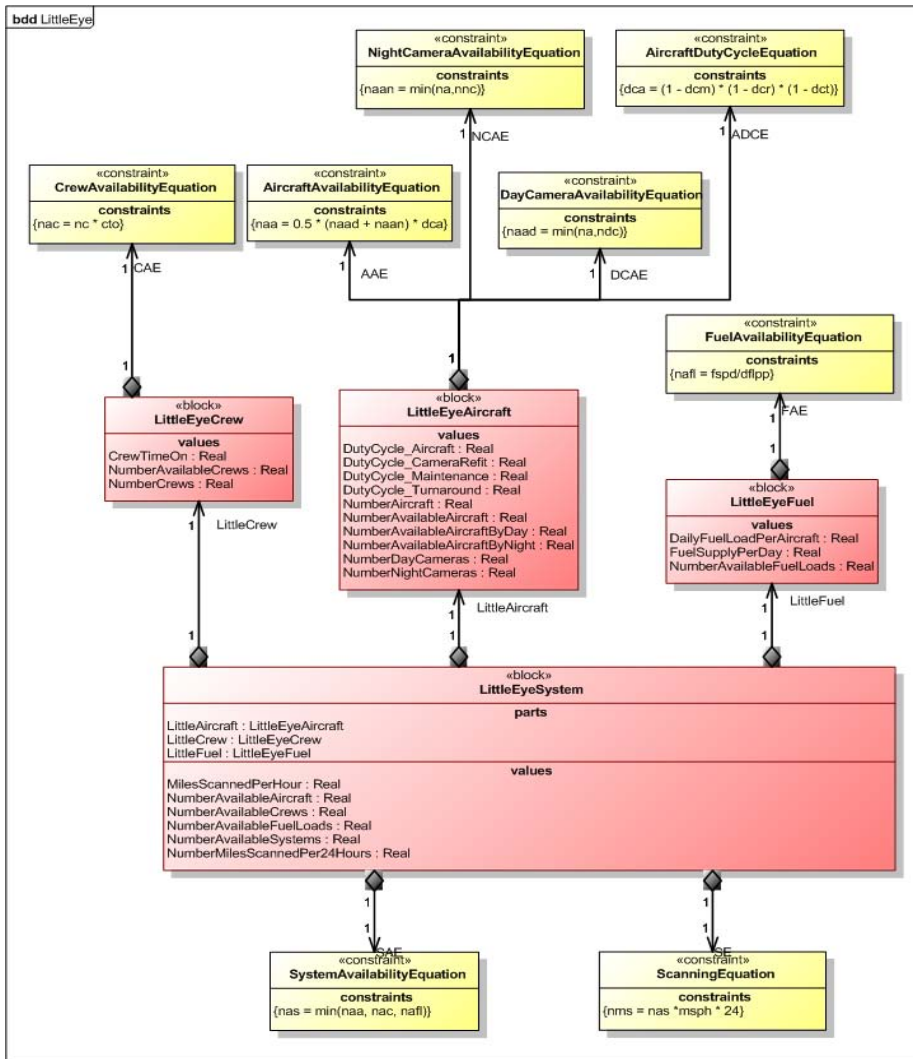

Figure D.46 - Block Definition Diagram

D.12.4 System Parametrics

Figure D.47 shows the Aircraft, Crew and Fuel value types linked to the System Context values.

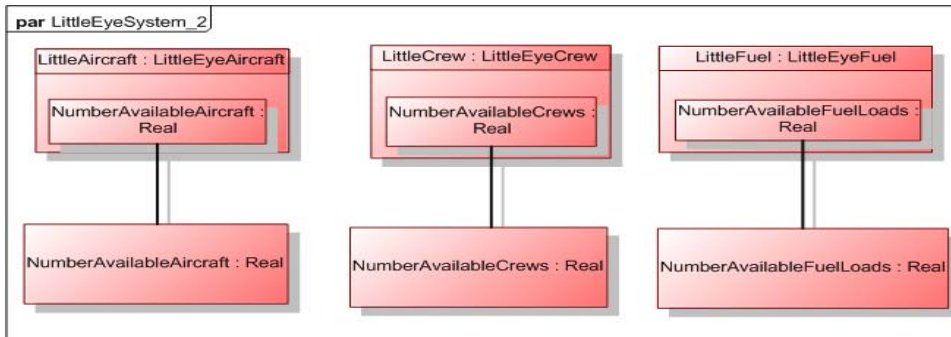

Figure D.47 - System Parametrics

D.12.5 Parametric Equations

Figure D.48 Shows the System Availability and Scanning Equations, their parameters, the value properties and the relationships between them.

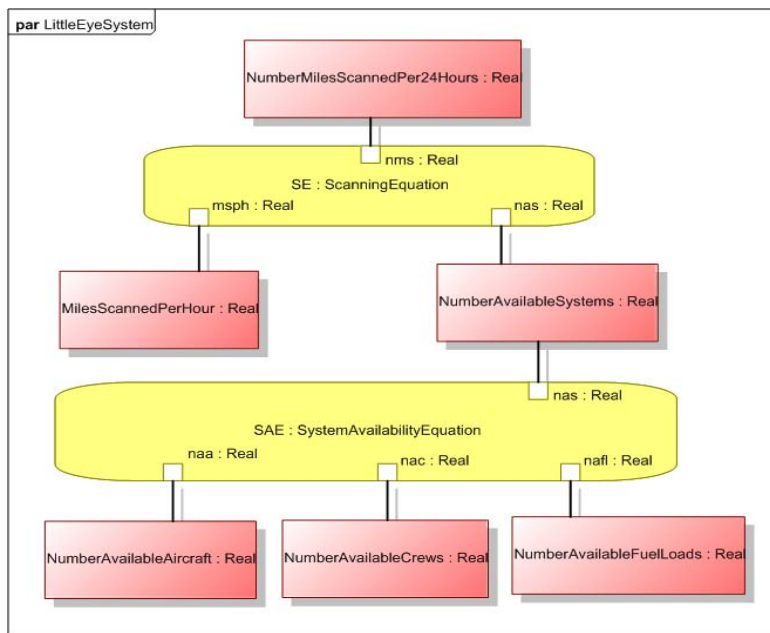

Figure D.48 - Scanning and Availability Equations

Figure D.49 shows the Fuel Availability Equation.

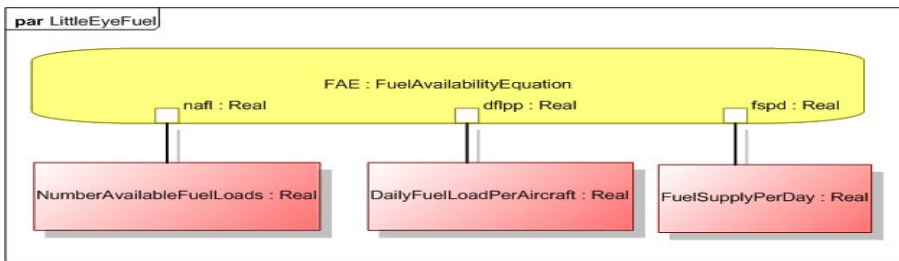

Figure D.49 - Fuel Availability Equation

Figure D.50 shows the Crew Availability Equation.

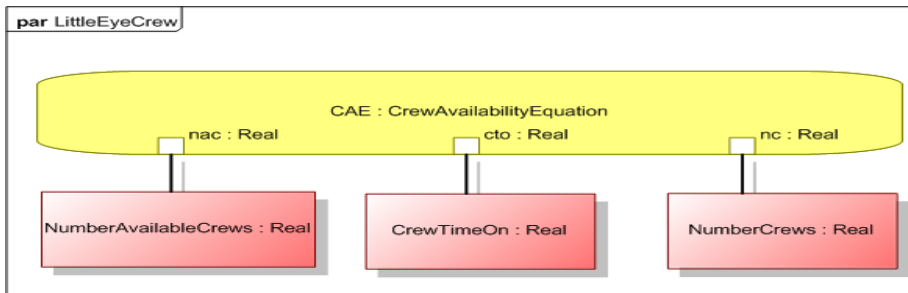

Figure D.50 - Crew Availability Equation

Figure D.51 shows the constraint properties in Little Eye Aircraft. All these parametric equations can be combined together to define the trade-off analysis definition to provide a means of calculating the optimum configuration.

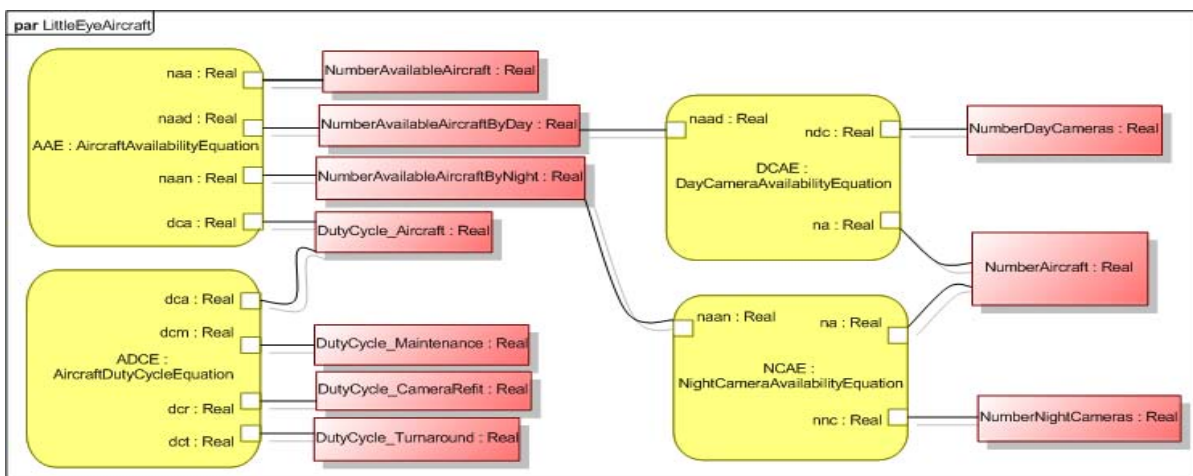

Figure D.51 - Aircraft System Parametric

D.12.6 Instance Diagram

To perform the trade-off analysis calculations an instance diagram of the system components is created as shown in Figure D.52. Initial values are created for some of the value properties as a means of defining set values against which the equation solver can work.

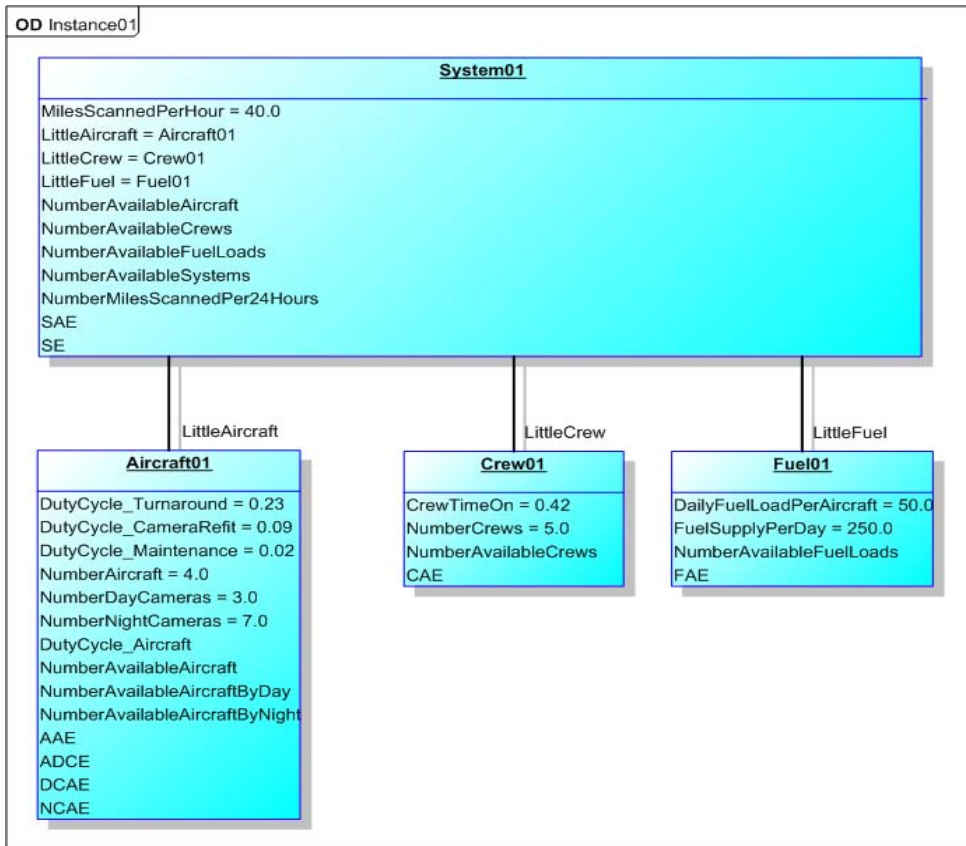

Figure D.52 - System Instance Diagram

Annex E - Bibliography

MOD Architectural Framework, Version 1.2, 23 June 2008, Office of Public Sector Information, <http://www.modaf.org.uk/>

DoD Dictionary of Military Terms, <http://www.dtic.mil/doctrine/jel/doddict/index.html>

Joint Doctrine Joint Force Employment Briefing, <http://www.dtic.mil/doctrine/jrm/plans.pdf>

Joint Forces Staff College, Joint Planning and Operations Course, http://www.jfsc.ndu.edu/schools_programs/jpoc/course_materials/default.asp

Doctrine for Joint Operations, http://www.dtic.mil/doctrine/jel/new_pubs/jp3_0.pdf

Joint Doctrine for countering air and missile threats, [http://www.dtic.mil/doctrine/jel/new_pubs/jp3_01 .pdf](http://www.dtic.mil/doctrine/jel/new_pubs/jp3_01.pdf) Joint Communications System, http://www.dtic.mil/doctrine/jel/new_pubs/jp6_0.pdf

Federal Information Processing Standards Publication (FIPS PUB) 183 -- INTEGRATION DEFINITION FOR FUNCTION MODELING (IDEF0), issued by the National Institute of Standards and Technology after approval by the Secretary of Commerce pursuant to Section 111(d) of the Federal Property and Administrative Services Act of 1949 as amended by the Computer Security Act of 1987, Public Law 100-235.

