



Unified Profile for DoDAF and MODAF (UPDM)

Version 2.0.1

OMG Document Number: formal/2013-01-01

Standard document URL: <http://www.omg.org/spec/UPDM/2.0.1>

Associated Schema File(s):

<http://www.omg.org/spec/UPDM/20120301/UPDM-Profile.xmi>

Original schema file: dtc/2012-09-10

Copyright © 2003-2011, Adaptive

Copyright © 2003-2011, Advanced Systems Management Group Ltd

Copyright © 2003-2011, Atego (formerly Artisan Software Tools, Ltd.)

Copyright © 2003-2011, International Business Machines

Copyright © 2003-2011, Mega International

Copyright © 2003-2011, No Magic

Copyright © 2003-2012, Object Management Group, Inc.

Copyright © 2003-2011, Sparx Systems Pty Ltd

Copyright © 2003-2011, Visumpoint

USE OF SPECIFICATION - TERMS, CONDITIONS & NOTICES

The material in this document details an Object Management Group specification in accordance with the terms, conditions and notices set forth below. This document does not represent a commitment to implement any portion of this specification in any company's products. The information contained in this document is subject to change without notice.

LICENSES

The companies listed above have granted to the Object Management Group, Inc. (OMG) a nonexclusive, royalty-free, paid up, worldwide license to copy and distribute this document and to modify this document and distribute copies of the modified version. Each of the copyright holders listed above has agreed that no person shall be deemed to have infringed the copyright in the included material of any such copyright holder by reason of having used the specification set forth herein or having conformed any computer software to the specification.

Subject to all of the terms and conditions below, the owners of the copyright in this specification hereby grant you a fully- paid up, non-exclusive, nontransferable, perpetual, worldwide license (without the right to sublicense), to use this specification to create and distribute software and special purpose specifications that are based upon this specification, and to use, copy, and distribute this specification as provided under the Copyright Act; provided that: (1) both the copyright notice identified above and this permission notice appear on any copies of this specification; (2) the use of the specifications is for informational purposes and will not be copied or posted on any network computer or broadcast in any media and will not be otherwise resold or transferred for commercial purposes; and (3) no modifications are made to this specification. This limited permission automatically terminates without notice if you breach any of these terms or conditions. Upon termination, you will destroy immediately any copies of the specifications in your possession or control.

PATENTS

The attention of adopters is directed to the possibility that compliance with or adoption of OMG specifications may require use of an invention covered by patent rights. OMG shall not be responsible for identifying patents for which a license may be required by any OMG specification, or for conducting legal inquiries into the legal validity or scope of those patents that are brought to its attention. OMG specifications are prospective and advisory only. Prospective users are responsible for protecting themselves against liability for infringement of patents.

GENERAL USE RESTRICTIONS

Any unauthorized use of this specification may violate copyright laws, trademark laws, and communications regulations and statutes. This document contains information which is protected by copyright. All Rights Reserved. No part of this work covered by copyright herein may be reproduced or used in any form or by any means--graphic, electronic, or mechanical, including photocopying, recording, taping, or information storage and retrieval systems--without permission of the copyright owner.

DISCLAIMER OF WARRANTY

WHILE THIS PUBLICATION IS BELIEVED TO BE ACCURATE, IT IS PROVIDED "AS IS" AND MAY CONTAIN ERRORS OR MISPRINTS. THE OBJECT MANAGEMENT GROUP AND THE COMPANIES LISTED ABOVE MAKE NO WARRANTY OF ANY KIND, EXPRESS OR IMPLIED, WITH REGARD TO THIS PUBLICATION, INCLUDING BUT NOT LIMITED TO ANY WARRANTY OF TITLE OR OWNERSHIP, IMPLIED WARRANTY OF MERCHANTABILITY OR WARRANTY OF FITNESS FOR A PARTICULAR PURPOSE OR USE.

IN NO EVENT SHALL THE OBJECT MANAGEMENT GROUP OR ANY OF THE COMPANIES LISTED ABOVE BE LIABLE FOR ERRORS CONTAINED HEREIN OR FOR DIRECT, INDIRECT, INCIDENTAL, SPECIAL, CONSEQUENTIAL, RELIANCE OR COVER DAMAGES, INCLUDING LOSS OF PROFITS, REVENUE, DATA OR USE, INCURRED BY ANY USER OR ANY THIRD PARTY IN CONNECTION WITH THE FURNISHING, PERFORMANCE, OR USE OF THIS MATERIAL, EVEN IF ADVISED OF THE POSSIBILITY OF SUCH DAMAGES.

The entire risk as to the quality and performance of software developed using this specification is borne by you. This disclaimer of warranty constitutes an essential part of the license granted to you to use this specification.

RESTRICTED RIGHTS LEGEND

Use, duplication or disclosure by the U.S. Government is subject to the restrictions set forth in subparagraph (c) (1) (ii) of The Rights in Technical Data and Computer Software Clause at DFARS 252.227-7013 or in subparagraph (c)(1) and (2) of the Commercial Computer Software - Restricted Rights clauses at 48 C.F.R. 52.227-19 or as specified in 48 C.F.R. 227- 7202-2 of the DoD F.A.R. Supplement and its successors, or as specified in 48 C.F.R. 12.212 of the Federal Acquisition Regulations and its successors, as applicable. The specification copyright owners are as indicated above and may be contacted through the Object Management Group, 109 Highland Avenue, Needham, MA 02494, U.S.A.

TRADEMARKS

MDA®, Model Driven Architecture®, UML®, UML Cube logo®, OMG Logo®, CORBA® and XMI® are registered trademarks of the Object Management Group, Inc., and Object Management Group™, OMG™, Unified Modeling Language™, Model Driven Architecture Logo™, Model Driven Architecture Diagram™, CORBA logos™, XMI Logo™, CWMTM, CWM Logo™, IIOPTM, IMMTM, MOFTM, OMG Interface Definition Language (IDL)™, and OMG SysML™ are trademarks of the Object Management Group. All other products or company names mentioned are used for identification purposes only, and may be trademarks of their respective owners.

COMPLIANCE

The copyright holders listed above acknowledge that the Object Management Group (acting itself or through its designees) is and shall at all times be the sole entity that may authorize developers, suppliers and sellers of computer software to use certification marks, trademarks or other special designations to indicate compliance with these materials.

Software developed under the terms of this license may claim compliance or conformance with this specification if and only if the software compliance is of a nature fully matching the applicable compliance points as stated in the specification. Software developed only partially matching the applicable compliance points may claim only that the software was based on this specification, but may not claim compliance or conformance with this specification. In the event that testing suites are implemented or approved by Object Management Group, Inc., software

developed using this specification may claim compliance or conformance with the specification only if the software satisfactorily completes the testing suites.

OMG's Issue Reporting Procedure

All OMG specifications are subject to continuous review and improvement. As part of this process we encourage readers to report any ambiguities, inconsistencies, or inaccuracies they may find by completing the Issue Reporting Form listed on the main web page <http://www.omg.org>, under Documents, Report a Bug/Issue (http://www.omg.org/report_issue.htm).

Table of Contents

1	SCOPE	2
1.1	GENERAL	2
1.2	SCOPE	2
2	COMPLIANCE	4
2.1	COMPLIANCE LEVELS.....	4
2.1.1	<i>Level 0 : Based on UML 2 and Partial SoaML Import</i>	<i>5</i>
2.1.2	<i>Level 1 : Based on UML 2 and Full SysML Import</i>	<i>5</i>
3	NORMATIVE REFERENCES.....	7
3.1	OMG DOCUMENTS	7
3.2	OTHER DOCUMENTS	7
3.2.1	<i>Department of Defense Documents.....</i>	<i>7</i>
4	TERMS AND DEFINITIONS.....	9
5	SYMBOLS AND ACRONYMS	10
6	ADDITIONAL INFORMATION.....	11
6.1	ADDITIONAL MATERIALS	11
6.1.1	<i>Statement of support from the DoD representative 19 May 2011.....</i>	<i>11</i>
6.1.2	<i>Statement of contribution from the MOD representative received 17th May, 2011.....</i>	<i>13</i>
6.1.3	<i>Statement of support from the Swedish Armed Forces representative received 16th May 2011</i>	<i>13</i>
6.2	OVERVIEW OF THIS SPECIFICATION	13
6.2.1	<i>Intended Audience</i>	<i>13</i>
6.2.2	<i>Organization of this Specification.....</i>	<i>13</i>
6.3	ACKNOWLEDGEMENTS	14
7	LANGUAGE ARCHITECTURE.....	17
7.1	INTRODUCTION.....	17
7.2	PHILOSOPHY.....	17
7.3	CORE PRINCIPLES.....	17
7.4	PROFILE STRUCTURE	18
7.4.1	<i>Top Level.....</i>	<i>18</i>
7.4.2	<i>Middle Level</i>	<i>19</i>
7.4.3	<i>Low Level.....</i>	<i>20</i>
7.5	REPRESENTING STEREOTYPE CONSTRAINTS	20
7.6	UML CONSTRAINT REPRESENTATION.....	22
7.7	IMPORTANT AREAS OF THE ARCHITECTURE.....	23
7.7.1	<i>Aliases.....</i>	<i>23</i>
7.7.2	<i>DoDAF 2.02 Conformance</i>	<i>23</i>
7.7.3	<i>SoaML Reuse in L0</i>	<i>24</i>
7.7.4	<i>SysML Reuse in L1</i>	<i>24</i>
7.7.5	<i>SOPEs Reuse in L1</i>	<i>24</i>
8.	PART II – UPDM PROFILE.....	26
8.1	DoDAF CLASS LIBRARY.....	26
8.1.1	<i>ClassificationType</i>	<i>26</i>
8.1.2	<i>CommunicationsLinkProperties</i>	<i>27</i>

8.1.3	<i>DataElementProperties</i>	27
8.1.4	<i>ExchangeProperties</i>	27
8.1.5	<i>InformationAssuranceProperties</i>	27
8.1.6	<i>InformationElementProperties</i>	27
8.1.7	<i>OperationalActivityProperties</i>	28
8.1.8	<i>SecurityAttributes</i>	28
8.2	UPDM L1	28
8.2.1	UPDM L1::UPDM L0	32
8.2.1.1	UPDM L1::UPDM L0::Core.....	32
8.2.1.1.1	UPDM L1::UPDM L0::Core::AcquisitionElements.....	32
8.2.1.1.1.1	UPDM L1::UPDM L0::Core::AcquisitionElements::Milestone.....	32
8.2.1.1.1.1.1	ActualProject	32
8.2.1.1.1.1.2	ActualProjectMilestoneRole	33
8.2.1.1.1.1.3	OrganizationalProjectRelationship	34
8.2.1.1.1.1.4	ProjectMilestoneRole.....	35
8.2.1.1.1.1.5	ProjectType.....	35
8.2.1.1.2	UPDM L1::UPDM L0::Core::AllElements	36
8.2.1.1.2.1	Exchange.....	36
8.2.1.1.2.2	UPDMElement	37
8.2.1.1.2.3	UPDM L1::UPDM L0::Core::AllElements::Behavior	38
8.2.1.1.2.3.1	Activity	38
8.2.1.1.2.3.2	CapableElement	39
8.2.1.1.2.3.3	Implements	39
8.2.1.1.2.3.4	IsCapableOfPerforming	40
8.2.1.1.2.4	UPDM L1::UPDM L0::Core::AllElements::Environment	41
8.2.1.1.2.4.1	ActualLocation	41
8.2.1.1.2.4.2	ConditionType	42
8.2.1.1.2.4.3	Environment	43
8.2.1.1.2.4.4	EnvironmentProperty	44
8.2.1.1.2.4.5	LocationHolder	44
8.2.1.1.2.4.6	LocationKind	45
8.2.1.1.2.4.7	LocationType	46
8.2.1.1.2.4.8	LocationTypeKind	47
8.2.1.1.2.5	UPDM L1::UPDM L0::Core::AllElements::Measurements.....	47
8.2.1.1.2.5.1	ActualMeasurement	47
8.2.1.1.2.5.2	ActualProperty	48
8.2.1.1.2.5.3	ActualPropertySet	49
8.2.1.1.2.5.4	ActualPropertySetKind	50
8.2.1.1.2.5.5	Measurement.....	50
8.2.1.1.2.5.6	MeasurementSet.....	51
8.2.1.1.2.5.7	Property	52
8.2.1.1.2.5.8	PropertySet	53
8.2.1.1.2.6	UPDM L1::UPDM L0::Core::AllElements::Structure	53
8.2.1.1.2.6.1	ExchangeElement	53
8.2.1.1.2.6.2	ExchangeElementKind	54
8.2.1.1.2.6.3	Participant.....	55
8.2.1.1.2.6.4	Resource	56
8.2.1.1.2.6.5	Rule.....	56
8.2.1.1.2.6.6	RuleKind.....	57
8.2.1.1.2.7	UPDM L1::UPDM L0::Core::AllElements::Views.....	58
8.2.1.1.2.7.1	ArchitecturalDescription.....	58
8.2.1.1.2.7.2	ArchitecturalReference	59
8.2.1.1.2.7.3	ArchitectureFrameworkKind	60
8.2.1.1.2.7.4	ArchitectureMetadata.....	60
8.2.1.1.2.7.5	Metadata	61
8.2.1.1.2.7.6	View.....	62
8.2.1.1.2.7.7	Viewpoint	63
8.2.1.1.3	UPDM L1::UPDM L0::Core::ExternalTypes	64
8.2.1.1.3.1	ISO8601DateTime	64
8.2.1.1.4	UPDM L1::UPDM L0::Core::OperationalElements.....	64
8.2.1.1.4.1	UPDM L1::UPDM L0::Core::OperationalElements::Behavior.....	64

8.2.1.1.4.1.1	NodeOperation.....	64
8.2.1.1.4.1.2	OperationalActivity	65
8.2.1.1.4.1.3	OperationalActivityAction.....	67
8.2.1.1.4.1.4	OperationalActivityEdge	67
8.2.1.1.4.1.5	OperationalEventTrace	68
8.2.1.1.4.1.6	OperationalMessage.....	69
8.2.1.1.4.1.7	OperationalParameter	70
8.2.1.1.4.1.8	OperationalState.....	71
8.2.1.1.4.1.9	OperationalStateDescription	72
8.2.1.1.4.1.10	SubjectOfOperationalStateMachine.....	72
8.2.1.1.4.2	UPDM L1::UPDM L0::Core::OperationalElements::Data.....	73
8.2.1.1.4.2.1	LogicalDataModel	73
8.2.1.1.4.3	UPDM L1::UPDM L0::Core::OperationalElements::Flows	74
8.2.1.1.4.3.1	Command.....	74
8.2.1.1.4.3.2	OperationalExchange.....	75
8.2.1.1.4.3.3	OperationalExchangeItem.....	76
8.2.1.1.4.3.4	OperationalExchangeKind.....	77
8.2.1.1.4.4	UPDM L1::UPDM L0::Core::OperationalElements::Structure.....	78
8.2.1.1.4.4.1	ArbitraryConnector	78
8.2.1.1.4.4.2	Competence	79
8.2.1.1.4.4.3	ConceptItem.....	79
8.2.1.1.4.4.4	ConceptRole	80
8.2.1.1.4.4.5	HighLevelOperationalConcept	81
8.2.1.1.4.4.6	KnownResource.....	81
8.2.1.1.4.4.7	LogicalArchitecture	82
8.2.1.1.4.4.8	Mission	83
8.2.1.1.4.4.9	Needline.....	83
8.2.1.1.4.4.10	Node.....	84
8.2.1.1.4.4.11	NodeParent	86
8.2.1.1.4.4.12	NodePort.....	86
8.2.1.1.4.4.13	NodeRole	87
8.2.1.1.4.4.14	OperationalConstraint.....	88
8.2.1.1.4.4.15	SecurityDomain	89
8.2.1.1.4.4.16	SubjectOfOperationalConstraint.....	90
8.2.1.1.4.4.17	UPDM L1::UPDM L0::Core::OperationalElements::Structure::Organizational.....	90
8.2.1.1.4.4.17.1	UPDM L1::UPDM L0::Core::OperationalElements::Structure::Organizational::Actual....	91
8.2.1.1.4.4.17.1.1	ActualOrganization	91
8.2.1.1.4.4.17.1.2	ActualOrganizationalResource.....	92
8.2.1.1.4.4.17.1.3	ActualOrganizationRelationship	93
8.2.1.1.4.4.17.1.4	ActualOrganizationRole.....	93
8.2.1.1.4.4.17.1.5	ActualPerson	94
8.2.1.1.4.4.17.1.6	ActualPost	95
8.2.1.1.4.4.17.1.7	CompetenceProvider	96
8.2.1.1.4.4.17.1.8	FillsPost.....	97
8.2.1.1.4.4.17.2	UPDM L1::UPDM L0::Core::OperationalElements::Structure::Organizational::Typical ..	98
8.2.1.1.4.4.17.2.1	CompetenceRequirer.....	98
8.2.1.1.4.4.17.2.2	Organization.....	98
8.2.1.1.4.4.17.2.3	OrganizationalResource	99
8.2.1.1.4.4.17.2.4	Person.....	100
8.2.1.1.4.4.17.2.5	Post.....	101
8.2.1.1.4.4.17.2.6	ProvidesCompetence.....	101
8.2.1.1.4.4.17.2.7	RequiresCompetence.....	102
8.2.1.1.4.4.17.2.8	Responsibility.....	103
8.2.1.1.5	UPDM L1::UPDM L0::Core::ServiceElements	104
8.2.1.1.5.1	UPDM L1::UPDM L0::Core::ServiceElements::Behavior	104
8.2.1.1.5.1.1	ServiceFeature	104
8.2.1.1.5.1.2	ServiceFunction	105
8.2.1.1.5.1.3	ServiceFunctionAction	106
8.2.1.1.5.1.4	ServiceFunctionEdge	107
8.2.1.1.5.1.5	ServiceInteraction	108
8.2.1.1.5.1.6	ServiceMessage	109
8.2.1.1.5.1.7	ServiceMessageHandler.....	110

8.2.1.1.5.1.8	ServiceOperation	110
8.2.1.1.5.1.9	ServiceParameter	111
8.2.1.1.5.1.10	ServiceStateMachine.....	112
8.2.1.1.5.2	UPDM L1::UPDM L0::Core::ServiceElements::Structure	113
8.2.1.1.5.2.1	AsynchronousMessage	113
8.2.1.1.5.2.2	Request	113
8.2.1.1.5.2.3	Service	114
8.2.1.1.5.2.4	ServiceAttribute	115
8.2.1.1.5.2.5	ServiceInterface	115
8.2.1.1.5.2.6	ServiceLevelValue.....	117
8.2.1.1.5.2.7	ServiceLevelValueSet.....	117
8.2.1.1.5.2.8	ServicePolicy	118
8.2.1.1.5.2.9	ServicePort.....	119
8.2.1.1.6	UPDM L1::UPDM L0::Core::StrategicElements	120
8.2.1.1.6.1	UPDM L1::UPDM L0::Core::StrategicElements::Structure	121
8.2.1.1.6.1.1	Capability.....	121
8.2.1.1.6.1.2	CapabilityProperty	122
8.2.1.1.6.1.3	DesiredState	122
8.2.1.1.6.1.4	Desirer	123
8.2.1.1.6.1.5	EnterpriseGoal	123
8.2.1.1.6.1.6	EnterprisePhase.....	124
8.2.1.1.6.1.7	EnterpriseVision	126
8.2.1.1.6.1.8	Exhibits.....	126
8.2.1.1.6.1.9	MapsToCapability	127
8.2.1.1.6.1.10	StructuralPart	128
8.2.1.1.6.1.11	TemporalPart	129
8.2.1.1.6.1.12	VisionStatement.....	130
8.2.1.1.7	UPDM L1::UPDM L0::Core::SystemsElements	131
8.2.1.1.7.1	UPDM L1::UPDM L0::Core::SystemsElements::Behavior	131
8.2.1.1.7.1.1	Function	131
8.2.1.1.7.1.2	FunctionAction	132
8.2.1.1.7.1.3	FunctionEdge.....	133
8.2.1.1.7.1.4	ResourceEventTrace	134
8.2.1.1.7.1.5	ResourceMessage.....	134
8.2.1.1.7.1.6	ResourceOperation.....	135
8.2.1.1.7.1.7	ResourceParameter	136
8.2.1.1.7.1.8	ResourceState	137
8.2.1.1.7.1.9	ResourceStateMachine.....	138
8.2.1.1.7.2	UPDM L1::UPDM L0::Core::SystemsElements::Data	138
8.2.1.1.7.2.1	DataModel	138
8.2.1.1.7.2.2	PhysicalDataModel.....	139
8.2.1.1.7.3	UPDM L1::UPDM L0::Core::SystemsElements::Flows	140
8.2.1.1.7.3.1	ResourceInteraction	140
8.2.1.1.7.3.2	ResourceInteractionItem	141
8.2.1.1.7.4	UPDM L1::UPDM L0::Core::SystemsElements::Structure	142
8.2.1.1.7.4.1	CapabilityConfiguration	142
8.2.1.1.7.4.2	FieldedCapability.....	143
8.2.1.1.7.4.3	Forecast.....	143
8.2.1.1.7.4.4	Materiel.....	144
8.2.1.1.7.4.5	MODAFRoleKind	145
8.2.1.1.7.4.6	PhysicalArchitecture	146
8.2.1.1.7.4.7	PhysicalResource	146
8.2.1.1.7.4.8	ResourceArtifact	147
8.2.1.1.7.4.9	ResourceConnector	148
8.2.1.1.7.4.10	ResourceConstraint.....	149
8.2.1.1.7.4.11	ResourceInterface	149
8.2.1.1.7.4.12	ResourcePort.....	150
8.2.1.1.7.4.13	ResourceRole.....	151
8.2.1.1.7.4.14	Software.....	153
8.2.1.1.7.4.15	SubjectOfForecast.....	153
8.2.1.1.7.4.16	SubjectOfResourceConstraint.....	154
8.2.1.1.7.4.17	SystemResource	154

8.2.1.1.7.4.18	VersionOfConfiguration	156
8.2.1.1.7.4.19	WholeLifeConfiguration	156
8.2.1.1.8	UPDM L1::UPDM L0::Core::TechnicalStandardsElements	157
8.2.1.1.8.1	Protocol	157
8.2.1.1.8.2	ProtocolImplementation	158
8.2.1.1.8.3	Standard	158
8.2.1.1.8.4	StandardConfiguration	160
8.2.1.1.8.5	UPDM L1::UPDM L0::Core::TechnicalStandardsElements::Data	160
8.2.1.1.8.5.1	Details	160
8.2.1.1.8.5.2	EntityAttribute	161
8.2.1.1.8.5.3	EntityItem	162
8.2.1.1.8.5.4	EntityRelationship	162
8.2.1.2	UPDM L1::UPDM L0::DoDAF	163
8.2.1.2.1	UPDM L1::UPDM L0::DoDAF::AcquisitionElements	163
8.2.1.2.1.1	ActivityPartOfProject	163
8.2.1.2.1.2	Project	164
8.2.1.2.1.3	ProjectActivity	165
8.2.1.2.2	UPDM L1::UPDM L0::DoDAF::AllElements	165
8.2.1.2.2.1	Information	165
8.2.1.2.2.2	InformationKind	166
8.2.1.2.2.3	UPDM L1::UPDM L0::DoDAF::AllElements::Behavior	167
8.2.1.2.2.3.1	ActivityPerformedByPerformer	167
8.2.1.2.2.4	UPDM L1::UPDM L0::DoDAF::AllElements::Environment	167
8.2.1.2.2.4.1	Condition	167
8.2.1.2.2.4.2	ConditionProperty	168
8.2.1.2.2.4.3	GeoPoliticalExtent	169
8.2.1.2.2.4.4	GeoPoliticalExtentKind	170
8.2.1.2.2.4.5	GeoPoliticalExtentType	170
8.2.1.2.2.4.6	GeoPoliticalExtentTypeKind	171
8.2.1.2.2.4.7	Location	172
8.2.1.2.2.5	UPDM L1::UPDM L0::DoDAF::AllElements::Measurements	172
8.2.1.2.2.5.1	Measure	172
8.2.1.2.2.5.2	MeasureType	173
8.2.1.2.3	UPDM L1::UPDM L0::DoDAF::OperationalElements	173
8.2.1.2.3.1	UPDM L1::UPDM L0::DoDAF::OperationalElements::Structure	173
8.2.1.2.3.1.1	Performer	174
8.2.1.2.3.1.2	UPDM L1::UPDM L0::DoDAF::OperationalElements::Structure::Organizational	174
8.2.1.2.3.1.2.1	IndividualPersonRole	174
8.2.1.2.3.1.2.2	OrganizationType	175
8.2.1.2.3.1.2.3	PersonType	175
8.2.1.2.3.1.2.4	Skill	176
8.2.1.2.3.1.2.5	SkillOfPersonType	176
8.2.1.2.3.1.2.5	SkillOfPersonType	176
8.2.1.2.4	UPDM L1::UPDM L0::DoDAF::ServiceElements	177
8.2.1.2.4.1	ServiceAccess	177
8.2.1.2.4.2	ServiceDescription	177
8.2.1.2.5	UPDM L1::UPDM L0::DoDAF::StrategicElements	178
8.2.1.2.5.1	ActivityPartOfCapability	178
8.2.1.2.5.2	CapabilityOfPerformer	178
8.2.1.2.5.3	DesiredEffect	179
8.2.1.2.5.4	Vision	180
8.2.1.2.6	UPDM L1::UPDM L0::DoDAF::SystemElements	180
8.2.1.2.6.1	UPDM L1::UPDM L0::DoDAF::SystemElements::Structure	180
8.2.1.2.6.1.1	System	180
8.2.1.2.7	UPDM L1::UPDM L0::DoDAF::TechnicalStandardsElements	181
8.2.1.2.7.1	FunctionalStandard	181
8.2.1.2.7.2	TechnicalStandard	181
8.2.1.2.7.3	UPDM L1::UPDM L0::DoDAF::TechnicalStandardsElements::Data	182
8.2.1.2.7.3.1	AssociationOfInformation	182
8.2.1.2.7.3.2	SecurityAttributesGroup	182
8.2.1.3	UPDM L1::UPDM L0::MODAF	183
8.2.1.3.1	UPDM L1::UPDM L0::MODAF::AcquisitionElements	183
8.2.1.3.1.1	UPDM L1::UPDM L0::MODAF::AcquisitionElements::Milestones	183

8.2.1.3.1.1.1	ActualProjectMilestone.....	183
8.2.1.3.1.1.2	IncrementMilestone	184
8.2.1.3.1.1.3	MilestoneSequence	185
8.2.1.3.1.1.4	OutOfServiceMilestone	185
8.2.1.3.1.1.5	ProjectMilestone	186
8.2.1.3.1.1.6	ProjectOwnership.....	187
8.2.1.3.1.1.7	ProjectSequence.....	187
8.2.1.3.1.2	UPDM L1::UPDM L0::MODAF::AcquisitionElements::Structure	188
8.2.1.3.1.2.1	ProjectStatus	188
8.2.1.3.1.2.2	ProjectTheme	189
8.2.1.3.1.2.3	StatusIndicators.....	190
8.2.1.3.2	UPDM L1::UPDM L0::MODAF::AllElements.....	190
8.2.1.3.2.1	UPDM L1::UPDM L0::MODAF::AllElements::Environment	190
8.2.1.3.2.1.1	Climate.....	190
8.2.1.3.2.1.2	LightCondition.....	191
8.2.1.3.2.2	UPDM L1::UPDM L0::MODAF::AllElements::Ontology	191
8.2.1.3.2.2.1	Alias.....	191
8.2.1.3.2.2.2	Definition.....	192
8.2.1.3.2.2.3	ExternalIndividual	193
8.2.1.3.2.2.4	ExternalTuple	194
8.2.1.3.2.2.5	ExternalTupleType	194
8.2.1.3.2.2.6	ExternalType.....	194
8.2.1.3.2.2.7	OntologyReference	195
8.2.1.3.2.2.8	Overlap	196
8.2.1.3.2.2.9	SameAs.....	196
8.2.1.3.2.2.10	StereotypeExtension	197
8.2.1.3.3	UPDM L1::UPDM L0::MODAF::OperationalElements	198
8.2.1.3.3.1	UPDM L1::UPDM L0::MODAF::OperationalElements::Behavior	198
8.2.1.3.3.1.1	ActivitySubject	198
8.2.1.3.3.1.2	OwnsProcess.....	198
8.2.1.3.3.1.3	Process	199
8.2.1.3.3.1.4	StandardOperationalActivity	200
8.2.1.3.3.2	UPDM L1::UPDM L0::MODAF::OperationalElements::Flows	201
8.2.1.3.3.2.1	Control.....	201
8.2.1.3.3.3	UPDM L1::UPDM L0::MODAF::OperationalElements::Structure	202
8.2.1.3.3.3.1	Energy.....	202
8.2.1.3.3.3.2	ProblemDomain	202
8.2.1.3.3.3.3	Trustline.....	203
8.2.1.3.3.3.4	UPDM L1::UPDM L0::MODAF::OperationalElements::Structure::Organizational	204
8.2.1.3.3.3.4.1	RoleType	204
8.2.1.3.4	UPDM L1::UPDM L0::MODAF::StrategicElements.....	205
8.2.1.3.4.1	UPDM L1::UPDM L0::MODAF::StrategicElements::Milestones.....	205
8.2.1.3.4.1.1	DeployedMilestone	205
8.2.1.3.4.1.2	NoLongerUsedMilestone.....	205
8.2.1.3.4.2	UPDM L1::UPDM L0::MODAF::StrategicElements::Structure.....	206
8.2.1.3.4.2.1	EnduringTask.....	206
8.2.1.3.4.2.2	WholeLifeEnterprise.....	207
8.2.1.3.5	UPDM L1::UPDM L0::MODAF::TechnicalStandardsElements.....	207
8.2.1.3.5.1	ProtocolLayer.....	208
8.2.1.4	UPDM L1::UPDM L0::SOPES	208
8.2.1.4.1	Contract	209
8.2.1.4.2	Semantic	209
8.2.1.4.3	SemanticAttribute.....	210
8.2.1.4.4	Transactional	210
8.2.1.4.5	TransactionalAttribute	211
8.2.1.4.6	Wrapper.....	211
8.2.1.4.7	WrapperAttribute.....	211
8.2.1.5	UPDM L1::UPDM L0::SwAF	212
8.2.1.5.1	DesignRule	212
8.2.1.5.2	DevelopmentStatus.....	213

ANNEX A DOMAIN METAMODEL (DMM)214

A.1	PRODUCTS.....	214
A.1.1	AcV/PV.....	214
A.1.1.1	AcV-1/PV-1 - DMM.....	214
A.1.1.2	AcV-2/PV-2 - DMM.....	215
A.1.1.3	PV-3 - DMM.....	215
A.1.2	AV.....	216
A.1.2.1	AV-1 - DMM.....	216
A.1.2.2	AV-2 - DMM.....	217
A.1.3	OV.....	218
A.1.3.1	OV-1 - DMM.....	218
A.1.3.2	OV-2 - DMM.....	219
A.1.3.3	OV-3 - DMM.....	220
A.1.3.4	OV-4 Actual - DMM.....	221
A.1.3.5	OV-4 Typical - DMM.....	222
A.1.3.6	OV-5 - DMM.....	223
A.1.3.7	OV-6a - DMM.....	224
A.1.3.8	OV-6b - DMM.....	224
A.1.3.9	OV-6c - DMM.....	225
A.1.3.10	OV-7/DIV-1/DIV-2/ - DMM.....	225
A.1.4	SOV.....	226
A.1.4.1	SOV-1 - DMM.....	226
A.1.4.2	SOV-2 - DMM.....	227
A.1.4.3	SOV-3 - DMM.....	228
A.1.4.4	SOV-4a - DMM.....	228
A.1.4.5	SOV-4b - DMM.....	228
A.1.4.6	SOV-4c - DMM.....	229
A.1.4.7	SOV-5 - DMM.....	229
A.1.5	StV/CV.....	230
A.1.5.1	CV-7 - DMM.....	230
A.1.5.2	StV-1/CV-1 - DMM.....	231
A.1.5.3	StV-2/CV-2 - DMM.....	232
A.1.5.4	StV-3/CV-3 - DMM.....	233
A.1.5.5	StV-4/CV-4 - DMM.....	233
A.1.5.6	StV-5/CV-5 - DMM.....	234
A.1.5.7	StV-6/CV-6 - DMM.....	235
A.1.6	SV/SvcV.....	236
A.1.6.1	SV-1/SvcV-1 - DMM.....	236
A.1.6.2	SV-10a/SvcV-10a - DMM.....	237
A.1.6.3	SV-10b/SvcV-10b DMM.....	238
A.1.6.4	SV-10c/SvcV-10c - DMM.....	239
A.1.6.5	SV-11/DIV-3 - DMM.....	239
A.1.6.6	SV-12 - DMM.....	240
A.1.6.7	SV-2/SvcV-2 - DMM.....	240
A.1.6.8	SV-3/SvcV-3a/SvcV-3b - DMM.....	241
A.1.6.9	SV-4/SvcV-4 - DMM.....	242
A.1.6.10	SV-5/SvcV-5 - DMM.....	243
A.1.6.11	SV-6/SvcV-6 - DMM.....	243
A.1.6.12	SV-7/SvcV-7 - DMM.....	244
A.1.6.13	SV-8/SvcV-8 - DMM.....	245
A.1.6.14	SV-9/SvcV-9 - DMM.....	246
A.1.7	TV/StdV.....	247
A.1.7.1	TV-1&2&3/StdV-1&2 - DMM.....	248
A.2	SOPES.....	248
A.2.1	SOPES - DMM.....	248
A.3	SWAF.....	249
A.3.1	Design Rule - DMM.....	249

A.4	DM2.....	249
A.4.1	Activity - DM2.....	250
A.4.2	Capability - DM2.....	250
A.4.3	Goals - DM2.....	251
A.4.4	Information and Data - DM2.....	252
A.4.5	Information Pedigree - DM2.....	253
A.4.6	Location - DM2.....	253
A.4.7	Measure - DM2.....	254
A.4.8	Organizational Structure - DM2.....	255
A.4.9	Performer - DM2.....	256
A.4.10	Project - DM2.....	256
A.4.11	Resource Flow - DM2.....	257
A.4.12	Rules - DM2.....	258
A.4.13	Services - DM2.....	259
ANNEX B	UPDM VIEWS (PROFILE).....	260
B.1	PRODUCTS.....	260
B.1.1	AcV/PV.....	260
B.1.1.1	AcV-1/PV-1.....	260
B.1.1.2	AcV-2/PV-2.....	260
B.1.1.3	PV-3.....	261
B.1.2	AV.....	261
B.1.2.1	AV-1.....	262
B.1.2.2	AV-2.....	263
B.1.2.3	Environment Elements.....	264
B.1.2.4	Measurements.....	265
B.1.3	OV.....	266
B.1.3.1	OV-1.....	266
B.1.3.2	OV-2.....	267
B.1.3.3	OV-3.....	268
B.1.3.4	OV-4 Actual.....	269
B.1.3.5	OV-4 Typical.....	270
B.1.3.6	OV-5.....	271
B.1.3.7	OV-6a.....	272
B.1.3.8	OV-6b.....	273
B.1.3.9	OV-6c.....	274
B.1.3.10	OV-7/DIV-1/DIV-2.....	274
B.1.4	SOV.....	275
B.1.4.1	SOV-1.....	275
B.1.4.2	SOV-2.....	276
B.1.4.3	SOV-3.....	277
B.1.4.4	SOV-4a.....	277
B.1.4.5	SOV-4b.....	278
B.1.4.6	SOV-4c.....	278
B.1.4.7	SOV-5.....	279
B.1.5	StV/CV.....	279
B.1.5.1	CV-7.....	280
B.1.5.2	StV-1/CV-1.....	280
B.1.5.3	StV-2/CV-2.....	281
B.1.5.4	StV-3/CV-3.....	282
B.1.5.5	StV-4/CV-4.....	283
B.1.5.6	StV-5/CV-5.....	283
B.1.5.7	StV-6/CV-6.....	284
B.1.6	SV/SvcV.....	285
B.1.6.1	SV-1/SvcV-1.....	285

B.1.6.2	SV-10a/SvcV-10a	286
B.1.6.3	SV-10b/SvcV-10b	287
B.1.6.4	SV-10c/SvcV-10c	287
B.1.6.5	SV-11/DIV-3	288
B.1.6.6	SV-12	289
B.1.6.7	SV-2/SvcV-2	289
B.1.6.8	SV-3/SvcV-3a/SvcV-3b	290
B.1.6.9	SV-4/SvcV-4	290
B.1.6.10	SV-5/SvcV-5	291
B.1.6.11	SV-6/SvcV-6	292
B.1.6.12	SV-7/SvcV-7	293
B.1.6.13	SV-8/SvcV-8	294
B.1.6.14	SV-9/SvcV-9	295
B.1.7	TV/StdV	295
B.1.7.1	TV-1&2&3/StdV-1&2	295
ANNEX C	UPDM ELEMENTS TRACEABILITY	297
C.1	DoDAF-DM2, UPDM, AND MODAF MAPPING	297
C.2	UPDM TO NAF ELEMENTS TRACEABILITY	306
C.2.1	Element additions in NAF 3.1 compared to MODAF 1.2.003	310
C.2.2	DoDAF 2.0 to MODAF 1.2 Views Traceability	310
ANNEX D	SAMPLE PROBLEM	315
D.1	PURPOSE	315
D.2	SCOPE	315
D.3	PROBLEM SCENARIO	315
D.3.1	Problem Domain Suitability	315
D.3.2	Acknowledgements	316
D.3.3	Summary	316
D.3.4	The "Yacht in Distress" Scenario	316
D.4	DIAGRAMS	317
D.4.1	Package Overview (Structure of the Sample Model)	317
D.4.2	Flow of SAR Example Models	317
D.5	ALL VIEWS	318
D.6	AV-1 ENTERPRISE DEFINITION	318
D.6.1	AV-2 Architecture Dictionary	319
D.6.2	AV Measurements Definition (Fit for Purpose)	320
D.6.3	AV Measurements Instances (Fit For Purpose)	321
D.6.4	SysML Value Definitions - Fit For Purpose View	321
D.6.5	SysML Requirements - Fit For Purpose View	321
D.6.6	Strategic/Capability Views	322
D.6.7	StV-1 Capability Vision (DoDAF CV-1)	323
D.6.8	StV-2 Capability Taxonomy (DoDAF CV-2)	324
D.6.9	StV-3 Capability Phasing (DoDAF CV-3)	325
D.6.10	StV-4 Capability Clusters (DoDAF CV-4)	325
D.6.11	StV-4 Capability Clusters Class Diagram (DoDAF CV-4)	326
D.6.12	StV-5 Capability to Organization Deployment (DoDAF CV-5)	327
D.6.13	StV-6 Operational Activity to Capability Mapping (DoDAF CV-6)	327
D.7	OPERATIONAL VIEWS	327
D.7.1	OV-1a Operational Context Graphic	327
D.7.2	OV-1 b Operational Context Description	329
D.7.3	OV-1c Operational Context Measurements	329
D.7.4	OV-1d Operational Context Use Cases (Fit for Purpose)	330
D.7.5	OV-2 Operational Node Connectivity Description (DoDAF Operational Resource Flow Description)	331

D.7.6	<i>OV-3 Operational Exchange Summary (DoDAF Operational Resource Flow Matrix)</i>	332
D.7.7	<i>OV-4 Organizational Relationships Chart</i>	333
D.7.8	<i>OV-5 Operational Activity Model (DoDAF Operational Activity Decomposition Tree - OV-5A)</i> 334	
D.7.9	<i>OV-6a Operational Rules Model (Same in DoDAF)</i>	336
D.7.10	<i>OV-6b Operational State Transition Description</i>	336
D.7.11	<i>OV-6c Operational Event Trace Description</i>	337
D.7.12	<i>OV-7 Logical Data Model (DoDAF DIV-1/DIV-2)</i>	337
D.8	SERVICE ORIENTED VIEWS (DoDAF SVCV-1)	338
D.8.1	<i>SOV-1 Service Taxonomy</i>	339
D.8.2	<i>SOV-2 Service Interface Specification (DoDAF SvcV-2)</i>	339
D.8.3	<i>SOV-3 Capability to Service Mapping (DoDAF CV-7)</i>	340
D.8.4	<i>SOV-4a Service Behaviors and Constraints (DoDAF SvcV-10a)</i>	340
D.8.5	<i>SOV-4b Service Behaviors and Constraints (DoDAF SvcV-10b)</i>	341
D.8.6	<i>SOV-5 Service Functionality (DoDAF SvcV-4)</i>	341
D.9	SYSTEMS VIEWS	342
D.9.1	<i>SV-1 Resource Interaction Specification (DoDAF Systems Interface Description)</i>	342
D.9.2	<i>SV-2 Systems Communications Description (DoDAF System Resource Flow Description)</i>	343
D.9.3	<i>SV-3 Resource Interaction Matrix (DoDAF Systems - Systems Matrix)</i>	344
D.9.4	<i>SV-4 Functionality Description (DoDAF Systems Functionality Description)</i>	344
D.9.5	<i>SV-5 Function to Operational Activity/Service Function Traceability</i>	346
D.9.6	<i>SV-5 System Function to Operational Activity/Service Function Traceability Matrix</i>	347
D.9.7	<i>SV-6 System Exchange Matrix (DoDAF Systems Resource Flow Matrix)</i>	347
D.9.8	<i>SV-7 Resource Performance Parameters (DoDAF Systems Measures Matrix)</i>	348
D.9.9	<i>SV-8 System Capability Configuration Management (DoDAF Systems Evolution Matrix)</i>	349
D.9.10	<i>SV-9 Technology and Skills Forecast (DoDAF Systems Technology and Skills Forecast)</i>	350
D.9.11	<i>SV-9 Technology and Skills Forecast</i>	350
D.9.12	<i>SV-10a System Rules and Constraints (DoDAF Systems Rules Model)</i>	351
D.9.13	<i>SV-10b Resource State Transition Description (DoDAF System State Transition Description)</i>	352
D.9.14	<i>SV-10c Resource Event Trace Description (DoDAF System Event Trace Description)</i>	353
D.9.15	<i>Physical Schema (DoDAF DIV-3)</i>	354
D.9.16	<i>System Service Provision</i>	354
D.10	ACQUISITION VIEWS (DoDAF PROJECT VIEWS)	355
D.10.1	<i>AcV-1 System of Systems Acquisition Clusters (DoDAF PV-1)</i>	355
D.10.2	<i>AcV-2 Program Timeline (DoDAF PV-2)</i>	355
D.10.3	<i>AcV-3 Typical Project (DoDAF PV-3)</i>	356
D.10.4	<i>AcV-3 Actual Project Instance (DoDAF PV-3)</i>	356
D.11	TECHNICAL VIEWS (DoDAF STANDARDS VIEWS)	357
D.11.1	<i>TV-1 Standards Profile (DoDAF StdV-1)</i>	357
D.11.2	<i>TV-2 Standards Forecast (DoDAF StdV-2)</i>	358
D.11.3	<i>TV-2 Standards Forecast Tabular Form (DoDAF StdV-2)</i>	359
D.12	A SIMPLE EXAMPLE OF SYSML PARAMETRICS D.12.1 SYSML PARAMETRICS	359
D.12.1	<i>Scenario Overview</i>	359
D.12.2	<i>SV-3 System Context</i>	360
D.12.3	<i>System Parametrics</i>	361
D.12.4	<i>Parametric Equations</i>	361
D.12.5	<i>Instance Diagram</i>	363
ANNEX E	BIBLIOGRAPHY	364

Table of Figures

Figure 1:1 - UPDM Viewpoint Support Illustration	3
Figure 2:1 - UPDM Compliance Levels 0 and 1	4
Figure 2:2 - L0 and L1	5
Figure 7:1 - Top Level Profile Structure	18
Figure 7:2 - Middle Level Profile Structure	19
Figure 7:3 - Performs Stereotype	20
Figure 7:4 - Performs Hierarchy	20
Figure 7:5 - Connector Extension "metarelationship" dependency	21
Figure 7:6 - Capabilities Generalization	21
Figure 7:7 - Visualizing «metarelationship»	22
Figure 7:8 - UML Dependency metaclass	22
Figure 7:9 - "stereotyped relationship" dependency	22
Figure 7:10 - Aliases	23
Figure 8:1 - DoDAF Class Library	26
Figure 8:2 - ActualProject	32
Figure 8:3 - ActualProjectMilestoneRole	33
Figure 8:4 - OrganizationalProjectRelationship	34
Figure 8:5 - ProjectMilestoneRole	35
Figure 8:6 - ProjectType	36
Figure 8:7 - Exchange	37
Figure 8:8 - UPDMElement	37
Figure 8:9 - Activity	38
Figure 8:10 - CapableElement	39
Figure 8:11 - Implements	40
Figure 8:12 - IsCapableOfPerforming	41
Figure 8:13 - ActualLocation	42
Figure 8:14 - ConditionType	43
Figure 8:15 - Environment	43
Figure 8:16 - EnvironmentProperty	44
Figure 8:17 - LocationHolder	45
Figure 8:18 - LocationType	46
Figure 8:19 - ActualMeasurement	47
Figure 8:20 - ActualProperty	48

Figure 8:21 - ActualPropertySet	49
Figure 8:22 - Measurement	51
Figure 8:23 - MeasurementSet	51
Figure 8:24 - Property	52
Figure 8:25 - PropertySet	53
Figure 8:26 - ExchangeElement	54
Figure 8:27 - Participant	55
Figure 8:28 - Resource	56
Figure 8:29 - Rule	57
Figure 8:30 - ArchitecturalDescription	58
Figure 8:31 - ArchitecturalReference	60
Figure 8:32 - ArchitectureMetadata	61
Figure 8:33 - Metadata	61
Figure 8:34 - View	62
Figure 8:35 - Viewpoint	63
Figure 8:36 - ISO8601DateTime	64
Figure 8:37 - NodeOperation	65
Figure 8:38 - OperationalActivity	66
Figure 8:39 - OperationalActivityAction	67
Figure 8:40 - OperationalActivityEdge	68
Figure 8:41 - OperationalEventTrace	69
Figure 8:42 - OperationalMessage	70
Figure 8:43 - OperationalParameter	71
Figure 8:44 - OperationalState	71
Figure 8:45 - OperationalStateDescription	72
Figure 8:46 - SubjectOfOperationalStateMachine	73
Figure 8:47 - LogicalDataModel	73
Figure 8:48 - Command	74
Figure 8:49 - OperationalExchange	75
Figure 8:50 - OperationalExchangeItem	77
Figure 8:51 - ArbitraryConnector	78
Figure 8:52 - Competence	79
Figure 8:53 - ConceptItem	79
Figure 8:54 - ConceptRole	80
Figure 8:55 - HighLevelOperationalConcept	81

Figure 8:56 - KnownResource	82
Figure 8:57 - LogicalArchitecture.....	82
Figure 8:58 - Mission	83
Figure 8:59 - Needline	84
Figure 8:60 - Node	85
Figure 8:61 - NodeParent	86
Figure 8:62 - NodePort	87
Figure 8:63 - NodeRole	88
Figure 8:64 - OperationalConstraint.....	89
Figure 8:65 - SecurityDomain	90
Figure 8:66 - SubjectOfOperationalConstraint	90
Figure 8:67 - ActualOrganization	91
Figure 8:68 - ActualOrganizationalResource	92
Figure 8:69 - ActualOrganizationRelationship	93
Figure 8:70 - ActualOrganizationRole	94
Figure 8:71 - ActualPerson.....	95
Figure 8:72 - ActualPost.....	96
Figure 8:73 - CompetenceProvider	97
Figure 8:74 - FillsPost.....	97
Figure 8:75 - CompetenceRequirer	98
Figure 8:76 - Organization	99
Figure 8:77 - OrganizationalResource.....	100
Figure 8:78 - Person.....	100
Figure 8:79 - Post.....	101
Figure 8:80 - ProvidesCompetence.....	102
Figure 8:81 - RequiresCompetence	103
Figure 8:82 - Responsibility.....	104
Figure 8:83 - ServiceFeature	105
Figure 8:84 - ServiceFunction	106
Figure 8:85 - ServiceFunctionAction.....	107
Figure 8:86 - ServiceFunctionEdge	108
Figure 8:87 - ServiceInteraction.....	108
Figure 8:88 - ServiceMessage	109
Figure 8:89 - ServiceMessageHandler	110
Figure 8:90 - ServiceOperation	111

Figure 8:91 - ServiceParameter	112
Figure 8:92 - ServiceStateMachine	112
Figure 8:93 - AsynchronousMessage	113
Figure 8:94 - Request	114
Figure 8:95 - Service	114
Figure 8:96 - ServiceAttribute	115
Figure 8:97 - ServiceInterface	116
Figure 8:98 - ServiceLevelValue	117
Figure 8:99 - ServiceLevelValueSet	118
Figure 8:100 - ServicePolicy	118
Figure 8:101 - ServicePort	120
Figure 8:102 - Capability	121
Figure 8:103 - CapabilityProperty	122
Figure 8:104 - DesiredState	123
Figure 8:105 - Desirer	123
Figure 8:106 - EnterpriseGoal	124
Figure 8:107 - EnterprisePhase	125
Figure 8:108 - EnterpriseVision	126
Figure 8:109 - Exhibits	127
Figure 8:110 - MapsToCapability	128
Figure 8:111 - StructuralPart	129
Figure 8:112 - TemporalPart	130
Figure 8:113 - VisionStatement	130
Figure 8:114 - Function	131
Figure 8:115 - FunctionAction	132
Figure 8:116 - FunctionEdge	133
Figure 8:117 - ResourceEventTrace	134
Figure 8:118 - ResourceMessage	135
Figure 8:119 - ResourceOperation	136
Figure 8:120 - ResourceParameter	137
Figure 8:121 - ResourceState	137
Figure 8:122 - ResourceStateMachine	138
Figure 8:123 - DataModel	139
Figure 8:124 - PhysicalDataModel	139
Figure 8:125 - ResourceInteraction	140

Figure 8:126 - ResourceInteractionItem.....	141
Figure 8:127 - CapabilityConfiguration.....	142
Figure 8:128 - FieldedCapability.....	143
Figure 8:129 - Forecast.....	144
Figure 8:130 - PhysicalArchitecture.....	146
Figure 8:131 - PhysicalResource.....	147
Figure 8:132 - ResourceArtifact.....	147
Figure 8:133 - ResourceConnector.....	148
Figure 8:134 - ResourceConstraint.....	149
Figure 8:135 - ResourceInterface.....	150
Figure 8:136 - ResourcePort.....	151
Figure 8:137 - ResourceRole.....	152
Figure 8:138 - Software.....	153
Figure 8:139 - SubjectOfForecast.....	153
Figure 8:140 - SubjectOfResourceConstraint.....	154
Figure 8:141 - SystemResource.....	155
Figure 8:142 - VersionOfConfiguration.....	156
Figure 8:143 - WholeLifeConfiguration.....	157
Figure 8:144 - Protocol.....	157
Figure 8:145 - ProtocolImplementation.....	158
Figure 8:146 - Standard.....	159
Figure 8:147 - StandardConfiguration.....	160
Figure 8:148 - Details.....	160
Figure 8:149 - EntityAttribute.....	161
Figure 8:150 - EntityItem.....	162
Figure 8:151 - EntityRelationship.....	163
Figure 8:152 - ActivityPartOfProject.....	164
Figure 8:153 - Project.....	164
Figure 8:154 - ProjectActivity.....	165
Figure 8:155 - Information.....	166
Figure 8:156 - ActivityPerformedByPerformer.....	167
Figure 8:157 - Condition.....	168
Figure 8:158 - ConditionProperty.....	168
Figure 8:159 - GeoPoliticalExtent.....	169
Figure 8:160 - GeoPoliticalExtentType.....	171

Figure 8:161 - Location	172
Figure 8:162 - Measure.....	173
Figure 8:163 - MeasureType.....	173
Figure 8:164 - Performer	174
Figure 8:165 - IndividualPersonRole	174
Figure 8:166 - OrganizationType	175
Figure 8:167 - PersonType	175
Figure 8:168 - Skill.....	176
Figure 8:169 - SkillOfPersonType.....	176
Figure 8:170 - ServiceAccess.....	177
Figure 8:171 - ServiceDescription	177
Figure 8:172 - ActivityPartOfCapability	178
Figure 8:173 - CapabilityOfPerformer	178
Figure 8:174 - DesiredEffect	179
Figure 8:175 - Vision	180
Figure 8:176 - System	180
Figure 8:177 - FunctionalStandard	181
Figure 8:178 - TechnicalStandard	181
Figure 8:179 - AssociationOfInformation	182
Figure 8:180 - SecurityAttributesGroup	182
Figure 8:181 - ActualProjectMilestone	183
Figure 8:182 - IncrementMilestone	184
Figure 8:183 - MilestoneSequence	185
Figure 8:184 - OutOfServiceMilestone	186
Figure 8:185 - ProjectMilestone	186
Figure 8:186 - ProjectOwnership.....	187
Figure 8:187 - ProjectSequence.....	187
Figure 8:188 - ProjectStatus	188
Figure 8:189 - ProjectTheme	189
Figure 8:190 - StatusIndicators.....	190
Figure 8:191 - Climate.....	190
Figure 8:192 - LightCondition	191
Figure 8:193 - Alias	192
Figure 8:194 - Definition	193
Figure 8:195 - ExternalIndividual.....	193

Figure 8:196 - ExternalType	195
Figure 8:197 - OntologyReference	195
Figure 8:198 - SameAs	196
Figure 8:199 - StereotypeExtension	197
Figure 8:200 - ActivitySubject	198
Figure 8:201 - OwnsProcess.....	199
Figure 8:202 - Process.....	200
Figure 8:203 - StandardOperationalActivity	200
Figure 8:204 - Control	201
Figure 8:205 - Energy	202
Figure 8:206 - ProblemDomain.....	203
Figure 8:207 - Trustline.....	203
Figure 8:208 - RoleType	204
Figure 8:209 - DeployedMilestone	205
Figure 8:210 - NoLongerUsedMilestone.....	206
Figure 8:211 - EnduringTask	207
Figure 8:212 - WholeLifeEnterprise	207
Figure 8:213 - ProtocolLayer.....	208
Figure 8:214 - SOPES Elements.....	209
Figure 8:215 - Design Rule Elements	212
Figure A:1 - AcV-1/PV-1 - DMM	214
Figure A:2 - AcV-2/PV-2 - DMM	215
Figure A:3 - PV-3 - DMM	216
Figure A:4 - AV-1 - DMM.....	217
Figure A:5 - AV-2 - DMM.....	218
Figure A:6 - OV-1 - DMM	219
Figure A:7 - OV-2 - DMM	220
Figure A:8 - OV-3 - DMM	221
Figure A:9 - OV-4 Actual - DMM	222
Figure A:10 - OV-4 Typical - DMM	223
Figure A:11 - OV-5 - DMM	224
Figure A:12 - OV-6a - DMM	224
Figure A:13 - OV-6b - DMM	225
Figure A:14 - OV-6c - DMM.....	225
Figure A:15 - OV-7/DIV-1/DIV-2/ - DMM.....	226

Figure A:16 - SOV-1 - DMM	227
Figure A:17 - SOV-2 - DMM	227
Figure A:18 - SOV-3 - DMM	228
Figure A:19 - SOV-4a - DMM.....	228
Figure A:20 - SOV-4b - DMM	228
Figure A:21 - SOV-4c - DMM.....	229
Figure A:22 - SOV-5 - DMM	230
Figure A:23 - CV-7 - DMM.....	231
Figure A:24 - StV-1/CV-1 - DMM.....	232
Figure A:25 - StV-2/CV-2 - DMM.....	232
Figure A:26 - StV-3/CV-3 - DMM.....	233
Figure A:27 - StV-4/CV-4 - DMM.....	234
Figure A:28 - StV-5/CV-5 - DMM.....	235
Figure A:29 - StV-6/CV-6 - DMM.....	236
Figure A:30 - SV-1/SvcV-1 - DMM.....	237
Figure A:31 - SV-10a/SvcV-10a - DMM	238
Figure A:32 - SV-10b/SvcV-10b DMM.....	239
Figure A:33 - SV-10c/SvcV-10c - DMM	239
Figure A:34 - SV-11/DIV-3 - DMM.....	240
Figure A:35 - SV-12 - DMM	240
Figure A:36 - SV-2/SvcV-2 - DMM.....	241
Figure A:37 - SV-3/SvcV-3a/SvcV-3b - DMM	242
Figure A:38 - SV-4/SvcV-4 - DMM.....	243
Figure A:39 - SV-5/SvcV-5 - DMM.....	243
Figure A:40 - SV-6/SvcV-6 - DMM.....	244
Figure A:41 - SV-7/SvcV-7 - DMM.....	245
Figure A:42 - SV-8/SvcV-8 - DMM.....	246
Figure A:43 - SV-9/SvcV-9 - DMM.....	247
Figure A:44 - TV-1&2&3/StdV-1&2 - DMM.....	248
Figure A:45 - SOPES - DMM	249
Figure A:46 - Design Rule - DMM.....	249
Figure A:47 - Activity - DM2.....	250
Figure A:48 - Capability - DM2.....	251
Figure A:49 - Goals - DM2.....	252
Figure A:50 - Information and Data - DM2	253

Figure A:51 - Information Pedigree - DM2	253
Figure A:52 - Location - DM2	254
Figure A:53 - Measure - DM2.....	255
Figure A:54 - Organizational Structure - DM2	255
Figure A:55 - Performer - DM2	256
Figure A:56 - Project - DM2	257
Figure A:57 - Resource Flow - DM2	258
Figure A:58 - Rules - DM2	259
Figure A:59 - Services - DM2.....	259
Figure B:1 - AcV-1/PV-1	260
Figure B:2 - AcV-2/PV-2	261
Figure B:3 - PV-3	261
Figure B:4 - AV-1	263
Figure B:5 - AV-2	264
Figure B:6 - Environment Elements	265
Figure B:7 - Measurements	266
Figure B:8 - OV-1.....	267
Figure B:9 - OV-2.....	268
Figure B:10 - OV-3.....	269
Figure B:11 - OV-4 Actual.....	270
Figure B:12 - OV-4 Typical.....	271
Figure B:13 - OV-5.....	272
Figure B:14 - OV-6a.....	273
Figure B:15 - OV-6b.....	273
Figure B:16 - OV-6c.....	274
Figure B:17 - OV-7/DIV-1/DIV-2.....	275
Figure B:18 - SOV-1.....	276
Figure B:19 - SOV-2.....	277
Figure B:20 - SOV-3.....	277
Figure B:21 - SOV-4a.....	278
Figure B:22 - SOV-4b.....	278
Figure B:23 - SOV-4c.....	279
Figure B:24 - SOV-5.....	279
Figure B:25 - CV-7	280
Figure B:26 - StV-1/CV-1	281

Figure B:27 - StV-2/CV-2	282
Figure B:28 - StV-3/CV-3	283
Figure B:29 - StV-4/CV-4	283
Figure B:30 - StV-5/CV-5	284
Figure B:31 - StV-6/CV-6	285
Figure B:32 - SV-1/SvcV-1	286
Figure B:33 - SV-10a/SvcV-10a	287
Figure B:34 - SV-10b/SvcV-10b	287
Figure B:35 - SV-10c/SvcV-10c	288
Figure B:36 - SV-11/DIV-3	288
Figure B:37 - SV-12	289
Figure B:38 - SV-2/SvcV-2	289
Figure B:39 - SV-3/SvcV-3a/SvcV-3b	290
Figure B:40 - SV-4/SvcV-4	291
Figure B:41 - SV-5/SvcV-5	292
Figure B:42 - SV-6/SvcV-6	293
Figure B:43 - SV-7/SvcV-7	294
Figure B:44 - SV-8/SvcV-8	294
Figure B:45 - SV-9/SvcV-9	295
Figure B:46 - TV-1&2&3/StdV-1&2	296
Table C:1 - DoDAF-DM2, UPDM, and MODAF Mapping	306
Table C:2 - NAF 3.1 and MODAF View Comparison	310
Table C:3 - Traceability between the DoDAF 2.0 and MODAF 1.2 views	314
Table D:1 - Acronyms	317
Figure D:1 - Diagram Flow	317
Figure D:2 - AV-1	319
Table D:2 - AV-2 Operational Activity Dictionary report	319
Table D:3 - AV-2 Capability Configuration Dictionary report	320
Figure D:3 - AV Measurements Class Diagram	320
Figure D:4 - AV Measurements Instance Diagram	321
Figure D:5 - SysML BDD Units, Dimensions, and Value Types	321
Figure D:6 - SysML Requirements	322
Figure D:7 - StV-1 Enterprise View	323
Figure D:8 - StV-2 Capability Taxonomy	324
Table D:4 - StV-3 Capability Phasing	325

Figure D:9 - StV-4	326
Figure D:10 - StV-4 Alternative View	326
Table D:5 - StV-5.....	327
Figure D:11 - StV-6.....	327
Figure D:12 - OV-1a	328
Figure D:13 - Alternate OV-1a	328
Table D:6 - OV-1c	329
Figure D:14 - OV-1d	330
Figure D:15 - OV-2 Class Diagram	331
Figure D:16 - Alternate OV-2 SysML Version without Service Ports	331
Figure D:17 - Alternate OV-2 with SysML Flow Ports	332
Table D:7 - OV-3	333
Figure D:18 - OV-4 Typical	333
Figure D:19 - OV-4 Actual	334
Figure D:20 - OV-5	335
Figure D:21 - Alternate OV-5	335
Table D:8 - OV-6a Operational Constraints	336
Figure D:22 - OV-6b	336
Figure D:23 - OV-6c.....	337
Figure D:24 - OV-7	338
Figure D:25 - SOV-1	339
Figure D:26 - SOV-2	339
Figure D:27 - SOV-3	340
Table D:9 - SOV-4a Service Policies	340
Figure D:28 - SOV-4b	341
Figure D:29 - SOV-5	342
Figure D:30 - SV-1 Maritime Rescue Unit	343
Figure D:31 - SV-2	343
Table D:10 - SV-3 System Connectivity Matrix.....	344
Figure D:32 - SV-4	344
Figure D:33 - SV-4 Activity Diagram.....	345
Figure D:34 - SV-5	346
Table D:11 - SV-5	347
Table D:12 - SV-6	347
Figure D:35 - SV-7	348

Table D:13 - SV-7 in Tabular Format	348
Table D:14 - SV-8	349
Figure D:36 - SV-9	350
Table D:15 - SV-9	350
Table D:16 - Systems Rules and Constraints	351
Figure D:37 - SV-10b	352
Figure D:38 - SV-10c	353
Figure D:39 - SV-11	354
Table D:17 - SV-12	354
Table D:18 - AcV-1	355
Figure D:40 - AcV-2	355
Figure D:41 - AcV-3 Class Diagram	356
Figure D:42 - AcV-3 Actual	356
Figure D:43 - AcV-3 Additional Milestone Types	357
Table D:19 - TV-1	357
Figure D:44 - TV-2	358
Figure D:45 - TV-2	358
Table D:20 - TV-2	359
Figure D:46 - Block Definition Diagram	360
Figure D:47 - System Parametrics	361
Figure D:48 - Scanning and Availability Equations	361
Figure D:49 - Fuel Availability Equation	361
Figure D:50 - Crew Availability Equation	362
Figure D:51 - Aircraft System Parametric	362
Figure D:52 - System Instance Diagram	363

Preface

About the Object Management Group

OMG

Founded in 1989, the Object Management Group, Inc. (OMG) is an open membership, not-for-profit computer industry standards consortium that produces and maintains computer industry specifications for interoperable, portable, and reusable enterprise applications in distributed, heterogeneous environments. Membership includes Information Technology vendors, end users, government agencies, and academia.

OMG member companies write, adopt, and maintain its specifications following a mature, open process. OMG's specifications implement the Model Driven Architecture® (MDA®), maximizing ROI through a full-lifecycle approach to enterprise integration that covers multiple operating systems, programming languages, middleware and networking infrastructures, and software development environments. OMG's specifications include: UML® (Unified Modeling Language™); CORBA® (Common Object Request Broker Architecture); CWMTM (Common Warehouse Metamodel); and industry-specific standards for dozens of vertical markets.

More information on the OMG is available at <http://www.omg.org/>.

OMG Specifications

As noted, OMG specifications address middleware, modeling and vertical domain frameworks. A Specifications Catalog is available from the OMG website at:

http://www.omg.org/technology/documents/spec_catalog.htm

Specifications within the Catalog are organized by the following categories:

OMG Modeling Specifications

- UML
- MOF
- XMI
- CWM
- Profile specifications.

OMG Middleware Specifications

- CORBA/IIOP
- IDL/Language Mappings
- Specialized CORBA specifications
- CORBA Component Model (CCM).

Platform Specific Model and Interface Specifications

- CORBA services
- CORBA facilities
- OMG Domain specifications
- OMG Embedded Intelligence specifications
- OMG Security specifications.

All of OMG's formal specifications may be downloaded without charge from our website. (Products implementing OMG specifications are available from individual suppliers.) Copies of specifications, available in PostScript and PDF format, may be obtained from the Specifications Catalog cited above or by contacting the Object Management Group, Inc. at:

OMG Headquarters, 109 Highland Avenue, Needham, MA 02494 USA

Tel: +1-781-444-0404 Fax: +1-781-444-0320 [Email: pubs@omg.org](mailto:pubs@omg.org)

Certain OMG specifications are also available as ISO standards. Please consult <http://www.iso.org>

Typographical Conventions

The type styles shown below are used in this document to distinguish programming statements from ordinary English. However, these conventions are not used in tables or section headings where no distinction is necessary.

Times/Times New Roman - 10 pt.: Standard body text

Helvetica/Arial - 10 pt. Bold: OMG Interface Definition Language (OMG IDL) and syntax elements.

Courier/Courier New - 10 pt. Bold: Programming language elements.

Helvetica/Arial - 10 pt: Exceptions

Note – Terms that appear in *italics* are defined in the glossary. Italic text also represents the name of a document, specification, or other publication.

Subpart I - Overview of the UML Profile for DoDAF and MODAF

This subpart contains the following Clauses and sub clauses:

- 1. Scope
 - 1.1. General
 - 1.2. Scope
- 2. Compliance
 - 2.1 Compliance Levels
 - 2.1.1. Level 0 : Based on UML 2 and Partial SoaML Import
 - 2.1.2 Level 1 : Based on UML 2 and Full SysML Import
- 3. Normative References
- 4. Terms and Definitions
- 5. Symbols and Acronyms
- 6. Additional Information
 - 6.1. Additional Materials
 - 6.1.1. Statement of support from the DoD representative 19 May 2011
 - 6.1.2. Statement of contribution from the MOD representative received 17th May, 2011
 - 6.1.3. Statement of support from the Swedish Armed Forces representative received 16 th May 2011
 - 6.2. Overview of this Specification
 - 6.2.1. Intended Audience
 - 6.2.2. Organization of this Specification
 - 6.3. Acknowledgements

1 Scope

1.1 General

The authors believe that this specification for a Unified Profile for the Department of Defense Architecture Framework (DoDAF) and the Ministry of Defence Architecture Framework (MODAF) will

- enhance the quality, productivity, and effectiveness associated with enterprise and system of systems architecture modeling,
- promote architecture model reuse and maintainability,
- improve tool interoperability and communications between stakeholders, and
- reduce training impacts due to different tool implementations and semantics.

The purpose of this document is to specify a UML 2, and optional SysML, profile to enable practitioners to express DoDAF and MODAF model elements and organize them in a set of specified viewpoints and views that support the specific needs of stakeholders in the US Department of Defense and the United Kingdom Ministry of Defence. The profile defined in this specification has been imported by at least four tool vendors including Artisan, EmbeddedPlus, No Magic, and Visumpoint, and the implementation is actively under development. They all plan to release a commercially available product supporting this version of UPDM within the next year. Currently, partial implementations are being used actively on projects.

UPDM 2.0 defines a set of UML and optional SysML stereotypes and model elements and associations to satisfy the requirements of the UPDM 2.0 RFP. This specification documents the language architecture in terms of the parts of UML 2 that are reused and the extensions to UML 2 and SysML. The specification includes the concrete syntax (notation) for the complete language. The reusable portion of the UML 2 and SysML specification are not included directly in the specification but are included by reference. The specification also provides an example of how the language can be used to represent a UPDM 2.0 architecture.

1.2 Scope

The scope of UPDM 2.0 includes the language extensions to enable the extraction of specified and custom views from an integrated architecture description. These views include a system's viewpoint (DoDAF Systems View) along with associated systems implementation standards (DoDAF/MODAF Technical View) within the context of the business or enterprise viewpoint (DoDAF/MODAF Operational View). The DoDAF/MODAF AllViews is also included. In addition, UPDM 2.0 allows the architecture model to include representation of an enterprise capability and strategic intent (MODAF Strategic Viewpoint, DoDAF 2.02 Capability Model) and the process steps associated with the procurement of conformant systems (MODAF Acquisition View, DoDAF 2.02 Project Model). Finally, the MODAF and DoDAF 2.02 Services View is included to model Service Oriented Architectures. UPDM 2.0 also includes mechanisms for designing ad hoc custom views and more formal extensions of new views of the model. The specification also allows for combined views such as the DoDAF 2.02 Data Model combining the SV-1 1 and OV-7. NAF is supported implicitly through the recent convergence of the MODAF and NAF standards. Consequently, NAF is not explicitly mentioned in the following specification for simplicity. However, a separate mapping subsection is included in Annex C to demonstrate compliance. In addition, the authors have worked closely with the NAF management group in order to ensure compliance and that the specification is fit for purpose.

UPDM 2.0 will support the capability to:

- model architectures for a broad range of complex systems, which may include hardware, software, data, personnel, and facility elements;
- model consistent architectures for system-of-systems down to lower levels of design and implementation;

- model service oriented architectures;
- support the analysis, specification, design, and verification of complex systems; and
- improve the ability to exchange architecture information among related tools that are UML based and tools that are based on other standards.

The profile provides the modeling of operational capabilities, services, system activities, nodes, system functions, ports, protocols, interfaces, performance, and physical properties and units of measure. In addition, the profile enables the modeling of related architecture concepts such as DoD's doctrine, organization, training material, leadership & education, personnel, and facilities (DOTMLPF) and the equivalent UK Ministry of Defence Lines of Development (DLOD) elements.

UPDM 2.0, as illustrated in Figure 1:1, will address DoDAF and MODAF Viewpoints as well as enabling extensions to new architecture perspectives (e.g., Services views, Custom views, Logistics views cost views, etc.). MODAF terminology has been used for simplicity.

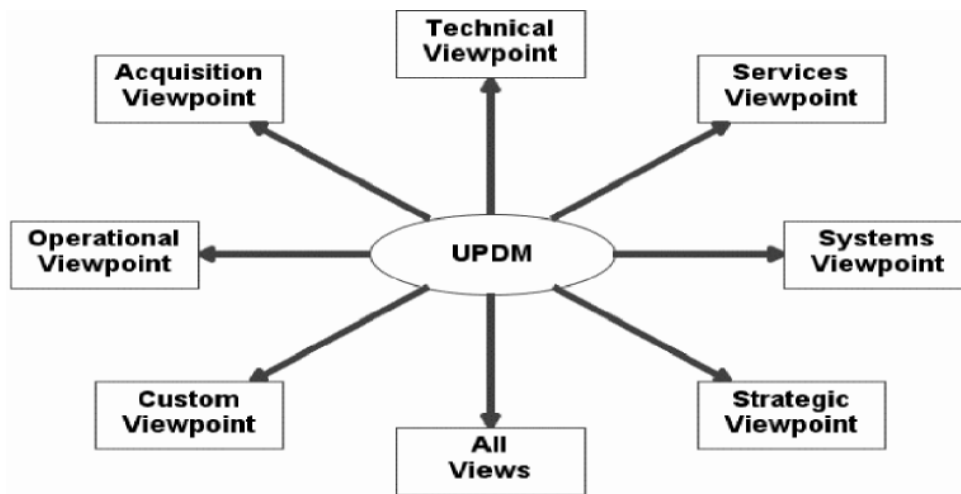

Figure 1:1 - UPDM Viewpoint Support Illustration

2 Compliance

2.1 Compliance Levels

UPDM 2.0 specifies two compliance levels corresponding to supporting a UML-based profile and a UML+OMG SysML™ profile.

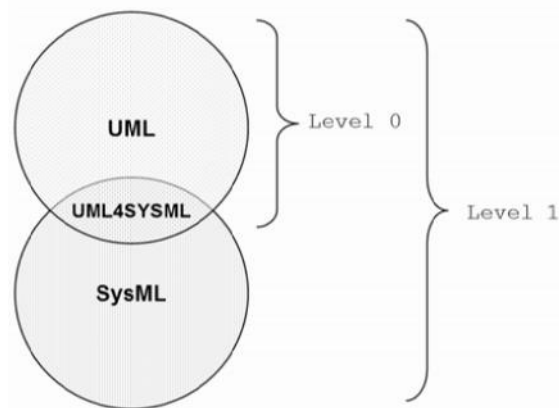

Figure 2:1 - UPDM Compliance Levels 0 and 1

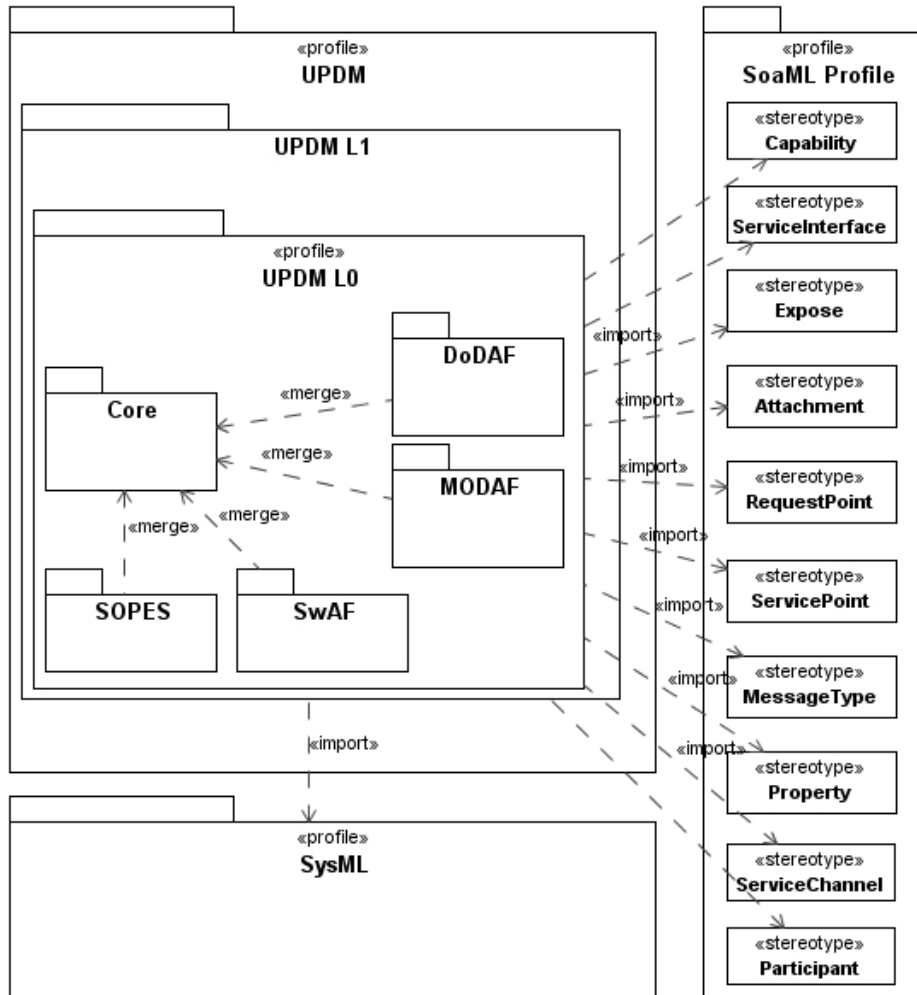

Figure 2:2 - L0 and L1

2.1.1 Level 0 : Based on UML 2 and Partial SoaML Import

Figure 2:2 illustrates that UPDM 2.0 Compliance Level 0 is an implementation of UPDM extending UML 2 and importing several SoaML stereotypes – namely Expose, Attachment, RequestPoint, ServicePoint, MessageType, Property. In order for a tool to be considered as compliant with L0, the following must be true:

- All stereotypes, classes, attributes, constraints, associations, and package structures that are scoped to the L0 package (including sub-packages) must exist and be compliant with this specification.
- XMI import and export of the user model and profile must be supported.
- A Level 0 compliant implementation must be able to import and export Level 0 UPDM 2.0 models with 100% fidelity (i.e., no loss or transforms).
- A Level 0 compliant implementation must be able to import Level 1 UPDM 2.0 models with only minimal losses.

2.1.2 Level 1 : Based on UML 2 and Full SysML Import

Figure 2:2 illustrates that UPDM 2.0 Compliance Level 1 includes everything in Level 0, imports the rest of the SysML sub-profiles and defines constraints that pair together the application of SysML and UPDM 2.0

stereotypes. This provides a UPDM 2.0 implementation that can be seamlessly taken forward into SysML modeling. For a tool to be considered as compliant with L1, the following must be true:

- All stereotypes, classes, attributes, constraints, associations and package structures that are scoped to the L1 package (including sub-packages) must exist and be compliant with this specification.
- XMI import and export of the user model and profile must be supported.
- A Level 1 compliant implementation must be able to import and export Level 1 UPDM 2.0 models with 100% fidelity (i.e., no loss or transforms).

A Level 1 compliant implementation must be able to import Level 0 UPDM 2.0 models with no loss, and transformations where necessary.

3 Normative References

The following normative documents contain provisions, which through reference in this text, constitute provisions of this specification. Subsequent amendments to, or revisions of, any of these publications do not apply.

3.1 OMG Documents

- Unified Modeling Language: Superstructure version 2.3 (<http://www.omg.org/spec/UML/2.3/Superstructure>)
- Unified Modeling Language: Infrastructure version 2.3 (<http://www.omg.org/spec/UML/2.3/Infrastructure>)
- MOF 2.0/XMI Mapping Specification, v2. 1 (<http://www.omg.org/spec/XMI/2.1>)
- UML 2.0 OCL Specification, v2.0 (<http://www.omg.org/spec/OCL/2.0>)
- SoaML Specification, v1 .0: (<http://www.omg.org/spec/SoaML/>)
- OMG Systems Modeling language (OMG SysML), V1 .2 (<http://www.omg.org/spec/SysML/1.2>)

3.2 Other Documents

- MODAF The MOD Architectural Framework Version 1.2.002 August 2008 (<http://www.modaf.org.uk> <http://www.modaf.org.uk/M3>)

3.2.1 Department of Defense Documents

DoD Deputy Chief Information Officer. Department of Defense Architecture Framework, Version 2.02, August 2010. 1. *The DoDAF Architecture Framework Version 2.02*. is defined in a web site format. One should start from the home page <http://cio-nii.defense.gov/sites/dodaf20/>

The following information was current on the web site as of 27 April 2011. The official and current version for the Department of Defense Architecture Framework. **is Version 2.02, dated August 2010.** An Adobe Portable Document Format (PDF) version of the 2.02 website is produced can be downloaded as: [DoDAF 2.02 .pdf](http://cio-nii.defense.gov/sites/dodaf20/products/DoDAF_v2-02_web.pdf) from http://cio-nii.defense.gov/sites/dodaf20/products/DoDAF_v2-02_web.pdf. This is approximately 289 pages.

2. For readers familiar with the three-volume version of DoDAF, the latest version is still DoDAF 2.0 of 2009. DoDAF 2.01 and 2.02 have not produced updates to that version. The reader must apply the changes documented in the Version Description Documents (see section 3 below) as well as the material on the official web site (see section 1 above). Again, the documentation set has not been changed from DoDAF Version 2.0 and is no longer definitive for 2.02 without the changes. It can be downloaded from the DoDAF Archives <http://cio-nii.defense.gov/sites/dodaf20/archives.html> or

- Volume One: Introduction, Overview, and Concepts: Manager's Guide, 28 May 2009
 - <http://cio-nii.defense.gov/docs/DoDAF%20V2%20-%20Volume%201.pdf> Volume Two: Architectural Data and Models: Architect's Guide, 28 May 2009
 - <http://cio-nii.defense.gov/docs/DoDAF%20V2%20-%20Volume%201.pdf> Volume Three: DoDAF Meta-model: Physical Exchange Specification: Developer's Guide, 28 May 2009
 - <http://cio-nii.defense.gov/docs/DoDAF%20V2%20-%20Volume%203.pdf>

3. DoDAF Meta Model (DM2). The DM2 for Version 2.02 of DoDAF can be derived sequentially as follows:

- The DoDAF Meta Model (DM2) **has changed** from DoDAF Version 2.0. It can be derived as a sequential update from DoDAF MetaModel (DM2) Version 2.00 to 2.01, and 2.02. There were 94 changes in the DoDAF MetaModel (DM2) from DoDAF 2.0 (68 in Version 2.01 and (26 in Version 2.02)¹ These changes may be traced as follows:

3.1 Start with a *description* of DoDAF/DM2 Version 2.00 baseline

See <http://cio-nii.defense.gov/sites/dodaf20/DM2.html>

The DM2 consists of the following data items:

- Conceptual Data Model
<http://cio-nii.defense.gov/sites/dodaf20/conceptual.html> and http://cio-nii.defense.gov/sites/dodaf20/DM2_HTML/index.htm
- Logical Data Model
<http://cio-nii.defense.gov/sites/dodaf20/logical.html>
- Physical Exchange Specification:
<http://cio-nii.defense.gov/sites/dodaf20/PES.html>
- Ontology:
<http://cio-nii.defense.gov/sites/dodaf20/Ontology1.html>

3.2 Proceed to the description of changes made to DoDAF/DM2 2.00 to create DoDAF/DM2 2.01 **Version 2.01** as of 1 April 2010. Version Description Document for the DoD Architecture Framework (DoDAF) and DoDAF Meta Model (DM2), Version 2.01 can be downloaded from http://cio-nii.defense.gov/sites/dodaf20/products/DoDAF_DM2_VDD_v2-01.doc

3.3 Proceed to the description of changes made to DoDAF/DM2 2.01 to create DoDAF/DM2 2.02, download the Version Description Document from http://cio-nii.defense.gov/sites/dodaf20/products/DoDAF-DM2_v2-02_VDD.pdf.

4. Supporting Material

- The Data Dictionary for Version 2.02 is available in spreadsheet format as http://cio-nii.defense.gov/sites/dodaf20/products/DM2_Data_Dictionary_and_Mappings_v202.xls
- Promulgation Memo: <http://cio-nii.defense.gov/docs/DoDAF%20V2%20-%20Promulgation%20Memo.pdf>

¹ The proper tracing of metamodel is so critical to UPDM 2.0 that UPDM 2.0 has produced a deliverable spreadsheet tracing UPDM Profile to the DM2 & MM3 in Annex C.

4 Terms and Definitions

No new terms and definitions have been required to create this specification. All terms should be available in the normative references or bibliographic citations for detailed explanation.

5 Symbols and Acronyms

AcV-*	Acquisition View
AV-*	All View
BPMN	Business Process Modeling Notation
C4ISR	Command, Control, Communications, Computers, Intelligence, Surveillance, and Reconnaissance
COI	Communities of Interest
CV-*	Capability View
DIV-*	Data and Information Views
DM2	DoDAF Meta Model
DMM	UPDM Domain Meta Model
DoD	United States Department of Defense
DoDAF	Department of Defense Architecture Framework
DOTMLP	Doctrine, Organization, Training, Material, Leadership, Personnel, Facilities
EIE	Enterprise Information Environment
IDEAS	International Defense Enterprise Architecture Exchange
IDEF	Integrated DEFinition Methods
JCIDS	Joint Capabilities Integration and Development System
JETL	Joint Essential Task List
MOD	United Kingdom Ministry of Defence
MODAF	Ministry of Defence Architecture Framework
NEC	Network Enabled Capability
NCW	NetCentric Warfare
NCAT	NetCentric Assessment Tool
NCOIC	NetCentric Operations Industry Consortium
OV-*	Operational View
PES	DoDAF Physical Exchange Specification
POC	Proof of Concept
PV-*	Project View
SoS	System of Systems
SOV-*	Service Oriented View
StdV-*	Standards View
STV-*	Strategic View
SV-*	System View
SvcV-*	Service View
TPPU	Task, Post, Process, and Use
TV-*	Technical View
UPDM	Unified Profile for DoDAF and MODAF

6 Additional Information

6.1 Additional Materials

Accompanying this specification are XMI files and requirements documents, as listed below.

Title	OMG Document Number	Supersedes
UPDM Profile Submission	dtc/201 1-06-14	c4i/2010-08-06
UPDM Profile Submission - ERRATA	N/A	N/A
UPDM Beta 2 specification without change notes	dtc/201 1-06-13	N/A
Inventory List	dtc/201 1-06-16	N/A
Final Report	dtc/201 1-06-12	N/A
UPDM XMI Document for UML	dtc/201 1-06-15	c4i/20 10-08-07
UPDM Requirements Traceability Document	N/A	N/A
UPDM Requirements Traceability Document - ERRATA	N/A	N/A

6.1.1 Statement of support from the DoD representative 19 May 2011

19 May 2011

To: Co-Chairs of the OMG UPDM Group

From: Leonard F. Levine DoD/DISA/EE31/703-225-4748 Subject: Summary of US DoD Support for UPDM 2.0

I am pleased to update and strengthen the endorsement of the Unified Profile for DoDAF and MODAF (UPDM) for Version 2.0

DoD support for the UPDM is strong and has steadily increased since 2005. As I wrote for UPDM Version 1.0, DoD promotes the use of international, national, and industry-wide open standards.

DoD welcomed the adoption of UPDM Version 1.0 by the Object Management Group (OMG) as an industry specification for architecture tools and the submission of UPDM Version 1.1 this very month to the International Organization for Standardization (ISO) as an international standard. UPDM Version 1 .x has been mandated for use in DoD Acquisition and recorded in the DoD IT Standards Registry (DISR). One of the criteria for this mandate was the availability of more than three widely-used commercial tools complying with standard. UPDM 1 .x remains viable for those using the DoD Architecture Framework (DoDAF), Version 1.5. I also point out that, on 19 September 2008, the United Kingdom Ministry of Defence (UK MOD) and the United States Department of Defense issued a joint statement of support.

Immediately upon release of DoDAF, Version 2.0 in May 2009, the OMG UPDM Group began synchronization of its lifecycle, particularly the respective Meta Models with the DODAF, and in August 2011, finalized its requirements upon the issuance of the maintenance upgrade of DoDAF 2.02. During the ensuing two years, technical representatives of the two groups have met quarterly at the OMG as well as at numerous ad hoc

meetings. The result was a complete mapping between the DoDAF Meta Model (DM2) and the UPDM Domain Meta Model (DMM), from which the normative Profile derives. This is particularly noteworthy since UPDM maintained equal support for the MODAF and added support for the NATO Architecture Framework (NAF).

Particularly noteworthy is the inclusion within the current and upcoming versions of the UPDM Profile of the Unified Modeling Language (UML) Profiles for Systems Modeling Language (SysML), Service Oriented Architecture Modeling Language (SOAML), and Business Process Modeling Notation (BPMN). While these are optional within UPDM, these standards are also DoD mandated standards. SysML, SOA, and BPMN support other DoD processes referenced in DoDAF and in Acquisition Processes supported by Acquisition, Technology and Logistics (OASD/ATL). This flexibility increases the appeal of the standard across the Department and promotes reuse across the various disciplines involved with acquisition.

A most important development in UPDM 2.0 is the proven capability of exchange of models among end-users as well as tool vendors. UPDM compliant tools will include architecture exchanges through the XML Metadata Interchange (XMI), and I note the facilitating role of the OMG Model Interchange Working Group in testing and making this practicable. This group plans to subject UPDM and its Search and Rescue (SAR) to tough interoperability tests through its use of OMG / ISO XMI.

In closing, I will paraphrase Mr. Brian Wilczynski, the Director, Architecture and Infrastructure, U.S. Department of Defense, Office of the Chief Information Officer, at the annual Enterprise Architecture Conference held this 11 – 15 April 2011 in Hampton, Virginia (Introductory Remarks at <http://afei.kzoplatform.com/swf/player/758> and Closing Remarks at <http://afei.kzoplatform.com/swf/player/770>):

- While UPDM does not solve all architecture problems, it represents a significant jump ahead in interoperability and architecture exchange.
- There has been a lot of DoD involvement, a very intensive engagement at times, involved with development of UPDM with significant devotion of human resource. This not something we could sit back and monitor, yet more impressively
- The UML tool vendors have come to the table because they see benefit in this.
- What's in it for us in DoD?
 - These tool vendors are implementing our standard.
 - And now we can reuse architectures.
- UPDM solves many of our problems because it is an enabler and allows improvement of information exchange across architecture toolsets.
- But that is a limited set of toolsets.
- Further education is required on where UPDM is applicable and where it can solve our problems, and what its role is.
- The whole experience with the OMG group is a model of how to work with industry without us (government) having to do a solution of its own.
- In summary, if you are using UML modeling tools for DoDAF 2.0, use UPDM. UPDM 2.0 will be mandated for those using DoDAF 2 and it will be part of the DISR.

Defense Information Systems Agency (DISA) ATTN: Leonard F. Levine /Code EE31
P.O. Box 549
Ft. Meade, MD 20755-0549

6.1.2 Statement of contribution from the MOD representative received 17th May, 2011

The United Kingdom Ministry of Defence, who developed and own MODAF, has actively contributed to the development of UPDM version 1 and version 2, primarily through the provision of contracted expertise sourced from Model Futures. The standardisation effort made by the UPDM group and OMG is regarded with high importance by MOD, as is demonstrated by the level of internal and external MOD resource provided to support the development of UPDM, and further evidenced by the recognition of UPDM in MOD's Joint Services Publication 605, Defence Architecture Policy Version 1.1 (page 7, EAP. 12) dated 11/04/2011, which states that:

"EAP. 12. Software Tools that are based on the Unified Modelling Language (UML) or the Systems Modelling Language (SysML) notations shall use the Unified Profile for DoDAF and MODAF (UPDM) standard which MOD recognises as a correct implementation of the M3."

Patrick Gorman
Assistant Head Architecture Framework CIO-ISP-POL
Ministry of Defence
Main Building, 2.N.19
Whitehall
LONDON, SW1A 2HB

6.1.3 Statement of support from the Swedish Armed Forces representative received 16 th May 2011

Swedish Armed Forces has in an active way, through FMV and with Generic AB as expert contractor to FMV, been supporting the work with UPDM version 1 and version 2. The standardization effort made within the UPDM group and OMG is regarded as very important by us, as proved by the level of support we have provided to the work with developing UPDM version 1 and 2. In those cases where UML tools are applicable for our work, we will only select UML tools that are compliant with the UPDM standard.

LtCol Mikael Hagenbo
Swedish Armed Forces HQ.
Supreme Commanders Staff, Joint Development Department,
Head of architecture, frameworks and International co-operation
Diplomaed Change Manager
SE-107 85 STOCKHOLM

6.2 Overview of this Specification

6.2.1 Intended Audience

This specification will be of interest to end users who expect to use this profile, and to tool vendors interested in developing tool support for the development of enterprise and system of systems architectures, and that can satisfy contract documentation requirements for DoD and MOD customers. Tool vendors will also be able to use this specification to support Model Driven Development of systems based on the architectural descriptions based on this profile. Developers and reviewers of the views will have a clearer understanding of the semantics behind specific views and viewpoints, which will support more precise evaluation and comparison.

6.2.2 Organization of this Specification

DoDAF and MODAF are formally expressed as domain-specific meta-models known as the DoDAF Meta Model (DM2) and the MODAF Meta Model (M3) respectively. There is also a set of viewpoints and views that address the concerns of a well-defined set of stakeholders. Before DoDAF Version 2.02 and UPDM Version 2.0, these were the organizing factors. This is no longer the case. This specification organizes the presentation of the UPDM 2.0 abstract and concrete syntax around the meta-models, with effort made to establish a maximum set of common Core models and a minimum set of DoDAF DM2 or MODAF M3 specific models. Significant effort has also been made to continue to support the now over 50 viewpoints that can be derived from these meta-

models as well as "user-defined views." This is done so that the discussion is well-connected to the domain experts required to produce these views. The rest of this document contains the technical content of this specification. As background for this specification, readers may wish to review the UML, OMG SysML, and SoaML specifications that complement this specification.

Although the clauses are organized in a logical manner and can be read sequentially, this is a reference specification that can be read in a non-sequential manner.

Part I of the specification describes the details of the specification.

Part II provides the technical details essential to understanding the specification:

The specification of the Profile language. The profile includes both a Compliance Level 0 that extends UML and a Compliance Level 1 that extends UML and OMG SysML. The elements of the profile are organized by the specific viewpoints required by DoDAF and MODAF. Within each of the viewpoint-specific sections, e.g., Operational Views (OVs), the elements are presented in alphabetical order.

Annex A presents a non-normative view of various diagrams that document the Domain Metamodel (DMM) that document the DoDAF 2.02 and MODAF 1.2 integrated model. This model was used as a basis for creating the UPDM 2.0 profile.

Annex B presents a non-normative view of the various diagrams that document the views from the UPDM Profile that implement the DoDAF 2.02 and MODAF 1.2 views in the Domain Meta-Model described in Annex A.

Annex C presents the traceability among UPDM 2.0 stereotypes and DoDAF/MODAF elements. Please note that not all DoDAF/MODAF elements have corresponding UPDM 2.0 stereotypes. Those DoDAF/MODAF elements are modeled by UML artifacts directly, which is shown in the Metaclass column. Annex C also contains a mapping table showing traceability between the NAF 3.1 and MODAF 1.2 views and elements, and the DoDAF 2.02 and the MODAF 1.2 views.

Annex D Sample Problem illustrating UPDM 2.0 concepts

Annex E contains the bibliography providing a listing of additional consulted artifacts.

6.3 Acknowledgements

The following individuals submitted parts of this specification and/or have assisted the UPDM 2.0 team in the development of the specification:

Adaptive Inc	Pete Rivett
Advanced System Management Group	Michael Abrason
Atego	Phil Astle
Atego	Matthew Hause
BAE Systems	David C. Putman
BORO Solutions	Chris Partridge
Decisive Analytics Corp	Charles Johnson
DOD	Leonard Levine
DOD	Walt Okon
EmbeddedPlus Engineering	Paula Obeid
EmbeddedPlus Engineering	Kumar Marimuthu
Generic AB	Lars-Olof Kihlstrom
General Dynamics	Ron Townsend
International Business Machines	Graham Bleakley
Lockheed Martin	Sanford Friedenthal
Lockheed Martin	Laura Hart
Malina Software	Bran Selic

Mega
Mitre
MOD
MOD
MOD
Model Futures
No Magic, Inc.
No Magic, Inc.
No Magic, Inc.
No Magic, Inc.
No Magic, Inc.
No Magic, Inc.
Northrop Grumman
OSD
Raytheon
Raytheon
Rolls Royce
Cisco
Silver Bullet
Silver Bullet
Sparx Systems
Swedish Armed Forces
Visumpoint
Visumpoint

Antoine Lonjon
Fatma Dandashi
Adrian Pearson
Patrick Gorman
John Keefe
Ian Bailey
Daniel Brookshier
Aurelijus Morkevicius
Jim Rice
Amelia Shroyer
Andrius Strazdauskas
J. D. Baker
Jeff Wilson
Dwayne Hardy
Ron Williamson
Wally Lee, PhD
Francis Thom
Fariba Hozhabrafkan
Dave McDaniel
Greg Schaefer
Sam Mancarella
Mikael Hagenbo
Robert Lario
Ginna Yost

The team would like to express their thanks to all of the above individuals and many others who are not listed.

Once again, it is important to stress that UPDM 2.0 is not a new framework. Instead, UPDM 2.0 is a specification for modeling DoDAF and MODAF architectures using UML and SysML. As such, it could not have been produced without taking concepts, structures and descriptions, etc, from the DoDAF and MODAF documentation and specifications, particularly the M3. The main authors of the M3 were:

- V1 .0 – Dave Mawby (PA Consulting), Paul King (Vega/ Detica) and Ian Bailey.
- V1.1 – Adrian Pearson (MOD), Paul King and Ian Bailey.
- V1 .2 – Adrian Pearson (MOD), Patrick Gorman (MOD) and Ian Bailey.

The authors of this UPDM 2.0 specification are therefore greatly indebted to organizations and authors who have contributed to all the DoDAF and MODAF specifications over the years. Some of these are listed above. To list all of them would not be possible.

Subpart II - Language Architecture

This subpart contains the following Clause and subclauses:

- 7. Language Architecture
 - 7.1. Introduction
 - 7.2. Philosophy
 - 7.3. Core Principles
 - 7.4. Profile Structure
 - 7.4.1. Top Level
 - 7.4.2. Middle Level
 - 7.4.3. Low Level
 - 7.5. Representing Stereotype Constraints
 - 7.6. UML Constraint Representation
 - 7.7. Important Areas of the Architecture
 - 7.7.1. Aliases
 - 7.7.2. DoDAF 2.02 Conformance
 - 7.7.3. SoaML Reuse in L0
 - 7.7.4. SysML Reuse in L1
 - 7.7.5. SOPES Reuse in L1

7 Language Architecture

7.1 Introduction

The UPDM specification reuses a subset of UML 2 and provides additional extensions needed to address requirements in the UPDM RFC Mandatory Requirements. We have used those requirements as the basis for this specification. This specification documents the language architecture in terms of the parts of UML 2 that are reused and the extensions to UML 2, as well as defining how to implement UPDM in SysML. This clause explains design principles and how they are applied to define the UPDM language architecture.

7.2 Philosophy

The UPDM was developed using a model-driven approach. A simple description of the work process is:

- The Domain Metamodel (DMM) was created using UML Class models to represent the concepts in DoDAF and MODAF. Concepts common to both DoDAF and MODAF were captured in a Core package.
- The DMM concepts were mapped to corresponding stereotypes in the Profile.
- The Profile was analyzed and refactored to reflect language architecture, tool implementation, and reuse considerations.
- The conformance levels were finalized including mapping to SysML.
- The Profile diagrams, stereotype descriptions, and documentation were added.
- The specification was generated from the profile model.

This approach allowed the team to concentrate on architecture issues rather than documentation production. Consistency was automatically maintained by the UML tool.

The UML tool also enabled traceability to be maintained between the profile and the DMM where every stereotype is linked to the DMM element using UML Abstraction relationship.

7.3 Core Principles

The fundamental design principles for UPDM are:

- **Requirements-driven:** UPDM is intended to satisfy the requirements of the UPDM RFC Mandatory Requirements.
- **Domain meta model (DMM) driven:** The DMM was created first by domain experts and it served as a foundation for profile development.
- **Reuse of existing specifications:** UPDM reuses UML/SysML wherever practical to satisfy the requirements of the UPDM RFC and leverage features from both UML and SysML to provide a robust modeling capability. Consequently, UPDM is intended to be relatively easy to implement for vendors who support UML 2. The UPDM team intended to reuse UPMS. However, since UPMS had not been formally adopted at the time of this specification, a separate service profile in UPDM was developed that used similar concepts, with the intent to replace it with UPMS in the future.
- **Partitioning:** The package is the basic unit of partitioning in this specification. The packages partition the model elements into logical groupings that minimize circular dependencies among them.

- **Compliance levels:** UPDM includes two compliance levels. L0 is a UML only profile and L1 extends L0 to enable seamless integration with SysML modeling and to leverage the features of SysML in UPDM modeling.
- **Interoperability:** UPDM inherits the XMI interchange capability from UML.

7.4 Profile Structure

7.4.1 Top Level

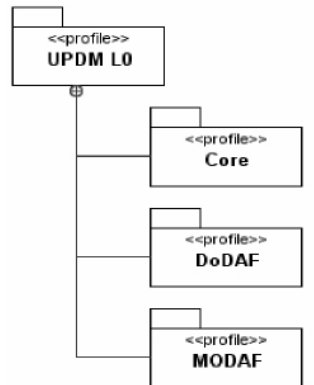

Figure 7:1 - Top Level Profile Structure

All the core elements for UPDM are in the UPDM L0 profile. The UPDM L0 profile has 3 top level profiles:

- **Core** - Elements shared by DoDAF and MODAF
- **DoDAF** - DoDAF specific elements
- **MODAF** - MODAF specific elements

7.4.2 Middle Level

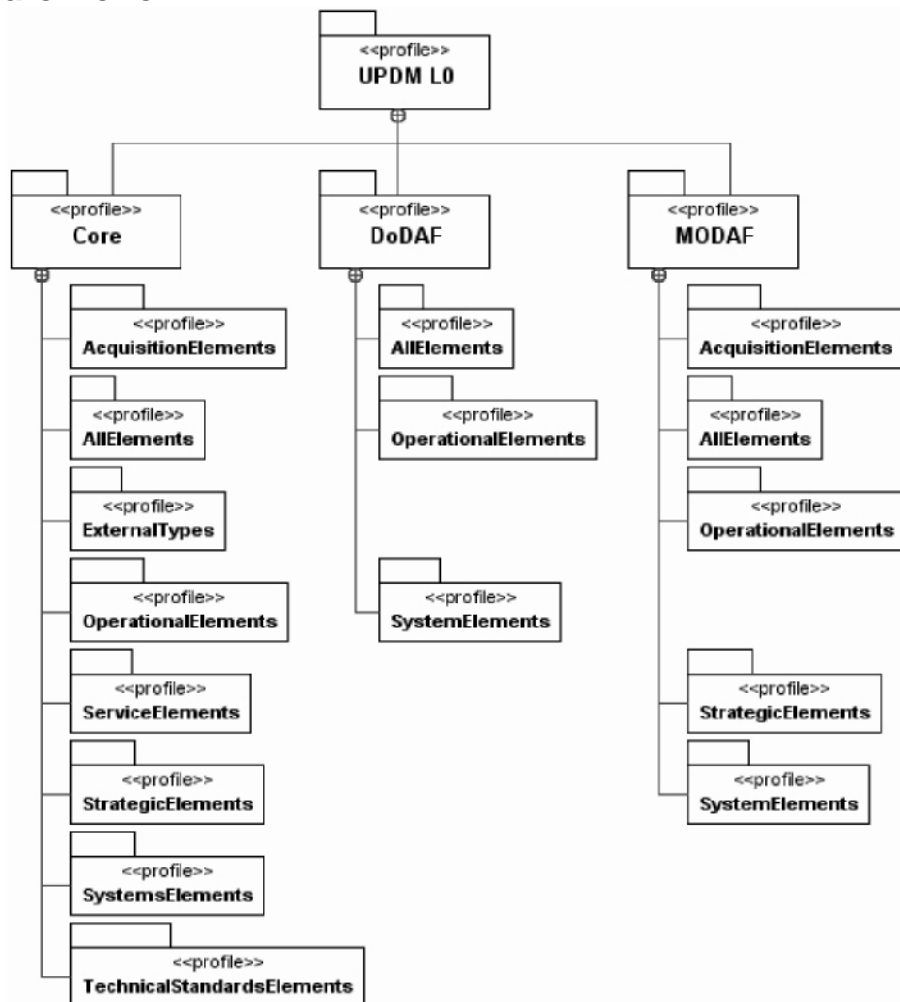

Figure 7:2 - Middle Level Profile Structure

Every top level profile may have the following subprofiles:

- **AllElements** - Cross-cutting elements.
- **AcquisitionElements** - Elements relating to Acquisitions.
- **ExternalTypes** - External types.
 - **OperationalElements** - Elements relating to Operational models.
 - **ServiceElements** - Elements relating to Service models.
 - **StrategicElements** - Elements relating to Strategic models.
 - **SystemsElements** - Elements relating to Systems models.
 - **TechnicalStandardsElements** - Elements relating to Technical Standards models.

7.4.3 Low Level

Each of these subprofiles may be further decomposed into low-level profiles:

- **Behavior** - Stereotypes for modeling behavior
- **Data** - Stereotypes for modeling data
- **Environment** - Stereotypes for modeling environment
- **Flows** - Stereotypes for modeling flows
- **Measurements** - Stereotypes for modeling measurements
- **Milestone** - Stereotypes for modeling milestones
- **Structure** - Stereotypes for modeling structure
- **Views** - Stereotypes for modeling views

7.5 Representing Stereotype Constraints

The profile uses a non-standard notation to represent stereotype constraints in the profile to improve readability of the profile.

«metaclass» dependency

«metaclass» is a stereotype that extends the Dependency metaclass. It is used to specify constrained elements within the profile.

A sample of the «metaclass» dependency is a diagram for stereotype extending the Dependency metaclass. See the following example:

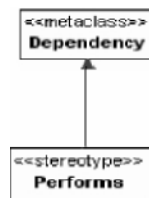

Figure 7:3 - Performs Stereotype

Performs is a stereotype that extends Dependency. The constraint on this stereotype is that its client end must be stereotyped by a Performer and its supplier end must be stereotyped by Activity. But as this constraint is not visible; therefore, the diagram does not communicate the needed information. We are using the "metaclass" dependency to visualize the constraint.

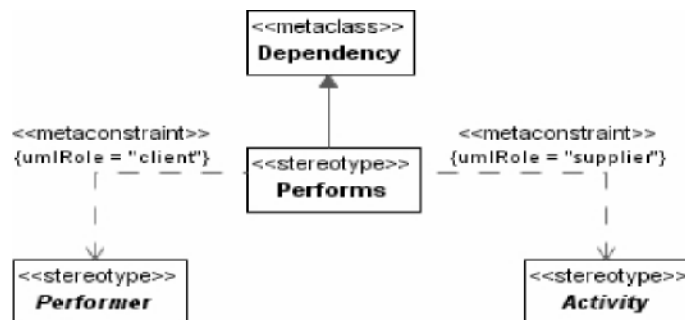

Figure 7:4 - Performs Hierarchy

This diagram should be read as follows:

Performs is a stereotype extending the Dependency metaclass and is used for modeling a relationship between a Performer (or its specializations) and an Activity (or its specializations). A Dependency stereotyped Performs must have its values for the client property stereotyped as Performer, and its values for the supplier property must be stereotyped Activity.

The «metacconstraint» dependency will appear only in the specification diagrams, but not the profile XMI.

Note – When stereotype extends Connector, the stereotype property umlRole has values "end[0].role" and "end[1].role." For example:

This is done because Connector has no direct "linkage" to the connected element; it links to the Connector Ends, which references the linked element. So, end[n] gives the reference to the ConnectorEnd, and role gives the reference to the linked element.

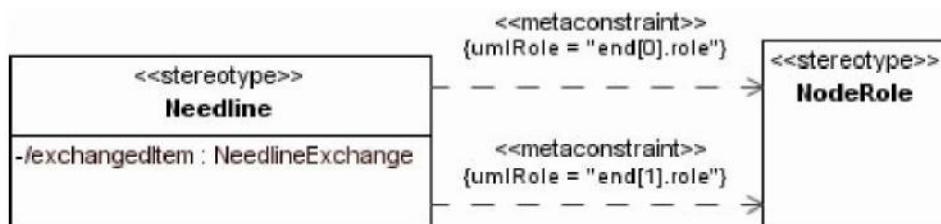

Figure 7:5 - Connector Extension "metarerelationship" dependency

"metarerelationship" is a stereotype for dependency, showing that certain domain concepts will be implemented using regular UML relationships.

For example: A Capability may depend on other Capabilities, but this concept cannot be visualized on the diagram:

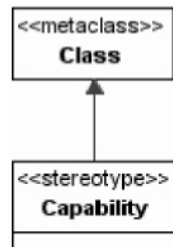

Figure 7:6 - Capabilities Generalization

We are using the "metarerelationship" dependency to visualize the dependency concept.

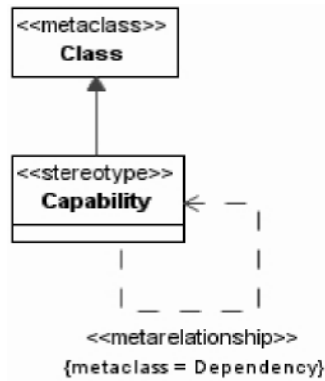

Figure 7:7 - Visualizing «metarelationship»

This diagram should be read as follows:

Capability may have other Capabilities related to it, using the UML Dependency metaclass.

The "metarelationship" dependency will appear only in the specification diagrams, but not the profile XMI. **"stereotyped relationship" dependency**

The "metaconstraint" dependency creates a good way to show the constrained ends of the stereotyped relationship, however, it also creates some overhead when showing the relationship between two stereotypes.

For example, the diagram needs to show that Node may require a Capability.



Figure 7:8 - UML Dependency metaclass

The "stereotyped relationship" dependency is used as follows:

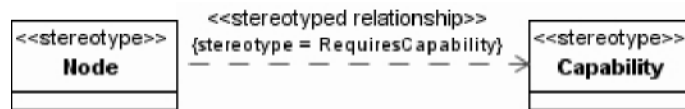

Figure 7:9 - "stereotyped relationship" dependency

The "stereotyped relationship" dependency will appear only in the specification diagrams, but not the profile XMI.

7.6 UML Constraint Representation

The specification uses the Object Constraint Language (OCL), as defined in Clause 6, "Object Constraint Language Specification" of the UML specification, for expressing well-formedness rules. The following conventions are used to promote readability:

- Self - which can be omitted as a reference to the metaclass defining the context of the invariant, has been kept for clarity. UML Infrastructure Specification, v2. 1.2 25

- In expressions where a collection is iterated, an iterator is used for clarity, even when formally unnecessary. The type of the iterator is usually omitted, but included when it adds to understanding.
- The 'collect' operation is left implicit where this is practical.
- The context part of an OCL constraint is not included explicitly, as it is well defined in the sub clause where the constraint appears.

The OCL constraints are stored with the profile and can be interchanged via XMI standard. Below is the pattern to represent constraint for stereotyped relationship in OCL as per UML 2.1:

- To constraint the client of the stereotyped relationship that should be a particular stereotyped element:
self.client->forAll(getAppliedStereotype(CLIENT_STEREOTYPE)-> notEmpty()
- To constraint the supplier of the stereotyped relationship that should be a particular stereotyped element:
self.supplier->forAll(getAppliedStereotype(SUPPLIER_STEREOTYPE)-> notEmpty()
- The constraint represented in Figure 7.7 can be represented in OCL as follows: self.client->forAll(getAppliedStereotype('UPDM: :AllElements: :Behavior : :Performer')-> notEmpty())self.supplier->forAll(getAppliedStereotype("UPDM: :AllElements: :Behavior : :Activity')->notEmpty())

7.7 Important Areas of the Architecture

7.7.1 Aliases

Although there are similar concepts in DoDAF and MODAF, they are not named the same. To keep interoperability and to fit the needs of both audiences, the UPDM specification used generalizations as a way to alias concepts.

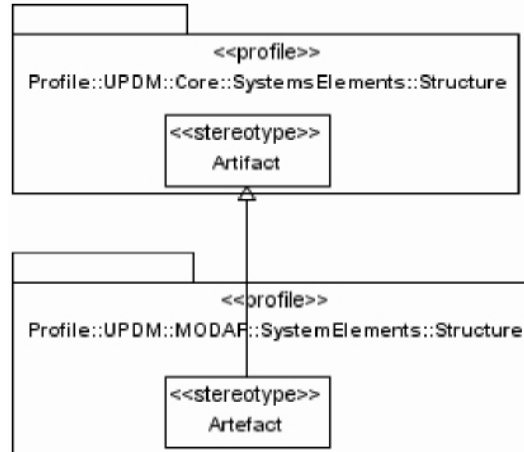

Figure 7:10 - Aliases

7.7.2 DoDAF 2.02 Conformance

Compliance with UPDM 2.0 Profile including metadata should assist the tool vendor in adhering to DoDAF 2.02 because the UPDM 2.0 Core and DoDAF-specific metadata models in UPDM 2.0 adhere to the metadata model inherent in DoDAF 2.02 Conceptual and Logical data models. In developing the UPDM 2.0, domain meta-modelers have also consulted the corresponding Physical data model in DoDAF 2.02 and to resolve questions of general conformance with enterprise-level architectural elements. Nevertheless, tool vendors are advised to consult DoDAF Version 2.02 (especially Volume I, page 2-6; Volume II, page 2-6; and Volume III, page 1-2) before claiming DoDAF 2.02 conformance. While conformance with UPDM 2.0 Core and DoDAF-specifics should greatly facilitate conformance with DoDAF 2.02, each tool vendor is still responsible for the tool's ultimate conformance with the documented architecture framework.

Compliance with UPDM 2.0 Profile including metadata should assist the tool vendor in adhering to DoDAF 2.02 because the UPDM 2.0 Core and DoDAF-specific metadata models in UPDM 2.02 adhere to the metadata model inherent in DoDAF 2.02 Conceptual and Logical data models. In developing the UPDM 2.0, domain meta-modelers have also consulted the corresponding Physical data model in DoDAF 2.02 to resolve questions of general conformance with enterprise-level architectural elements. Nevertheless, tool vendors are advised to consult DoDAF Version 2.02 before claiming DoDAF 2.02 compliance.

The DoD-CIO has clarified in a Decision Brief of 12 Jan 11 that it does not expect UPDM 2.0 to export models in PES, nor to provide an implementation of 4D (geo-spatial-temporal modeling) including a global implementation of Whole- Part and Temporal-Whole-Part for all UPDM elements (classes/objects).

The UPDM Profile to DoDAF Metamodel Compliance Matrix has been published as non-normative Annex C of the specification to aid tool vendors in their claims to DoDAF Level 2 Conformance. This matrix should also facilitate upgrades to Level 3 and 4 of DoDAF Conformance in future versions of UPDM.

7.7.3 SoaML Reuse in L0

SoaML is quickly becoming the standard modeling choice for capturing and creating service oriented architectures. By importing the SoaML stereotypes, a UPDM model gains access to these powerful features. They can be used and viewed in a UPDM model using the standard SoaML approach and as such have not been further documented.

7.7.4 SysML Reuse in L1

Defining an architectural framework in UPDM provides the highest level abstraction of what will one day become integrated pieces of hardware and software. Being able to trace from the architectural framework to the various levels of implementation is critical for ensuring the initial goals have been reached. By including the full SysML profile inside UPDM, a modeler can have all of the architectural, system, and software design in the same place. This provides huge benefits in analysis, cross abstraction level communication, traceability, and reuse. As in L0, all of the stereotypes contained in SysML can be used and displayed using standard SysML approaches while still being able to be connected to UPDM elements such as Nodes and Artifacts.

7.7.5 SOPES Reuse in L1

SOPES IEDM use of UML is becoming a standards based model for specifying and describing the rules governing the aggregation, marshalling, and processing of information across system interfaces. By importing the SOPES stereotypes, a UPDM 2.0 models gains higher fidelity in the specification and design of information exchange requirements. Additional information on the SOPES modeling approach can be found in <http://www.omg.org/spec/SOPES/>.

Subpart III - UPDM Profile

This subpart contains the following Clause and sub clauses:

- DoDAF Class Library
- UPDM Profile

8. Part II – UPDM Profile

UPDM L1 contains UPDM L0 and imports the entire SysML profile. This compliance level contains a set of constraints that specify which SysML stereotypes are applied to the L0 elements. The use of this compliance level is intended to provide more seamless integration with system modeling using SysML and to be able to fully leverage the capabilities of SysML in UPDM.

8.1 DoDAF Class Library

A library of Measurements, MeasurementSets and SecurityAttributesGroup, derived from DoDAF.

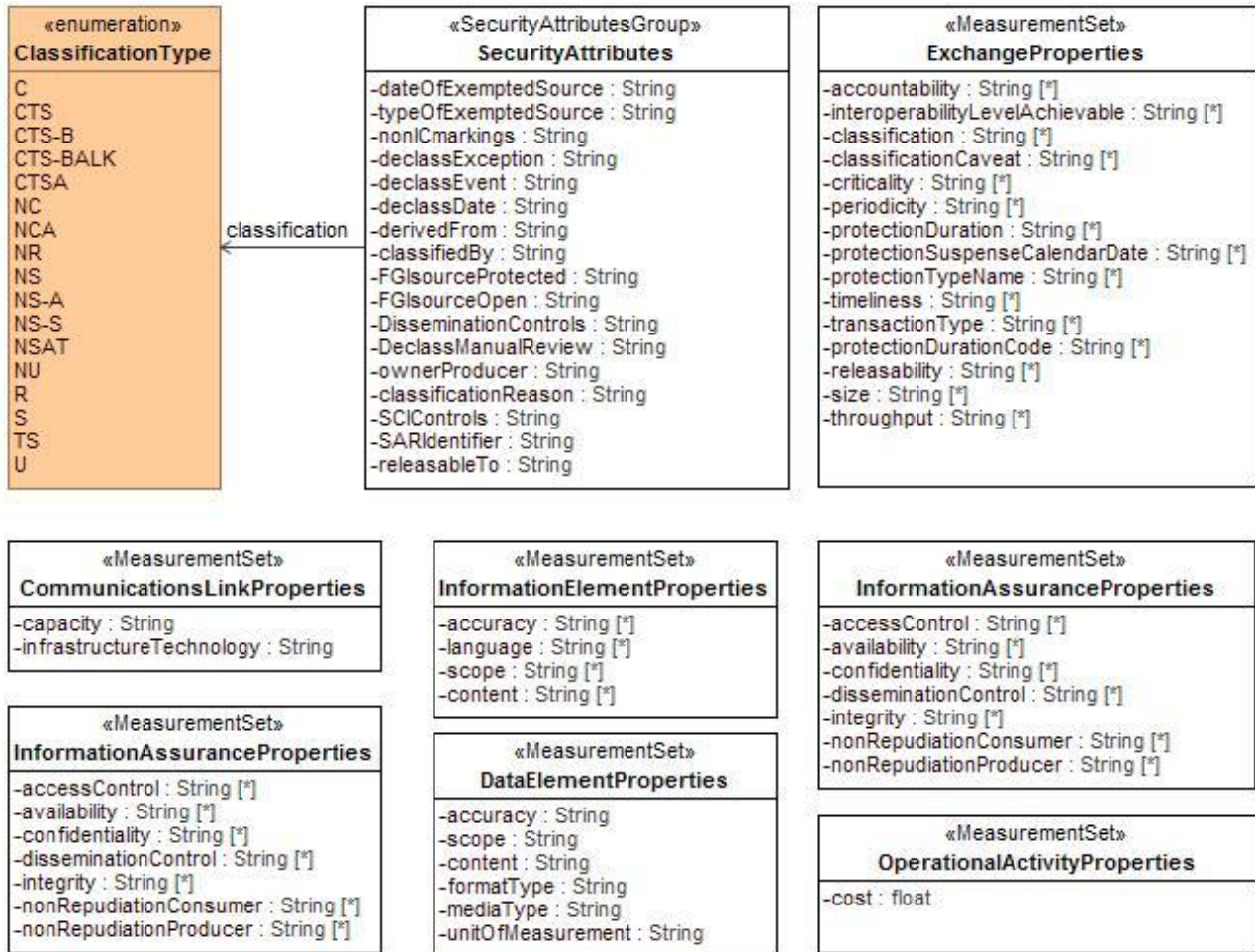

Figure 8:1 - DoDAF Class Library

8.1.1 ClassificationType

Enumeration of types of security classification, derived from DoDAF.

- **Enumeration Literals**

The following are enumeration literals for ClassificationType:

- C - Confidential
- CTS - COSMIC TOP SECRET
- CTS-B - COSMIC TOP SECRET - BOHEMIA
- CTS-BALK - COSMIC TOP SECRET - BALK
- CTSA - COSMIC TOP SECRET ATOMAL
- NC - NATO Confidential
- NCA - NATO Confidential Atomal
- NR - NATO Restricted (similar to US For Official Use only)
- NS - NATO Secret
- NS-A - NATO Atomal
- NS-S - NATO Secret
- NSAT - NATO Secret Atomal
- NU - NATO Unclassified
- R - Restricted Data (RD) US Nuclear Information OR FOR OFFICIAL USE ONLY
- S - Secret
- TS - Top Secret
- U - Unclassified

8.1.2 CommunicationsLinkProperties

Properties detailing aspects of Resource Interfaces.

8.1.3 DataElementProperties

Properties detailing the aspects of a DataElement.

8.1.4 ExchangeProperties

Properties detailing aspects of exchange for Operational Exchange and/or Resource Interaction.

8.1.5 InformationAssuranceProperties

Properties indicating the assurance of a piece of information.

8.1.6 InformationElementProperties

Predefined additional DoDAF properties for InformationElement.

8.1.7 OperationalActivityProperties

Properties detailing aspects OperationalActivities.

8.1.8 SecurityAttributes

W3C XML Schema for the Intelligence Community Metadata Standard for Information Security Marking (IC-ISM), which is part of the IC standards for Information Assurance.

8.2 UPDM L1

UPDM L1 contains UPDM L0 and imports the entire SysML profile. This compliance level contains a set of constraints that specify which SysML stereotypes are applied to the L0 elements. The use of this compliance level is intended to provide more seamless integration with system modeling using SysML and to be able to fully leverage the capabilities of SysML in UPDM.

Capability

- **context Class inv:**
`UPDM::Capability::allInstances() ->exists(n|n.base_Class=self) implies SysML::Block::allInstances() ->exists(b| b.base_Class = self)`

CapabilityConfiguration

- **context Class inv:**
`UPDM::CapabilityConfiguration::allInstances() ->exists(n|n.base_Class=self) implies SysML::Block::allInstances() ->exists(b| b.base_Class = self)`

Climate

- **context DataType inv:**
`UPDM::Climate::allInstances() ->exists(n|n.base_Class=self) implies SysML::ValueType::allInstances() ->exists(b| b.base_Class = self)`

Commands

- **context InformationFlow inv:**
`UPDM::Commands::allInstances() ->exists(n|n.base_Class=self) implies SysML::ItemFlow::allInstances() ->exists(b| b.base_Class = self)`

Condition

- **context DataType inv:**
`UPDM::Condition::allInstances() ->exists(n|n.base_Class=self) implies SysML::ValueType::allInstances() ->exists(b| b.base_Class = self)`

Control

- **context InformationFlow inv:**
`UPDM::Control::allInstances() ->exists(n|n.base_Class=self) implies SysML::ItemFlow::allInstances() ->exists(b| b.base_Class = self)`

Energy

- **context Class inv:**
`UPDM::Energy::allInstances() ->exists(n|n.base_Class=self) implies SysML::Block::allInstances() ->exists(b| b.base_Class = self)`

EnterpriseGoal

- **context Class inv:**
`UPDM::EnterpriseGoal::allInstances() ->exists(n|n.base_Class=self)`

`implies`
`SysML::Requirement::allInstances () ->exists (b| b.base_Class = self)`

EntityItem

- `context Class inv:`
`UPDM::EntityItem::allInstances () ->exists (n|n.base_Class=self) implies`
`SysML::Block::allInstances () ->exists (b| b.base_Class = self)`

Environment

- `context DataType inv:`
`UPDM::Environment::allInstances () ->exists (n|n.base_Class=self) implies`
`SysML::Block::allInstances () ->exists (b| b.base_Class = self)`

ExchangeElement

- `context DataType inv:`
`UPDM::ExchangeElement::allInstances () ->exists (n|n.base_Class=self)`
`implies`
`SysML::ValueType::allInstances () ->exists (b| b.base_Class = self)`

ExternalType

- `context Class inv:`
`UPDM::ExternalType::allInstances () ->exists (n|n.base_Class=self)`
`implies`
`SysML::Block::allInstances () ->exists (b| b.base_Class = self)`

GeoPoliticalExtentType

- `context DataType inv:`
`UPDM::GeoPoliticalExtentType::allInstances () -`
`>exists (n|n.base_Class=self) implies`
`SysML::ValueType::allInstances () ->exists (b| b.base_Class = self)`

HighLevelOperationalConcept

- `context Class inv:`
`UPDM::HighLevelOperationalConcept::allInstances () -`
`>exists (n|n.base_Class=self) implies`
`SysML::Block::allInstances () ->exists (b| b.base_Class = self)`

LightCondition

- `context DataType inv:`
`UPDM::LightCondition::allInstances () ->exists (n|n.base_Class=self)`
`implies`
`SysML::ValueType::allInstances () ->exists (b| b.base_Class = self)`

LocationType

- `context DataType inv:`
`UPDM::LocationType::allInstances () ->exists (n|n.base_Class=self)`
`implies`
`SysML::ValueType::allInstances () ->exists (b| b.base_Class = self)`

LogicalArchitecture

- `context Class inv:`
`UPDM::LogicalArchitecture::allInstances () ->exists (n|n.base_Class=self)`
`implies`
`SysML::Block::allInstances () ->exists (b| b.base_Class = self)`

Materiel

- context Class inv:
UPDM::Materiel::allInstances () ->exists (n|n.base_Class=self) implies
SysML::Block::allInstances () ->exists (b| b.base_Class = self)

MeasurementSet

- context DataType inv:
UPDM::MeasurementSet::allInstances () ->exists (n|n.base_Class=self)
implies
SysML::ValueType::allInstances () ->exists (b| b.base_Class = self)

MeasureType

- context DataType inv:
UPDM::MeasureType::allInstances () ->exists (n|n.base_Class=self) implies
SysML::ValueType::allInstances () ->exists (b| b.base_Class = self)

Node

- context Class inv:
UPDM::Node::allInstances () ->exists (n|n.base_Class=self) implies
SysML::Block::allInstances () ->exists (b| b.base_Class = self)

NodePort

- context Port inv:
UPDM::NodePort::allInstances () ->exists (n|n.base_Class=self) implies
SysML::FlowPort::allInstances () ->exists (b| b.base_Class = self)

OperationalExchange

- context InformationFlow inv:
UPDM::OperationalExchange::allInstances () ->exists (n|n.base_Class=self)
implies
SysML::ItemFlow::allInstances () ->exists (b| b.base_Class = self)

Organization

- context Class inv:
UPDM::Organization::allInstances () ->exists (n|n.base_Class=self)
implies
SysML::Block::allInstances () ->exists (b| b.base_Class = self)

OrganizationType

- context Class inv:
UPDM::OrganizationType::allInstances () ->exists (n|n.base_Class=self)
implies
SysML::Block::allInstances () ->exists (b| b.base_Class = self)

Performer

- context Class inv:
UPDM::Performer::allInstances () ->exists (n|n.base_Class=self) implies
SysML::Block::allInstances () ->exists (b| b.base_Class = self)

PersonType

- context Class inv:
UPDM::PersonType::allInstances () ->exists (n|n.base_Class=self) implies
SysML::Block::allInstances () ->exists (b| b.base_Class = self)

PhysicalArchitecture

- context Class inv:
UPDM::PhysicalArchitecture::allInstances () -
>exists (n|n.base_Class=self) implies
SysML::Block::allInstances () ->exists (b| b.base_Class = self)

Post

- context Class inv:
UPDM::Post::allInstances() ->exists(n|n.base_Class=self) implies
SysML::Block::allInstances() ->exists(b| b.base_Class = self)

ResourceArtifact

- context Class inv:
UPDM::ResourceArtifact::allInstances() ->exists(n|n.base_Class=self)
implies
SysML::Block::allInstances() ->exists(b| b.base_Class = self)

ResourceInteraction

- context InformationFlow inv:
UPDM::ResourceInteraction::allInstances() ->exists(n|n.base_Class=self)
implies
SysML::ItemFlow::allInstances() ->exists(b| b.base_Class = self)

ResourcePort

- context Port inv:
UPDM::ResourcePort::allInstances() ->exists(n|n.base_Class=self)
implies
SysML::FlowPort::allInstances() ->exists(b| b.base_Class = self)

Responsibility

- context Class inv:
UPDM::Responsibility::allInstances() ->exists(n|n.base_Class=self)
implies
SysML::Block::allInstances() ->exists(b| b.base_Class = self)

RoleType

- context Class inv:
UPDM::RoleType::allInstances() ->exists(n|n.base_Class=self) implies
SysML::Block::allInstances() ->exists(b| b.base_Class = self)

SecurityAttributesGroup

- context DataType inv:
UPDM::SecurityAttributesGroup::allInstances() -
>exists(n|n.base_Class=self) implies
SysML::ValueType::allInstances() ->exists(b| b.base_Class = self)

SecurityDomain

- context Class inv:
UPDM::Node::allInstances() ->exists(n|n.base_Class=self) implies
SysML::Block::allInstances() ->exists(b| b.base_Class = self)

ServiceAccess

- context Class inv:
UPDM::ServiceAccess::allInstances() ->exists(n|n.base_Class=self)
implies
SysML::Block::allInstances() ->exists(b| b.base_Class = self)

Software

- context Class inv:
UPDM::Software::allInstances() ->exists(n|n.base_Class=self) implies
SysML::Block::allInstances() ->exists(b| b.base_Class = self)

System

- context Class inv:
UPDM::System::allInstances ()->exists (n|n.base_Class=self) implies
SysML::Block::allInstances ()->exists (b| b.base_Class = self)

8.2.1 UPDM L1::UPDM L0

UPDM L0 contains all the Core, DoDAF and MODAF elements, and imports parts of SysML – Requirements and ModelElements namely. This compliance level is primarily based on UML and reuse of a minimum of SysML elements. This includes Requirements and Views/Viewpoints. As one of the core principles is reuse, cloning/recreating of these existing SysML structures was considered as inappropriate.

8.2.1.1 UPDM L1::UPDM L0::Core

The Core contains most of the elements of UPDM profile. These elements are common to both DoDAF and MoDAF or are critical to a complete model of core concepts. The Core is always associated with either the DoDAF or MoDAF profiles.

If desired, there is no prohibition of using both MoDAF, DoDAF and Core should the end-user desire to use some or all of the concepts represented.

8.2.1.1.1 UPDM L1::UPDM L0::Core::AcquisitionElements

The AcquisitionElements describe project details, including dependencies between projects and capability integration. These Views guide the acquisition and fielding processes.

8.2.1.1.1.1 UPDM L1::UPDM L0::Core::AcquisitionElements::Milestone

Milestone elements from the acquisition section of the profile.

8.2.1.1.1.1.1 ActualProject

MODAF: (MODAF::Project): A time-limited endeavour to create a specific set of products or services.

DoDAF: (DoDAF::Project): A temporary endeavor undertaken to create Resources or Desired Effects.

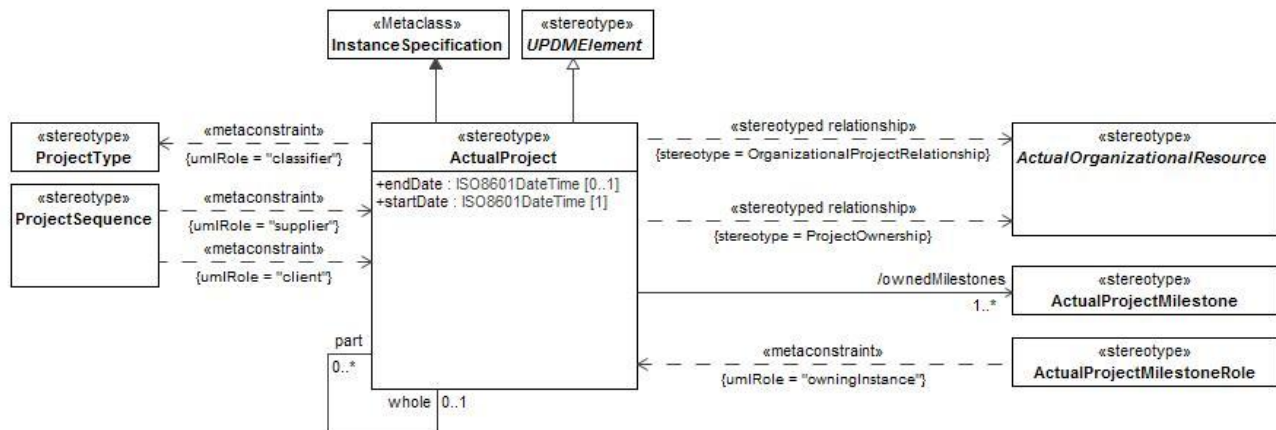

Figure 8:2 - ActualProject

- Constraints

The following are constraints for ActualProject:

- `ActualProject.classifier` - Classifier property value must be stereotyped `«Project»` or its specializations.

- **Attributes**

The following are attributes for ActualProject:

- `endDate` : ISO8601DateTime[0..1] - End time for this Project.
- `ownedMilestones` : ActualProjectMilestone[1..*] - Milestones associates with this project.
- `part` : ActualProject[0..*] - Sub-projects.
- `startDate` : ISO8601DateTime[1] - Start time for this Project.
- `whole` : ActualProject[0..1] - Parent project.

- **Extensions**

The following metaclasses are extended by ActualProject:

- InstanceSpecification

- **Specializations**

The ActualProject element is a specialization of:

- UPDMElement

8.2.1.1.1.2 ActualProjectMilestoneRole

UPDM: An instance of a ProjectMilestoneRole in the context of an ActualProject.

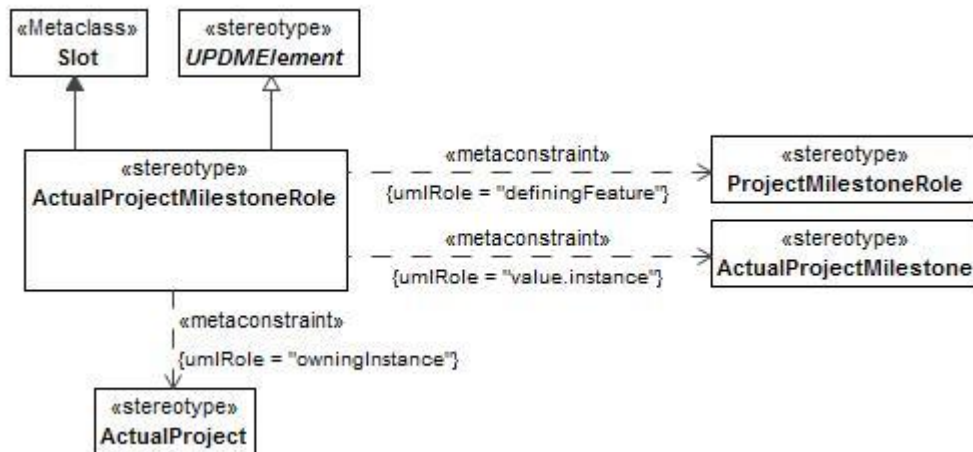

Figure 8:3 - ActualProjectMilestoneRole

- **Constraints**

The following are constraints for ActualProjectMilestoneRole:

- `ActualProjectMilestoneRole.definingFeature` - Value for definingFeature property has to be stereotyped `«ProjectMilestoneRole»` or its specializations.

- `ActualProjectMilestoneRole.owningInstance` - Value for `owningInstance` property has to be stereotyped `«ActualProject»` or its specializations.
- **Extensions**

The following metaclasses are extended by `ActualProjectMilestoneRole`:

- Slot

- **Specializations**

The `ActualProjectMilestoneRole` element is a specialization of:

- `UPDMElement`

8.2.1.1.1.3 OrganizationalProjectRelationship

MODAF: A relationship between an `ActualOrganization` and a `Project`.

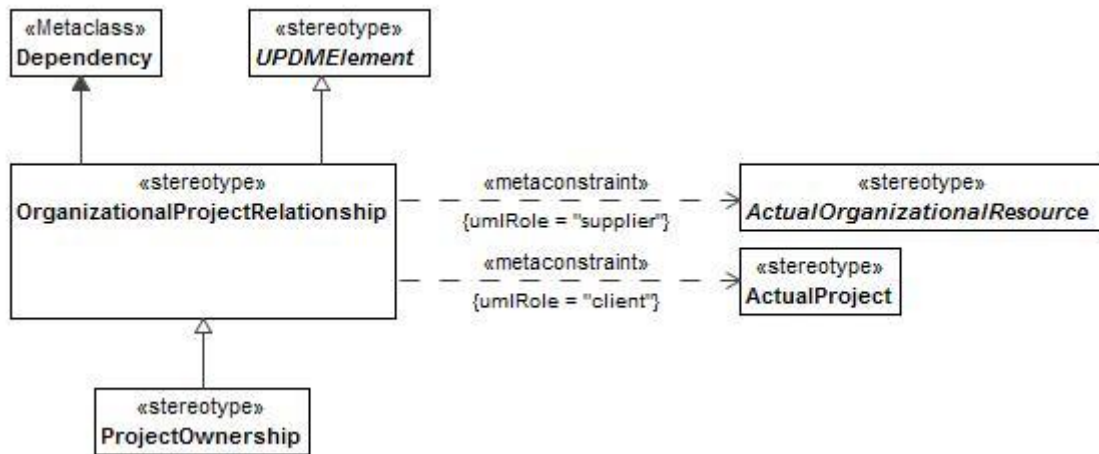

Figure 8:4 - OrganizationalProjectRelationship

- **Constraints**

The following are constraints for `OrganizationalProjectRelationship`:

- `OrganizationalProjectRelationship.client` - Value for the `client` property must be stereotyped `«ActualProject»` or its specializations.
- `OrganizationalProjectRelationship.supplier` - Value for the `supplier` property must be stereotyped a specialization of `«ActualOrganizationalResource»`.

- **Extensions**

The following metaclasses are extended by `OrganizationalProjectRelationship`:

- `Dependency`

- **Specializations**

The `OrganizationalProjectRelationship` element is a specialization of:

- `UPDMElement`

8.2.1.1.1.1.4 ProjectMilestoneRole

UPDM: The role played by a ProjectMilestone in the context of an ActualProjectMilestone.

MODAF: NA

DoDAF: NA

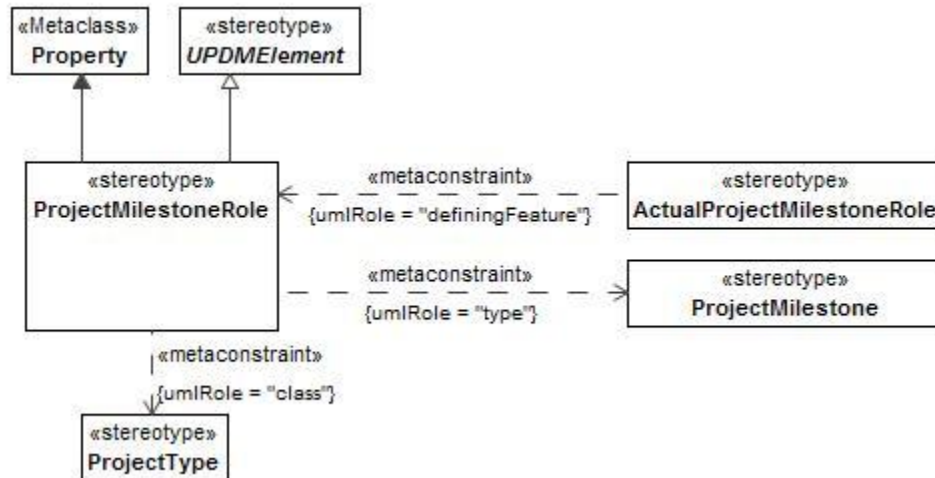

Figure 8:5 - ProjectMilestoneRole

- **Constraints**

The following are constraints for ProjectMilestoneRole:

- **ProjectMilestoneRole.class** - Value for the class property must be stereotyped **«Project»** or its specializations.
- **ProjectMilestoneRole.type** - Value for the type property must be stereotyped **«ProjectMilestone»** or its specializations.

- **Extensions**

The following metaclasses are extended by ProjectMilestoneRole:

- Property

- **Specializations**

The ProjectMilestoneRole element is a specialization of:

- UPDMElement

8.2.1.1.1.1.5 ProjectType

MODAF: A Project (MODAF::ProjectType) is used to define a category of project: For example, "Programme," "Acquisition Project," or "Training Programme."

DoDAF: NA (only Individual Project in DoDAF).

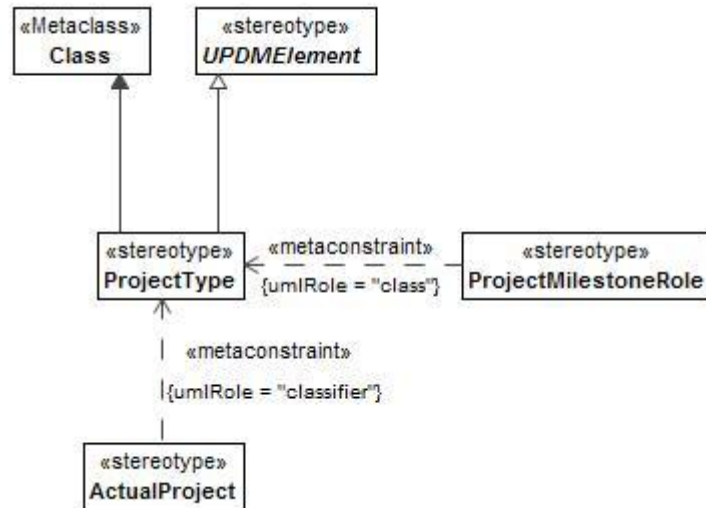

Figure 8:6 - ProjectType

- **Constraints**

The following are constraints for ProjectType:

- **Project.ownedAttribute** - Values for ownedAttribute property must be stereotyped «ProjectMilestoneRole» or its specializations.

- **Extensions**

The following metaclasses are extended by ProjectType:

- Class

- **Specializations**

The ProjectType element is a specialization of:

- UPDMElement
- Desirer

8.2.1.1.2 UPDM L1::UPDM L0::Core::AllElements

The AllElements are elements that are part of the All View. The All-Views (AVs) provide an overarching description of the architecture, its scope, ownership, timeframe, and all of the other meta data that is required in order to effectively search and query architectural models. They also provide a place to record any findings arising from the architecting process. The AVs include a dictionary of the terms used in the construction of the architecture – which helps others fully understand it’s meaning at a later date. Since the AVs provide critical information for the future access and exploitation of an architectural model their population is essential whenever an architecture is created or modified. The AVs provide a critical input into the processes that provide architectural governance.

8.2.1.1.2.1 Exchange

UPDM: Abstract grouping for interactions that exchange messages.

MODAF: NA

DoDAF: NA

Note: Exchange is abstract.

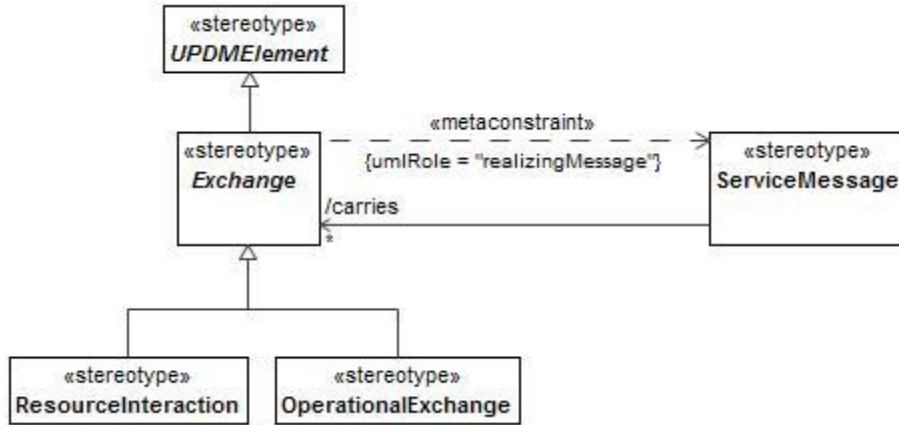

Figure 8:7 - Exchange

- Specializations

The Exchange element is a specialization of:

- UPDMElement

8.2.1.1.2.2 UPDMElement

UPDM Artifact: Super type for many of the UPDM elements. It provides a means of extending UPDM elements in a common way. With links to the measurement set, it also allows quantitative metrics to be associated with structural and behavioral elements.

Note: UPDMElement is abstract.

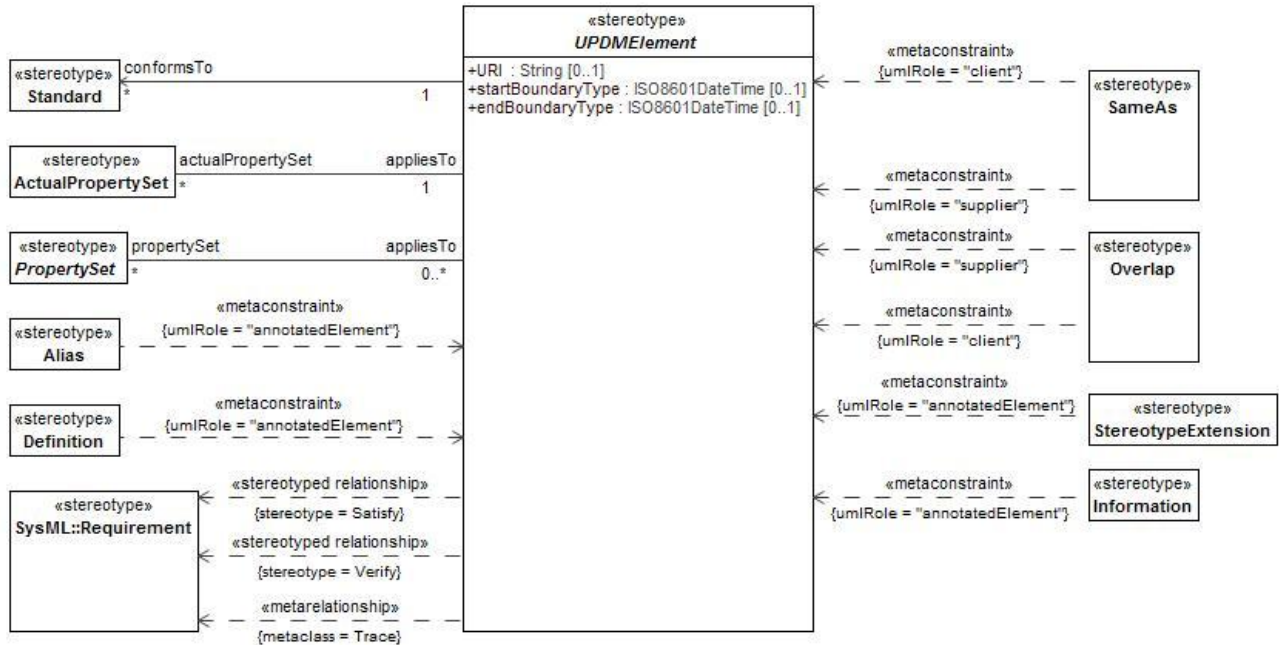

Figure 8:8 - UPDMElement

- **Attributes**

The following are attributes for UPDMElement:

- actualPropertySet : ActualPropertySet[*] - The actual measurements to which the element must conform.
- conformsTo : Standard[*] - Standard that this UPDM element is conforming to.
- endBoundaryType : ISO8601DateTime[0..1] - End time of boundary.
- propertySet : PropertySet[*] - Types of measurements corresponding to the actual measurements.
- startBoundaryType : ISO8601DateTime[0..1] - Start time of a boundary.
- URI : String[0..1] - Unique identifier for the element.

8.2.1.1.2.3 UPDM L1::UPDM L0::Core::AllElements::Behavior

The behavioral portion of the AllElements profile.

8.2.1.1.2.3.1 Activity

UPDM: An abstract element that represents a behavior (i.e., a Function or OperationalActivity) that can be performed by a Performer.

MODAF: NA

DoDAF: Work, not specific to a single organization, weapon system or individual that transforms inputs (Resources) into outputs (Resources) or changes their state.

Note: Activity is abstract.

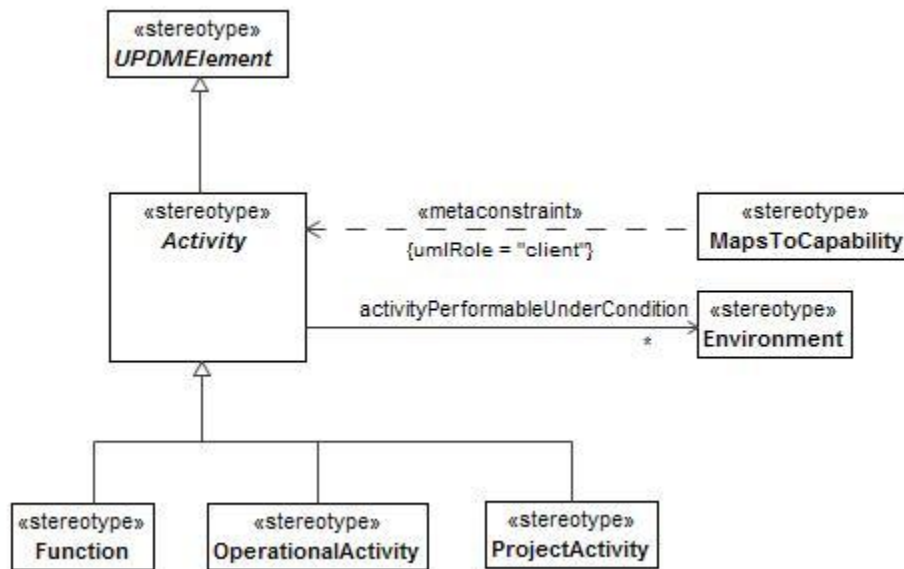

Figure 8:9 - Activity

- **Attributes**

The following are attributes for Activity:

- activityPerformableUnderCondition: Environment[*] - The environment under which an activity is performed.

- **Specializations**

The Activity element is a specialization of:

- UPDMElement
- Desirer

8.2.1.1.2.3.2 CapableElement

UPDM: An abstract element that represents a structural element that can perform behaviors (i.e., PerformedActivity).

DoDAF: NA

Note: CapableElement is abstract.

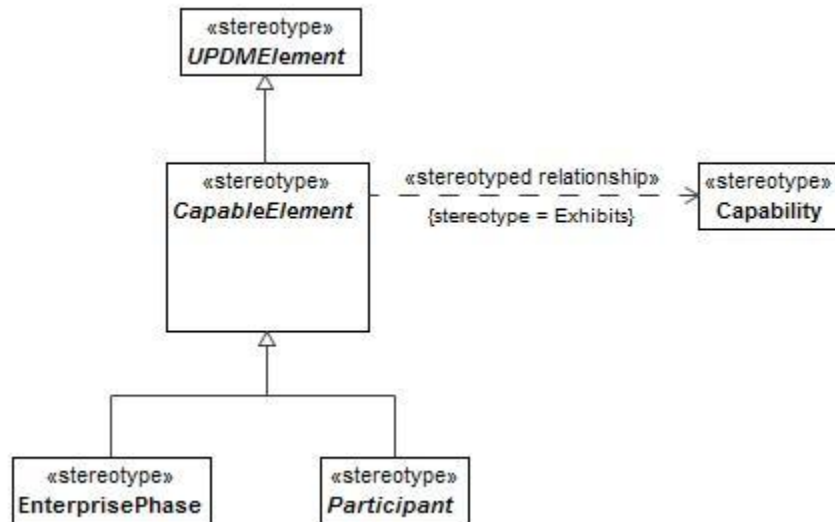

Figure 8:10 - CapableElement

- **Specializations**

The CapableElement element is a specialization of:

- UPDMElement

8.2.1.1.2.3.3 Implements

UPDM: Tuple defining the relationship between systems and service elements and operational elements.

MODAF: ActivityToFunctionMapping, Asserts that a Function (at least in part) performs or assists in the conducting of an OperationalActivity.

DoDAF: N/A

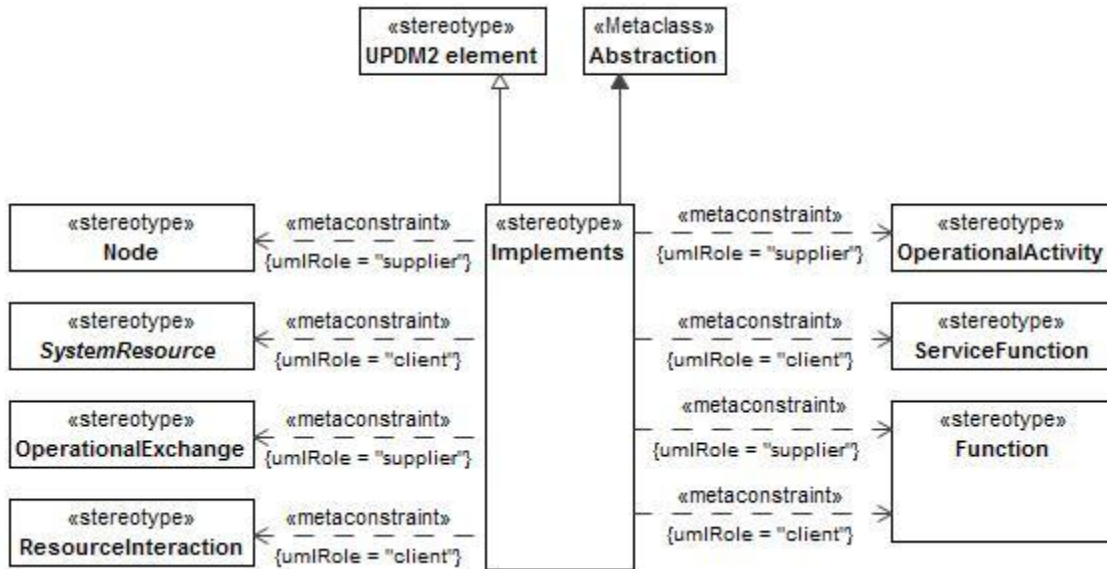

Figure 8:11 - Implements

- **Constraints**

The following are constraints for Implements:

- **Implements.client** - Values for the client property must be stereotyped «SystemResource», «ResourceInteraction», «Function», «ServiceFunction» or their specializations.
- **Implements.supplier** - Values for the supplier property must be stereotyped «Node», «OperationalActivity», «OperationalExchange», «Function» or their specializations.

- **Extensions**

The following metaclasses are extended by Implements:

- Abstraction

- **Specializations**

The Implements element is a specialization of:

- UPDM2 element

8.2.1.1.2.3.4 IsCapableOfPerforming

UPDM: Links a Performer to the behavior that it can perform.

DoDAF: The Performs (DoDAF::activityPerformedByPerformer) relationship is an overlap between a Performer and a PerformedActivity (DoDAF::Activity) wherein the activity is performed by the Performer.

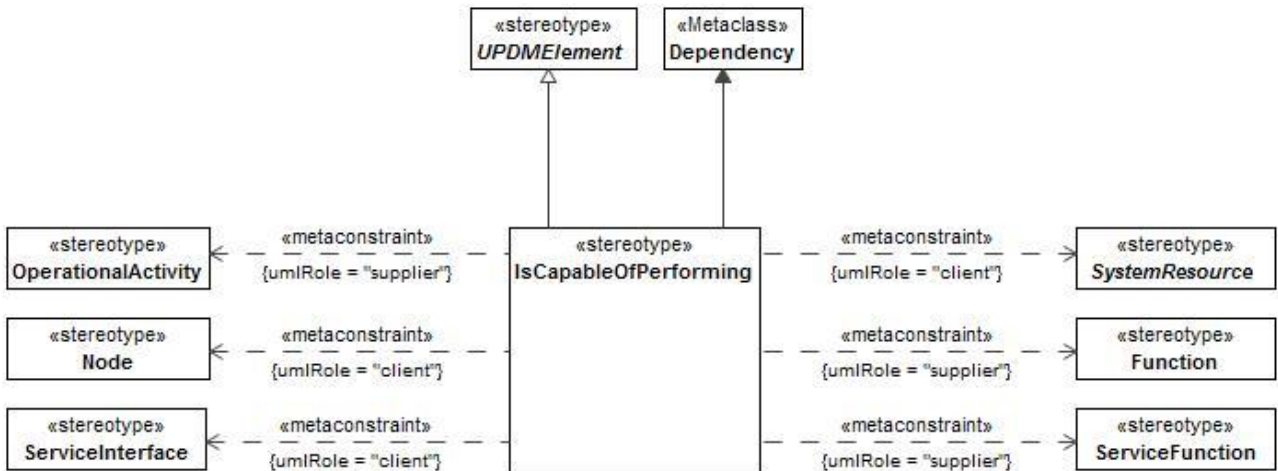

Figure 8:12 - IsCapableOfPerforming

- **Constraints**

The following are constraints for IsCapableOfPerforming:

- IsCapableOfPerforming.client - Values for the client property must be stereotyped «Node», «SystemResource», «ServiceInterface» or their specializations.
- IsCapableOfPerforming.supplier - Values for the supplier property must be stereotyped «OperationalActivity», «Function», «ServiceFunction» or their specializations.

- **Extensions**

The following metaclasses are extended by IsCapableOfPerforming:

- Dependency

- **Specializations**

The IsCapableOfPerforming element is a specialization of:

- UPDMElement

8.2.1.1.2.4 UPDM L1::UPDM L0::Core::AllElements::Environment

The environmental aspects of the AllElements profile.

8.2.1.1.2.4.1 ActualLocation

MODAF: A PhysicalLocation (MODAF::ActualLocation) is a location anywhere on the earth. The means of describing the location is a string (locationDescription). The information contained in that string is governed by the taxonomy reference - e.g., if the PhysicalLocation is a “GPS reference,” the string will contain the GPS coordinates. NOTE: This has been extended in UPDM to include non-earth locations.

DoDAF: All subtypes of << IndividualType>> Location, such as Facility, Site, etc.

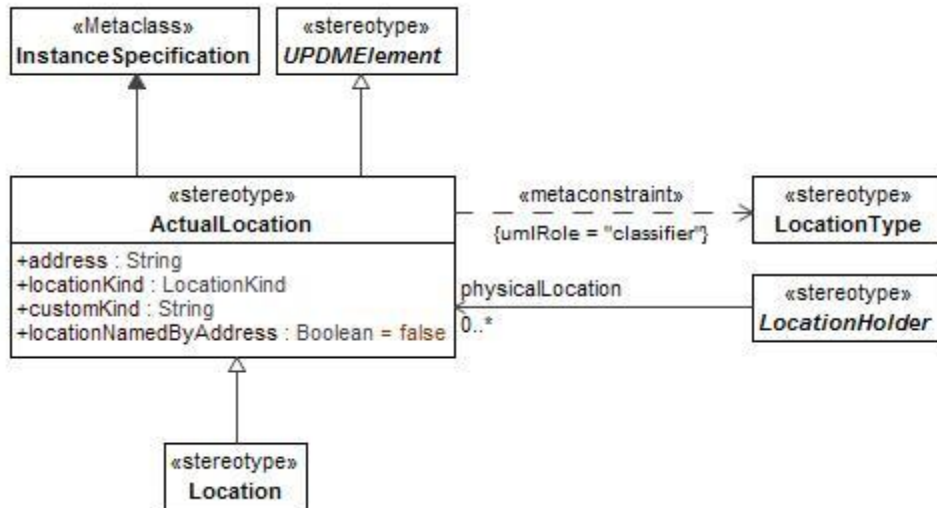

Figure 8:13 - ActualLocation

- **Constraints**

The following are constraints for ActualLocation:

- **ActualLocation.classifier** - Classifier property value must be stereotyped «LocationType» or its specializations.

- **Attributes**

The following are attributes for ActualLocation:

- address : String[] - String describing the address of the actual location, i.e., "1600 Pennsylvania avenue" describes the address of the actual location "The White House."
- customKind : String[] - String describing a location kind that is not on the enumerated list.
- locationKind : LocationKind[] - Enumerated value describing the kind of location.
- locationNamedByAddress : Boolean[] - Boolean, by default = false, that indicates if the location address is embedded in the location name.

- **Extensions**

The following metaclasses are extended by ActualLocation:

- InstanceSpecification

- **Specializations**

The ActualLocation element is a specialization of:

- UPDMElement

8.2.1.1.2.4.2 ConditionType

Abstract element indicating what an EnvironmentProperty can be typed by.

Note: ConditionType is abstract.

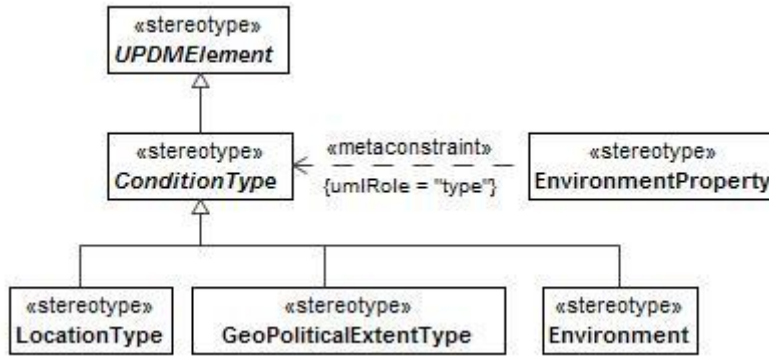

Figure 8:14 - ConditionType

- **Specializations**

The ConditionType element is a specialization of:

- UPDMElement

8.2.1.1.2.4.3 Environment

MODAF: A definition of the conditions in which something exists or functions.

DoDAF: NA

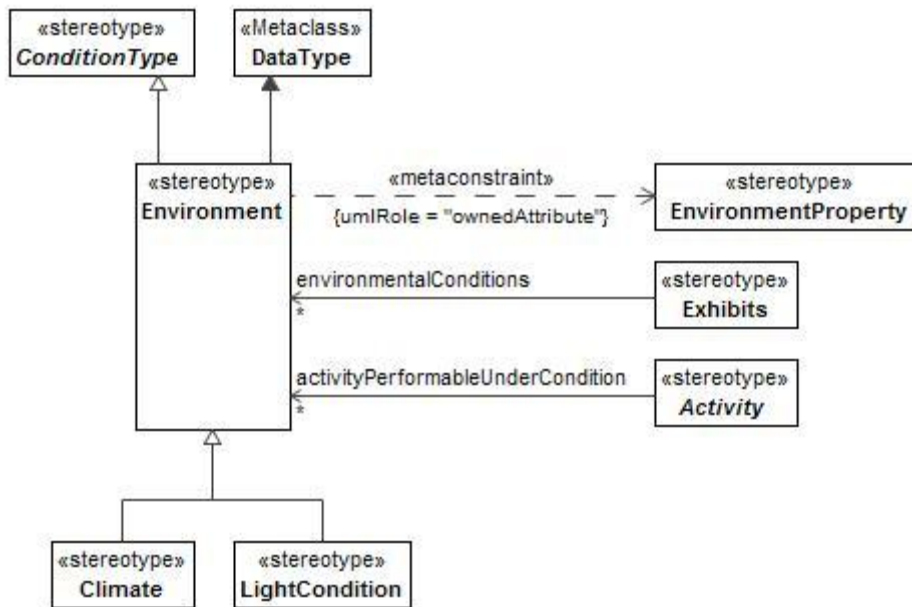

Figure 8:15 - Environment

- **Constraints**

The following are constraints for Environment:

- **Environment.ownedAttributes** - Owned attributes have to be stereotyped <<EnvironmentProperty>>.

- **Extensions**

The following metaclasses are extended by Environment:

- DataType

- **Specializations**

The Environment element is a specialization of:

- ConditionType
- PropertySet

8.2.1.1.2.4.4 EnvironmentProperty

MODAF: Asserts that an Environment has one or more properties. These may be Climate, LocationType, or LightCondition.

DoDAF: NA

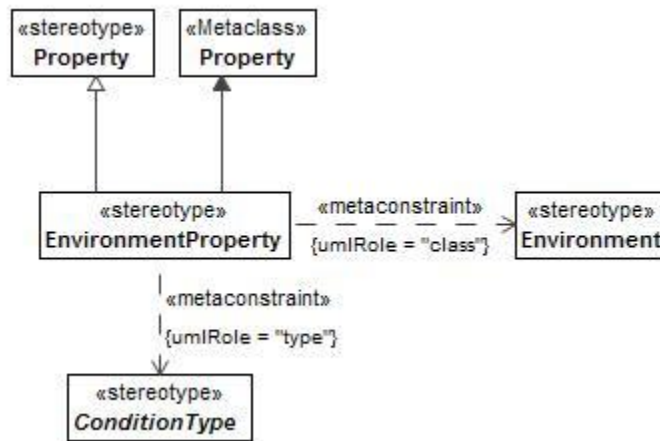

Figure 8:16 - EnvironmentProperty

- **Constraints**

The following are constraints for EnvironmentProperty:

- **EnvironmentalProperty.class** - Value for the class property must be stereotyped «Environment» or its specializations.
- **EnvironmentalProperty.type** - Value for the type property must be stereotyped «ConditionType» or its specializations.

- **Extensions**

The following metaclasses are extended by EnvironmentProperty:

- Property

- **Specializations**

The EnvironmentProperty element is a specialization of:

- Property

8.2.1.1.2.4.5 LocationHolder

UPDM: Abstract grouping to capture elements that can have a location.

Note: LocationHolder is abstract.

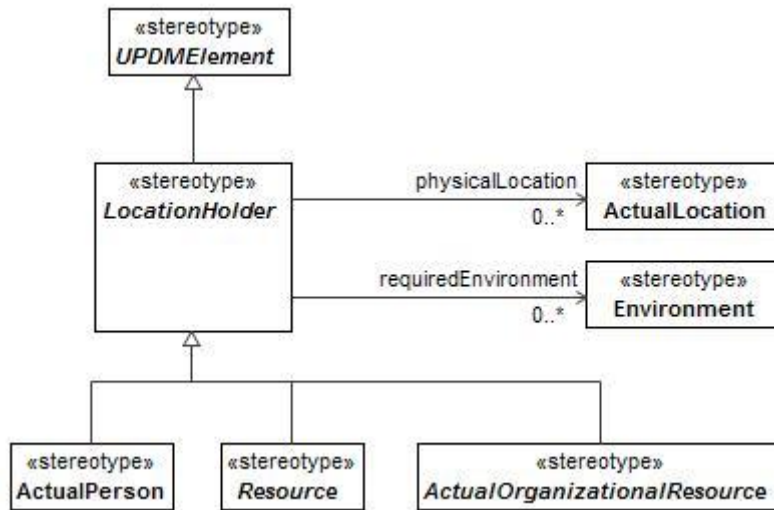

Figure 8:17 - LocationHolder

- **Attributes**

The following are attributes for LocationHolder:

- physicalLocation: ActualLocation[0..*] - The ActualLocation associated with a LocationHolder(Abstract).
- requiredEnvironment: Environment[0..*] - The Environment in which a LocationHolder(Abstract) is active.

- **Specializations**

The LocationHolder element is a specialization of:

- UPDMElement

8.2.1.1.2.4.6 LocationKind

Enumeration of location kinds, derived from DoDAF, used to support the locationKind tag of the LocationKind stereotype.

- **Enumeration Literals**

The following are enumeration literals for LocationKind:

- CircularArea - The space enclosed by a circle.
- EllipticalArea - The space enclosed by an ellipse.
- GeoStationaryPoint - Unidimensional Individual (dimensionless in space, existent over all time).
- Line - A geometric figure formed by a point moving along a fixed direction and the reverse direction.
- Other - Other Location kind that is not on the enumerated list.
- PlanarSurface - A two-dimensional portion of space.

- Point - Unidimensional Individual (dimensionless in space, existent over all time).
- PolygonArea - The space enclosed by a polygon.
- RectangularArea - The space enclosed by a rectangle.
- SolidVolume - The amount of space occupied by a three-dimensional object of definite shape; not liquid or gaseous.
- Surface - A portion of space having length and breadth but no thickness or regards to time.

8.2.1.1.2.4.7 LocationType

MODAF: A general specification of the surroundings / scenario in which an operation may take place. Examples would be: "desert," "arctic," "at sea," etc.

DoDAF: A point or extent in space that may be referred to physically or logically. Includes concepts such as: Facility, Installation, RealProperty, Site, and instances of conditions such as underwater (as specified in UJTLs).

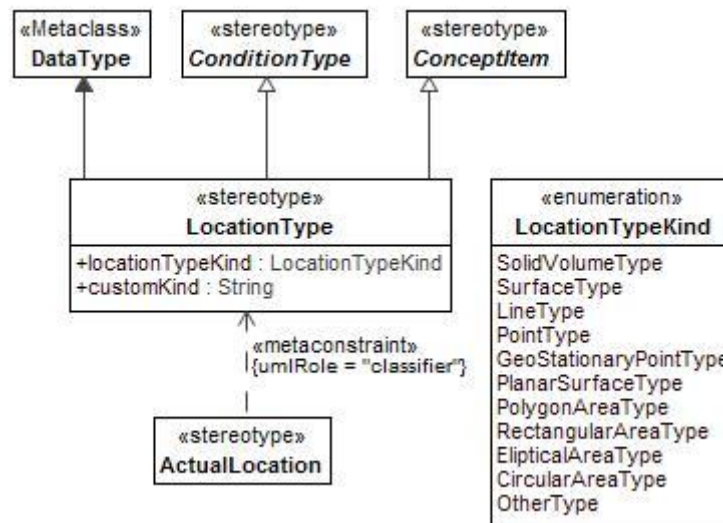

Figure 8:18 - LocationType

- **Attributes**

The following are attributes for LocationType:

- customKind: String[] - String defining custom kinds of locationTypes.
- locationTypeKind: LocationTypeKind[] - Kind of location taken from the DOD UJTLs.

- **Extensions**

The following metaclasses are extended by LocationType:

- DataType

- **Specializations**

The LocationType element is a specialization of:

- ConceptItem

- ConditionType

8.2.1.1.2.4.8 LocationTypeKind

Enumeration of kinds of location types, derived from DoDAF, used to support the LocationTypeKind tag of the LocationTypeKind stereotype.

- **Enumeration Literals**

The following are enumeration literals for LocationTypeKind:

- CircularAreaType - Powertype Of CircularArea.
- EllipticalAreaType - Powertype Of EllipticalArea.
- GeoStationaryPointType - Powertype Of GeoStationaryPoint.
- LineType - Powertype Of Line.
- OtherType - Other LocationType kind that is not on the enumerated list.
- PlanarSurfaceType - Powertype Of PlanarSurface.
- PointType - Powertype Of Point.
- PolygonAreaType - Powertype Of PolygonArea.
- RectangularAreaType - Powertype Of RectangularArea.
- SolidVolumeType - Powertype Of SolidVolume.
- SurfaceType - Powertype Of Surface.

8.2.1.1.2.5 UPDM L1::UPDM L0::Core::AllElements::Measurements

The measurement portion of the AllElements profile.

8.2.1.1.2.5.1 ActualMeasurement

UPDM: An actual value of the Measurement.

MODAF: NA

DoDAF: NA

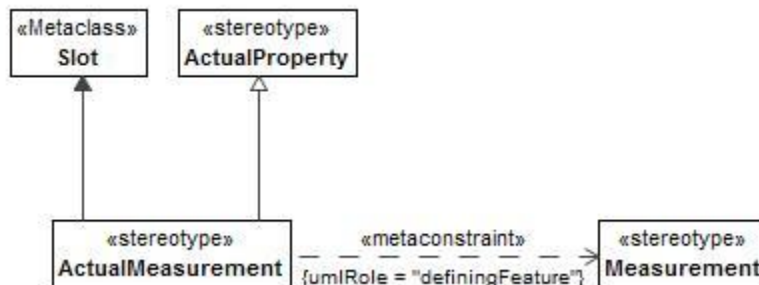

Figure 8:19 - ActualMeasurement

- **Constraints**

The following are constraints for ActualMeasurement:

- `ActualMeasurement.definingFeature` - Value for `definingFeature` property must be stereotyped `«Measurement»` or its specializations.

- **Extensions**

The following metaclasses are extended by `ActualMeasurement`:

- Slot

- **Specializations**

The `ActualMeasurement` element is a specialization of:

- `ActualProperty`

8.2.1.1.2.5.2 ActualProperty

UPDM: The value of a Measure.

MODAF: NA

DoDAF: NA

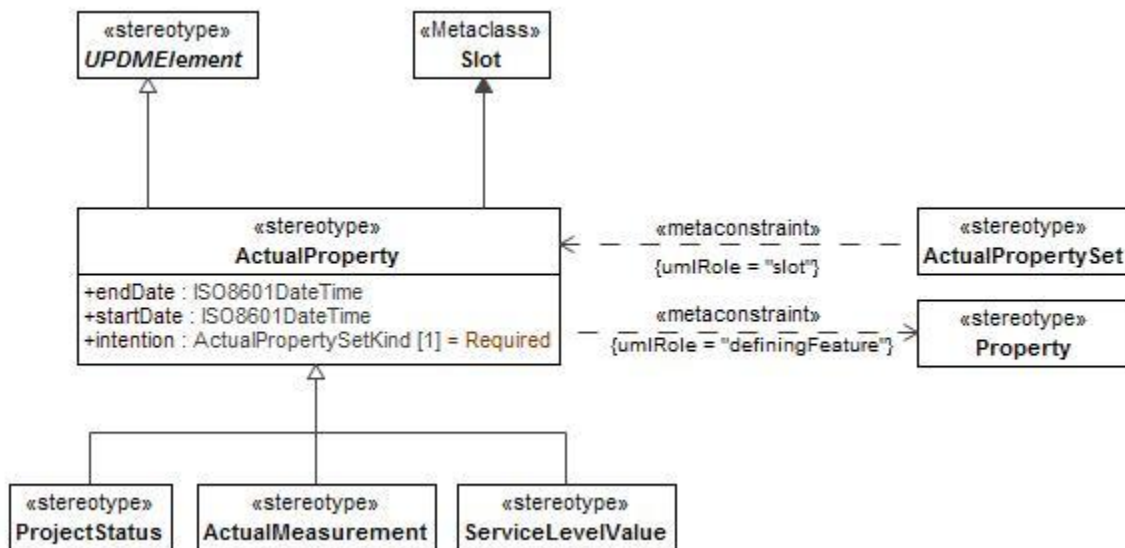

Figure 8:20 - ActualProperty

- **Constraints**

The following are constraints for `ActualProperty`:

- `PropertyValue.definingFeature` - Value for `definingFeature` property must be stereotyped `«Property»` or its specializations.
- `PropertyValue.owningInstance` - Value for `owningInstance` property has to be stereotyped `«PropertySet»` or its specializations.

- **Attributes**

The following are attributes for `ActualProperty`:

- `endDate`: `ISO8601DateTime[]` - Applicable end date of the measured property.
- `intention`: `ActualPropertySetKind[1]` - Possible kinds of `ActualMeasurementSet` intention.

- startDate: ISO8601DateTime[] - Applicable end date of the measured property.

- **Extensions**

The following metaclasses are extended by ActualProperty:

- Slot

- **Specializations**

The ActualProperty element is a specialization of:

- UPDMElement

8.2.1.1.2.5.3 ActualPropertySet

UPDM: A set or collection of ActualMeasurement(s). A date of measurement can be set. An intent of ActualMeasurementSet can be “Result,” “Required,” or “Estimate.”

MODAF: NA

DoDAF: NA

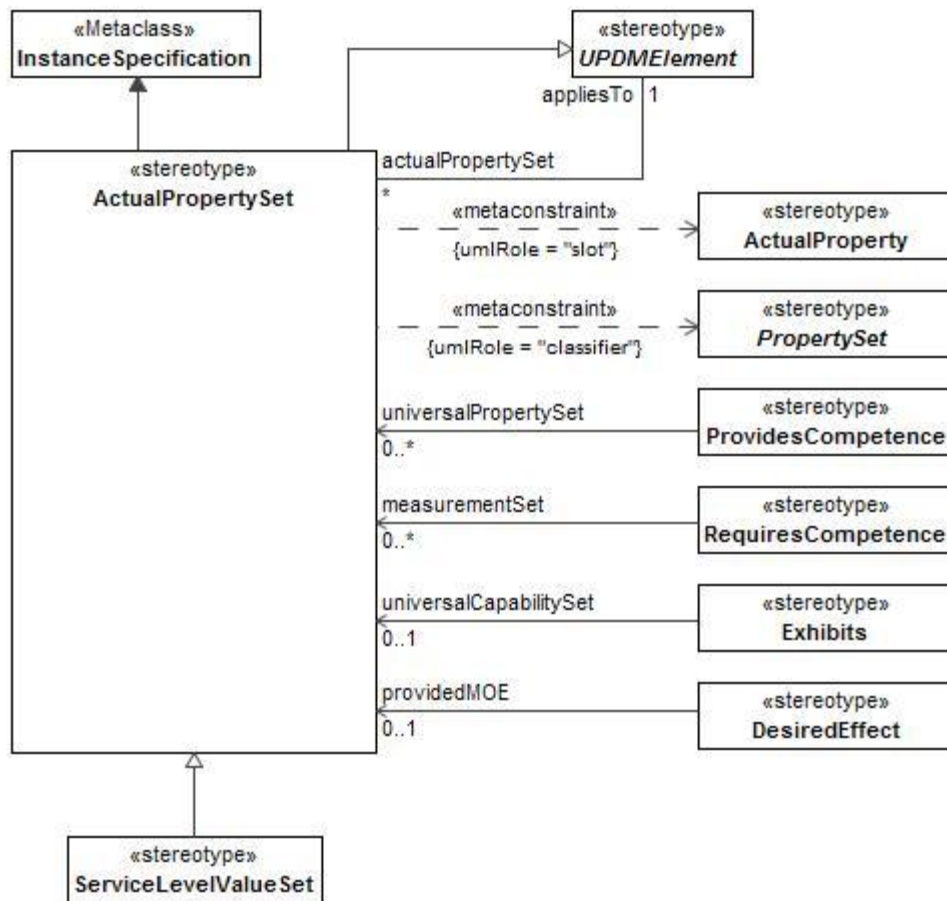

Figure 8:21 - ActualPropertySet

- **Constraints**

The following are constraints for ActualPropertySet:

- `ActualPropertySet.classifier` - Value for the classifier property must be stereotyped «PropertySet» or its specializations.
- `ActualPropertySet.slot` - Value for the slot property must be stereotyped «ActualProperty» or its specializations.

- **Attributes**

The following are attributes for ActualPropertySet:

- `appliesTo`: UPDMElement[1] - Measured element.

- **Extensions**

The following metaclasses are extended by ActualPropertySet:

- InstanceSpecification

- **Specializations**

The ActualPropertySet element is a specialization of:

- UPDMElement

8.2.1.1.2.5.4 ActualPropertySetKind

Possible kinds of ActualMeasurementSet intention, derived from DoDAF.

- **Enumeration Literals**

The following are enumeration literals for ActualPropertySetKind:

- Actual - Actual Measure
- Estimate - Estimate
- Required - Required Measure

8.2.1.1.2.5.5 Measurement

MODAF: MeasurableProperty: A property of something in the physical world, expressed in amounts of a unit of measure. The property may have a required value - either specified by the [defaultValue] from UML::property attribute, or the [minValue] and [maxValue] to specify a required range.

DoDAF: Measure: A Measurement (DoDAF::Measure) is the magnitude of some attribute of an individual.

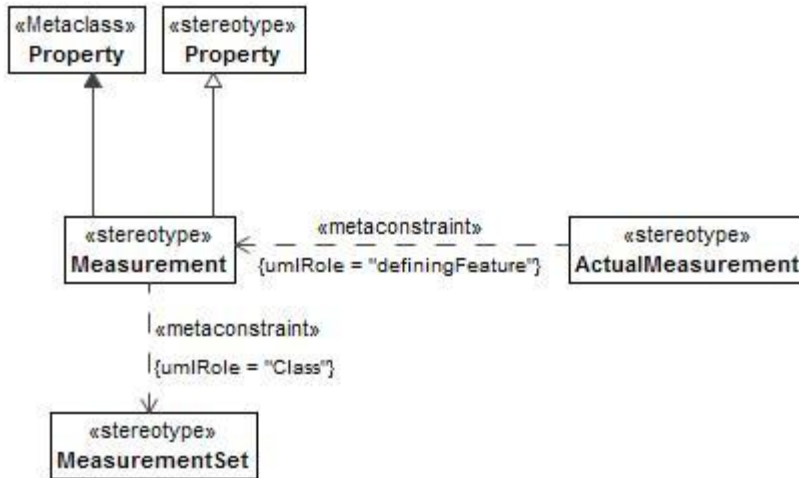

Figure 8:22 - Measurement

- **Extensions**

The following metaclasses are extended by Measurement:

- Property

- **Specializations**

The Measurement element is a specialization of:

- Property

8.2.1.1.2.5.6 MeasurementSet

UPDM: A collection of Measurements.

MODAF: N/A

DoDAF: N/A

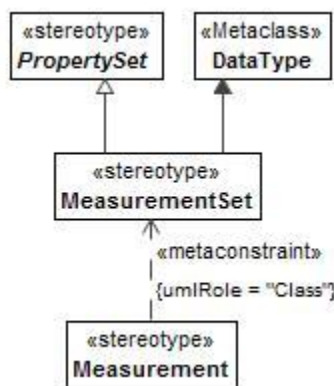

Figure 8:23 - MeasurementSet

- **Constraints**

The following are constraints for MeasurementSet:

- `MeasurementSet.ownedAttributes` - Owned attributes have to be stereotyped `<<Measurement>>`.

- **Extensions**

The following metaclasses are extended by `MeasurementSet`:

- `DataType`

- **Specializations**

The `MeasurementSet` element is a specialization of:

- `PropertySet`

8.2.1.1.2.5.7 Property

UPDM: The defining feature of an actual property, used to capture measurements.

MODAF: NA

DoDAF: NA

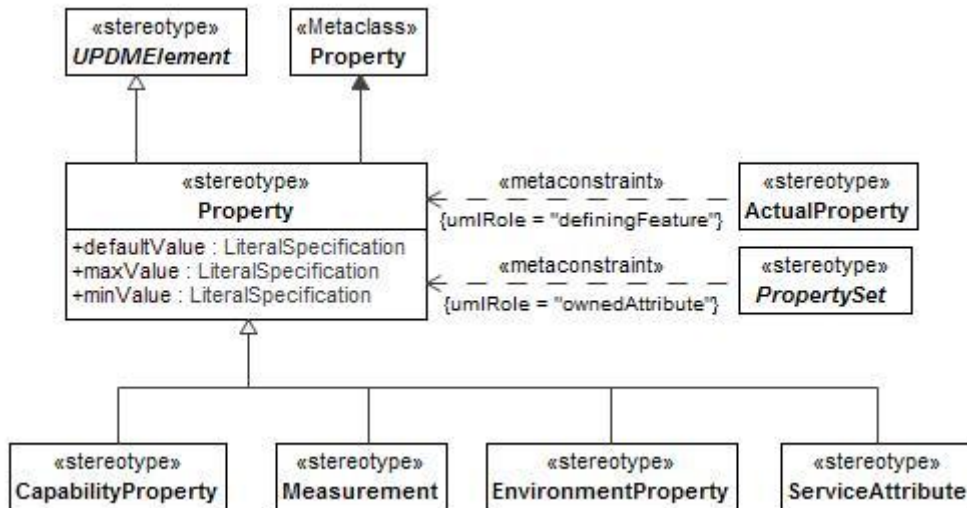

Figure 8:24 - Property

- **Attributes**

The following are attributes for `Property`:

- `defaultValue : LiteralSpecification[]` -
- `maxValue : LiteralSpecification[]` -
- `minValue : LiteralSpecification[]` -

- **Extensions**

The following metaclasses are extended by `Property`:

- `Property`

- **Specializations**

The `Property` element is a specialization of:

- UPDMElement

8.2.1.1.2.5.8 PropertySet

UPDM: A set or collection of Measurement(s).
 MODAF: NA
 DoDAF: NA

Note: PropertySet is abstract.

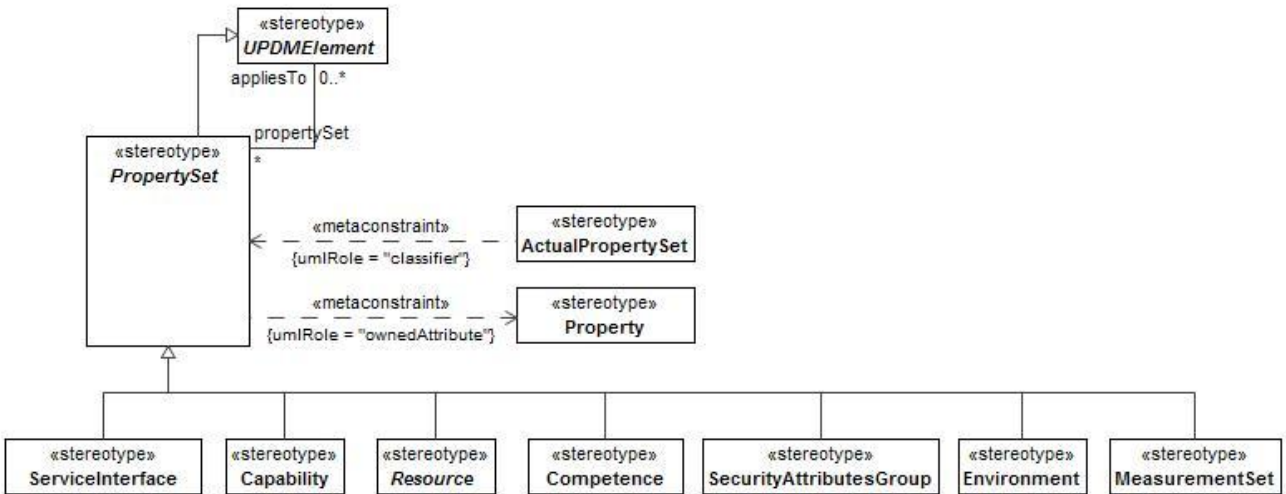

Figure 8:25 - PropertySet

- **Constraints**

The following are constraints for PropertySet:

- **PropertySet.ownedAttribute** - Values for the ownedAttribute property must be stereotyped «Property» or its specializations.

- **Attributes**

The following are attributes for PropertySet:

- appliesTo : UPDMElement[0..*] - Measured element.

- **Specializations**

The PropertySet element is a specialization of:

- UPDMElement

8.2.1.1.2.6 UPDM L1::UPDM L0::Core::AllElements::Structure

This sub clause of the specification contains the Structural Aspects of the All Elements ssub clause.

8.2.1.1.2.6.1 ExchangeElement

MODAF: A relationship specifying the need to exchange information between nodes.
 DoDAF: NA - this is a specialization of OperationalExchange (DoDAF::Interface).

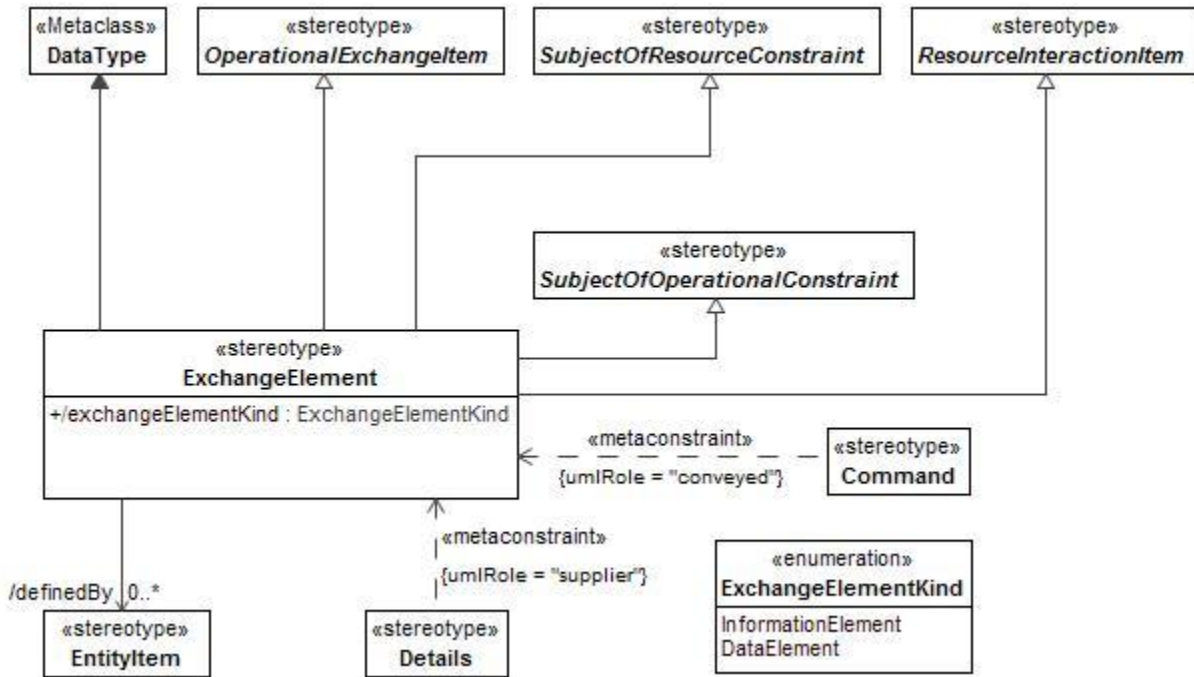

Figure 8:26 - ExchangeElement

- **Attributes**

The following are attributes for ExchangeElement:

- definedBy: EntityItem[0..*] - The relationship between the EntityElement that defines the ExchangeElement.
- exchangeElementKind: ExchangeElementKind[] - Enumeration of the kinds of information being exchanged.

- **Extensions**

The following metaclasses are extended by ExchangeElement:

- DataType

- **Specializations**

The ExchangeElement element is a specialization of:

- OperationalExchangeItem
- SubjectOfResourceConstraint
- ResourceInteractionItem
- SubjectOfOperationalConstraint

8.2.1.1.2.6.2 ExchangeElementKind

Enumeration of the types of element being exchanged on an information exchange.

- **Enumeration Literals**

The following are enumeration literals for ExchangeElementKind:

- DataElement - A formalized representation of data which is managed by or exchanged between resources.
- InformationElement - An item of information that flows between Operational Activities and Nodes. The structure of an InformationElement may be defined using a LogicalDataModel.

8.2.1.1.2.6.3 Participant

UPDM: A participant is the abstract type of a provider and/or consumer of services. In the business domain a participant may be a person, organization or system. In the systems domain a participant may be a system, application, or component.

Note: Participant is abstract.

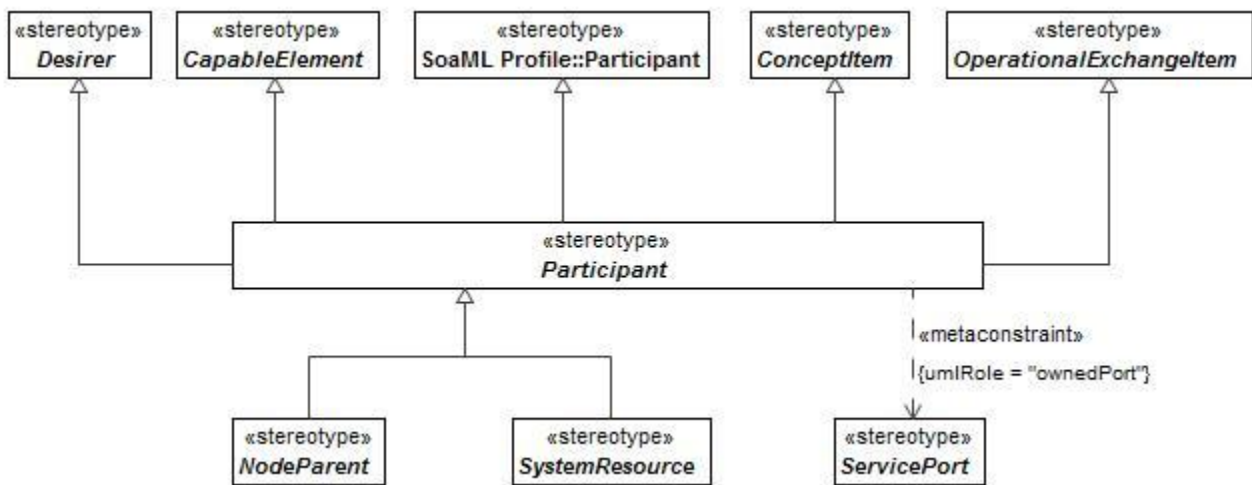

Figure 8:27 - Participant

- **Constraints**

The following are constraints for Participant:

- **Participant.ownedPort** - Values for the ownedPort property must be stereotyped «ServicePort» or its specializations.

- **Specializations**

The Participant element is a specialization of:

- CapableElement
- ConceptItem
- OperationalExchangeItem
- Desirer
- Participant

8.2.1.1.2.6.4 Resource

UPDM: Abstract element placeholder to indicate that resources can be exchanged in Operational and Systems views.

MODAF: NA

DoDAF: Data, Information, Performers, Material, or Personnel Types that are produced or consumed.

Note: Resource is abstract.

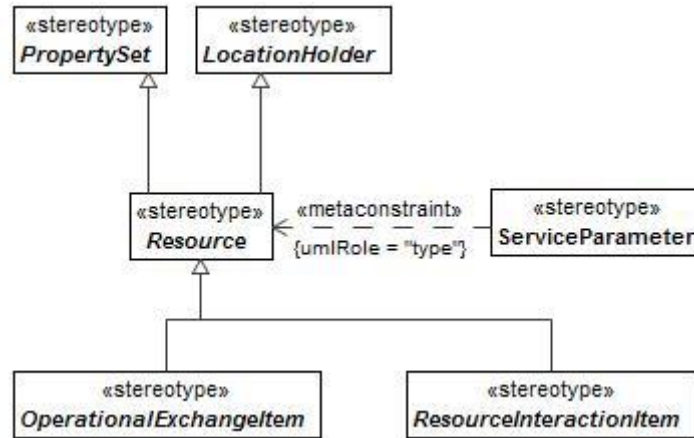

Figure 8:28 - Resource

- **Specializations**

The Resource element is a specialization of:

- LocationHolder
- PropertySet
- SubjectOfResourceConstraint

8.2.1.1.2.6.5 Rule

MODAF: An abstract Class that is extended by OperationalConstraint - a rule governing an operational behavior or property; and ResourceConstraint - a rule governing the structural or functional aspects of an implementation (this may also include constraints on OrganizationalResources that are part of an implementation).

DoDAF: Rule: A principle or condition that governs behavior; a prescribed guide for conduct or action. Subtype:

Constraint: The range of permissible states for an object.

Note: Rule is abstract.

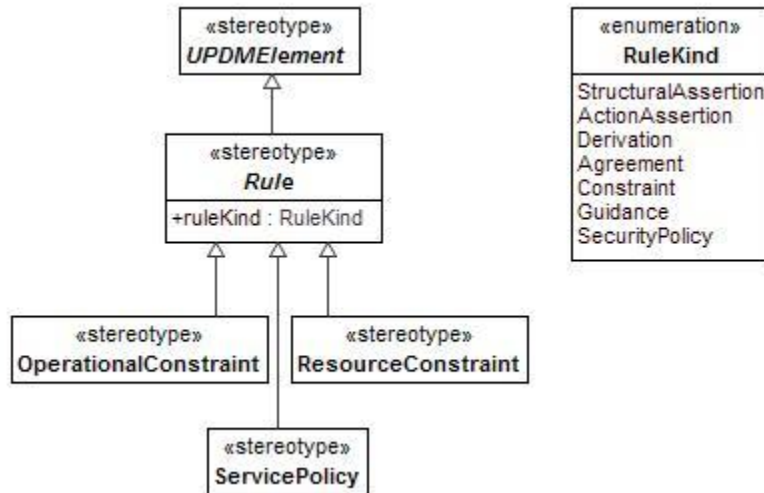

Figure 8:29 - Rule

- **Attributes**

The following are attributes for Rule:

- ruleKind : RuleKind[] -

- **Specializations**

The Rule element is a specialization of:

- UPDMElement

8.2.1.1.2.6.6 RuleKind

Enumeration of possible kinds for constraints.

- **Enumeration Literals**

The following are enumeration literals for RuleKind:

- ActionAssertion - Statement that concerns some dynamic aspect of the business.
- Agreement - A consent among parties regarding the terms and conditions of activities that said parties participate in.
- Constraint - Business Rule, Rule, Restraint, Operational Limitation.
- Derivation - Rule derived from another rule.
- Guidance - An authoritative statement intended to lead or steer the execution of actions.
- SecurityPolicy - An OperationalConstraint that specifies policy for information handling, physical security, encryption, etc.
- StructuralAssertion - Statement that something of importance to the business either exists as a concept of interest or exists in relationship to another thing of interest.

8.2.1.1.2.7 UPDM L1::UPDM L0::Core::AllElements::Views

The views sub clause of the AllElements profile.

8.2.1.1.2.7.1 ArchitecturalDescription

MODAF: A specification of a system of systems at a technical level which also provides the business context for the system of systems.

DoDAF: Information describing an architecture such as an OV-5 Activity Model document.

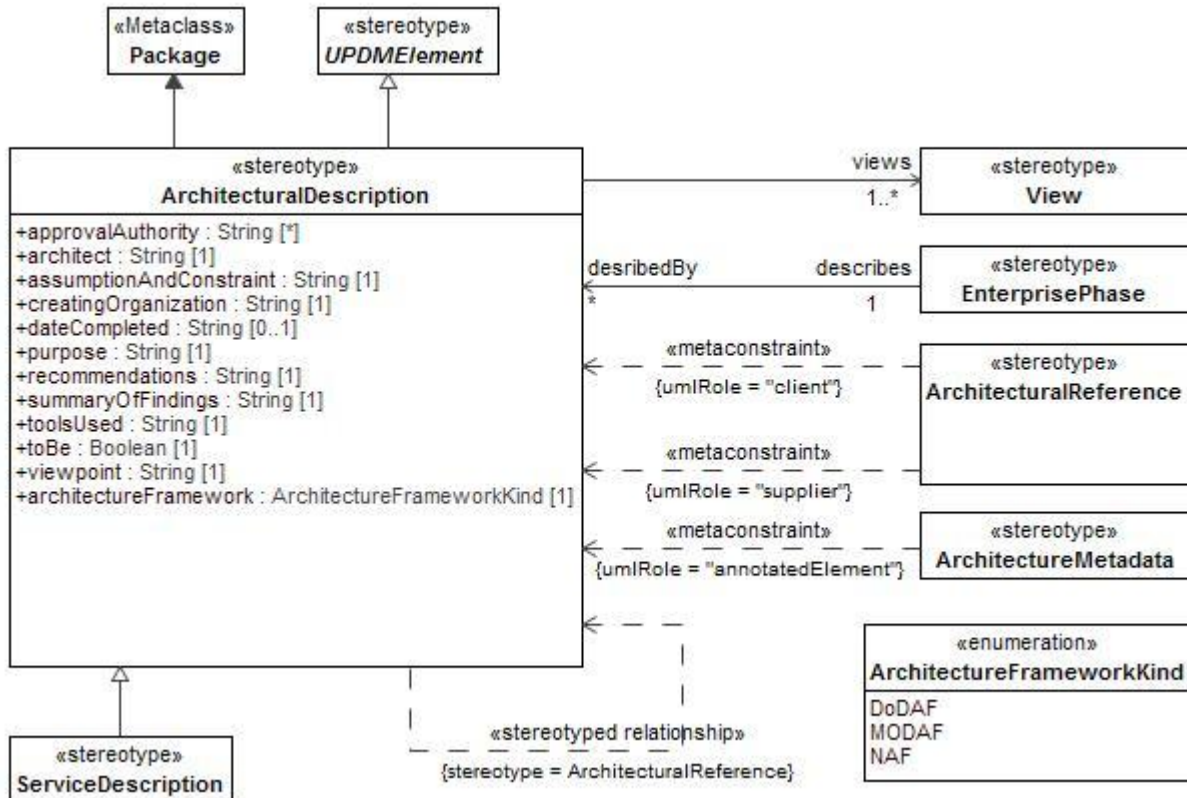

Figure 8:30 - ArchitecturalDescription

- **Constraints**

The following are constraints for ArchitecturalDescription:

- **ArchitecturalDescription.architectureFramework** - If the property is set to DoDAF, only aliases scoped under the DoDAF profile can be used - if set to MODAF then only MODAF aliases can be used. Should the property be set to nothing, none of the aliases can be used.

- **Attributes**

The following are attributes for ArchitecturalDescription:

- approvalAuthority: String[*] - References the actual organizational resource that has the authority to approve the architectural description.
- architect: String[1] - The name of the architect responsible for the ArchitecturalDescription.

- architectureFramework: ArchitectureFrameworkKind[1] - Indicates the type of framework used.
- assumptionAndConstraint: String[1] - Any assumptions, constraints, and limitations contained in the ArchitecturalDescription, including those affecting deployment, communications performance, information assurance environments, etc.
- creatingOrganization: String[1] - Describes the ActualOrganizationalResource creating the ArchitecturalDescription.
- dateCompleted: String[0..1] - Date that the Architectural Description was completed.
- purpose: String[1] - Explains the need for the Architecture, what it will demonstrate, the types of analyses that will be applied to it, who is expected to perform the analyses, what decisions are expected to be made on the basis of each form of analysis, who is expected to make those decisions, and what actions are expected to result.
- recommendations: String[1] - States the recommendations that have been developed based on the architecture effort. Examples include recommended system implementations, and opportunities for technology insertion.
- summaryOfFindings: String[1] - Summarizes the findings that have been developed so far. This may be updated several times during the development of the ArchitecturalDescription.
- toBe: Boolean[1] - Indicates whether the ArchitecturalDescription is existing or future.
- toolsUsed: String[1] - Identifies any tools used to develop the ArchitecturalDescription as well as file names and formats if appropriate.
- viewpoint: String[1] - Indicates which viewpoints are used in the architecture.
- views: View[1..*] - Indicates which views are used in the architecture.

- **Extensions**

The following metaclasses are extended by ArchitecturalDescription:

- Package

- **Specializations**

The ArchitecturalDescription element is a specialization of:

- UPDMElement

8.2.1.1.2.7.2 ArchitecturalReference

MODAF: Asserts that one architectural description (referrer) refers to another (referred).

DoDAF: NA

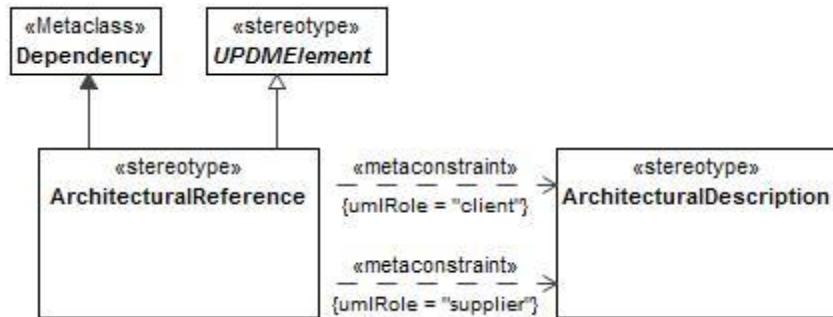

Figure 8:31 - ArchitecturalReference

- **Constraints**

The following are constraints for ArchitecturalReference:

- **ArchitecturalReference.client** - Value for the client property must be stereotyped «ArchitecturalDescription» or its specializations.
- **ArchitecturalReference.supplier** - Value for the supplier property must be stereotyped «ArchitecturalDescription» or its specializations.

- **Extensions**

The following metaclasses are extended by ArchitecturalReference:

- Dependency

- **Specializations**

The ArchitecturalReference element is a specialization of:

- UPDMElement

8.2.1.1.2.7.3 ArchitectureFrameworkKind

Enumeration of the possible types of architectural framework that the architecture is being developed for.

- **Enumeration Literals**

The following are enumeration literals for ArchitectureFrameworkKind:

- DoDAF - Department of Defense Architecture Framework
- MODAF - Ministry of Defence Architecture Framework
- NAF - NATO Architecture Framework

8.2.1.1.2.7.4 ArchitectureMetadata

UPDM: Information on ArchitecturalDescription. It states things like what methodology was used, notation, etc.

MODAF: A Metadata element that applies to the whole architecture.

DoDAF: NA

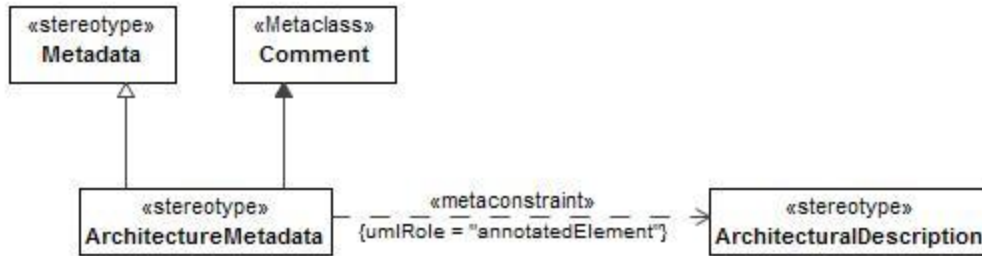

Figure 8:32 - ArchitectureMetadata

- **Constraints**

The following are constraints for ArchitectureMetadata:

- **ArchitectureMetadata.annotatedElement** - Value for the annotatedElement property must be stereotyped «ArchitecturalDescription» or its specializations.

- **Extensions**

The following metaclasses are extended by ArchitectureMetadata:

- Comment

- **Specializations**

The ArchitectureMetadata element is a specialization of:

- Metadata

8.2.1.1.2.7.5 Metadata

MODAF: Annotation that can be applied to any element in the architecture.

DoDAF: NA

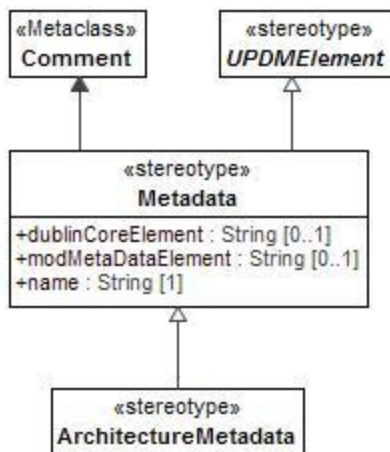

Figure 8:33 - Metadata

- **Attributes**

The following are attributes for Metadata:

- dublinCoreElement: String[0..1] - If the meta data corresponds to the Dublin Core Meta-Data Standard, then the meta-data element name should be listed here.
- modMetaDataElement: String[0..1] - If the meta data corresponds to the MOD Meta-Data Standard, then the meta-data element name should be listed here.
- name : String[1] - The name of the Metadata.

- **Extensions**

The following metaclasses are extended by Metadata:

- Comment

- **Specializations**

The Metadata element is a specialization of:

- UPDMElement

8.2.1.1.2.7.6 View

MODAF: A specification of a way to present an aspect of the architecture. Views are defined with one or more purposes in mind - e.g., showing the logical topology of the enterprise, describing a process model, defining a data model, etc.

DoDAF: NA

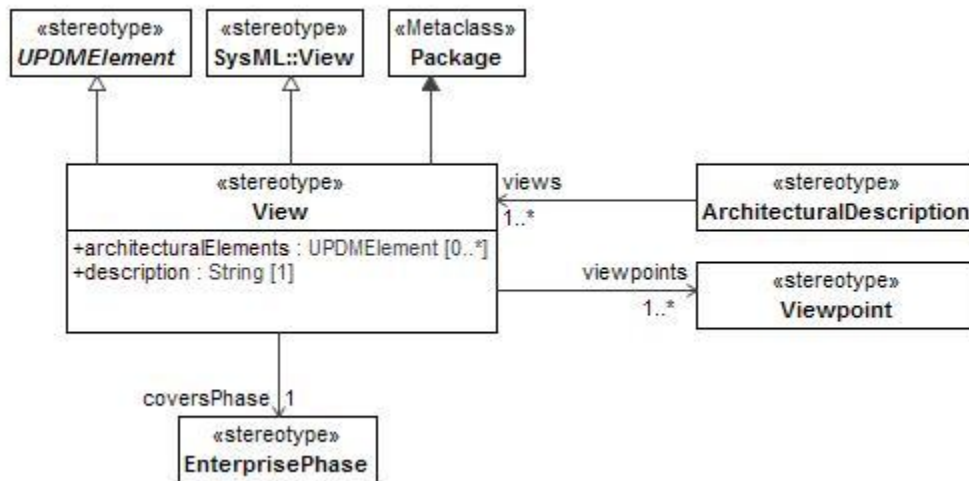

Figure 8:34 - View

- **Attributes**

The following are attributes for View:

- architecturalElements: UPDMElement[0..*] - Architectural elements contained in the view.
- coversPhase: EnterprisePhase[1] - The EnterprisePhase that is covered by a view.
- description: String[1] - Description of the view.
- viewpoints: Viewpoint[1..*] - The Viewpoints associated with a View.

- **Extensions**

The following metaclasses are extended by View:

- Package

- **Specializations**

The View element is a specialization of:

- View
- UPDMElement

8.2.1.1.2.7.7 Viewpoint

MODAF: An instance of the specified View.

DoDAF: NA

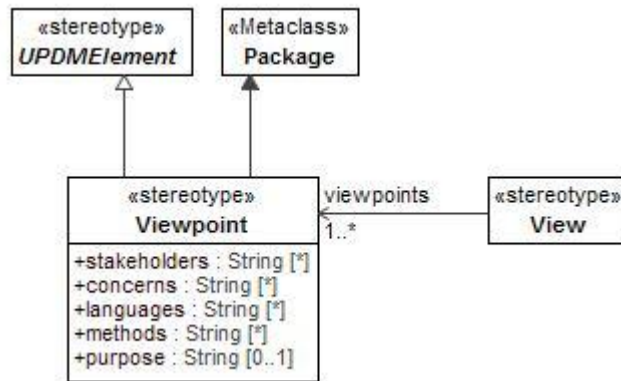

Figure 8:35 - Viewpoint

- **Attributes**

The following are attributes for Viewpoint:

- concerns: String[*] - String, the concerns to be addressed by the viewpoint.
- languages: String[*] - String, the languages used to express the viewpoint.
- methods: String[*] - String, the methods employed in the development of the viewpoint.
- purpose: String[0..1] - String, the purpose of the viewpoint.
- stakeholders: String[*] - String, the stakeholders of the architecture.

- **Extensions**

The following metaclasses are extended by Viewpoint:

- Package

- **Specializations**

The Viewpoint element is a specialization of:

- UPDMElement

8.2.1.1.3 UPDM L1::UPDM L0::Core::ExternalTypes

A type defined by an external ontology. This may be higher-order - i.e., a type of a type.

8.2.1.1.3.1 ISO8601DateTime

MODAF: A date and time specified in the ISO8601 date-time format including timezone designator (TZD): YYYY-MM-DDThh:mm:ssTZD.

DoDAF: NA

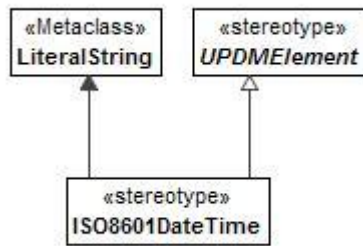

Figure 8:36 - ISO8601DateTime

- **Extensions**

The following metaclasses are extended by ISO8601DateTime:

- LiteralString

- **Specializations**

The ISO8601DateTime element is a specialization of:

- UPDMElement

8.2.1.1.4 UPDM L1::UPDM L0::Core::OperationalElements

OperationalElements group elements used to model product for Operational View. An Operational View (OV) describes the tasks and activities, operational elements, and information exchanges required to conduct operations. A pure OV is material independent. However, operations and their relationships may be influenced by new technologies such as collaboration technology, where process improvements are in practice before policy can reflect the new procedures. There may be some cases, as well, in which it is necessary to document the way processes are performed given the restrictions of current systems, in order to examine ways in which new systems could facilitate streamlining the processes. In such cases, an OV may have material constraints and requirements that must be addressed. For this reason, it may be necessary to include some high-level Systems View (SV) architecture data as overlays or augmenting information onto the OV products.

8.2.1.1.4.1 UPDM L1::UPDM L0::Core::OperationalElements::Behavior

Behavioral sub clause of the OperationalElements Profile.

8.2.1.1.4.1.1 NodeOperation

UPDM: A partial or full realization of an OperationalActivity.

MODAF: NA

DoDAF: NA

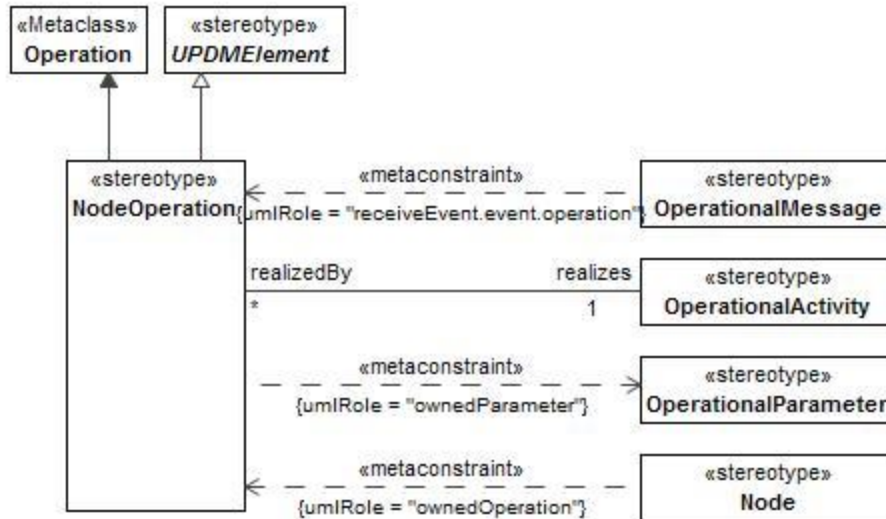

Figure 8:37 - NodeOperation

- **Constraints**

The following are constraints for NodeOperation:

- **NodeOperation.ownedParameter** - The values for the ownedParameter property must be stereotyped «OperationalParameter» or its specializations.

- **Attributes**

The following are attributes for NodeOperation:

- realizes: OperationalActivity[1] - Relationship between a NodeOperation and an OperationalActivity.

- **Extensions**

The following metaclasses are extended by NodeOperation:

- Operation

- **Specializations**

The NodeOperation element is a specialization of:

- UPDMElement

8.2.1.1.4.1.2 OperationalActivity

MODAF: A logical process, specified independently of how the process is carried out.

DoDAF: An activity is an action performed in conducting the business of an enterprise. It is a general term that does not imply a placement in a hierarchy (e.g., it could be a process or a task as defined in other documents and it could be at any level of the hierarchy of the OV-5). It is used to portray operational actions not hardware/software system functions. NOTE: This is also a specialization of Activity.

DoDAF: NA

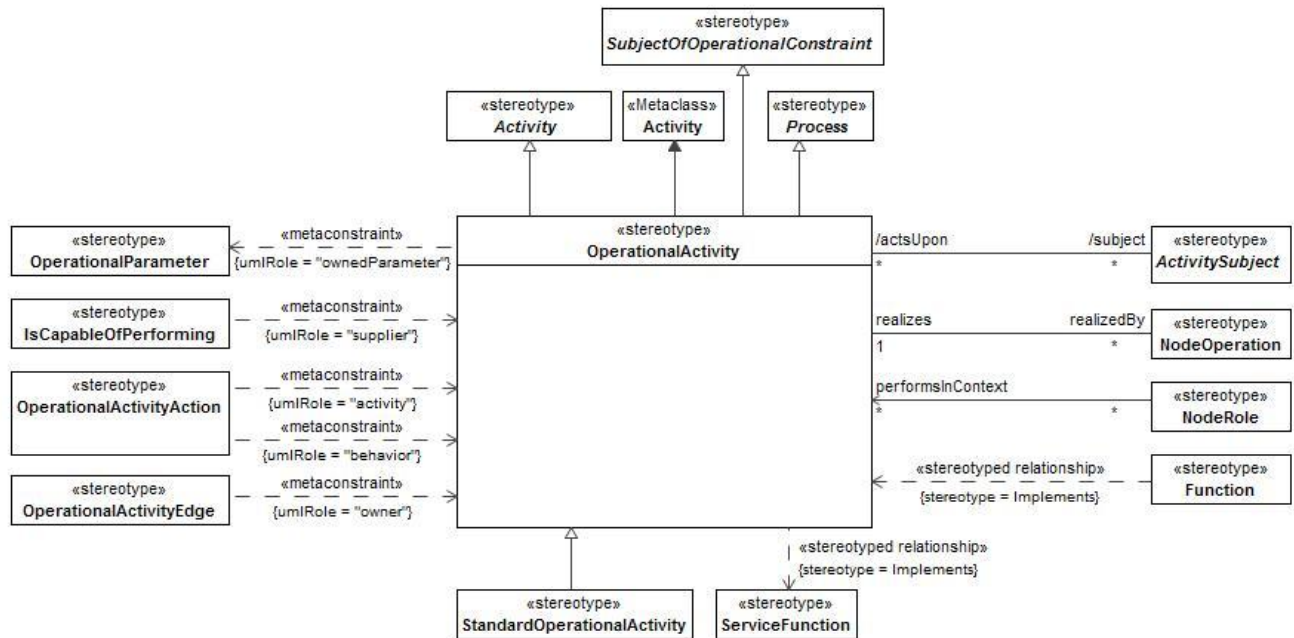

Figure 8:38 - OperationalActivity

- **Constraints**

The following are constraints for OperationalActivity:

- **OperationalActivity.ownedParameter** - The values for the ownedParameter property must be stereotyped «OperationalParameter» or its specializations.

- **Attributes**

The following are attributes for OperationalActivity:

- realizedBy: NodeOperation[*] - Relationship between an OperationalActivity and a NodeOperation
- subject: ActivitySubject[*] - Object acting upon this OperationalActivity.

- **Extensions**

The following metaclasses are extended by OperationalActivity:

- Activity

- **Specializations**

The OperationalActivity element is a specialization of:

- Activity
- SubjectOfOperationalConstraint
- Process

8.2.1.1.4.1.3 OperationalActivityAction

UPDM: The OperationalActivityAction is defined as a call behavior action that invokes the activity that needs to be preformed.

MODAF: Used to relate an OperationalActivity to its sub-activities.

DoDAF: NA

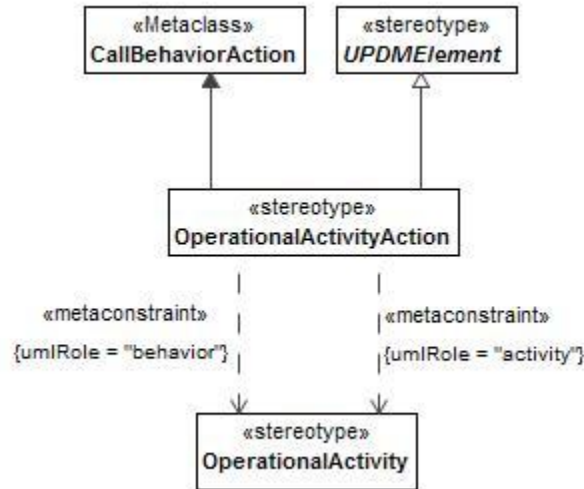

Figure 8:39 - OperationalActivityAction

- **Constraints**

The following are constraints for OperationalActivityAction:

- **OperationalActivityAction.activity** - Value for behavior property must be stereotyped «OperationalActivity» or its specializations.
- **OperationalActivityAction.behavior** - Value for activity property must be stereotyped «OperationalActivity» or its specializations.

- **Extensions**

The following metaclasses are extended by OperationalActivityAction:

- CallBehaviorAction

- **Specializations**

The OperationalActivityAction element is a specialization of:

- UPDMElement

8.2.1.1.4.1.4 OperationalActivityEdge

UPDM: An extension of <<ActivityEdge>> that is used to model the flow of control/objects through an OperationalActivity.

MODAF: An OperationalActivityEdge (MODAF::OperationalActivityFlow) is a flow of information, energy or material from one activity to another.

DoDAF: NA

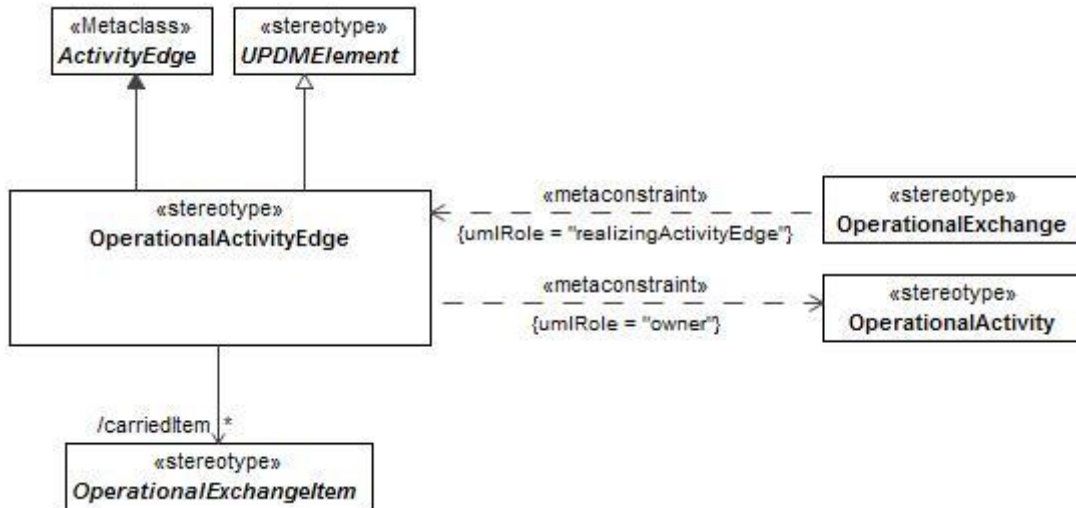

Figure 8:40 - OperationalActivityEdge

- **Constraints**

The following are constraints for OperationalActivityEdge:

- **OperationalActivityEdge.owner** - **«OperationalActivityEdge» must be owned directly or indirectly by «OperationalActivity».**

- **Attributes**

The following are attributes for OperationalActivityEdge:

- **carriedItem: OperationalExchangeItem[*]** - The item information element carried along an OperationalActivityEdge, associated with the relevant needline.

- **Extensions**

The following metaclasses are extended by OperationalActivityEdge:

- ActivityEdge

- **Specializations**

The OperationalActivityEdge element is a specialization of:

- UPDMElement

8.2.1.1.4.1.5 OperationalEventTrace

MODAF: An OperationalEventTrace (MODAF::OperationalInteractionSpecification) is a specification of the interactions between nodes in an operational architecture.

DoDAF: The Operational Event-Trace Description (OV-6c) DoDAF-described View provides a time ordered examination of the resource flows as a result of a particular scenario. Each event-trace diagram will have an accompanying description that defines the particular scenario or situation.

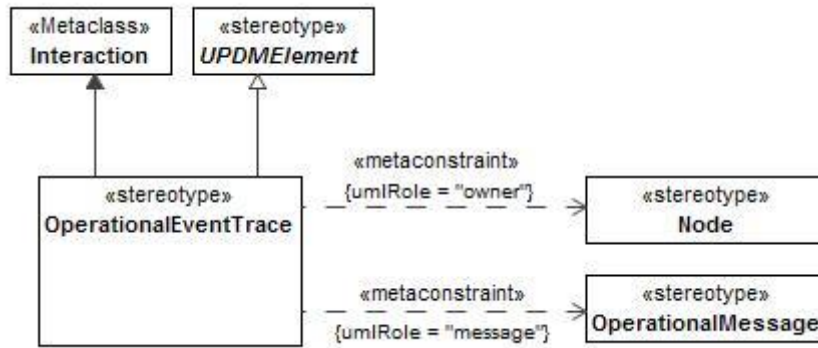

Figure 8:41 - OperationalEventTrace

- **Constraints**

The following are constraints for OperationalEventTrace:

- OperationalEventTrace.message - Values for the message property must be stereotyped with «OperationalMessage» or its specializations.
- OperationalEventTrace.owner - Values for the owner property must be stereotyped with «Node» or its specializations.

- **Extensions**

The following metaclasses are extended by OperationalEventTrace:

- Interaction

- **Specializations**

The OperationalEventTrace element is a specialization of:

- UPDMElement

8.2.1.1.4.1.6 OperationalMessage

UPDM: Message for use in an Operational Event-Trace which carries any of the subtypes of OperationalExchange. This is used to provide additional information about OperationalMessages for display on an OV-6c.

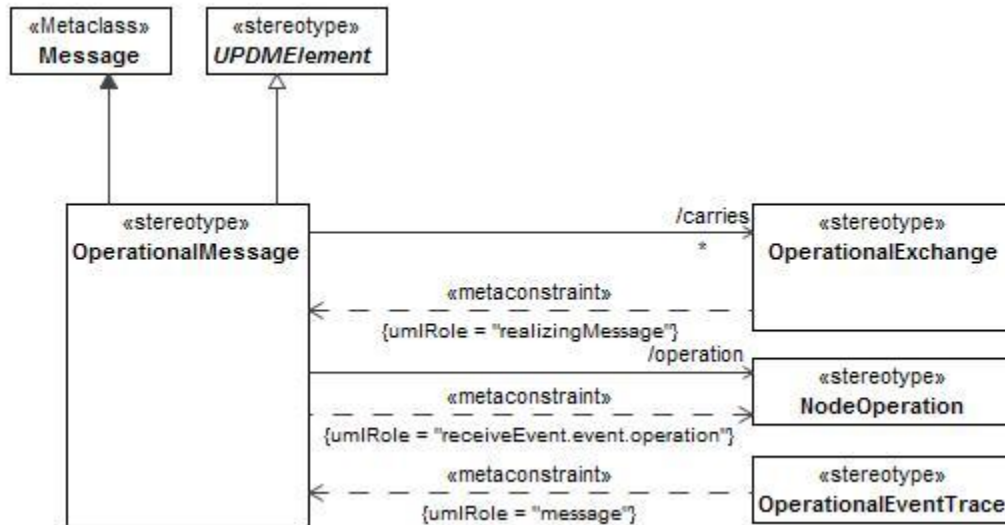

Figure 8:42 - OperationalMessage

- **Constraints**

The following are constraints for OperationalMessage:

- `OperationalMessage.receiveEvent.event.operation` - Values for the `receiveEvent.event.operation` property must be stereotyped with `«NodeOperation»` or its specializations.

- **Attributes**

The following are attributes for OperationalMessage:

- `carries: OperationalExchange[*]` - Carried OperationalExchange.
- `operation: NodeOperation[]` - The NodeOperation associated with an OperationalMessage.

- **Extensions**

The following metaclasses are extended by OperationalMessage:

- Message

- **Specializations**

The OperationalMessage element is a specialization of:

- UPDMElement

8.2.1.1.4.1.7 OperationalParameter

UPDM Represents inputs and outputs of an OperationalActivity. It is typed by OperationalExchangeItem.

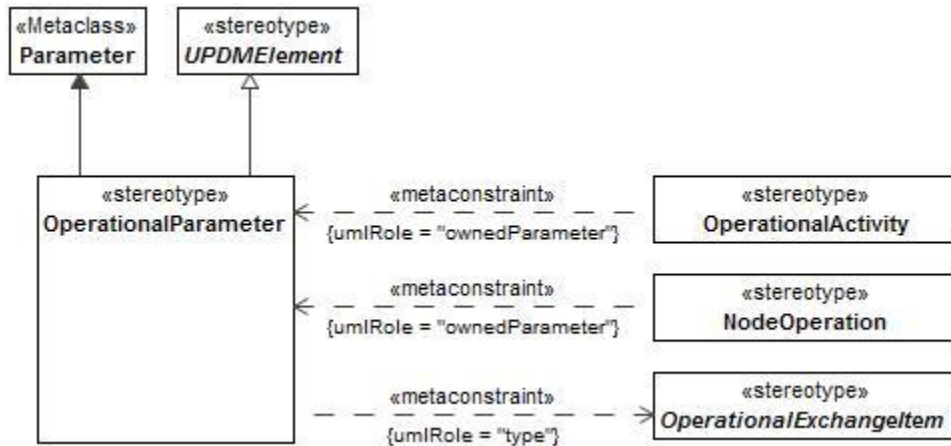

Figure 8:43 - OperationalParameter

- **Constraints**

The following are constraints for OperationalParameter:

- OperationalParameter.type - Value for the type property must be stereotyped by specialization of «OperationalExchangeItem».

- **Extensions**

The following metaclasses are extended by OperationalParameter:

- Parameter

- **Specializations**

The OperationalParameter element is a specialization of:

- UPDMElement

8.2.1.1.4.1.8 OperationalState

UPDM: State identified in the context of an OperationalStateDescription

MODAF: N/A

DoDAF: N/A

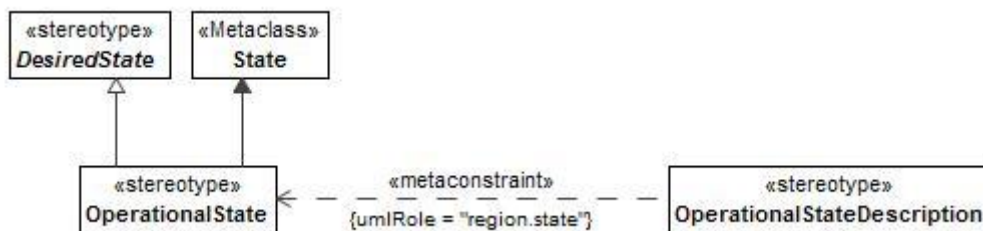

Figure 8:44 - OperationalState

- **Extensions**

The following metaclasses are extended by OperationalState:

- State

- **Specializations**

The OperationalState element is a specialization of:

- DesiredState

8.2.1.1.4.1.9 OperationalStateDescription

UPDM: A state machine describing an operational behavior or property.

MODAF: An OperationalStateMachine (MODAF::OperationalStateDescription) is a rule governing an operational behavior or property.

DoDAF: The Operational State Transition Description (OV-6b) DoDAF-described View is a graphical method of describing how an Operational Activity responds to various events by changing its state. The diagram represents the sets of events to which the Architecture will respond (by taking an action to move to a new state) as a function of its current state. Each transition specifies an event and an action.

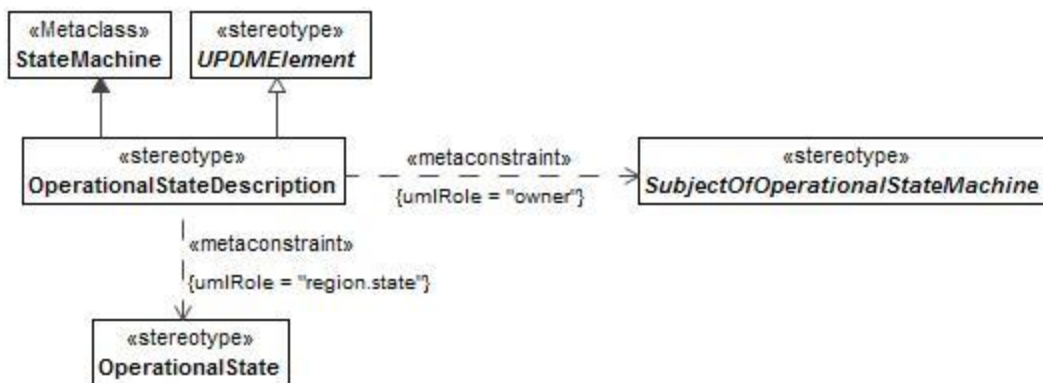

Figure 8:45 - OperationalStateDescription

- **Constraints**

The following are constraints for OperationalStateDescription:

- **OperationalStateDescription.owner** - Values for the owner property must be stereotyped with specializations of «SubjectOfOperationalStateMachine».
- **OperationalStateDescription.region.state** - Values for the region.state property must be stereotyped with «OperationalState» or its specializations.

- **Extensions**

The following metaclasses are extended by OperationalStateDescription:

- StateMachine

- **Specializations**

The OperationalStateDescription element is a specialization of:

- UPDMElement

8.2.1.1.4.1.10 SubjectOfOperationalStateMachine

UPDM Abstract Element: The element being described by the state machine.

Note: SubjectOfOperationalStateMachine is abstract.

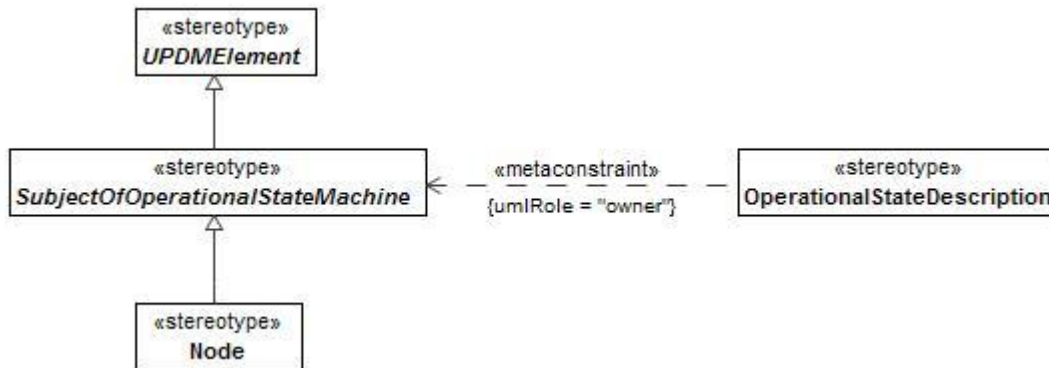

Figure 8:46 - SubjectOfOperationalStateMachine

- **Constraints**

The following are constraints for SubjectOfOperationalStateMachine:

- SubjectOfOperationalStateMachine.ownedBehavior - If elements, that have applied stereotypes that are specializations of «SubjectOfOperationalStateMachine» have StateMachines as owned behaviors, then those behaviors must be stereotyped «OperationalStateMachine» or its specializations.

- **Specializations**

The SubjectOfOperationalStateMachine element is a specialization of:

- UPDMElement

8.2.1.1.4.2 UPDM L1::UPDM L0::Core::OperationalElements::Data

The Data Profile is used to document the business information requirements and structural business process rules of the architecture. It describes the information that is associated with the information exchanges of the architecture. Included are information items, their attributes or characteristics, and their inter-relationships.

8.2.1.1.4.2.1 LogicalDataModel

MODAF: A LogicalDataModel is a specification of business information requirements as a formal data structure, where relationships and classes (entities) are used to specify the logic which underpins the information.

DoDAF: A Logical Data Model allows analysis of an architecture’s data definition aspect, without consideration of implementation specific or product specific issues.

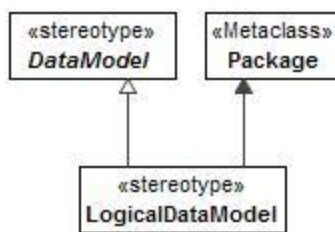

Figure 8:47 - LogicalDataModel

- **Extensions**

The following metaclasses are extended by LogicalDataModel:

- Package

- **Specializations**

The LogicalDataModel element is a specialization of:

- DataModel

8.2.1.1.4.3 UPDM L1::UPDM L0::Core::OperationalElements::Flows

Sub clause of the OperationalElements profile that describe flows exists or are required between Nodes such as flows of information, people, material, or energy.

8.2.1.1.4.3.1 Command

MODAF: Asserts that one OrganizationalResource (source) commands another (target)

DoDAF: NA

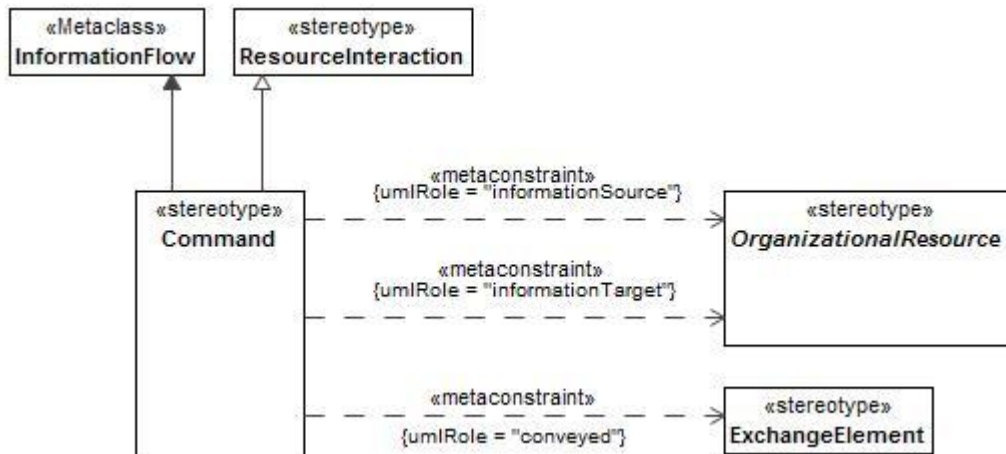

Figure 8:48 - Command

- **Constraints**

The following are constraints for Command:

- **Command.conveyed** - Value for the conveyed property must be stereotyped «ExchangeElement» or its specializations.
- **Command.informationSource** - Value for the informationSource property must be stereotyped «OrganizationalResource» or its specializations.
- **Command.informationTarget** - Value for the informationTarget property must be stereotyped «OrganizationalResource» or its specializations.

- **Extensions**

The following metaclasses are extended by Command:

- InformationFlow

- **Specializations**

The Command element is a specialization of:

- ResourceInteraction

8.2.1.1.4.3.2 OperationalExchange

UPDM: A utility element used as common flow for:

- InformationExchange
- OrganizationalExchange
- EnergyExchange
- MaterialExchange
- ConfigurationExchange
- GeoPoliticalExtent

An operational exchange is formed when an activity of one operational node consumes items produced by another activity of a different operational node.

An operational exchange describes the characteristics of the exchanged item, such as the content, format (voice, imagery, text and message format, etc.), throughput requirements, security or classification level, timeliness requirement, and the degree of interoperability.

MODAF: An OperationalExchange (MODAF::LogicalFlow) asserts that a flow exists or is required between Nodes (e.g., flows of information, people, material, or energy).

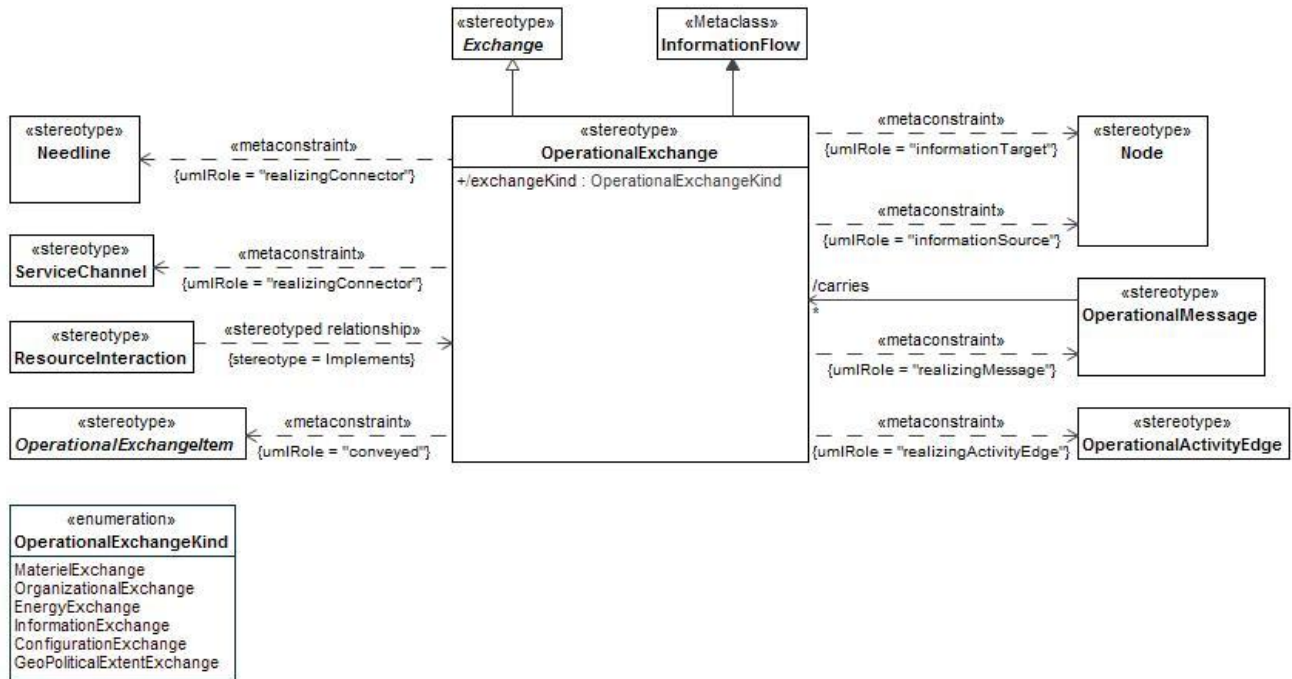

Figure 8:49 - OperationalExchange

- **Constraints**

The following are constraints for OperationalExchange:

- `OperationalExchange.conveyed` - In case of `OperationalExchange.operationalExchangeKind`:
 - = `InformationExchange`, the conveyed element must be stereotyped `«ExchangeElement»` or its specializations,
 - = `MaterielExchange`, the conveyed element must be stereotyped `«ResourceArtifact»` or its specializations,
 - = `EnergyExchange`, the conveyed element must be stereotyped `«Energy»` or its specializations,
 - = `OrganizationalExchange`, the conveyed element must be stereotyped `«OrganizationalResource»` or its specializations,
 - = `ConfigurationExchange`, the conveyed element must be stereotyped `«CapabilityConfiguration»` or its specializations, or
 - = `GeoPoliticalExtentExchange`, the conveyed element must be stereotyped `«GeoPoliticalExtent»` or its specializations.
- `OperationalExchange.informationSource` - Value for `informationSource` property has to be stereotyped `«Node»` or its specializations.
- `OperationalExchange.informationTarget` - Value for `informationTarget` property has to be stereotyped `«Node»` or its specializations.
- `OperationalExchange.realization/realizingConnector` - Value for `realization` or `realizingConnector` property has to be stereotyped `«Needline»`, `«ServiceChannel»`, or their specializations.
- `OperationalExchange.realizingActivityEdge` - Value for `realizingActivityEdge` property has to be stereotyped `«OperationalActivityEdge»` or its specializations.
- `OperationalExchange.realizingMessage` - Value for `realizingMessage` property has to be stereotyped `«OperationalMessage»` or its specializations.

- **Attributes**

The following are attributes for `OperationalExchange`:

- `exchangeKind` : `OperationalExchangeKind[]` - Enumeration of operational exchange kinds.

- **Extensions**

The following metaclasses are extended by `OperationalExchange`:

- `InformationFlow`

- **Specializations**

The `OperationalExchange` element is a specialization of:

- `Exchange`
- `SubjectOfOperationalConstraint`

8.2.1.1.4.3.3 `OperationalExchangeItem`

UPDM: An abstract utility element used as common ancestor for:

- `InformationElement`
- `ResourceArtifact`

- Energy
- OrganizationalResource
- CapabilityConfiguration
- GeoPoliticalExtent

Note: OperationalExchangeItem is abstract.

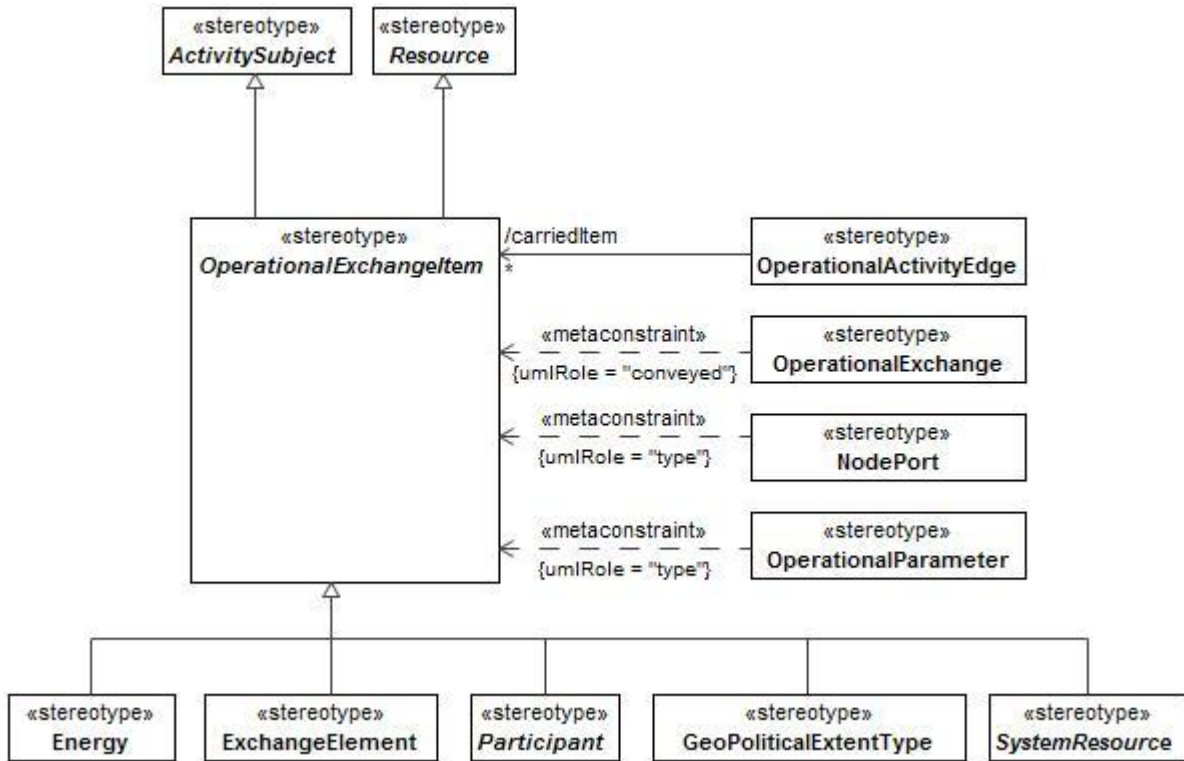

Figure 8:50 - OperationalExchangeItem

- **Specializations**

The OperationalExchangeItem element is a specialization of:

- ActivitySubject
- Resource

8.2.1.1.4.3.4 OperationalExchangeKind

Enumeration of operational exchange kinds, used to support the exchangeKind tag of the OperationalExchange stereotype.

- **Enumeration Literals**

The following are enumeration literals for OperationalExchangeKind:

- ConfigurationExchange - A LogicalFlow where CapabilityConfigurations flow from one node to another.
- EnergyExchange - A LogicalFlow where energy is flowed from one node to another.

- GeoPoliticalExtentExchange - A LogicalFlow where GeoPoliticalExtents (i.e., Borders) flow from one place to another.
- InformationExchange - A LogicalFlow where energy is flowed from one node to another.
- MaterielExchange - A flow of material (artifacts) between Functions.
- OrganizationalExchange - A LogicalFlow where human resources (PostTypes, RoleTypes) flow between Nodes.

8.2.1.1.4.4 UPDM L1::UPDM L0::Core::OperationalElements::Structure

Sub clause of the OperationalElements profile that describes structural concepts.

8.2.1.1.4.4.1 ArbitraryConnector

UPDM: Represents a visual indication of a connection used in high level operational concept diagrams. The connections are purely visual and cannot be related to any architectural semantics.

MODAF: NA

DoDAF: NA

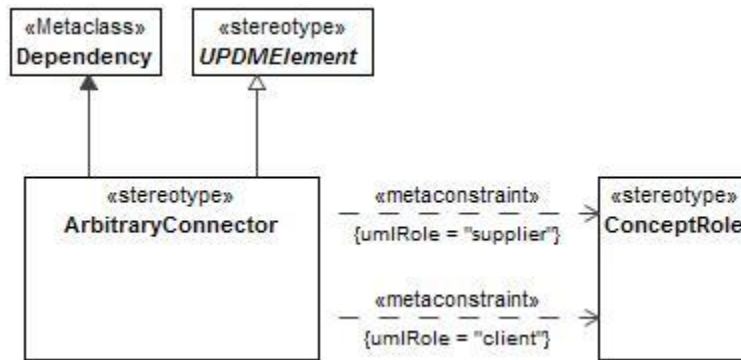

Figure 8:51 - ArbitraryConnector

- **Constraints**

The following are constraints for ArbitraryConnector:

- **ArbitraryConnector.client** - The value for client property has to be stereotyped «ConceptRole» or its specializations.
- **ArbitraryConnector.supplier** - The value for supplier property has to be stereotyped «ConceptRole» or its specializations.

- **Extensions**

The following metaclasses are extended by ArbitraryConnector:

- Dependency

- **Specializations**

The ArbitraryConnector element is a specialization of:

- UPDMElement

8.2.1.1.4.4.2 Competence

MODAF: A specific set of abilities defined by knowledge, skills, and attitude.

DoDAF: (DoDAF::Skill): The ability, coming from one's knowledge, practice, aptitude, etc., to do something well.

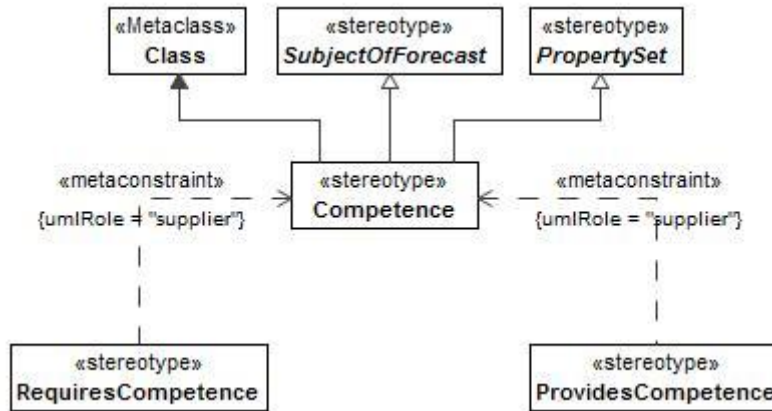

Figure 8:52 - Competence

- **Extensions**

The following metaclasses are extended by Competence:

- Class

- **Specializations**

The Competence element is a specialization of:

- SubjectOfForecast
- PropertySet

8.2.1.1.4.4.3 ConceptItem

UPDM: Abstract, an item which may feature in a high level operational concept.

DoDAF: NA

Note: ConceptItem is abstract.

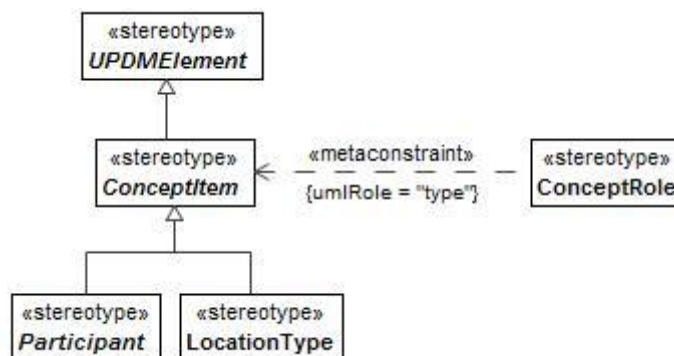

Figure 8:53 - ConceptItem

- **Specializations**

The ConceptItem element is a specialization of:

- UPDMElement

8.2.1.1.4.4.4 ConceptRole

UPDM: Usage of a ConceptItem in the context of a HighLevelOperationalConcept

MODAF: ItemInConcept: A relationship which asserts that a ConceptItem forms part of the high level operational concept.

DoDAF: N/A

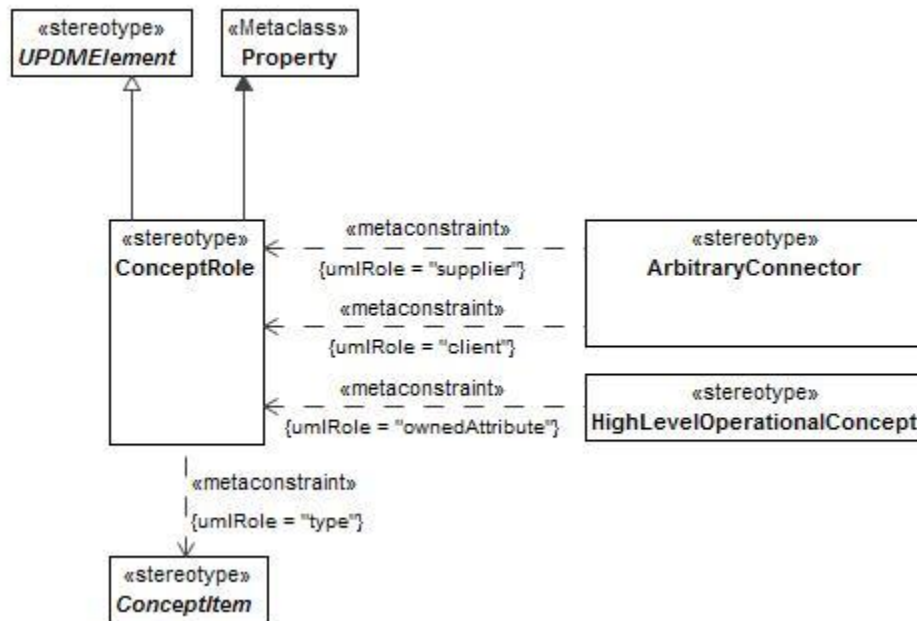

Figure 8:54 - ConceptRole

- **Constraints**

The following are constraints for ConceptRole:

- **ConceptRole.type** - Value for the type property must be stereotyped a specialization of «ConceptItem».

- **Extensions**

The following metaclasses are extended by ConceptRole:

- Property

- **Specializations**

The ConceptRole element is a specialization of:

- UPDMElement

8.2.1.1.4.4.5 HighLevelOperationalConcept

MODAF: A generalized model for operations.

DoDAF: NA

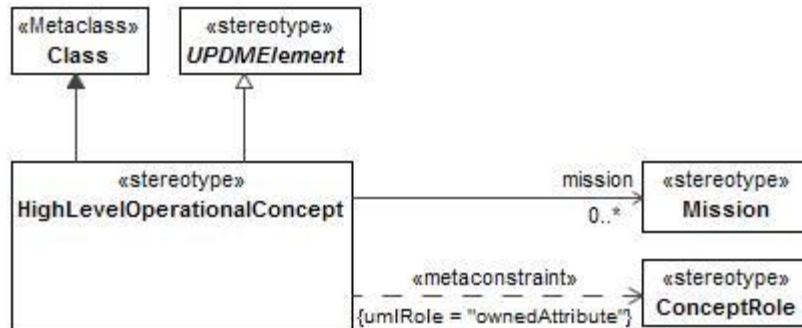

Figure 8:55 - HighLevelOperationalConcept

- **Constraints**

The following are constraints for HighLevelOperationalConcept:

- **HighLevelOperationalConcept.ownedAttribute** - The values for the ownedAttribute properties must be stereotyped with specializations of the «ConceptRole».

- **Attributes**

The following are attributes for HighLevelOperationalConcept:

- mission : Mission[0..*] - Mission that is described by this HighLevelOperationalConcept.

- **Extensions**

The following metaclasses are extended by HighLevelOperationalConcept:

- Class

- **Specializations**

The HighLevelOperationalConcept element is a specialization of:

- UPDMElement

8.2.1.1.4.4.6 KnownResource

MODAF: Asserts that a known Resource plays a part in the architecture.

DoDAF: NA – covered by the more general temporalWholePart element.

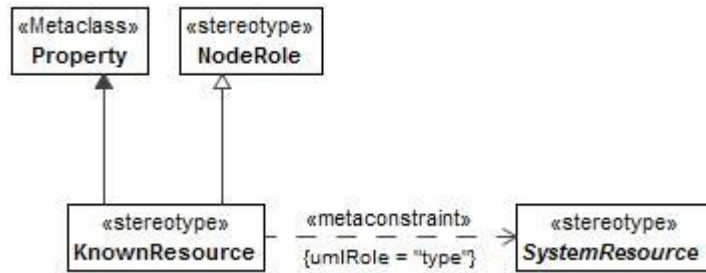

Figure 8:56 - KnownResource

- **Constraints**

The following are constraints for KnownResource:

- KnownResource.type - Values for type property have to be stereotyped «SystemResource» or its specializations.

- **Extensions**

The following metaclasses are extended by KnownResource:

- Property

- **Specializations**

The KnownResource element is a specialization of:

- NodeRole

8.2.1.1.4.4.7 LogicalArchitecture

MODAF: A CompositeStructureModel whose parts are either NodeRoles (MODAF::Node), ProblemDomains, or KnownResources.

DoDAF: NA

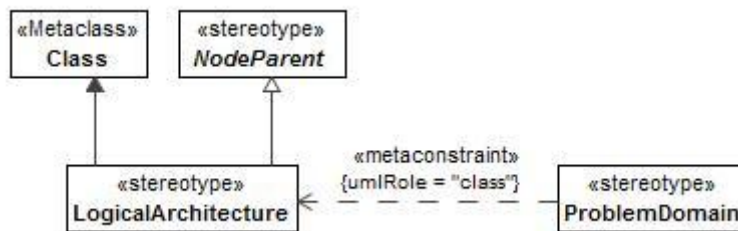

Figure 8:57 - LogicalArchitecture

- **Extensions**

The following metaclasses are extended by LogicalArchitecture:

- Class

- **Specializations**

The LogicalArchitecture element is a specialization of:

- NodeParent

8.2.1.1.4.4.8 Mission

MODAF: A purpose to which a person, organization, or autonomous system is tasked.

DoDAF: The task, together with the purpose, that clearly indicates the action to be taken.

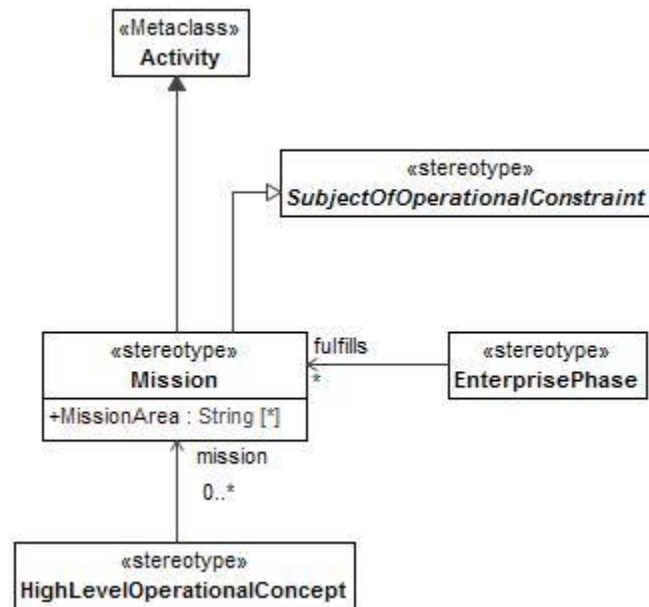

Figure 8:58 - Mission

- **Attributes**

The following are attributes for Mission:

- MissionArea: String[*] - The area in which the Mission will take place.

- **Extensions**

The following metaclasses are extended by Mission:

- Activity

- **Specializations**

The Mission element is a specialization of:

- SubjectOfOperationalConstraint

8.2.1.1.4.4.9 Needline

MODAF: A relationship between Nodes representing a bundle of InformationExchanges.

DoDAF: A needline documents the requirement to exchange information between nodes. The needline does not indicate how the information transfer is implemented.

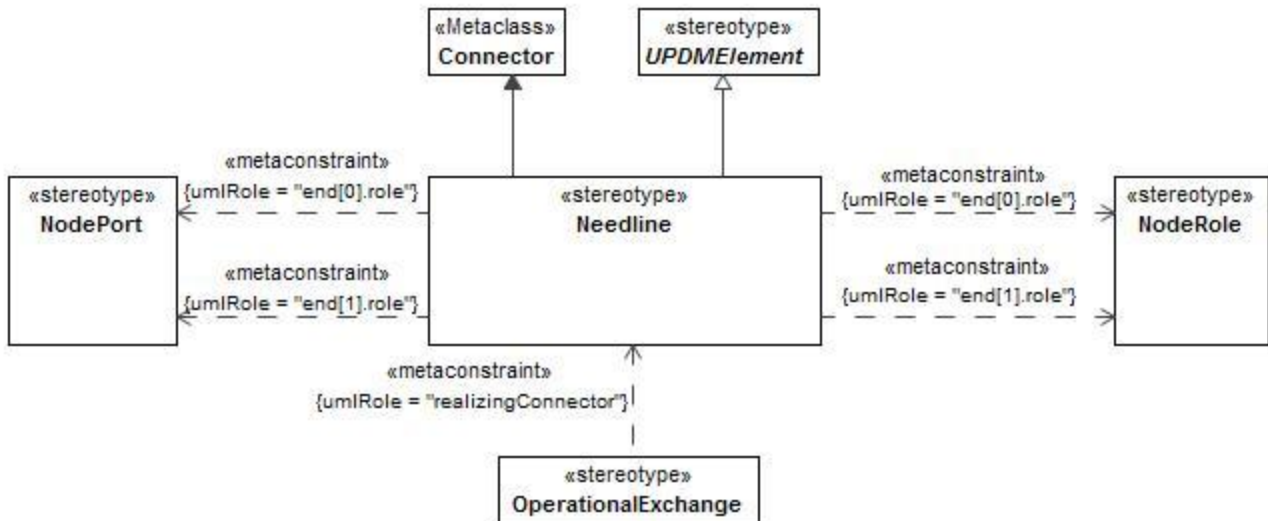

Figure 8:59 - Needline

- **Constraints**

The following are constraints for Needline:

- **Needline.end** - The value for the role property for the owned ConnectorEnd must be stereotype «NodeRole»/«NodePort» or its specializations.

- **Extensions**

The following metaclasses are extended by Needline:

- Connector

- **Specializations**

The Needline element is a specialization of:

- UPDMElement

8.2.1.1.4.4.10 Node

MODAF: A Node (MODAF::NodeType) is a logical entity that performs operational activities. Note: nodes are specified independently of any physical realization.

DoDAF: A Node (DoDAF::OperationalNode) is an element of the operational architecture that produces, consumes, or processes information. NOTE: This is also a specialization of Performer.

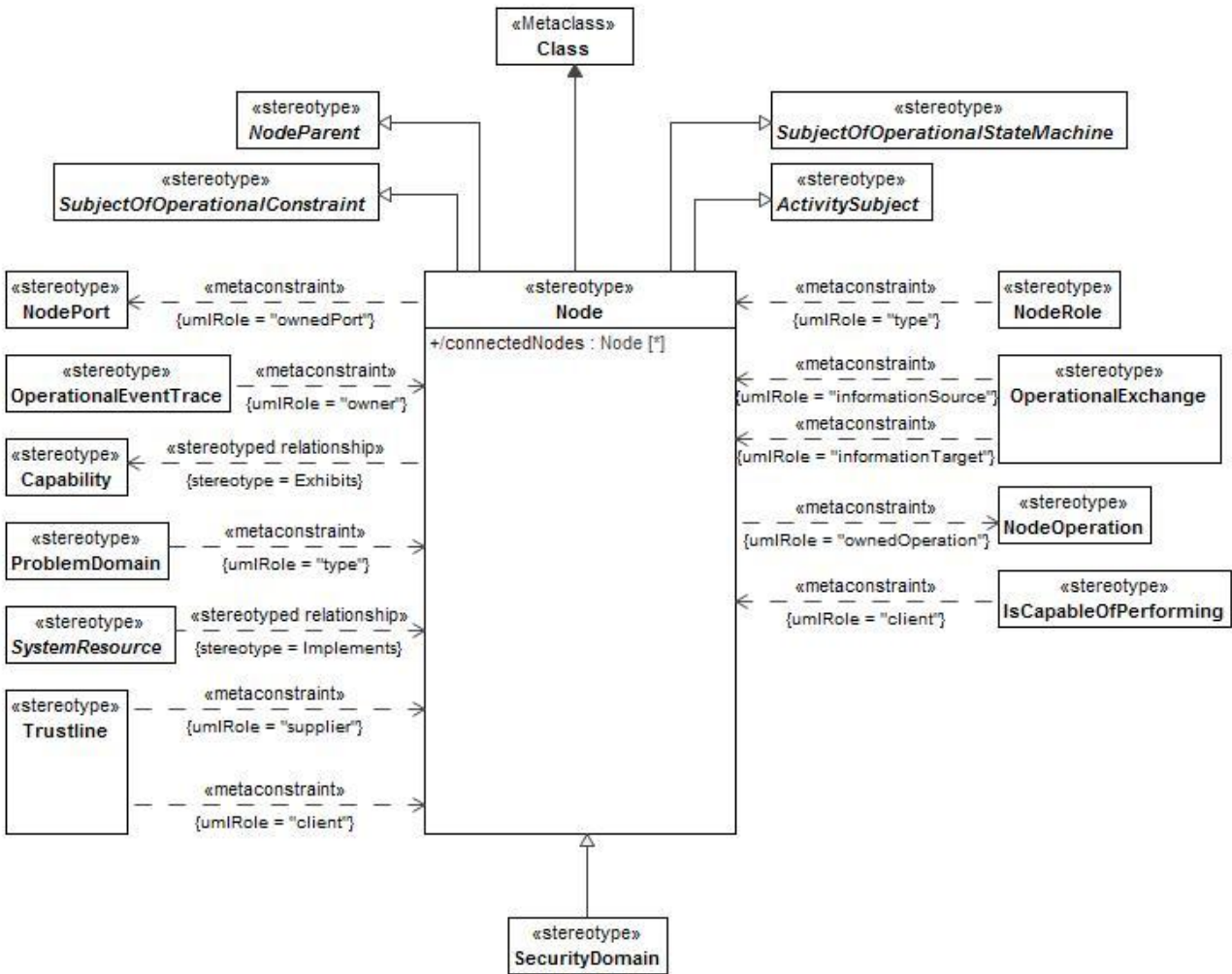

Figure 8:60 - Node

- **Constraints**

The following are constraints for Node:

- **Node.isCapableOfPerforming** - Is capable of performing only «OperationalActivity» elements or its specializations.
- **Node.ownedOperation** - Values for the ownedOperation property must be stereotyped «NodeOperation» or its specializations.
- **Node.ownedPort** - Values for the ownedPort property must be stereotyped «NodePort», «ServicePort», or their specializations.

- **Attributes**

The following are attributes for Node:

- connectedNodes : Node[*] -

- **Extensions**

The following metaclasses are extended by Node:

- Class

- **Specializations**

The Node element is a specialization of:

- ActivitySubject
- SubjectOfOperationalConstraint
- NodeParent
- SubjectOfOperationalStateMachine

8.2.1.1.4.4.11 NodeParent

UPDM: An abstract element representing the owners/context of composite structure at the operational level.

MODAF: The abstract supertype of all elements that can have child Nodes (LogicalArchitecture, ProblemDomain & NodeType).

DoDAF: NA

Note: NodeParent is abstract.

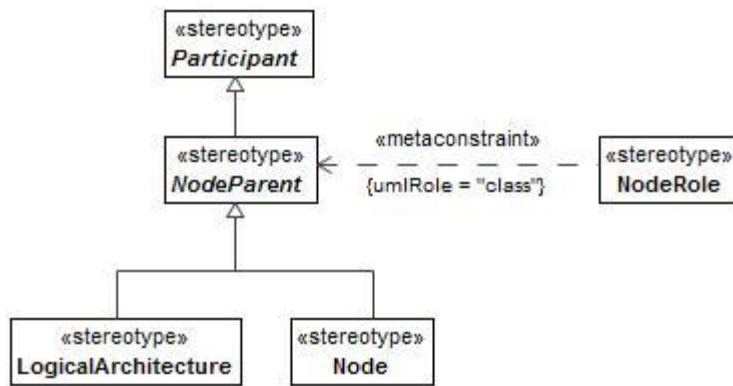

Figure 8:61 - NodeParent

- **Specializations**

The NodeParent element is a specialization of:

- Participant

8.2.1.1.4.4.12 NodePort

UPDM: A port is a property of a Node that specifies a distinct interaction point between the node and its environment or between the (behavior of the) node and its internal parts. It is the “entry/exit” point where resources (e.g., energy, information/data and people, etc.) flow in and out of a node.

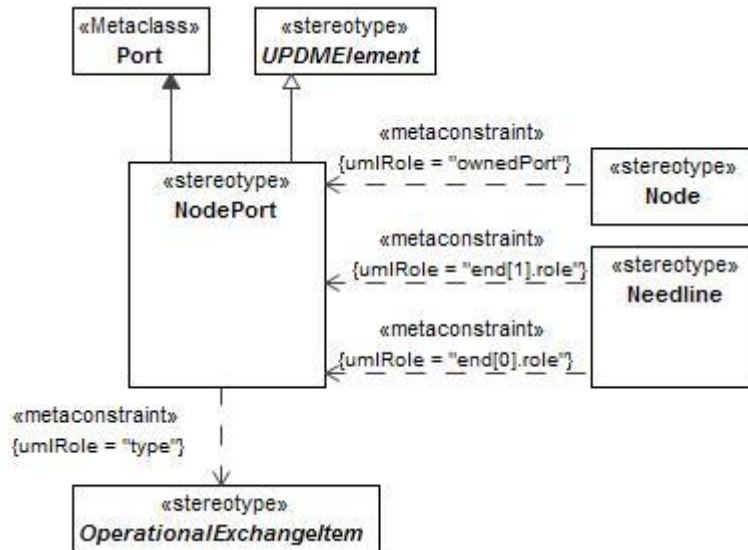

Figure 8:62 - NodePort

- **Constraints**

The following are constraints for NodePort:

- **NodePort.type** - Value for the type property must be stereotyped specialization of «OperationalExchangeItem».

- **Extensions**

The following metaclasses are extended by NodePort:

- Port

- **Specializations**

The NodePort element is a specialization of:

- UPDMElement

8.2.1.1.4.4.13 NodeRole

MODAF: A NodeRole (MODAF::Node) is used to link a parent Node to its sub-nodes.

DoDAF: NA

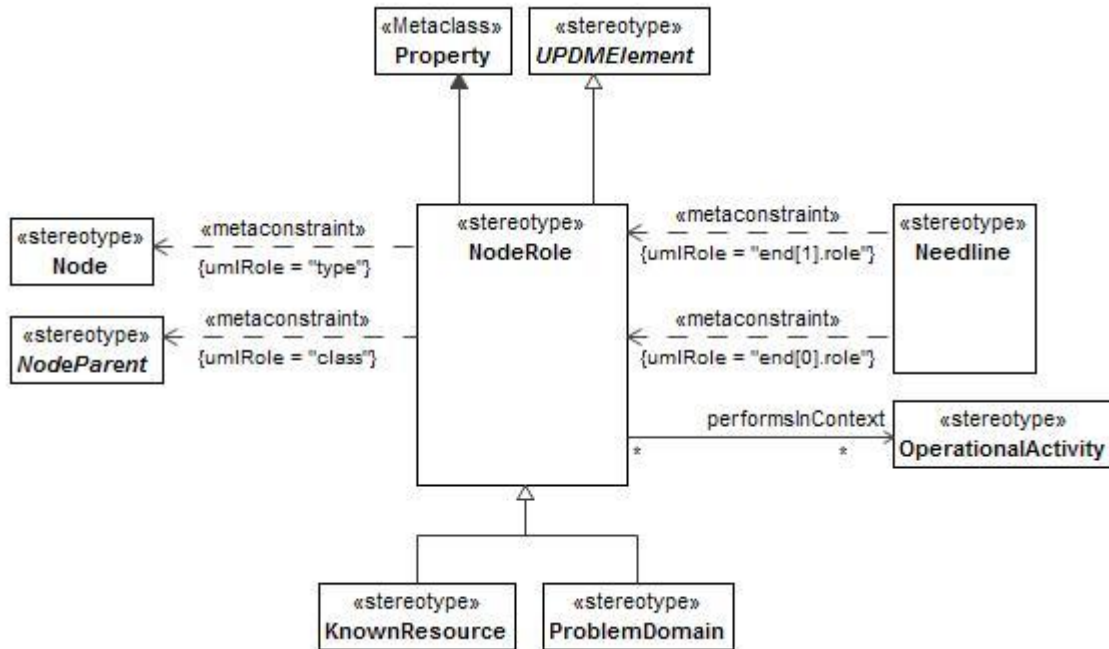

Figure 8:63 - NodeRole

- **Constraints**

The following are constraints for NodeRole:

- **NodeRole.class** - Value for class meta property must be stereotyped a specialization of «NodeParent».
- **NodeRole.type** - Value for type meta property must be stereotyped «Node» or its specializations.

- **Attributes**

The following are attributes for NodeRole:

- **performsInContext**: OperationalActivity[*] - OperationalActivity Performed in the context of a specific role.

- **Extensions**

The following metaclasses are extended by NodeRole:

- Property

- **Specializations**

The NodeRole element is a specialization of:

- UPDMElement

8.2.1.1.4.4.14 OperationalConstraint

UPDM: An abstract Class that is extended by OperationalConstraint (a rule governing an operational behavior or property) and ResourceConstraint.

MODAF: A rule governing an operational behavior or property.

DoDAF: A principle or condition that governs behavior; a prescribed guide for conduct or action (Rule).

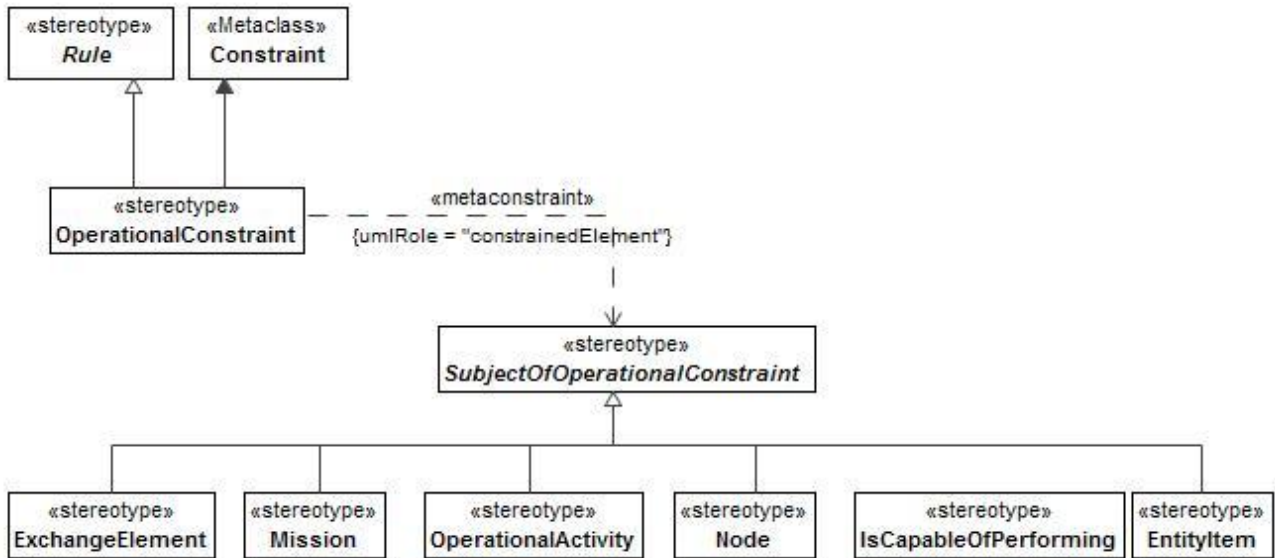

Figure 8:64 - OperationalConstraint

- **Constraints**

The following are constraints for OperationalConstraint:

- **OperationalConstraint.constrainedElement** - Value for the constrainedElement property must be stereotyped by any specialization of «SubjectOfOperationalConstraint».

- **Extensions**

The following metaclasses are extended by OperationalConstraint:

- Constraint

- **Specializations**

The OperationalConstraint element is a specialization of:

- UPDMElement
- Rule

8.2.1.1.4.4.15 SecurityDomain

MODAF: NA

DoDAF: A NodeType whose members (other Nodes, KnownResources) all share a common security policy.

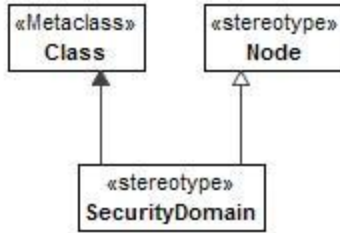

Figure 8:65 - SecurityDomain

- **Extensions**

The following metaclasses are extended by SecurityDomain:

- Class

- **Specializations**

The SecurityDomain element is a specialization of:

- Node

8.2.1.1.4.4.16 SubjectOfOperationalConstraint

MODAF: Abstract - An element of the architecture that may be subject to an OperationalConstraint or OperationalStateDescription.

Note: SubjectOfOperationalConstraint is abstract.

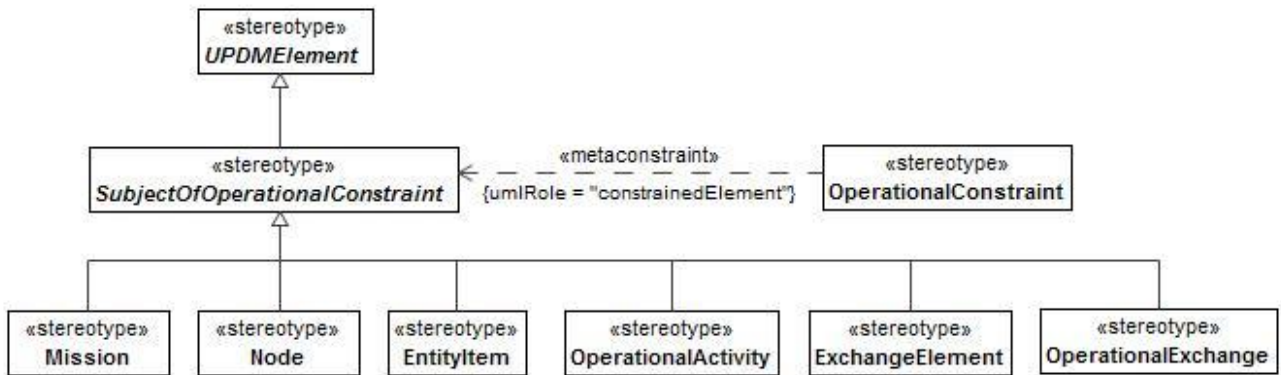

Figure 8:66 - SubjectOfOperationalConstraint

- **Specializations**

The SubjectOfOperationalConstraint element is a specialization of:

- UPDMElement

8.2.1.1.4.4.17 UPDM L1::UPDM L0::Core::OperationalElements::Structure::Organizational

The organizational elements of the operational structure.

8.2.1.1.4.4.17.1 UPDM L1::UPDM
 L0::Core::OperationalElements::Structure::Organizational::Actual

Actual elements in the organizational part of the structural part of the Operational profile.

8.2.1.1.4.4.17.1.1 ActualOrganization

MODAF: An actual specific organization, an instance of an organization class - e.g., "The US Department of Defense."

DoDAF: [DoDAF::Organization]: A specific real-world assemblage of people and other resources organized for an on-going purpose.

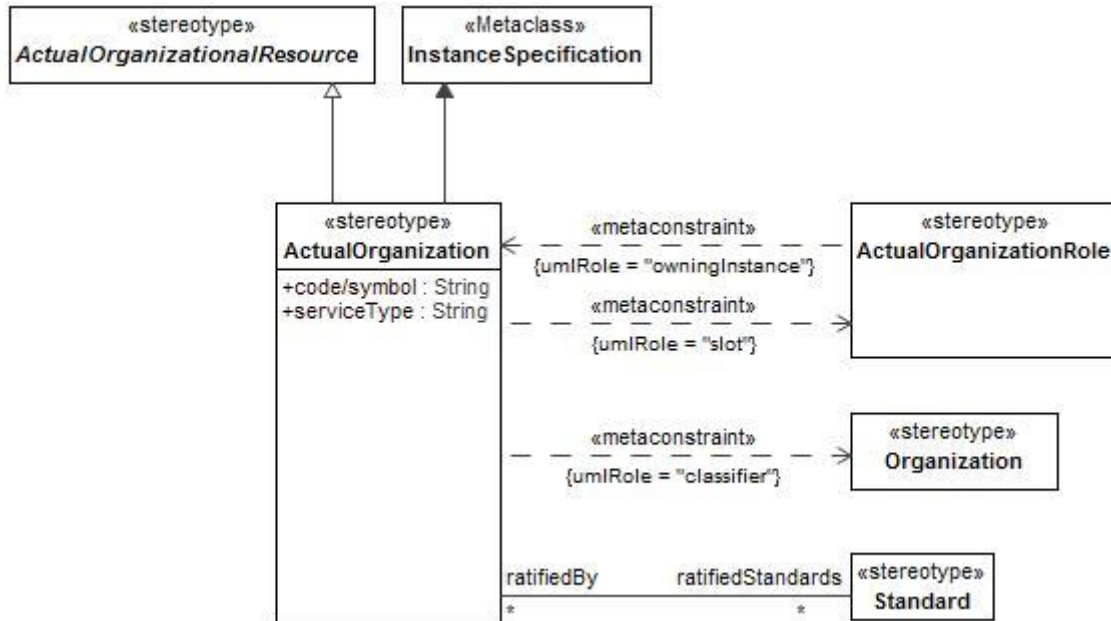

Figure 8:67 - ActualOrganization

• **Constraints**

The following are constraints for ActualOrganization:

- **ActualOrganization.classifier** - Classifier property value must be stereotyped «Organization» or its specializations.
- **ActualOrganization.slot** - Slot property value must be stereotyped «ActualOrganizationRole» or its specializations.

• **Attributes**

The following are attributes for ActualOrganization:

- code/symbol : String[] - Army, Navy, Air Force, Marine Corps, Joint
- ratifiedStandards: Standard[*] - Standards that were ratified by this ActualOrganization.
- serviceType : String[] - Service office code or symbol

• **Extensions**

The following metaclasses are extended by ActualOrganization:

- InstanceSpecification

- **Specializations**

The ActualOrganization element is a specialization of:

- ActualOrganizationalResource

8.2.1.1.4.4.17.1.2 ActualOrganizationalResource

UPDM: An ActualOrganization or an ActualPost.

MODAF: An instance of either an actual organization or an actual post.

DoDAF: A specific real-world assemblage of people and other resources organized for an on-going purpose.

Note: ActualOrganizationalResource is abstract.

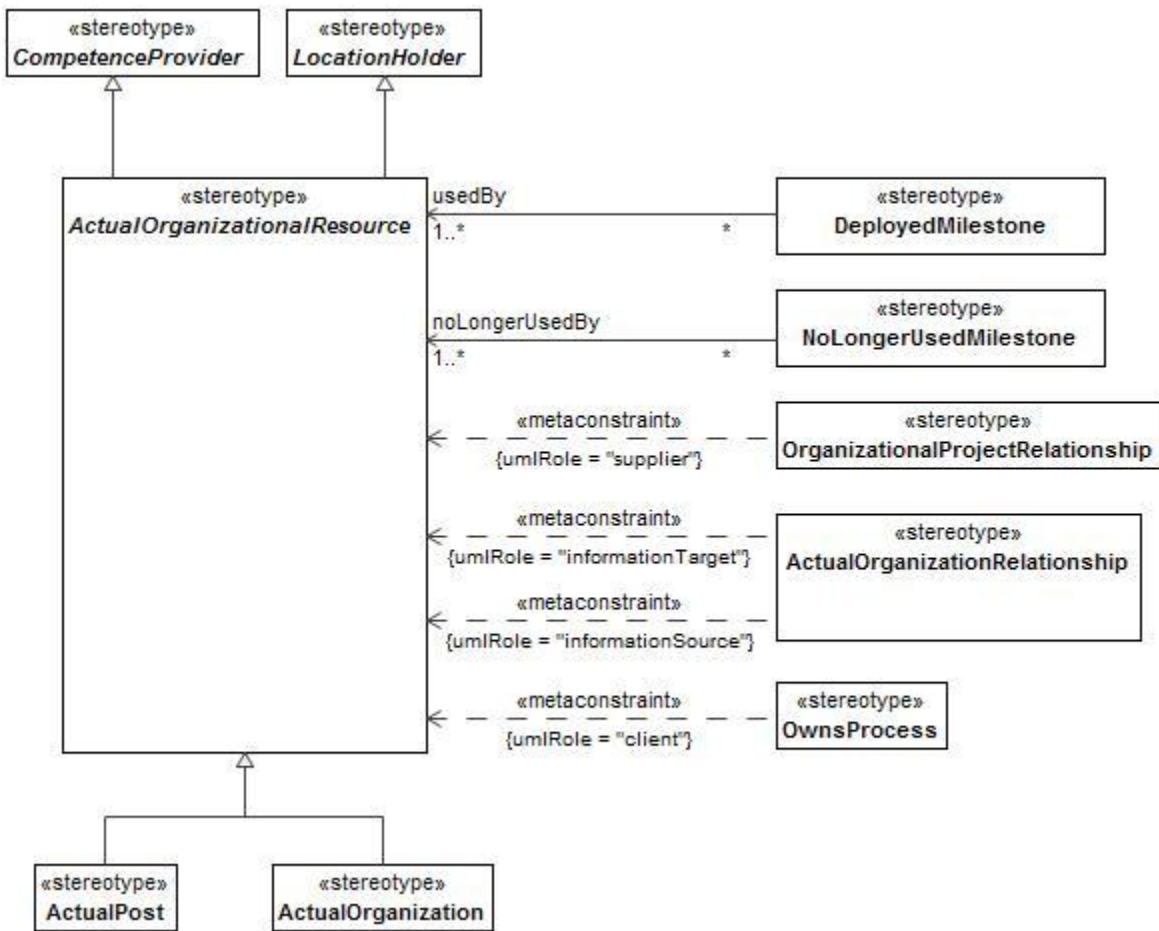

Figure 8:68 - ActualOrganizationalResource

- **Specializations**

The ActualOrganizationalResource element is a specialization of:

- LocationHolder
- CompetenceProvider

8.2.1.1.4.4.17.1.3 ActualOrganizationRelationship

UPDM: A relationship between two ActualOrganizationResources.

MODAF: A relationship between two actual specific organizations or parts of an organization.

DoDAF: NA

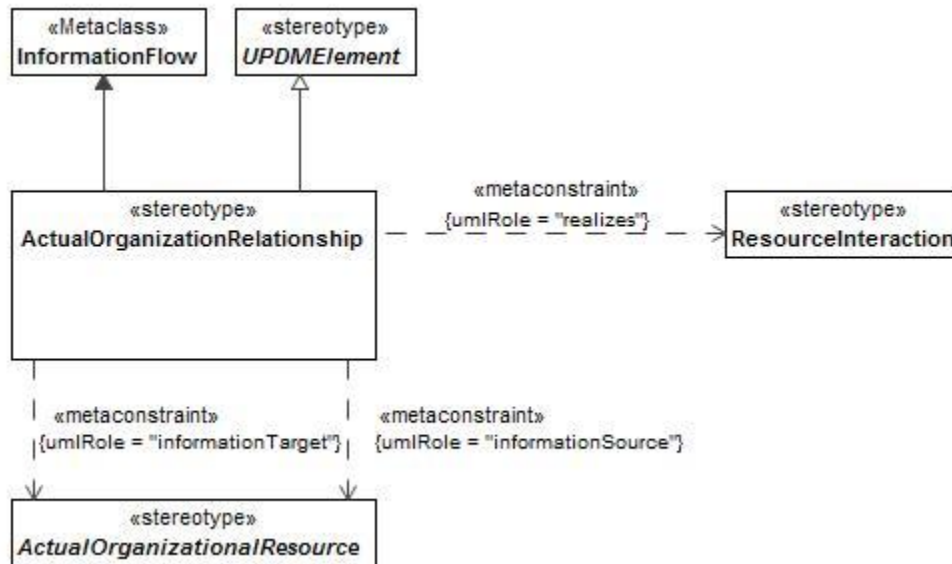

Figure 8:69 - ActualOrganizationRelationship

- **Constraints**

The following are constraints for ActualOrganizationRelationship:

- ActualOrganizationRelationship.conveyed - Value for conveyed metaproperty must be stereotyped <<ExchangeElement>> or its specializations.
- ActualOrganizationRelationship.source - Value for source metaproperty must be stereotyped <<ActualOrganizationalResource>> or its specializations.
- ActualOrganizationRelationship.target - Value for realizes metaproperty must be stereotyped <<ResourceInteraction>> or its specializations.

- **Extensions**

The following metaclasses are extended by ActualOrganizationRelationship:

- InformationFlow

- **Specializations**

The ActualOrganizationRelationship element is a specialization of:

- UPDMElement

8.2.1.1.4.4.17.1.4 ActualOrganizationRole

UPDM: Relates an actual specific organization to an actual specific organizational resource that fulfills a role in that organization.

MODAF: NA
DoDAF: NA

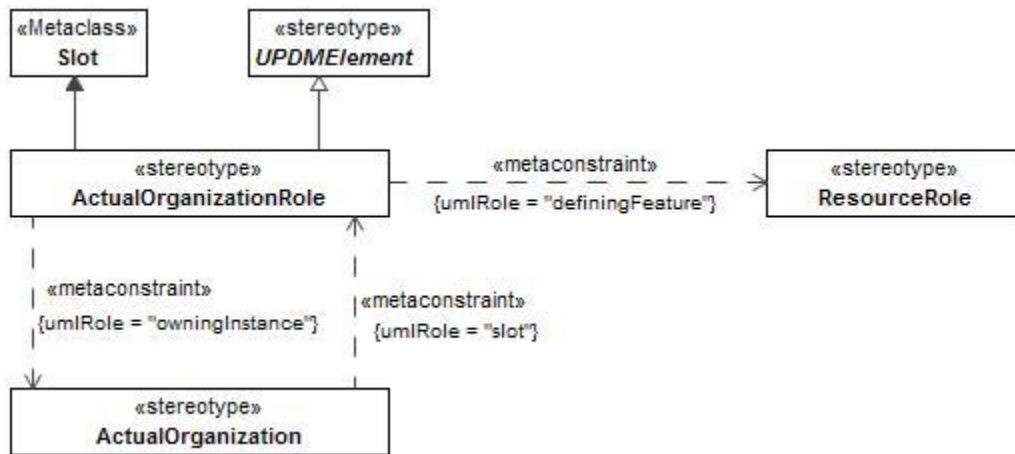

Figure 8:70 - ActualOrganizationRole

- **Constraints**

The following are constraints for ActualOrganizationRole:

- **ActualOrganizationPart.definingFeature** - Value for definingFeature property has to be stereotyped «ResourceRole» or its specializations.
- **ActualOrganizationPart.owningInstance** - Value for owningInstance property has to be stereotyped «ActualOrganization» or its specializations.

- **Extensions**

The following metaclasses are extended by ActualOrganizationRole:

- Slot

- **Specializations**

The ActualOrganizationRole element is a specialization of:

- UPDMElement

8.2.1.1.4.4.17.1.5 ActualPerson

UPDM: Named individual that fulfills an ActualPost. An individual human being (vs Person which is a type), that is recognized by law as the subject of rights and duties.

MODAF: NA

DoDAF: An individual person

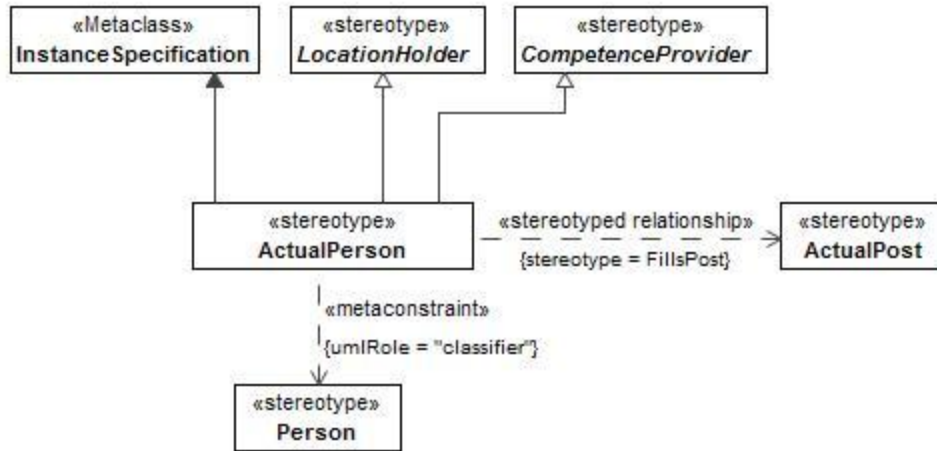

Figure 8:71 - ActualPerson

- **Constraints**

The following are constraints for ActualPerson:

- **ActualPerson.classifier** - Value for the classifier property has to be stereotyped «Person» or its specializations.

- **Extensions**

The following metaclasses are extended by ActualPerson:

- InstanceSpecification

- **Specializations**

The ActualPerson element is a specialization of:

- LocationHolder
- CompetenceProvider

8.2.1.1.4.4.17.1.6 ActualPost

UPDM: An actual, specific post, an instance of a PostType class - e.g., "President of the United States of America."

MODAF: NA

DoDAF: NA

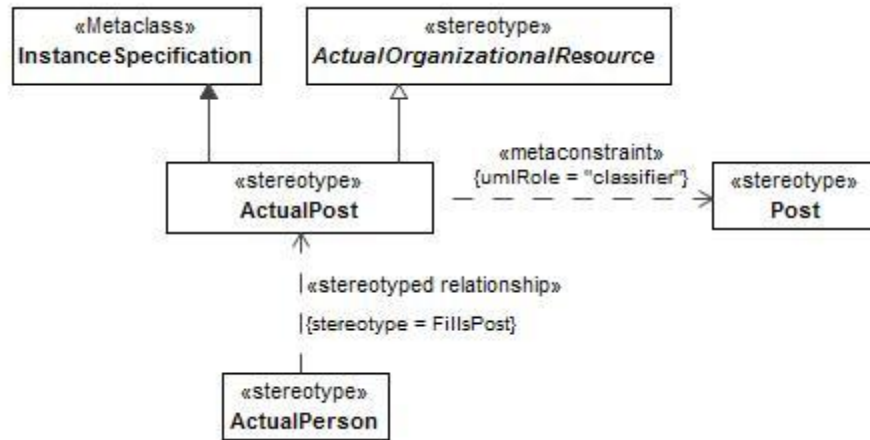

Figure 8:72 - ActualPost

- **Constraints**

The following are constraints for ActualPost:

- **ActualPost.classifier** - Classifier property value must be stereotyped <<Post>> or its specializations.

- **Extensions**

The following metaclasses are extended by ActualPost:

- InstanceSpecification

- **Specializations**

The ActualPost element is a specialization of:

- ActualOrganizationalResource

8.2.1.1.4.4.17.1.7 CompetenceProvider

UPDM: Abstract element used to group ActualPersons and ActualOrganizationalResources.

MODAF: NA

DoDAF: NA

Note: CompetenceProvider is abstract.

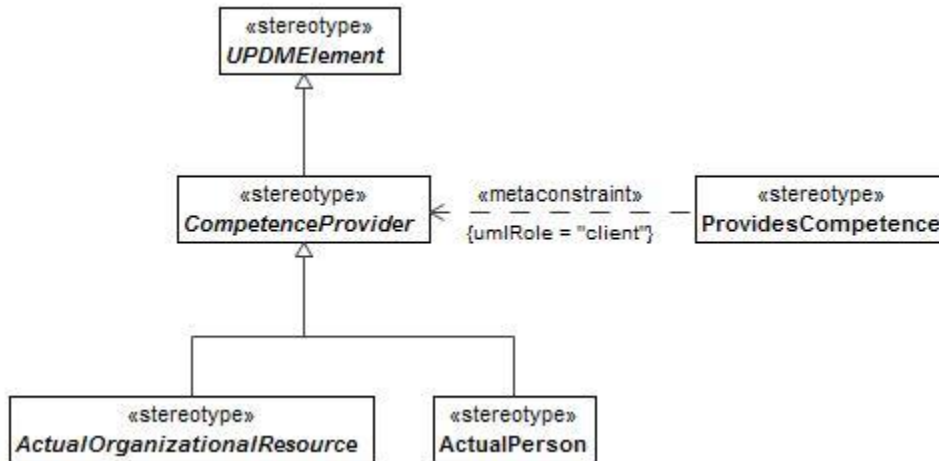

Figure 8:73 - CompetenceProvider

- Specializations

The CompetenceProvider element is a specialization of:

- UPDMElement

8.2.1.1.4.4.17.1.8 FillsPost

UPDM: Asserts that ActualPerson fills an ActualPost.

MODAF: NA

DoDAF: NA

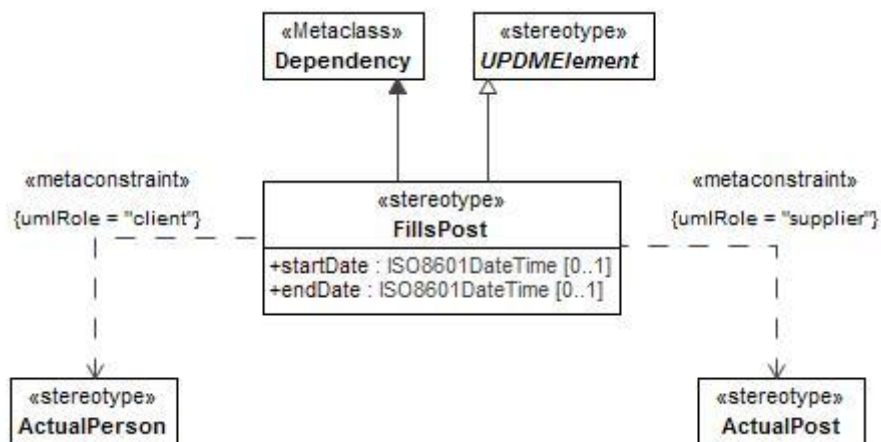

Figure 8:74 - FillsPost

- Constraints

The following are constraints for FillsPost:

- **FillsPost.client** - Value for the client property must be stereotyped by «ActualPerson» or its specializations.
- **FillsPost.supplier** - Value for the supplier property must be stereotyped by «ActualPost» or its specializations.

- **Attributes**

The following are attributes for FillsPost:

- endDate : ISO8601DateTime[0..1] - End date
- startDate : ISO8601DateTime[0..1] - Start date

- **Extensions**

The following metaclasses are extended by FillsPost:

- Dependency

- **Specializations**

The FillsPost element is a specialization of:

- UPDMElement

8.2.1.1.4.4.17.2 UPDM L1::UPDM L0::Core::OperationalElements::Structure::Organizational::Typical

Typical elements in the organizational part of the structural part of the Operational profile.

8.2.1.1.4.4.17.2.1 CompetenceRequirer

UPDM: Abstract element used to group Organizations, Post and Responsibilities.

MODAF: NA

DoDAF: NA

Note: CompetenceRequirer is abstract.

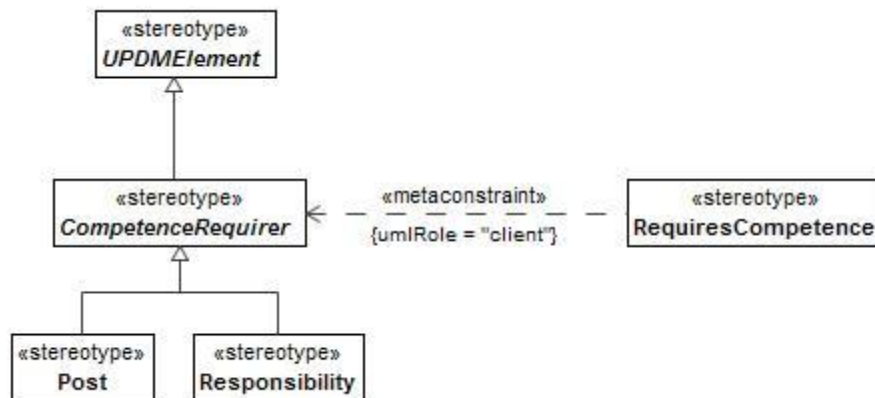

Figure 8:75 - CompetenceRequirer

- **Specializations**

The CompetenceRequirer element is a specialization of:

- UPDMElement

8.2.1.1.4.4.17.2.2 Organization

MODAF: A group of persons, associated for a particular purpose.

DoDAF: A type of Organization.

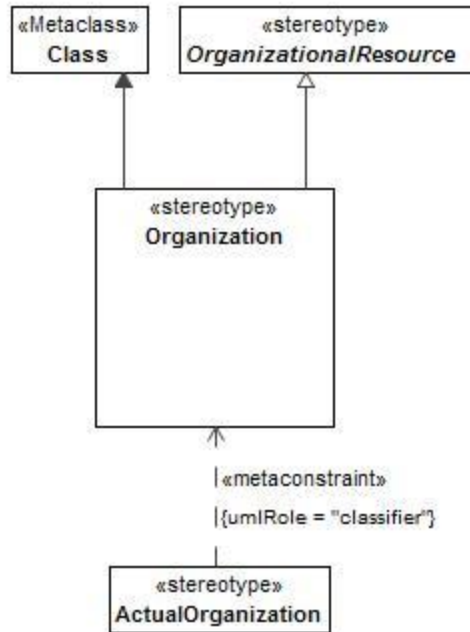

Figure 8:76 - Organization

- **Extensions**

The following metaclasses are extended by Organization:

- Class

- **Specializations**

The Organization element is a specialization of:

- OrganizationalResource

8.2.1.1.4.4.17.2.3 OrganizationalResource

UPDM: An abstract element that represents Organizations and Posts.

MODAF: Either an organization or a post.

Note: OrganizationalResource is abstract.

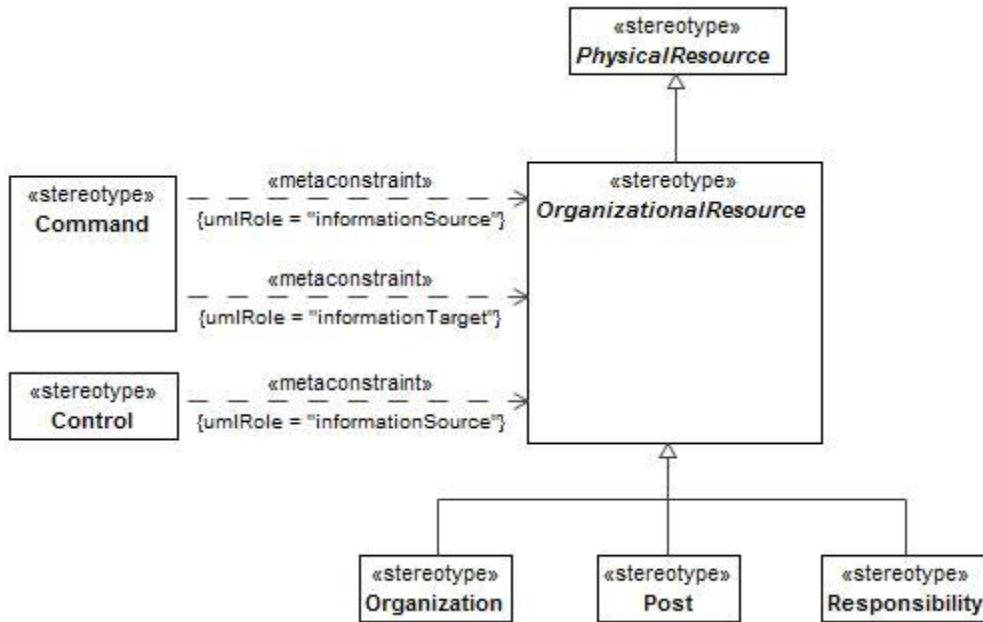

Figure 8:77 - OrganizationalResource

- Specializations

The OrganizationalResource element is a specialization of:

- PhysicalResource

8.2.1.1.4.4.17.2.4 Person

UPDM: A type of a human being that is recognized by law as the subject of rights and duties. This is used to define the characteristics that require capturing for ActualPersons (e.g., properties such as address, rank, telephone number, etc).

MODAF: NA

DoDAF: NA

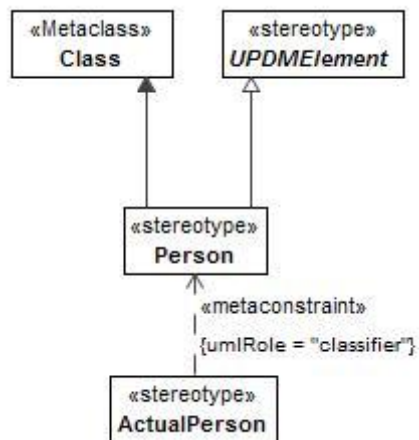

Figure 8:78 - Person

- **Extensions**

The following metaclasses are extended by Person:

- Class

- **Specializations**

The Person element is a specialization of:

- UPDMElement

8.2.1.1.4.4.17.2.5 Post

MODAF: A Post (MODAF::PostType) is a type of point of contact or responsible person. Note that this is the type of post - e.g., Desk Officer, Commander Land Component, etc.

DoDAF: A Post (DoDAF:: PersonType) is a category of persons defined by the role or roles they share that are relevant to an architecture.

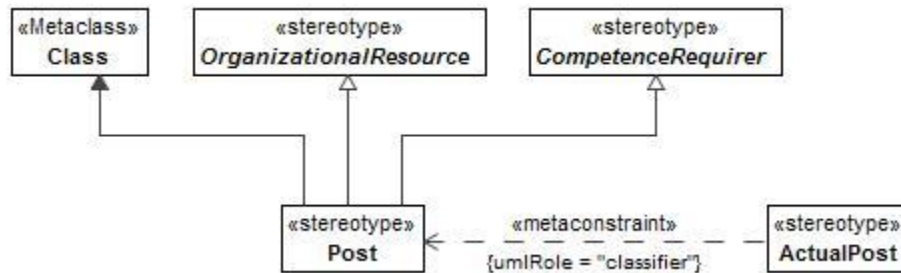

Figure 8:79 - Post

- **Extensions**

The following metaclasses are extended by Post:

- Class

- **Specializations**

The Post element is a specialization of:

- OrganizationalResource
- CompetenceRequirer

8.2.1.1.4.4.17.2.6 ProvidesCompetence

UPDM: Asserts that a Resource type provides a competence.

MODAF: Asserts that a Role requires a Competence (MODAF::CompetenceForRole).

DoDAF: An overlap between a Personnel Type and the Skills it entails (DoDAF:: skillPartOfPersonType).

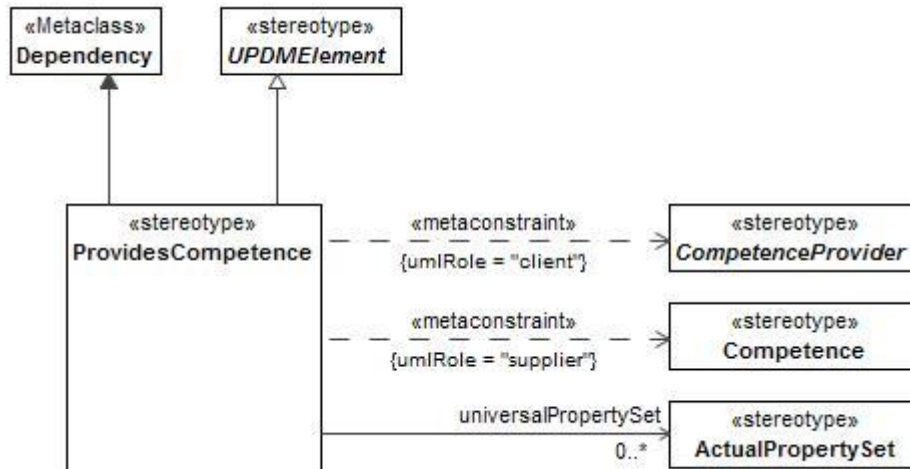

Figure 8:80 - ProvidesCompetence

- **Constraints**

The following are constraints for ProvidesCompetence:

- ProvidesCompetence.client - Value for the client property must be stereotyped by a specialization of «CompetenceProvider».
- ProvidesCompetence.supplier - Value for the client property must be stereotyped «Competence» or its specializations.

- **Attributes**

The following are attributes for ProvidesCompetence:

- universalPropertySet: ActualPropertySet[0..*] - The measurements associated with a Competence.

- **Extensions**

The following metaclasses are extended by ProvidesCompetence:

- Dependency

- **Specializations**

The ProvidesCompetence element is a specialization of:

- UPDMElement

8.2.1.1.4.4.17.2.7 RequiresCompetence

MODAF: Asserts that a Role requires a Competence (MODAF::CompetenceForRole).

DoDAF: An overlap between a Personnel Type and the Skills it entails (DoDAF:: SkillPartOfPersonType).

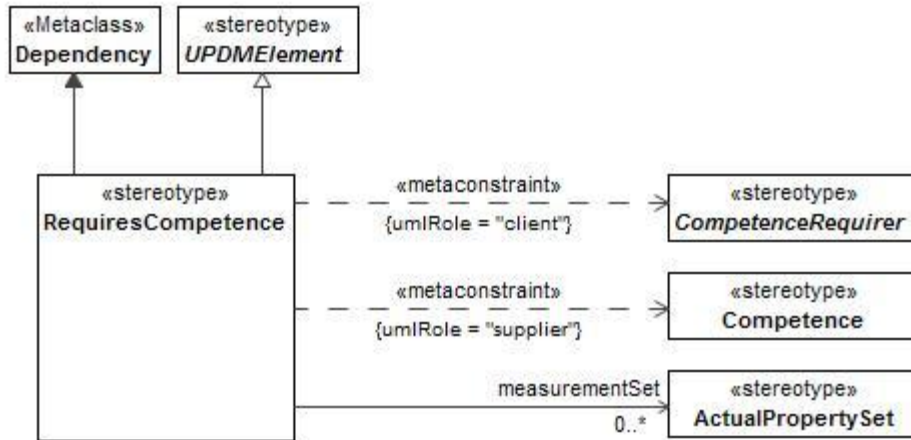

Figure 8:81 - RequiresCompetence

- **Constraints**

The following are constraints for RequiresCompetence:

- RequiresCompetence.client - Value for the client property must be stereotyped a specialization of «CompetenceRequirer».
- RequiresCompetence.supplier - Value for the client property must be stereotyped «Competence» or its specializations.

- **Attributes**

The following are attributes for RequiresCompetence:

- measurementSet: ActualPropertySet[0..*] - The measurements associated with a Competence.

- **Extensions**

The following metaclasses are extended by RequiresCompetence:

- Dependency

- **Specializations**

The RequiresCompetence element is a specialization of:

- UPDMElement

8.2.1.1.4.4.17.2.8 Responsibility

UPDM: Asserts that a Post or Organization has specific responsibilities.

MODAF: NA

DoDAF: NA

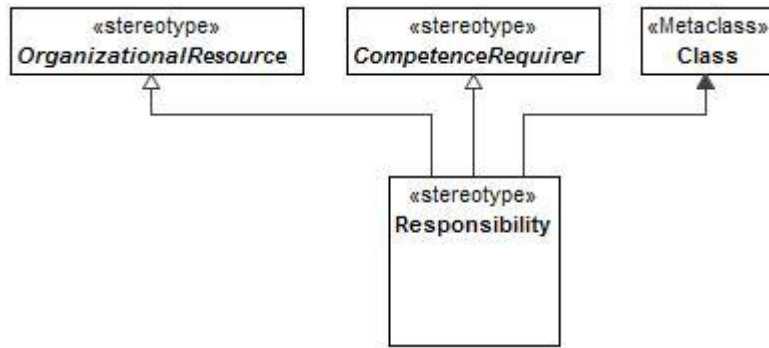

Figure 8:82 - Responsibility

- **Extensions**

The following metaclasses are extended by Responsibility:

- Class

- **Specializations**

The Responsibility element is a specialization of:

- CompetenceRequirer
- OrganizationalResource

8.2.1.1.5 UPDM L1::UPDM L0::Core::ServiceElements

The Service-Oriented View (SOV) is a description of services needed to directly support the operational domain as described in the Operational View. A service should be understood in its broadest sense, as a unit of work through which a provider provides a useful result to a consumer. This could be anything from web-based services to delivering an effect, to transporting troops.

8.2.1.1.5.1 UPDM L1::UPDM L0::Core::ServiceElements::Behavior

Behavior elements of the service oriented view.

8.2.1.1.5.1.1 ServiceFeature

UPDM: Abstract grouping used to ServiceFunctions to Serviceoperations and ServiceMessageHandlers.

Note: ServiceFeature is abstract.

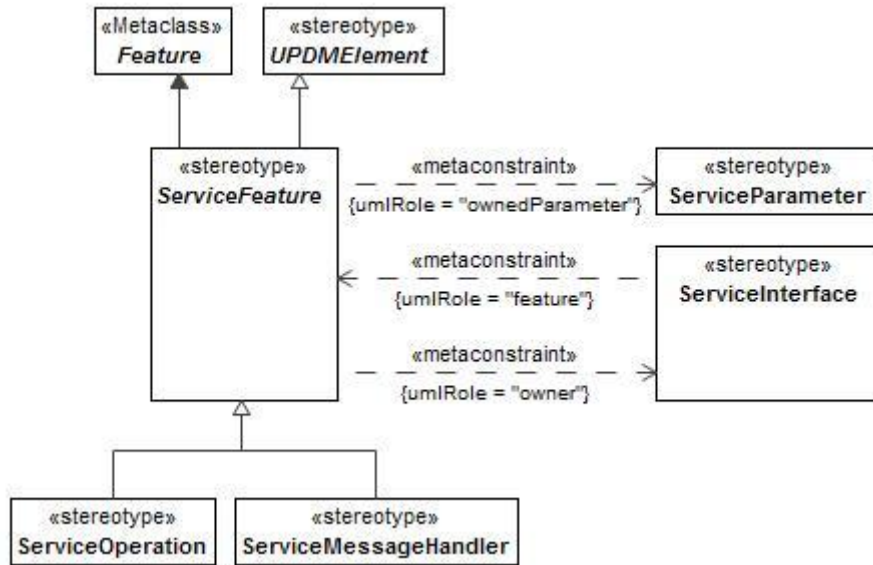

Figure 8:83 - ServiceFeature

- **Constraints**

The following are constraints for ServiceFeature:

- **ServiceFeature.ownedParameter** - The values for the ownedParameter property must be stereotyped «ServiceParameter».
- **ServiceFeature.owner** - The values for the owner property must be stereotyped «ServiceInterface».

- **Extensions**

The following metaclasses are extended by ServiceFeature:

- Feature

- **Specializations**

The ServiceFeature element is a specialization of:

- UPDMElement

8.2.1.1.5.1.2 ServiceFunction

UPDM: A ServiceFunction describes the abstract behavior of ServiceOperations, regardless of the actual implementation.

MODAF: A type of activity describing the functionality of a service.

DoDAF: Information necessary to interact with the service in such terms as the service inputs, outputs, and associated semantics. The service description also conveys what is accomplished when the service is invoked and the conditions for using the service.

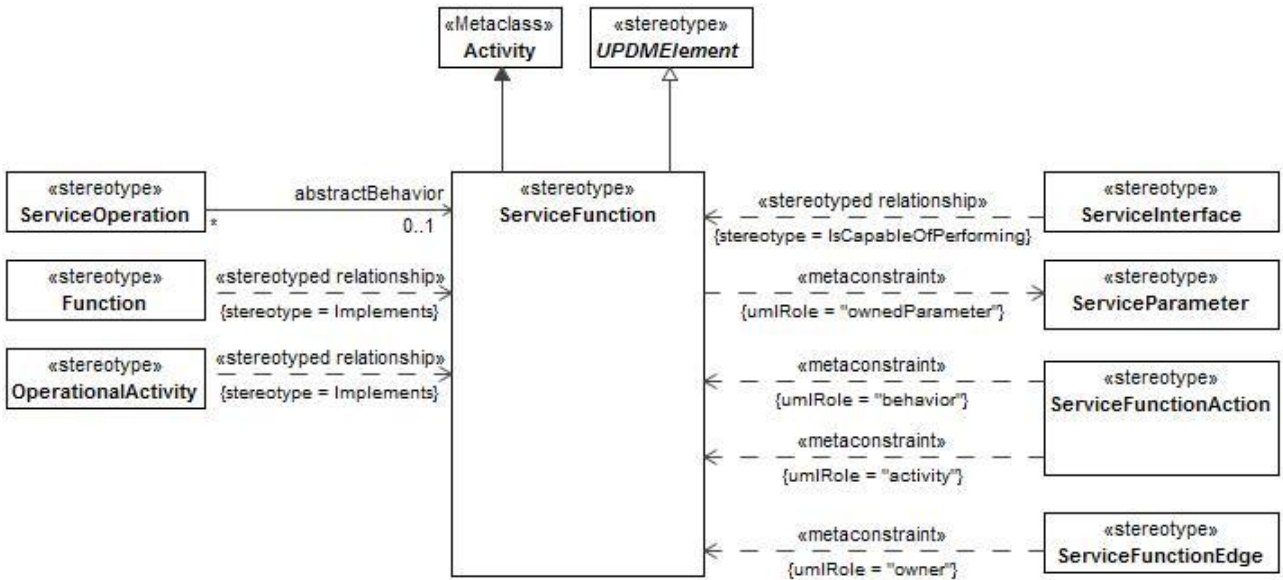

Figure 8:84 - ServiceFunction

- **Constraints**

The following are constraints for ServiceFunction:

- **ServiceFunction.ownedParameter** - The values for the ownedParameter property must be stereotyped «ServiceParameter».

- **Extensions**

The following metaclasses are extended by ServiceFunction:

- Activity

- **Specializations**

The ServiceFunction element is a specialization of:

- UPDMElement

8.2.1.1.5.1.3 ServiceFunctionAction

UPDM: A call behavior action that invokes the ServiceFunction that needs to be preformed. This concept is required for mapping the architecture with UML and does not have a DoDAF or MoDAF equivalent.

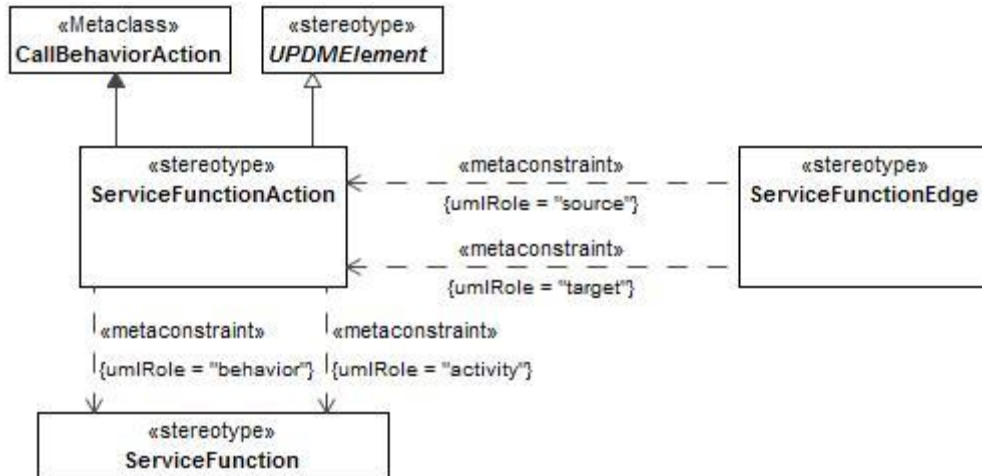

Figure 8:85 - ServiceFunctionAction

- **Constraints**

The following are constraints for ServiceFunctionAction:

- **ServiceFunctionAction.activity** - Value for the behavior property must be stereotyped «ServiceFunction» or its specializations.
- **ServiceFunctionAction.behavior** - Value for the activity property must be stereotyped «ServiceFunction» or its specializations.

- **Extensions**

The following metaclasses are extended by ServiceFunctionAction:

- CallBehaviorAction

- **Specializations**

The ServiceFunctionAction element is a specialization of:

- UPDMElement

8.2.1.1.5.1.4 ServiceFunctionEdge

UPDM: An extension of <<ActivityEdge>> that is used to model the flow of control/objects through a ServiceFunction.

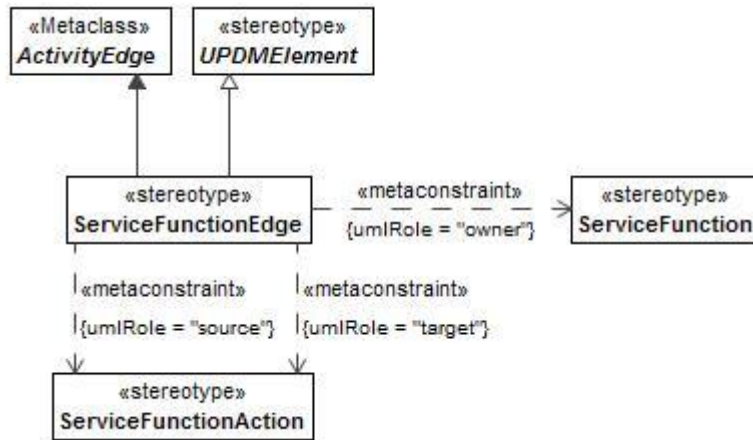

Figure 8:86 - ServiceFunctionEdge

- **Constraints**

The following are constraints for ServiceFunctionEdge:

- **ServiceFunctionEdge.owner** - Value for the target property must be **stereotyped** «ServiceFunction» or its specializations.

- **Extensions**

The following metaclasses are extended by ServiceFunctionEdge:

- ActivityEdge

- **Specializations**

The ServiceFunctionEdge element is a specialization of:

- UPDMElement

8.2.1.1.5.1.5 ServiceInteraction

UPDM: Interaction for a service interface.

MODAF: A model representing how a set of Service classes interacts with one another (MODAF::ServiceInteractionSpecification).

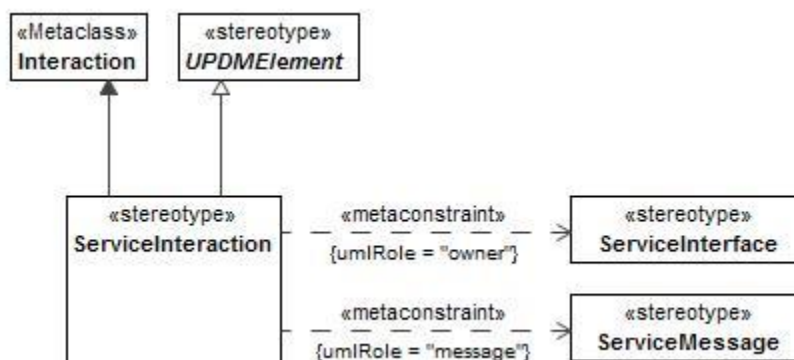

Figure 8:87 - ServiceInteraction

- **Constraints**

The following are constraints for ServiceInteraction:

- **ServiceInteraction.message** - Values for the message property must be stereotyped with «ServiceMessage» or its specializations.
- **ServiceInteraction.owner** - Value for the target property must be stereotyped «ServiceInterface» or its specializations.

- **Extensions**

The following metaclasses are extended by ServiceInteraction:

- Interaction

- **Specializations**

The ServiceInteraction element is a specialization of:

- UPDMElement

8.2.1.1.5.1.6 ServiceMessage

UPDM: Message for use in a Service Interaction Specification, implements a resourceInteraction or any of the subtypes.

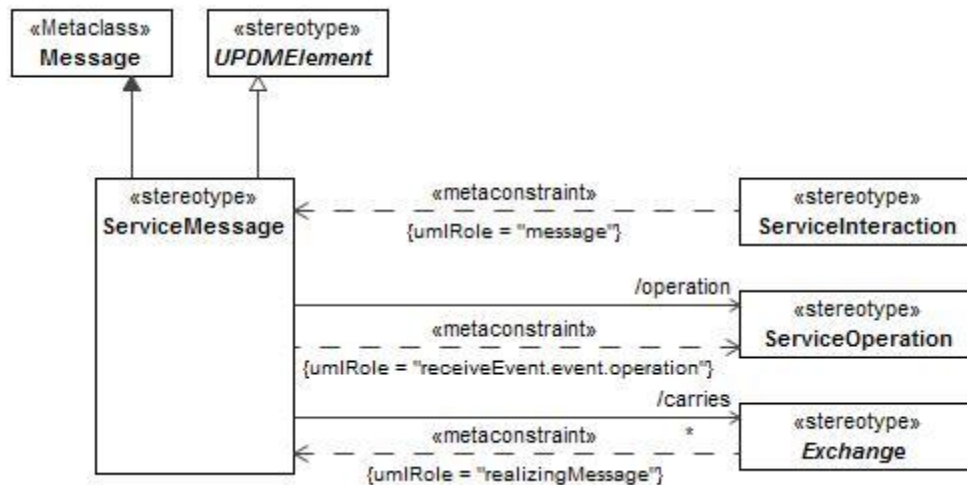

Figure 8:88 - ServiceMessage

- **Constraints**

The following are constraints for ServiceMessage:

- **ServiceMessage.receiveEvent.event.operation** - Values for the receiveEvent.event.operation property must be stereotyped with «ServiceOperation» or its specializations.

- **Attributes**

The following are attributes for ServiceMessage:

- carries: Exchange[*] - Carried ResourceInteraction.

- operation : ServiceOperation[] -

- **Extensions**

The following metaclasses are extended by ServiceMessage:

- Message

- **Specializations**

The ServiceMessage element is a specialization of:

- UPDMElement

8.2.1.1.5.1.7 ServiceMessageHandler

UPDM: An instance of an AsynchronousMessage, applied in the service domain.

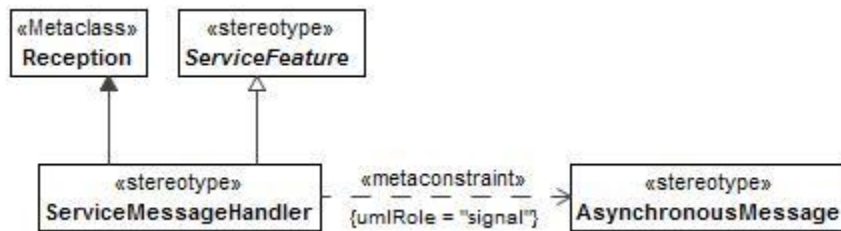

Figure 8:89 - ServiceMessageHandler

- **Constraints**

The following are constraints for ServiceMessageHandler:

- **ServiceMessageHandler.signal** - Values for the signal property must be stereotyped with «AsynchronousMessage» or its specializations.

- **Extensions**

The following metaclasses are extended by ServiceMessageHandler:

- Reception

- **Specializations**

The ServiceMessageHandler element is a specialization of:

- ServiceFeature

8.2.1.1.5.1.8 ServiceOperation

UPDM: A ServiceOperation provides the access point for invoking the behavior of a provided service. The ServiceOperations are defined on ServiceInterfaces and mirrored on the providing Resource to handle calls forwarded on by the interface.

MODAF: a function or procedure which enables programmatic communication with a Service via a ServiceInterface (MODAF:: ServiceInterfaceOpration).



Figure 8:90 - ServiceOperation

- **Constraints**

The following are constraints for ServiceOperation:

- **ServiceOperation.ownedParameter** - The values for the ownedParameter property must be stereotyped «ServiceParameter» or its specializations.

- **Attributes**

The following are attributes for ServiceOperation:

- **abstractBehavior** : ServiceFunction[0..1] - Links a ServiceOperation to the abstract description of its behavior, as provided by a ServiceFunction.

- **Extensions**

The following metaclasses are extended by ServiceOperation:

- Operation

- **Specializations**

The ServiceOperation element is a specialization of:

- ServiceFeature

8.2.1.1.5.1.9 ServiceParameter

UPDM: Represents inputs and outputs of Service. It is typed by ResourceInteractionItem.

MODAF: A constant or variable passed into or out of a ServiceInterface as part of the execution of a ServiceInterfaceOperation (MODAF:: ServiceInterfaceParameter).

DoDAF: NA

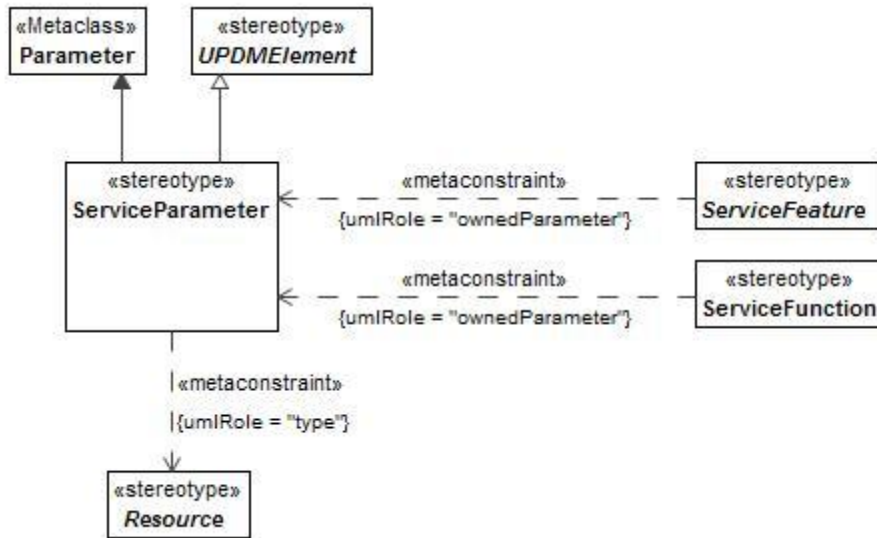

Figure 8:91 - ServiceParameter

- **Constraints**

The following are constraints for ServiceParameter:

- **ServiceParameter.type** - The values for the type property must be stereotyped a specialization of «Resource».

- **Extensions**

The following metaclasses are extended by ServiceParameter:

- Parameter

- **Specializations**

The ServiceParameter element is a specialization of:

- UPDMElement

8.2.1.1.5.1.10 ServiceStateMachine

UPDM Artifact that extends a UML StateMachine.

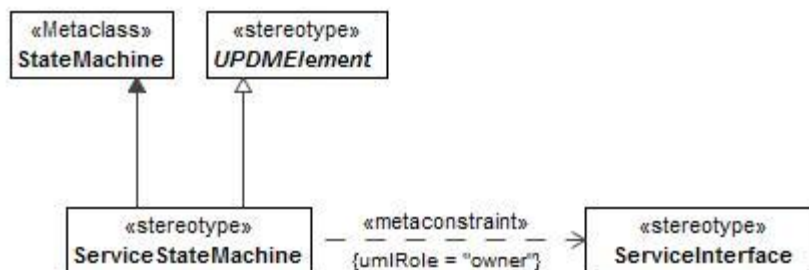

Figure 8:92 - ServiceStateMachine

- **Constraints**

The following are constraints for ServiceStateMachine:

- `ServiceStateMachine.owner` - Values for the owner property must be stereotyped `«ServiceInterface»` or its specializations.

- **Extensions**

The following metaclasses are extended by `ServiceStateMachine`:

- `StateMachine`

- **Specializations**

The `ServiceStateMachine` element is a specialization of:

- `UPDMElement`

8.2.1.1.5.2 UPDM L1::UPDM L0::Core::ServiceElements::Structure

Structure elements of the service oriented view.

8.2.1.1.5.2.1 AsynchronousMessage

MODAF: A signal which is transmitted irregularly with respect to time.

DoDAF: NA

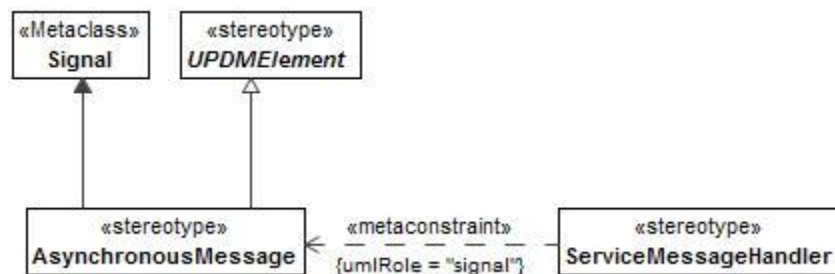

Figure 8:93 - AsynchronousMessage

- **Extensions**

The following metaclasses are extended by `AsynchronousMessage`:

- `Signal`

- **Specializations**

The `AsynchronousMessage` element is a specialization of:

- `UPDMElement`

8.2.1.1.5.2.2 Request

UPDM: From SoaML, A Request represents a feature of a Participant that is the consumption of a service by one participant provided by others using well-defined terms, conditions, and interfaces. A Request designates ports that define the connection point through which a Participant meets its needs through the consumption of services provided by others.

MODAF: Similar to requires, Asserts that a Resource requires a Service to be provided in order to function correctly.

DoDAF: Similar to ServicePort, A part of a Performer that specifies a distinct interaction point through which the Performer interacts with other Performers. This isolates dependencies between performers to particular interaction points rather than to the performer as a whole.

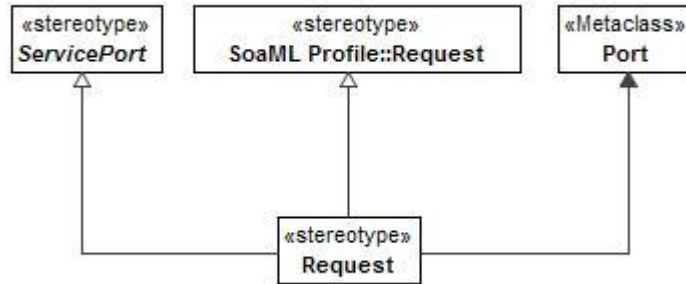

Figure 8:94 - Request

- **Extensions**

The following metaclasses are extended by Request:

- Port

- **Specializations**

The Request element is a specialization of:

- Request
- ServicePort

8.2.1.1.5.2.3 Service

MODAF: A type of delivered functionality, specified independently of the resources that provide it.

DoDAF: mechanism to enable access to a set of one or more capabilities , where the access is provided using a prescribed interface and is exercised consistent with constraints and policies as specified by the service description. The mechanism is a Performer. The "capabilities" accessed are Resources -- Information, Data, Material, Performers, and Geo-political Extents.

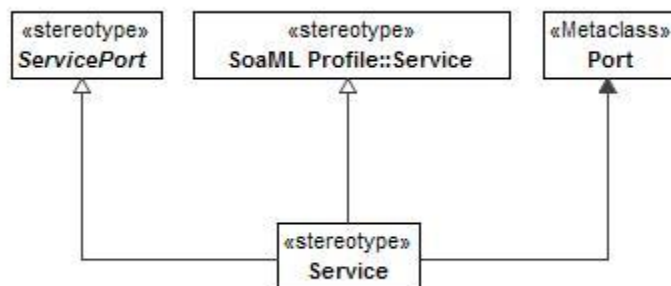

Figure 8:95 - Service

- **Extensions**

The following metaclasses are extended by Service:

- Port

- **Specializations**

The Service element is a specialization of:

- Service

- ServicePort

8.2.1.1.5.2.4 ServiceAttribute

MODAF: A property of Service.

DoDAF: NA

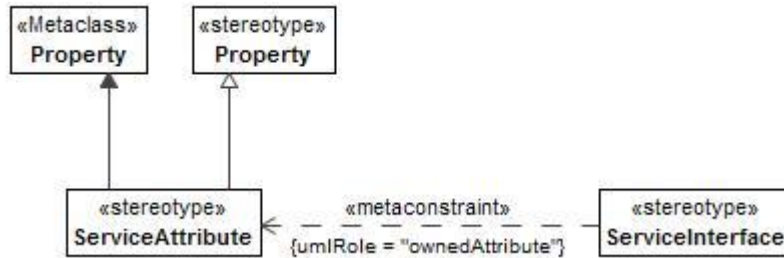

Figure 8:96 - ServiceAttribute

- **Extensions**

The following metaclasses are extended by ServiceAttribute:

- Property

- **Specializations**

The ServiceAttribute element is a specialization of:

- Property

8.2.1.1.5.2.5 ServiceInterface

UPDM: A contractual agreement between two resources that implement protocols through which the source service interacts to the destination resource. A physical connection between two resources that implements protocols through which the source resource can transmit items to the destination resource.

MODAF: The mechanism by which a Service communicates.

DoDAF: An overlap between Performers for the purpose of producing a Resource that is consumed by the other. (DoDAF::Interface).

SOAML: Defines the interface to a Service Point or Request Point and is the type of a role in a service contract.

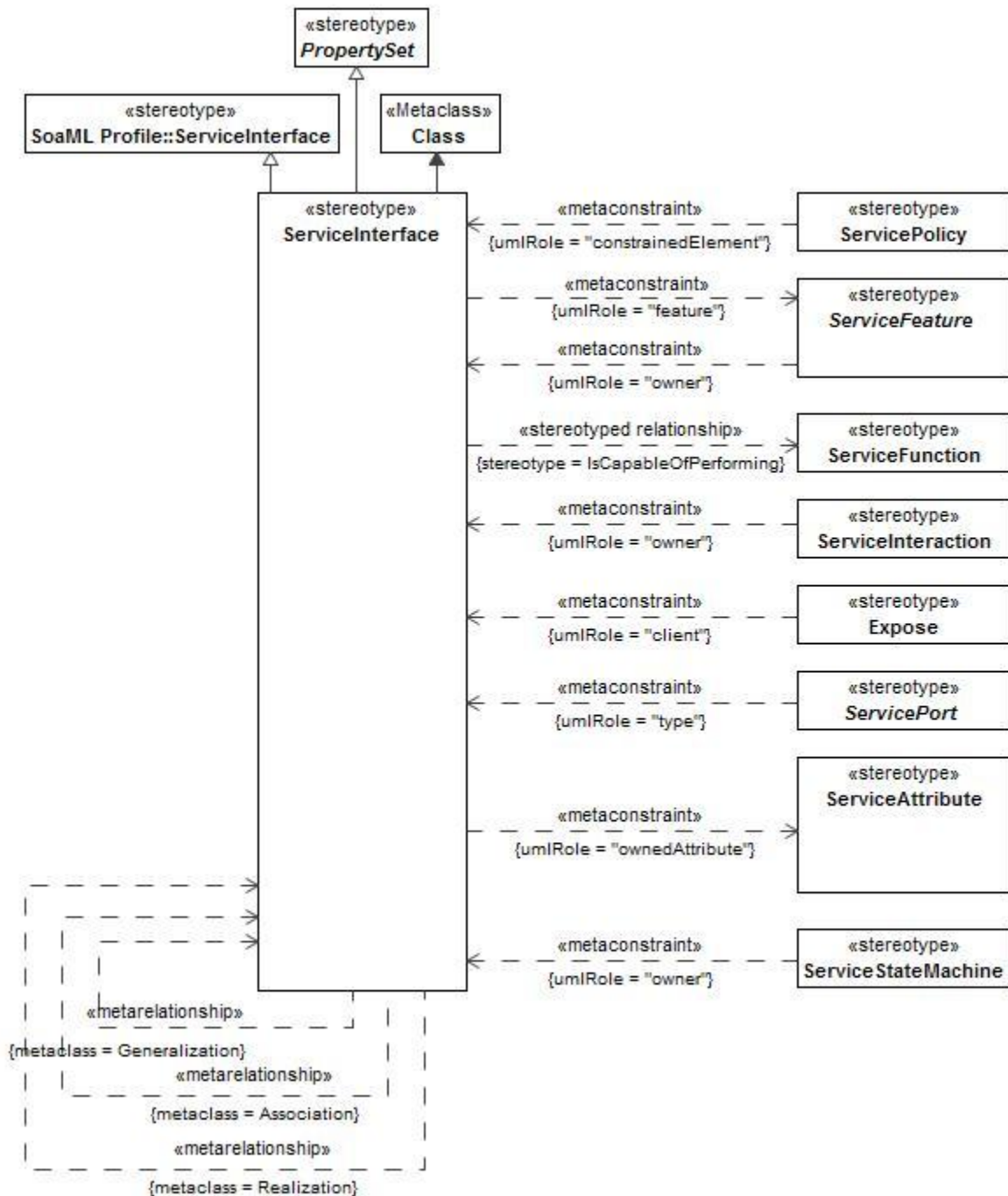

Figure 8:97 - ServiceInterface

- **Constraints**

The following are constraints for ServiceInterface:

- `ServiceInterface.feature` - Value for the feature property must be stereotyped `«ServiceFeature»` or its specializations.
- `ServiceInterface.ownedAttribute` - Values for ownedAttribute property must be stereotyped `«ServiceAttribute»` or its specializations.

- **Extensions**

The following metaclasses are extended by ServiceInterface:

- Class

- **Specializations**

The ServiceInterface element is a specialization of:

- ServiceInterface
- PropertySet

8.2.1.1.5.2.6 ServiceLevelValue

MODAF: A ServiceAttribute indicating the level to which a Resource delivers a Service, in a particular environment.

DoDAF: NA

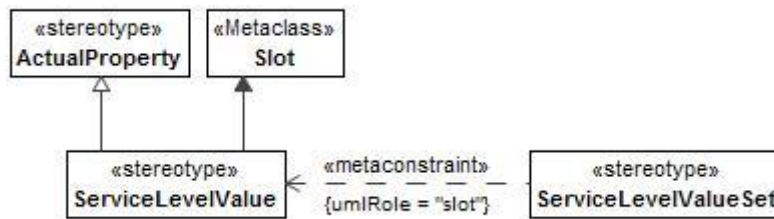

Figure 8:98 - ServiceLevelValue

- **Extensions**

The following metaclasses are extended by ServiceLevelValue:

- Slot

- **Specializations**

The ServiceLevelValue element is a specialization of:

- ActualProperty

8.2.1.1.5.2.7 ServiceLevelValueSet

MODAF: A value specification for a set of ServiceAttributes indicating the level to which a Resource delivers a Service, in a particular environment.

DoDAF: NA

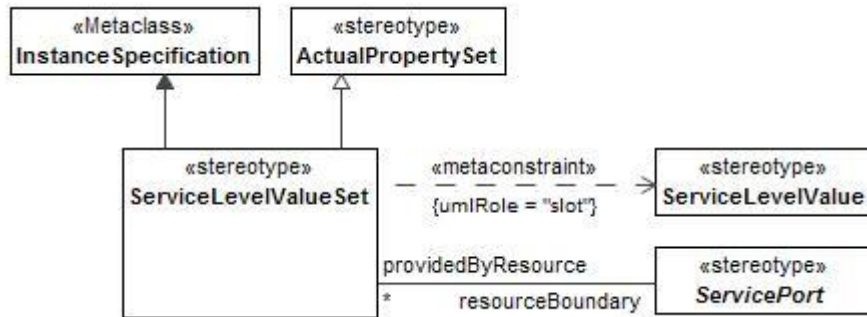

Figure 8:99 - ServiceLevelValueSet

- **Constraints**

The following are constraints for ServiceLevelValueSet:

- **ServiceLevelValueSet.slot** - Slot property value must be stereotyped «ServiceLevelValue» or its specializations.

- **Attributes**

The following are attributes for ServiceLevelValueSet:

- resourceBoundary : ServicePort[] - Service level associated with a port.

- **Extensions**

The following metaclasses are extended by ServiceLevelValueSet:

- InstanceSpecification

- **Specializations**

The ServiceLevelValueSet element is a specialization of:

- ActualPropertySet

8.2.1.1.5.2.8 ServicePolicy

UPDM: A constraint governing the consumers and providers of services.

MODAF: A constraint governing one or more Services.

DoDAF: Agreement: A consent among parties regarding the terms and conditions of activities that said parties participate in.

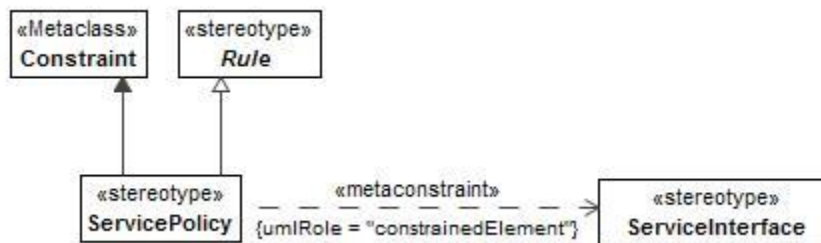

Figure 8:100 - ServicePolicy

- **Constraints**

The following are constraints for ServicePolicy:

- **ServicePolicy.constrainedElement** - Values for constrainedElement property must be stereotyped «ServiceInterface» or its specializations.

- **Extensions**

The following metaclasses are extended by ServicePolicy:

- Constraint

- **Specializations**

The ServicePolicy element is a specialization of:

- UPDMElement
- Rule

8.2.1.1.5.2.9 ServicePort

MODAF: ServiceInterface - The mechanism by which a Service communicates.

DoDAF: A part of a Performer that specifies a distinct interaction point through which the Performer interacts with other Performers. This isolates dependencies between performers to particular interaction points rather than to the performer as a whole.

Note: ServicePort is abstract.

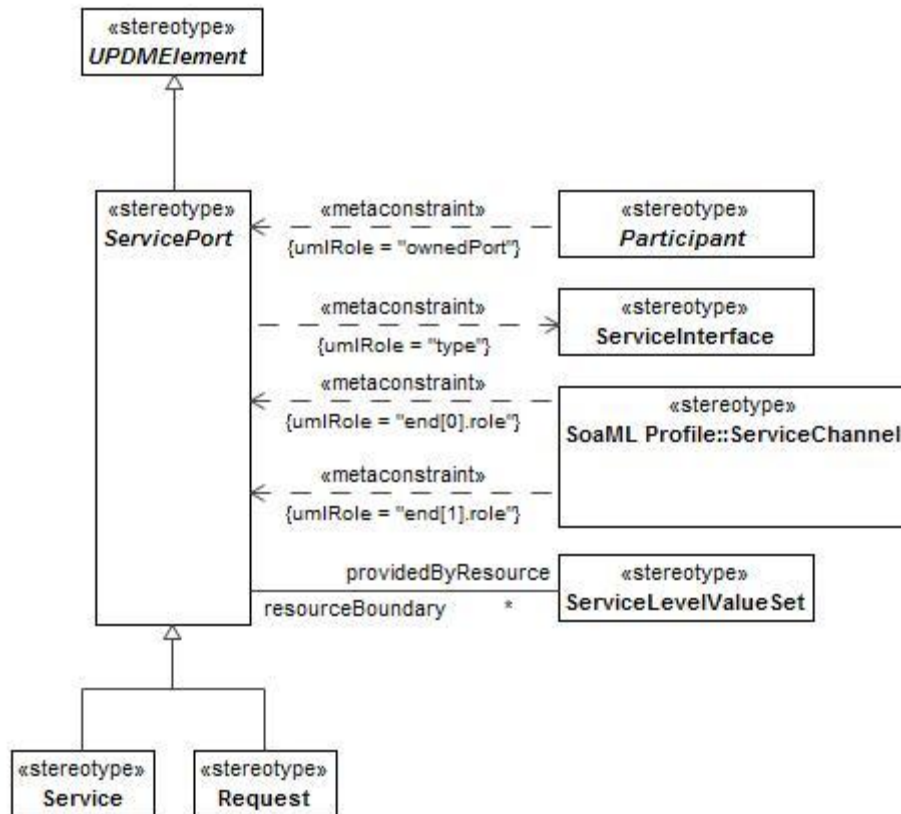

Figure 8:101 - ServicePort

- **Constraints**

The following are constraints for ServicePort:

- **ServicePort.actualPropertySets** - Values for actualPropertySet property must be stereotyped «ServiceLevelValueSet» or its specializations.
- **ServicePort.type** - Values for type property must be stereotyped «ServiceInterface» or its specializations.

- **Attributes**

The following are attributes for ServicePort:

- providedByResource : ServiceLevelValueSet[*] - Port associated with a service level.

- **Specializations**

The ServicePort element is a specialization of:

- UPDMElement

8.2.1.1.6 UPDM L1::UPDM L0::Core::StrategicElements

The Strategic Elements are used in the Strategic View which provides an overall Enterprise Architecture assessment of the Capabilities and their relationships facilitating Capability Management (e.g., capability introduction, integration, re-alignment, and removal). While an Enterprise will have a number of UPDM Architecture

Descriptions that have the Operational, System, Technical Standards, and All Views, only one Strategic View will exist across a number of Architecture Descriptions.

8.2.1.1.6.1 UPDM L1::UPDM L0::Core::StrategicElements::Structure

Structural sub clause of the StrategicElements profile.

8.2.1.1.6.1.1 Capability

MODAF: A high level specification of the enterprise's ability.

DoDAF: The ability to achieve a desired effect under specified [performance] standards and conditions through combinations of ways and means [activities and resources] to perform a set of activities.

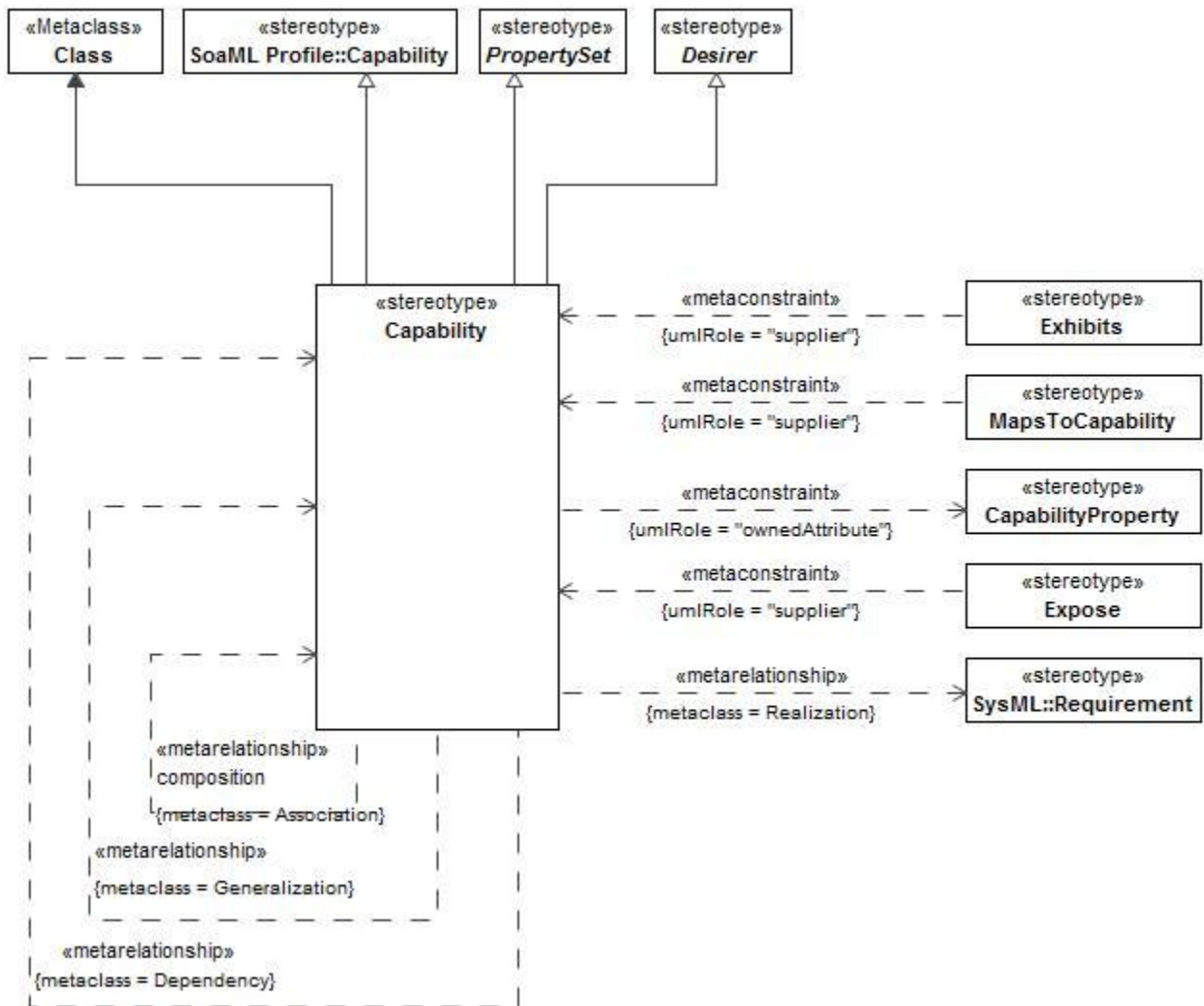

Figure 8:102 - Capability

- **Constraints**

The following are constraints for Capability:

- **Capability.ownedAttribute** - Values for ownedAttribute property must be stereotyped «CapabilityProperty» or its specializations.

- **Extensions**

The following metaclasses are extended by Capability:

- Class

- **Specializations**

The Capability element is a specialization of:

- Capability
- PropertySet
- Desirer

8.2.1.1.6.1.2 CapabilityProperty

UPDM: A property of a capability.

MODAF: NA

DoDAF: NA

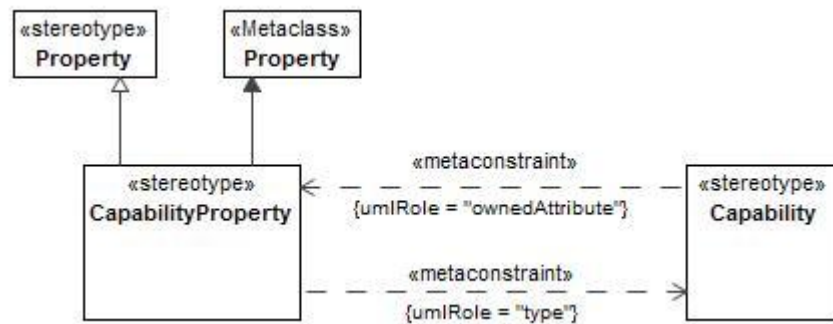

Figure 8:103 - CapabilityProperty

- **Constraints**

The following are constraints for CapabilityProperty:

- **CapabilityProperty.type** - Value for type meta property must be **stereotyped «Capability»** or its specializations.

- **Extensions**

The following metaclasses are extended by CapabilityProperty:

- Property

- **Specializations**

The CapabilityProperty element is a specialization of:

- Property

8.2.1.1.6.1.3 DesiredState

UPDM: Abstract element used to group Operational and Resource states.

Note: DesiredState is abstract.

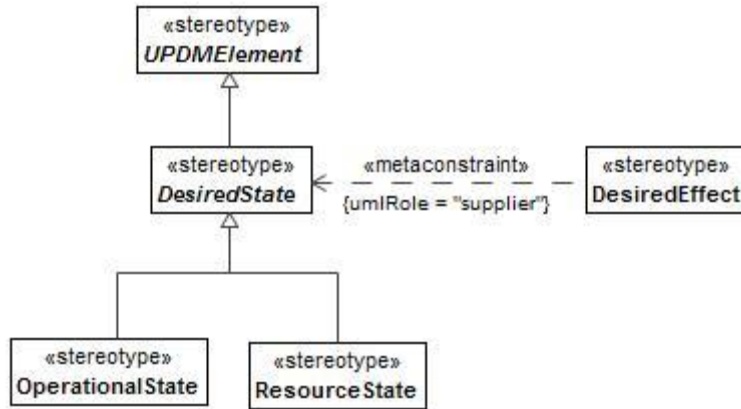

Figure 8:104 - DesiredState

- **Specializations**

The DesiredState element is a specialization of:

- UPDMElement

8.2.1.1.6.1.4 Desirer

UPDM: Abstract element used to group UPDM elements that might desire a particular effect.

Note: Desirer is abstract.

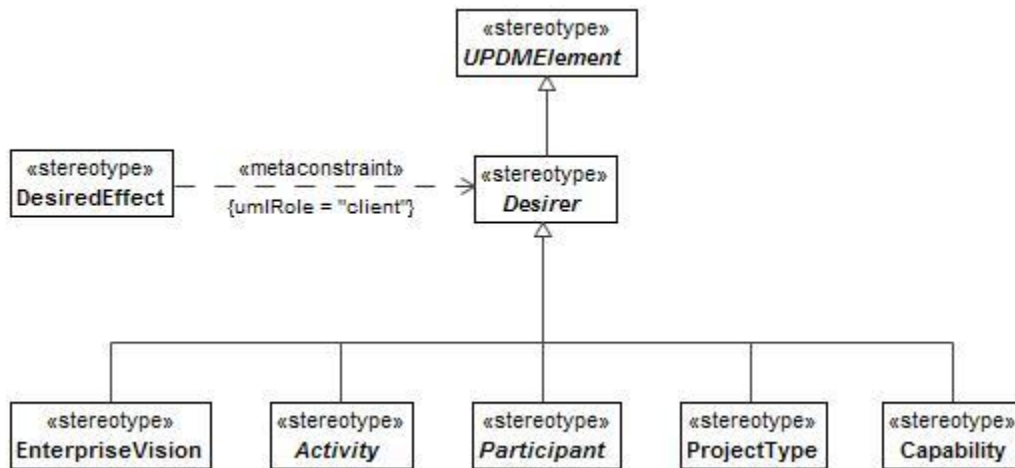

Figure 8:105 - Desirer

- **Specializations**

The Desirer element is a specialization of:

- UPDMElement

8.2.1.1.6.1.5 EnterpriseGoal

MODAF: A specific, required objective of the enterprise that the architecture represents.

DoDAF: NA

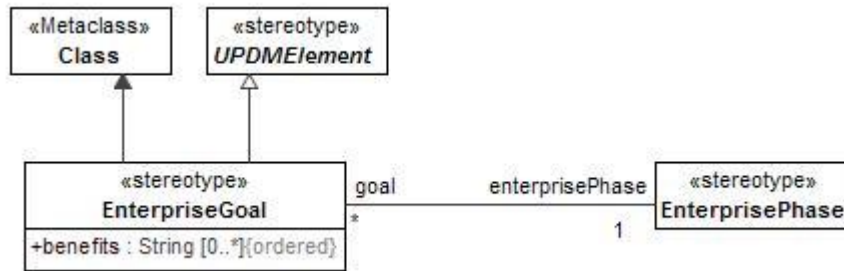

Figure 8:106 - EnterpriseGoal

- **Attributes**

The following are attributes for EnterpriseGoal:

- benefits : String[0..*] - A description of the usefulness of the Goal in terms of why the state or condition of the Enterprise is worth attaining.
- enterprisePhase : EnterprisePhase[1] - Phase of the goal.

- **Extensions**

The following metaclasses are extended by EnterpriseGoal:

- Class

- **Specializations**

The EnterpriseGoal element is a specialization of:

- UPDMElement

8.2.1.1.6.1.6 EnterprisePhase

MODAF: A specific, required objective of the enterprise that the architecture represents.

DoDAF: NA

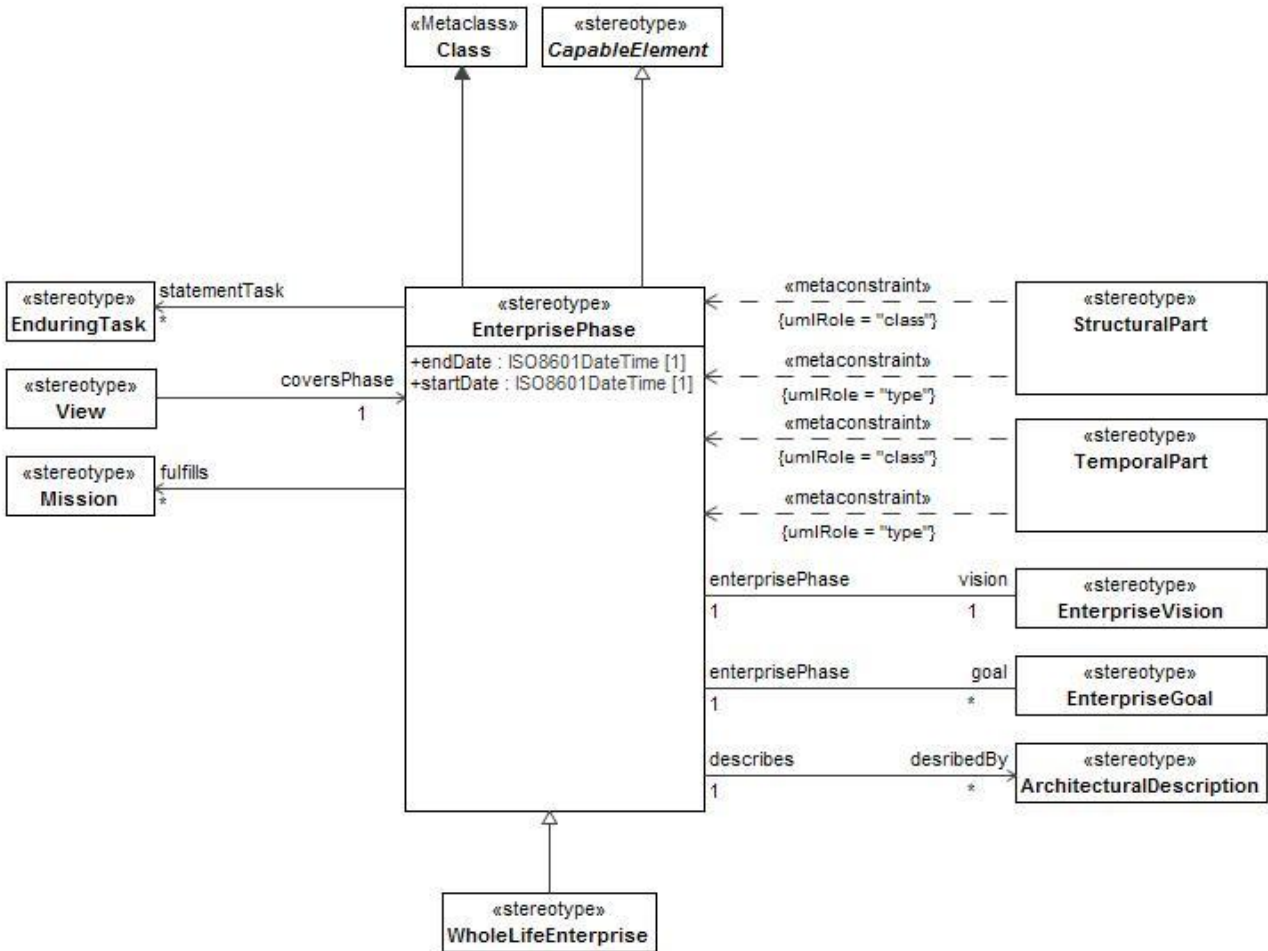

Figure 8:107 - EnterprisePhase

- **Constraints**

The following are constraints for EnterprisePhase:

- **Enterprise from/to - Must fall within the Enterprise to and from time, the complete lifecycle.**

- **Attributes**

The following are attributes for EnterprisePhase:

- **describedBy : ArchitecturalDescription[*]** - The EnterprisePhase described by an ArchitecturalDescription.
- **endDate : ISO8601DateTime[1]** - The time and date at which the Phase ends.
- **fulfills : Mission[*]** - EnterprisePhases associated with a Mission.
- **goal : EnterpriseGoal[*]** - The Goal towards which this Phase is directed and is in support of.
- **startDate : ISO8601DateTime[1]** - The time and date at which the Phase starts.
- **statementTask : EnduringTask[*]** - Collection of statement tasks.

- vision : EnterpriseVision[1] - The Vision towards which this Phase is directed and is in support of.

- **Extensions**

The following metaclasses are extended by EnterprisePhase:

- Class

- **Specializations**

The EnterprisePhase element is a specialization of:

- CapableElement

8.2.1.1.6.1.7 EnterpriseVision

MODAF: The overall aims of an enterprise over a given period of time.

DoDAF: (DoDAF::Vision): An end that describes the future state of the enterprise, without regard to how it is to be achieved; a mental image of what the future will or could be like.

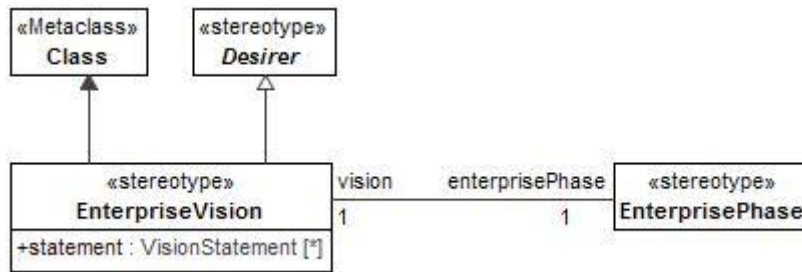

Figure 8:108 - EnterpriseVision

- **Attributes**

The following are attributes for EnterpriseVision:

- enterprisePhase : EnterprisePhase[1] - The phase which temporally locates the Vision.
- statement : VisionStatement[*] - A description of the Vision.

- **Extensions**

The following metaclasses are extended by EnterpriseVision:

- Class

- **Specializations**

The EnterpriseVision element is a specialization of:

- Desirer

8.2.1.1.6.1.8 Exhibits

UPDM: Relationship between a Node and a capability the node provides.

MODAF: (MODAF::CapabilityForNode): An assertion that a Node is required to have a Capability.

DoDAF: A couple that represents the capability that a performer manifests.

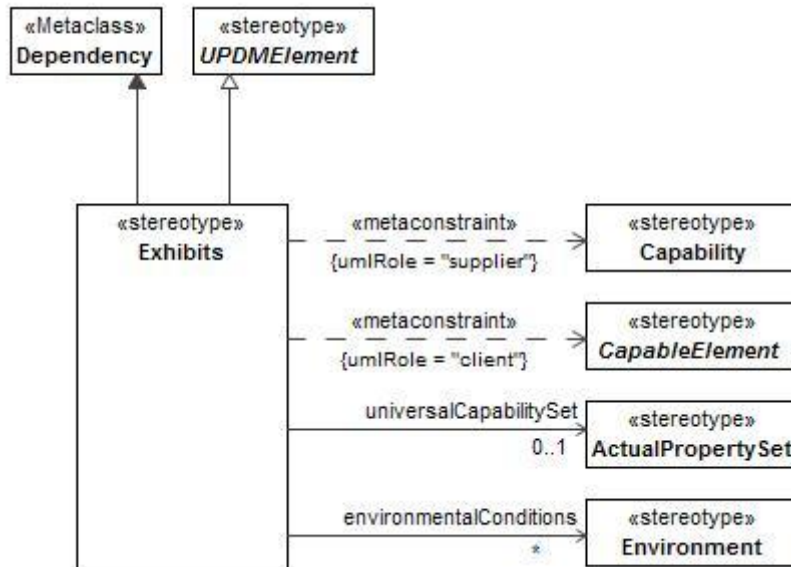

Figure 8:109 - Exhibits

- **Constraints**

The following are constraints for Exhibits:

- Exhibits.client - Value for the client property must be stereotyped a specialization of «CapableElement».
- Exhibits.supplier - Value for the supplier property must be stereotyped «Capability».

- **Attributes**

The following are attributes for Exhibits:

- environmentalConditions : Environment[*] - Asserts that a Capability’s capabilityMetric (MeasureableProperty) is valid for a particular environment.
- universalCapabilitySet : ActualPropertySet[0..1] - The ActualPropertySet that exists between a Capability and a Capable Element.

- **Extensions**

The following metaclasses are extended by Exhibits:

- Dependency

- **Specializations**

The Exhibits element is a specialization of:

- UPDMElement

8.2.1.1.6.1.9 MapsToCapability

MODAF: Asserts that a StandardOperationalActivity is in some way part of a capability.

DoDAF: MapsToCapability (DoDAF::ActivityPartOfCapability) is a disposition to manifest an Activity. An Activity to be performed to achieve a desired effect under specified [performance] standards and conditions through

combinations of ways and means.

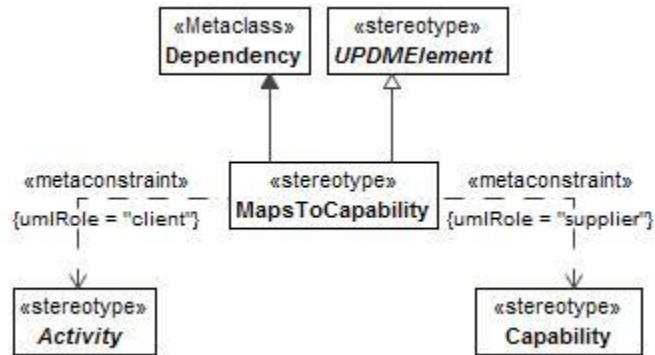

Figure 8:110 - MapsToCapability

- **Constraints**

The following are constraints for MapsToCapability:

- **MapsToCapability.client** - Value for the client property must be stereotyped a specialization of «Activity».
- **MapsToCapability.supplier** - Value for the supplier property must be stereotyped «Capability».

- **Extensions**

The following metaclasses are extended by MapsToCapability:

- Dependency

- **Specializations**

The MapsToCapability element is a specialization of:

- UPDMElement

8.2.1.1.6.1.10 StructuralPart

UPDM: An EnterprisePhase can be sub-divided into structural and temporal parts. StructuralPart describes the EnterprisePhase elements that describe the structure.

MODAF: Asserts that one EnterprisePhase is a spatial part of another (MODAF::EnterpriseStructure).

Note: This is a topological structuring relationship, hence the EnterprisePhase may be physically disjoint.

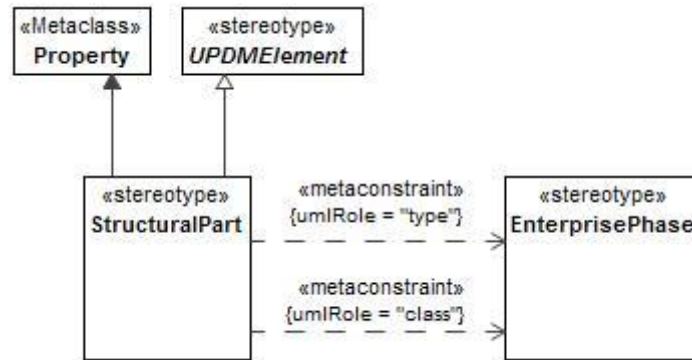

Figure 8:111 - StructuralPart

- **Constraints**

The following are constraints for StructuralPart:

- **StructuralPart.class** - Value for class metaproperty must be stereotyped «EnterprisePhase» or its specializations.
- **StructuralPart.type** - Value for type metaproperty must be stereotyped «EnterprisePhase» or its specializations.

- **Extensions**

The following metaclasses are extended by StructuralPart:

- Property

- **Specializations**

The StructuralPart element is a specialization of:

- UPDMElement

8.2.1.1.6.1.11 TemporalPart

UPDM Artifact: An EnterprisePhase can be sub-divided into structural and temporal parts. TemporalPart describes the EnterprisePhase elements that have a time based nature.

MODAF: Asserts that one EnterprisePhase is a temporal part of another. Note: This means that both EnterprisePhases have the same spatial extent - i.e., this is only a temporal structure (MODAF::EnterpriseTemporalPart).

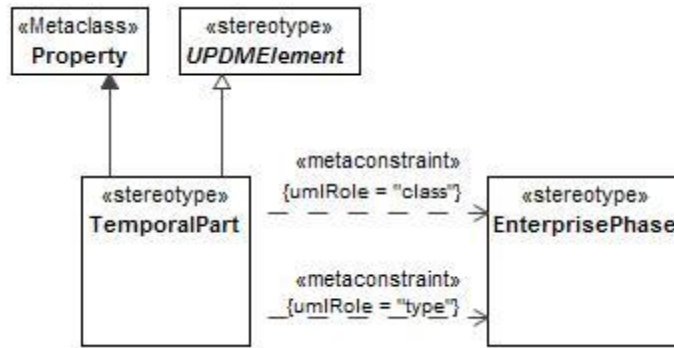

Figure 8:112 - TemporalPart

- **Constraints**

The following are constraints for TemporalPart:

- **TemporalPart.class** - Value for class metaproperty must be stereotyped «EnterprisePhase» or its specializations.
- **TemporalPart.type** - Value for type metaproperty must be stereotyped «EnterprisePhase» or its specializations.

- **Extensions**

The following metaclasses are extended by TemporalPart:

- Property

- **Specializations**

The TemporalPart element is a specialization of:

- UPDMElement

8.2.1.1.6.1.12 VisionStatement

MODAF: A high-level textual description of an EnterpriseVision.

DoDAF: An end that describes the future state of the enterprise, without regard to how it is to be achieved; a mental image of what the future will or could be like (DODAF::Vision).

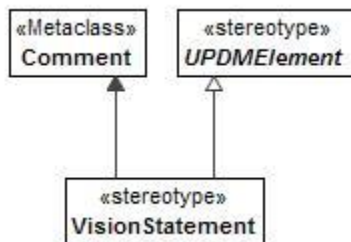

Figure 8:113 - VisionStatement

- **Extensions**

The following metaclasses are extended by VisionStatement:

- Comment

- **Specializations**

The VisionStatement element is a specialization of:

- UPDMElement

Expose.client

- **Value for the client property must be stereotyped «ServiceInterface» or its specializations.**

Expose.supplier

- **Value for the supplier property must be stereotyped «Capability».**

8.2.1.1.7 UPDM L1::UPDM L0::Core::SystemsElements

Models in the System Viewpoint represent alternate realizations in terms of equipment capability of the operational capabilities expressed through models in the Operational Viewpoint and in the User Requirements. The System Viewpoint primarily addresses the specification of the system capability needed (rather than implementation details). Significant changes originally made in MODAF improved the ability for modelers to represent configuration of capability that include people as well as systems and platforms.

8.2.1.1.7.1 UPDM L1::UPDM L0::Core::SystemsElements::Behavior

The Behavior sub clause of the SystemsElements profile.

8.2.1.1.7.1.1 Function

MODAF: An activity which is specified in context of the resource (human or machine) that performs it.
 DoDAF: Activity: Work, not specific to a single organization, weapon system or individual that transforms inputs (Resources) into outputs (Resources) or changes their state.

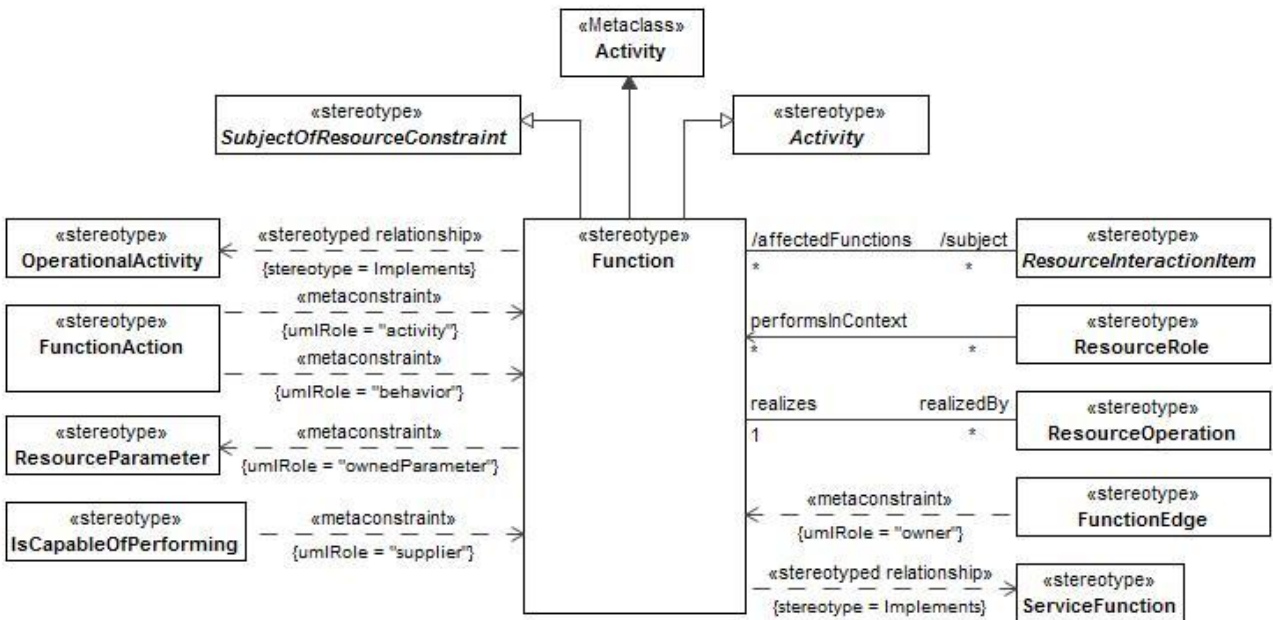

Figure 8:114 - Function

- **Constraints**

The following are constraints for Function:

- **Function.ownedParameter** - The values for the ownedParameter property must be stereotyped «ResourceParameter».

- **Attributes**

The following are attributes for Function:

- realizedBy : ResourceOperation[*] - Relationship between a Function and a ResourceOperation.
- subject : ResourceInteractionItem[*] - The ResourceInteractionItem that is the subject of the Function.

- **Extensions**

The following metaclasses are extended by Function:

- Activity

- **Specializations**

The Function element is a specialization of:

- Activity
- SubjectOfResourceConstraint

8.2.1.1.7.1.2 FunctionAction

UPDM Artifact: The FunctionAction is defined as a call behavior action that invokes the function that needs to be performed. This concept is required for mapping the architecture with UML and does not have a DoDAF or MoDAF equivalent.

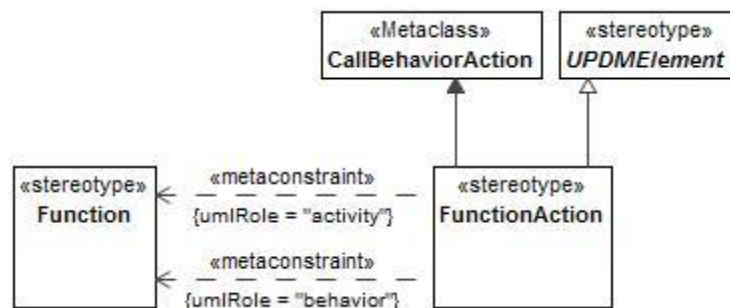

Figure 8:115 - FunctionAction

- **Constraints**

The following are constraints for FunctionAction:

- **FunctionAction.activity** - Value for the activity property must be stereotyped «Function».
- **FunctionAction.behavior** - Value for the behavior property must be stereotyped «Function».

- **Extensions**

The following metaclasses are extended by FunctionAction:

- CallBehaviorAction

- **Specializations**

The FunctionAction element is a specialization of:

- UPDMElement

8.2.1.1.7.1.3 FunctionEdge

UPDM: An extension of <<ActivityEdge>> that is used to model the flow of control/objects through a Function.
 MODAF: A FunctionEdge (MODAF::FunctionFlow) is a UML::ObjectFlow between Functions. NOTE: this has been extended in UPDM to additionally include UML::ControlFlows.

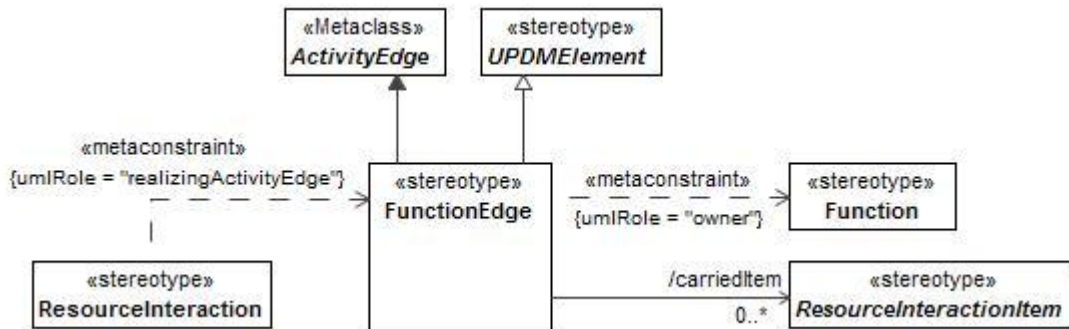

Figure 8:116 - FunctionEdge

- **Constraints**

The following are constraints for FunctionEdge:

- **FunctionEdge.owner** - <<FunctionEdge>> must be owned directly or indirectly by <<Function>>.

- **Attributes**

The following are attributes for FunctionEdge:

- carriedItem : ResourceInteractionItem[0..*] - The ResourceInteractionItem that is conveyed.

- **Extensions**

The following metaclasses are extended by FunctionEdge:

- ActivityEdge

- **Specializations**

The FunctionEdge element is a specialization of:

- UPDMElement

8.2.1.1.7.1.4 ResourceEventTrace

UPDM: A UPDM artifact that extends a UML Interaction.

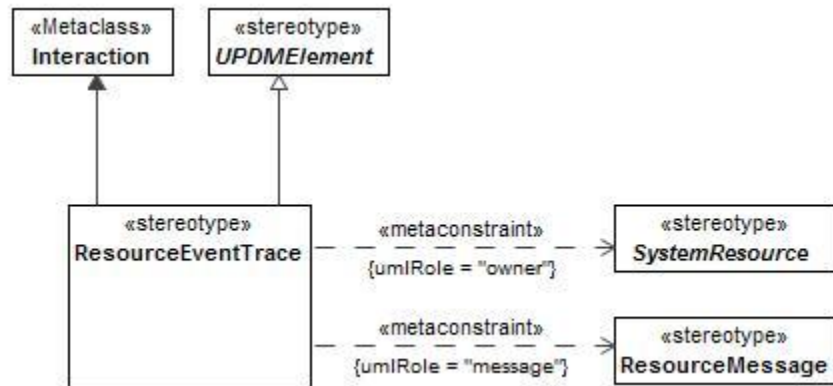

Figure 8:117 - ResourceEventTrace

- **Constraints**

The following are constraints for ResourceEventTrace:

- ResourceEventTrace.message - Values for the message property must be stereotyped with «ResourceMessage» or its specializations.
- ResourceEventTrace.owner - Values for the owner property must be stereotyped with «Resource» or its specializations.

- **Extensions**

The following metaclasses are extended by ResourceEventTrace:

- Interaction

- **Specializations**

The ResourceEventTrace element is a specialization of:

- UPDMElement

8.2.1.1.7.1.5 ResourceMessage

UPDM: Message for use in a Resource Event-Trace, implements a ResourceInteraction.

MODAF: A specification of the interactions between aspects of a Resources architecture (MODAF::ResourceInteractionSpecification).

DoDAF: An overlap of an Activity with a Resource, in particular a consuming or producing Activity that expresses an input, output, consumption, or production Activity of the Resource (DoDAF:: activityResourceOverlap).

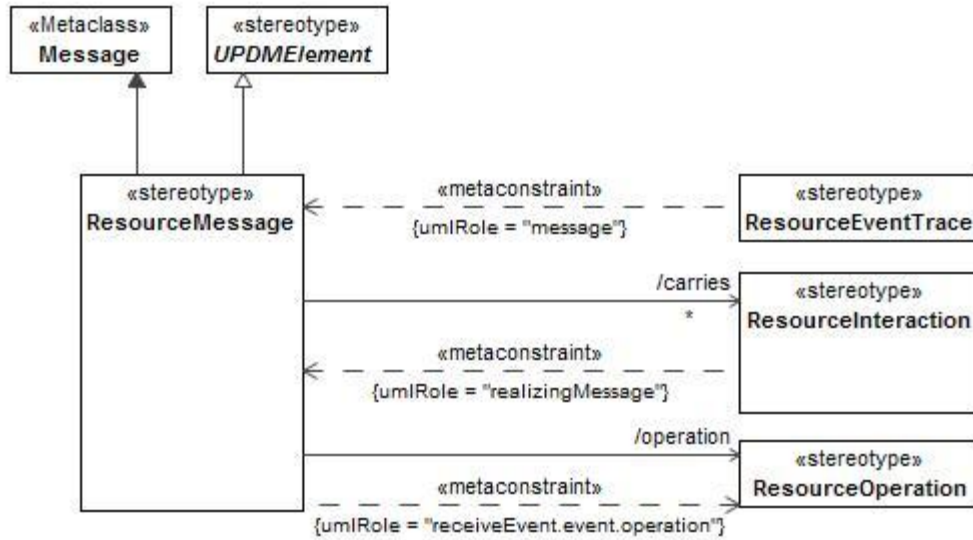

Figure 8:118 - ResourceMessage

- **Constraints**

The following are constraints for ResourceMessage:

- ResourceMessage.receiveEvent.event.operation - Values for the receiveEvent.event.operation property must be stereotyped with «ResourceOperation» or its specializations.

- **Attributes**

The following are attributes for ResourceMessage:

- carries : ResourceInteraction[*] - Carried ResourceInteraction
- operation : ResourceOperation[] - The ResourceOperation associated with a ResourceMessage.

- **Extensions**

The following metaclasses are extended by ResourceMessage:

- Message

- **Specializations**

The ResourceMessage element is a specialization of:

- UPDMElement

8.2.1.1.7.1.6 ResourceOperation

UPDM: A partial or full realization of Function.

MODAF: NA

DoDAF: NA

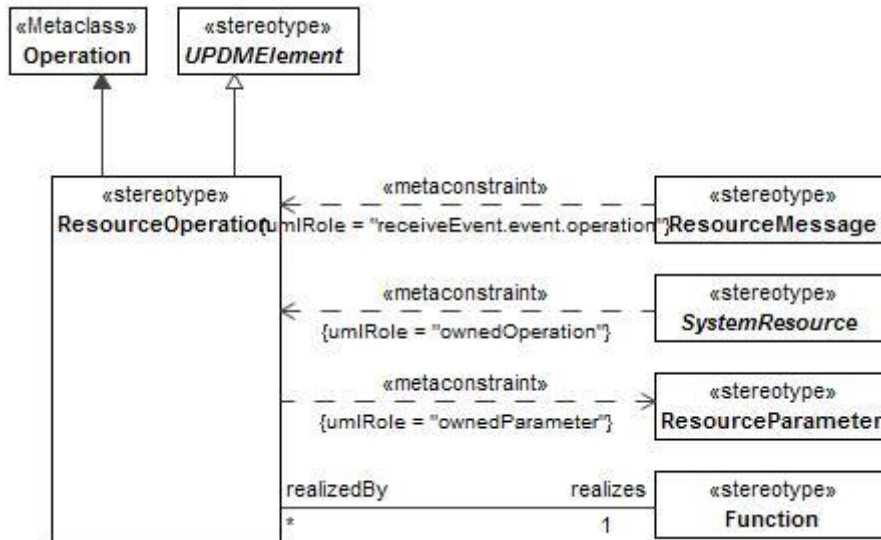

Figure 8:119 - ResourceOperation

- **Constraints**

The following are constraints for ResourceOperation:

- **ResourceOperation.ownedParameter** - The values for the ownedParameter property must be stereotyped «ResourceParameter».

- **Attributes**

The following are attributes for ResourceOperation:

- realizes : Function[1] - Relationship between a ResourceOperation and a Function.

- **Extensions**

The following metaclasses are extended by ResourceOperation:

- Operation

- **Specializations**

The ResourceOperation element is a specialization of:

- UPDMElement

8.2.1.1.7.1.7 ResourceParameter

UPDM: Represents inputs and outputs of Function. It is typed by ResourceInteractionItem.

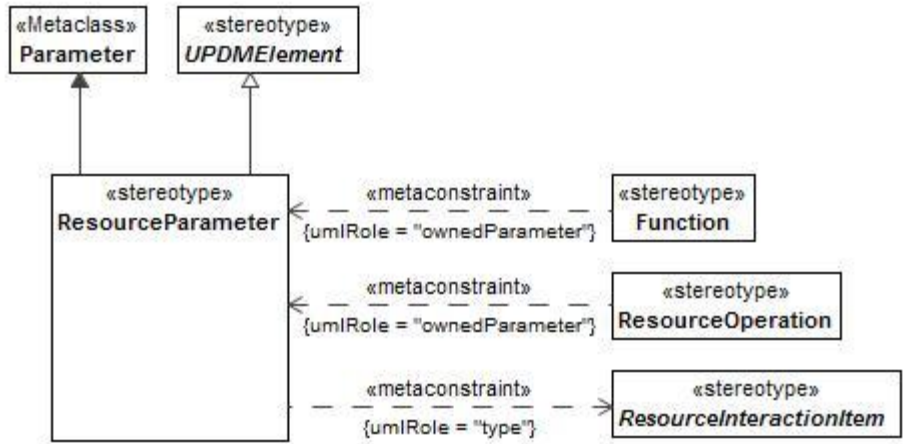

Figure 8:120 - ResourceParameter

- **Constraints**

The following are constraints for ResourceParameter:

- ResourceParameter.type - Value for the type property must be stereotyped with specialization of «ResourceInteractionItem».

- **Extensions**

The following metaclasses are extended by ResourceParameter:

- Parameter

- **Specializations**

The ResourceParameter element is a specialization of:

- UPDMElement

8.2.1.1.7.1.8 ResourceState

UPDM: State identified in the context of an ResourceStateDescription.
 MODAF: N/A
 DoDAF: N/A

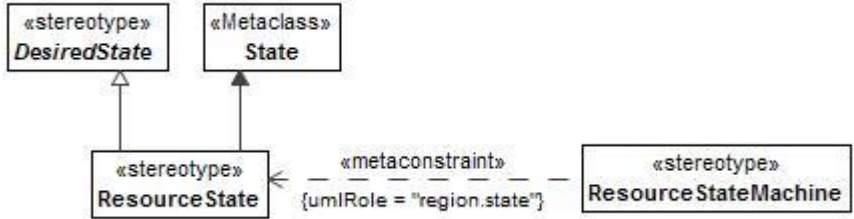

Figure 8:121 - ResourceState

- **Extensions**

The following metaclasses are extended by ResourceState:

- State

- **Specializations**

The ResourceState element is a specialization of:

- DesiredState

8.2.1.1.7.1.9 ResourceStateMachine

UPDM Artifact that extends a UML StateMachine allied to Resources.

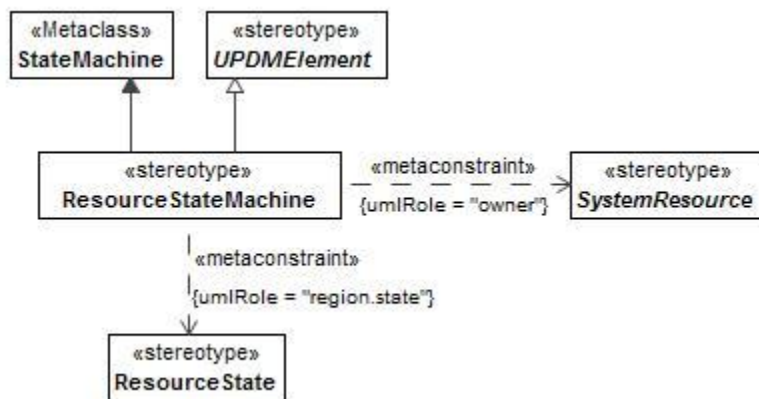

Figure 8:122 - ResourceStateMachine

- **Constraints**

The following are constraints for ResourceStateMachine:

- ResourceStateMachine.owner - Values for the owner property must be stereotyped with «SystemResource» or its specializations.
- ResourceStateMachine.region.state - Values for the region.state property must be stereotyped with «ResourceState» or its specializations.

- **Extensions**

The following metaclasses are extended by ResourceStateMachine:

- StateMachine

- **Specializations**

The ResourceStateMachine element is a specialization of:

- UPDMElement

8.2.1.1.7.2 UPDM L1::UPDM L0::Core::SystemsElements::Data

The Data sub clause of the SystemsElements profile.

8.2.1.1.7.2.1 DataModel

MODAF: A structural specification of data, showing classifications of data elements and relationships between them.

DoDAF: NA

Note: DataModel is abstract.

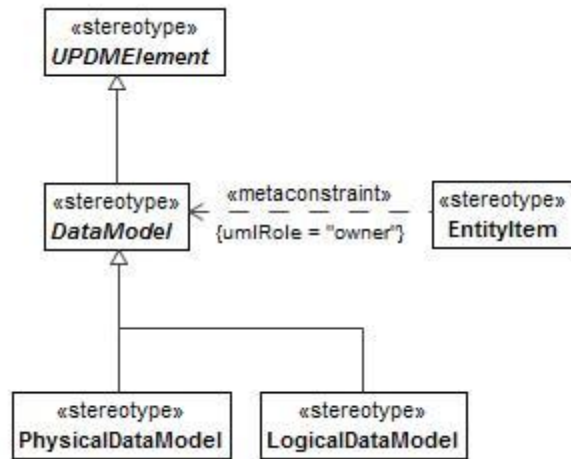

Figure 8:123 - DataModel

- **Constraints**

The following are constraints for DataModel:

- **DataModel.ownedElement** - All classifiers owned by DataModel must be stereotyped «EntityItem».

- **Specializations**

The DataModel element is a specialization of:

- UPDMElement

8.2.1.1.7.2.2 PhysicalDataModel

MODAF: A PhysicalDataModel is an implementable specification of a data structure. A PhysicalDataModel realizes a LogicalDataModel, taking into account implementation restrictions and performance issues whilst still enforcing the constraints, relationships, and typing of the logical model.

DoDAF: A Physical Data Model defines the structure of the various kinds of system or service data that are utilized by the systems or services in the Architecture.

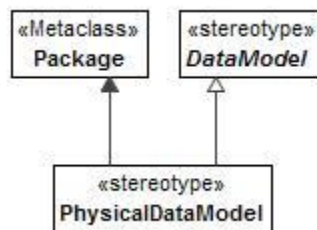

Figure 8:124 - PhysicalDataModel

- **Extensions**

The following metaclasses are extended by PhysicalDataModel:

- Package

- **Specializations**

The PhysicalDataModel element is a specialization of:

- DataModel

8.2.1.1.7.3 UPDM L1::UPDM L0::Core::SystemsElements::Flows

The Flows sub clause of the SystemsElements profile.

8.2.1.1.7.3.1 ResourceInteraction

UPDM: ResourceInteraction represents data that is exchanged between the resources

MODAF: An assertion that two FunctionalResources interact. Examples: data exchange between systems, conversations between people, people using systems.

DoDAF: NA

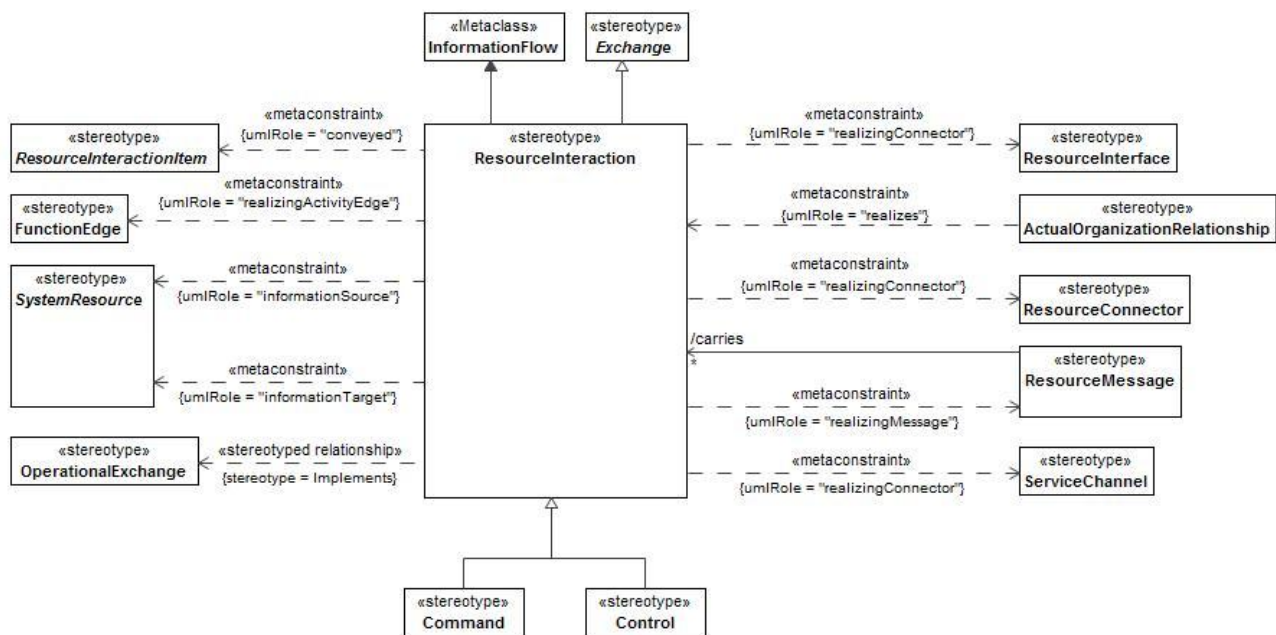

Figure 8:125 - ResourceInteraction

- **Constraints**

The following are constraints for ResourceInteraction:

- **ResourceInteraction.conveyedElement** - Value for the conveyedElement property must be stereotyped «ResourceInteractionItem» or its specializations.
- **ResourceInteraction.informationSource** - Value for the informationSource property must be stereotyped «SystemResource» or its specializations.
- **ResourceInteraction.informationTarget** - Value for the informationTarget property must be stereotyped «SystemResource» or its specializations.

- ResourceInteraction.realization - Value for the realization property must be stereotyped «ResourceInterface», «ActualOrganizationRelationship», or their specializations.
 - ResourceInteraction.realizingActivityEdge - Value for the realizingActivityEdge property must be stereotyped «FunctionEdge» or its specializations.
 - ResourceInteraction.realizingConnector - Value for the realizingConnector property must be stereotyped «ResourceInterface», «ResourceConnector», «ServiceChannel» or their specializations.
- Extensions

The following metaclasses are extended by ResourceInteraction:

- InformationFlow

- Specializations

The ResourceInteraction element is a specialization of:

- Exchange
- SubjectOfResourceConstraint

8.2.1.1.7.3.2 ResourceInteractionItem

UPDM Abstract: Represents the item(s) exchanged between the resources through a ResourceInteraction.

MODAF: Formalized representation of data which is managed by or exchanged between systems (MODAF::DataElement).

DoDAF: Representation of information in a formalized manner suitable for communication, interpretation, or processing by humans or by automatic means (DoDAF::Data).

Note: ResourceInteractionItem is abstract.

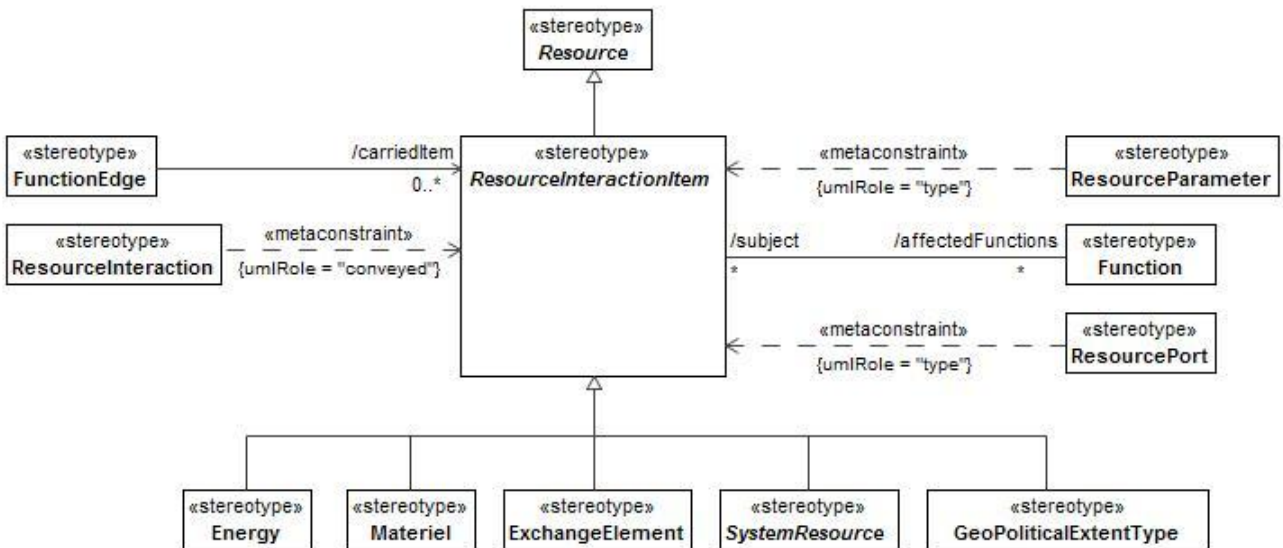

Figure 8:126 - ResourceInteractionItem

- **Attributes**

The following are attributes for ResourceInteractionItem:

- affectedFunctions : Function[*] - The Functions affected by the ResourceInteractionItem.

- **Specializations**

The ResourceInteractionItem element is a specialization of:

- Resource

8.2.1.1.7.4 UPDM L1::UPDM L0::Core::SystemsElements::Structure

The Structure sub clause of the SystemsElements profile.

8.2.1.1.7.4.1 CapabilityConfiguration

MODAF: A composite structure representing the physical and human resources (and their interactions) in an enterprise. A CapabilityConfiguration is a set of artifacts or an organization configured to provide a capability, and should be guided by [doctrine] which may take the form of Standard or OperationalConstraint stereotypes.

DoDAF: Any entity (human, automated, or any aggregation of human and/or automated) that performs an activity and provides a capability (Performer).

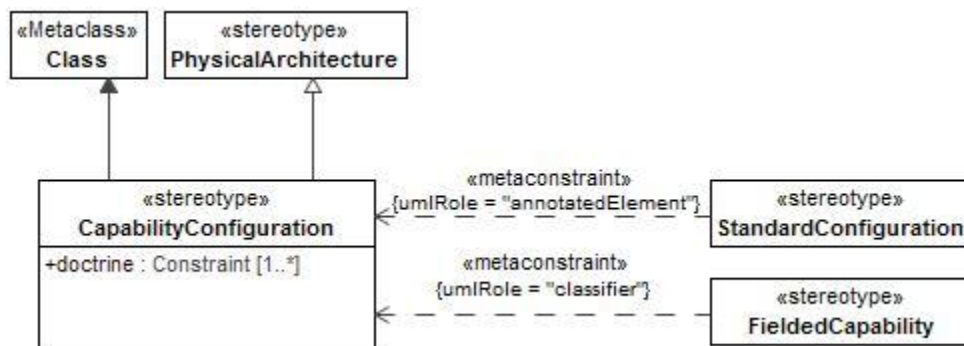

Figure 8:127 - CapabilityConfiguration

- **Attributes**

The following are attributes for CapabilityConfiguration:

- doctrine : Constraint[1..*] - Represents the doctrinal line of development of the capability.

- **Extensions**

The following metaclasses are extended by CapabilityConfiguration:

- Class

- **Specializations**

The CapabilityConfiguration element is a specialization of:

- PhysicalArchitecture

8.2.1.1.7.4.2 FieldedCapability

MODAF: An actual, fully-realized capability. A FieldedCapability must indicate its configuration CapabilityConfiguration.

DoDAF: NA

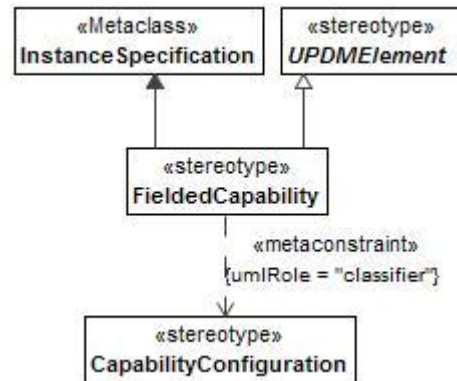

Figure 8:128 - FieldedCapability

- **Constraints**

The following are constraints for FieldedCapability:

- **FieldedCapability.classifier** - Value for the classifier property must be stereotyped «CapabilityConfiguration» or its specializations.

- **Extensions**

The following metaclasses are extended by FieldedCapability:

- InstanceSpecification

- **Specializations**

The FieldedCapability element is a specialization of:

- UPDMElement

8.2.1.1.7.4.3 Forecast

MODAF: A statement about the future state of one or more types of system or standard.

DoDAF: NA

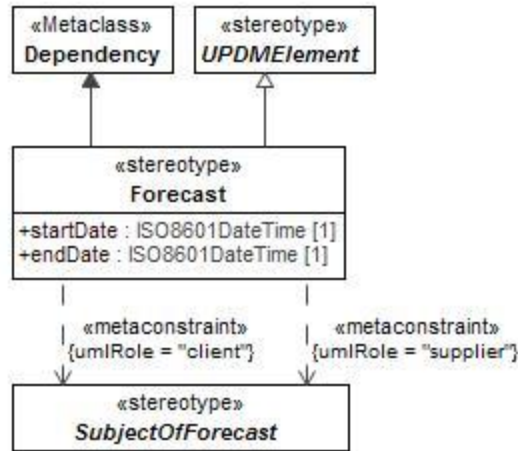

Figure 8:129 - Forecast

- **Constraints**

The following are constraints for Forecast:

- **Forecast.client** - Value for the client property must be stereotyped «SubjectOfForecast» or its specializations.
- **Forecast.pair** - The client and supplier must be stereotyped by the same specialization of «SubjectOfForecast» (e.g. «Software» to «Software», «Standard» to «Standard», etc).
- **Forecast.supplier** - Value for the supplier property must be stereotyped «SubjectOfForecast» or its specializations.

- **Attributes**

The following are attributes for Forecast:

- **endDate** : ISO8601DateTime[1] - End date of the forecast.
- **startDate** : ISO8601DateTime[1] - Start date of the forecast.

- **Extensions**

The following metaclasses are extended by Forecast:

- Dependency

- **Specializations**

The Forecast element is a specialization of:

- UPDMElement

8.2.1.1.7.4.4 Material

MODAF: Artifact, A type of man-made object. Examples are "car," "radio," "diesel," etc.

DoDAF: Equipment, apparatus, or supplies that are of interest, without distinction as to its application for administrative or combat purposes.

- **Extensions**

The following metaclasses are extended by Material:

- Class

- **Specializations**

The Material element is a specialization of:

- ResourceInteractionItem

8.2.1.1.7.4.5 MODAFRoleKind

Enumeration of the roles that a ResourceRole may play in the context of a CapabilityConfiguration or System, derived from MODAF, used to support the MODAFRoleKind tag of a ResourceRole.

- **Enumeration Literals**

The following are enumeration literals for MODAFRoleKind:

- Component - (MODAF SoftwareComponent) Asserts that Software is a component of another Software.
- Equipment - UPDM: Equipment is a physical resource that is used to accomplish a task or function in a system or an environment.
MODAF: (MODAF::PhysicalAsset): Usage of a ResourceArtifact (MODAF::Artifact) as a component of a ResourceConfiguration.
DoDAF: NA
- Hosted Software - Asserts that Software is hosted on a ResourceArtifact (which means the artifact is some kind of computer system).
- Human Resource - The role of an OrganizationalResource in a PhysicalArchitecture.
- Other - Other MODAF Role kind that is not on the enumerated list.
- Part - Usage of a ResourceArtifact as a part of another ResourceArtifact.
- Platform - Usage of a ResourceArtifact as a platform (e.g., vessel, aircraft, etc.) in a particular PhysicalArchitecture.
- Post Role - (MODAF Post) Asserts that a Post exists in an OrganizationType of the type specified by the related PostType.
- Responsibility Role - (MODAF Role) A ResourceUsage that asserts a given PostType has a RoleType.
- Service Access Role - A ResourceUsage that asserts a given ServiceAccess is used in the context of a particular service usage.
- Sub Organization - Asserts that one OrganizationType is typically the parent of another - e.g., a squadron may be part of a battalion.
- Sub System Part - UPDM: Indicates that a (sub)system is part of another system.
MODAF: Usage of an Artifact (UPDM::ResourceArtifact) as a part of another Artifact (UPDM::ResourceArtifact), equates to a MODAF::Part.
DoDAF: NA

- System - The usage of a ResourceArtifact as a System in a PhysicalArchitecture.
- Used Configuration - The usage of a PhysicalArchitecture in another PhysicalArchitecture.

8.2.1.1.7.4.6 PhysicalArchitecture

MODAF: A configuration of Resources for a purpose.

DoDAF: NA

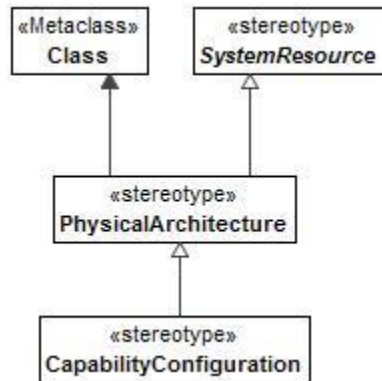

Figure 8:130 - PhysicalArchitecture

- **Extensions**

The following metaclasses are extended by PhysicalArchitecture:

- Class

- **Specializations**

The PhysicalArchitecture element is a specialization of:

- SystemResource

8.2.1.1.7.4.7 PhysicalResource

UPDM: Abstract supertype for physical resources such as OrganizationalResource.

MODAF: A PhysicalAsset, OrganizationalResource, or FunctionalResource that can contribute towards fulfilling a capability (MODAF::ResourceType).

Note: PhysicalResource is abstract.

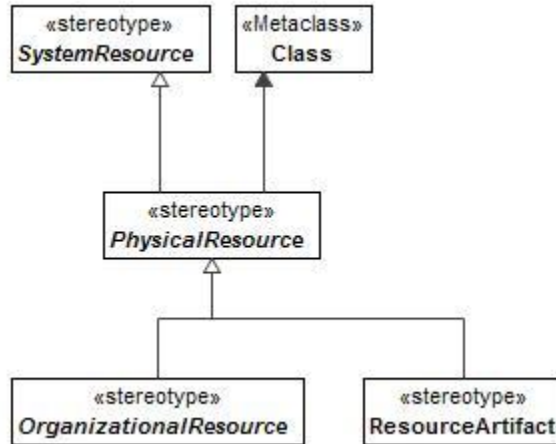

Figure 8:131 - PhysicalResource

- **Extensions**

The following metaclasses are extended by PhysicalResource:

- Class

- **Specializations**

The PhysicalResource element is a specialization of:

- SystemResource

8.2.1.1.7.4.8 ResourceArtifact

UPDM: A combination of physical element, energy, and data that are combined used to accomplish a task or function.

MODAF: A type of man-made object. Examples are "car," "radio," "fuel," etc. (MODAF:: Artifact).

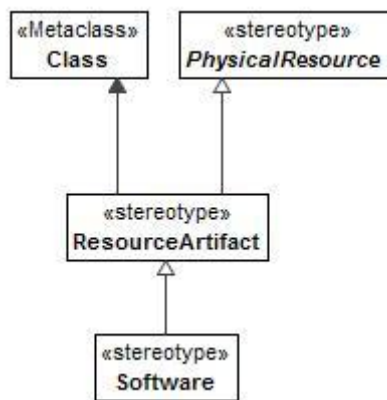

Figure 8:132 - ResourceArtifact

- **Extensions**

The following metaclasses are extended by ResourceArtifact:

- Class

- **Specializations**

The ResourceArtifact element is a specialization of:

- PhysicalResource

8.2.1.1.7.4.9 ResourceConnector

UPDM: A physical connection between two resources that implements protocols through which the source resource can transmit items to the destination resource.

MODAF: Asserts that a connection exists between two ports belonging to parts in a system composite structure model (MODAF::SystemPortConnector).

DoDAF: NA

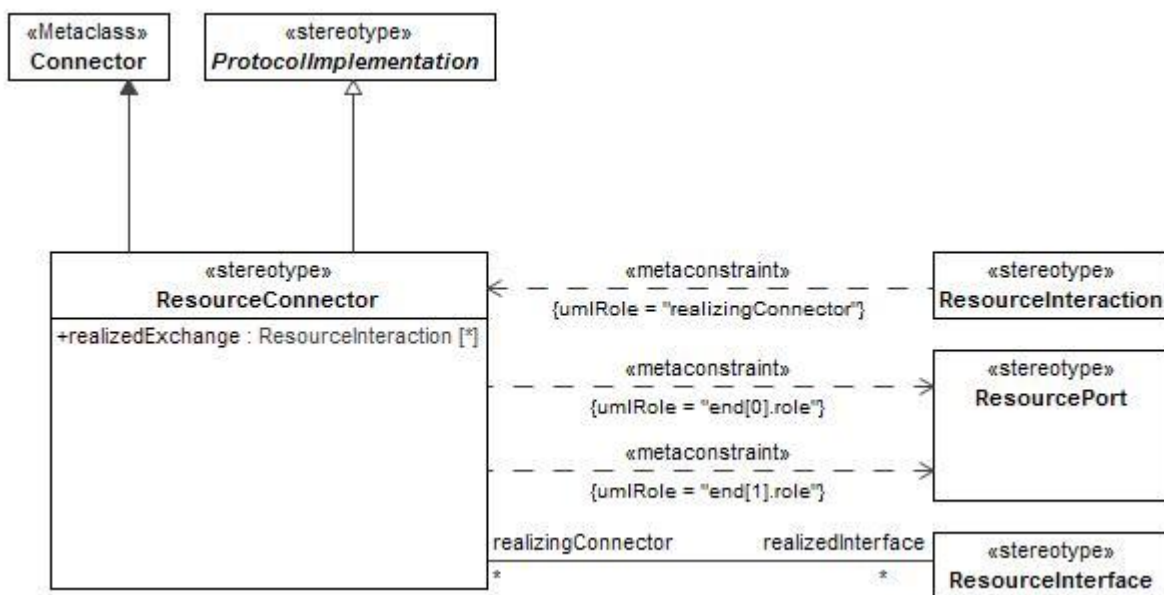

Figure 8:133 - ResourceConnector

- **Constraints**

The following are constraints for ResourceConnector:

- **ResourceConnector.end** - The value for the role property for the owned ConnectorEnd must be stereotype «ResourcePort» or its specializations.

- **Attributes**

The following are attributes for ResourceConnector:

- realizedExchange : ResourceInteraction[*] - A list of ResourceInteractions (or specializations) that realized by the ResourceInterface/ResourceConnector. This is derived by navigating from the ResourceInteraction to the ResourceInterfaces/ResourceConnectors using the inverse of the realization/realizingConnector roles.
- realizedInterface : ResourceInterface[*] - Realized ResourceInterfaces.

- **Extensions**

The following metaclasses are extended by ResourceConnector:

- Connector

- **Specializations**

The ResourceConnector element is a specialization of:

- ProtocolImplementation

8.2.1.1.7.4.10 ResourceConstraint

MODAF: A rule governing the structural or functional aspects of an implementation - this may also include constraints on OrganizationalResources that are part of an implementation.

DoDAF: The range of permissible states for an object (DoDAF::Constraint).

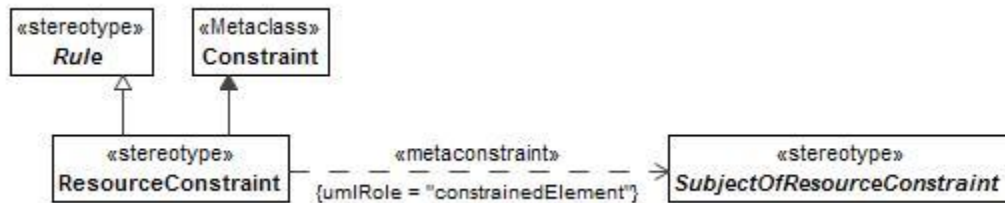

Figure 8:134 - ResourceConstraint

- **Constraints**

The following are constraints for ResourceConstraint:

- **ResourceConstraint.constrainedElement** - Value for the constrainedElement property must be stereotyped «SubjectOfResourceConstraint» or its specializations.

- **Extensions**

The following metaclasses are extended by ResourceConstraint:

- Constraint

- **Specializations**

The ResourceConstraint element is a specialization of:

- Rule

8.2.1.1.7.4.11 ResourceInterface

UPDM: ResourceInterface is a contractual agreement between two resources that implement protocols through which the source resource to the destination resource.

MODAF: NA

DoDAF: An overlap between Performers for the purpose of producing a Resource that is consumed by the other (DoDAF:: Interface).

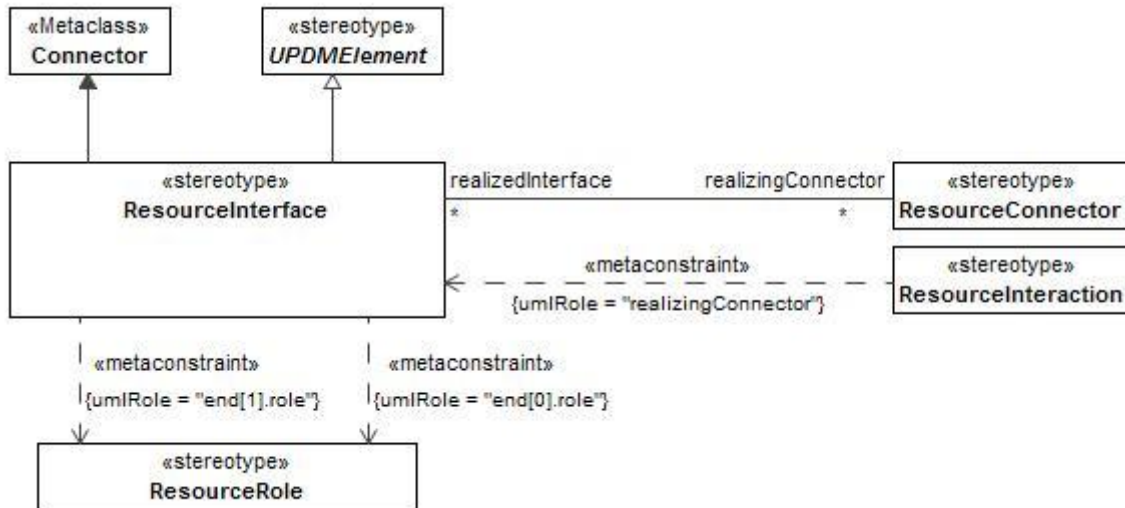

Figure 8:135 - ResourceInterface

- **Constraints**

The following are constraints for ResourceInterface:

- ResourceInterface.end - the value for the role property for the owned ConnectorEnd must be stereotype «ResourceRole» or its specializations.

- **Attributes**

The following are attributes for ResourceInterface:

- realizingConnector : ResourceConnector[*] - Realizing ResourceConnectors.

- **Extensions**

The following metaclasses are extended by ResourceInterface:

- Connector

- **Specializations**

The ResourceInterface element is a specialization of:

- UPDMElement

8.2.1.1.7.4.12 ResourcePort

UPDM: Port is an interaction point for a resource through which it can interact with the outside environment.

MODAF: An interface (logical or physical) provided by a System. A SystemPort may implement a PortType though there is no requirement for SystemPorts to be typed (MODAF:: SystemPort).

DoDAF: An interface (logical or physical) provided by a System (DoDAF::Port).

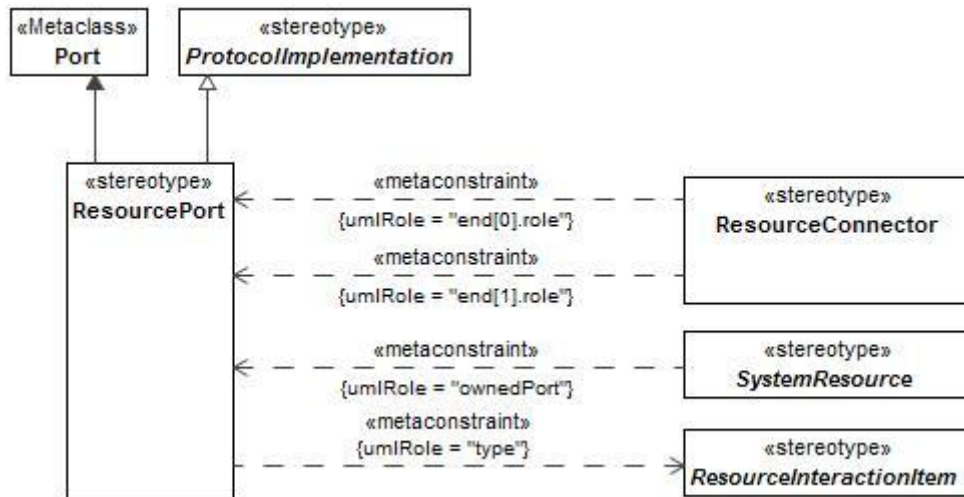

Figure 8:136 - ResourcePort

- **Constraints**

The following are constraints for ResourcePort:

- ResourcePort.type - Value for the type property must be stereotyped «ResourceInteractionItem» or its specializations.

- **Extensions**

The following metaclasses are extended by ResourcePort:

- Port

- **Specializations**

The ResourcePort element is a specialization of:

- ProtocolImplementation

8.2.1.1.7.4.13 ResourceRole

UPDM: abstract element.

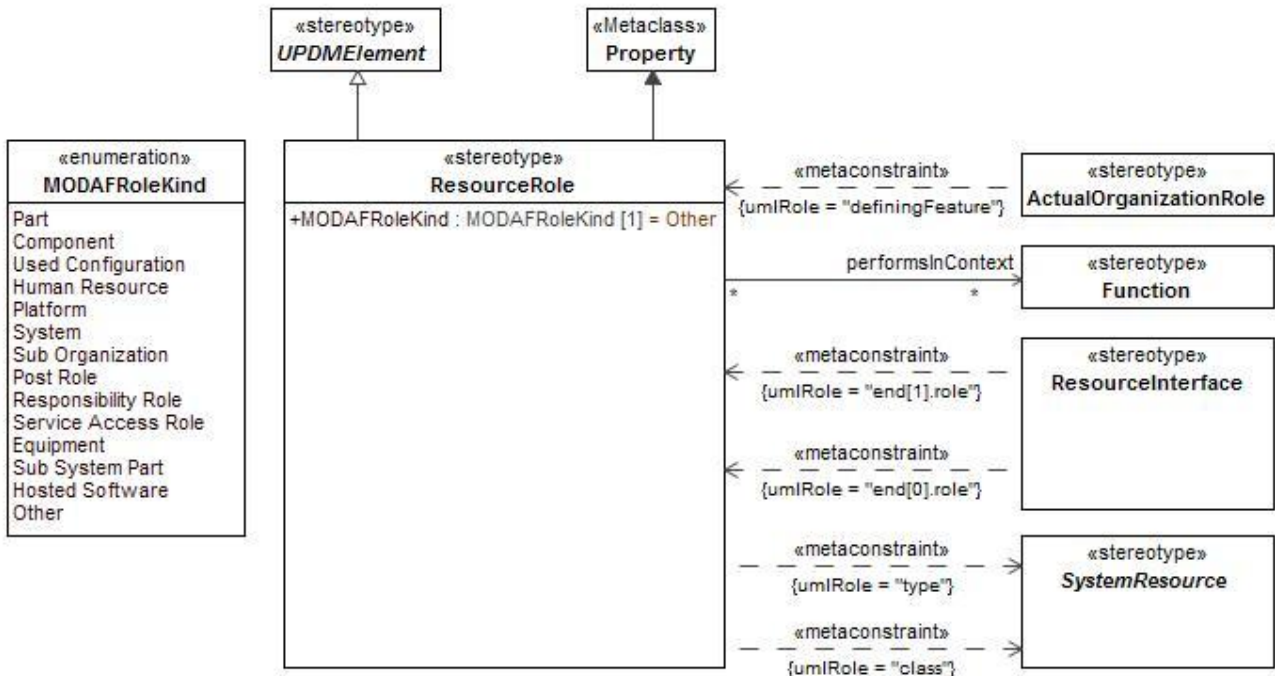

Figure 8:137 - ResourceRole

- **Constraints**

The following are constraints for ResourceRole:

- **ResourceRole.type** - An element with the stereotype «ResourceRole» applied must have the «SystemResource» stereotype (or its specializations) applied to the targets of its extended metaclass property "type".
- **ResourceRole.class** - Value for the class property must be stereotyped «SystemResource» or its specializations.

- **Attributes**

The following are attributes for ResourceRole:

- MODAFRoleKind : MODAFRoleKind[1] - Enumeration of the kinds of role a resource can play.
- performsInContext : Function[*] - Functions used by the ResourceRole.

- **Extensions**

The following metaclasses are extended by ResourceRole:

- Property

- **Specializations**

The ResourceRole element is a specialization of:

- UPDMElement

8.2.1.1.7.4.14 Software

MODAF: An executable computer programme.

DoDAF: Material: Equipment, apparatus or supplies that are of interest, without distinction as to its application for administrative or combat purposes.

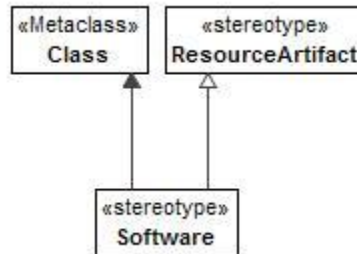

Figure 8:138 - Software

- **Extensions**

The following metaclasses are extended by Software:

- Class

- **Specializations**

The Software element is a specialization of:

- ResourceArtifact

8.2.1.1.7.4.15 SubjectOfForecast

MODAF: Abstract Any element that may be subject to a Forecast.

Note: SubjectOfForecast is abstract.

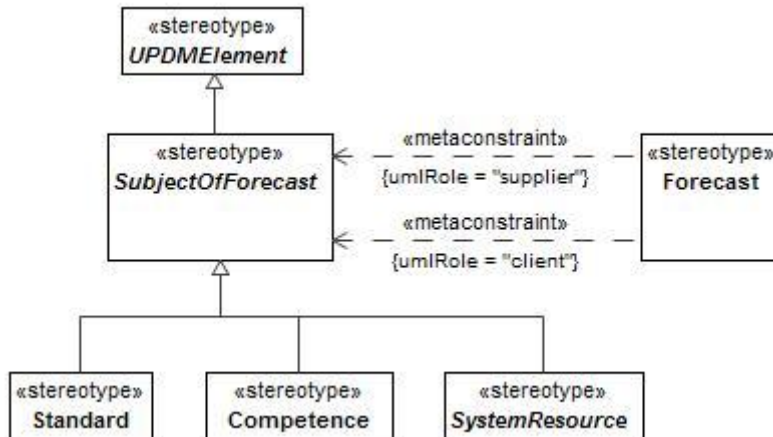

Figure 8:139 - SubjectOfForecast

- **Specializations**

The SubjectOfForecast element is a specialization of:

- UPDMElement

8.2.1.1.7.4.16 SubjectOfResourceConstraint

MODAF: Abstract. Anything that may be constrained by a ResourceConstraint.

Note: SubjectOfResourceConstraint is abstract.

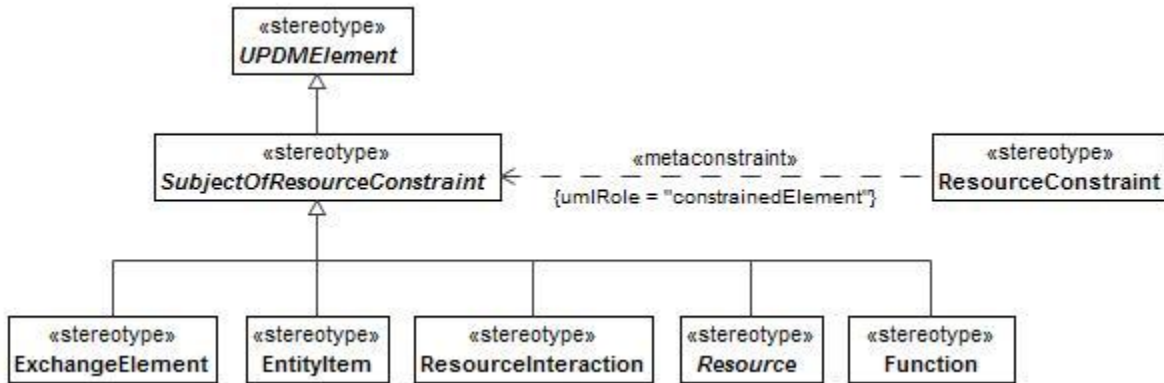

Figure 8:140 - SubjectOfResourceConstraint

- **Specializations**

The SubjectOfResourceConstraint element is a specialization of:

- UPDMElement

8.2.1.1.7.4.17 SystemResource

UPDM: Abstract element used as placeholder for resource properties.

Note: SystemResource is abstract.

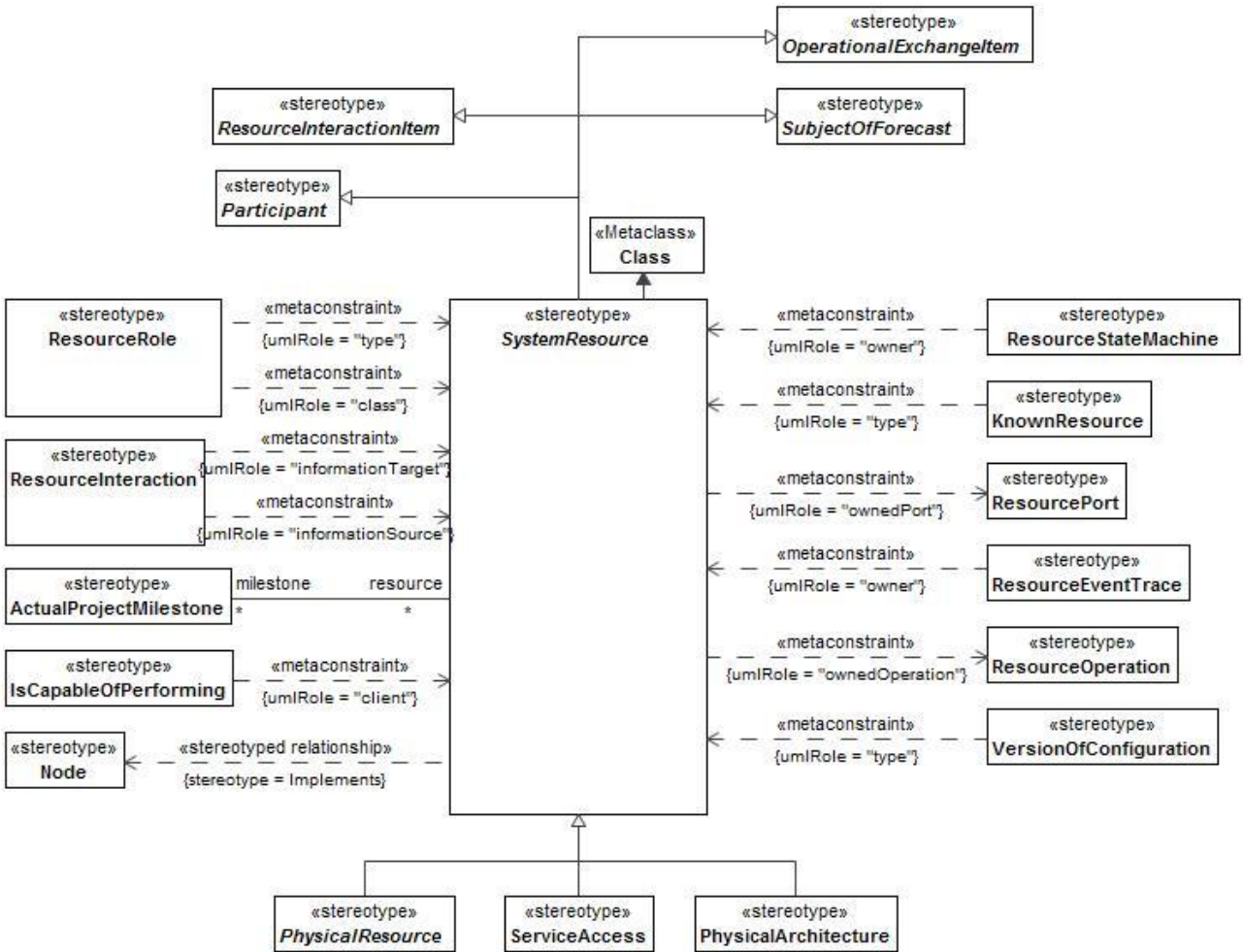

Figure 8:141 - SystemResource

- **Constraints**

The following are constraints for SystemResource:

- **Resource.ownedOperation** - Values for the ownedOperation property must be stereotyped with «ResourceOperation» or its specializations.
- **Resource.ownedPort** - Values for the ownedPort property must be stereotyped with «ServicePort» or its specializations.
- **Resource.performs** - Can perform only «Functions».

- **Attributes**

The following are attributes for SystemResource:

- **milestone** : ActualProjectMilestone[*] - A Linked milestone.

- **Extensions**

The following metaclasses are extended by SystemResource:

- Class

- **Specializations**

The SystemResource element is a specialization of:

- Participant
- ResourceInteractionItem
- SubjectOfForecast
- OperationalExchangeItem

8.2.1.1.7.4.18 VersionOfConfiguration

MODAF: Asserts that a CapabilityConfiguration is a version of a WholeLifeConfiguration.

DoDAF: NA

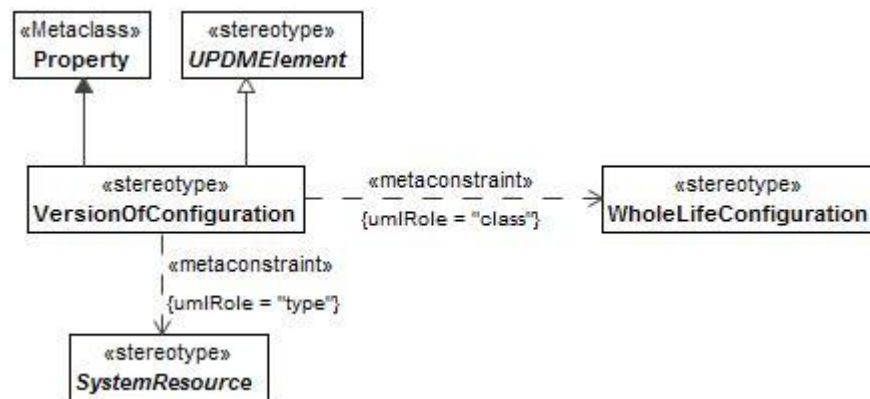

Figure 8:142 - VersionOfConfiguration

- **Constraints**

The following are constraints for VersionOfConfiguration:

- **VersionOfConfiguration.class** - Value for the class property must be stereotyped «WholeLifeConfiguration» or its specializations.
- **VersionOfConfiguration.type** - Value for the type property must be stereotyped «SystemResource» or its specializations.

- **Extensions**

The following metaclasses are extended by VersionOfConfiguration:

- Property

- **Specializations**

The VersionOfConfiguration element is a specialization of:

- UPDMElement

8.2.1.1.7.4.19 WholeLifeConfiguration

MODAF: A set of versions of a CapabilityConfiguration over time.

DoDAF: NA

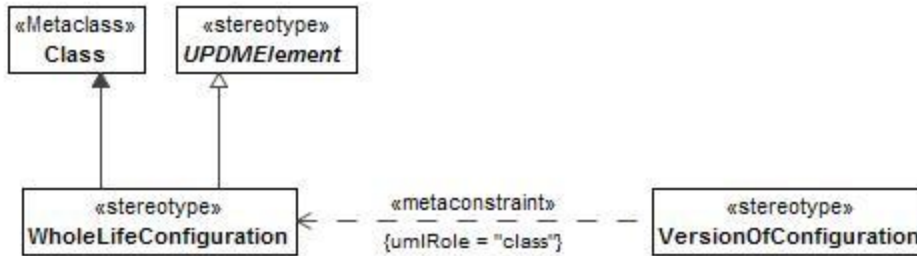

Figure 8:143 - WholeLifeConfiguration

- **Extensions**

The following metaclasses are extended by WholeLifeConfiguration:

- Class

- **Specializations**

The WholeLifeConfiguration element is a specialization of:

- UPDMElement

8.2.1.1.8 UPDM L1::UPDM L0::Core::TechnicalStandardsElements

Section 1.4.4 of the DoDAF version 1.5 Definitions and Guidelines (Volume I) Define the purpose of the Technical View as follows:

“The TV is the minimal set of rules governing the arrangement, interaction, and interdependence of system parts or elements. Its purpose is to ensure that a system satisfies a specified set of operational requirements. The TV provides the technical systems implementation guidelines upon which engineering specifications are based, common building blocks are established, and product lines are developed. It includes a collection of the technical standards, implementation conventions, standards options, rules, and criteria that can be organized into profile(s) that govern systems and system or service elements for a given architecture.”

8.2.1.1.8.1 Protocol

MODAF: A Standard for communication. Protocols may be composite (i.e., a stack).

DoDAF: NA, See TechnicalStandard.

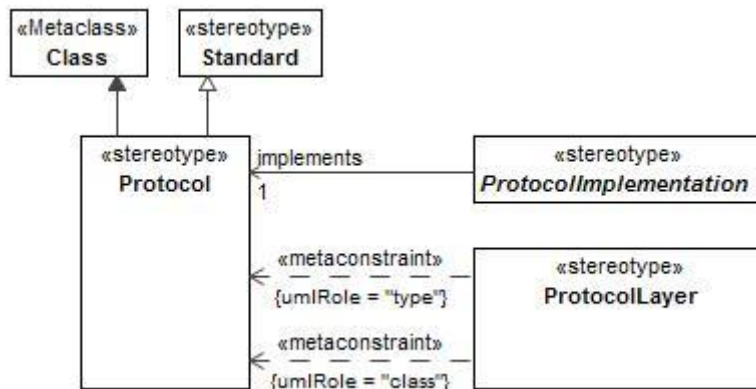

Figure 8:144 - Protocol

- **Extensions**

The following metaclasses are extended by Protocol:

- Class

- **Specializations**

The Protocol element is a specialization of:

- Standard

8.2.1.1.8.2 ProtocolImplementation

UPDM: Abstract element: A connector that implements a specific Protocol.

MODAF: An element that can implement a Protocol.

Note: ProtocolImplementation is abstract.

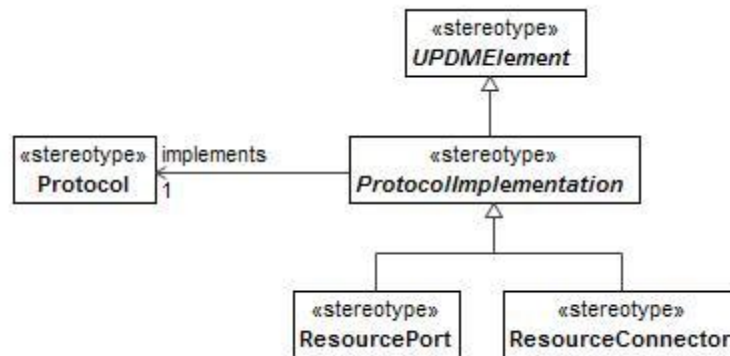

Figure 8:145 - ProtocolImplementation

- **Attributes**

The following are attributes for ProtocolImplementation:

- implements: Protocol[1] - The <<Protocol>> which can be implemented by the Connector targets.

- **Specializations**

The ProtocolImplementation element is a specialization of:

- UPDMElement

8.2.1.1.8.3 Standard

MODAF: A ratified and peer-reviewed specification that is used to guide or constrain the architecture. A Standard may be applied to any element in the architecture via the [constrainedItem] property of UML::Constraint.

DoDAF: A formal agreement documenting generally accepted specifications or criteria for products, processes, procedures, policies, systems, and/or personnel.

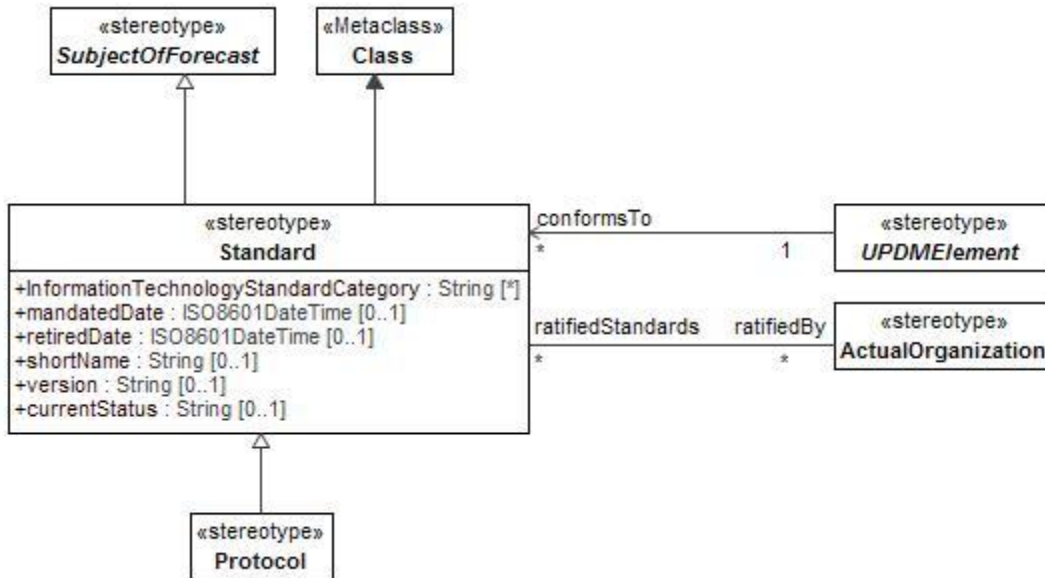

Figure 8:146 - Standard

- **Attributes**

The following are attributes for Standard:

- `currentStatus: String[0..1]` - Current status of the Standard.
- `InformationTechnologyStandardCategory: String[*]` - The information technology standard category which the <<Standard>> belongs to.
- `mandatedDate: ISO8601DateTime[0..1]` - The date when this version of the Standard was published.
- `ratifiedBy: ActualOrganization[*]` - Organization that ratified this Standard.
- `retiredDate: ISO8601DateTime[0..1]` - The date when this version of the Standard was retired.
- `shortName: String[0..1]` - Short name of the Standard.
- `version: String[0..1]` - Represents the revision number of the Standard - e.g., "1.2.1," "v2," ":2004," etc.

- **Extensions**

The following metaclasses are extended by Standard:

- Class

- **Specializations**

The Standard element is a specialization of:

- SubjectOfForecast

8.2.1.1.8.4 StandardConfiguration

MODAF: A UML::Comment that when attached to a CapabilityConfiguration indicates that it is a standard pattern for re-use in the architecture.

DoDAF: NA

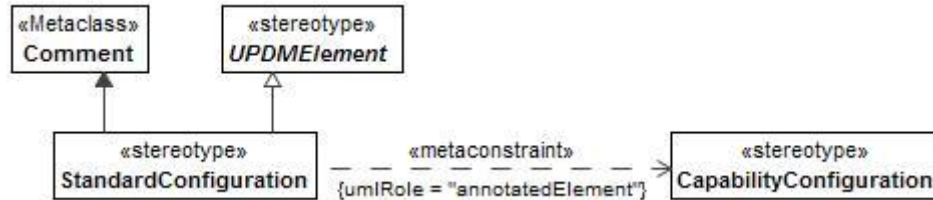

Figure 8:147 - StandardConfiguration

- **Constraints**

The following are constraints for StandardConfiguration:

- **StandardConfiguration.annotatedElement** - Value for the annotatedElement property must be stereotyped «CapabilityConfiguration».

- **Extensions**

The following metaclasses are extended by StandardConfiguration:

- Comment

- **Specializations**

The StandardConfiguration element is a specialization of:

- UPDMElement

8.2.1.1.8.5 UPDM L1::UPDM L0::Core::TechnicalStandardsElements::Data

The data portion of the AllElements profile.

8.2.1.1.8.5.1 Details

UPDM: A tuple used to provide the relationship between an entityItem and an ExchangeElement.

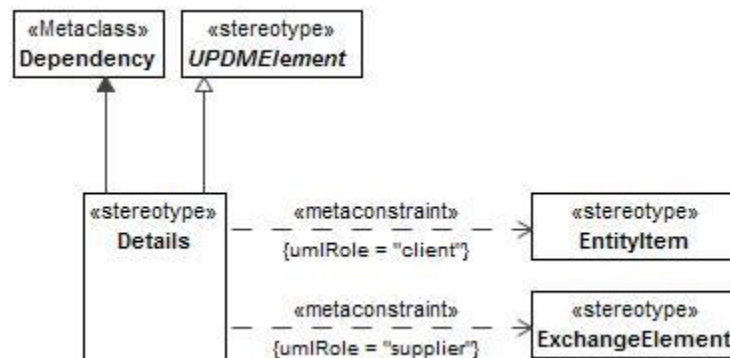

Figure 8:148 - Details

- **Constraints**

The following are constraints for Details:

- **Details.client** - Value for the client property must be stereotyped a specialization of «EntityItem».
- **Details.supplier** - Value for the supplier property must be stereotyped «ExchangeElement».

- **Extensions**

The following metaclasses are extended by Details:

- Dependency

- **Specializations**

The Details element is a specialization of:

- UPDMElement

8.2.1.1.8.5.2 EntityAttribute

MODAF: A defined property of an EntityItem.

DoDAF: NA

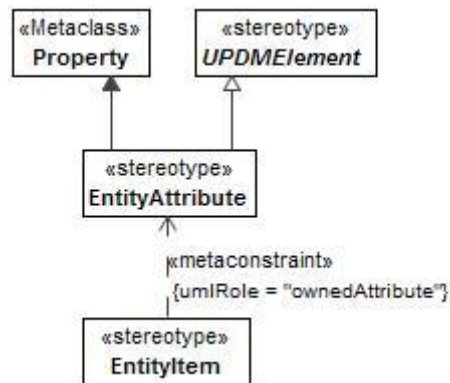

Figure 8:149 - EntityAttribute

- **Constraints**

The following are constraints for EntityAttribute:

- **EntityAttribute.canBeAppliedTo** - «EntityAttribute» stereotype can be applied to Properties that are owned only by «EntityItem»

- **Extensions**

The following metaclasses are extended by EntityAttribute:

- Property

- **Specializations**

The EntityAttribute element is a specialization of:

- UPDMElement

8.2.1.1.8.5.3 EntityItem

MODAF: (MODAF::Entity): A definition (type) of an item of interest.
DoDAF: NA

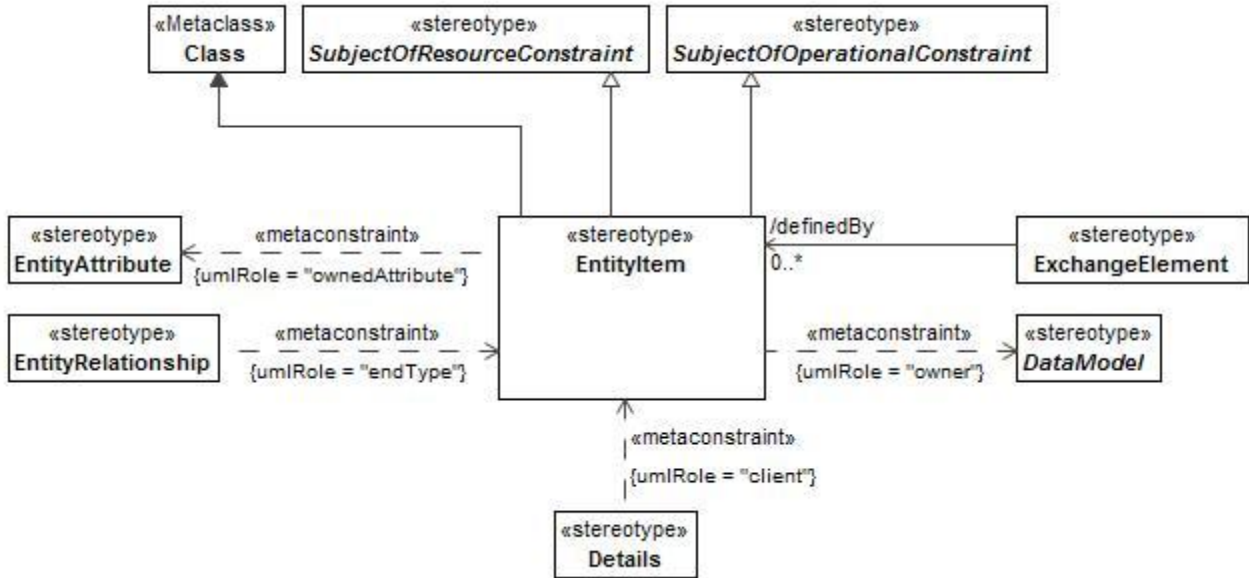

Figure 8:150 - EntityItem

- **Constraints**

The following are constraints for EntityItem:

- EntityItem.ownedAttribute - Value for the ownedAttribute property must be stereotyped «EntityAttribute» or its specializations.

- **Extensions**

The following metaclasses are extended by EntityItem:

- Class

- **Specializations**

The EntityItem element is a specialization of:

- SubjectOfOperationalConstraint
- SubjectOfResourceConstraint

8.2.1.1.8.5.4 EntityRelationship

MODAF: Asserts that there is a relationship between two EntityItems.

DoDAF: (DoDAF::DataAssociation): A relationship or association between two elements of proceduralized information.

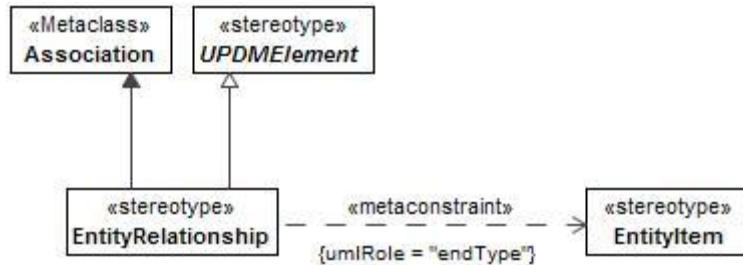

Figure 8:151 - EntityRelationship

- **Constraints**

The following are constraints for EntityRelationship:

- **EntityRelationship.endType** - Values for the endType property must be stereotyped «EntityItem» or its specializations.

- **Extensions**

The following metaclasses are extended by EntityRelationship:

- Association

- **Specializations**

The EntityRelationship element is a specialization of:

- UPDMElement

8.2.1.2 UPDM L1::UPDM L0::DoDAF

Elements that are not considered part of the Core architectural model, but necessary for DoDAF.

8.2.1.2.1 UPDM L1::UPDM L0::DoDAF::AcquisitionElements

This sub clause of the specification contains the Acquisition elements of the DoDAF sub clause.

8.2.1.2.1.1 ActivityPartOfProject

UPDM: As in DoDAF

DoDAF: A wholePart relationship between a Project and an Activity (Task) that is part of the Project.

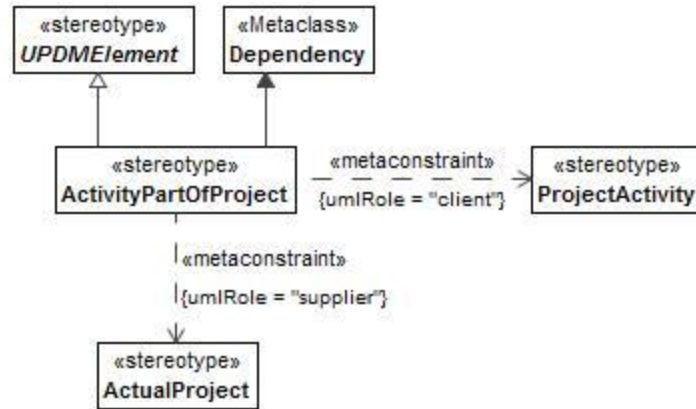

Figure 8:152 - ActivityPartOfProject

- **Constraints**

The following are constraints for ActivityPartOfProject:

- ActivityPartOfProject.client - Value for the client property must be stereotyped a specialization of «ProjectActivity».
- ActivityPartOfProject.supplier - Value for the supplier property must be stereotyped «ActualProject».

- **Extensions**

The following metaclasses are extended by ActivityPartOfProject:

- Dependency

- **Specializations**

The ActivityPartOfProject element is a specialization of:

- UPDMElement

8.2.1.2.1.2 Project

DoDAF: A temporary endeavor undertaken to create Resources or Desired Effects.

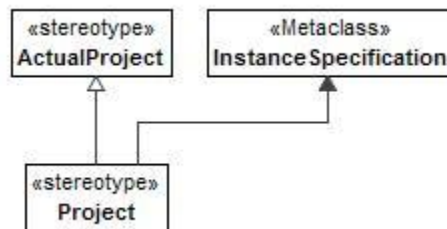

Figure 8:153 - Project

- **Extensions**

The following metaclasses are extended by Project:

- InstanceSpecification

- **Specializations**

The Project element is a specialization of:

- ActualProject

8.2.1.2.1.3 ProjectActivity

MOAF: NA

DoDAF: An activity carried out during a project.

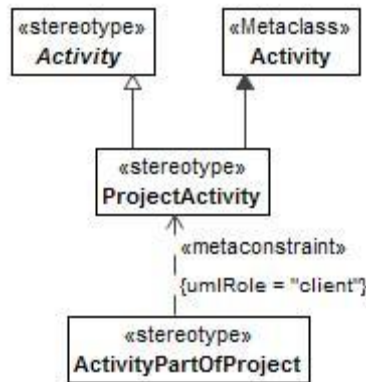

Figure 8:154 - ProjectActivity

- **Extensions**

The following metaclasses are extended by ProjectActivity:

- Activity

- **Specializations**

The ProjectActivity element is a specialization of:

- Activity

8.2.1.2.2 UPDM L1::UPDM L0::DoDAF::AllElements

The All View elements for DoDAF specific models. The All View elements provide information about the entire Architecture. They are used for support rather than architectural models.

8.2.1.2.2.1 Information

UPDM: As DoDAF

MODAF: N/A

DoDAF: Information is the state of something of interest that is materialized, in any medium or form, and communicated or received.

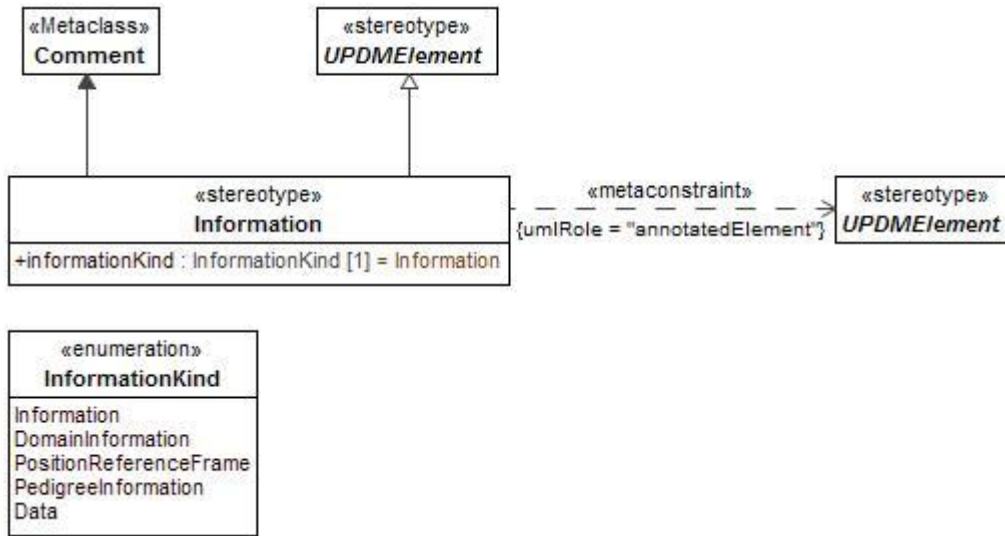

Figure 8:155 - Information

- **Constraints**

The following are constraints for Information:

- **Information.annotatedElement** - Value for the annotatedElement property must be stereotyped <<UPDMElement>> or its specializations.

- **Attributes**

The following are attributes for Information:

- informationKind: InformationKind[1] - Enumeration of the kinds of information being passed.

- **Extensions**

The following metaclasses are extended by Information:

- Comment

- **Specializations**

The Information element is a specialization of:

- UPDMElement

8.2.1.2.2.2 InformationKind

Enumeration of kinds of information, derived from MODAF and DoDAF, used to support the InformationKind tag of the Information stereotype.

- **Enumeration Literals**

The following are enumeration literals for InformationKind:

- Data - Representation of information in a formalized manner suitable for communication, interpretation, or processing by humans or by automatic means. Examples could be whole models, packages, entities, attributes, classes, domain values, enumeration values, records, tables, rows, columns, and fields.

- DomainInformation - Types of information within the scope or domain of the architecture.
- Information - Information is the state of something of interest that is materialized, in any medium or form, and communicated or received.
- PedigreeInformation - Information describing pedigree.
- PositionReferenceFrame - An arbitrary set of axes with reference to which the position or motion of something is described or physical laws are formulated.

8.2.1.2.2.3 UPDM L1::UPDM L0::DoDAF::AllElements::Behavior

This sub clause of the specification contains the Behavior Elements of the DoDAF, All Elements sub clause.

8.2.1.2.2.3.1 ActivityPerformedByPerformer

UPDM: Links a Performer to the behavior that it can perform.

MODAF: NA

DoDAF: An overlap of an Activity with a Resource, in particular a consuming or producing Activity that expresses an input, output, consumption, or production Activity of the Resource.

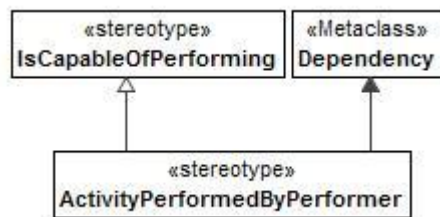

Figure 8:156 - ActivityPerformedByPerformer

- **Extensions**

The following metaclasses are extended by ActivityPerformedByPerformer:

- Dependency

- **Specializations**

The ActivityPerformedByPerformer element is a specialization of:

- IsCapableOfPerforming

8.2.1.2.2.4 UPDM L1::UPDM L0::DoDAF::AllElements::Environment

This sub clause of the specification contains the Environmental Elements of the DoDAF, All Elements sub clause.

8.2.1.2.2.4.1 Condition

MODAF: A definition of the conditions in which something exists or functions. An Environment may be specified in terms of LocationType (e.g., terrain), Climate (e.g., tropical), and LightCondition (e.g., dark, light, dusk, etc.)

DoDAF: An object that encompasses meteorological, geographic, and control features mission significance.

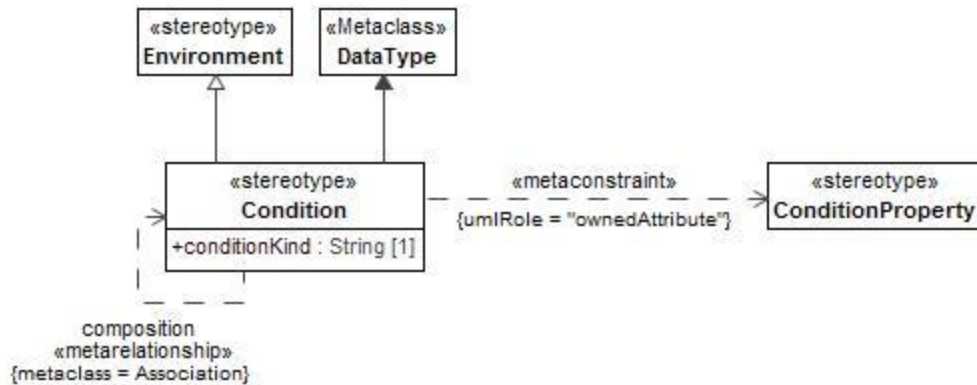

Figure 8:157 - Condition

- **Constraints**

The following are constraints for Condition:

- **Condition.ownedAttribute** - Values for the ownedAttribute property must be stereotyped «ConditionProperty» or its specializations.

- **Attributes**

The following are attributes for Condition:

- conditionKind: String[1] - String defining the type of condition being set.

- **Extensions**

The following metaclasses are extended by Condition:

- DataType

- **Specializations**

The Condition element is a specialization of:

- Environment

8.2.1.2.2.4.2 ConditionProperty

MODAF: EnvironmentalProperty: Asserts that an Environment has one or more properties. These may be Climate, LocationType, or LightCondition.

DoDAF: NA

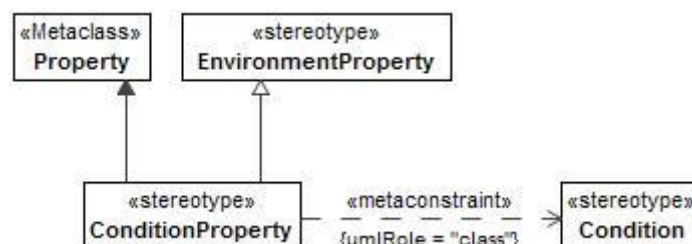

Figure 8:158 - ConditionProperty

- **Constraints**

The following are constraints for ConditionProperty:

- `ConditionProperty.class` - Value for the class property must be stereotyped `«Condition»` or its specializations.

- **Extensions**

The following metaclasses are extended by ConditionProperty:

- Property

- **Specializations**

The ConditionProperty element is a specialization of:

- EnvironmentProperty

8.2.1.2.2.4.3 GeoPoliticalExtent

UPDM: An instance of a GeoPoliticalExtentType

MODAF: N/A

DoDAF: N/A

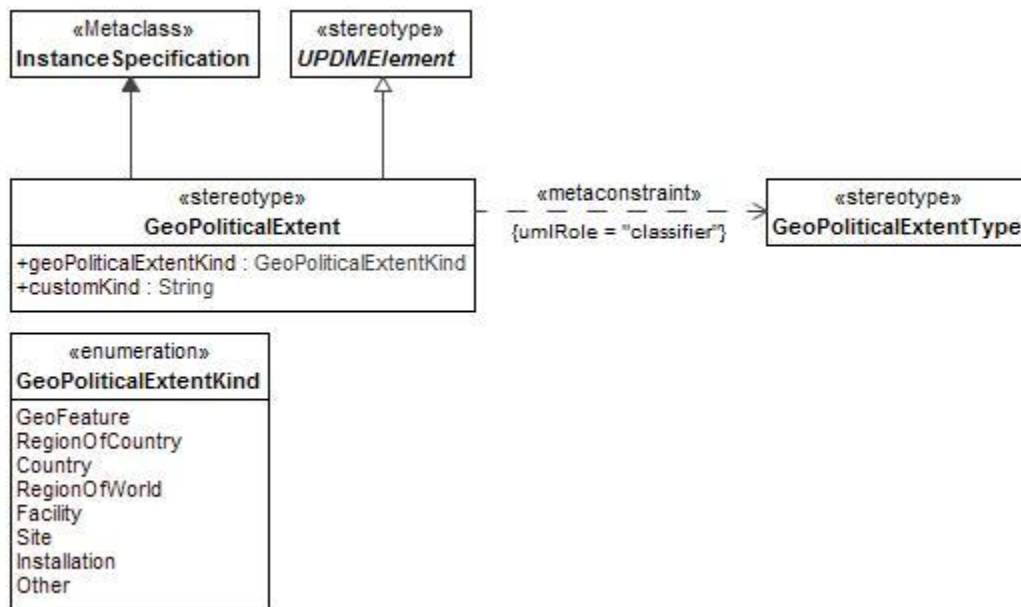

Figure 8:159 - GeoPoliticalExtent

- **Constraints**

The following are constraints for GeoPoliticalExtent:

- `GeoPoliticalExtent.classifier` - Classifier property value must be stereotyped `«GeoPoliticalExtentType»` or its specializations.

- **Attributes**

The following are attributes for GeoPoliticalExtent:

- `customKind: String[]` - String defining custom kinds of geopolitical extent.

- geoPoliticalExtentKind: GeoPoliticalExtentKind[] - Enumeration of kinds of GeopoliticalExtent.

- **Extensions**

The following metaclasses are extended by GeoPoliticalExtent:

- InstanceSpecification

- **Specializations**

The GeoPoliticalExtent element is a specialization of:

- UPDMElement

8.2.1.2.2.4.4 GeoPoliticalExtentKind

Enumeration of geopolitical extent kinds, used to support the geoPoliticalExtentKind tag of the geoPoliticalExtent stereotype, derived from DoDAF.

- **Enumeration Literals**

The following are enumeration literals for GeoPoliticalExtentKind:

- Country - A political state or nation or its territory.
- Facility - A real property entity consisting of underlying land and one or more of the following: a building, a structure (including linear structures), a utility system, or pavement.
- GeoFeature - An object that encompasses meteorological, geographic, and control features mission significance.
- Installation - A base, camp, post, station, yard, center, or other activity, including leased facilities, without regard to the duration of operational control. An installation may include one or more sites.
- Other - Other GeoPoliticalExtent kind that is not on the enumerated list.
- RegionOfCountry - A large, usually continuous segment of a political state or nation or its territory.
- RegionOfWorld - A large, usually continuous segment of a surface or space; area.
- Site - Physical (geographic) location that is or was owned by, leased to, or otherwise possessed. Each site is assigned to a single installation. A site may exist in one of three forms: (1) Land only, where there are no facilities present and where the land consists of either a single land parcel or two or more contiguous land parcels. (2) Facility or facilities only, where the underlying land is neither owned nor controlled by the government. A stand-alone facility can be a site. If a facility is not a stand-alone facility, it must be assigned to a site. (3). Land and all the facilities thereon, where the land consists of either a single land parcel or two or more contiguous land parcels.

8.2.1.2.2.4.5 GeoPoliticalExtentType

MODAF: NA

DoDAF: A geospatial extent whose boundaries are by declaration or agreement by political parties.

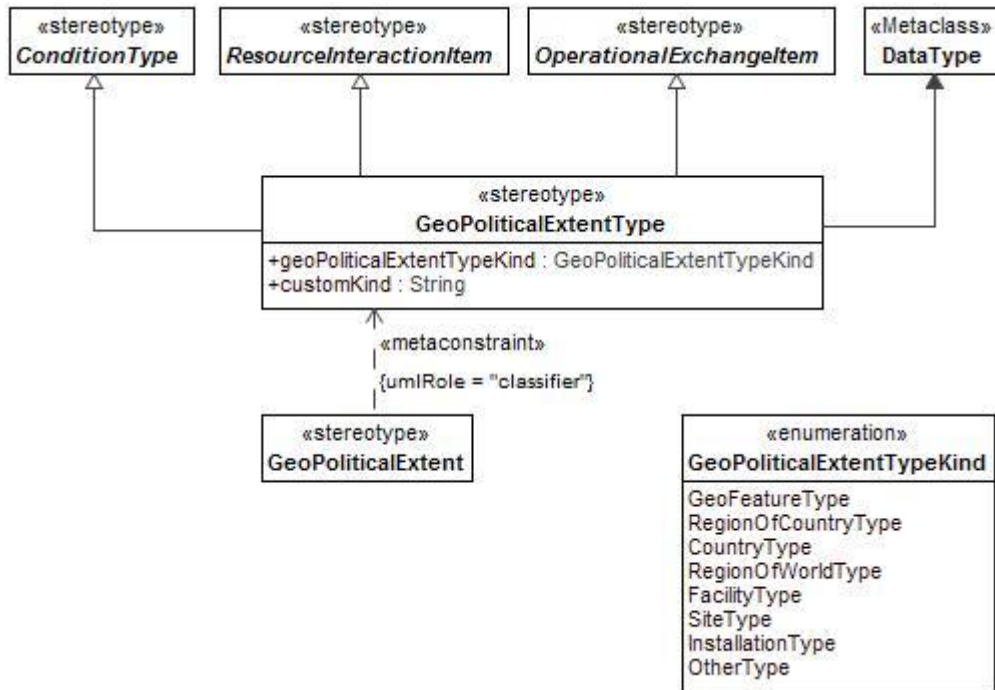

Figure 8:160 - GeoPoliticalExtentType

- **Attributes**

The following are attributes for GeoPoliticalExtentType:

- customKind: String[] - String defining custom kinds of GeopoliticalExtentTypes.
- geoPoliticalExtentTypeKind: GeoPoliticalExtentTypeKind[] - Enumeration of kinds GeopoliticalExtentTypes.

- **Extensions**

The following metaclasses are extended by GeoPoliticalExtentType:

- DataType

- **Specializations**

The GeoPoliticalExtentType element is a specialization of:

- ResourceInteractionItem
- OperationalExchangeItem
- ConditionType

8.2.1.2.2.4.6 GeoPoliticalExtentTypeKind

Enumeration of kinds of geopolitical extent type, derived from DoDAF, used to support the geoPoliticalExtentTypeKind tag of the GeopoliticalExtentType stereotype.

- **Enumeration Literals**

The following are enumeration literals for GeoPoliticalExtentTypeKind:

- CountryType - Powertype Of Country.
- FacilityType - Powertype Of Facility.
- GeoFeatureType - Powertype Of GeoFeature.
- InstallationType - Powertype Of Installation.
- OtherType - Other GeoPoliticalExtentType kind that is not on the enumerated list.
- RegionOfCountryType - Powertype Of RegionOfCountry.
- RegionOfWorldType - Powertype Of RegionOfWorld.
- SiteType - Powertype Of Site.

8.2.1.2.2.4.7 Location

DoDAF: All subtypes of << IndividualType>> Location, such as Facility, Site, etc.

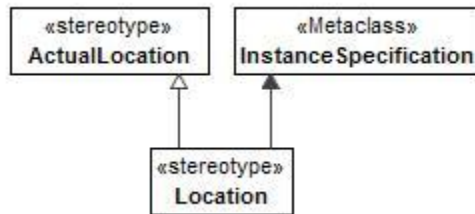

Figure 8:161 - Location

- **Extensions**

The following metaclasses are extended by Location:

- InstanceSpecification

- **Specializations**

The Location element is a specialization of:

- ActualLocation

8.2.1.2.2.5 UPDM L1::UPDM L0::DoDAF::AllElements::Measurements

This sub clause of the specification contains the Measurement Elements of the DoDAF, All Elements sub clause.

8.2.1.2.2.5.1 Measure

MODAF: NA

DoDAF: The magnitude of some attribute of an individual.

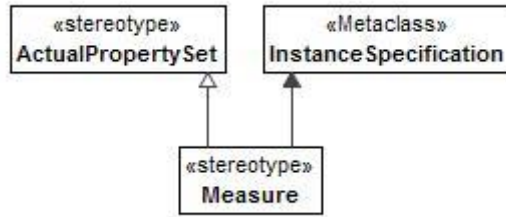

Figure 8:162 - Measure

- **Extensions**

The following metaclasses are extended by Measure:

- InstanceSpecification

- **Specializations**

The Measure element is a specialization of:

- ActualPropertySet

8.2.1.2.2.5.2 MeasureType

MODAF: NA

DoDAF: A category of Measures.

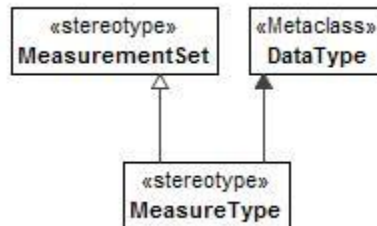

Figure 8:163 - MeasureType

- **Extensions**

The following metaclasses are extended by MeasureType:

- DataType

- **Specializations**

The MeasureType element is a specialization of:

- MeasurementSet

8.2.1.2.3 UPDM L1::UPDM L0::DoDAF::OperationalElements

The Operational View elements for DoDAF specific models.

8.2.1.2.3.1 UPDM L1::UPDM L0::DoDAF::OperationalElements::Structure

Sub clause of the OperationalElements profile that describe structural concepts for DoDAF.

8.2.1.2.3.1.1 Performer

MODAF: NA

DoDAF: Any entity - human, automated, or any aggregation of human and/or automated - that performs an activity and provides a capability. An alias for Node in DoDAF.

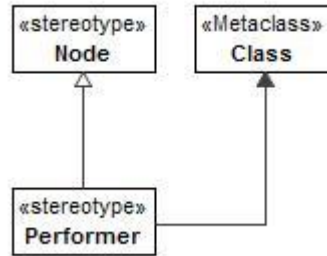

Figure 8:164 - Performer

- **Extensions**

The following metaclasses are extended by Performer:

- Class

- **Specializations**

The Performer element is a specialization of:

- Node

8.2.1.2.3.1.2 UPDM L1::UPDM

L0::DoDAF::OperationalElements::Structure::Organizational

This sub clause of the specification contains the organizational Elements of the DoDAF, Operational Elements sub clause.

8.2.1.2.3.1.2.1 IndividualPersonRole

UPDM: An individual person.

MODAF: NA

DoDAF: An Individual person.

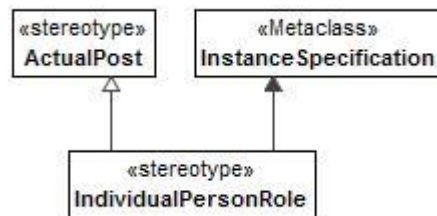

Figure 8:165 - IndividualPersonRole

- **Extensions**

The following metaclasses are extended by IndividualPersonRole:

- InstanceSpecification

- **Specializations**

The IndividualPersonRole element is a specialization of:

- ActualPost

8.2.1.2.3.1.2.2 OrganizationType

DoDAF: A type of Organization.

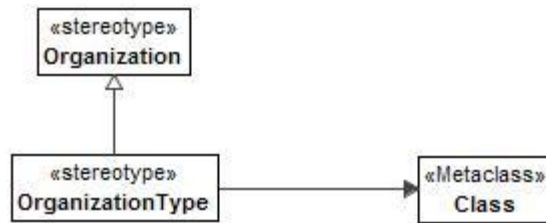

Figure 8:166 - OrganizationType

- **Extensions**

The following metaclasses are extended by OrganizationType:

- Class

- **Specializations**

The OrganizationType element is a specialization of:

- Organization

8.2.1.2.3.1.2.3 PersonType

DoDAF: A category of persons defined by the role or roles they share that are relevant to an architecture. Includes assigned material.

MODAF: NA

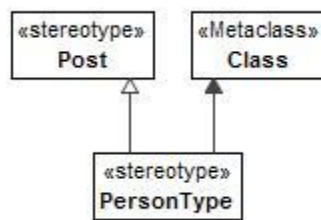

Figure 8:167 - PersonType

- **Extensions**

The following metaclasses are extended by PersonType:

- Class

- **Specializations**

The PersonType element is a specialization of:

- Post

8.2.1.2.3.1.2.4 Skill

MODAF: A specific set of abilities defined by knowledge, skills and attitude (Competence).

DoDAF: The ability, coming from one's knowledge, practice, aptitude, etc., to do something well.

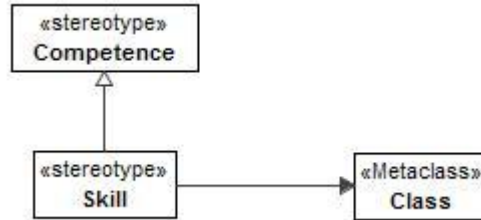

Figure 8:168 - Skill

- **Extensions**

The following metaclasses are extended by Skill:

- Class

- **Specializations**

The Skill element is a specialization of:

- Competence

8.2.1.2.3.1.2.5 SkillOfPersonType

UPDM: Alias for ProvidesCompetence, the tuple showing the skills and competencies required from a particular role or organization.

DoDAF: A type property between a PersonRoleType and the Skills it entails.

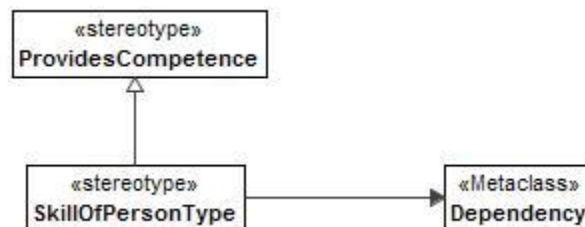

Figure 8:169 - SkillOfPersonType

- **Extensions**

The following metaclasses are extended by SkillOfPersonType:

- Dependency

- **Specializations**

The SkillOfPersonType element is a specialization of:

- ProvidesCompetence

8.2.1.2.4 UPDM L1::UPDM L0::DoDAF::ServiceElements

This sub clause of the specification contains the Service Elements of the DoDAF sub clause.

8.2.1.2.4.1 ServiceAccess

UPDM: The mechanism by which a service is accessed

MODAF: NA

DoDAF: NA

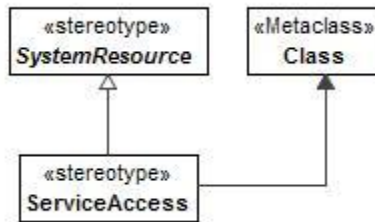

Figure 8:170 - ServiceAccess

- **Extensions**

The following metaclasses are extended by ServiceAccess:

- Class

- **Specializations**

The ServiceAccess element is a specialization of:

- SystemResource

8.2.1.2.4.2 ServiceDescription

UPDM: Package containing the elements that describe a service, from DoDAF 2.

DoDAF: Information necessary to interact with the service in such terms as the service inputs, outputs, and associated semantics. The service description also conveys what is accomplished when the service is invoked and the conditions for using the service.

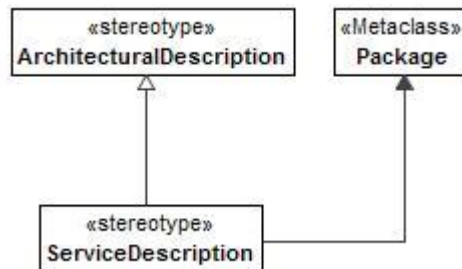

Figure 8:171 - ServiceDescription

- **Extensions**

The following metaclasses are extended by ServiceDescription:

- Package

- **Specializations**

The ServiceDescription element is a specialization of:

- ArchitecturalDescription

8.2.1.2.5 UPDM L1::UPDM L0::DoDAF::StrategicElements

This sub clause of the specification contains the Strategic Elements of the DoDAF sub clause.

8.2.1.2.5.1 ActivityPartOfCapability

UPDM: As in DoDAF

DoDAF: A disposition to manifest an Activity. An Activity to be performed to achieve a desired effect under specified [performance] standards and conditions through combinations of ways and means.

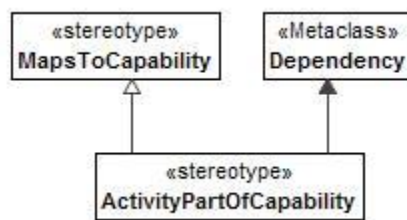

Figure 8:172 - ActivityPartOfCapability

- **Extensions**

The following metaclasses are extended by ActivityPartOfCapability:

- Dependency

- **Specializations**

The ActivityPartOfCapability element is a specialization of:

- MapsToCapability

8.2.1.2.5.2 CapabilityOfPerformer

UPDM: A couple that represents the capability that a resource, node or enterprise phase exhibits (Exhibits).

MODAF: An assertion that a Node is required to have a Capability (Capability for node).

DoDAF: A couple that represents the capability that a performer has.

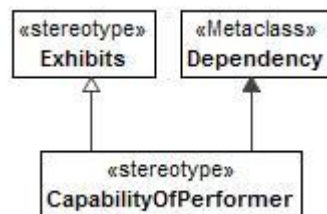

Figure 8:173 - CapabilityOfPerformer

- **Extensions**

The following metaclasses are extended by CapabilityOfPerformer:

- Dependency

- **Specializations**

The CapabilityOfPerformer element is a specialization of:

- Exhibits

8.2.1.2.5.3 DesiredEffect

MODAF: NA

DoDAF: A desired state of a Resource.

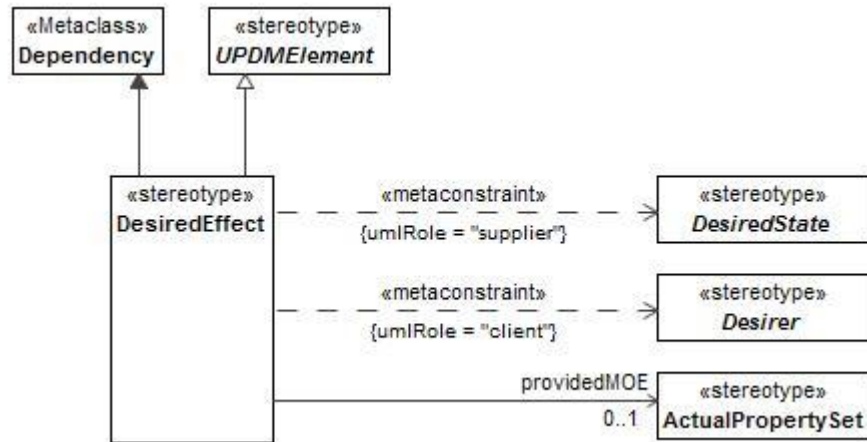

Figure 8:174 - DesiredEffect

- **Constraints**

The following are constraints for DesiredEffect:

- **DesiredEffect.client** - Value for the client property must be stereotyped a specialization of «Desirer».
- **DesiredEffect.supplier** - Value for the supplier property must be stereotyped a specialization of «DesiredState».

- **Attributes**

The following are attributes for DesiredEffect:

- providedMOE: ActualPropertySet[0..1] - Measures of the DesiredEffect.

- **Extensions**

The following metaclasses are extended by DesiredEffect:

- Dependency

- **Specializations**

The DesiredEffect element is a specialization of:

- UPDMElement

8.2.1.2.5.4 Vision

MODAF: The overall aims of an enterprise over a given period of time. (EnterpriseVision)

DoDAF: An end that describes the future state of the enterprise, without regard to how it is to be achieved; a mental image of what the future will or could be like.

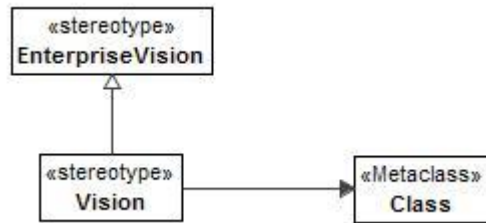

Figure 8:175 - Vision

- **Extensions**

The following metaclasses are extended by Vision:

- Class

- **Specializations**

The Vision element is a specialization of:

- EnterpriseVision

8.2.1.2.6 UPDM L1::UPDM L0::DoDAF::SystemElements

The System View elements for DoDAF specific models.

8.2.1.2.6.1 UPDM L1::UPDM L0::DoDAF::SystemElements::Structure

Defines the structure parts of the system elements.

8.2.1.2.6.1.1 System

A DoDAF alias for ResourceArtifact.

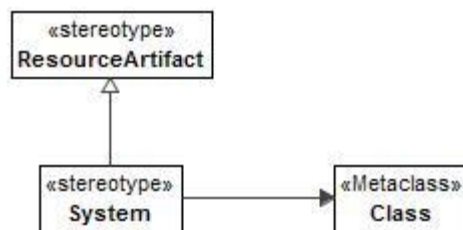

Figure 8:176 - System

- **Extensions**

The following metaclasses are extended by System:

- Class

- **Specializations**

The System element is a specialization of:

- ResourceArtifact

8.2.1.2.7 UPDM L1::UPDM L0::DoDAF::TechnicalStandardsElements

This sub clause of the specification contains the Technical Standard Elements of the DoDAF sub clause.

8.2.1.2.7.1 FunctionalStandard

MODAF: NA

DoDAF: Functional standards set forth rules, conditions, guidelines, and characteristics.

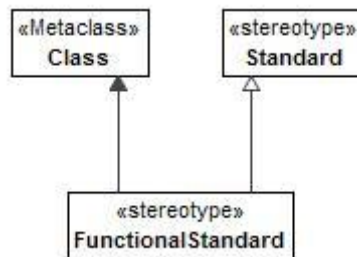

Figure 8:177 - FunctionalStandard

- **Extensions**

The following metaclasses are extended by FunctionalStandard:

- Class

- **Specializations**

The FunctionalStandard element is a specialization of:

- Standard

8.2.1.2.7.2 TechnicalStandard

MODAF: A ratified and peer-reviewed specification that is used to guide or constrain the architecture. A Standard may be applied to any element in the architecture via the [constrainedItem] property of UML::Constraint (Standard).

DoDAF: Technical standards document specific technical methodologies and practices to design and implement.

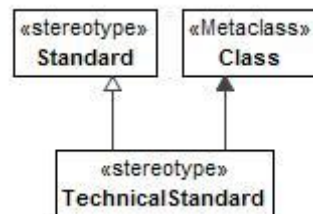

Figure 8:178 - TechnicalStandard

- **Extensions**

The following metaclasses are extended by TechnicalStandard:

- Class

- **Specializations**

The TechnicalStandard element is a specialization of:

- Standard

8.2.1.2.7.3 UPDM L1::UPDM L0::DoDAF::TechnicalStandardsElements::Data

This sub clause of the specification contains the Data elements of the DoDAF, Technical Standard Elements sub clause.

8.2.1.2.7.3.1 AssociationOfInformation

MODAF: Asserts that there is a relationship between two entities (Entity Relationship).

DoDAF: A relationship or association between two elements of information.

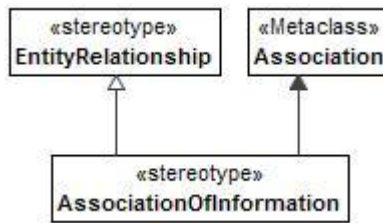

Figure 8:179 - AssociationOfInformation

- **Extensions**

The following metaclasses are extended by AssociationOfInformation:

- Association

- **Specializations**

The AssociationOfInformation element is a specialization of:

- EntityRelationship

8.2.1.2.7.3.2 SecurityAttributesGroup

MODAF: NA

DoDAF: The group of Information Security Marking attributes in which the use of attributes 'classification' and 'ownerProducer' is required. This group is to be contrasted with group 'SecurityAttributesOptionGroup' in which use of those attributes is optional.

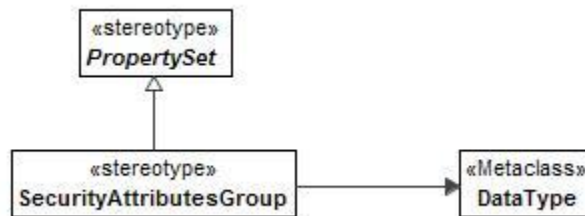

Figure 8:180 - SecurityAttributesGroup

- **Extensions**

The following metaclasses are extended by SecurityAttributesGroup:

- DataType

- **Specializations**

The SecurityAttributesGroup element is a specialization of:

- PropertySet

8.2.1.3 UPDM L1::UPDM L0::MODAF

Elements that are not considered part of the Core architectural model, but necessary for MoDAF.

8.2.1.3.1 UPDM L1::UPDM L0::MODAF::AcquisitionElements

The Acquisition View elements for MoDAF specific models.

8.2.1.3.1.1 UPDM L1::UPDM L0::MODAF::AcquisitionElements::Milestones

Milestones are an event in a Project by which progress is measured.

8.2.1.3.1.1.1 ActualProjectMilestone

MODAF: (ProjectMilestone): An event in a ActualProject (MODAF::Project) by which progress is measured. Note: in the case of an acquisition project, there are two key types of milestones which shall be represented using subtypes - IncrementMilestone (MODAF::CapabilityIncrement) and OutOfServiceMilestone (MODAF::OutOfService)
DoDAF: NA

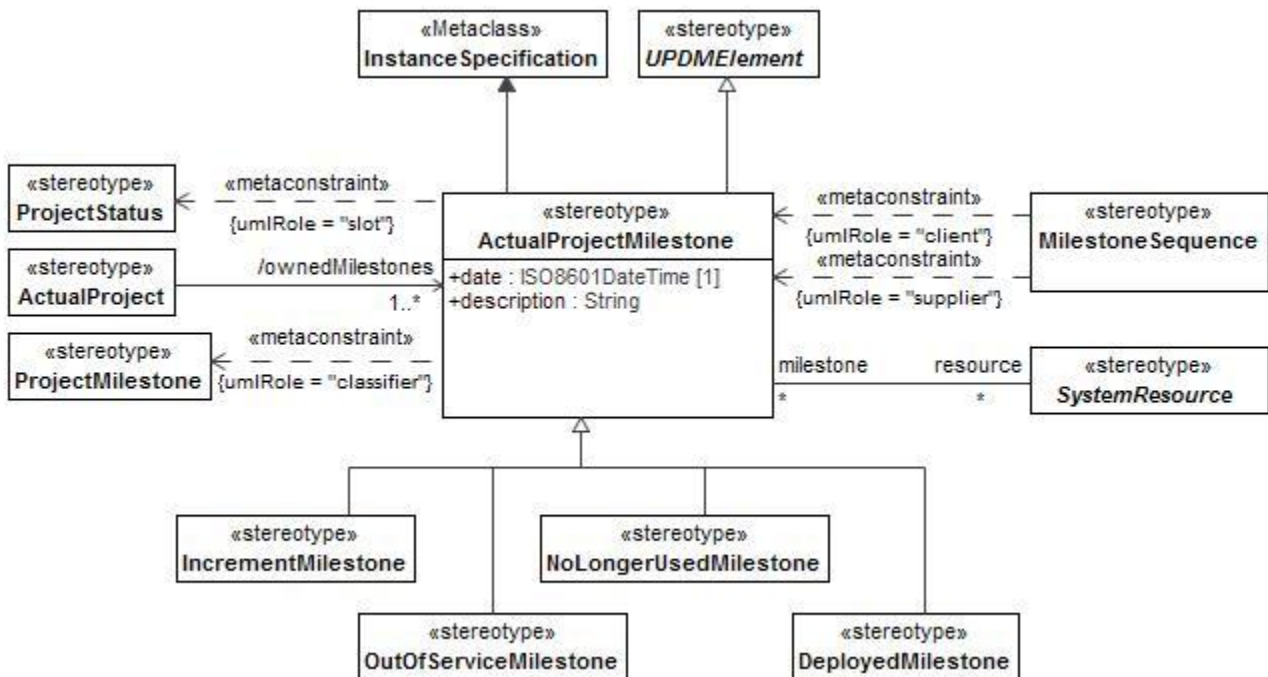

Figure 8:181 - ActualProjectMilestone

- **Constraints**

The following are constraints for ActualProjectMilestone:

- **ActualProjectMilestone.classifier** - Value for the classifier property must be stereotyped «ProjectMilestone» or its specializations.
- **ActualProjectMilestone.slot** - Slot values have to be stereotyped «ProjectStatus» or its specializations.

- **Attributes**

The following are attributes for ActualProjectMilestone:

- date: ISO8601DateTime[1] - Defines time for this ProjectMilestone.
- description: String[] - Description of the ActualProjectMilestone.
- resource: SystemResource[*] - Affected resource.

- **Extensions**

The following metaclasses are extended by ActualProjectMilestone:

- InstanceSpecification

- **Specializations**

The ActualProjectMilestone element is a specialization of:

- UPDMElement

8.2.1.3.1.1.2 IncrementMilestone

MODAF: (MODAF::CapabilityIncrement): An ActualProjectMilestone (MODAF::ProjectMilestone) that indicates the point in time at which a project is predicted to deliver or has delivered a Capability.
DoDAF: NA

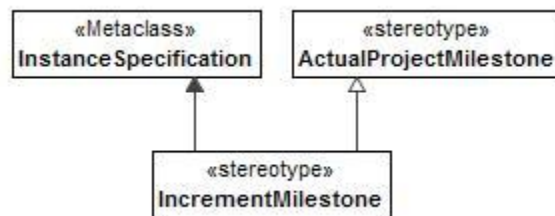

Figure 8:182 - IncrementMilestone

- **Extensions**

The following metaclasses are extended by IncrementMilestone:

- InstanceSpecification

- **Specializations**

The IncrementMilestone element is a specialization of:

- ActualProjectMilestone

8.2.1.3.1.1.3 MilestoneSequence

MODAF: A MilestoneSequence (MODAF::MilestoneRelationship) is a relationship between two milestones.
DoDAF: NA

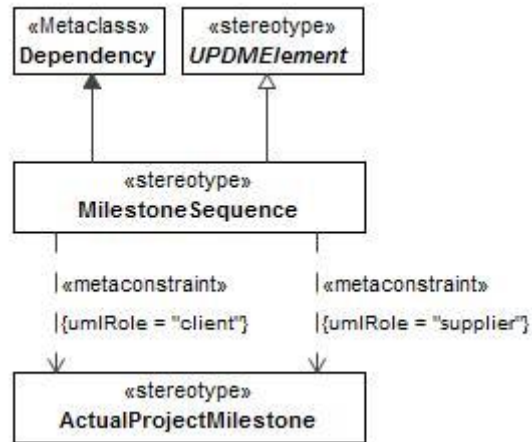

Figure 8:183 - MilestoneSequence

- **Constraints**

The following are constraints for MilestoneSequence:

- **MilestoneSequence.client** - Client must be **«ProjectMilestone»**.
- **MilestoneSequence.supplier** - Supplier must be **«ProjectMilestone»**.

- **Extensions**

The following metaclasses are extended by MilestoneSequence:

- Dependency

- **Specializations**

The MilestoneSequence element is a specialization of:

- UPDMElement

8.2.1.3.1.1.4 OutOfServiceMilestone

MODAF: An OutOfServiceMilestone (MODAF::OutOfService) is a ProjectMilestone that indicates a project's deliverable is to go out of service.

DoDAF: NA

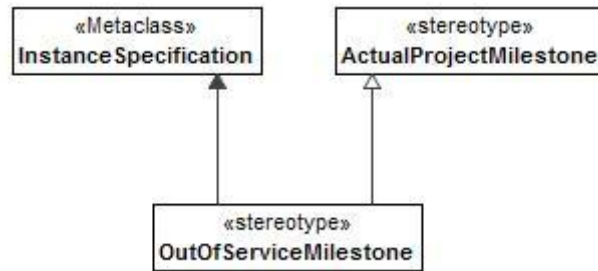

Figure 8:184 - OutOfServiceMilestone

- **Extensions**

The following metaclasses are extended by OutOfServiceMilestone:

- InstanceSpecification

- **Specializations**

The OutOfServiceMilestone element is a specialization of:

- ActualProjectMilestone

8.2.1.3.1.1.5 ProjectMilestone

UPDM: An element representing a collection of themes (e.g., DLOD or DOTMLPF) which is connected to a Project as part of a Project’s definition. This is used as a template for ActualProjectMilestones.

MODAF: An event in a Project by which progress is measured.

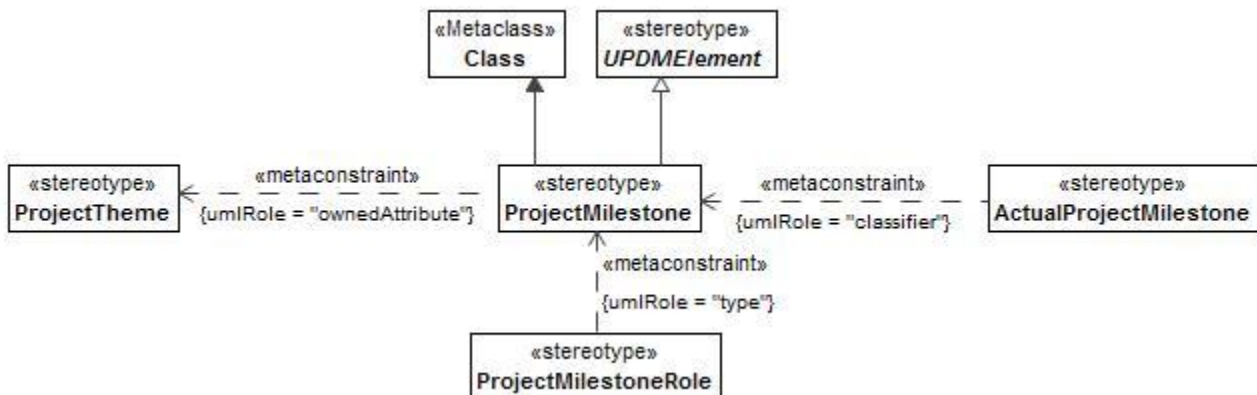

Figure 8:185 - ProjectMilestone

- **Constraints**

The following are constraints for ProjectMilestone:

- **ProjectMilestone.ownedAttributes** - Owned attributes have to be stereotyped <<ProjectTheme>>.
- **ProjectMilestone.ownedThemes** - All of the ProjectThemes, owned by a ProjectMilestone, must be typed by the same StatusIndicators.

- **Extensions**

The following metaclasses are extended by ProjectMilestone:

- Class

- **Specializations**

The ProjectMilestone element is a specialization of:

- UPDMElement

8.2.1.3.1.1.6 ProjectOwnership

MODAF: A type of OrganisationProjectRelationship where the organisation is the party responsible for the project.

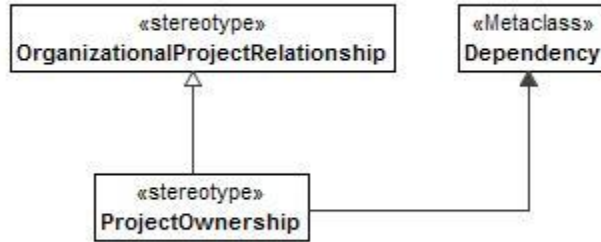

Figure 8:186 - ProjectOwnership

- **Extensions**

The following metaclasses are extended by ProjectOwnership:

- Dependency

- **Specializations**

The ProjectOwnership element is a specialization of:

- OrganizationalProjectRelationship

8.2.1.3.1.1.7 ProjectSequence

MODAF: Asserts that one ActualProject (MODAF::Project) follows from another - i.e., the target ActualProject cannot start until the source ActualProject has ended.

DoDAF: NA

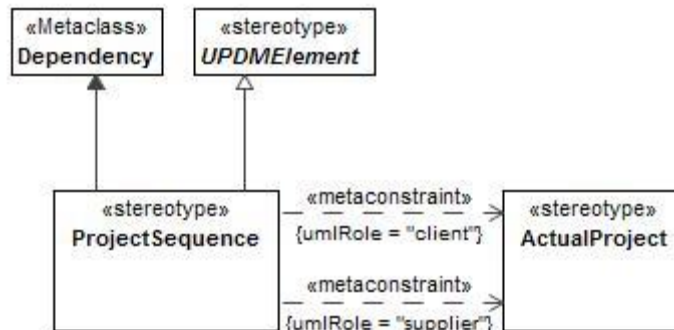

Figure 8:187 - ProjectSequence

- **Constraints**

The following are constraints for ProjectSequence:

- ProjectSequence.client - Client property value must be stereotyped «ActualProject» or its specializations.
- ProjectSequence.supplier - Supplier property value must be stereotyped «ActualProject» or its specializations.

- **Extensions**

The following metaclasses are extended by ProjectSequence:

- Dependency

- **Specializations**

The ProjectSequence element is a specialization of:

- UPDMElement

8.2.1.3.1.2 UPDM L1::UPDM L0::MODAF::AcquisitionElements::Structure

Structure for Acquisition View elements for MoDAF specific models.

8.2.1.3.1.2.1 ProjectStatus

MODAF: A ProjectStatus (MODAF::StatusAtMilestone) is a relationship between a Status and a milestone that asserts the status (i.e., level of progress) of a ProjectTheme for the project at the time of the ActualProjectMilestone (MODAF::Milestone).

DoDAF: NA

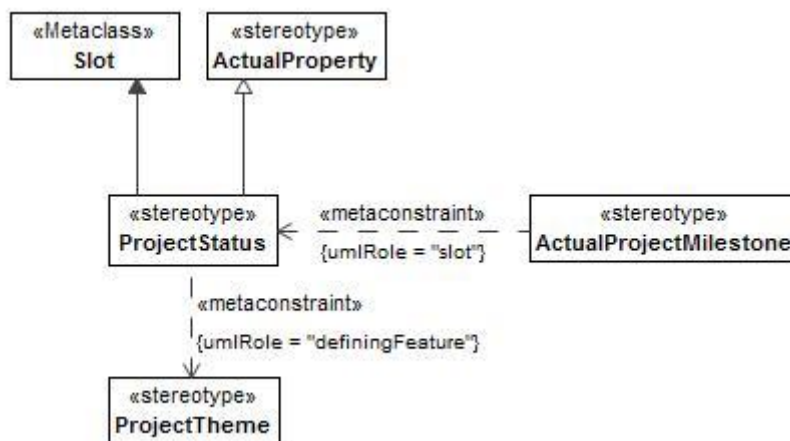

Figure 8:188 - ProjectStatus

- **Constraints**

The following are constraints for ProjectStatus:

- ProjectStatus.definingFeature - DefiningFeature value must be stereotyped «ProjectTheme» or its specializations.

- **Extensions**

The following metaclasses are extended by ProjectStatus:

- Slot

- **Specializations**

The ProjectStatus element is a specialization of:

- ActualProperty

8.2.1.3.1.2.2 ProjectTheme

MODAF: An aspect by which the progress of various Projects may be measured. In UK MOD, this could be one of the defence lines of development (DLOD), or DOTMLPF in the US.

DoDAF: NA

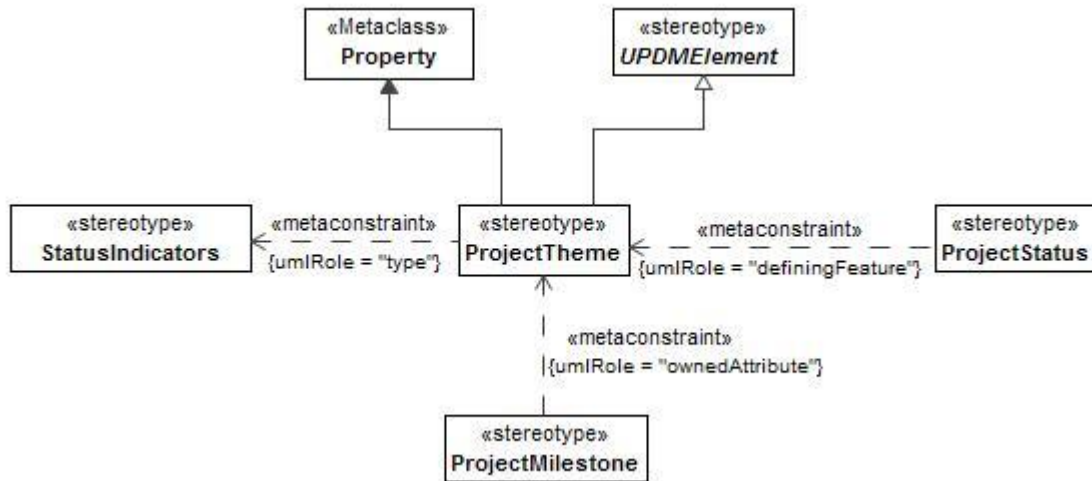

Figure 8:189 - ProjectTheme

- **Constraints**

The following are constraints for ProjectTheme:

- **ProjectTheme.type** - Value for the type property must be stereotyped «StatusIndicators» or its specializations.

- **Extensions**

The following metaclasses are extended by ProjectTheme:

- Property

- **Specializations**

The ProjectTheme element is a specialization of:

- UPDMElement

8.2.1.3.1.2.3 StatusIndicators

UPDM: Specifies a status for a ProjectTheme (such as training status).

MODAF: An enumeration of the possible statuses (MODAF::StatusIndicator) for one of more ProjectThemes.

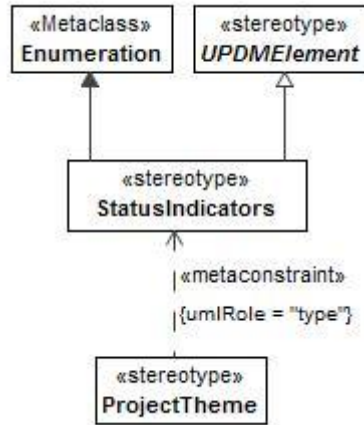

Figure 8:190 - StatusIndicators

- **Extensions**

The following metaclasses are extended by StatusIndicators:

- Enumeration

- **Specializations**

The StatusIndicators element is a specialization of:

- UPDMElement

8.2.1.3.2 UPDM L1::UPDM L0::MODAF::AllElements

The All View elements for MoDAF specific models.

8.2.1.3.2.1 UPDM L1::UPDM L0::MODAF::AllElements::Environment

This sub clause of the specification contains the Environment elements of the MODAF, All Elements sub clause.

8.2.1.3.2.1.1 Climate

MODAF: A type of weather condition, or combination of weather conditions (e.g. high temperature & dry).

DoDAF: NA

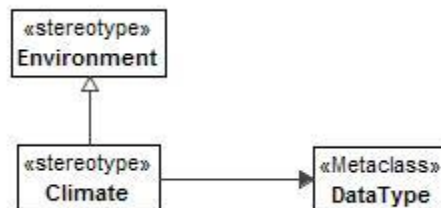

Figure 8:191 - Climate

- **Extensions**

The following metaclasses are extended by Climate:

- DataType

- **Specializations**

The Climate element is a specialization of:

- Environment

8.2.1.3.2.1.2 LightCondition

MODAF: a specification of environmental lighting conditions.

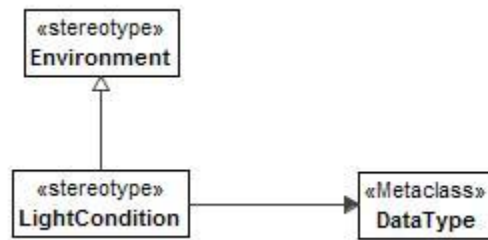

Figure 8:192 - LightCondition

- **Extensions**

The following metaclasses are extended by LightCondition:

- DataType

- **Specializations**

The LightCondition element is a specialization of:

- Environment

8.2.1.3.2.2 UPDM L1::UPDM L0::MODAF::AllElements::Ontology

Ontology elements from All Elements.

8.2.1.3.2.2.1 Alias

A UPDM Artifact used to define an alternative name for an element as used by DoDAF or MODAF.

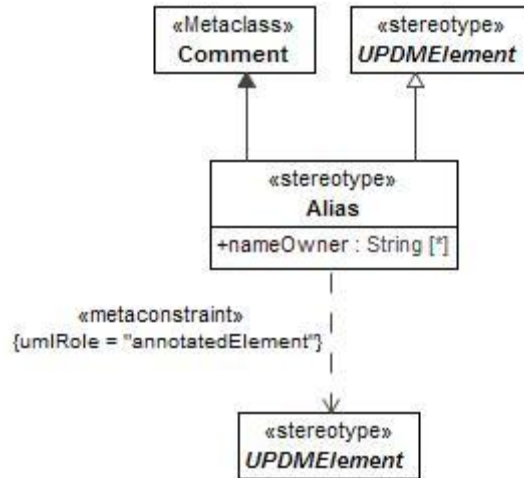

Figure 8:193 - Alias

- **Constraints**

The following are constraints for Alias:

- **Allias.annotatedElement** - Value for the annotatedElement property must be stereotyped <UPDMElement> or its specializations.

- **Attributes**

The following are attributes for Alias:

- nameOwner: String[*] - The person or organization that uses this alternative name.

- **Extensions**

The following metaclasses are extended by Alias:

- Comment

- **Specializations**

The Alias element is a specialization of:

- UPDMElement

8.2.1.3.2.2.2 Definition

MODAF: A definition of an element in the architecture.

DoDAF: NA

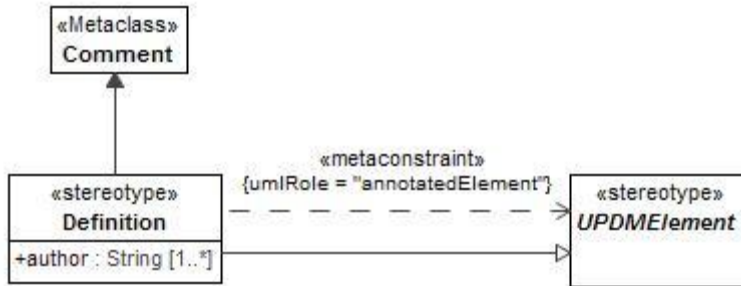

Figure 8:194 - Definition

- **Constraints**

The following are constraints for Definition:

- **Definition.annotatedElement** - Value for the annotatedElement property must be stereotyped «UPDMElement» or its specializations.

- **Attributes**

The following are attributes for Definition:

- author: String[1..*] - The original or current person (architect) responsible for the element.

- **Extensions**

The following metaclasses are extended by Definition:

- Comment

- **Specializations**

The Definition element is a specialization of:

- UPDMElement

8.2.1.3.2.2.3 ExternalIndividual

MODAF: An individual (i.e., something which has spatial and temporal extent) defined by an external ontology.

DoDAF: NA

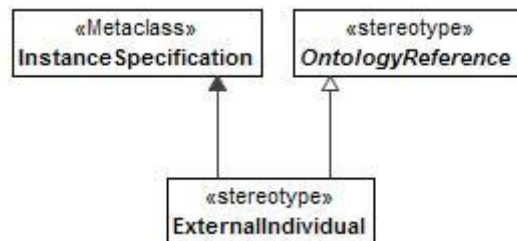

Figure 8:195 - ExternalIndividual

- **Extensions**

The following metaclasses are extended by ExternalIndividual:

- InstanceSpecification

- **Specializations**

The ExternalIndividual element is a specialization of:

- OntologyReference

8.2.1.3.2.2.4 ExternalTuple

UPDM: An instance of ExternalTupleType defined in an external Ontology.

MODAF: NA

DoDAF: NA

- **Extensions**

The following metaclasses are extended by ExternalTuple:

- Class

- **Specializations**

The ExternalTuple element is a specialization of:

- OntologyReference

8.2.1.3.2.2.5 ExternalTupleType

UPDM: A TupleType defined in an external Ontology.

MODAF: NA

DoDAF: NA

- **Extensions**

The following metaclasses are extended by ExternalTupleType:

- Class

- **Specializations**

The ExternalTupleType element is a specialization of:

- ExternalType

8.2.1.3.2.2.6 ExternalType

MODAF: A type defined by an external ontology.

DoDAF: NA

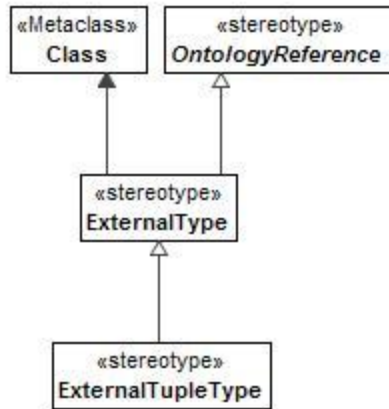

Figure 8:196 - ExternalType

- **Extensions**

The following metaclasses are extended by ExternalType:

- Class

- **Specializations**

The ExternalType element is a specialization of:

- OntologyReference

8.2.1.3.2.2.7 OntologyReference

MODAF: A reference to an element in a recognized external ontology or taxonomy.

DoDAF: NA

Note: OntologyReference is abstract.

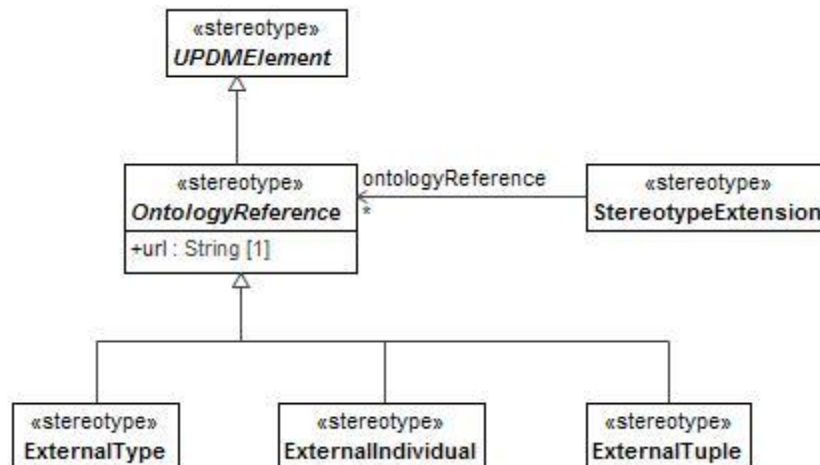

Figure 8:197 - OntologyReference

- **Attributes**

The following are attributes for OntologyReference:

- url: String[1] - Unique identifier for the element.

- **Specializations**

The OntologyReference element is a specialization of:

- UPDMElement

8.2.1.3.2.2.8 Overlap

IDEAS: A couple of wholePart couples where the part in each couple is the same.

- **Constraints**

The following are constraints for Overlap:

- **Overlap.client** - Values for the client property must be stereotyped «UPDMElement» or its specializations.
- **Overlap.supplier** - Values for the supplier property must be stereotyped «Element» or its specializations.

- **Extensions**

The following metaclasses are extended by Overlap:

- Dependency

- **Specializations**

The Overlap element is a specialization of:

- UPDMElement

8.2.1.3.2.2.9 SameAs

MODAF: Asserts that two elements refer to the same real-world thing.

DoDAF: NA

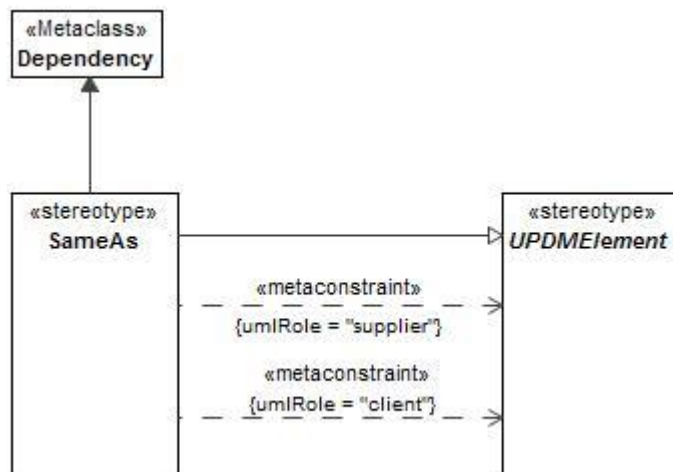

Figure 8:198 - SameAs

- **Constraints**

The following are constraints for SameAs:

- **SameAs.client** - Values for the client property must be stereotyped «UPDMElement» or its specializations.
- **SameAs.supplier** - Values for the supplier property must be stereotyped «Element» or its specializations.

- **Extensions**

The following metaclasses are extended by SameAs:

- Dependency

- **Specializations**

The SameAs element is a specialization of:

- UPDMElement

8.2.1.3.2.2.10 StereotypeExtension

MODAF: Defines an additional stereotype used in the architecture which is not defined in this meta-model. The body attribute contains the name of the new stereotype. The extendedStereotype tagged value shall contain the name of the meta-model stereotype which is extended. The ontologyReference tagged value shall be populated with a reference to the external ontology element represented by the new stereotype.
DoDAF: NA

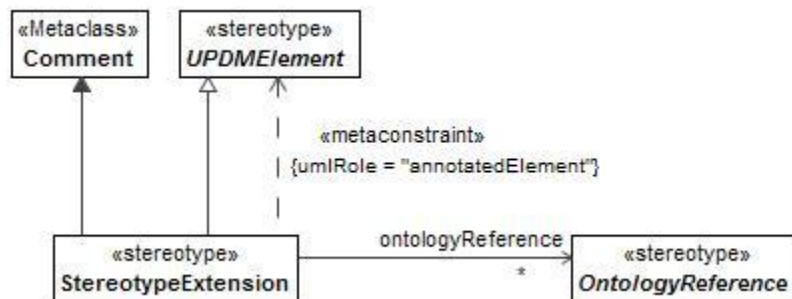

Figure 8:199 - StereotypeExtension

- **Constraints**

The following are constraints for StereotypeExtension:

- **StereotypeExtension.annotatedElement** - Values for the annotatedElement property must be stereotyped «UPDMElement» or its specializations.

- **Attributes**

The following are attributes for StereotypeExtension:

- ontologyReference: OntologyReference[*] - Ontologicalrefecence associated with an Stereotype extension.

- **Extensions**

The following metaclasses are extended by StereotypeExtension:

- Comment

- **Specializations**

The StereotypeExtension element is a specialization of:

- UPDMElement

8.2.1.3.3 UPDM L1::UPDM L0::MODAF::OperationalElements

The Operational View elements for MoDAF specific models.

8.2.1.3.3.1 UPDM L1::UPDM L0::MODAF::OperationalElements::Behavior

Behavior for Operational View elements for MoDAF specific models.

8.2.1.3.3.1.1 ActivitySubject

MODAF: Anything that is acted upon by an OperationalActivity

DoDAF: NA

Note: ActivitySubject is abstract.

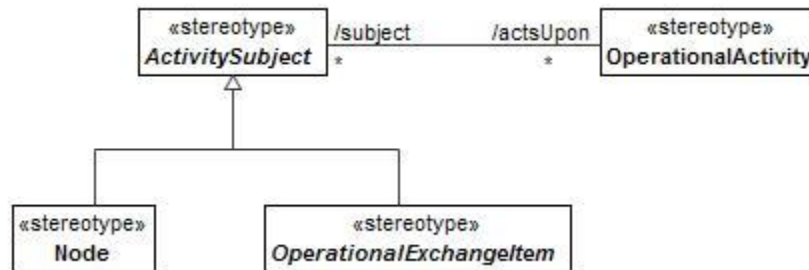

Figure 8:200 - ActivitySubject

- **Attributes**

The following are attributes for ActivitySubject:

- actsUpon: OperationalActivity[*] - OperationalActivities that this ActivitySubject is acting upon.

- **Specializations**

The ActivitySubject element is a specialization of:

- UPDMElement

8.2.1.3.3.1.2 OwnsProcess

UPDM: Asserts that an ActualOrganizationalResource owns a Process.

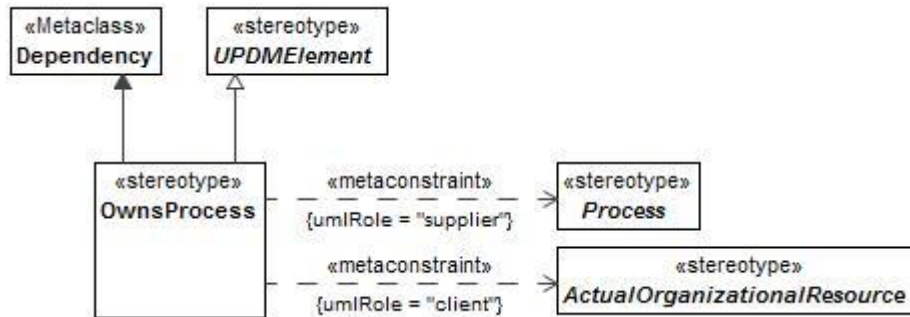

Figure 8:201 - OwnsProcess

- **Constraints**

The following are constraints for OwnsProcess:

- OwnsProcess.client - Value for the client property must be stereotyped «ActualOrganizationalResource» or its specializations.
- OwnsProcess.supplier - Value for the supplier property must be stereotyped a specialization of «Process».

- **Extensions**

The following metaclasses are extended by OwnsProcess:

- Dependency

- **Specializations**

The OwnsProcess element is a specialization of:

- UPDMElement

8.2.1.3.3.1.3 Process

MODAF: The abstract supertype of OperationalActivity and EnduringTask.

DoDAF: NA

Note: Process is abstract.

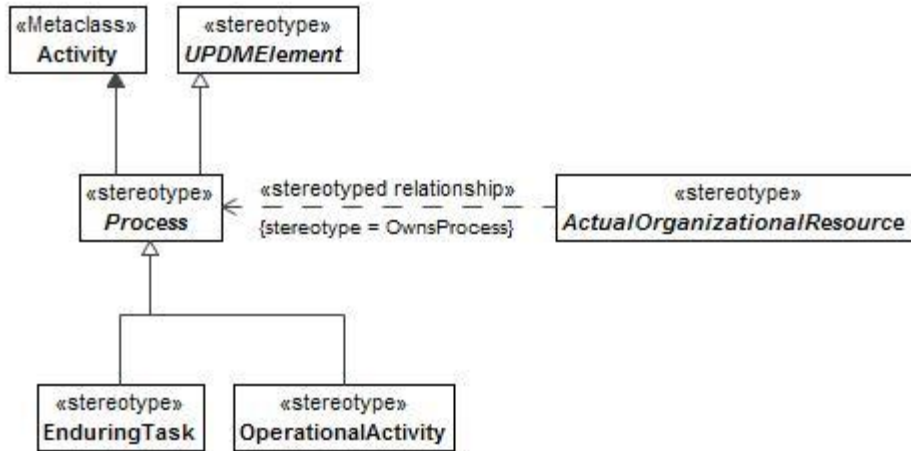

Figure 8:202 - Process

- **Extensions**

The following metaclasses are extended by Process:

- Activity

- **Specializations**

The Process element is a specialization of:

- UPDMElement

8.2.1.3.3.1.4 StandardOperationalActivity

MODAF: An OperationalActivity that is a standard procedure that is doctrinal. Note: This is equivalent to what some defense organizations call JETLs.

DoDAF: Work, not specific to a single organization, weapon system or individual, that transforms inputs into outputs or changes their state (DoDAF:: Activity).

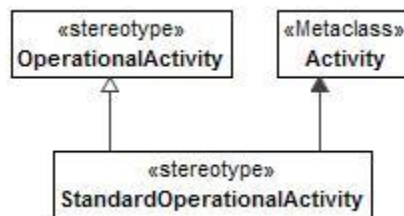

Figure 8:203 - StandardOperationalActivity

- **Extensions**

The following metaclasses are extended by StandardOperationalActivity:

- Activity

- **Specializations**

The StandardOperationalActivity element is a specialization of:

- OperationalActivity

8.2.1.3.3.2 UPDM L1::UPDM L0::MODAF::OperationalElements::Flows

Flows for Operational View elements for MoDAF specific models.

8.2.1.3.3.2.1 Control

MODAF: A type of ResourceInteraction where one Resource (source) controls another (target). --Examples - the driver of a tank, one organisation having operational control of another, a fire control system controlling a weapons system.

DoDAF: NA

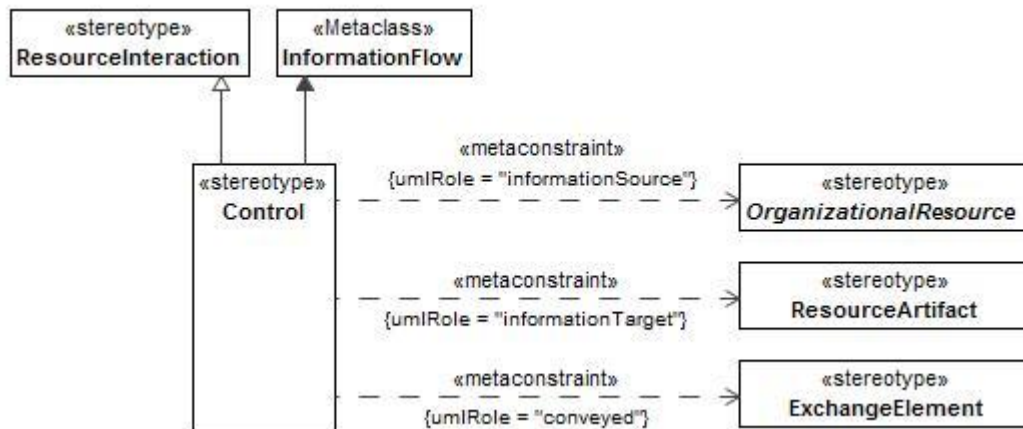

Figure 8:204 - Control

- **Constraints**

The following are constraints for Control:

- **Control.conveyed** - Value for the conveyed property must be stereotyped **«ExchangeElement»** or its specializations.
- **Control.informationSource** - Value for the informationSource property must be stereotyped **«OrganizationalResource»** or its specializations.
- **Control.informationTarget** - Value for the informationTarget property must be stereotyped **«ResourceArtifact»** or its specializations.

- **Extensions**

The following metaclasses are extended by Control:

- InformationFlow

- **Specializations**

The Control element is a specialization of:

- ResourceInteraction

8.2.1.3.3.3 UPDM L1::UPDM L0::MODAF::OperationalElements::Structure

Structure for Operational View elements for MoDAF specific models.

8.2.1.3.3.3.1 Energy

UPDM: Energy to be exchanged between Nodes.

MODAF: A unit of energy that flows along an EnergyFlow or OperationalActivityEnergyFlow

DoDAF: NA

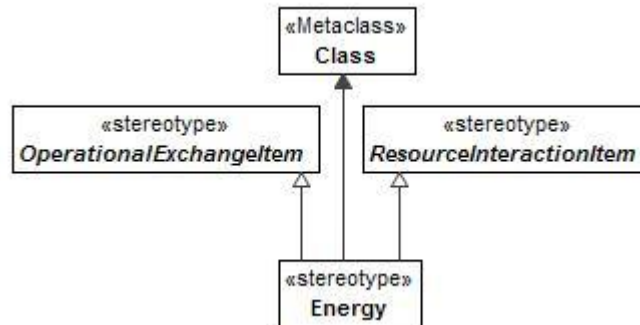

Figure 8:205 - Energy

- **Extensions**

The following metaclasses are extended by Energy:

- Class

- **Specializations**

The Energy element is a specialization of:

- ResourceInteractionItem
- OperationalExchangeItem

8.2.1.3.3.3.2 ProblemDomain

MODAF: The boundary containing those Nodes which may be realized by functional resources specified in SV-1. There may be more than one alternative solution for a given ProblemDomain specified as a set of SV suites. There may be only one ProblemDomain in a LogicalArchitecture.

DoDAF: NA – covered by the more general temporalWholePart element.

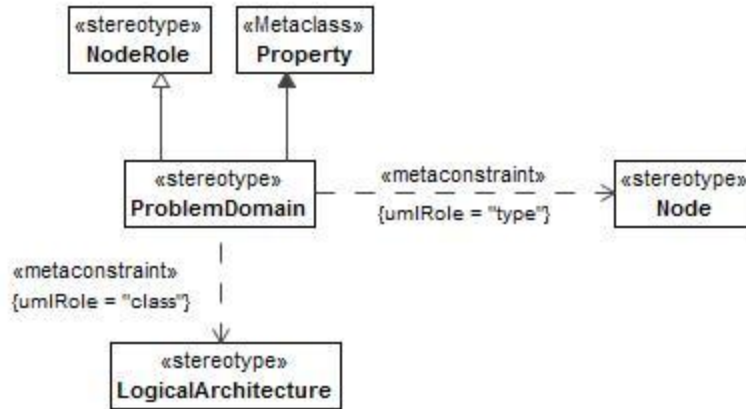

Figure 8:206 - ProblemDomain

- **Constraints**

The following are constraints for ProblemDomain:

- **ProblemDomain.class** - Value for the class property must be stereotyped «LogicalArchitecture» or its specializations.
- **ProblemDomain.type** - Value for the type property must be stereotyped «Node» or its specializations.

- **Extensions**

The following metaclasses are extended by ProblemDomain:

- Property

- **Specializations**

The ProblemDomain element is a specialization of:

- NodeRole

8.2.1.3.3.3 Trustline

MODAF: Asserts that the trustingParty (either a Node or a KnownResource) trusts the trustedParty to a given level (indicated by the level attribute). Note: No unit of measure is associated with the level - security architects must define their own scale of trust levels for a given architecture or set of architectures.

DoDAF: NA

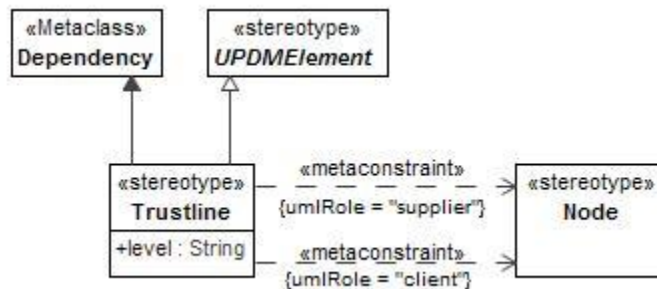

Figure 8:207 - Trustline

- **Constraints**

The following are constraints for Trustline:

- **Trustline.client** - Values for the client property must be stereotyped «Node» or its specializations.
- **Trustline.supplier** - Values for the supplier property must be stereotyped «Node» or its specializations.

- **Attributes**

The following are attributes for Trustline:

- level: String[] - String denoting the level of Trust in the information source.

- **Extensions**

The following metaclasses are extended by Trustline:

- Dependency

- **Specializations**

The Trustline element is a specialization of:

- UPDMElement

8.2.1.3.3.3.4 UPDM L1::UPDM

L0::MODAF::OperationalElements::Structure::Organizational

This sub clause of the specification contains the organizational Elements of the MODAF, Operational Elements sub clause.

8.2.1.3.3.3.4.1 RoleType

MODAF: An aspect of a person or organization that enables them to fulfill a particular function.



Figure 8:208 - RoleType

- **Extensions**

The following metaclasses are extended by RoleType:

- Class

- **Specializations**

The RoleType element is a specialization of:

- Responsibility

8.2.1.3.4 UPDM L1::UPDM L0::MODAF::StrategicElements

The Strategic View elements for MoDAF specific models.

8.2.1.3.4.1 UPDM L1::UPDM L0::MODAF::StrategicElements::Milestones

Milestone elements for Strategic View elements for MoDAF specific models.

8.2.1.3.4.1.1 DeployedMilestone

MODAF: Asserts that an ActualOrganizationResource started to use, or is slated to start using a CapabilityConfiguration from a specific point in time. --This is used to describe capabilities going into service with specific organizations or posts.

DoDAF: NA

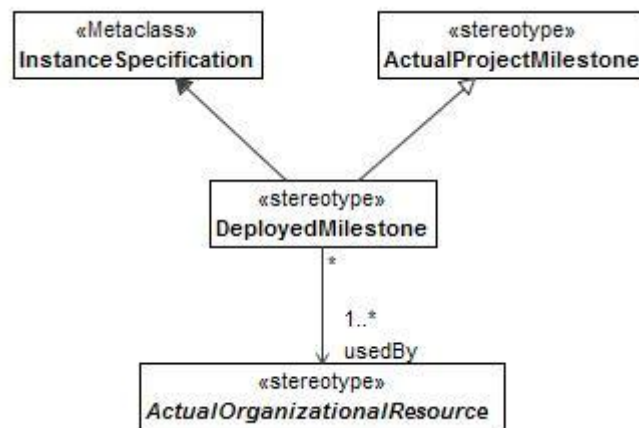

Figure 8:209 - DeployedMilestone

- **Attributes**

The following are attributes for DeployedMilestone:

- usedBy: ActualOrganizationalResource[1..*] - ActualOrganizationalResources using CapabilityConfiguration deployed at this Milestone.

- **Extensions**

The following metaclasses are extended by DeployedMilestone:

- InstanceSpecification

- **Specializations**

The DeployedMilestone element is a specialization of:

- ActualProjectMilestone

8.2.1.3.4.1.2 NoLongerUsedMilestone

MODAF: Asserts that an ActualOrganizationResource ceased to use or is slated to cease using a CapabilityConfiguration from a specific point in time. --This is used to describe capabilities going out of service

with specific organizations or posts.
DoDAF: NA

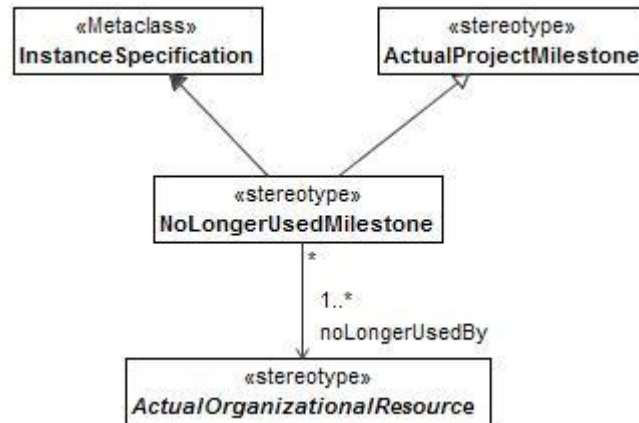

Figure 8:210 - NoLongerUsedMilestone

- **Attributes**

The following are attributes for NoLongerUsedMilestone:

- noLongerUsedBy: ActualOrganizationalResource[1..*] - ActualOrganizationalResources that are no longer using CapabilityConfiguration that went out of service at this Milestone.

- **Extensions**

The following metaclasses are extended by NoLongerUsedMilestone:

- InstanceSpecification

- **Specializations**

The NoLongerUsedMilestone element is a specialization of:

- ActualProjectMilestone

8.2.1.3.4.2 UPDM L1::UPDM L0::MODAF::StrategicElements::Structure

Structure elements for Strategic View elements for MoDAF specific models.

8.2.1.3.4.2.1 EnduringTask

MODAF: A type of behaviour recognized by an enterprise as being essential to achieving its goals - i.e., a strategic specification of what the enterprise does.

DoDAF: NA

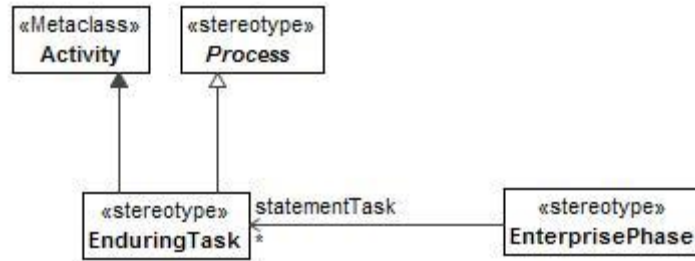

Figure 8:211 - EnduringTask

- **Extensions**

The following metaclasses are extended by EnduringTask:

- Activity

- **Specializations**

The EnduringTask element is a specialization of:

- Process

8.2.1.3.4.2.2 WholeLifeEnterprise

UPDM: A WholeLifeEnterprise is a purposeful endeavor of any size involving people, organizations, and supporting systems (including physical systems and/or processes).

MODAF: An EnterprisePhase that represents the whole existence of an enterprise.

DoDAF: NA

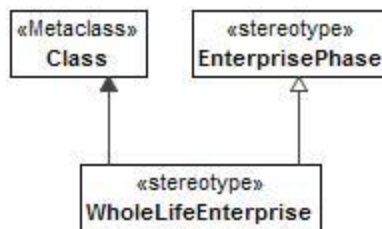

Figure 8:212 - WholeLifeEnterprise

- **Extensions**

The following metaclasses are extended by WholeLifeEnterprise:

- Class

- **Specializations**

The WholeLifeEnterprise element is a specialization of:

- EnterprisePhase

8.2.1.3.5 UPDM L1::UPDM L0::MODAF::TechnicalStandardsElements

This sub clause of the specification contains the Technical Standard Elements of the MODAF sub clause.

8.2.1.3.5.1 ProtocolLayer

MODAF: Asserts that a Protocol (upperLayer) uses another Protocol (lowerLayer)

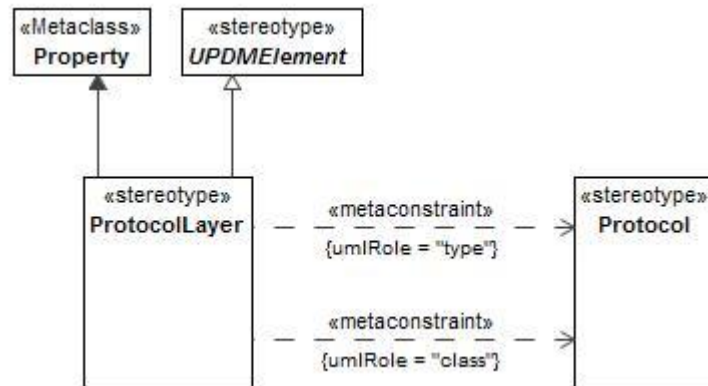

Figure 8:213 - ProtocolLayer

- **Constraints**

The following are constraints for ProtocolLayer:

- **ProtocolLayer.class** - Value for the class property must be stereotyped `<<Protocol>>` or its specializations.
- **ProtocolLayer.type** - Value for the type property must be stereotyped `<<Protocol>>` or its specializations.

- **Extensions**

The following metaclasses are extended by ProtocolLayer:

- Property

- **Specializations**

The ProtocolLayer element is a specialization of:

- UPDMElement

8.2.1.4 UPDM L1::UPDM L0::SOPES

The SOPES profile comprises a the core elements of the Shared Operational Picture Exchange Services (SOPES) Information Exchange Data Model (IEDM) modeling profile described in Annex A of the OMG SOPES IEDM Specification. The modeling profile seeks to use UML to expressing the policies, rules, and constraints governing the release and exchange of information between information systems. The UML models provide a means to express these exchange policies in a manner that can be encoded as a set of human and machine readable policies that can be enforced by software applications and services.

The goal for adding SOPES to the UPDM is to provide greater fidelity for architecture modeling of information exchange requirements within the DoDAF, MODAF and NAF.

Additional elements in the SOPES modeling profiles can be accomplished using standard UML Class diagram constructs and not specifically integrated into the UPDM Specification.

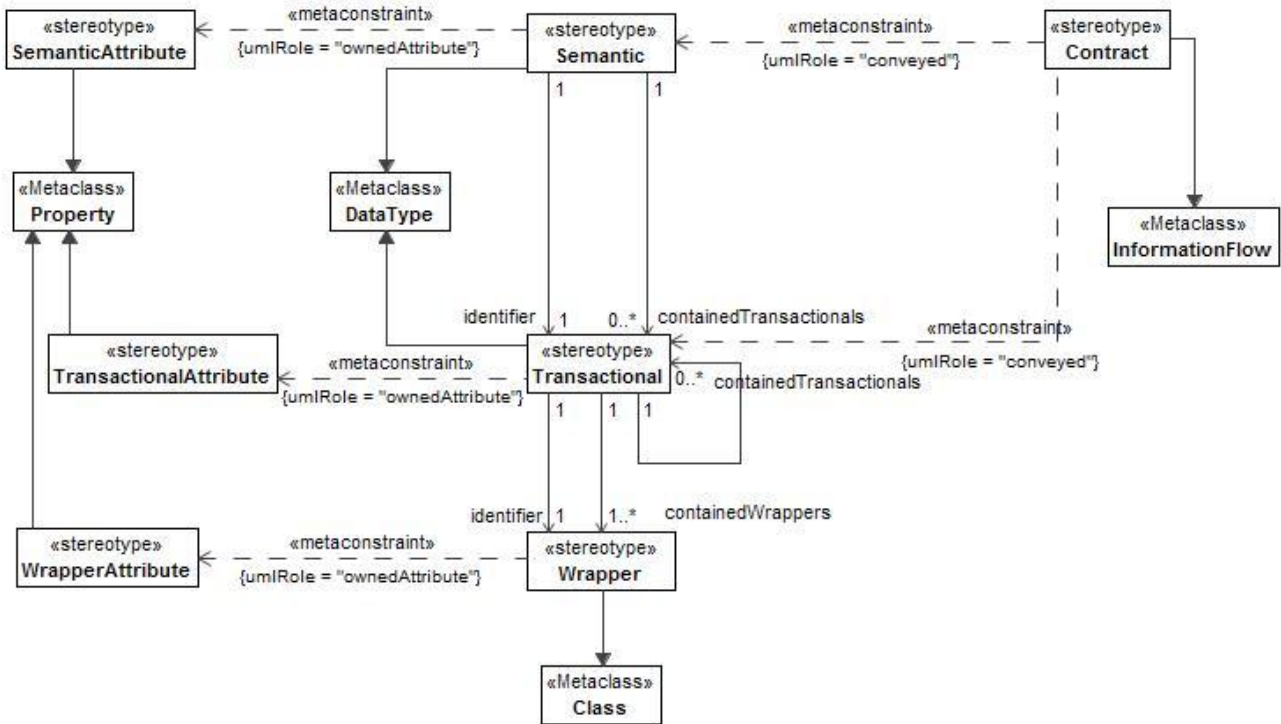

Figure 8:214 - SOPES Elements

The SOPES Elements diagram shows the UPDM elements and the relationships that map to the concepts of the SOPES Metamodel.

8.2.1.4.1 Contract

A specialization of an “OperationalExchange” a “Contract” specifies an agreement between two or more parties to exchange information. The Contract forms an ontological commitment between parties in a community of interest (CoI) or Community of Practice (CoP). The contract is also used to realize the information exchange requirements of either a needline or a community of interest.

- **Constraints**

The following are constraints for Contract:

- **Contract.conveyed** - conveyed property value must be stereotyped **«Semantic»**, **«Transactional»** or their specializations.

- **Extensions**

The following metaclasses are extended by Contract:

- InformationFlow

8.2.1.4.2 Semantic

A specialization of “InformationElement” that enables the specification of a complete dataset, which is considered meaningful to a community, organization, system, or application; meeting one or more of the information flow requirements specification for a needline. The semantic is defined by the community, needline, or application interface.

- **Constraints**

The following are constraints for Semantic:

- **Semantic.ownedAttribute** - ownedAttribute property value must be stereotyped «SemanticAttribute» or its specializations.

- **Attributes**

The following are attributes for Semantic:

- containedTransactionals: Transactional[0..*] - Represents the relationship between a "Transactional" and its containing "Semantic." Meaning that during aggregation process of data represented by the "Transactional" is gathered into the containing "Semantic." When all the data represented by the "Transactionals" is gathered - the data set is complete and ready for formatting and exchange.
- identifier: Transactional[1] - The "identifier" identifies the subtended Class that holds Unique Identifier or Key needed for the construction of the data set. This subtended class would contain, as a minimum, the base Global Unique Identifier (e.g., Database Key, foreign keys or unique identifier) that would differentiate which transactional or wrappers (information element instances) are included in the construction of the composite. (e.g., foreign key relationships) There exists one and only one "identifier" on each semantic or transactional diagram.

- **Extensions**

The following metaclasses are extended by Semantic:

- DataType

8.2.1.4.3 SemanticAttribute

Specialization of Entity Attribute that enables the relationship between logical/Interim-Processing and Operational/Business naming conventions.

- **Extensions**

The following metaclasses are extended by SemanticAttribute:

- Property

8.2.1.4.4 Transactional

A specialization of "InformationElement" the enables the specification of reusable information building blocks, upon which multiple community semantics can be built. Transactionals describe the constructions plans for data sets realizable from the underlying information/data store. The transactional links the community semantics to the structures and business rules information/data store.

- **Constraints**

The following are constraints for Transactional:

- **Transactional.ownedAttribute** - ownedAttribute property value must be stereotyped «TransactionalAttribute» or its specializations.

- **Attributes**

The following are attributes for Transactional:

- containedTransactionals: Transactional[0..*] - Represents the relationship between a "Transactional" and its containing "Transactional". Meaning that during the data aggregation process of data represented by the "Transactional" is gathered into the containing "Transactional."
- containedWrappers: Wrapper[1..*] - Represents the relationship between a "Wrapper" and its containing "Transactional." Meaning that during the data aggregation process of data represented by the "Wrapper" is gathered into the containing "Transactional."
- identifier: Wrapper[1] - The “identifier” identifies the subtended Class that holds Unique Identifier or Key needed for the construction of the data set. This subtended class would contain, as a minimum, the base Global Unique Identifier (e.g., Database Key, foreign keys, or unique identifier) that would differentiate which transactional or wrappers (information element instances) are included in the construction of the composite (e.g., foreign key relationships). There exists one and only one “identifier” on each semantic or transactional diagram.

- **Extensions**

The following metaclasses are extended by Transactional:

- DataType

8.2.1.4.5 TransactionalAttribute

Specialization of Entity Attribute that enables the relationship between logical and Interim processing Attribute naming conventions.

- **Extensions**

The following metaclasses are extended by TransactionalAttribute:

- Property

8.2.1.4.6 Wrapper

A specialization of “EntityItem” that links a Transactional to the logical information/data model Elements (e.g., DB Table). Wrappers represent a single instance of “EntityItem” data.

- **Constraints**

The following are constraints for Wrapper:

- **Wrapper.ownedAttribute - ownedAttribute property value must be stereotyped <WrapperAttribute> or its specializations.**

- **Extensions**

The following metaclasses are extended by Wrapper:

- Class

8.2.1.4.7 WrapperAttribute

Specialization of Entity Attribute that enables the relationship between physical and logical attribute naming conventions.

- **Extensions**

The following metaclasses are extended by WrapperAttribute:

- Property

8.2.1.5 UPDM L1::UPDM L0::SwAF

The SWAF section defines the design rules being used by the Swedish Armed Forces and NATO that aid in the development and implementation of information Integration.

The design rule describes how military organizations can develop and implement the ability to exchange information with each other to support interoperability issues. Much of this design rule can also be applied when exchanging information with other actors than military organizations.

Definition of interoperability in this context: The ability of technical systems and/or organizations using technical systems to operate together by making (necessary) data & information and/or services produced by one system or organization available to the others, in an agreed format.

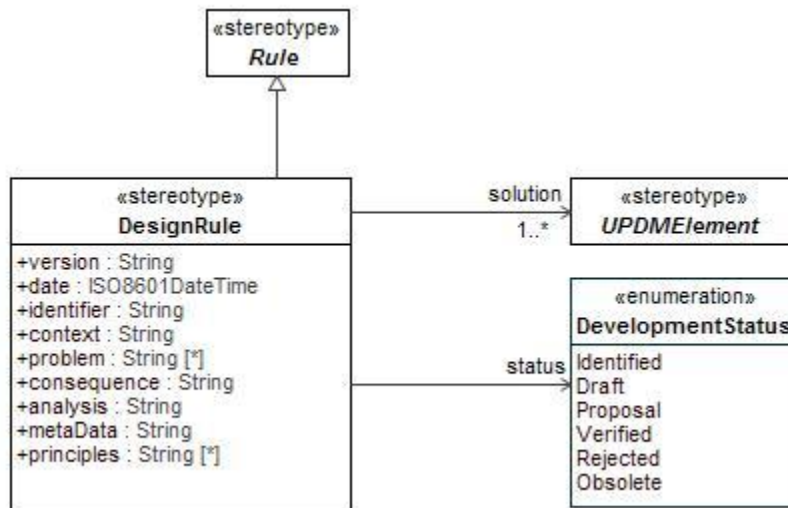

Figure 8:215 - Design Rule Elements

The Design Rule Elements diagram shows the UPDM elements and the relationships that map to the concepts of the Design Rules metamodel from NISP as submitted by Swedish Armed Forces (SWAF).

8.2.1.5.1 DesignRule

A design rule is a solution to a problem in a specific context with the following characteristics:

- belongs to a problem domain,
- packages knowledge in a reusable form,
- standardize solutions to design problems within NBD,
- gives value to the re-user.

- **Constraints**

The following are constraints for DesignRule:

- **DesignRule.ruleKind** - Guidance

- **Attributes**

The following are attributes for DesignRule:

- analysis : String[] -
- consequence : String[] -
- context : String[] -

- date : ISO8601DateTime[] -
- identifier : String[] -
- metaData : String[] -
- principles : String[*] -
- problem : String[*] -
- solution : UPDMElement[1..*] -
- status : DevelopmentStatus[] -
- version : String[] -

- **Extensions**

The following metaclasses are extended by DesignRule:

- Constraint

- **Specializations**

The DesignRule element is a specialization of:

- Rule

8.2.1.5.2 DevelopmentStatus

Enumeration of development statuses, used to support the status tag of the DesignRule stereotype.

- **Enumeration Literals**

The following are enumeration literals for DevelopmentStatus:

- Draft - Indicates that the development of the design rule is in Draft state.
- Identified - Indicates that the development of the design rule is in Identified state.
- Obsolete - Indicates that the development of the design rule is in Obsolete state.
- Proposal - Indicates that the development of the design rule is in Proposal state.
- Rejected - Indicates that the development of the design rule is in Rejected state.
- Verified - Indicates that the development of the design rule is in Verified state.

Annex A Domain Metamodel (DMM)

This Annex is comprised of various diagrams that document the Domain Metamodel (DMM) that document the MoDAF 1.5 and MoDAF 1.2 integrated model. This model was used as a basis for creating the UPDM profile.

Note that the diagrams rely on color to aid the reader in understanding the model. Please refer to the legend in the various diagrams to understand the specific definitions.

A.1 Products

This sub clause documents each of the products of the DMM.

A.1.1 AcV/PV

The AcquisitionElements describe project details, including dependencies between projects and capability integration. These Views guide the acquisition and fielding processes.

A.1.1.1 AcV-1/PV-1 - DMM

MODAF: AcV-1 view products represent an organizational perspective on projects.

DoDAF: AcV-1 view [DoDAF::Project Portfolio Relationships (PV-1) DoDAF-described View] represents an organizational perspective on programs, projects, or a portfolio of projects.

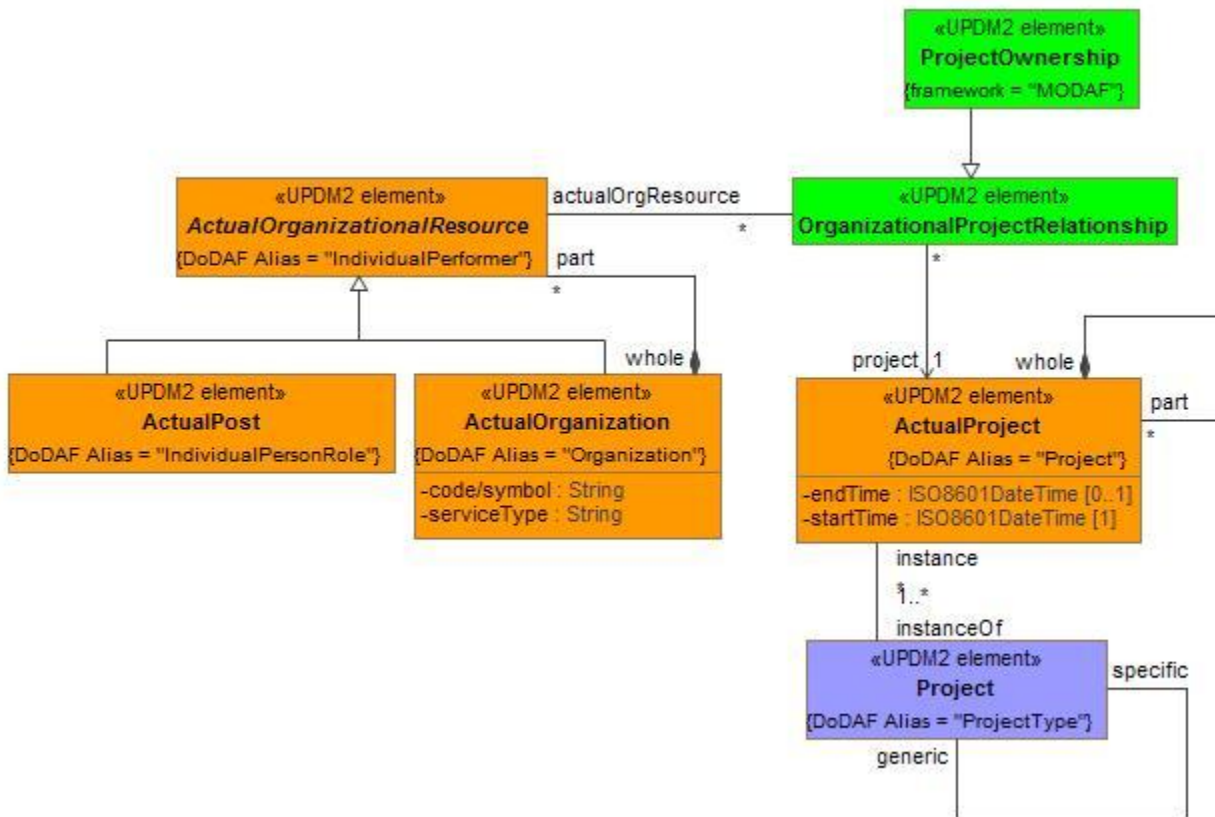

Figure A:1 - AcV-1/PV-1 - DMM

A.1.1.2 AcV-2/PV-2 - DMM

MODAF: AcV-2 view products provide a timeline perspective on projects.

DoDAF: AcV-2 (DoDAF::PV-2: Project Timelines DoDAF-described View) provides a timeline perspective on programs or projects.

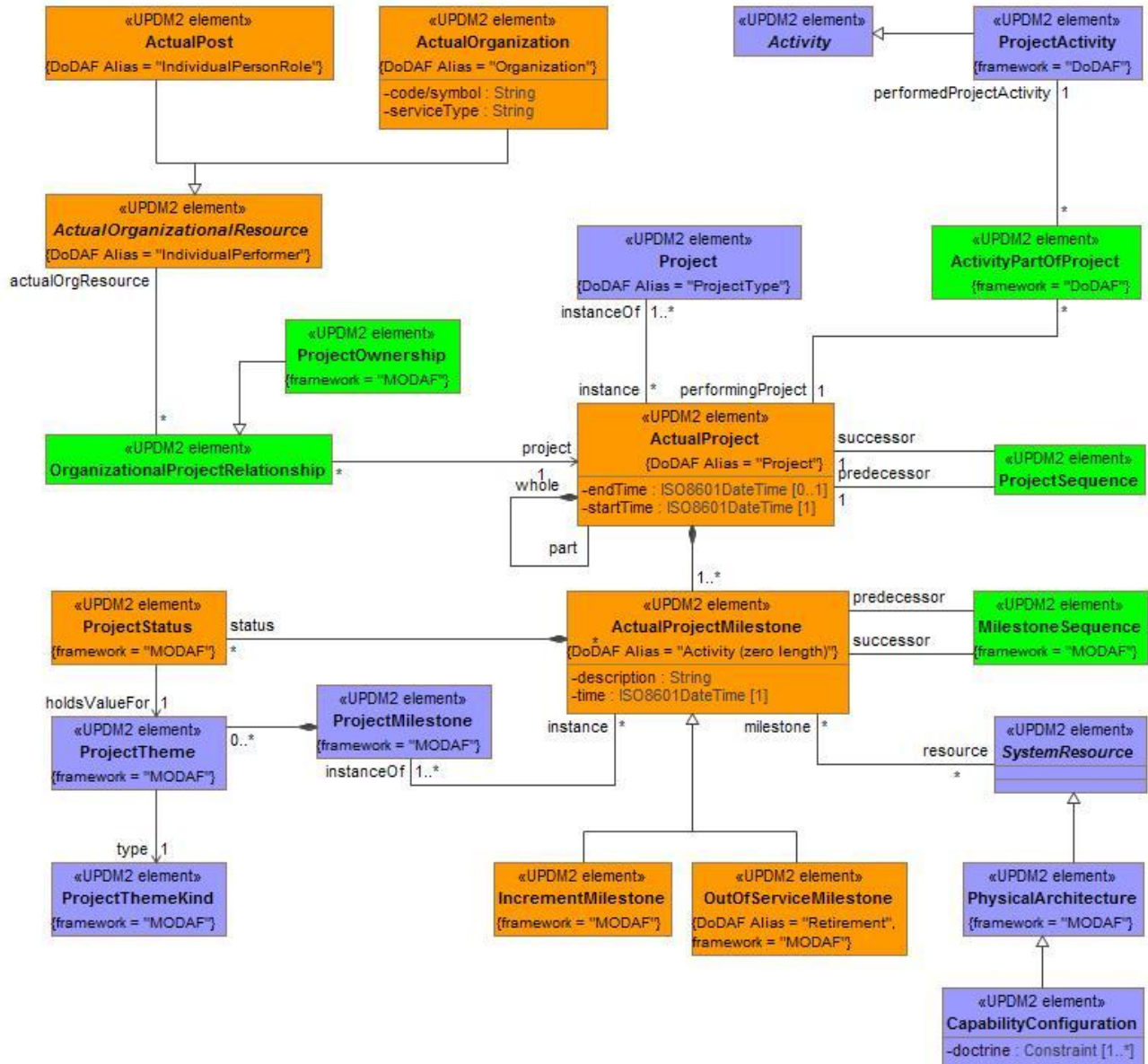

Figure A:2 - AcV-2/PV-2 - DMM

A.1.1.3 PV-3 - DMM

MODAF: NA

DoDAF: PV-3 diagram indicates the Capabilities that are realized by a particular project.

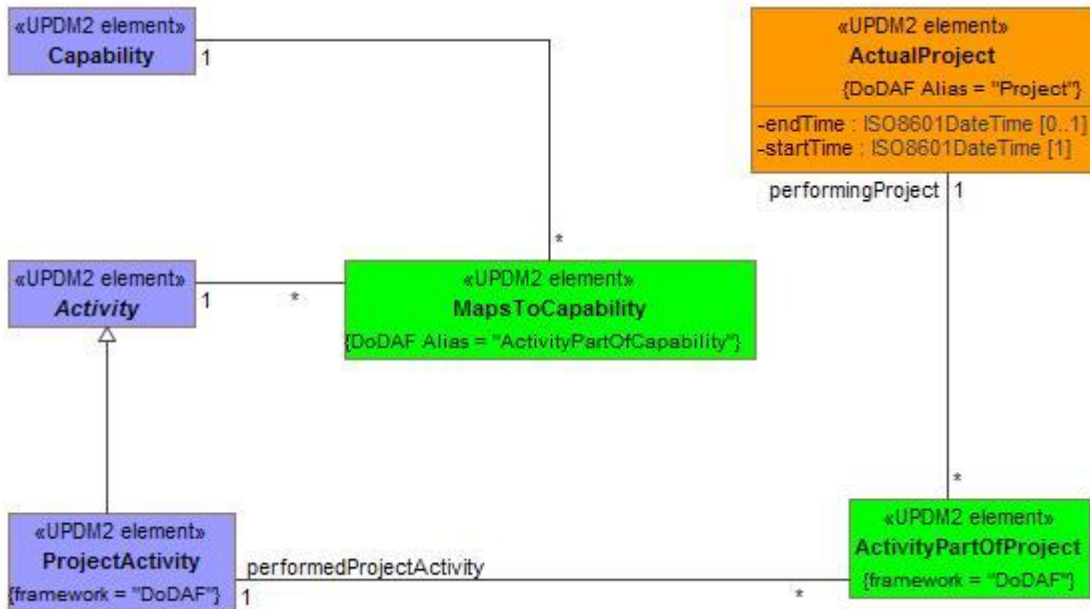

Figure A:3 - PV-3 - DMM

A.1.2 AV

Elements that are part of the All View: The All-Views (AVs) provide an overarching description of the architecture, its scope, ownership, timeframe, and all of the other meta data that is required in order to effectively search and query architectural models. They also provide a place to record any findings arising from the architecting process. The AVs include a dictionary of the terms used in the construction of the architecture – which helps others fully understand its meaning at a later date. Since the AVs provide critical information for the future access and exploitation of an architectural model their population is essential whenever an architecture is created or modified. The AVs provide a critical input into the processes that provide architectural governance.

A.1.2.1 AV-1 - DMM

MODAF: The overview and summary information contained within the AV-1 product provides executive-level summary information in a consistent form that allows quick reference and comparison between architectural descriptions. AV-1 includes assumptions, constraints, and limitations that may affect high-level decisions relating to an architecture-based work programme.

DoDAF: The overview and summary information contained within the AV-1 DoDAF-described View provides executive-level summary information in a consistent form that allows quick reference and comparison between architectural descriptions. The AV-1 includes assumptions, constraints, and limitations that may affect high-level decisions relating to an architecture-based work program.

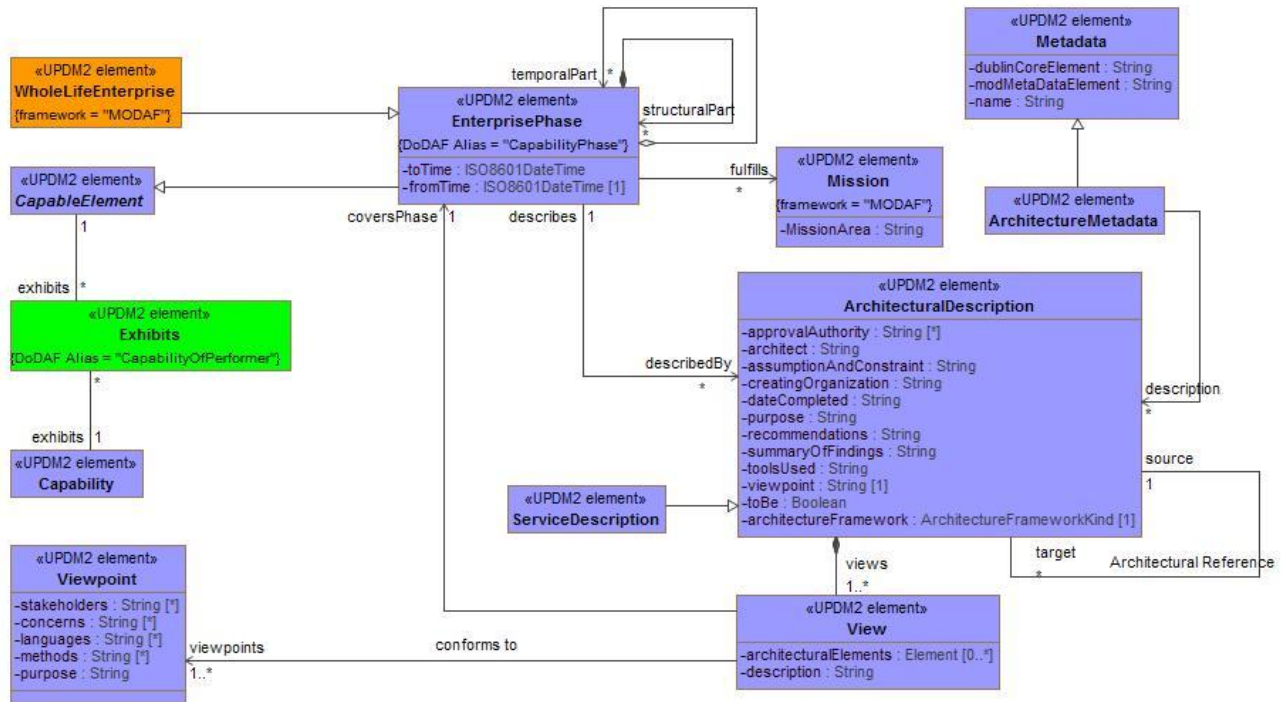

Figure A:4 - AV-1 - DMM

A.1.2.2 AV-2 - DMM

MODAF: AV-2 presents all the Elements used in an architecture as a stand alone structure. An AV-2 presents all the Elements as a specialization hierarchy, provides a text definition for each one and references the source of the element (e.g., MODAF Ontology, IDEAS Model, local, etc.). An AV-2 shows elements from the MODAF Ontology that have been used in the architecture and new elements (i.e., not in the MODAF Ontology) that have been introduced by the architecture.

DoDAF: The AV-2 presents all the metadata used in an architecture as a standalone structure. An AV-2 presents all the metadata as a specialization hierarchy, provides a text definition for each one and references the source of the element (e.g., DoDAF Meta-model, IDEAS, a published document or policy). An AV-2 shows elements from the DoDAF Meta-model that have been used in the architecture and new elements (i.e., not in the DoDAF Meta-model) that have been introduced by the architecture.

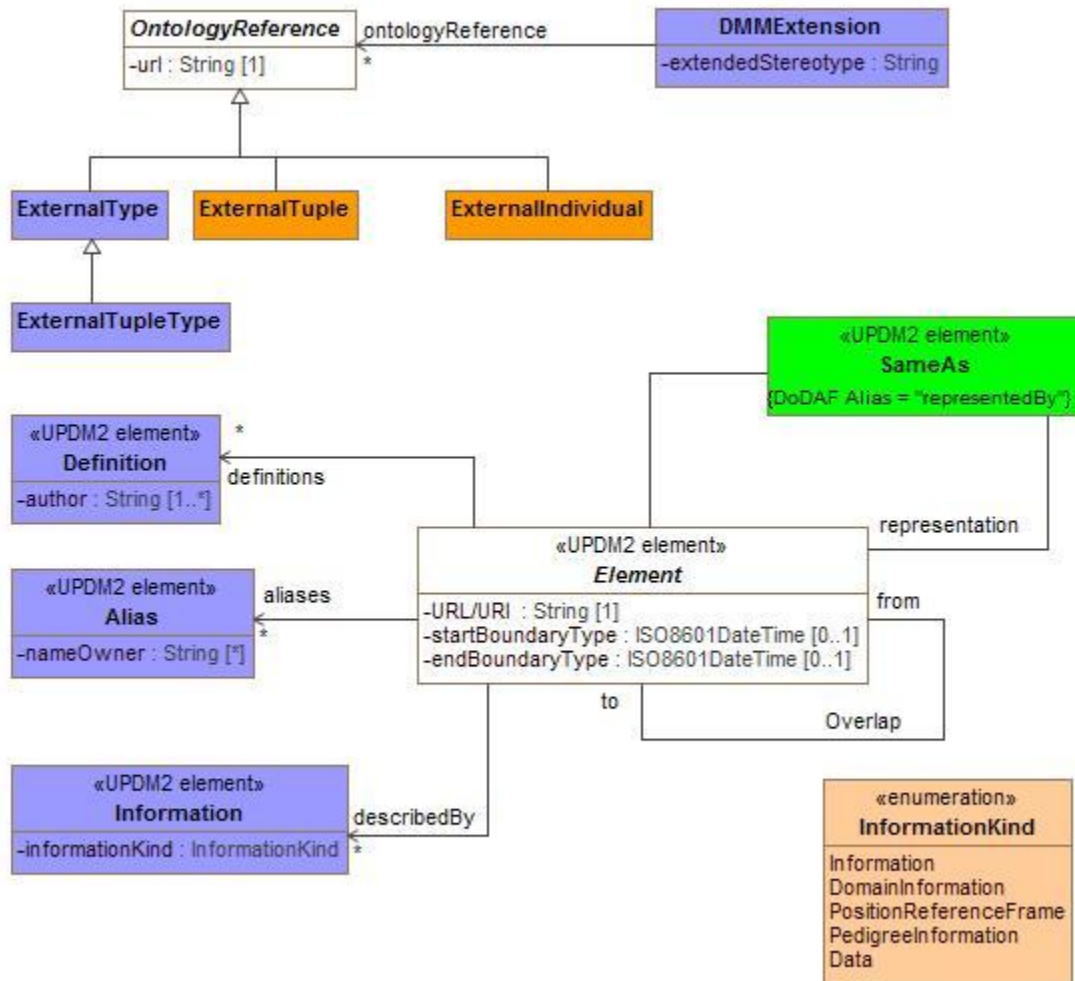

Figure A:5 - AV-2 - DMM

A.1.3 OV

The Operational View is about real-world activities, the people and machinery that perform them, and the means by which they are performed. The Operational View is divided into nine products intended to answer the “who,” “what,” “when,” “where,” “why,” and “how” of a mission. They are summarized below.

A.1.3.1 OV-1 - DMM

MODAF: OV-1 addresses the high level operational concepts related to one or more missions. An OV-1 describes a mission, class of mission, or scenario; and highlights the main operational elements and interesting or unique aspects of operations.

The OV-1 has two purposes. First, it provides a means of organizing the operational architecture models into distinct groups based on scenario context. Second, it communicates the essence of the scenario context in an essentially graphical form.

DoDAF: The OV-1 DoDAF-described View describes a mission, class of mission, or scenario. It shows the main operational concepts and interesting or unique aspects of operations. It describes the interactions between the subject architecture and its environment, and between the architecture and external systems. A textual description accompanying the graphic is crucial. Graphics alone are not sufficient for capturing the necessary architecture data.

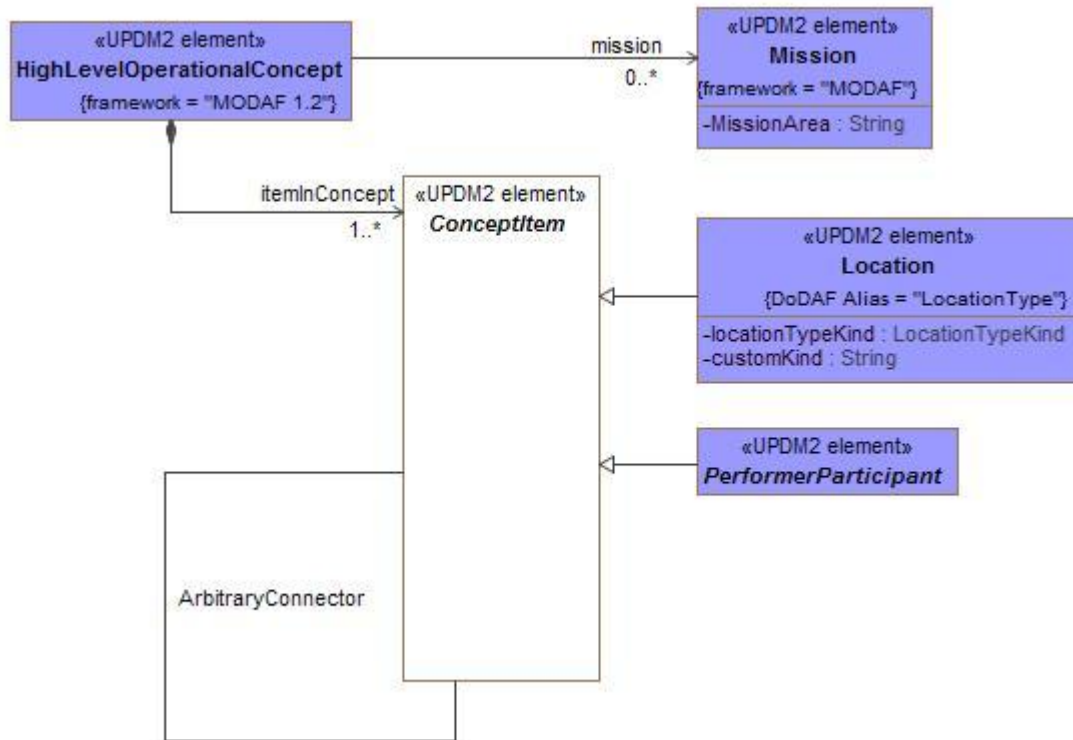

Figure A:6 - OV-1 - DMM

A.1.3.2 OV-2 - DMM

MODAF: The Operational Node Relationships Description (OV-2) addresses localization of operational capability.
 DoDAF: The Operational Resource Description (OV-2) DoDAF-described View applies the context of the operational capability to a community of anticipated users.

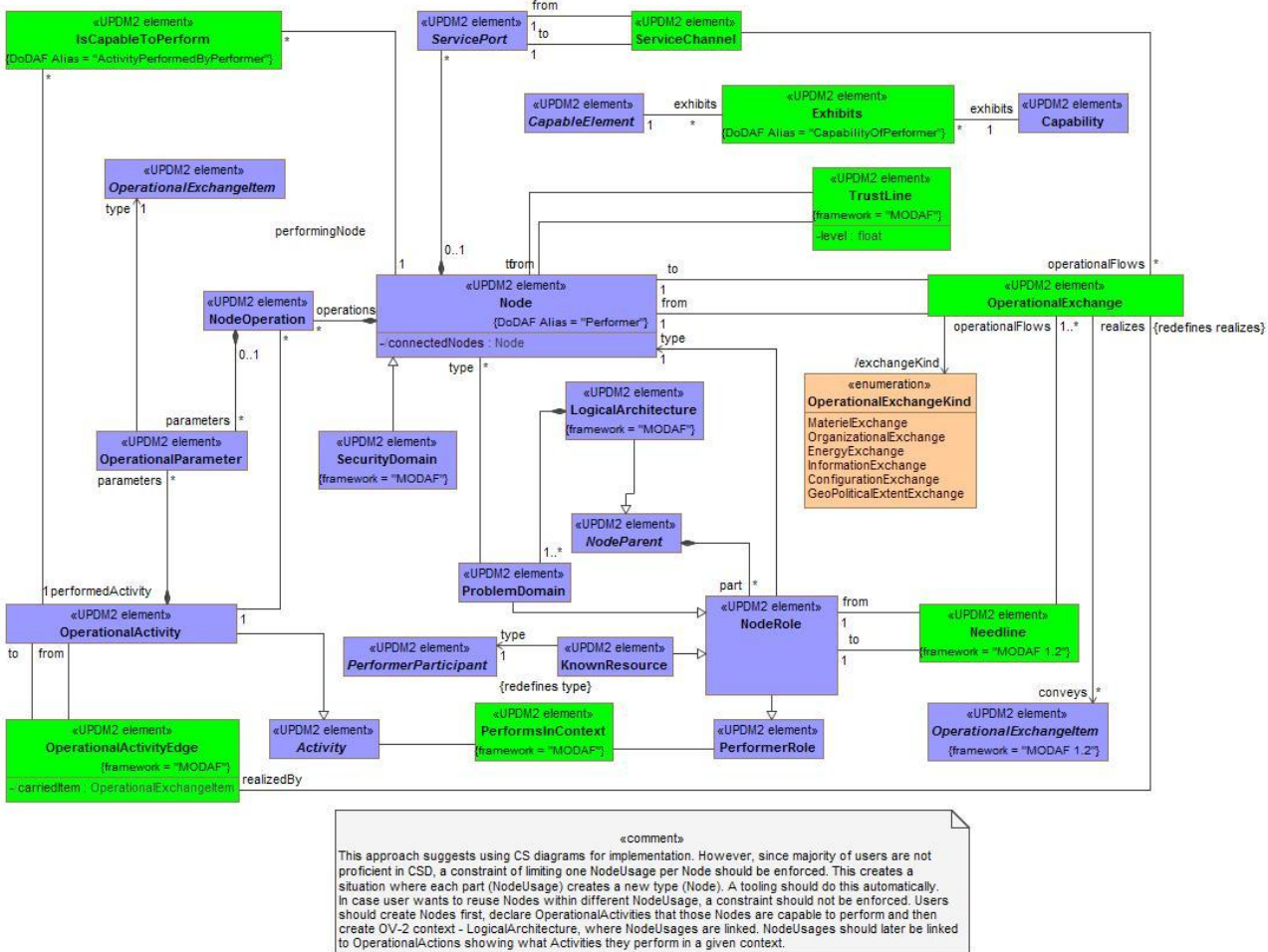

Figure A:7 - OV-2 - DMM

A.1.3.3 OV-3 - DMM

MODAF: The Operational Information Exchange Matrix (OV-3) addresses operational information exchanges between nodes.

DoDAF: The Operational Resource Flow Matrix (OV-3) DoDAF-described addresses operational resource flows exchanged between Operational Activities and locations.

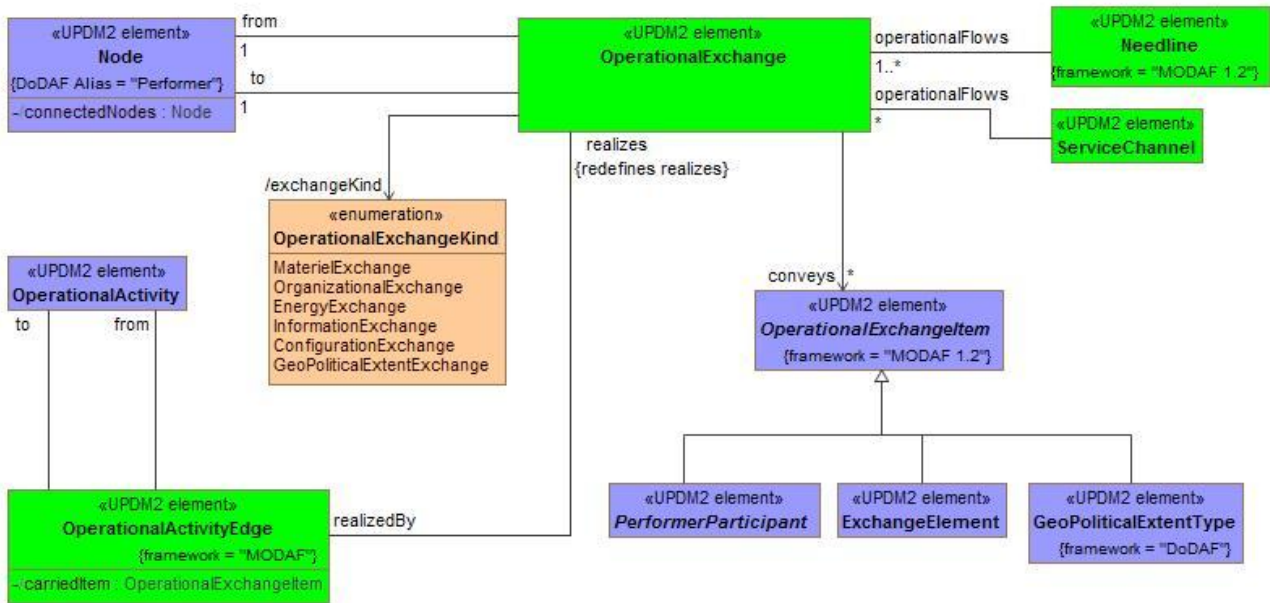

Figure A:8 - OV-3 - DMM

A.1.3.4 OV-4 Actual - DMM

This is the OV-4 Actual View. The Organizational Relationships Chart illustrates the command structure or relationships (as opposed to relationships with respect to a business process flow) among human roles, organizations, or organization types that are the key players in architecture. MoDAF divides the OV-4 two views, an OV-4 Typical and an OV-4 Actual. The former is exactly as the DoDAF OV-4, while the latter is a special form of the SV-1; where the resources are restricted to being organizational.

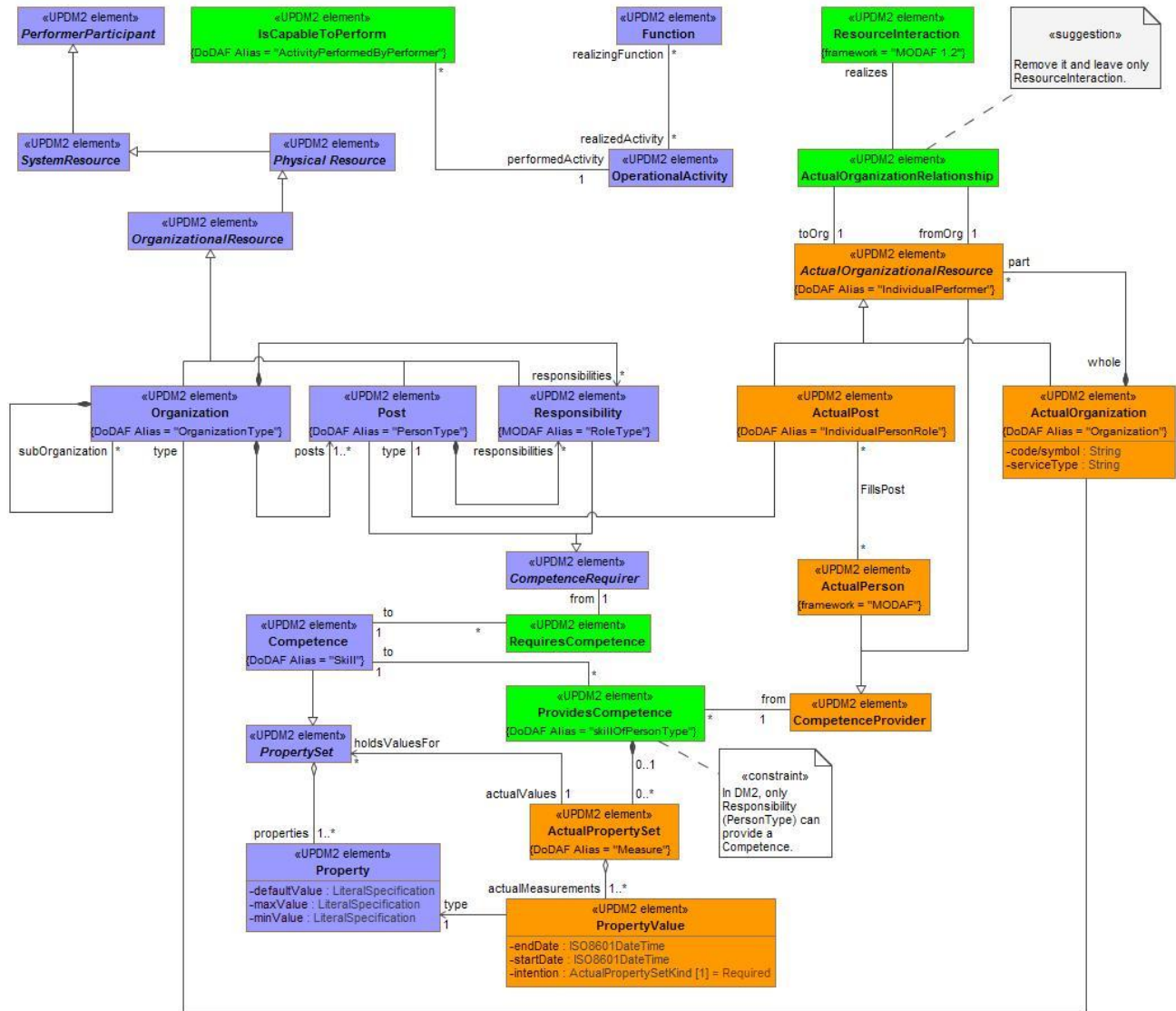

Figure A:9 - OV-4 Actual - DMM

A.1.3.5 OV-4 Typical - DMM

MODAF: The OV-4 shows organizational structures and interactions. The organizations shown may be civil or military. A typical OV-4 shows the possible relationships between organizational resources (organizations and posts).

DoDAF: DoDAF: The OV-4 DoDAF-described View shows organizational structures and interactions. The organizations shown may be civil or military. A typical OV-4 shows the possible relationships between organizational resources.

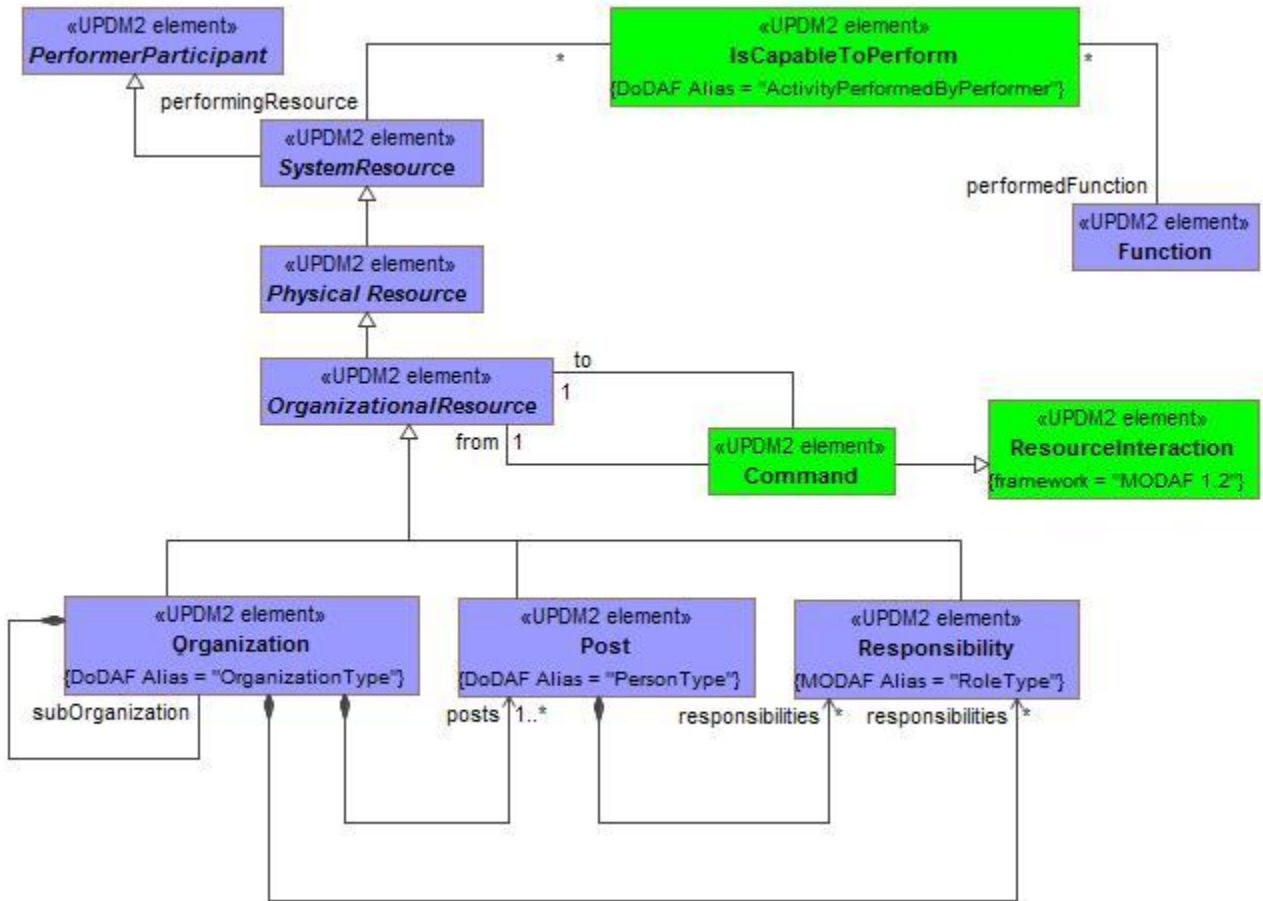

Figure A:10 - OV-4 Typical - DMM

A.1.3.6 OV-5 - DMM

MODAF: The Operational Activity Model (OV-5) describes the operations that are normally conducted in the course of achieving a mission or a business goal. It describes operational activities (or tasks); Input/Output flows between activities, and to/from activities that are outside the scope of the Architecture.

DoDAF: The Operational Activity Model DoDAF-described View describes the operations that are normally conducted in the course of achieving a mission or a business goal. It describes operational activities (or tasks); Input/Output flows between activities, and to/from activities that are outside the scope of the Architecture.

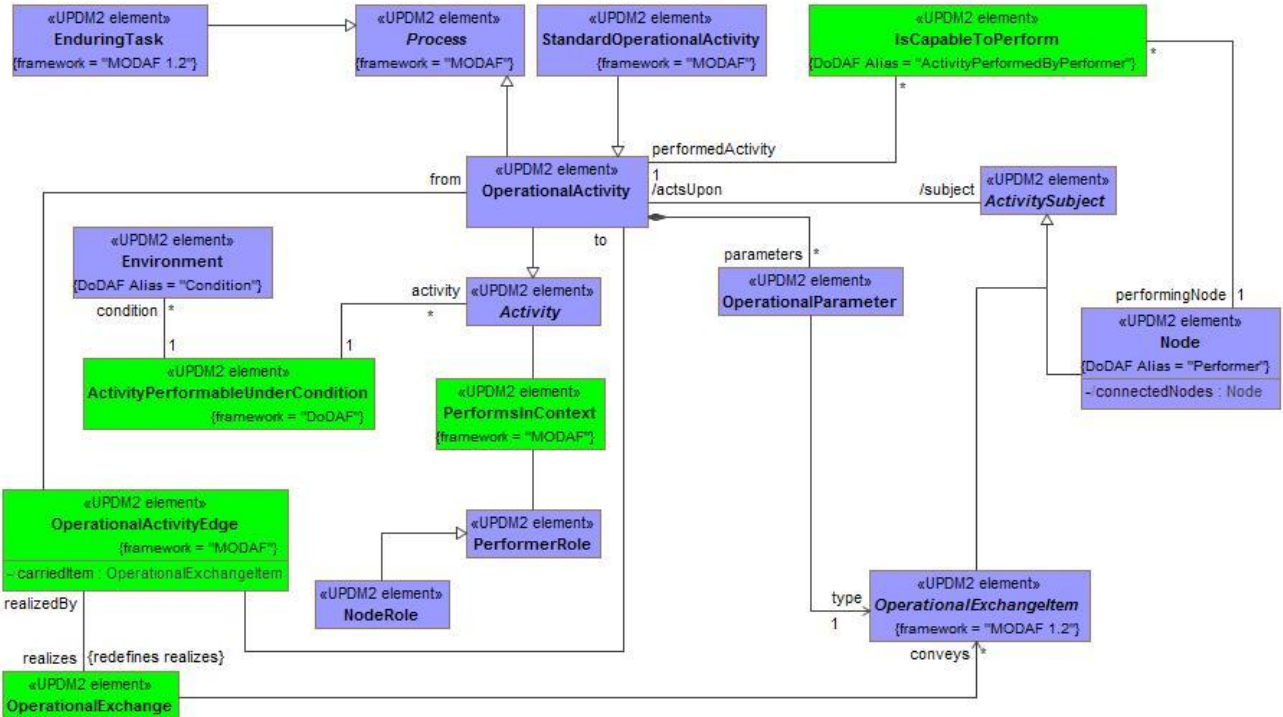

Figure A:11 - OV-5 - DMM

A.1.3.7 OV-6a - DMM

MODAF: An Operational Rules Model (OV-6a) specifies operational or business rules that are constraints on the way that business is done in the enterprise.

DoDAF: An Operational Rules Model (OV-6a) DoDAF-described View specifies operational or business rules that are constraints on the way that business is done in the enterprise.

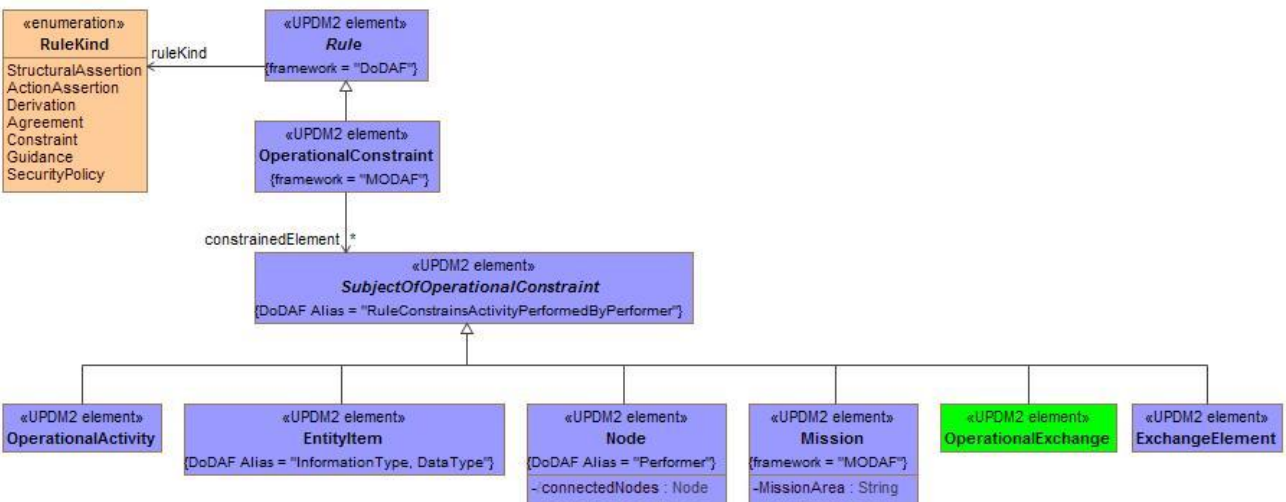

Figure A:12 - OV-6a - DMM

A.1.3.8 OV-6b - DMM

MODAF: OV-6b: The Operational State Transition Description is a graphical method of describing how an Operational Node or activity responds to various events by changing its state. The diagram represents the sets of

events to which the Architecture will respond (by taking an action to move to a new state) as a function of its current state. Each transition specifies an event and an action.

DoDAF: The Operational State Transition Description (OV-6b) DoDAF-described View is a graphical method of describing how an Operational Activity responds to various events by changing its state. The diagram represents the sets of events to which the Architecture will respond (by taking an action to move to a new state) as a function of its current state. Each transition specifies an event and an action.

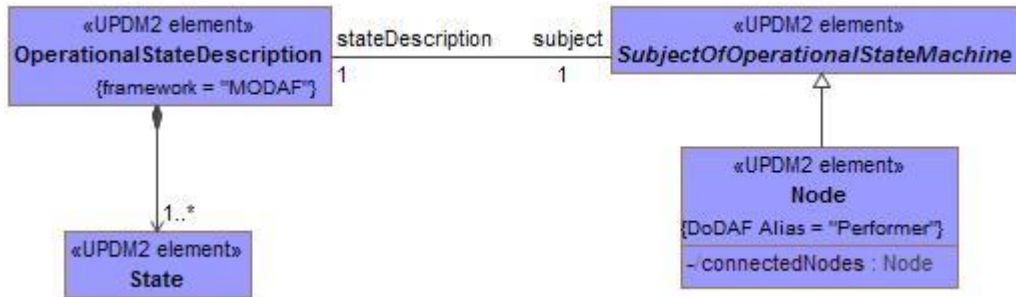

Figure A:13 - OV-6b - DMM

A.1.3.9 OV-6c - DMM

MODAF: OV-6c: The Operational Event-Trace Description provides a time-ordered examination of the information exchanges between participating Operational Nodes as a result of a particular scenario. Each event-trace diagram will have an accompanying description that defines the particular scenario or situation.

DoDAF: The Operational Event-Trace Description (OV-6c) DoDAF-described View provides a time ordered examination of the resource flows as a result of a particular scenario. Each event-trace diagram will have an accompanying description that defines the particular scenario or situation.

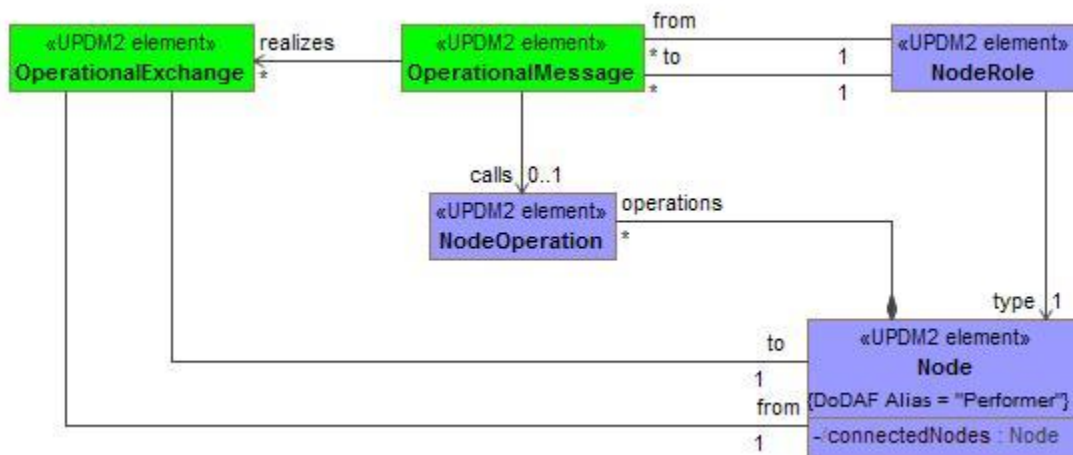

Figure A:14 - OV-6c - DMM

A.1.3.10 OV-7/DIV-1/DIV-2/ - DMM

MODAF: Information Models (OV-7) address the information perspective on an operational architecture.

DoDAF: The Conceptual Data Model (DIV-1), a new DoDAF-described View in DoDAF V2.0, addresses the information concepts at a high-level on an operational architecture.

The Logical Data Model (DIV-2) DoDAF-described View allows analysis of an architecture's data definition aspect, without consideration of implementation specific or product specific issues.

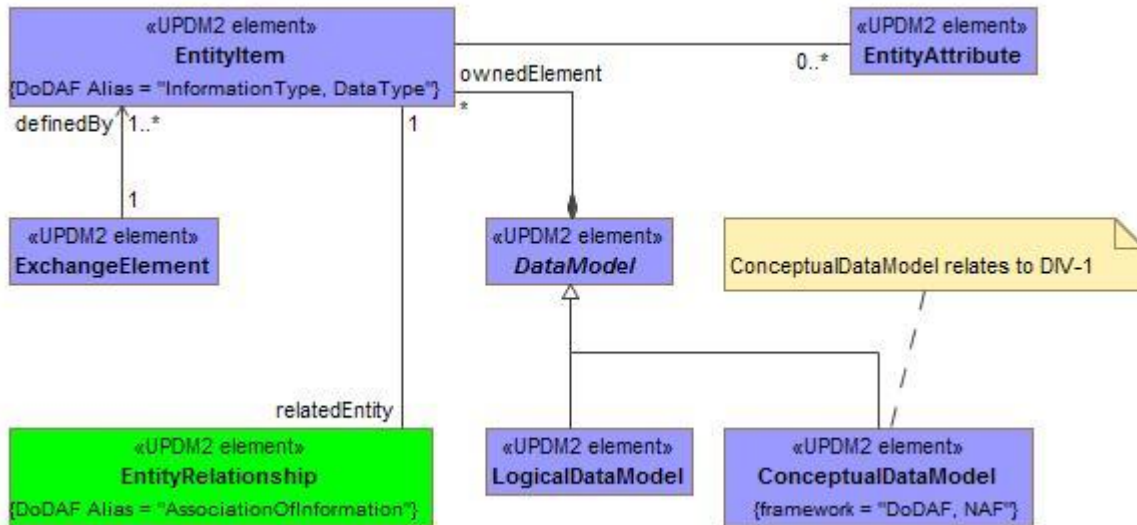

Figure A:15 - OV-7/DIV-1/DIV-2/ - DMM

A.1.4 SOV

The Service-Oriented View (SOV) is a description of services needed to directly support the operational domain as described in the OperationalView. A service is described as a unit of work through which a particular Resource provides a useful result to a consuming Resource.

The direction taken by UPDM in modeling services is heavily based on a simplified version of the UPMS profile. Only those elements which are compatible with existing DoDAF/MODAF concepts have been used. A full integration with UPMS will be assessed at a later date.

A.1.4.1 SOV-1 - DMM

The Service Taxonomy View (SOV-1) specifies a hierarchy of services. The elements in the hierarchy are service specifications (i.e., service interfaces), and the relationships between the elements are specializations – i.e., one Service is a special type of another. Along with SOV-2, it specifies a standard library of Service specifications for an enterprise, which Service implementers are expected to conform to.

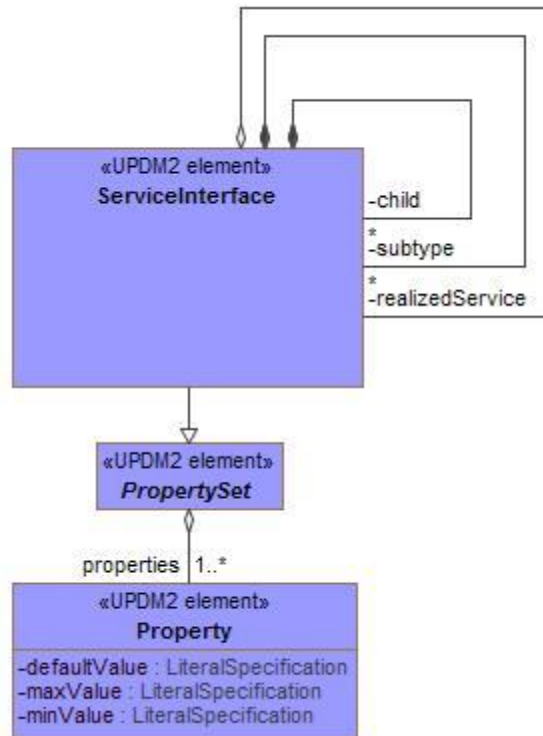

Figure A:16 - SOV-1 - DMM

A.1.4.2 SOV-2 - DMM

MODAF: The Service Taxonomy View (SOV-1) specifies a hierarchy of services. The elements in the hierarchy are service specifications (rather than service implementations), and the relationships between the elements are specialisations – i.e., one Service is a special type of another.

DoDAF: NA

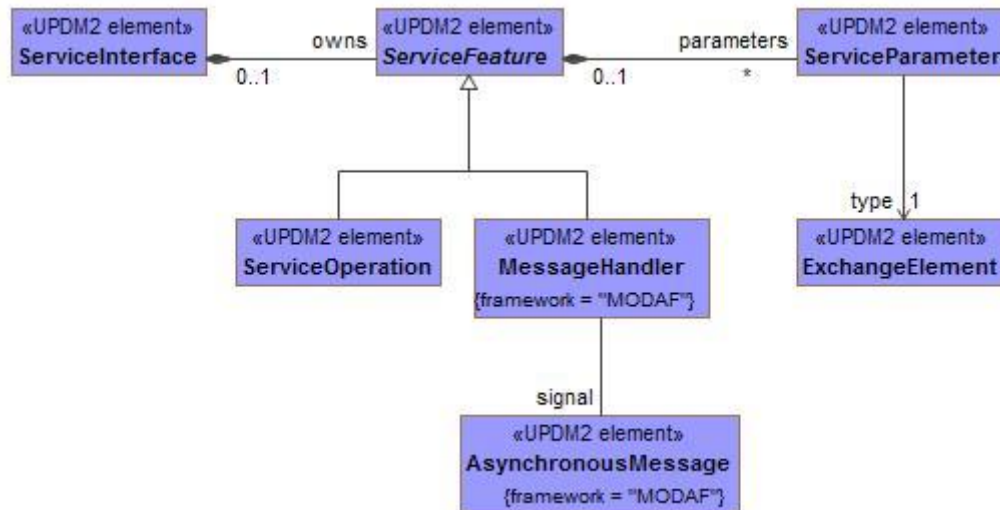

Figure A:17 - SOV-2 - DMM

A.1.4.3 SOV-3 - DMM

MODAF: The Capability to Service Mapping View (SOV-3) depicts which services contribute to the achievement of a capability.

DoDAF: The Operational Activity to Services Function Traceability Matrix (SvcV-5) DoDAF-described View addresses the linkage between service functions described in SvcV-4 and Operational Activities specified in OV-5.

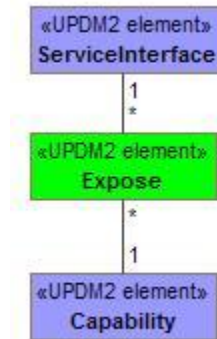

Figure A:18 - SOV-3 - DMM

A.1.4.4 SOV-4a - DMM

MODAF: The purpose of the Service Constraints View (SOV-4a) is to specify constraints that apply to implementations of services.

DoDAF: The SvcV-10a DoDAF-described View describes constraints on the resources, functions, data and ports that make up the Service View physical architecture. The constraints are specified in text and may be functional or structural (i.e., non-functional).

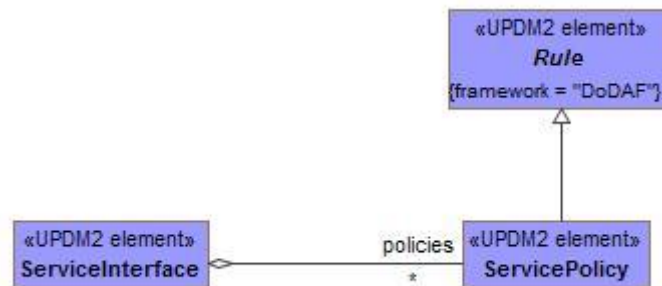

Figure A:19 - SOV-4a - DMM

A.1.4.5 SOV-4b - DMM

MODAF: The purpose of the Service State Model View (SOV-4b) is to specify the possible states a service may have, and the possible transitions between those states.

DoDAF: The Services State Transition Description DoDAF-described View is a graphical method of describing a resource (or function) response to various events by changing its state. The diagram basically represents the sets of events to which the resources in the Architecture will respond (by taking an action to move to a new state) as a function of its current state. Each transition specifies an event and an action.



Figure A:20 - SOV-4b - DMM

A.1.4.6 SOV-4c - DMM

The purpose of the Service Interaction Specification View (SOV-4c) is to specify how a service interacts with external agents, and the sequence and dependencies of those interactions. An SOV-4c product does not specify the sequencing of an orchestrated set of services (see OV-6c). Its purpose is to specify the general sequence of interactions that are possible for a given service.

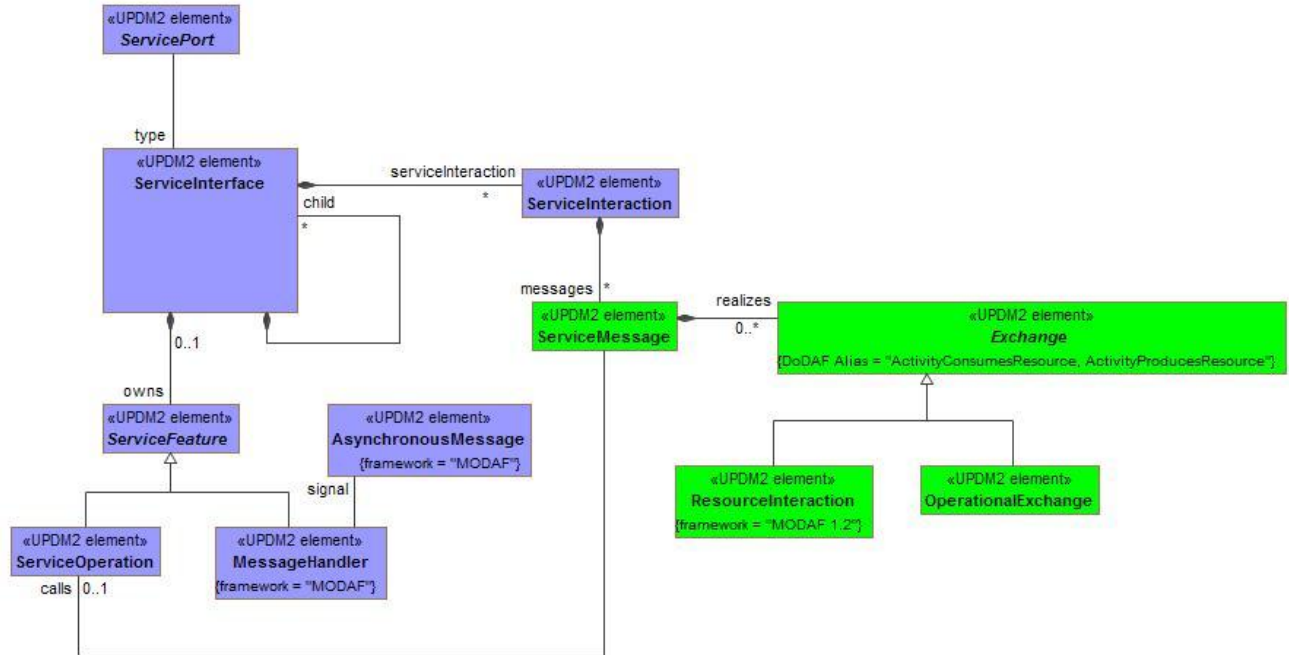

Figure A:21 - SOV-4c - DMM

A.1.4.7 SOV-5 - DMM

MODAF: The Service Functionality View (SOV-5) defines the behavior of a service in terms of the functions it is expected to perform.

DoDAF: The Services Functionality Description provides detailed information regarding the Allocation of service functions to resources, and Flow of resources between service functions.

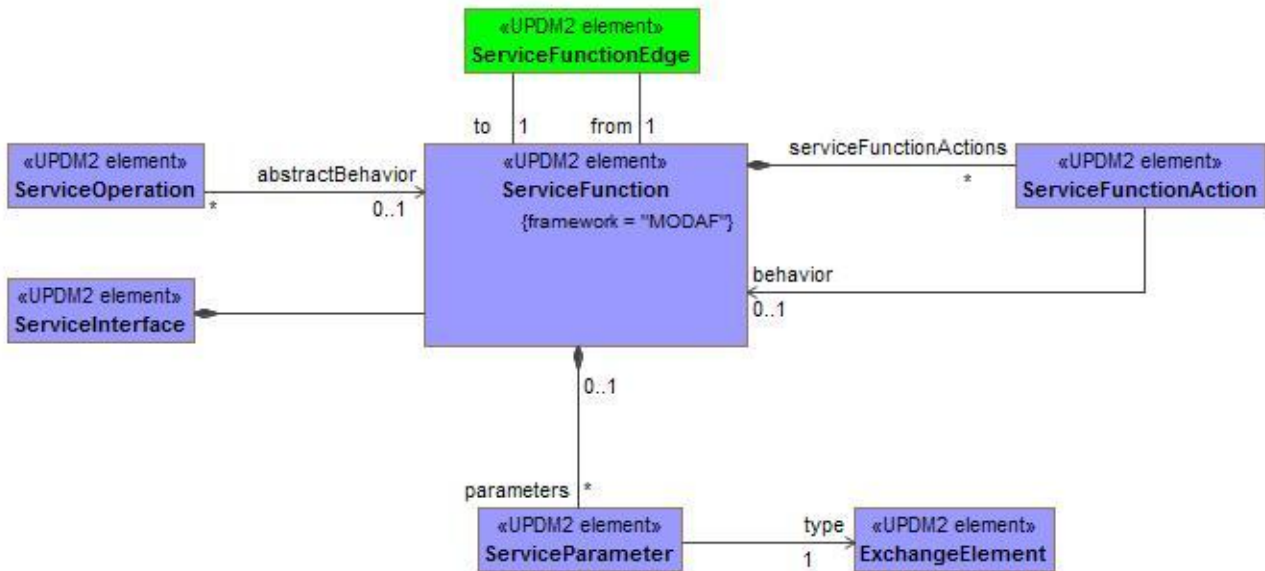

Figure A:22 - SOV-5 - DMM

A.1.5 StV/CV

The Strategic Elements are used in the Strategic View which provides an overall Enterprise Architecture assessment of the Capabilities and their relationships facilitating Capability Management (e.g., capability introduction, integration, re-alignment, and removal). While an Enterprise will have a number of UPDM Architecture Descriptions that have the Operational, System, Technical Standards, and All Views, only one Strategic View will exist across a number of Architecture Descriptions.

A.1.5.1 CV-7 - DMM

MODAF: NA

DoDAF: CV-7 details the mapping between DoDAF services (ServiceAccess) and the Capability that they realize.

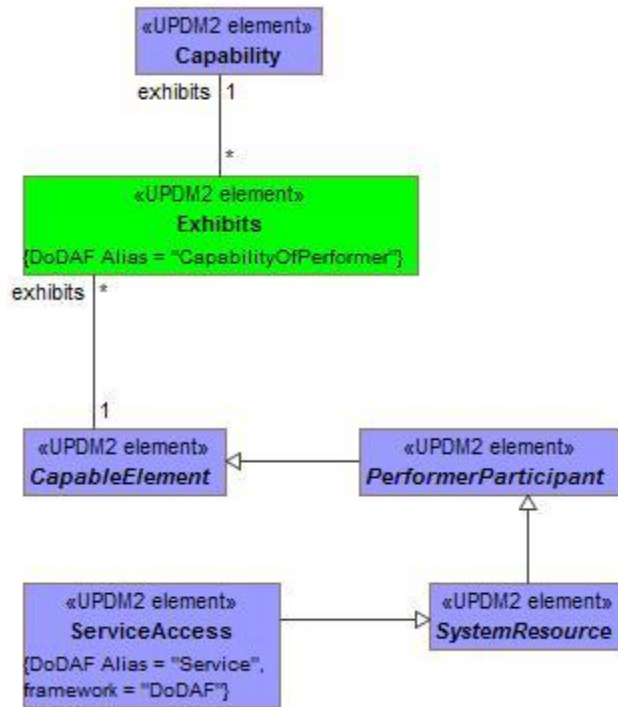

Figure A:23 - CV-7 - DMM

A.1.5.2 StV-1/CV-1 - DMM

MODAF: StV-1 addresses the enterprise concerns associated with the overall vision for transformational endeavors and thus defines the strategic context for a group of Enterprise capabilities.

DoDAF: CV-1: Vision: addresses the enterprise concerns associated with the overall vision for transformational endeavors and thus defines the strategic context for a group of capabilities.

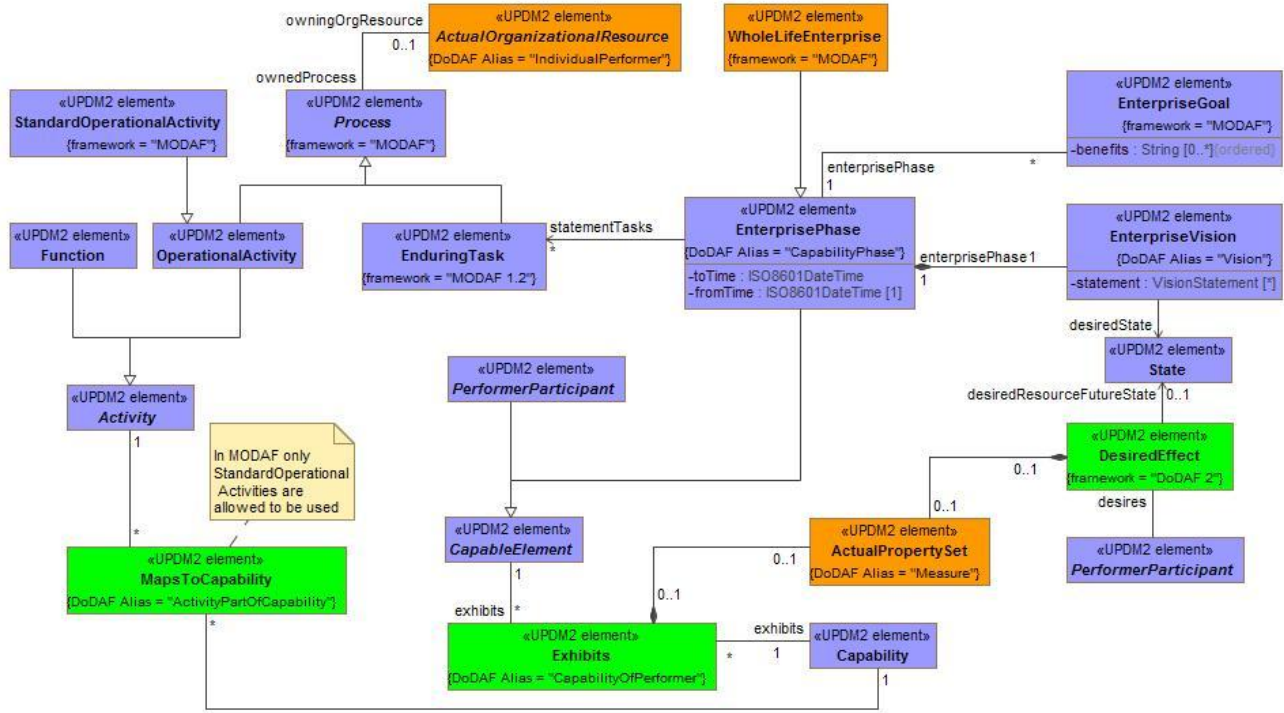

Figure A:24 - StV-1/CV-1 - DMM

A.1.5.3 StV-2/CV-2 - DMM

MODAF: The StV-2 Product models capability taxonomies.

DoDAF: The CV-2 DoDAF-described View models capability taxonomies.

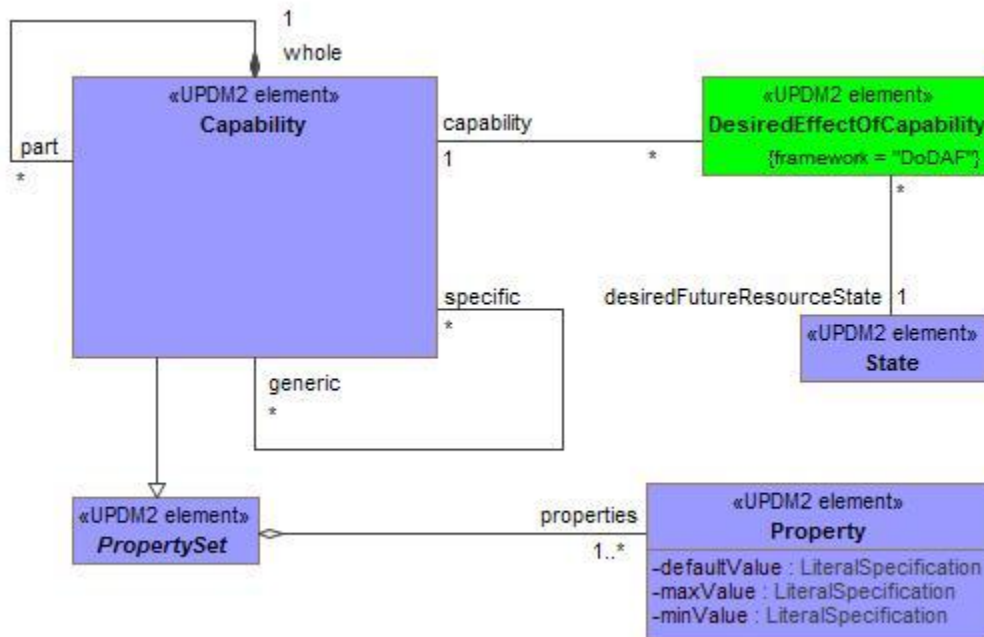

Figure A:25 - StV-2/CV-2 - DMM

A.1.5.4 StV-3/CV-3 - DMM

MODAF: StV-3 addresses the planned achievement of capability at different points in time or during specific periods of time, i.e., capability phasing.

DoDAF: CV-3: Capability Phasing: The CV-3 addresses the planned achievement of capability at different points in time or during specific periods of time, i.e., capability phasing.

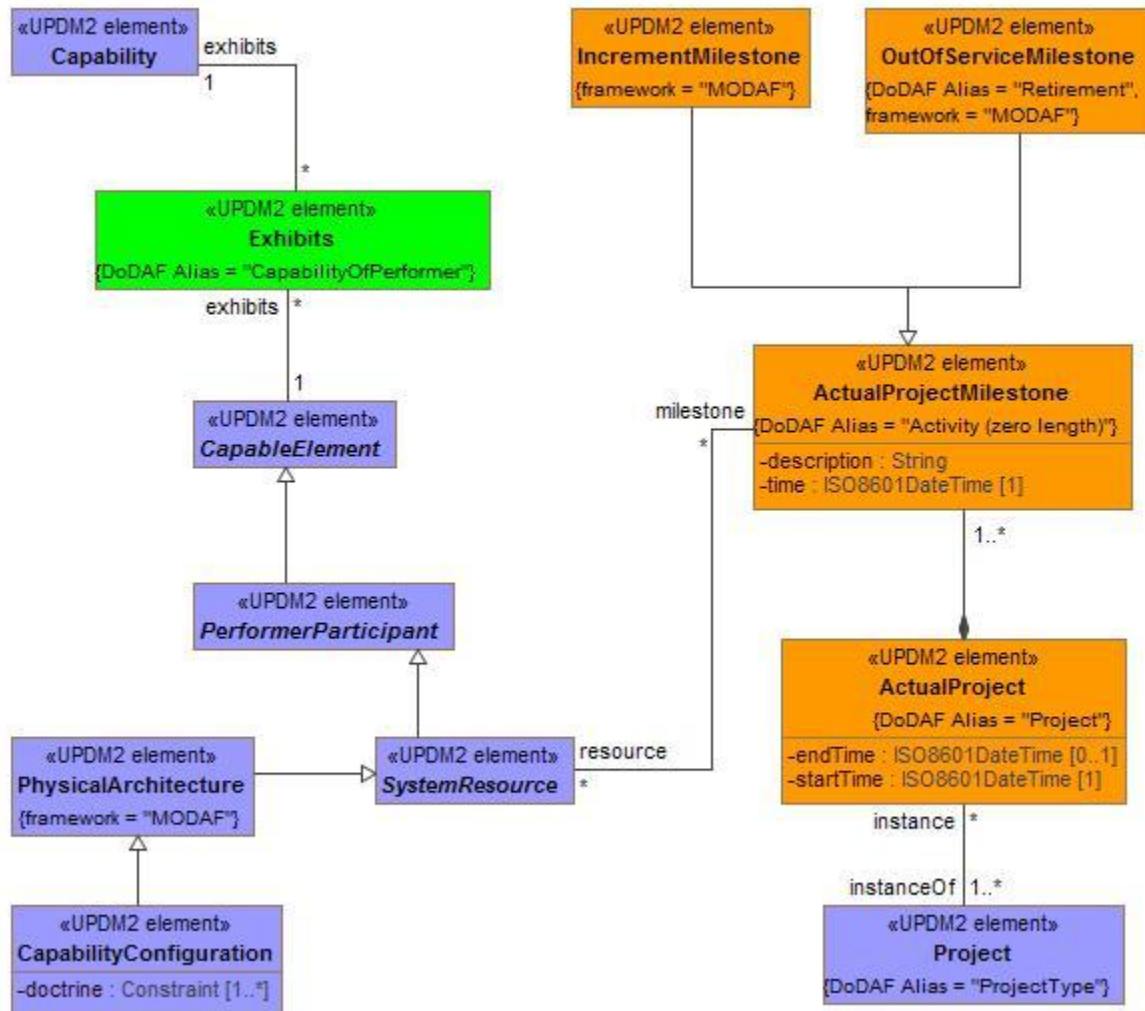

Figure A:26 - StV-3/CV-3 - DMM

A.1.5.5 StV-4/CV-4 - DMM

MODAF: The StV-4 Product describes the dependencies between planned capabilities. It also defines logical groupings of capabilities (capability clusters).

DoDAF: CV-4: Capability Dependencies: The CV-4 DoDAF-described View describes the dependencies between planned capabilities. It also defines logical groupings of capabilities.

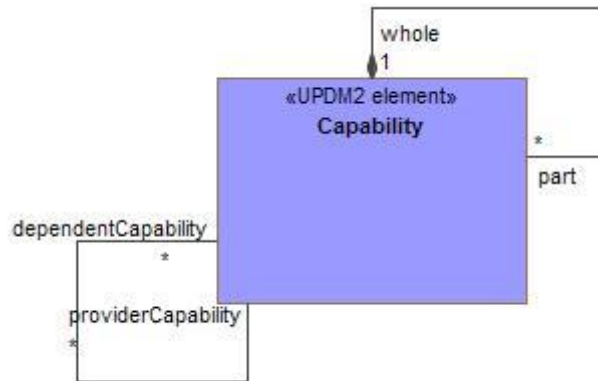

Figure A:27 - StV-4/CV-4 - DMM

A.1.5.6 StV-5/CV-5 - DMM

MODAF: StV-5 addresses the fulfilment of capability requirements, in particular by network enabled capabilities.
 DoDAF: CV-5: Capability to Organizational Development Mapping: The CV-5 addresses the fulfilment of capability requirements.

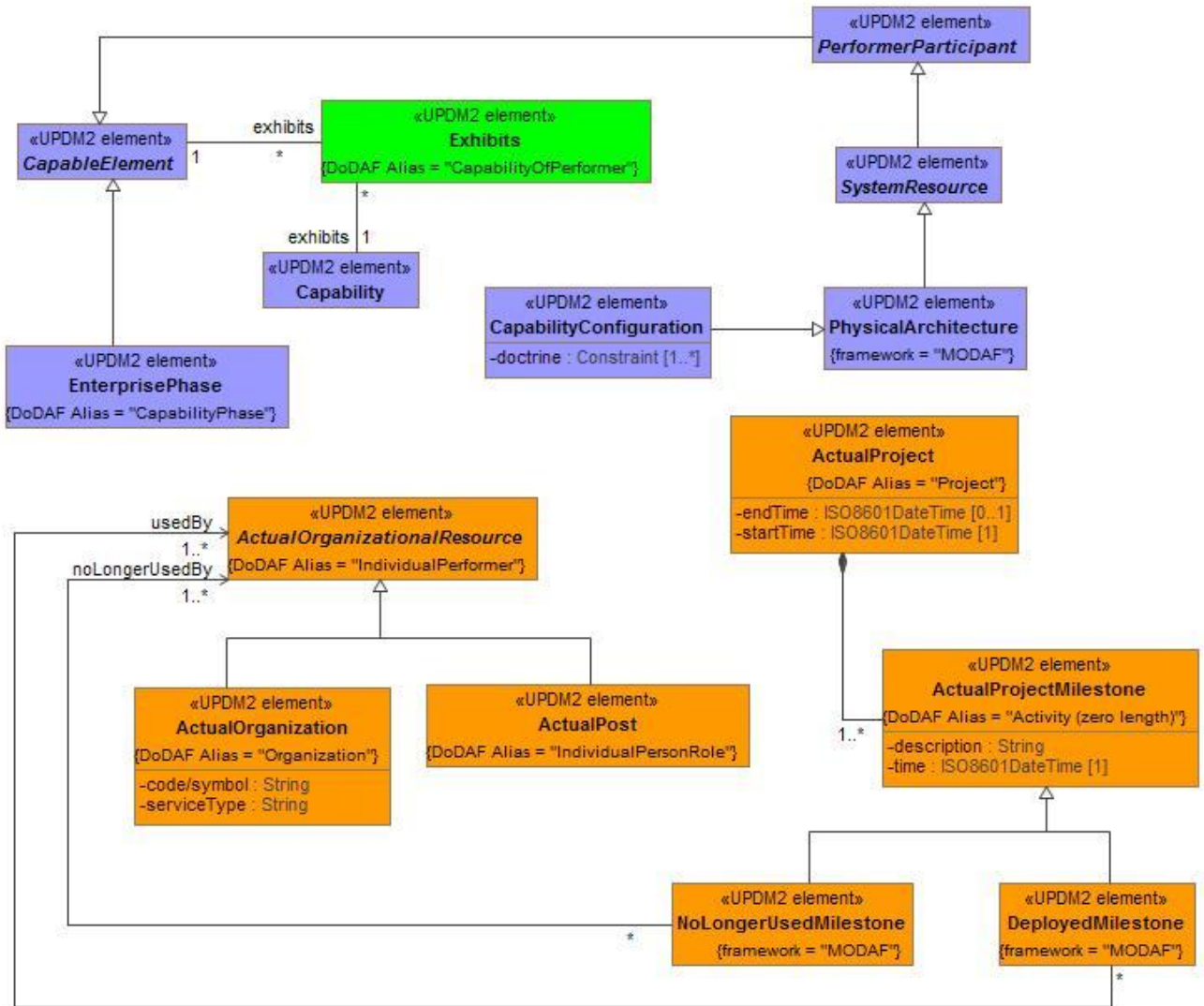

Figure A:28 - StV-5/CV-5 - DMM

A.1.5.7 StV-6/CV-6 - DMM

MODAF: The StV-6 Product describes the mapping between the capabilities required by an Enterprise and the operational activities that those capabilities support.

DoDAF: CV-6: Capability to Operational Activities Mapping: The CV-6 DoDAF-described View describes the mapping between the capabilities required and the operational activities that those capabilities support.

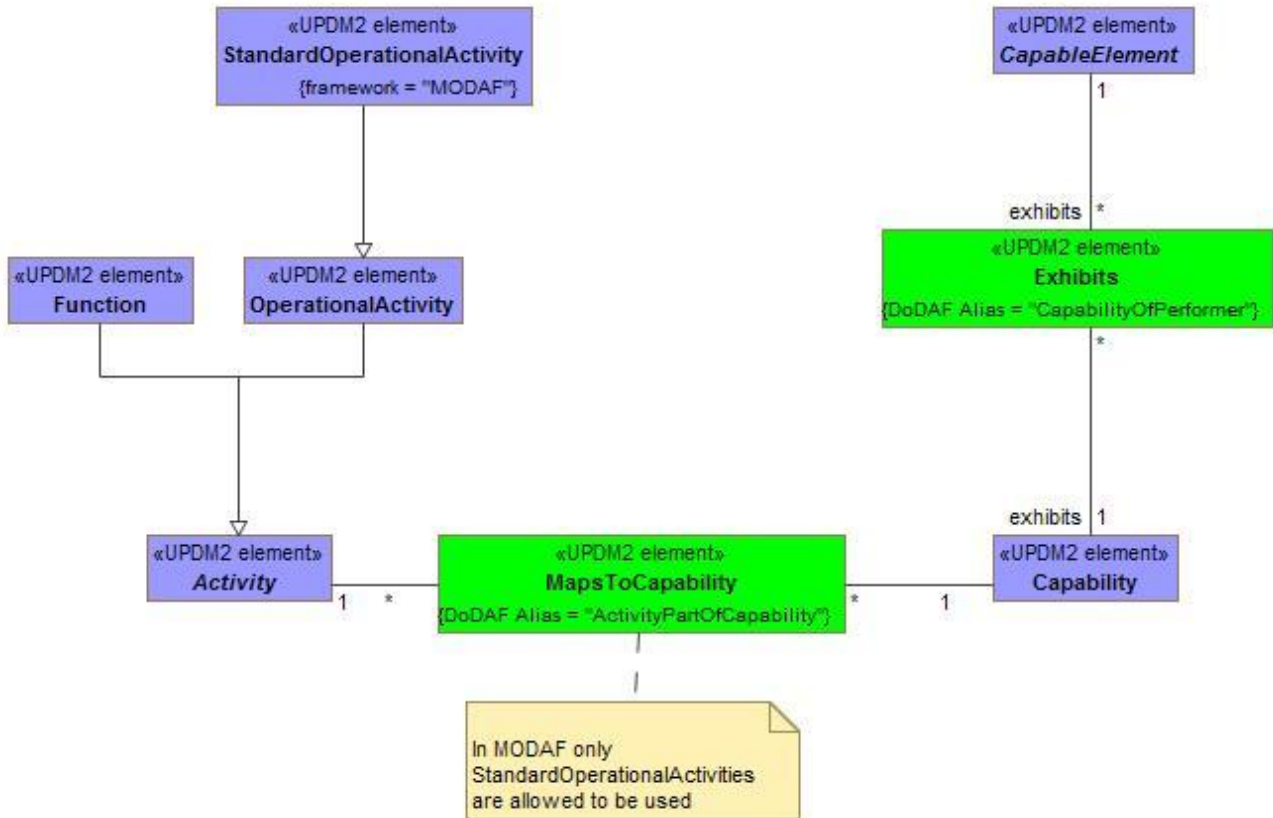

Figure A:29 - StV-6/CV-6 - DMM

A.1.6 SV/SvcV

Models in the System Viewpoint represent alternate realizations in terms of equipment capability of the operational capabilities expressed through models in the Operational Viewpoint and in the User Requirements. The System Viewpoint primarily addresses the specification of the system capability needed (rather than implementation details). Significant changes originally made in MODAF improved the ability for modelers to represent configuration of capability that include people as well as systems and platforms.

A.1.6.1 SV-1/SvcV-1 - DMM

MODAF: Resource Interaction Specification (SV-1) addresses the composition and interaction of resources. From MODAF v1.1, SV-1 incorporates the human elements – Posts, Organizations, and Roles.

DoDAF: The Systems Interface Description (SV-1) DoDAF-described View addresses the composition and interaction of Systems. For DoDAF v2.0, the SV-1 incorporates the human elements as types of Performers-Organizations and Personnel Types.

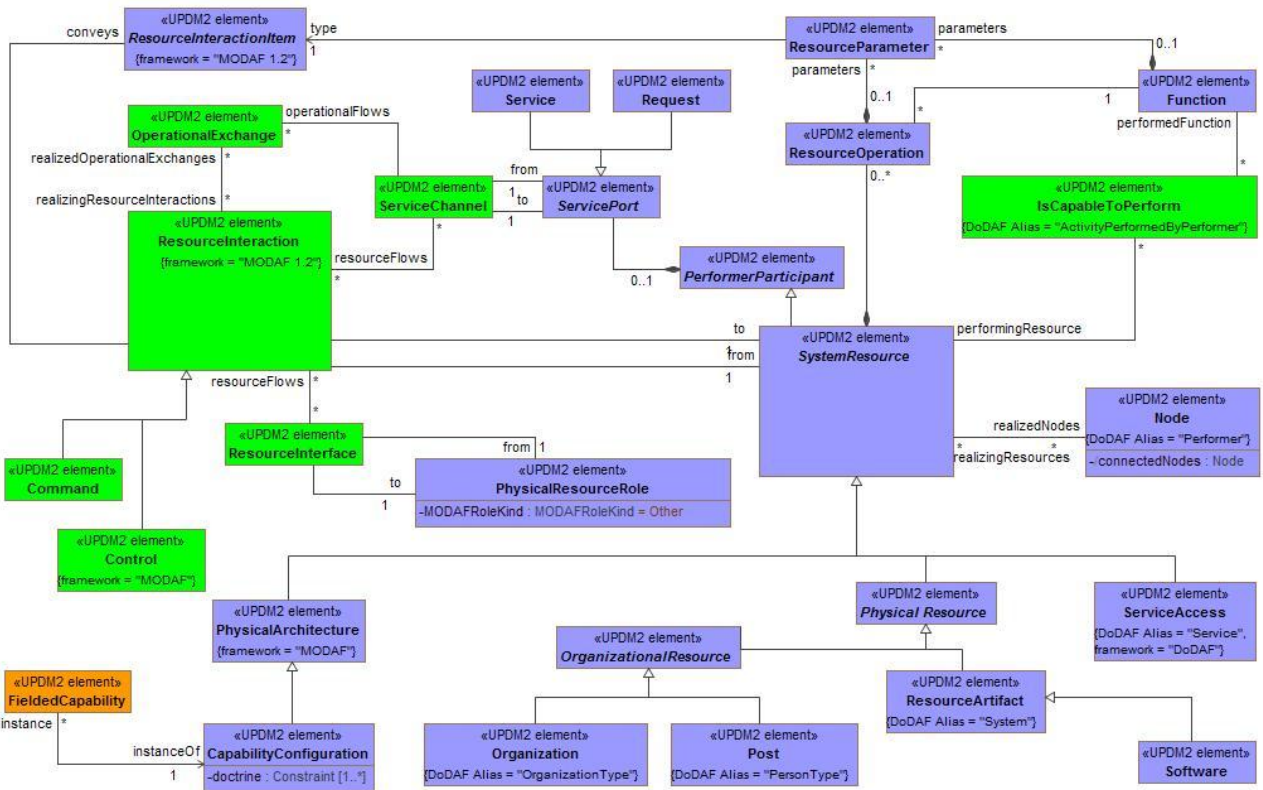

Figure A:30 - SV-1/SvcV-1 - DMM

A.1.6.2 SV-10a/SvcV-10a - DMM

MODAF: The purpose of this Product is to specify functional and non-functional constraints on the implementation aspects of the architecture (i.e., the structural and behavioral elements of the SV viewpoint).

DoDAF: The SV-10a Systems Rules Model DoDAF-described View describes constraints on the resources, functions, data, and ports that make up the SV physical architecture. The constraints are specified in text and may be functional or structural (i.e., non-functional).

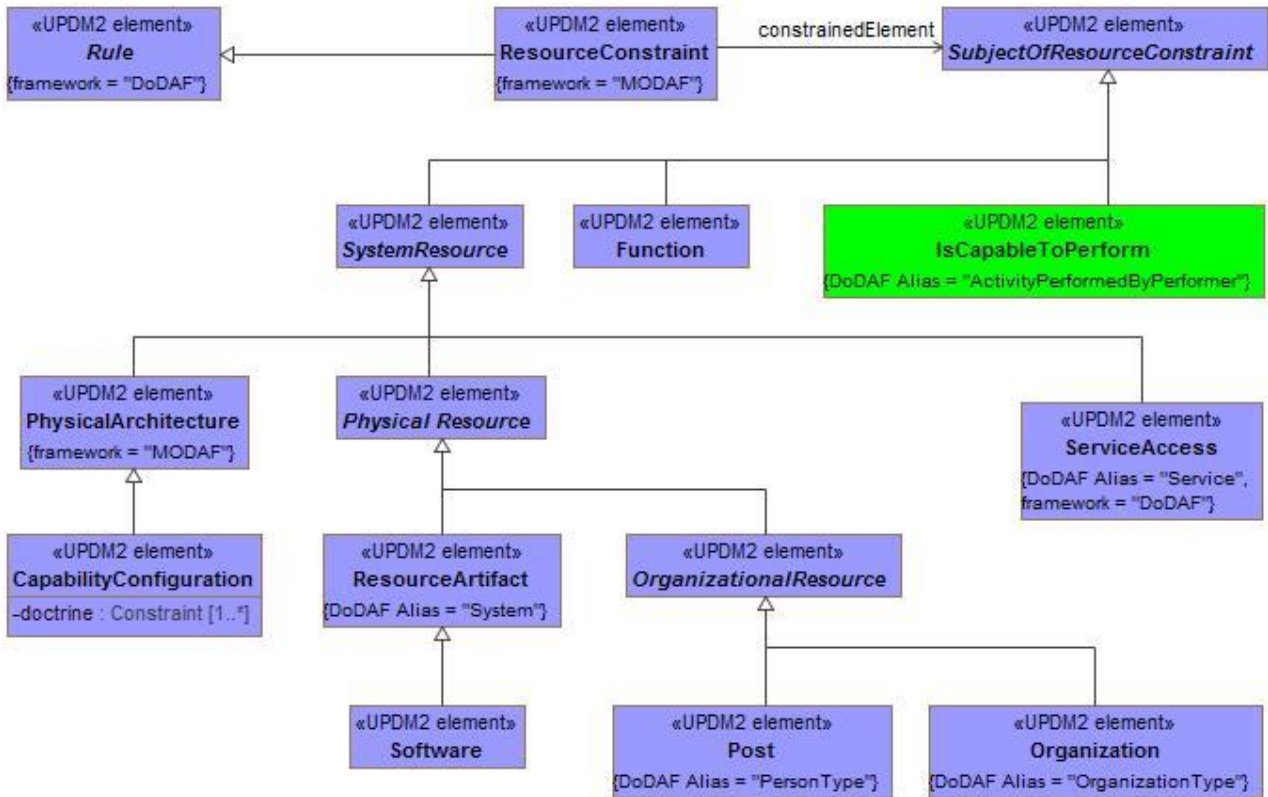

Figure A:31 - SV-10a/SvcV-10a - DMM

A.1.6.3 SV-10b/SvcV-10b DMM

MODAF: The Resource State Transition Description is a graphical method of describing a resource (or function) response to various events by changing its state. The diagram basically represents the sets of events to which the Resources in the Architecture will respond (by taking an action to move to a new state) as a function of its current state. Each transition specifies an event and an action.

DoDAF: The Systems State Transition Description DoDAF-described View is a graphical method of describing a resource (or system function) response to various events by changing its state. The diagram basically represents the sets of events to which the resources in the Architecture will respond (by taking an action to move to a new state) as a function of its current state. Each transition specifies an event and an action.

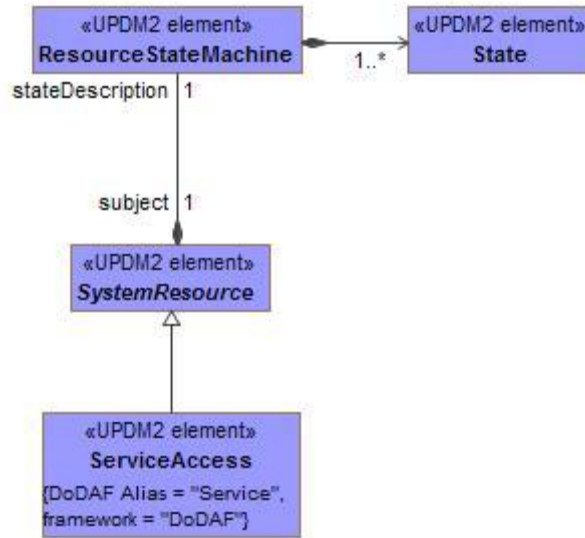

Figure A:32 - SV-10b/SvcV-10b DMM

A.1.6.4 SV-10c/SvcV-10c - DMM

MODAF: The Resource Event-Trace Description provides a time-ordered examination of the interactions between resources. Each event-trace diagram will have an accompanying description that defines the particular scenario or situation.

DoDAF: The Systems Event-Trace Description provides a time-ordered examination of the interactions between functional resources. Each event-trace diagram will have an accompanying description that defines the particular scenario or situation.

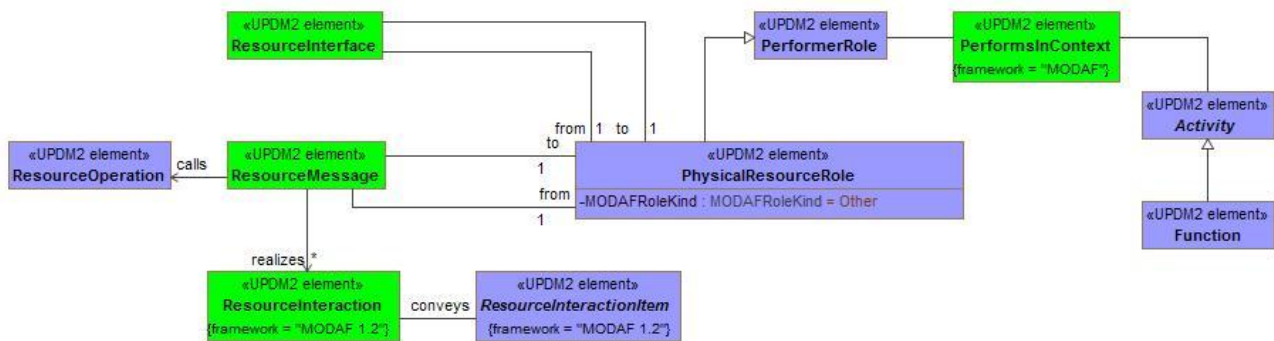

Figure A:33 - SV-10c/SvcV-10c - DMM

A.1.6.5 SV-11/DIV-3 - DMM

MODAF: The SV-11 View defines the structure of the various kinds of system data that are utilized by the systems in the Architecture.

DoDAF: The DIV-3 Physical Data Model DoDAF-described view defines the structure of the various kinds of system or service data that are utilized by the systems or services in the Architecture.

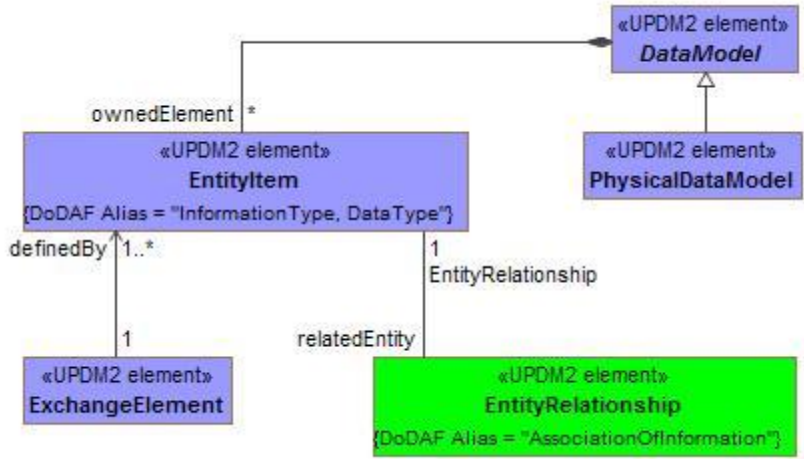

Figure A:34 - SV-11/DIV-3 - DMM

A.1.6.6 SV-12 - DMM

MODAF: The Service Provision View (SV-12) specifies configurations of resources that can deliver a service, and the levels of service those resources can deliver in different environments.
 DoDAF: NA

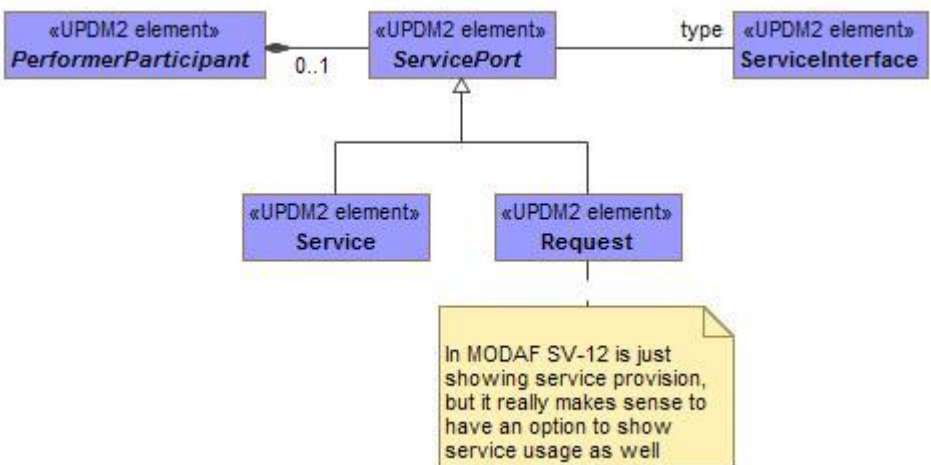

Figure A:35 - SV-12 - DMM

A.1.6.7 SV-2/SvcV-2 - DMM

MODAF: The Systems Communications Description (SV-2a/2b/2c) series of views is intended for the representation of communications networks and pathways that link communications systems, and provides details regarding their configuration.
 DoDAF: A Systems Resource Flow Description (SV-2) DoDAF-described View specifies the resource flows between Systems and may also list the protocol stacks used in connections.

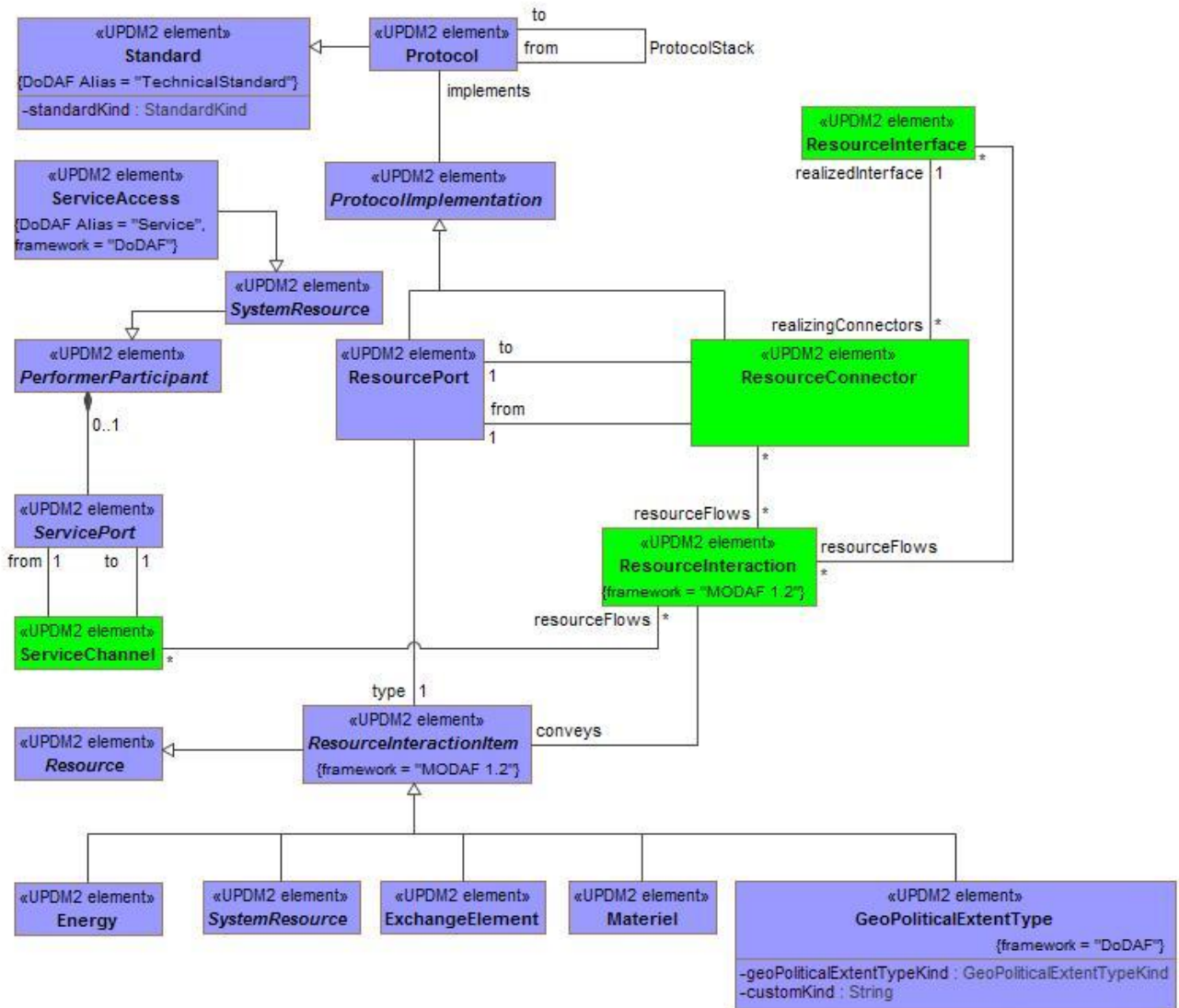

Figure A:36 - SV-2/SvcV-2 - DMM

A.1.6.8 SV-3/SvcV-3a/SvcV-3b - DMM

MODAF: The Resource Interaction Matrix provides a tabular summary of the resource interactions specified in the SV-1 for the Architecture.

DoDAF: The Systems – Systems Matrix (SV-3) DoDAF-described View provides a tabular summary of the system interactions specified in the SV-1 for the Architecture.

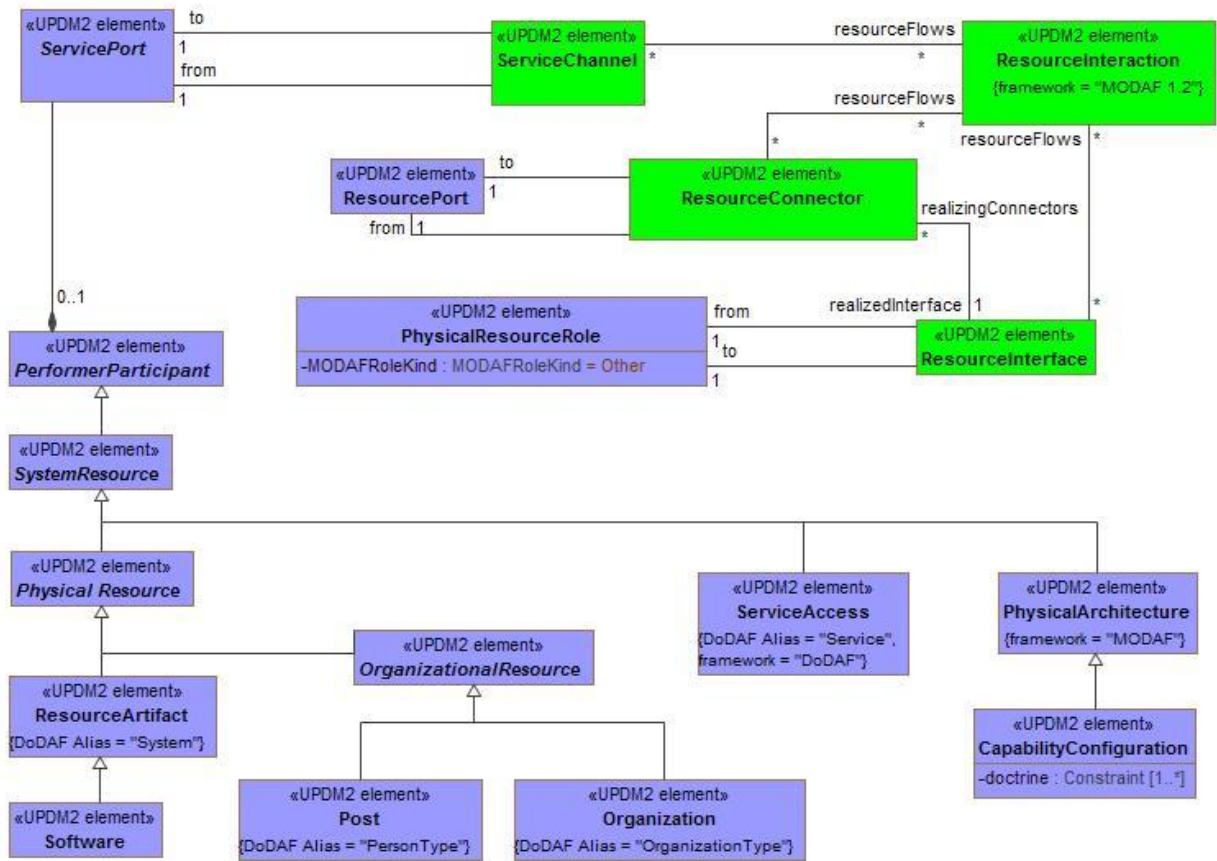

Figure A:37 - SV-3/SvcV-3a/SvcV-3b - DMM

A.1.6.9 SV-4/SvcV-4 - DMM

MODAF: Functionality Descriptions (SV-4) address human and system functionality.

DoDAF: The Systems Functionality Description (SV-4) DoDAF-described View addresses human and system functionality.

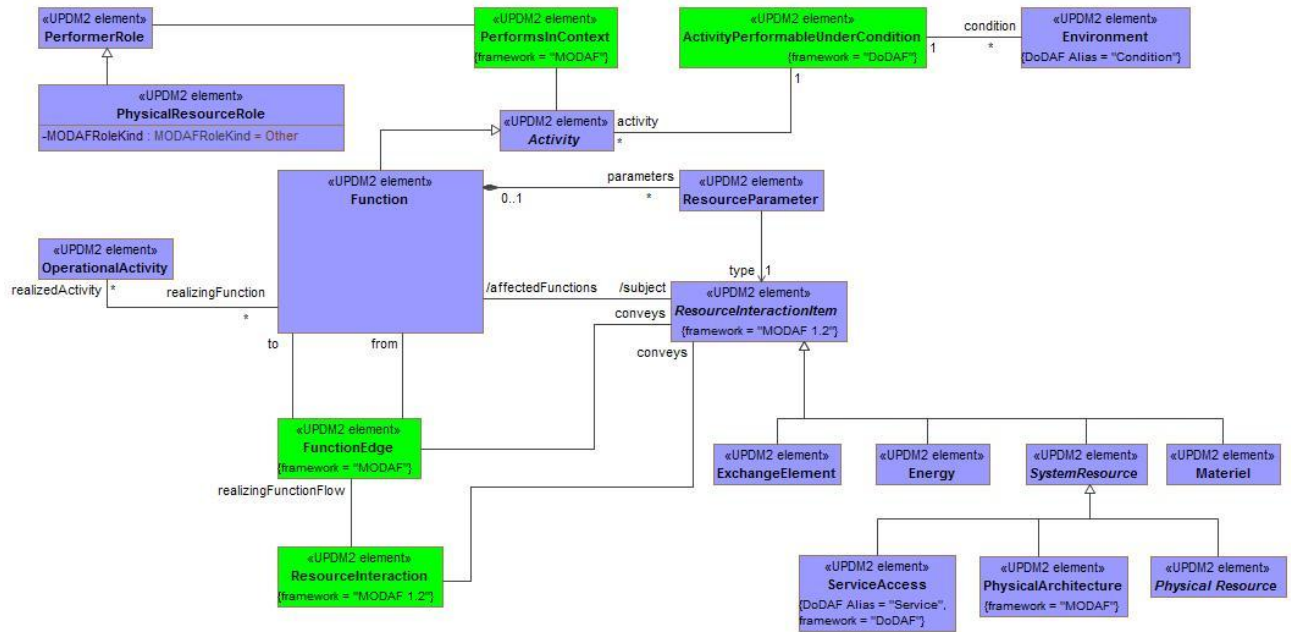

Figure A:38 - SV-4/SvcV-4 - DMM

A.1.6.10 SV-5/SvcV-5 - DMM

MODAF: SV-5 shows the Functions that implement the behavior of the OperationalActivities.
 DoDAF: SV-5/ScvV Shows the SystemFunctions and Service that implement the behavior of the OperationalActivities.

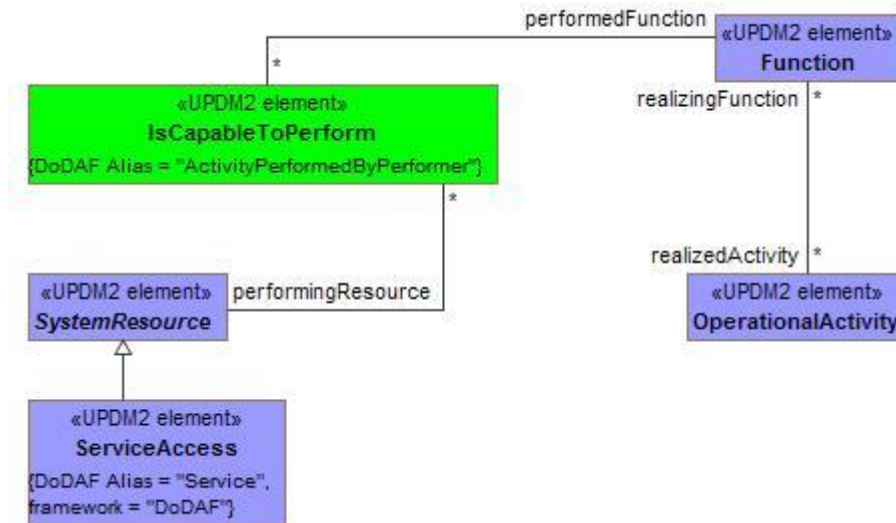

Figure A:39 - SV-5/SvcV-5 - DMM

A.1.6.11 SV-6/SvcV-6 - DMM

MODAF: The Systems Data Exchange Matrix specifies the characteristics of the system data exchanged between systems. The focus is on data crossing the system boundary.
 DoDAF: The Systems Resource Flow Exchange Matrix DoDAF-described View specifies the characteristics of the system resource flows exchanged between systems. The focus is on resource crossing the system boundary.

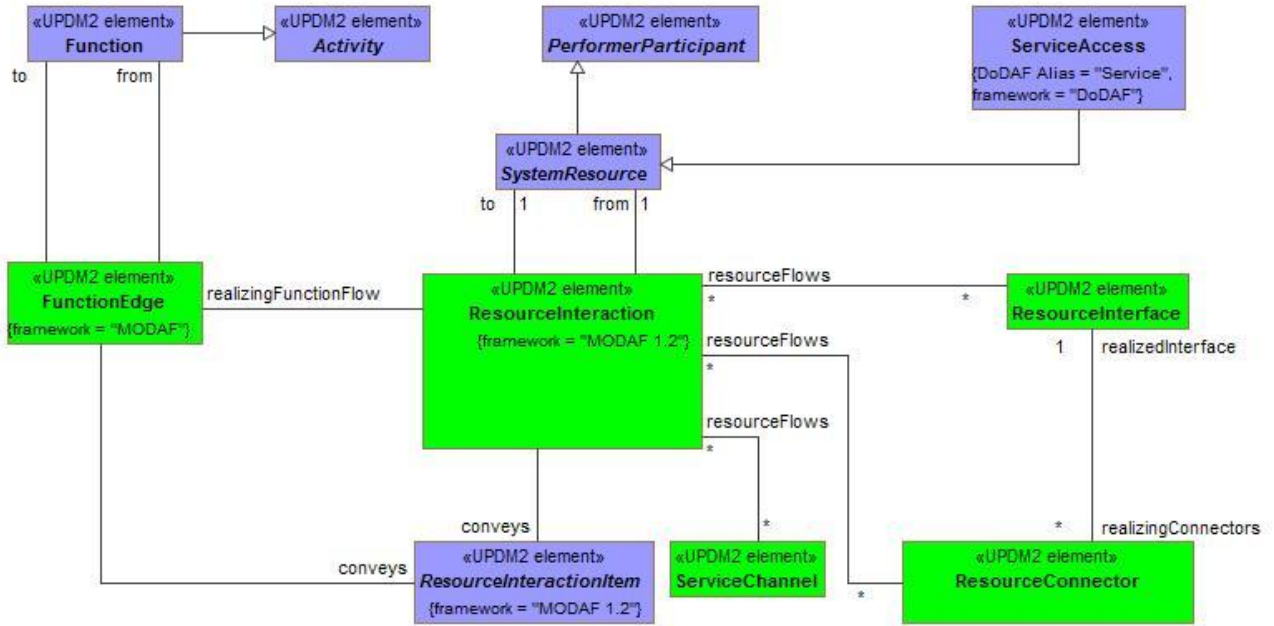

Figure A:40 - SV-6/SvcV-6 - DMM

A.1.6.12 SV-7/SvcV-7 - DMM

MODAF: The SV-7 is the Resource Performance Parameters Matrix and depicts the performance characteristics of a Resource (e.g., system, role, or capability configuration).

DoDAF: The SV-7 DoDAF-described View is the Systems Measures Matrix and depicts the measures (metrics) of resources.

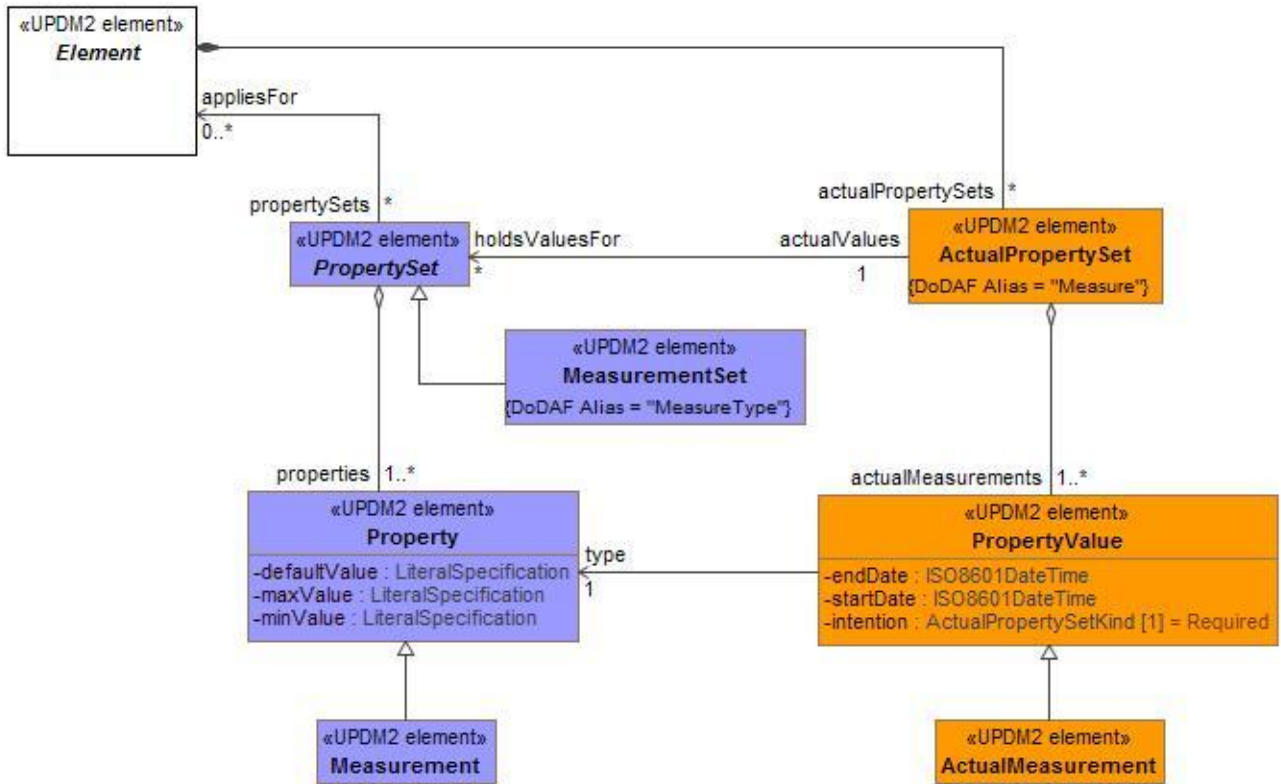

Figure A:41 - SV-7/SvcV-7 - DMM

A.1.6.13 SV-8/SvcV-8 - DMM

MODAF: The SV-8 provides an overview of how a capability configuration structure changes over time. It shows the structure of several capability configurations mapped against a timeline.
 DoDAF: The Systems Evolution Description DoDAF-described View presents a whole lifecycle view of resources (systems), describing how it changes over time. It shows the structure of several resources mapped against a timeline.

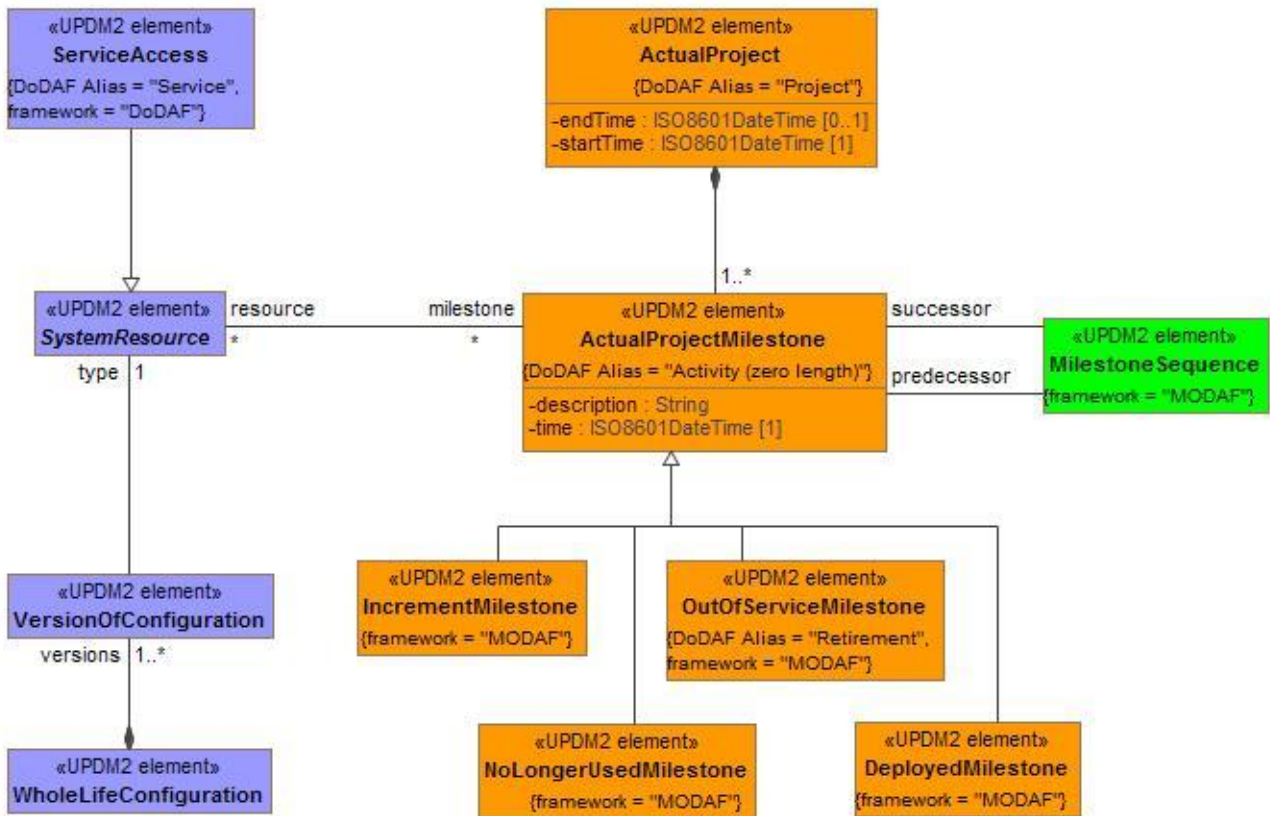

Figure A:42 - SV-8/SvcV-8 - DMM

A.1.6.14 SV-9/SvcV-9 - DMM

MODAF: The Technology & Skills Forecast defines the underlying current and expected supporting technologies and skills. Expected supporting technologies and skills are those that can be reasonably forecast given the current state of technology and skills, and expected improvements / trends. New technologies and skills will be tied to specific time periods, which can correlate against the time periods used in SV-8 milestones and linked to Enterprise Phases.

DoDAF: The Technology & Skills Forecast defines the underlying current and expected supporting technologies and skills. Expected supporting technologies and skills are those that can be reasonably forecast given the current state of technology and skills, and expected improvements / trends. New technologies and skills will be tied to specific time periods, which can correlate against the time periods used in SV-8 milestones and linked to Enterprise Phases.

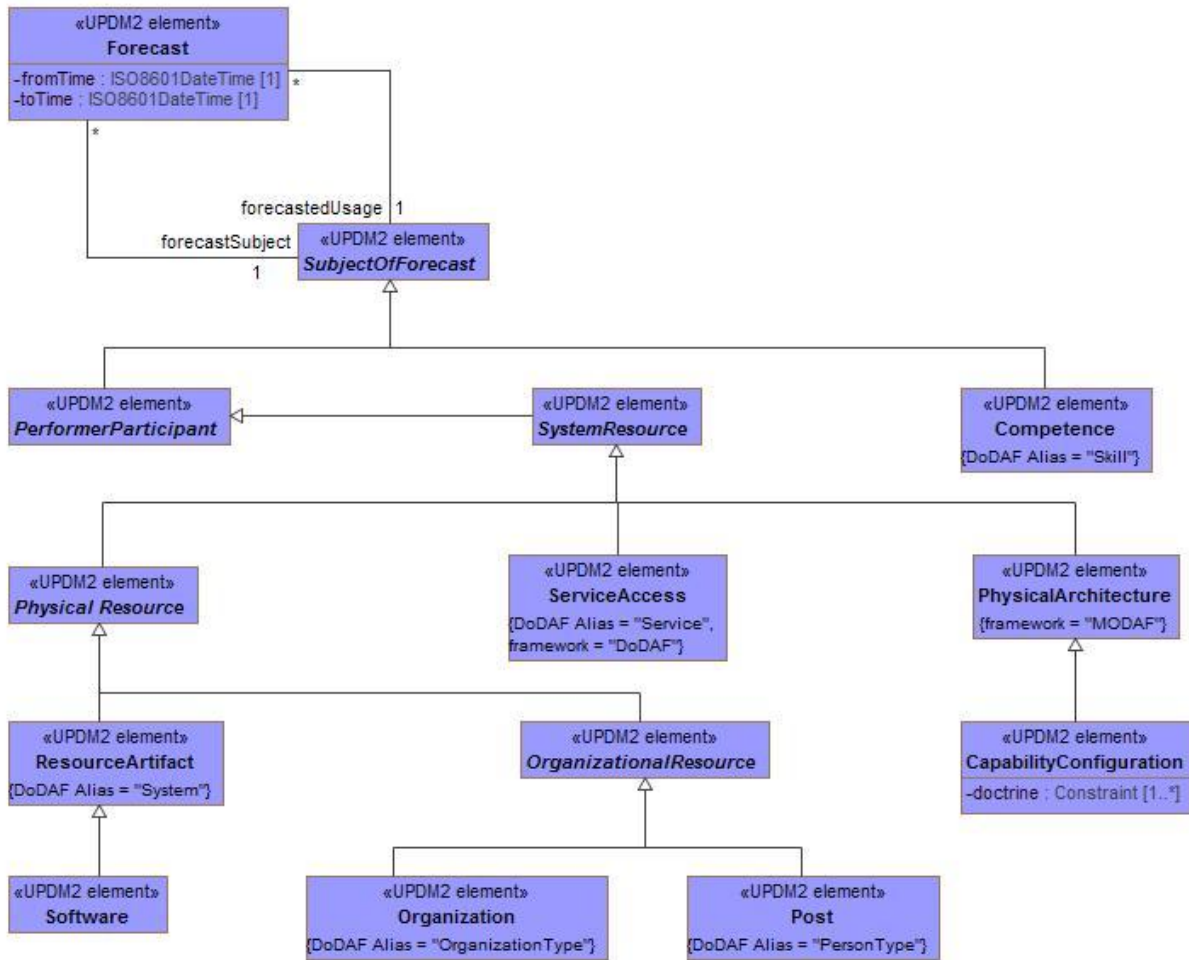

Figure A:43 - SV-9/SvcV-9 - DMM

A.1.7 TV/StdV

The Technical View is a set of products delineating standards, rules, notations, and conventions that apply to the implementation of the system architecture. When the standards profile is tied to the system elements to which they apply, TV-1 serves as the bridge between the SV and TV. SV-9 forecasts relate to the TV-1 in that a timed technology forecast may contribute to the decision to retire or phase out the use of a certain standard in connection with a system element. Similarly, SV-9 forecasts relate to TV-2 standards forecasts in that a certain standard may be adopted depending on a certain technology becoming available (e.g., the availability of Java Script may influence the decision to adopt a new HTML standard).

MODAF extends the core DoDAF Technical Standards Views to include non-technical standards and policies applicable to the architecture such as operational doctrine, industry process standards, etc. Additionally, the TV-1 may also document policies and standards applicable to the operational or business context. MoDAF also distinguishes between ‘applicability’ and ‘conformance’ with regard to architectural elements. If a standard is applicable to a given architecture, that architecture need not be fully conformant with the standard. The degree of conformance to a given standard may be judged on a risk basis at an approval point. An association between a Standard and an architectural element is not to be interpreted as stating the level of compliance of the element is fully compliant with that Standard. Additional evidences would need to be given (outside MODAF) to confirm the level of compliance. Finally, MoDAF adds the explicit requirement that any Standards cited in TV-1 View must, where appropriate, be in accordance with the trend towards open architectures – i.e., standards which encourage stove-piped systems are expressly prohibited.

A.1.7.1 TV-1&2&3/StdV-1&2 - DMM

MODAF: Standards Profile (TV-1) defines the technical and non-technical standards, guidance, and policy applicable to the architecture.

The Standards Forecast (TV-2) contains expected changes in technology-related standards and conventions, which are documented in the TV-1 Product.

DoDAF: The Standards Profile StdV-1 DoDAF-described View defines the technical, operational, and business standards, guidance, and policy applicable to the architecture.

The StdV-2 Standards Forecast DoDAF-described View contains expected changes in technology related standards, operational standards, or business standards and conventions, which are documented in the StdV-1 view.

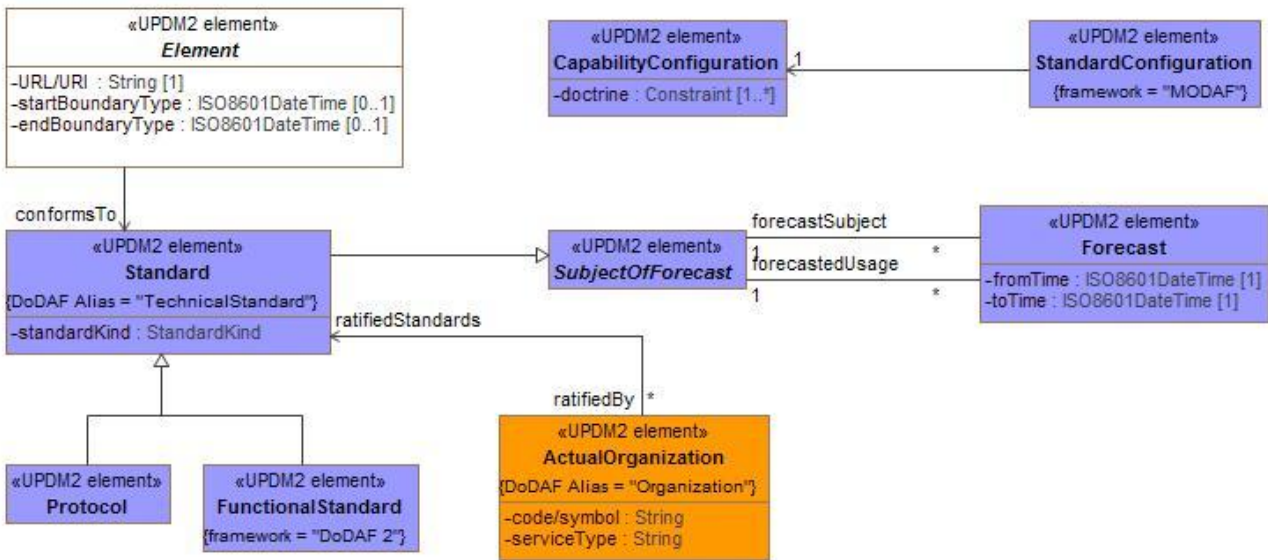

Figure A:44 - TV-1&2&3/StdV-1&2 - DMM

A.2 SOPES

This sub clause shows the UPDM elements and relationships that are used to represent the SOPES metamodel in UPDM.

A.2.1 SOPES - DMM

The SOPES diagram shows the UPDM elements and the relationships that map to the concepts of the SOPES Metamodel.

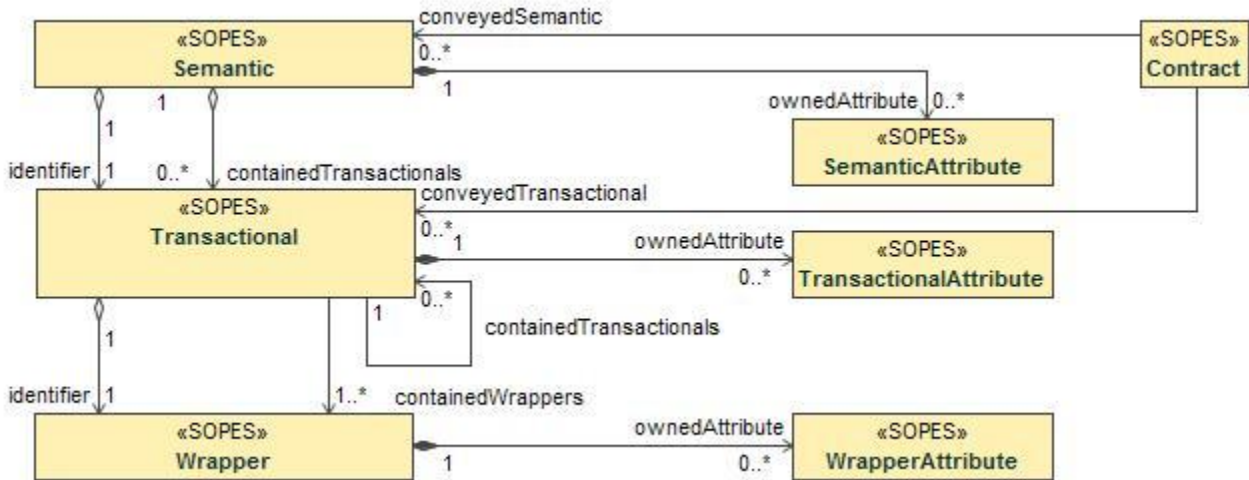

Figure A:45 - SOPES - DMM

A.3 SwAF

This sub clause shows the UPDM elements and relationships that are used to represent the Design Rules metamodel from NISP as submitted by Swedish Armed Forces (SWAF).

A.3.1 Design Rule - DMM

The Design Rule diagram shows the UPDM elements and the relationships that map to the concepts of the Design Rules metamodel from NISP as submitted by Swedish Armed Forces (SWAF).

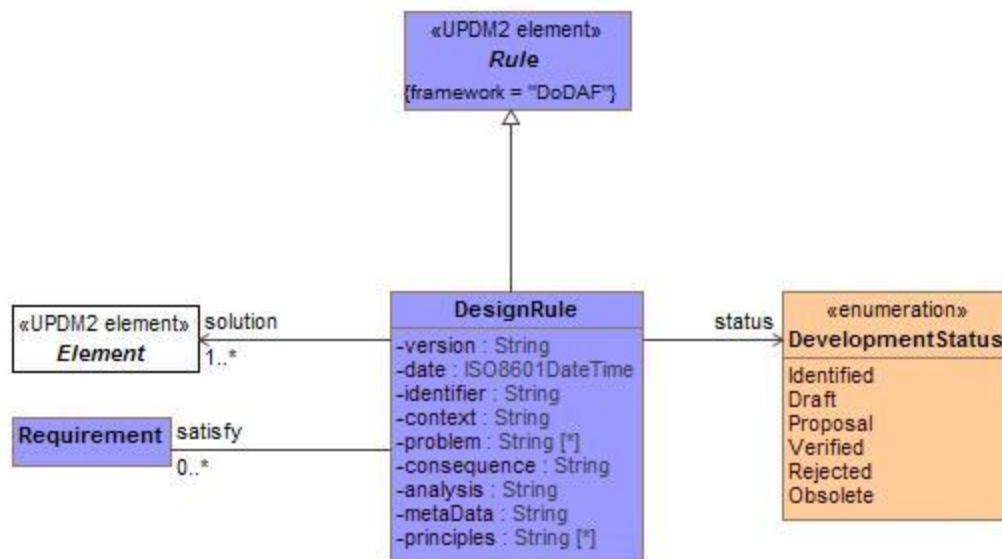

Figure A:46 - Design Rule - DMM

A.4 DM2

The DM2 sub clause gathers together UPDM Domain Meta Model elements and relationships into the same groupings as detailed in the DoDAF 2.0.2 metamodel.

A.4.1 Activity - DM2

The Activity diagram shows the UPDM elements and the relationships that map to the concepts of Activity from the DoDAF 2.0.2 Metamodel.

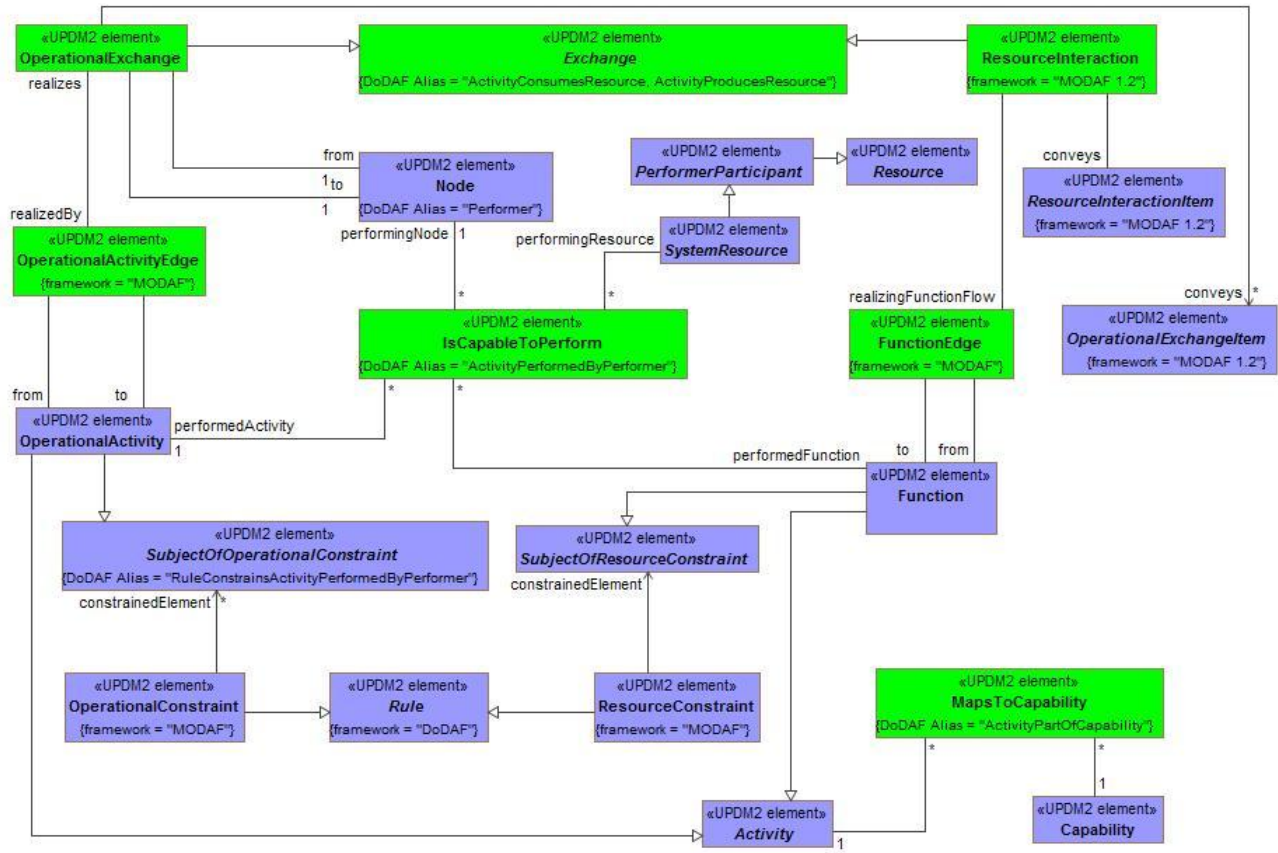

Figure A:47 - Activity - DM2

A.4.2 Capability - DM2

The Capability diagram shows the UPDM elements and the relationships that map to the concepts of Capability from the DoDAF 2.0.2 Metamodel.

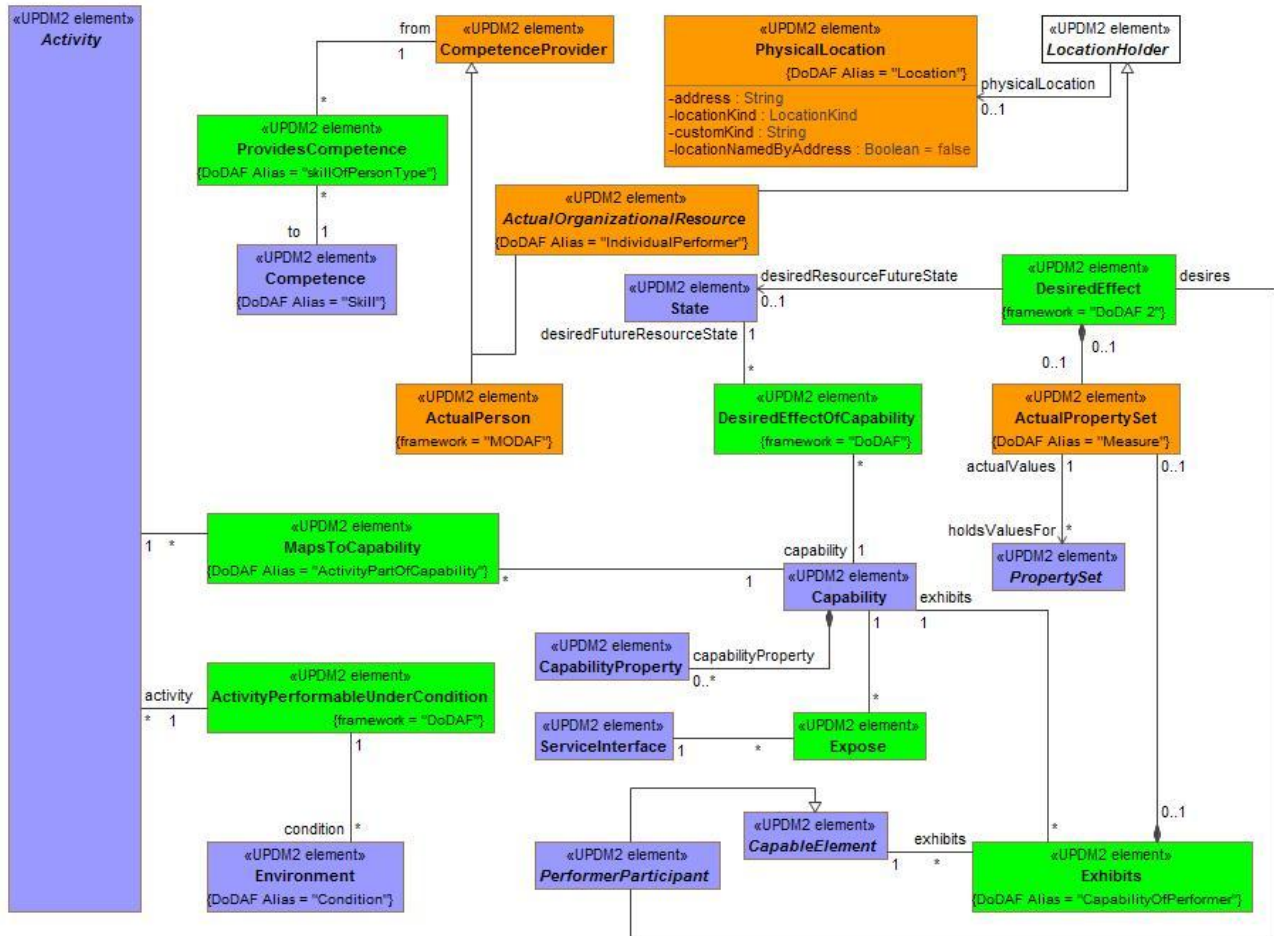

Figure A:48 - Capability - DM2

A.4.3 Goals - DM2

The Goals diagram shows the UPDM elements and the relationships that map to the concepts of Goals from the DoDAF 2.0.2 Metamodel.

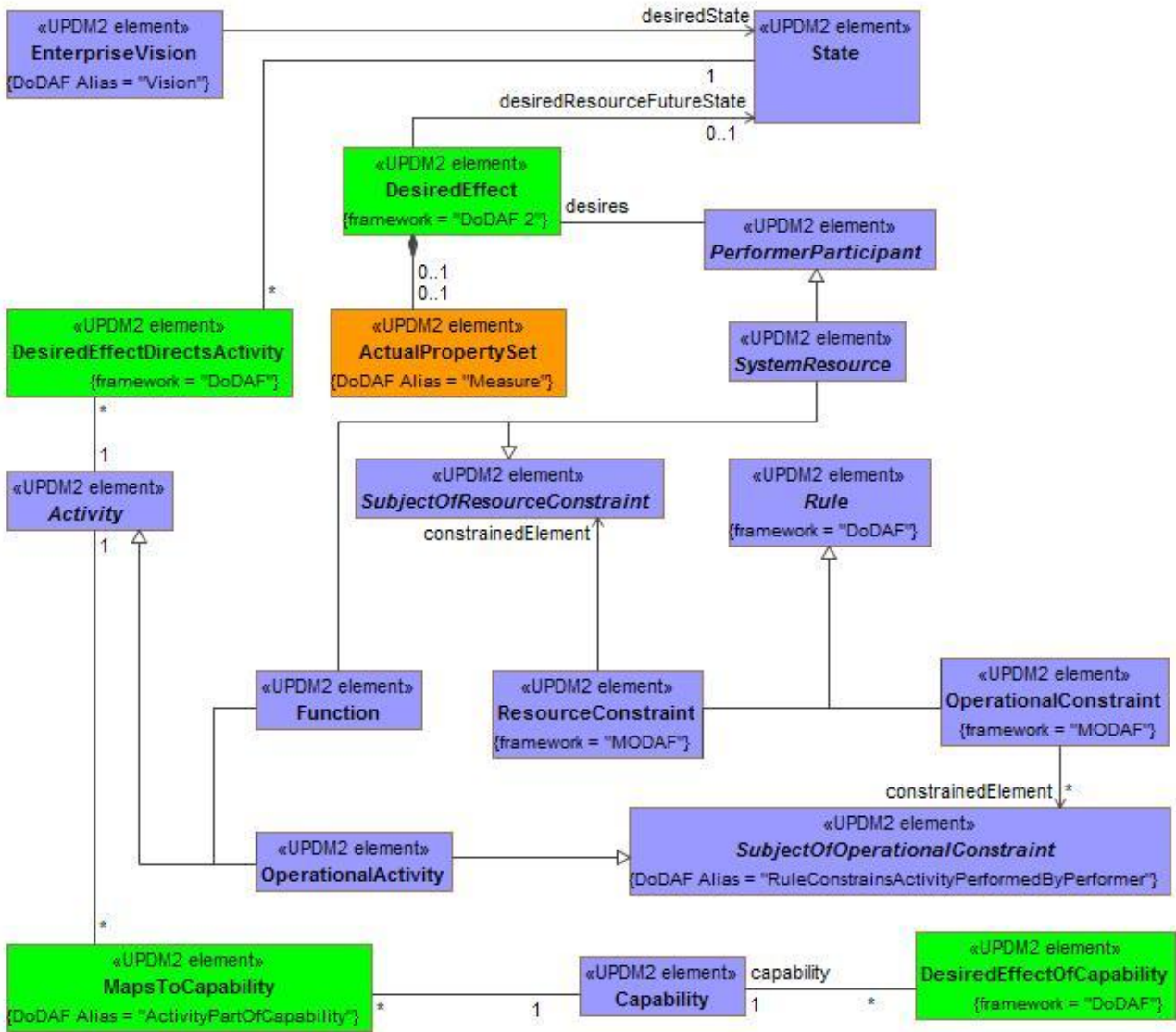

Figure A:49 - Goals - DM2

A.4.4 Information and Data - DM2

The Information and Data diagram shows the UPDM elements and the relationships that map to the concepts of Information and Data from the DoDAF 2.0.2 Metamodel.

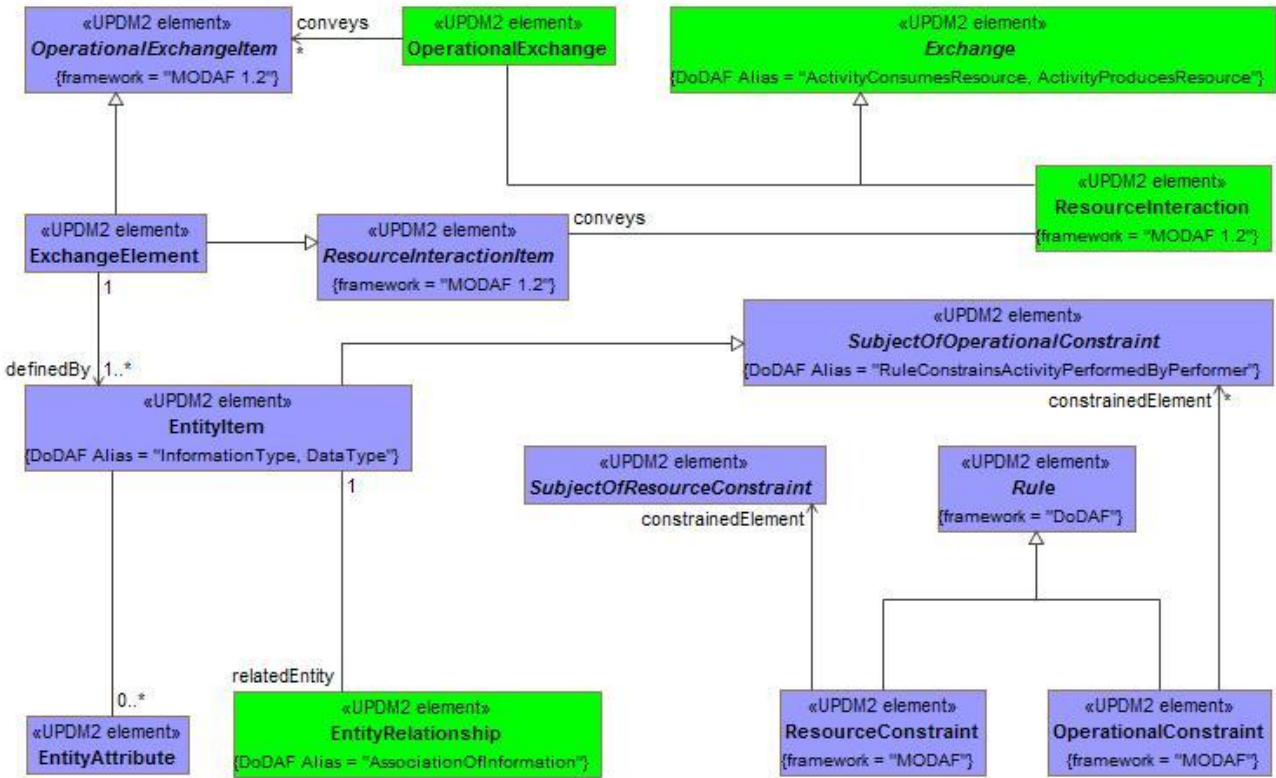

Figure A:50 - Information and Data - DM2

A.4.5 Information Pedigree - DM2

The Information Pedigree diagram shows the UPDM elements and the relationships that map to the concepts of Information Pedigree from the DoDAF 2.0.2 Metamodel.

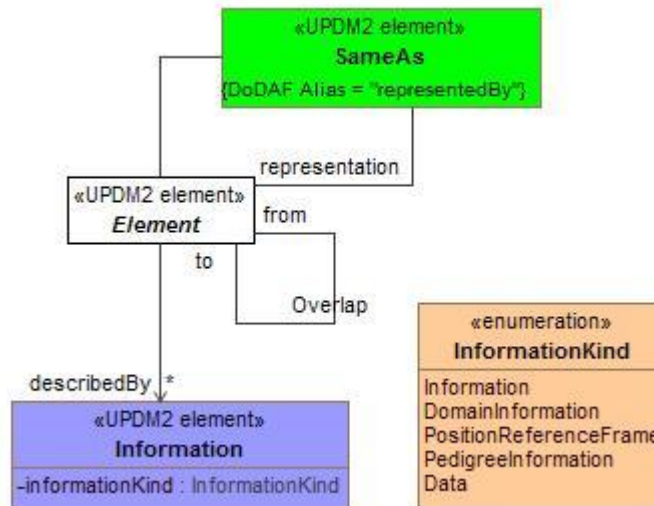

Figure A:51 - Information Pedigree - DM2

A.4.6 Location - DM2

The Location diagram shows the UPDM elements and the relationships that map to the concepts of Location from the DoDAF 2.0.2 Metamodel.

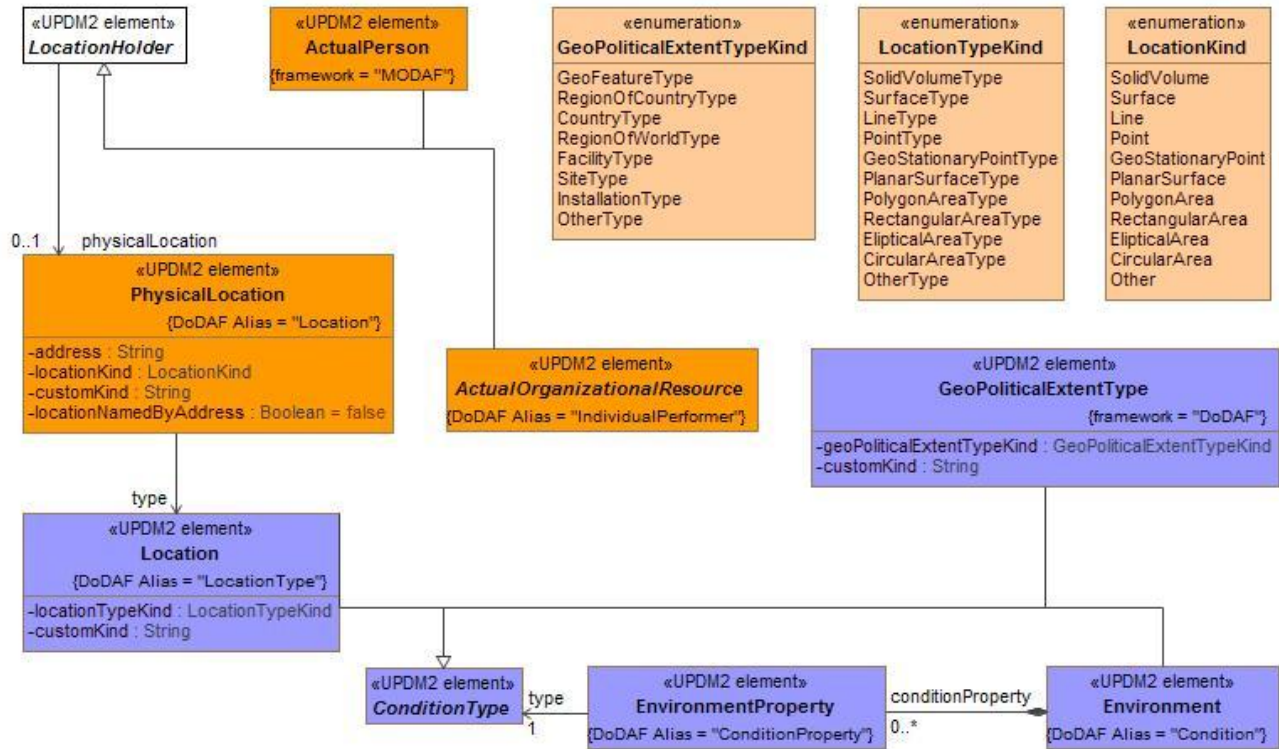

Figure A:52 - Location - DM2

A.4.7 Measure - DM2

The Measure diagram shows the UPDM elements and the relationships that map to the concepts of Measure from the DoDAF 2.0.2 Metamodel.

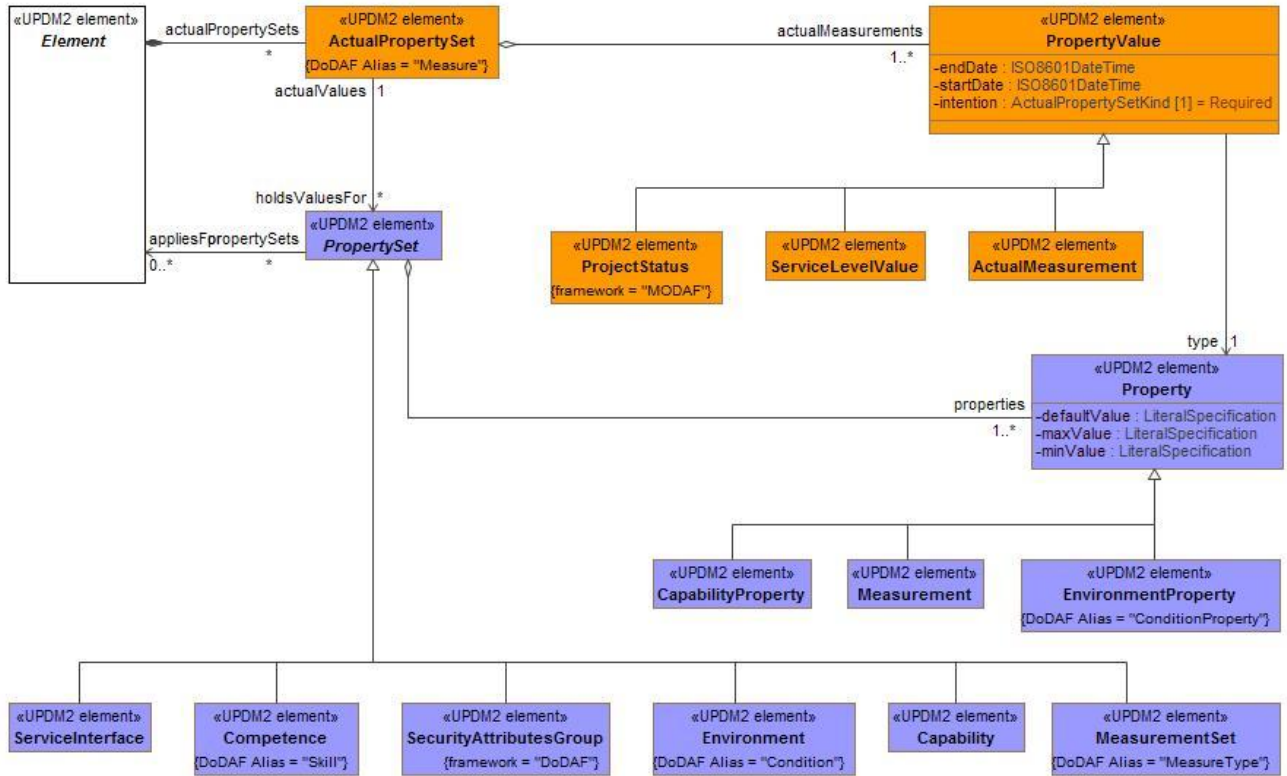

Figure A:53 - Measure - DM2

A.4.8 Organizational Structure - DM2

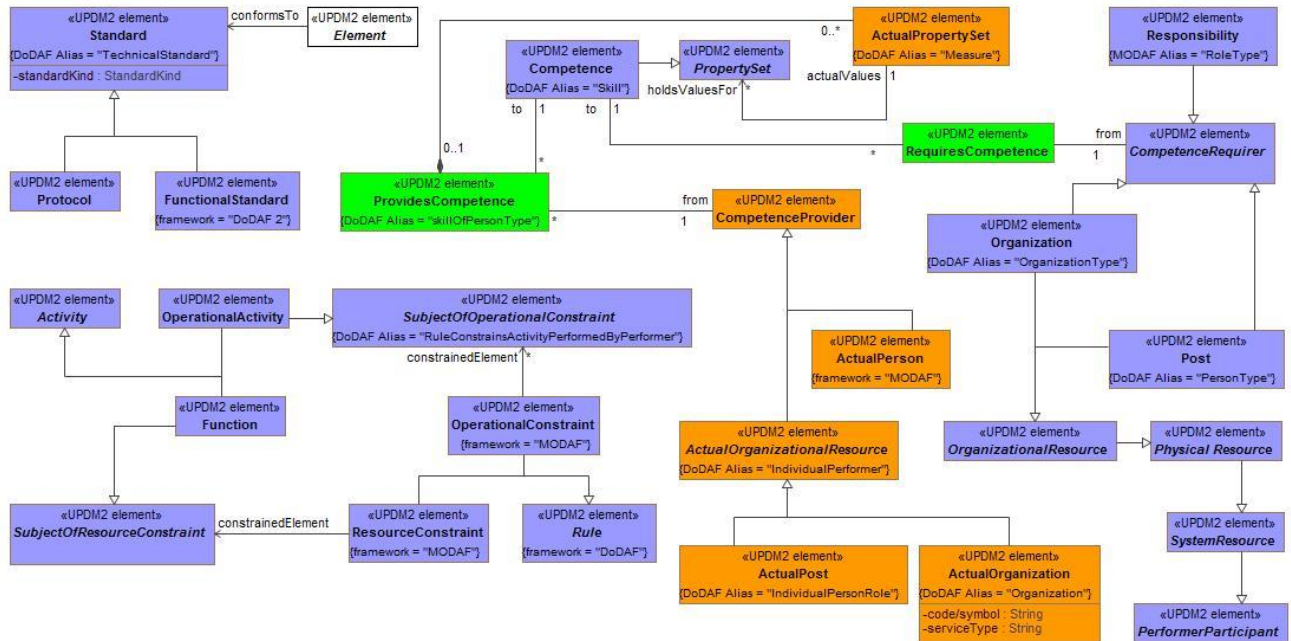

Figure A:54 - Organizational Structure - DM2

A.4.9 Performer - DM2

The Performer diagram shows the UPDM elements and the relationships that map to the concepts of Performer from the DoDAF 2.0.2 Metamodel.

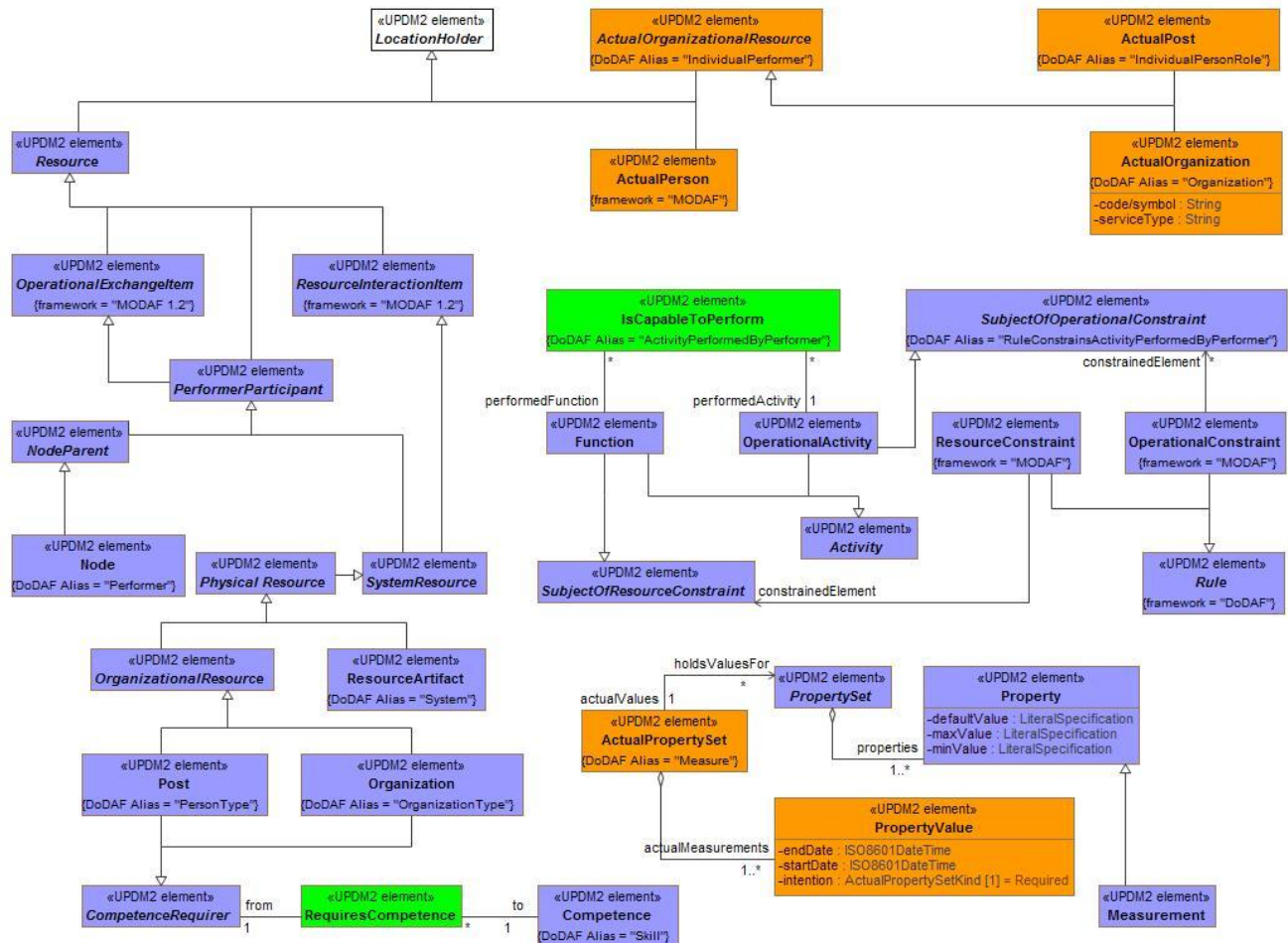

Figure A:55 - Performer - DM2

A.4.10 Project - DM2

The Project diagram shows the UPDM elements and the relationships that map to the concepts of Project from the DoDAF 2.0.2 Metamodel.

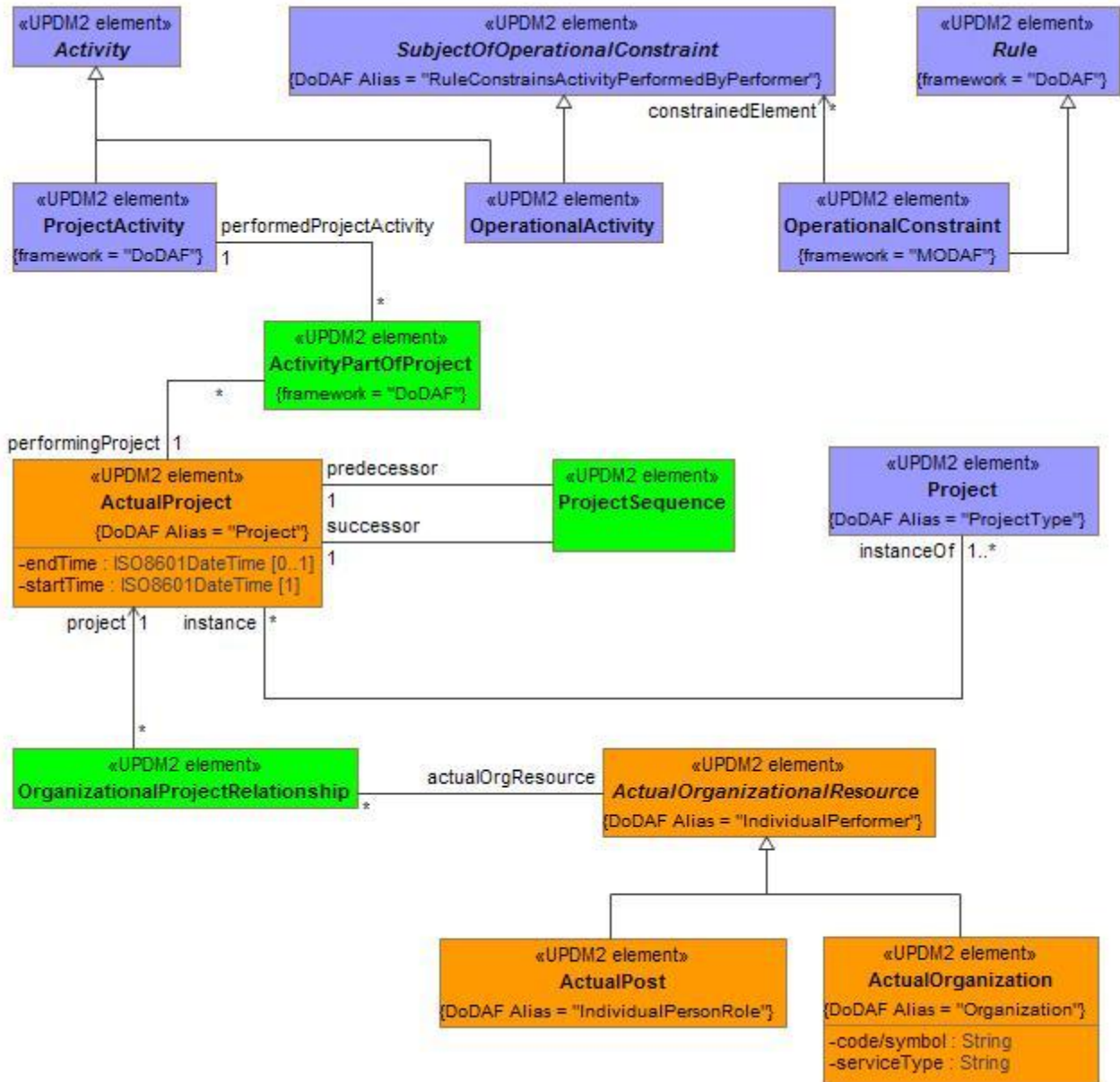

Figure A:56 - Project - DM2

A.4.11 Resource Flow - DM2

The Resource Flow diagram shows the UPDM elements and the relationships that map to the concepts of Resource Flow from the DoDAF 2.0.2 Metamodel.

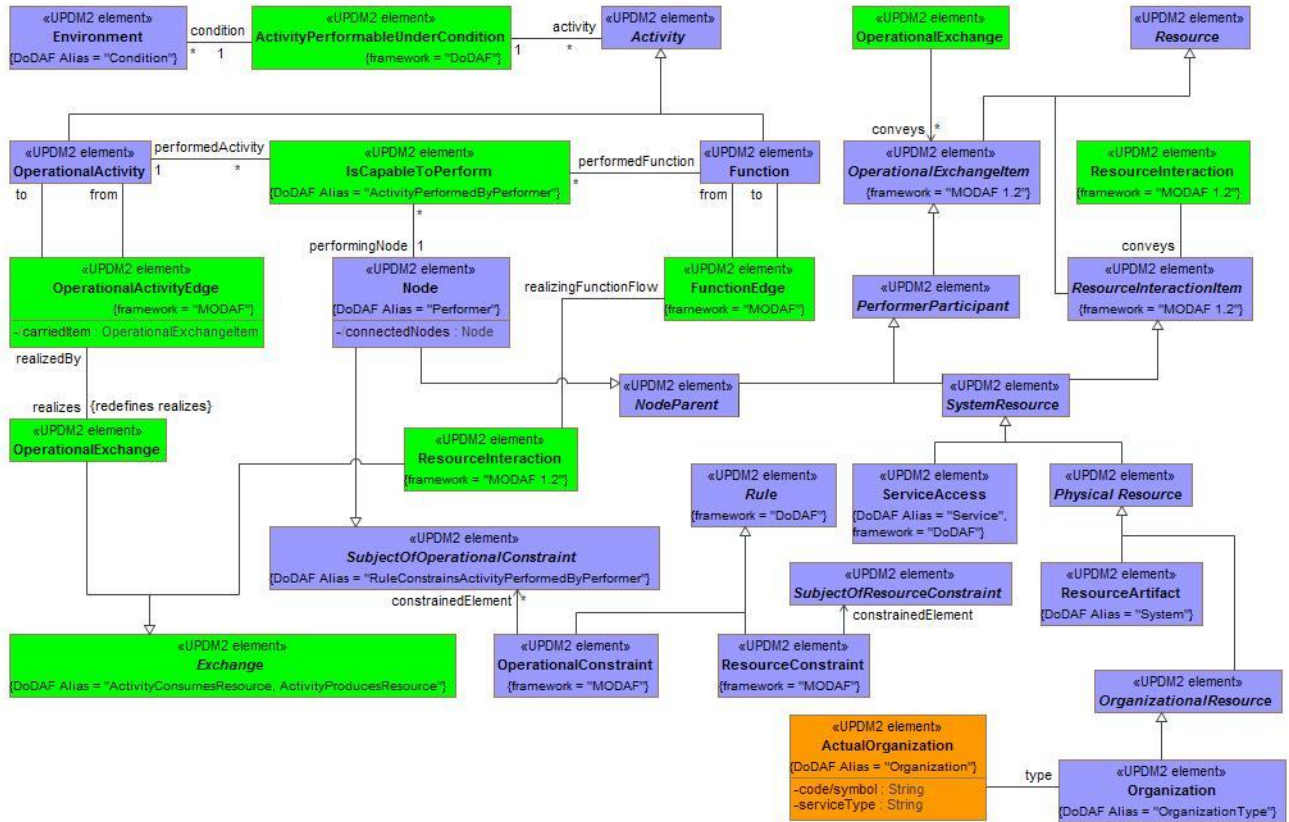

Figure A:57 - Resource Flow - DM2

A.4.12 Rules - DM2

The Rules diagram shows the UPDM elements and the relationships that map to the concepts of Rules from the DoDAF 2.0.2 Metamodel.

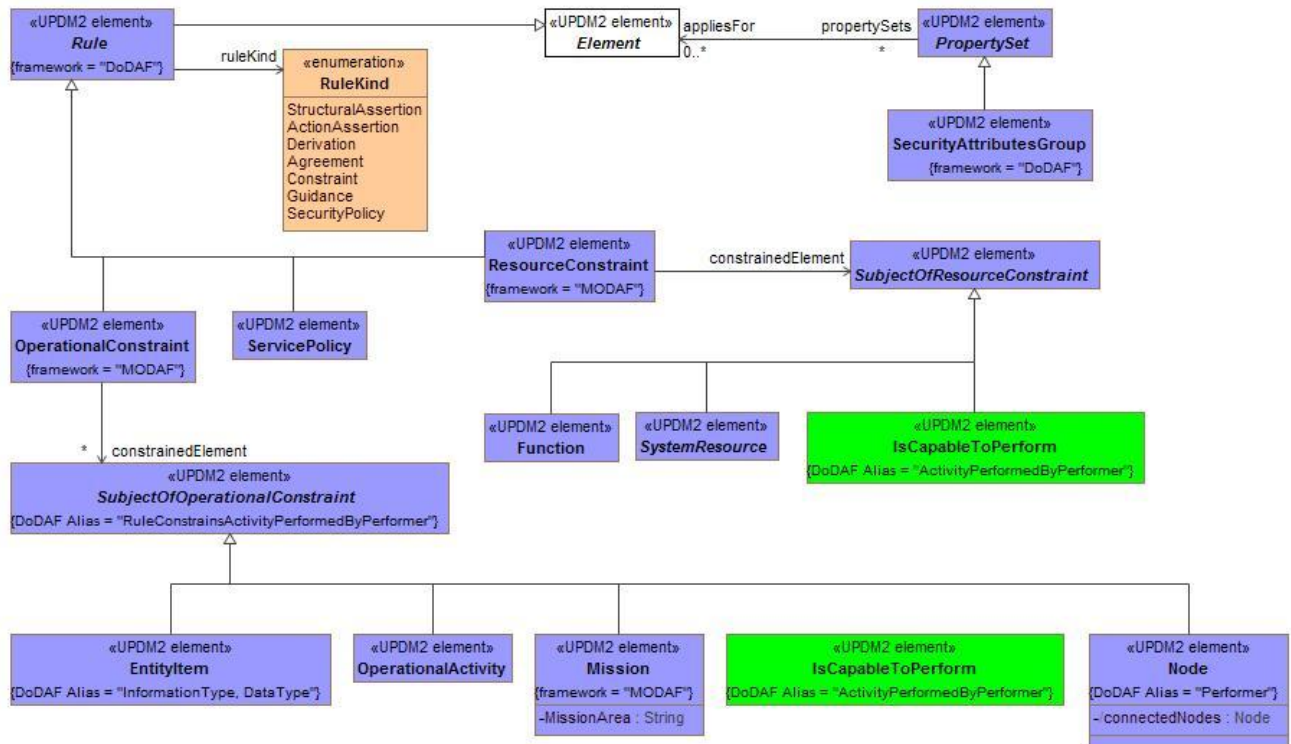

Figure A:58 - Rules - DM2

A.4.13 Services - DM2

The Services diagram shows the UPDM elements and the relationships that map to the concepts of Services from the DoDAF 2.0.2 Metamodel.

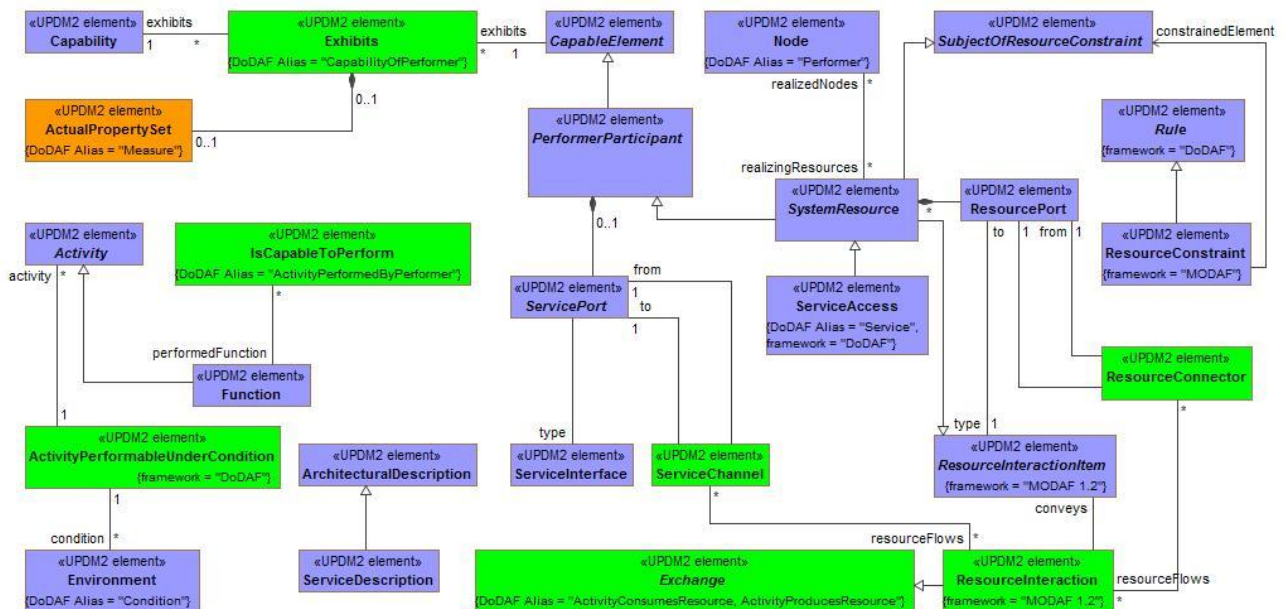

Figure A:59 - Services - DM2

Annex B UPDM Views (Profile)

This Annex is intended as non-normative guidance for developers and users as to what UPDM elements and relationships are applicable for each of the UPDM Views.

B.1 Products

MODAF: A connected and coherent set of Architectural Elements that conform to a View.

DoDAF Alias: View: DoDAF divides the problem space into manageable pieces, according to the stakeholder's Viewpoint, further defined in the framework as "Views."

B.1.1 AcV/PV

MODAF: The Acquisition Views (AcVs) describe programmatic details, including dependencies between projects and capability integration across the all the DLODs. These Views guide the acquisition and fielding processes.

DoDAF: Project Views (PV) within the Project Viewpoint describe projects, how those projects deliver capabilities, the organizations contributing to the projects and dependencies between projects.

B.1.1.1 AcV-1/PV-1

MODAF: AcV-1 view products represent an organizational perspective on projects.

DoDAF: AcV-1 view [DoDAF::Project Portfolio Relationships (PV-1) DoDAF-described View] represents an organizational perspective on programs, projects, or a portfolio of projects.

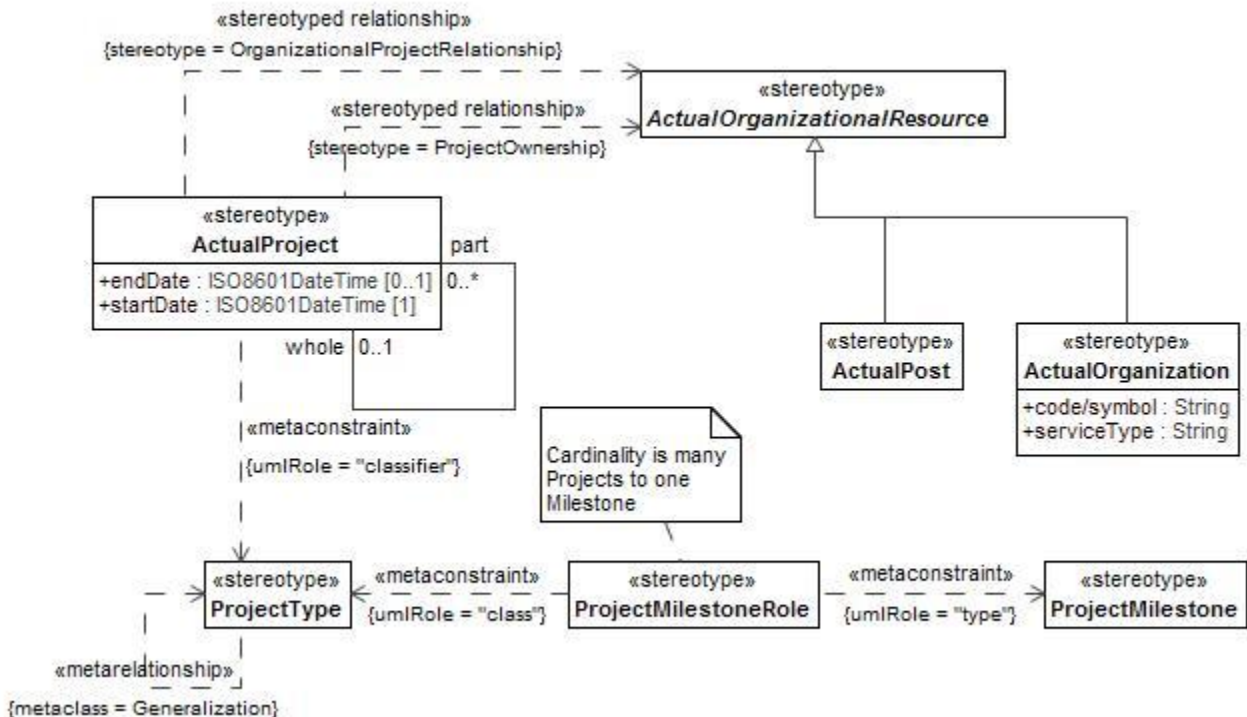

Figure B:1 - AcV-1/PV-1

B.1.1.2 AcV-2/PV-2

MODAF: AcV-2 view products provide a timeline perspective on projects.

DoDAF: AcV-2 (DoDAF::PV-2: Project Timelines DoDAF-described View) provides a timeline perspective on

programs or projects.

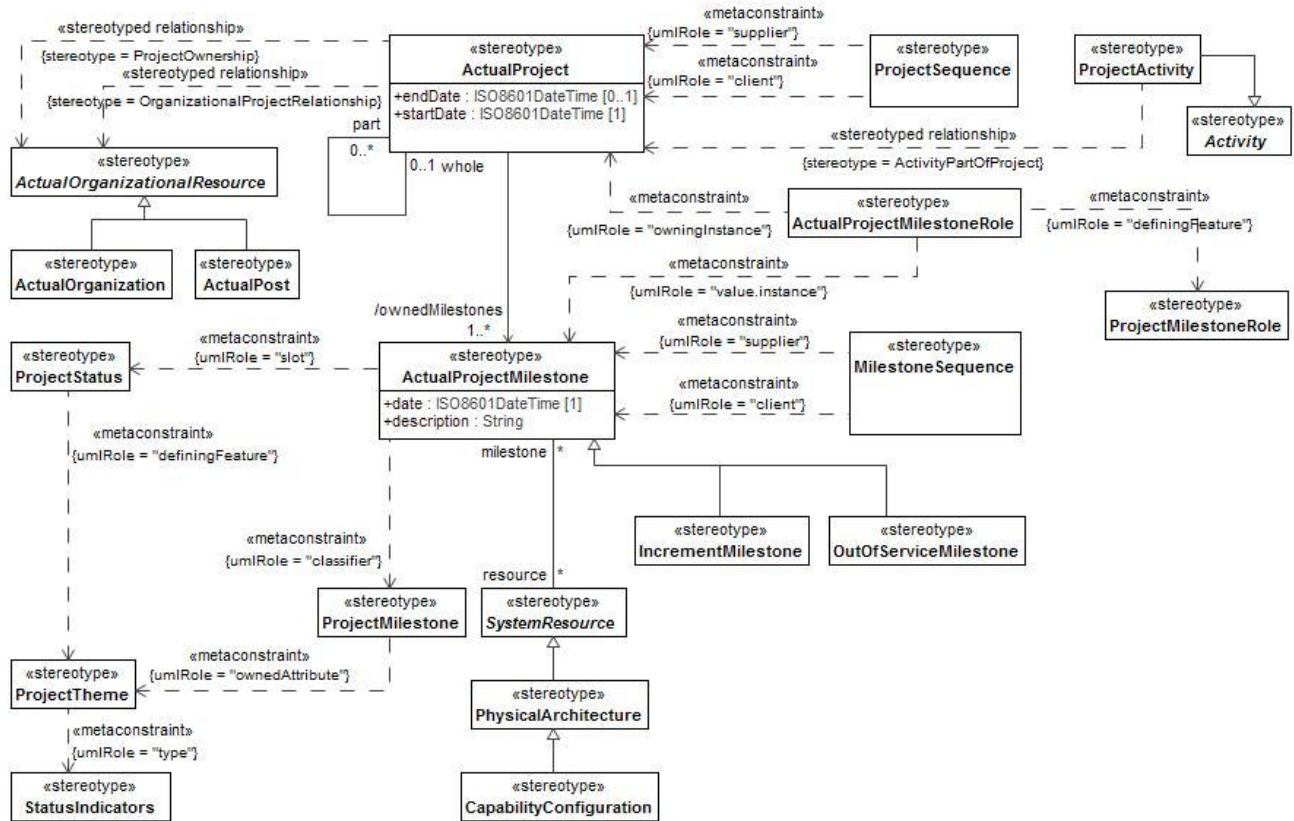

Figure B:2 - AcV-2/PV-2

B.1.1.3 PV-3

MODAF: NA

DoDAF: PV-3 diagram indicates the Capabilities that are realized by a particular project.

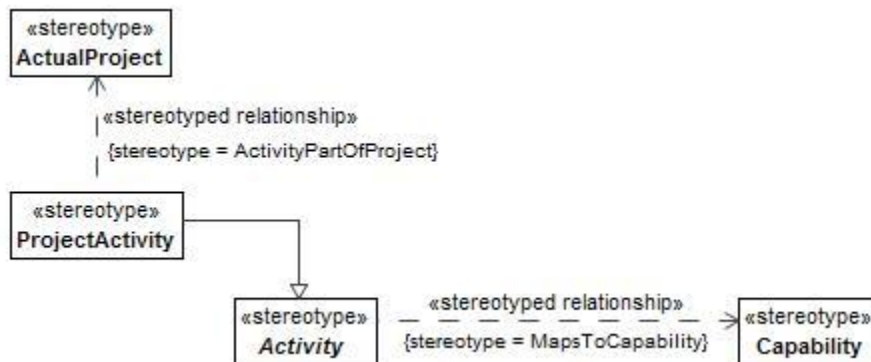

Figure B:3 - PV-3

B.1.2 AV

MODAF: All View products provide information pertinent to the entire Architecture. They present supporting information rather than architectural models.

DoDAF: There are some overarching aspects of an architecture that relate to the entire architecture being developed.

These overarching aspects are captured in the All Viewpoint (AV) DoDAF-described views.

B.1.2.1 AV-1

MODAF: The overview and summary information contained within the AV-1 product provides executive-level summary information in a consistent form that allows quick reference and comparison between architectural descriptions. AV-1 includes assumptions, constraints, and limitations that may affect high-level decisions relating to an architecture-based work programme.

DoDAF: The overview and summary information contained within the AV-1 DoDAF-described View provides executive-level summary information in a consistent form that allows quick reference and comparison between architectural descriptions. The AV-1 includes assumptions, constraints, and limitations that may affect high-level decisions relating to an architecture-based work program.

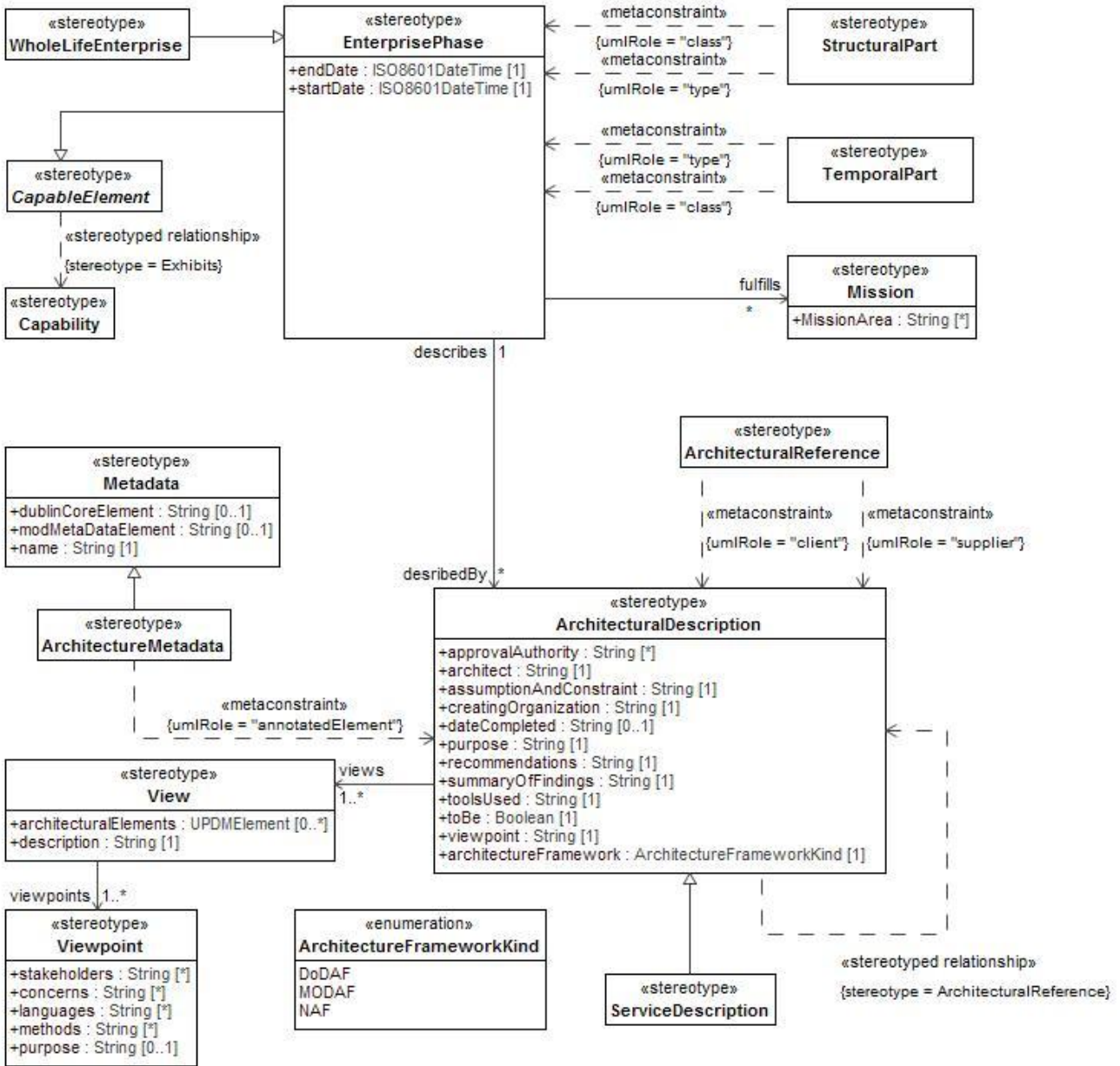

Figure B:4 - AV-1

B.1.2.2 AV-2

MODAF: AV-2 presents all the Elements used in an architecture as a stand alone structure. An AV-2 presents all the Elements as a specialization hierarchy, provides a text definition for each one, and references the source of the element (e.g., MODAF Ontology, IDEAS Model, local, etc.). An AV-2 shows elements from the MODAF Ontology that have been used in the architecture and new elements (i.e., not in the MODAF Ontology) that have been introduced by the architecture.

DoDAF: The AV-2 presents all the metadata used in an architecture as a standalone structure. An AV-2 presents all the metadata as a specialization hierarchy, provides a text definition for each one, and references the source of the element (e.g., DoDAF Meta-model, IDEAS, a published document or policy). An AV-2 shows elements from the DoDAF Meta-model that have been used in the architecture and new elements (i.e., not in the DoDAF Meta-model) that have been introduced by the architecture.

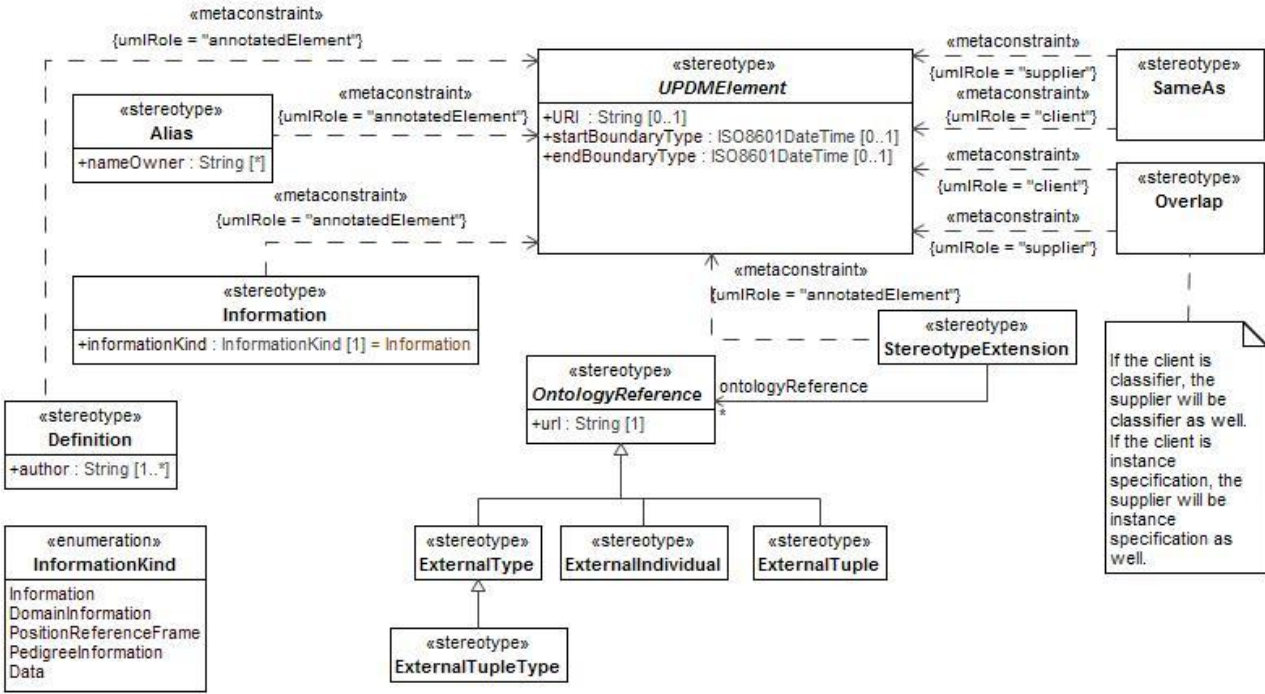

Figure B:5 - AV-2

B.1.2.3 Environment Elements

The Environments diagram shows the elements and relationships that are involved in defining the environments applicable to capability, operational concept, or set of systems.

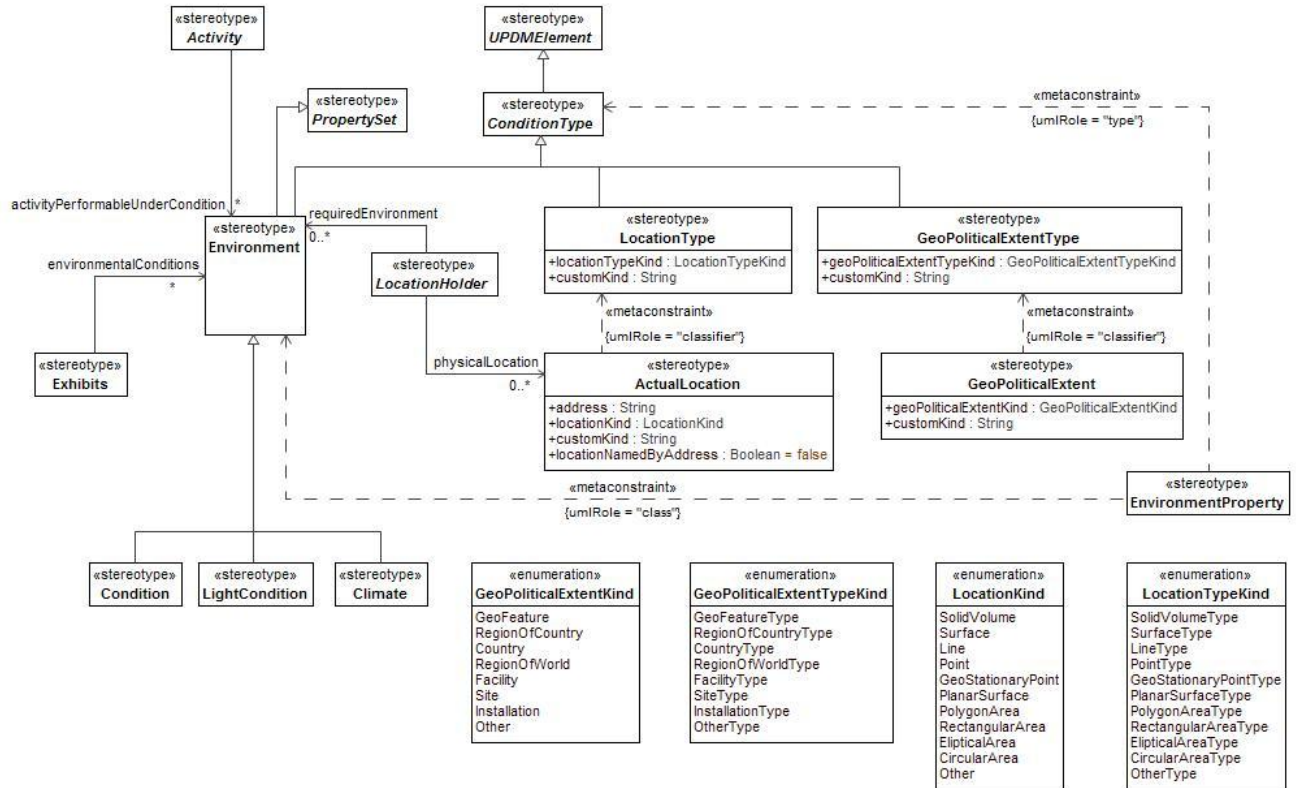

Figure B:6 - Environment Elements

B.1.2.4 Measurements

Shows the measurable properties of something in the physical world, expressed in amounts of a unit of measure that can be associated with a UPDMElement.

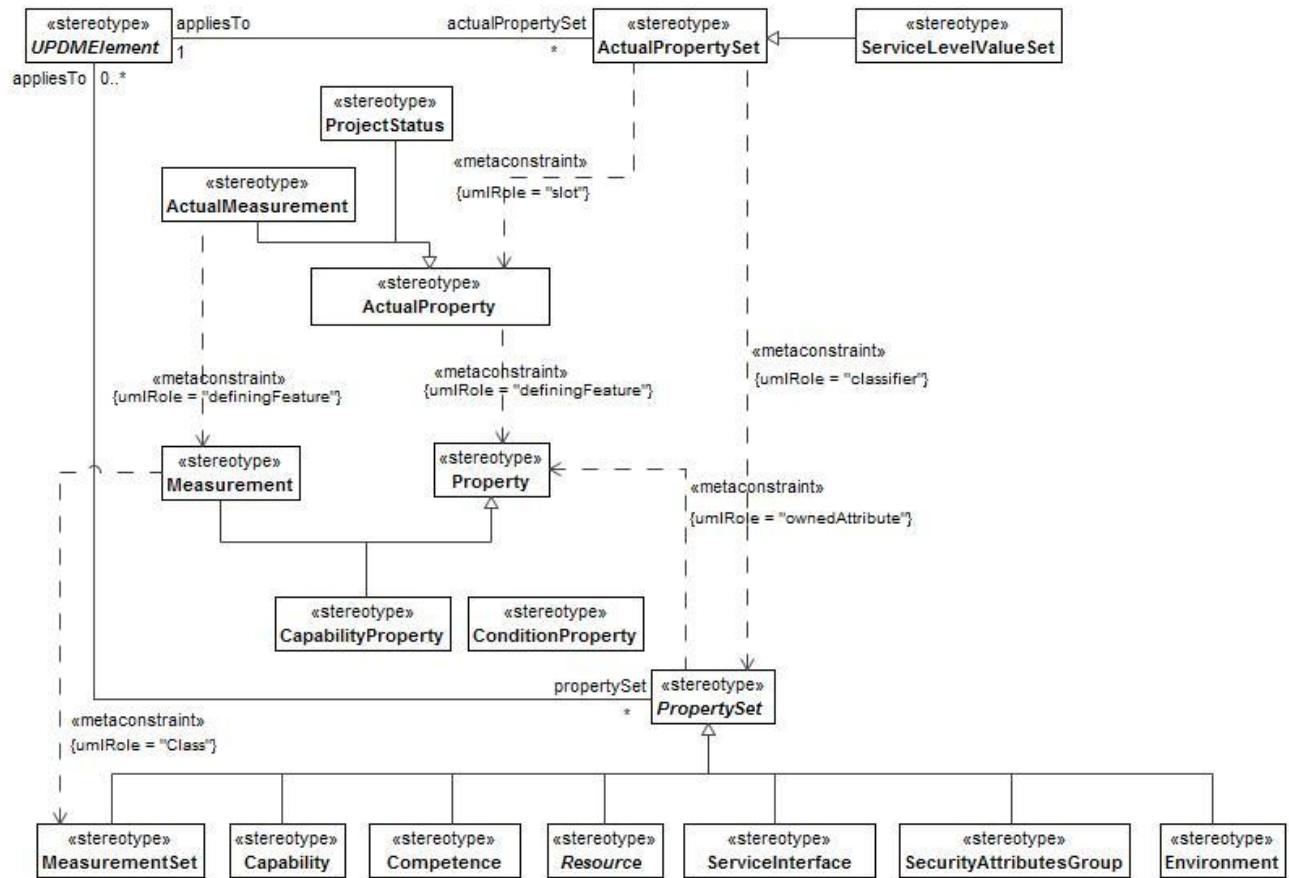

Figure B:7 - Measurements

B.1.3 OV

MODAF: Operational Views describe the tasks and activities, operational elements, and information exchanges required to conduct operations. In MODAF thinking, the OV Views are considered to illustrate the Logical Architecture of the enterprise.

DoDAF: Operational Views within the Operational Viewpoint describe the tasks and activities, operational elements, and resource flow exchanges required to conduct operations. A pure operational view is material independent.

B.1.3.1 OV-1

MODAF: OV-1 addresses the high level operational concepts related to one or more missions. An OV-1 describes a mission, class of mission, or scenario; and highlights the main operational elements and interesting or unique aspects of operations.

The OV-1 has two purposes. First, it provides a means of organizing the operational architecture models into distinct groups based on scenario context. Second, it communicates the essence of the scenario context in an essentially graphical form.

DoDAF: The OV-1 DoDAF-described View describes a mission, class of mission, or scenario. It shows the main operational concepts and interesting or unique aspects of operations. It describes the interactions between the subject architecture and its environment, and between the architecture and external systems. A textual description accompanying the graphic is crucial. Graphics alone are not sufficient for capturing the necessary architecture data.

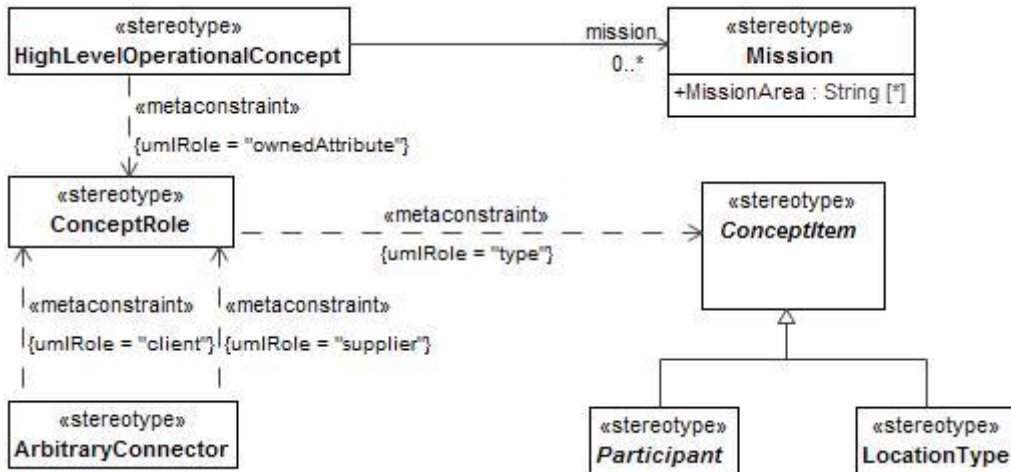

Figure B:8 - OV-1

B.1.3.2 OV-2

MODAF: The Operational Node Relationships Description (OV-2) addresses localization of operational capability.
 DoDAF: The Operational Resource Description (OV-2) DoDAF-described View applies the context of the operational capability to a community of anticipated users.

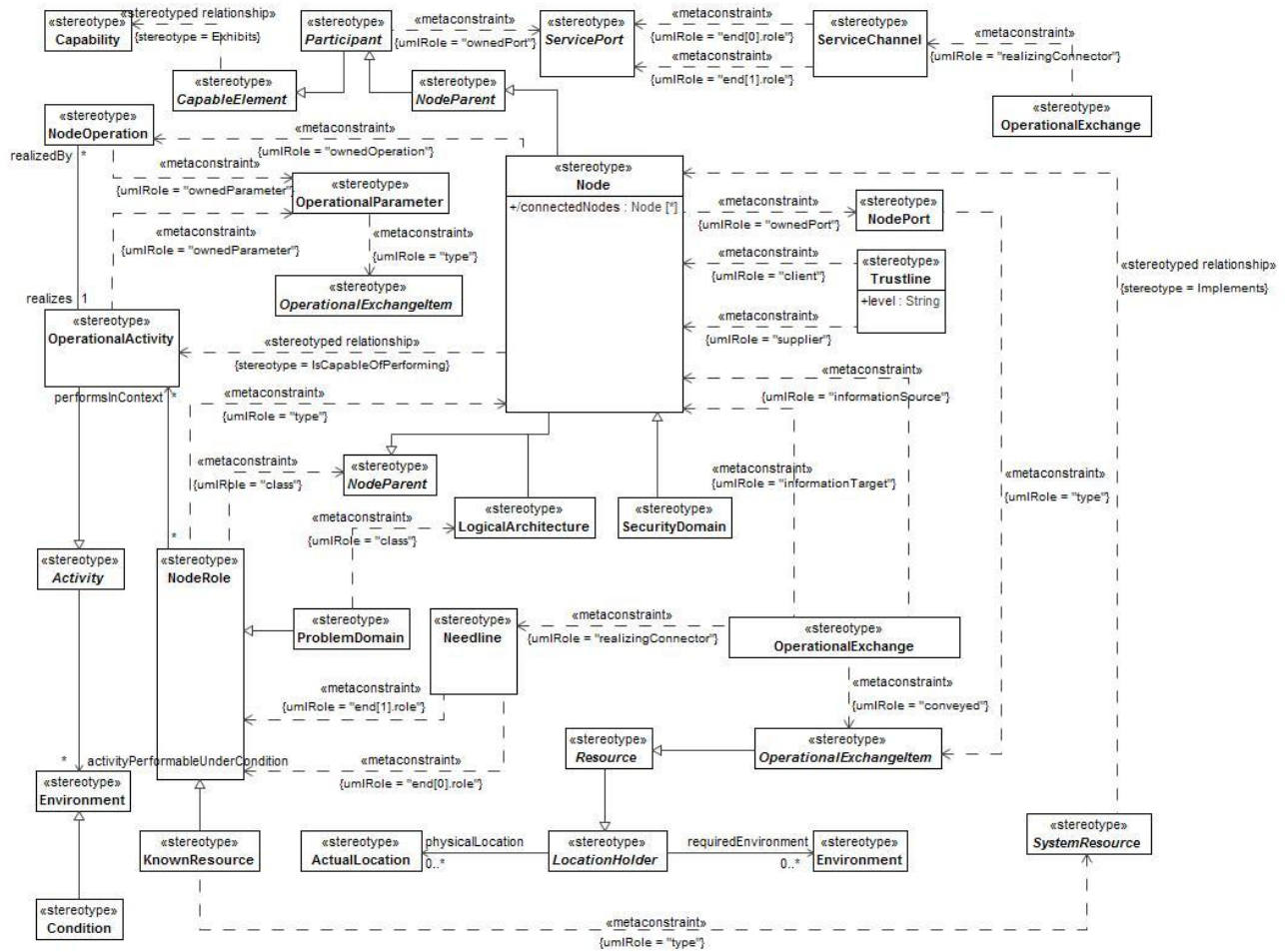

Figure B:9 - OV-2

B.1.3.3 OV-3

MODAF: The Operational Information Exchange Matrix (OV-3) addresses operational information exchanges between nodes.

DoDAF: The Operational Resource Flow Matrix (OV-3) DoDAF-described addresses operational resource flows exchanged between Operational Activities and locations.

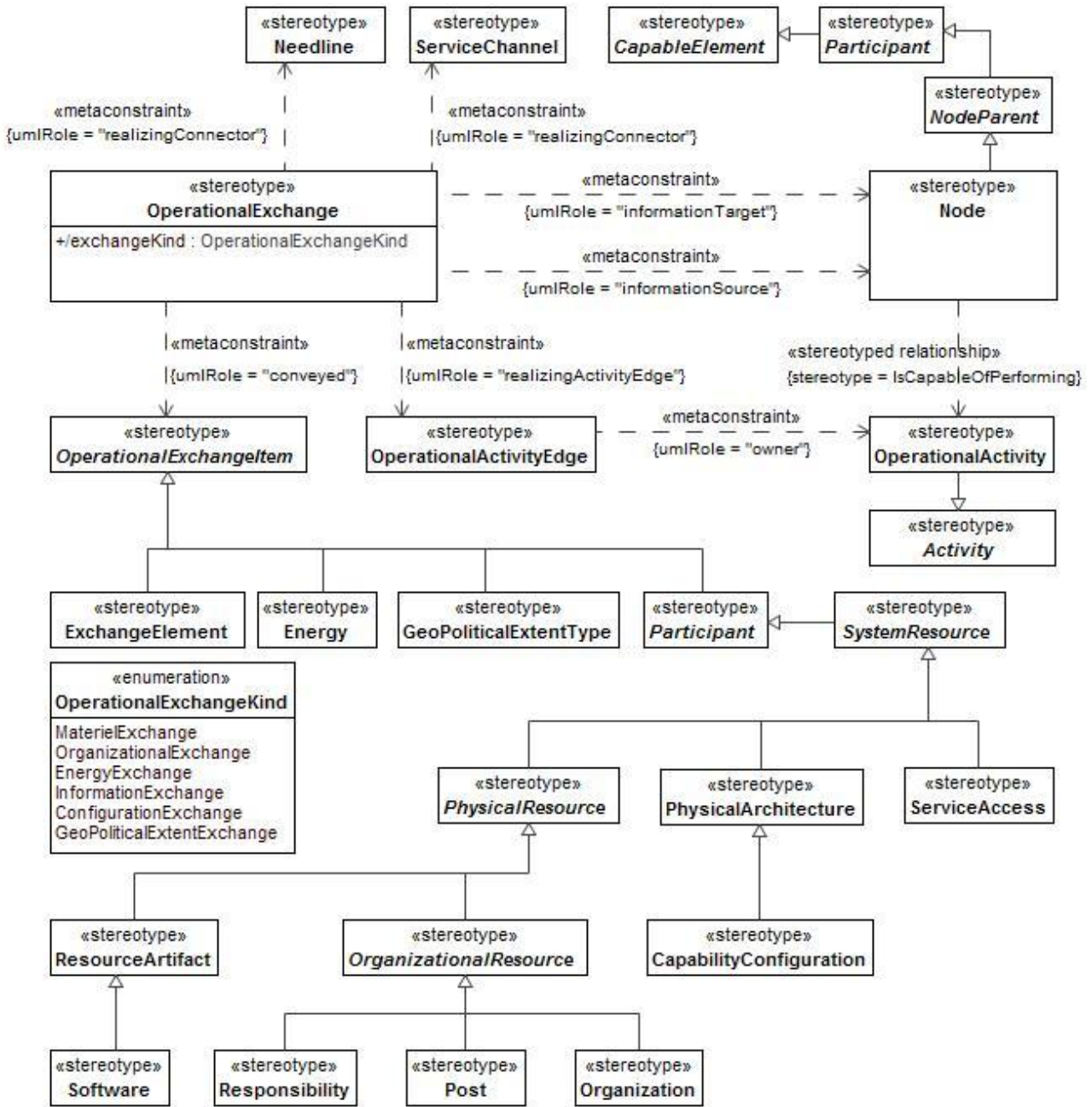

Figure B:10 - OV-3

B.1.3.4 OV-4 Actual

This is the OV-4 Actual View. The Organizational Relationships Chart illustrates the command structure or relationships (as opposed to relationships with respect to a business process flow) among human roles, organizations, or organization types that are the key players in architecture. MoDAF divides the OV-4 two views, an OV-4 Typical and an OV-4 Actual. The former is exactly as the DoDAF OV-4, while the latter is a special form of the SV-1; where the resources are restricted to being organizational.

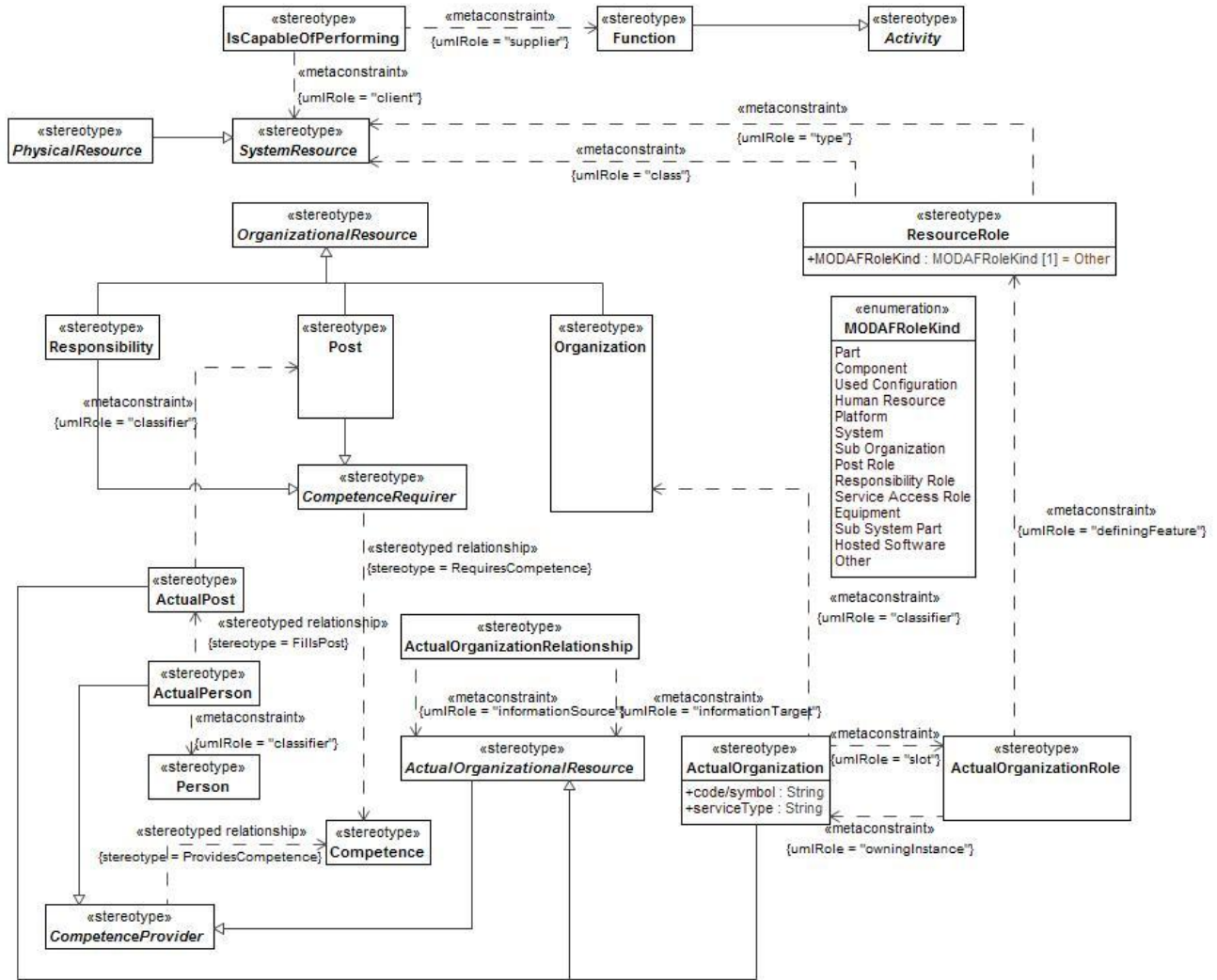

Figure B:11 - OV-4 Actual

B.1.3.5 OV-4 Typical

MODAF: The OV-4 shows organizational structures and interactions. The organizations shown may be civil or military. A typical OV-4 shows the possible relationships between organizational resources (organizations and posts).

DoDAF: DoDAF: The OV-4 DoDAF-described View shows organizational structures and interactions. The organizations shown may be civil or military. A typical OV-4 shows the possible relationships between organizational resources.

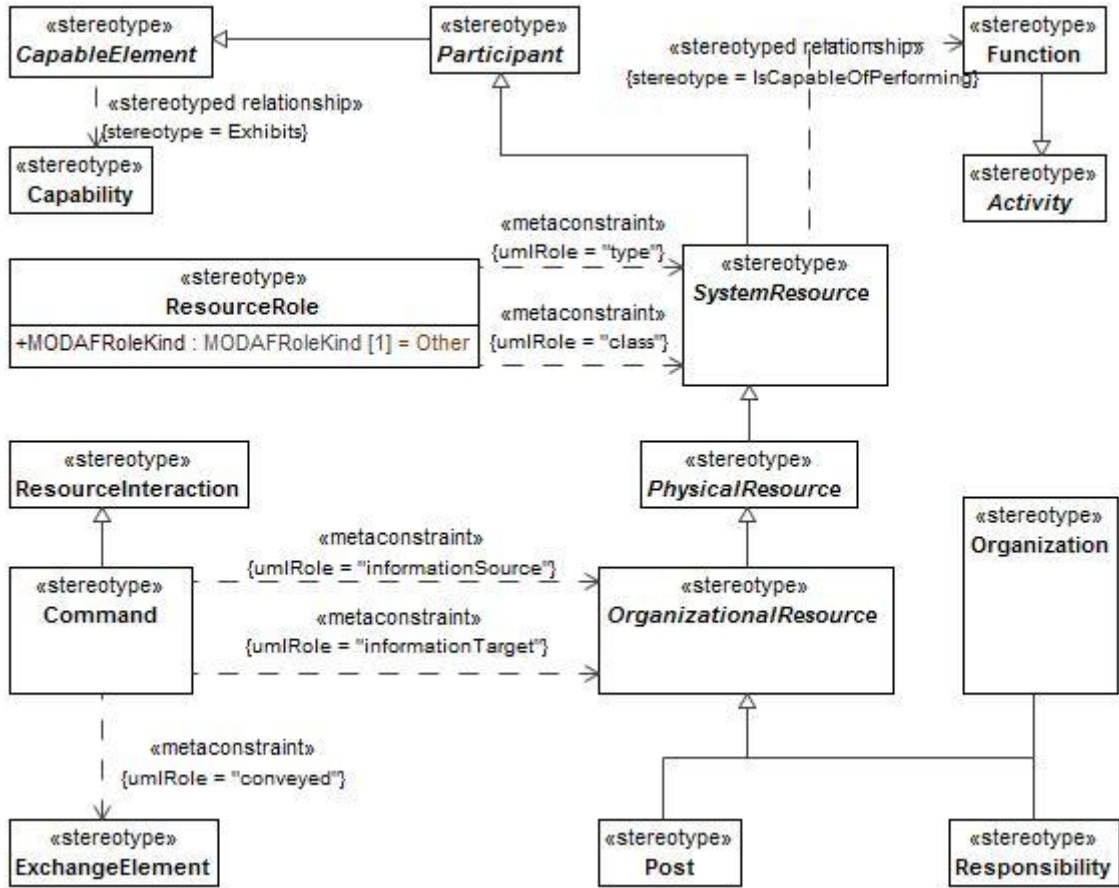

Figure B:12 - OV-4 Typical

B.1.3.6 OV-5

MODAF: The Operational Activity Model (OV-5) describes the operations that are normally conducted in the course of achieving a mission or a business goal. It describes operational activities (or tasks), Input/Output flows between activities, and to/from activities that are outside the scope of the Architecture.

DoDAF: The Operational Activity Model DoDAF-described View describes the operations that are normally conducted in the course of achieving a mission or a business goal. It describes operational activities (or tasks); Input/Output flows between activities, and to/from activities that are outside the scope of the Architecture.

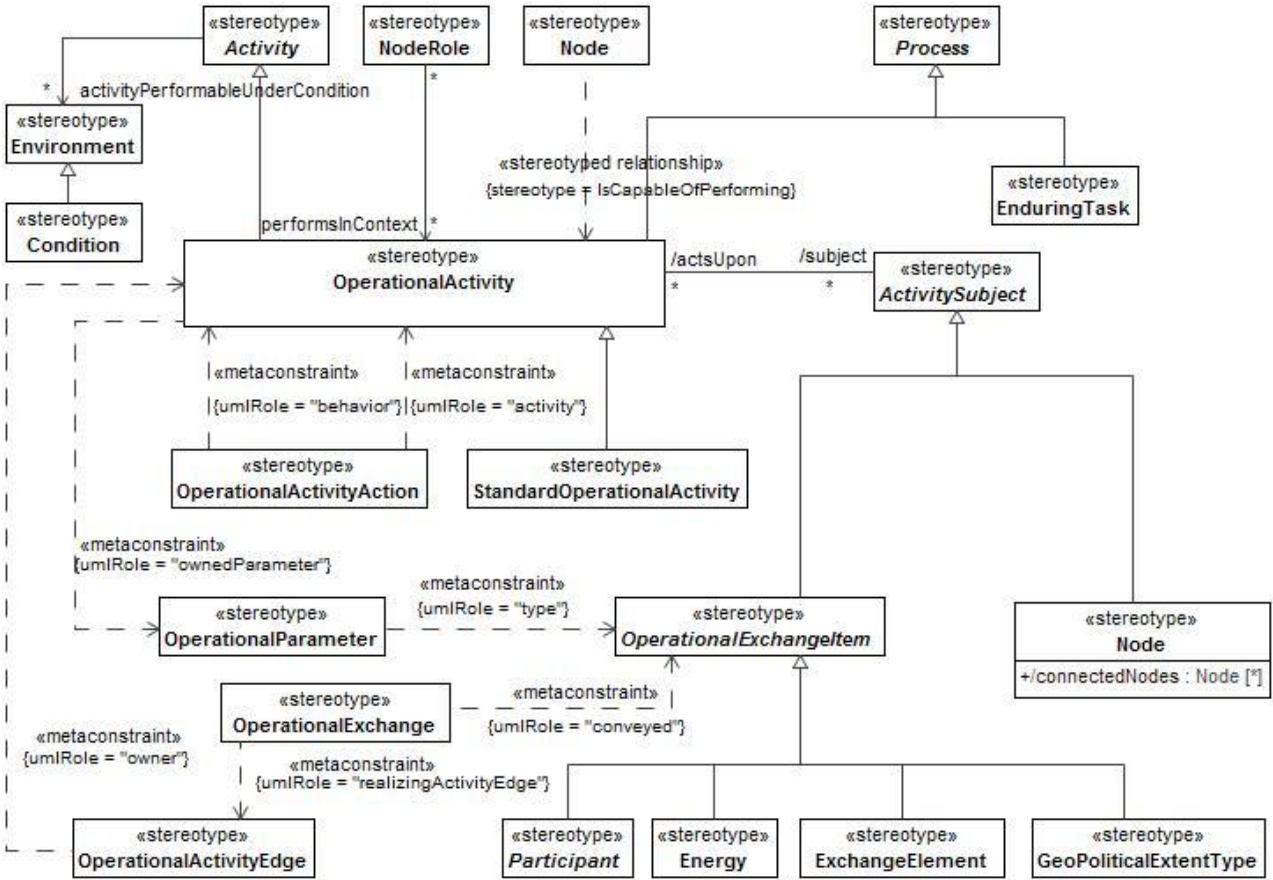

Figure B:13 - OV-5

B.1.3.7 OV-6a

MODAF: An Operational Rules Model (OV-6a) specifies operational or business rules that are constraints on the way that business is done in the enterprise.

DoDAF: An Operational Rules Model (OV-6a) DoDAF-described View specifies operational or business rules that are constraints on the way that business is done in the enterprise.

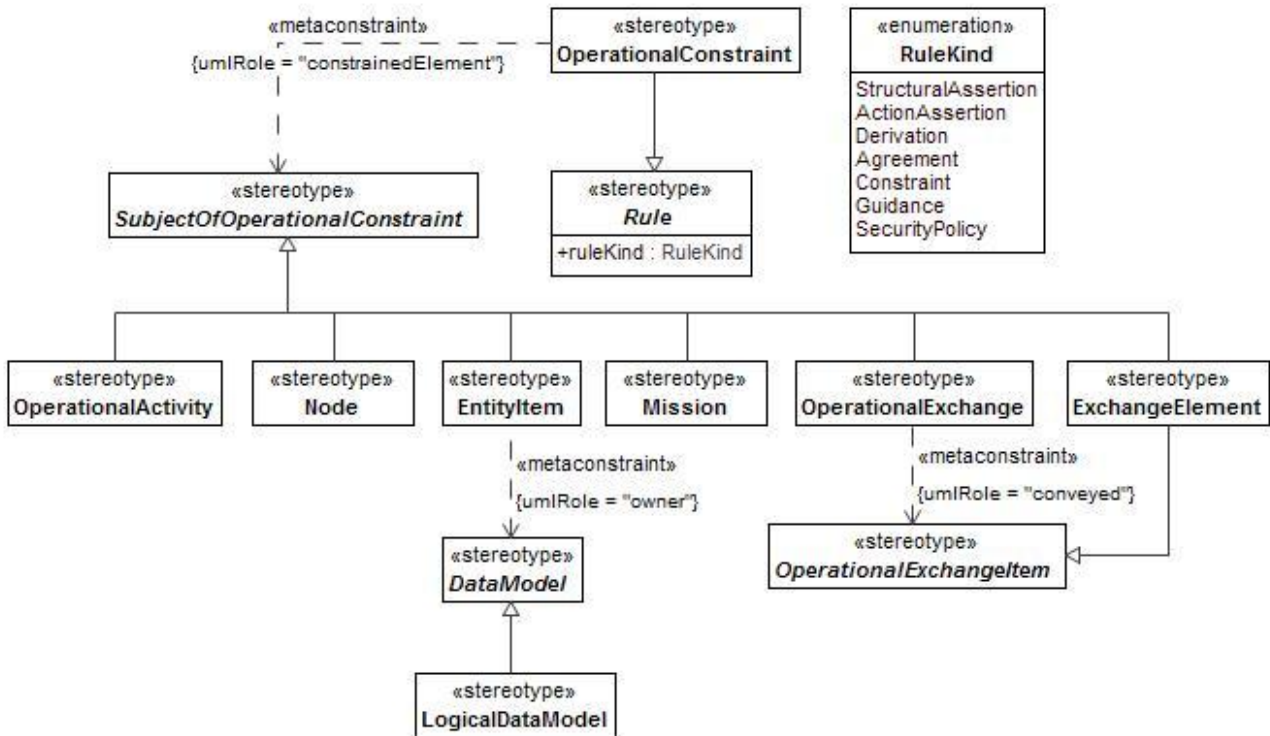

Figure B:14 - OV-6a

B.1.3.8 OV-6b

MODAF: OV-6b: The Operational State Transition Description is a graphical method of describing how an Operational Node or activity responds to various events by changing its state. The diagram represents the sets of events to which the Architecture will respond (by taking an action to move to a new state) as a function of its current state. Each transition specifies an event and an action.

DoDAF: The Operational State Transition Description (OV-6b) DoDAF-described View is a graphical method of describing how an Operational Activity responds to various events by changing its state. The diagram represents the sets of events to which the Architecture will respond (by taking an action to move to a new state) as a function of its current state. Each transition specifies an event and an action.

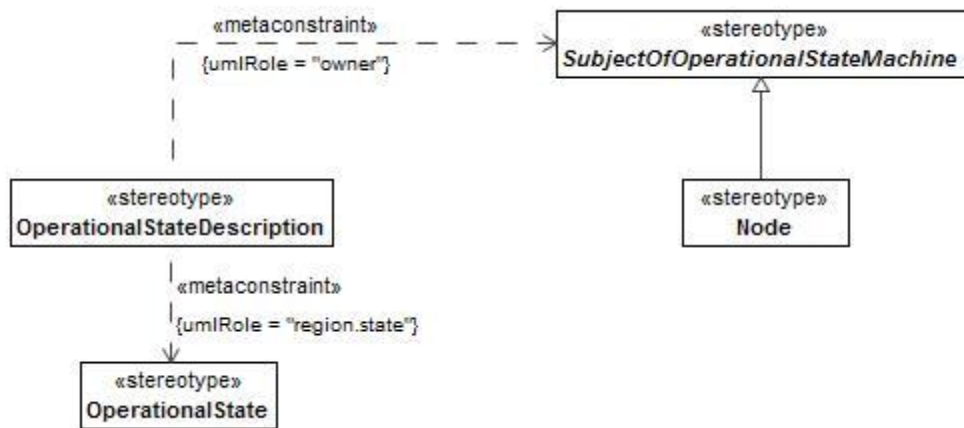

Figure B:15 - OV-6b

B.1.3.9 OV-6c

MODAF: OV-6c: The Operational Event-Trace Description provides a time-ordered examination of the information exchanges between participating Operational Nodes as a result of a particular scenario. Each event-trace diagram will have an accompanying description that defines the particular scenario or situation.

DoDAF: The Operational Event-Trace Description (OV-6c) DoDAF-described View provides a time ordered examination of the resource flows as a result of a particular scenario. Each event-trace diagram will have an accompanying description that defines the particular scenario or situation.

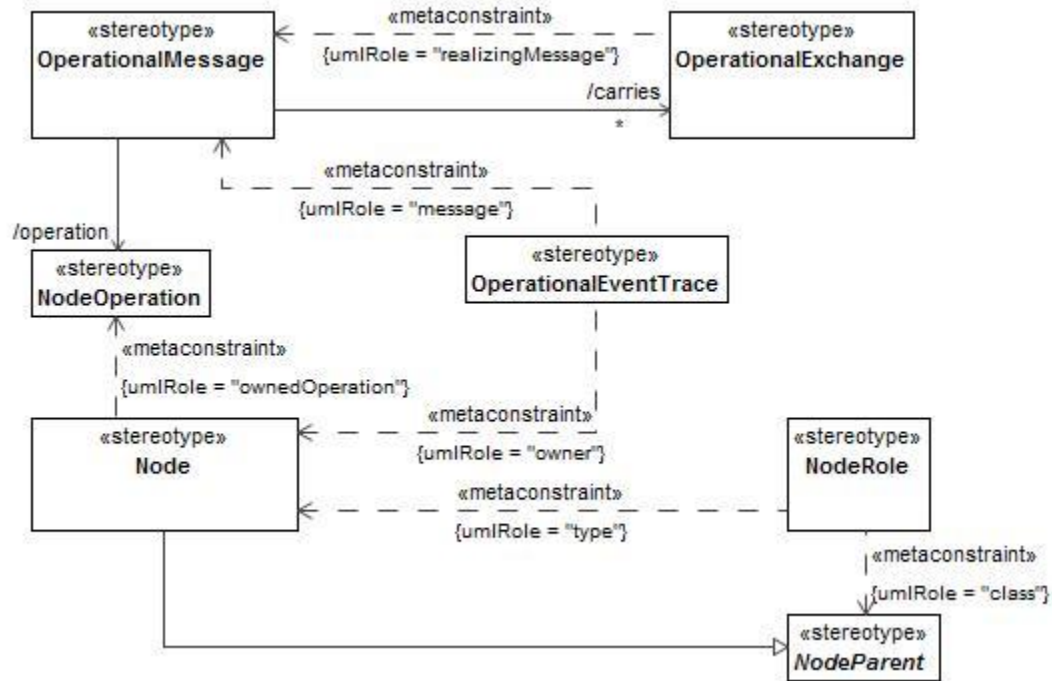

Figure B:16 - OV-6c

B.1.3.10 OV-7/DIV-1/DIV-2

MODAF: Information Models (OV-7) address the information perspective on an operational architecture.

DoDAF: The Conceptual Data Model (DIV-1), a new DoDAF-described View in DoDAF V2.0, addresses the information concepts at a high-level on an operational architecture.

The Logical Data Model (DIV-2) DoDAF-described View allows analysis of an architecture's data definition aspect, without consideration of implementation specific or product specific issues.

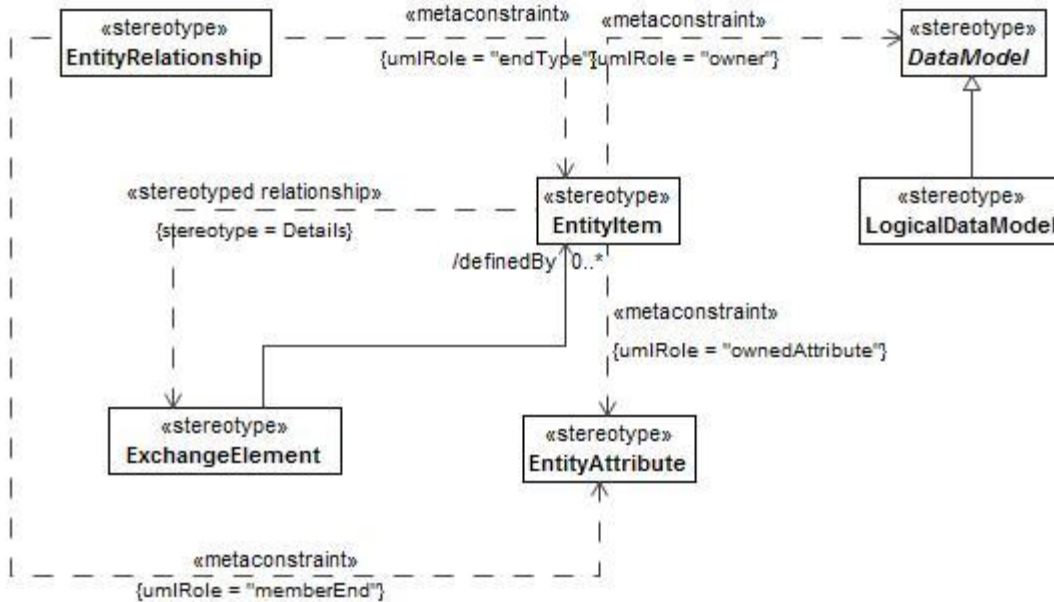

Figure B:17 - OV-7/DIV-1/DIV-2

B.1.4 SOV

MODAF: The Service-Orientated View (SOV) is a description of services needed to directly support the operational domain as described in the Operational View. A service within MODAF is understood in its broadest sense, as a unit of work through which a provider provides a useful result to a consumer.

DoDAF: The Service Views within the Services Viewpoint describe the design for service-based solutions to support operational development processes (JCIDS) and Defense Acquisition System or capability development within the Joint Capability Areas.

The relationship between architecture data elements across the Service Viewpoint to the Operational Viewpoint and Capability Viewpoint can be exemplified as services are procured and fielded to support organizations and their operations or a capability.

B.1.4.1 SOV-1

MODAF: The Service Taxonomy View (SOV-1) specifies a hierarchy of services. The elements in the hierarchy are service specifications (rather than service implementations), and the relationships between the elements are specializations – i.e., one Service is a special type of another.

DoDAF: NA

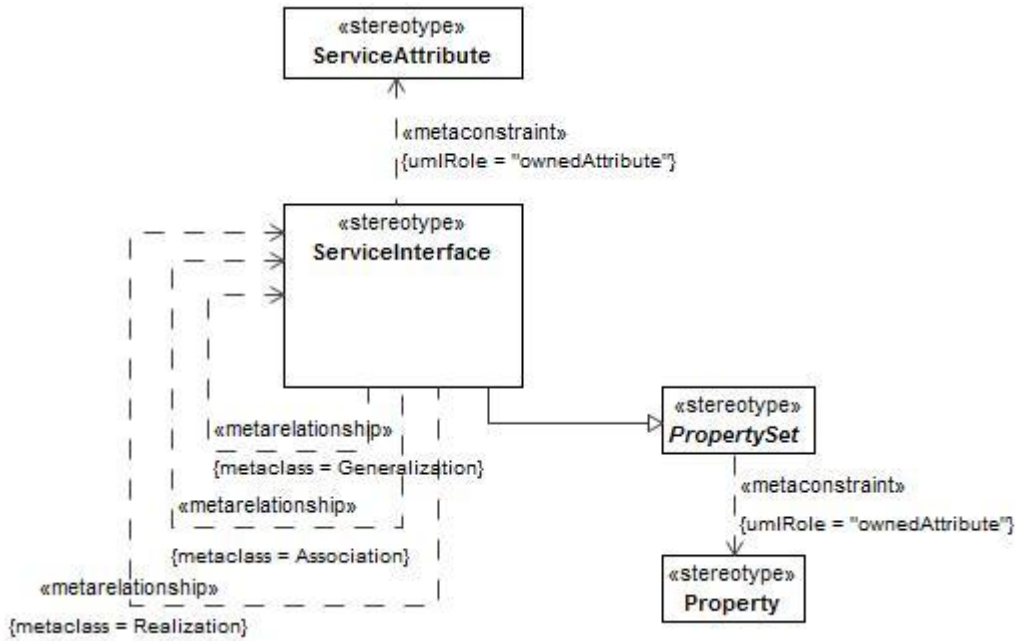

Figure B:18 - SOV-1

B.1.4.2 SOV-2

MODAF: The Service Taxonomy View (SOV-1) specifies a hierarchy of services. The elements in the hierarchy are service specifications (rather than service implementations), and the relationships between the elements are specializations – i.e., one Service is a special type of another.
 DoDAF: NA

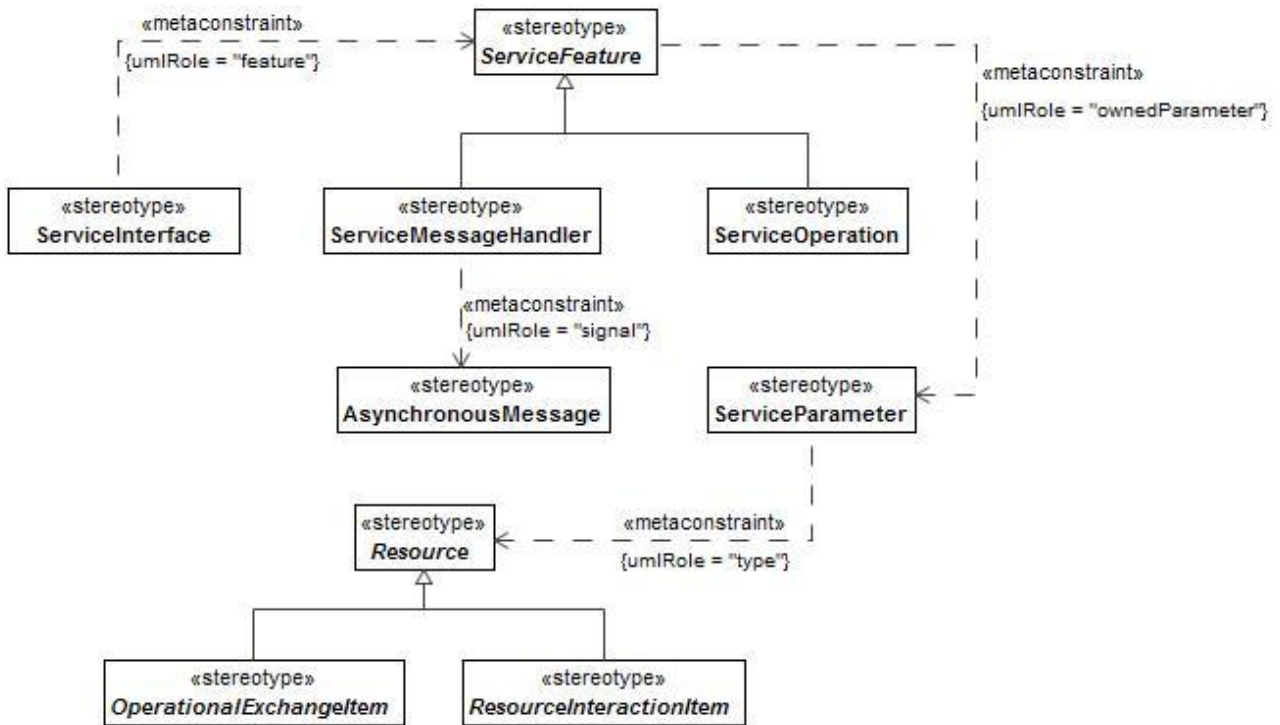

Figure B:19 - SOV-2

B.1.4.3 SOV-3

MODAF: The Capability to Service Mapping View (SOV-3) depicts which services contribute to the achievement of a capability.

DoDAF: CV-7 - A mapping between the capabilities and the services that these capabilities enable.

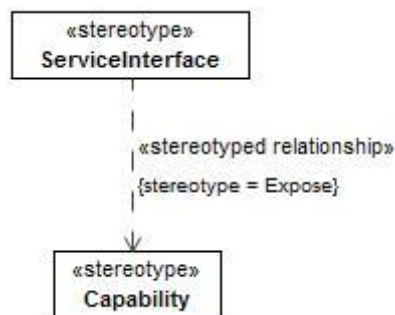

Figure B:20 - SOV-3

B.1.4.4 SOV-4a

MODAF: The purpose of the Service Constraints View (SOV-4a) is to specify constraints that apply to implementations of services.

DoDAF: The SvcV-10a DoDAF-described View describes constraints on the resources, functions, data and ports that make up the Service View physical architecture. The constraints are specified in text and may be functional or structural (i.e., non-functional).

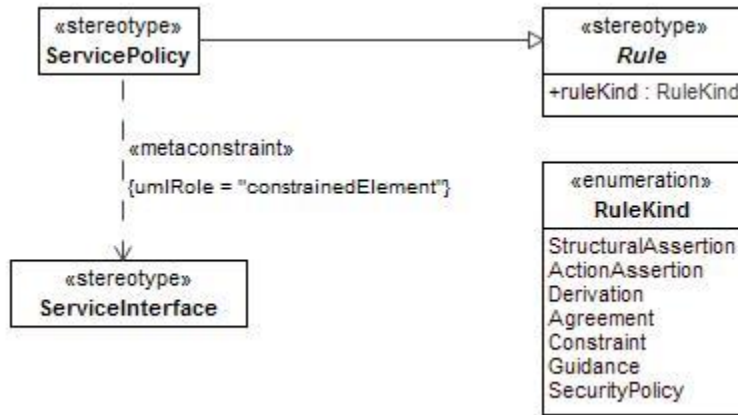

Figure B:21 - SOV-4a

B.1.4.5 SOV-4b

MODAF: The purpose of the Service State Model View (SOV-4b) is to specify the possible states a service may have, and the possible transitions between those states.

DoDAF: The Services State Transition Description DoDAF-described View is a graphical method of describing a resource (or function) response to various events by changing its state. The diagram basically represents the sets of events to which the resources in the Architecture will respond (by taking an action to move to a new state) as a function of its current state. Each transition specifies an event and an action.

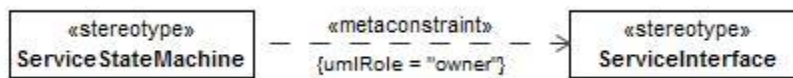

Figure B:22 - SOV-4b

B.1.4.6 SOV-4c

MODAF: The purpose of the Service Interaction Specification View (SOV-4c) is to specify how a service interacts with external agents, and the sequence and dependencies of those interactions.

DoDAF: The Services Event-Trace Description DoDAF-described View provides a time-ordered examination of the interactions between services functional resources. Each event-trace diagram will have an accompanying description that defines the particular scenario or situation.

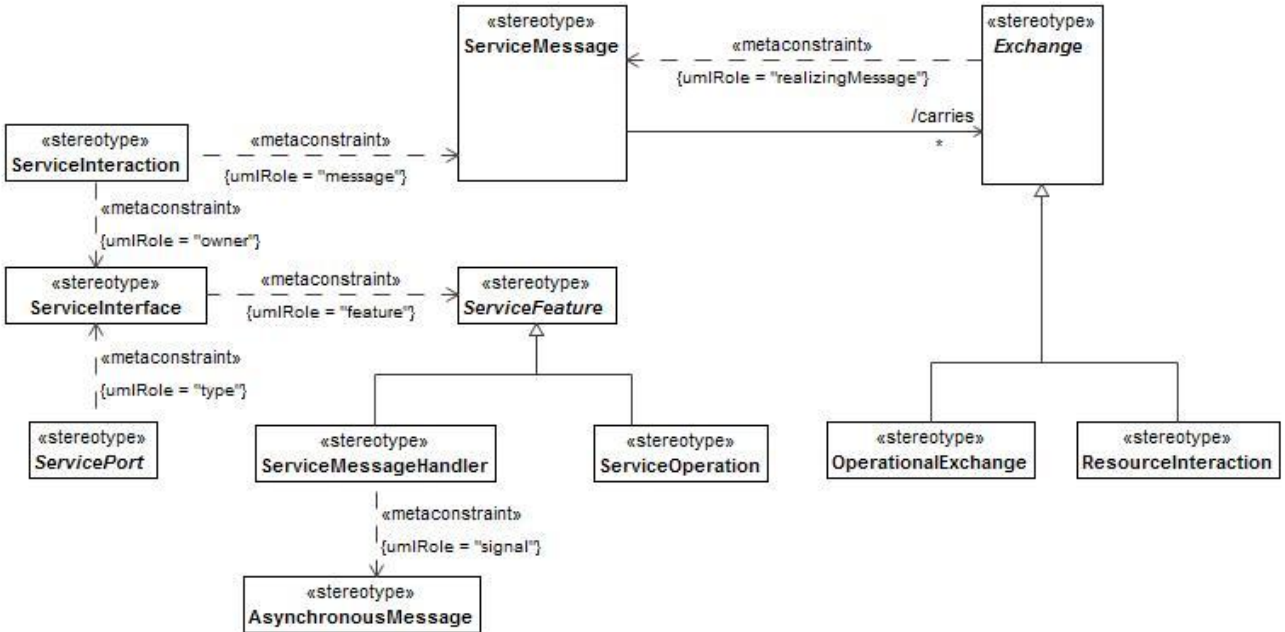

Figure B:23 - SOV-4c

B.1.4.7 SOV-5

MODAF: The Service Functionality View (SOV-5) defines the behavior of a service in terms of the functions it is expected to perform.

DoDAF: The Services Functionality Description provides detailed information regarding the: Allocation of service functions to resources, and Flow of resources between service functions.

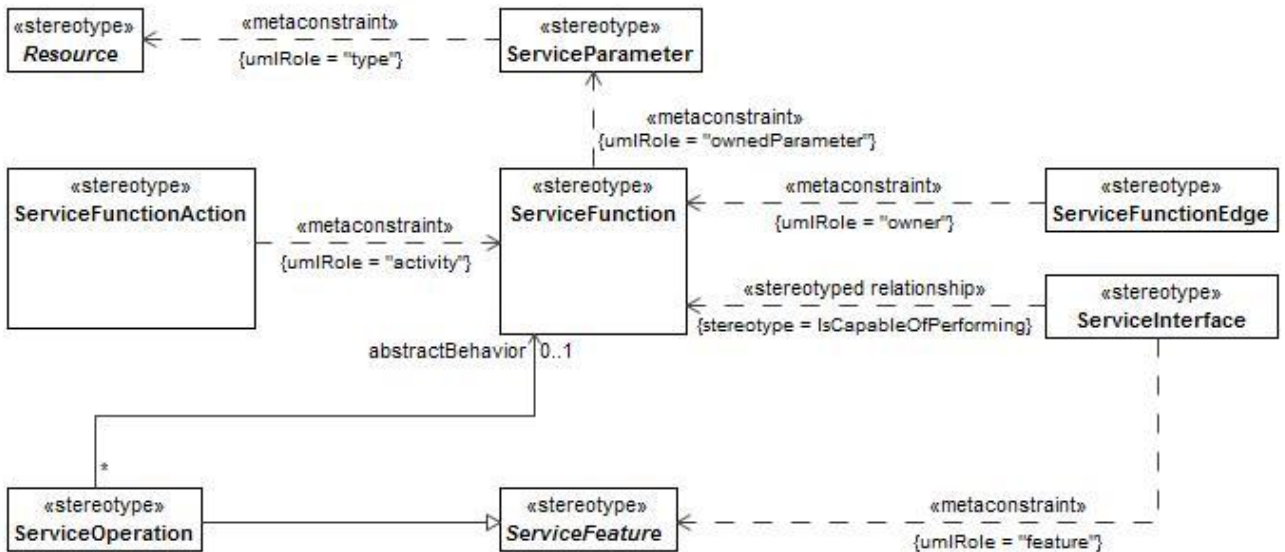

Figure B:24 - SOV-5

B.1.5 StV/ CV

MODAF: The Strategic Views (StVs) have been introduced to support the capability management process.

DoDAF: The Capability Views within the Capability Viewpoint are introduced into DoDAF V2.0 to address the concerns of Capability Portfolio Managers. In particular, Capability Views describe capability taxonomy and

capability evolution.

B.1.5.1 CV-7

MODAF: NA

DoDAF: CV-7 details the mapping between DoDAF services (ServiceAccess) and the Capability that they realize.

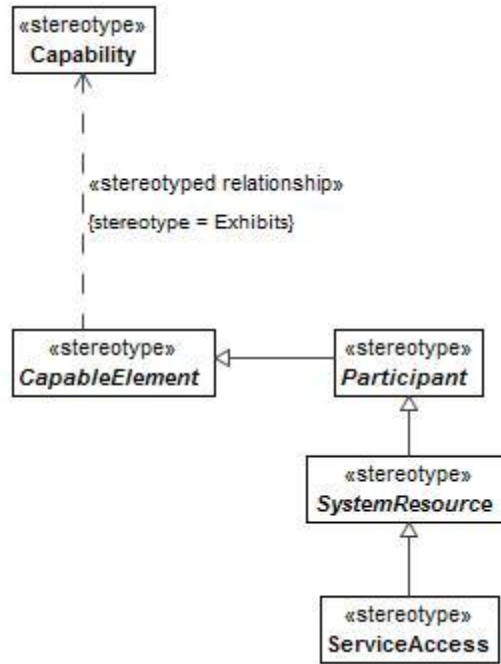

Figure B:25 - CV-7

B.1.5.2 StV-1/CV-1

MODAF: StV-1 addresses the enterprise concerns associated with the overall vision for transformational endeavors and thus defines the strategic context for a group of Enterprise capabilities.

DoDAF: CV-1: Vision: addresses the enterprise concerns associated with the overall vision for transformational endeavors and thus defines the strategic context for a group of capabilities.

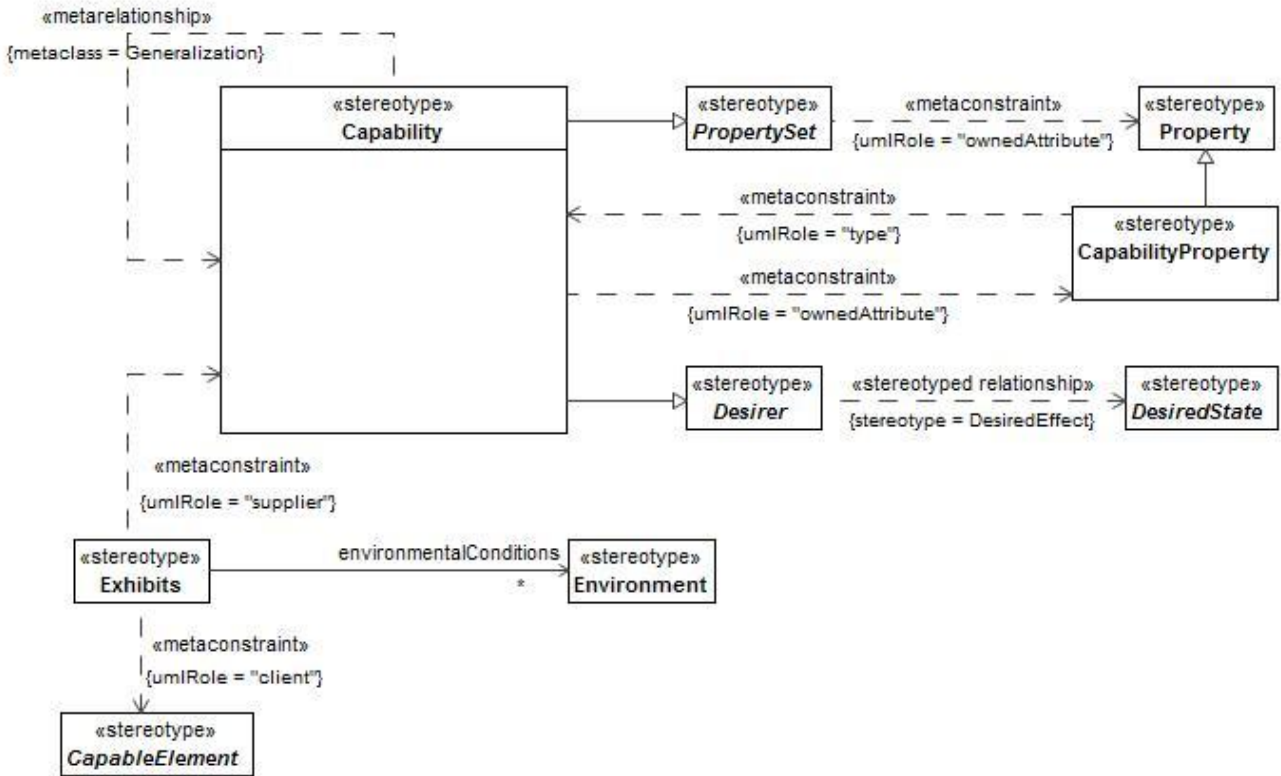

Figure B:27 - StV-2/CV-2

B.1.5.4 StV-3/CV-3

MODAF: StV-3 addresses the planned achievement of capability at different points in time or during specific periods of time, i.e., capability phasing.

DoDAF: CV-3: Capability Phasing: The CV-3 addresses the planned achievement of capability at different points in time or during specific periods of time, i.e., capability phasing.

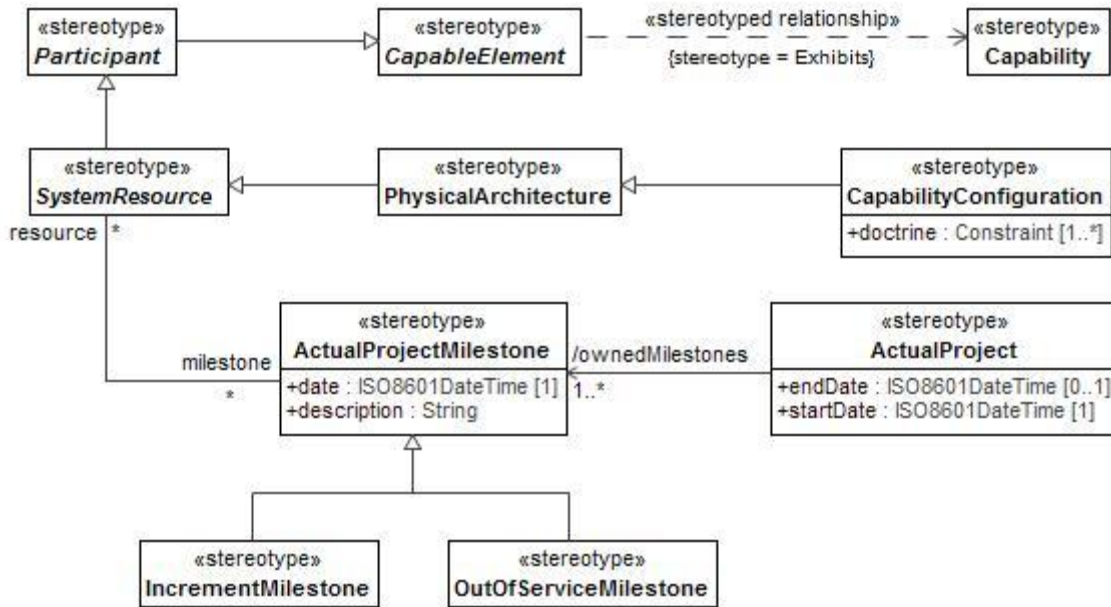

Figure B:28 - StV-3/CV-3

B.1.5.5 StV-4/CV-4

MODAF: The StV-4 Product describes the dependencies between planned capabilities. It also defines logical groupings of capabilities (capability clusters).

DoDAF: CV-4: Capability Dependencies: The CV-4 DoDAF-described View describes the dependencies between planned capabilities. It also defines logical groupings of capabilities.

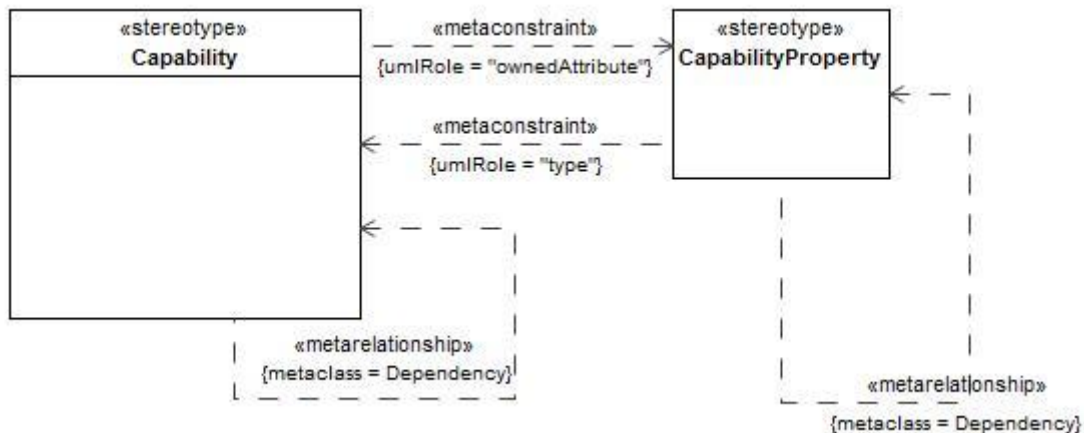

Figure B:29 - StV-4/CV-4

B.1.5.6 StV-5/CV-5

MODAF: StV-5 addresses the fulfillment of capability requirements, in particular by network enabled capabilities.

DoDAF: CV-5: Capability to Organizational Development Mapping: The CV-5 addresses the fulfillment of capability requirements.

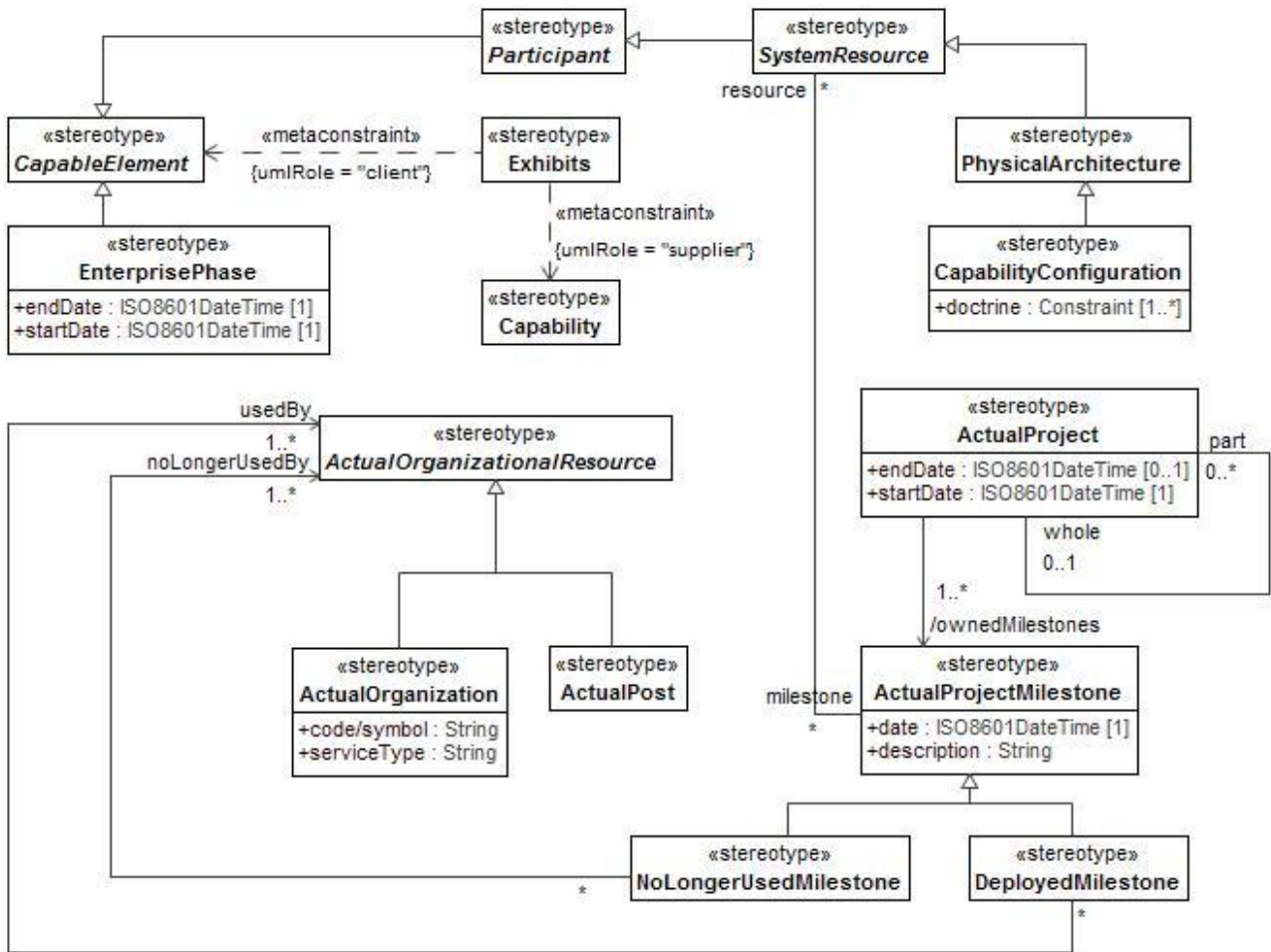

Figure B:30 - StV-5/CV-5

B.1.5.7 StV-6/CV-6

MODAF: The StV-6 Product describes the mapping between the capabilities required by an Enterprise and the operational activities that those capabilities support.

DoDAF: CV-6: Capability to Operational Activities Mapping: The CV-6 DoDAF-described View describes the mapping between the capabilities required and the operational activities that those capabilities support.

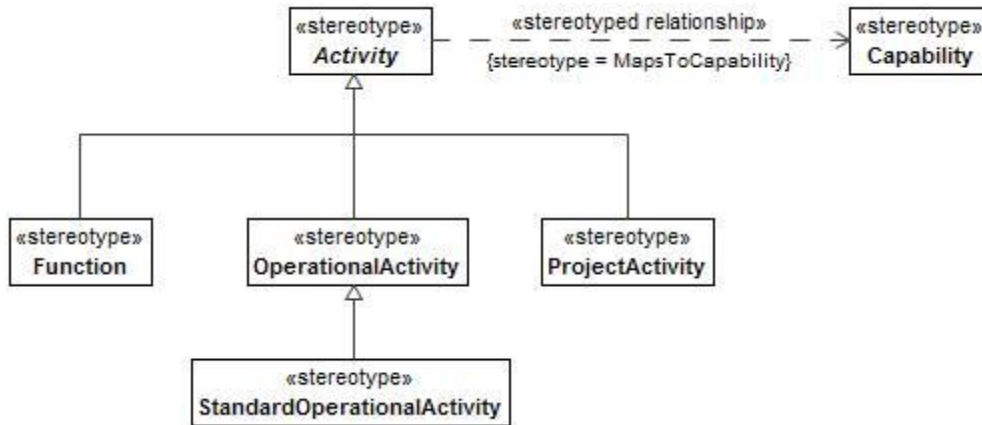

Figure B:31 - StV-6/CV-6

B.1.6 SV/SvcV

MODAF: A better name for these views in MODAF would be Solution or Specification View. In essence they should specify a requirement for a system or present the solution, without delving into the design elements of the system.

DoDAF: The Systems Views within the Systems Viewpoint describe systems and interconnections providing for, or supporting, DoD functions.

B.1.6.1 SV-1/SvcV-1

MODAF: Resource Interaction Specification (SV-1) addresses the composition and interaction of resources. From MODAF v1.1, SV-1 incorporates the human elements – Posts, Organizations, and Roles.

DoDAF: The Systems Interface Description (SV-1) DoDAF-described View addresses the composition and interaction of Systems. For DoDAF v2.0, the SV-1 incorporates the human elements as types of Performers-Organizations and Personnel Types.

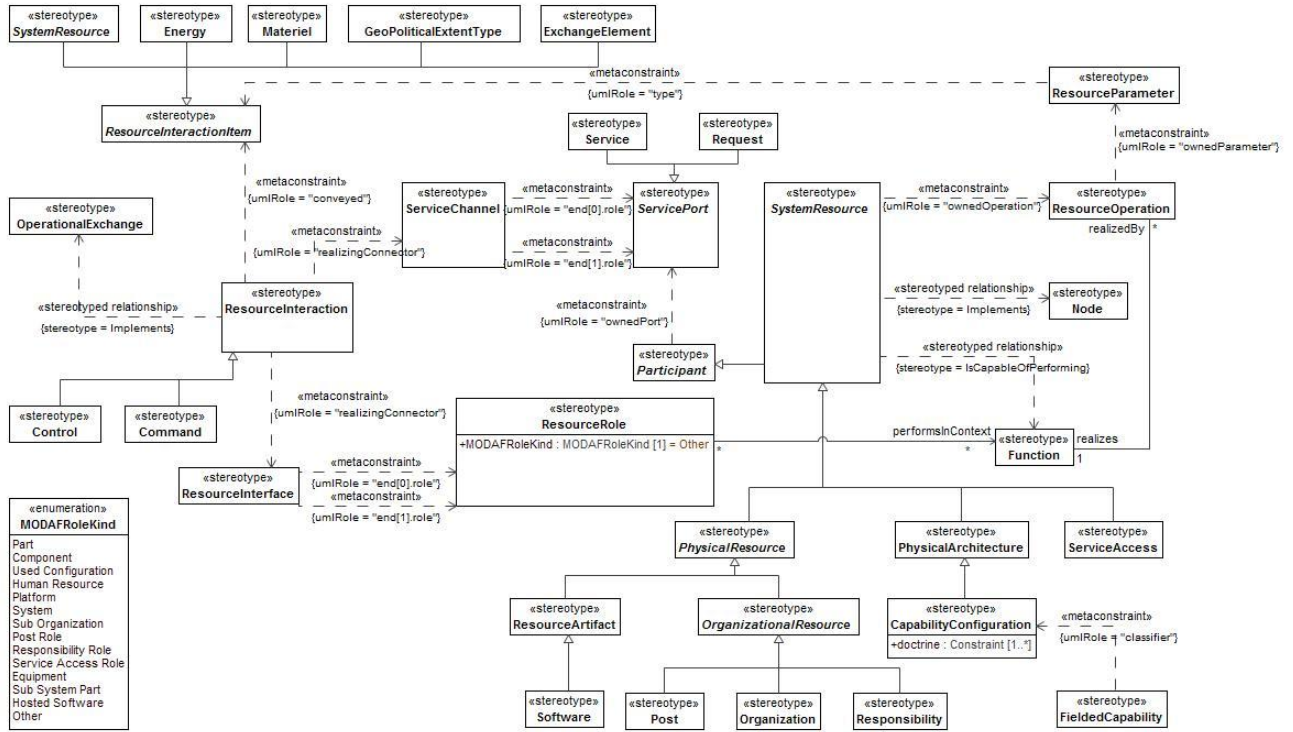

Figure B:32 - SV-1/SvcV-1

B.1.6.2 SV-10a/SvcV-10a

MODAF: The purpose of this Product is to specify functional and non-functional constraints on the implementation aspects of the architecture (i.e., the structural and behavioral elements of the SV viewpoint).

DoDAF: The SV-10a Systems Rules Model DoDAF-described View describes constraints on the resources, functions, data, and ports that make up the SV physical architecture. The constraints are specified in text and may be functional or structural (i.e., non-functional).

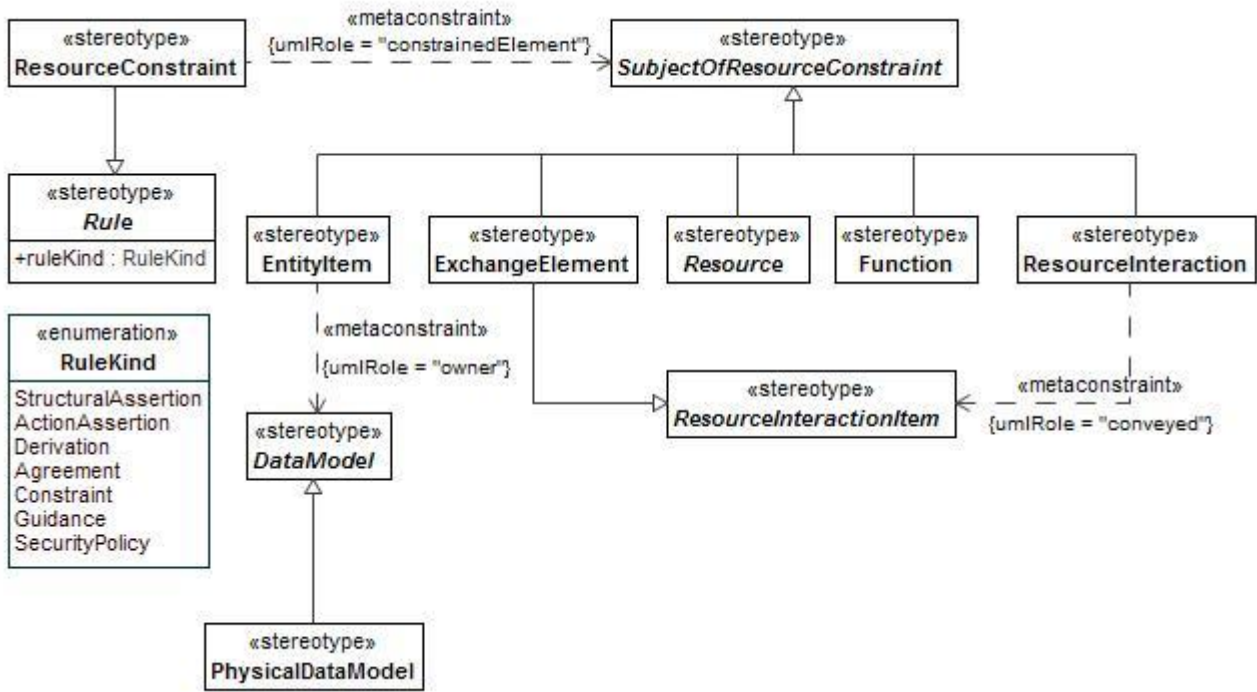

Figure B:33 - SV-10a/SvcV-10a

B.1.6.3 SV-10b/SvcV-10b

MODAF: The Resource State Transition Description is a graphical method of describing a resource (or function) response to various events by changing its state. The diagram basically represents the sets of events to which the Resources in the Architecture will respond (by taking an action to move to a new state) as a function of its current state. Each transition specifies an event and an action.

DoDAF: The Systems State Transition Description DoDAF-described View is a graphical method of describing a resource (or system function) response to various events by changing its state. The diagram basically represents the sets of events to which the resources in the Architecture will respond (by taking an action to move to a new state) as a function of its current state. Each transition specifies an event and an action.

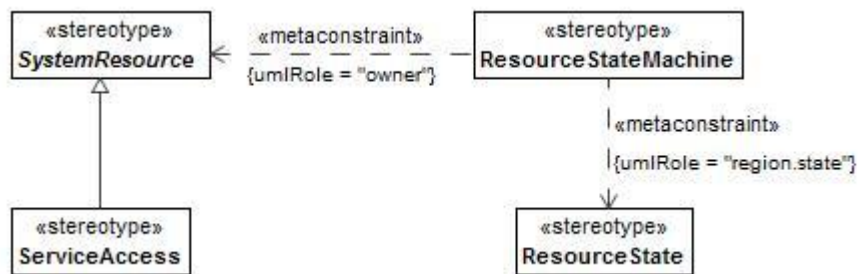

Figure B:34 - SV-10b/SvcV-10b

B.1.6.4 SV-10c/SvcV-10c

MODAF: The Resource Event-Trace Description provides a time-ordered examination of the interactions between resources. Each event-trace diagram will have an accompanying description that defines the particular scenario or situation.

DoDAF: The Systems Event-Trace Description provides a time-ordered examination of the interactions between functional resources. Each event-trace diagram will have an accompanying description that defines the particular

scenario or situation.

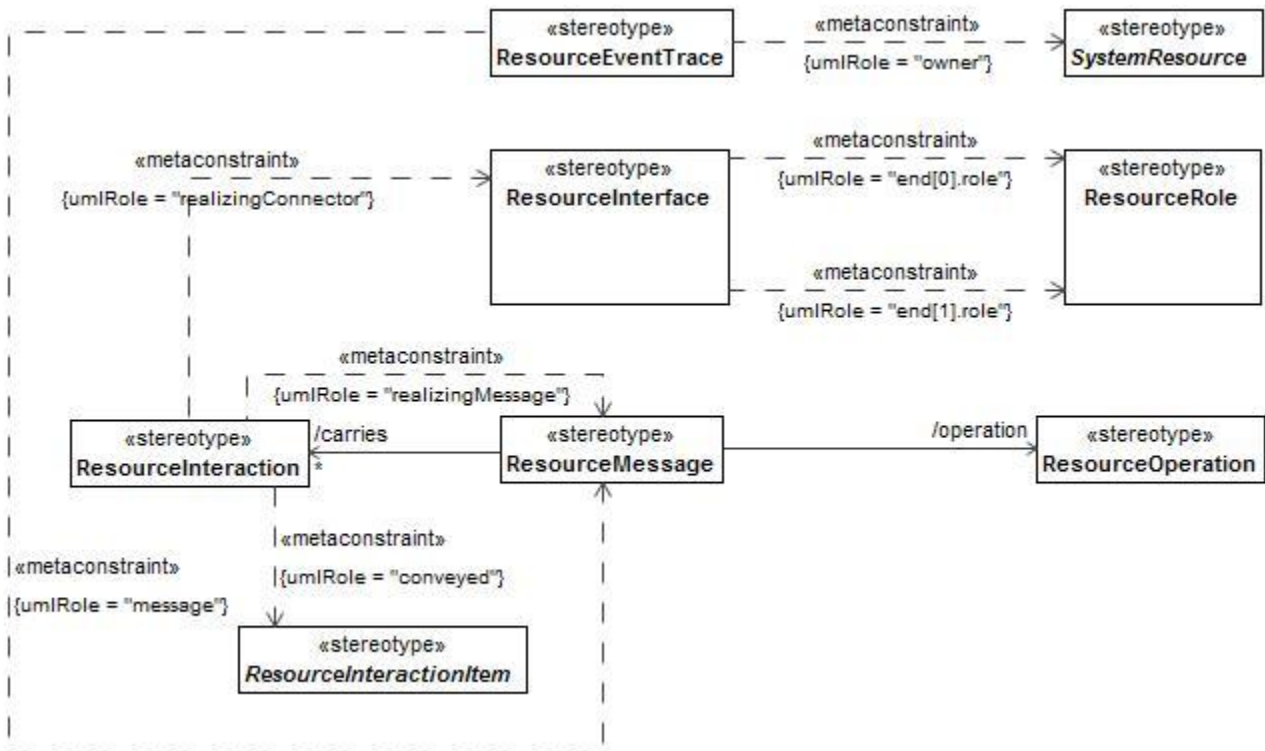

Figure B:35 - SV-10c/SvcV-10c

B.1.6.5 SV-11/DIV-3

MODAF: The SV-11 View defines the structure of the various kinds of system data that are utilized by the systems in the Architecture.

DoDAF: The DIV-3 Physical Data Model DoDAF-described view defines the structure of the various kinds of system or service data that are utilized by the systems or services in the Architecture.

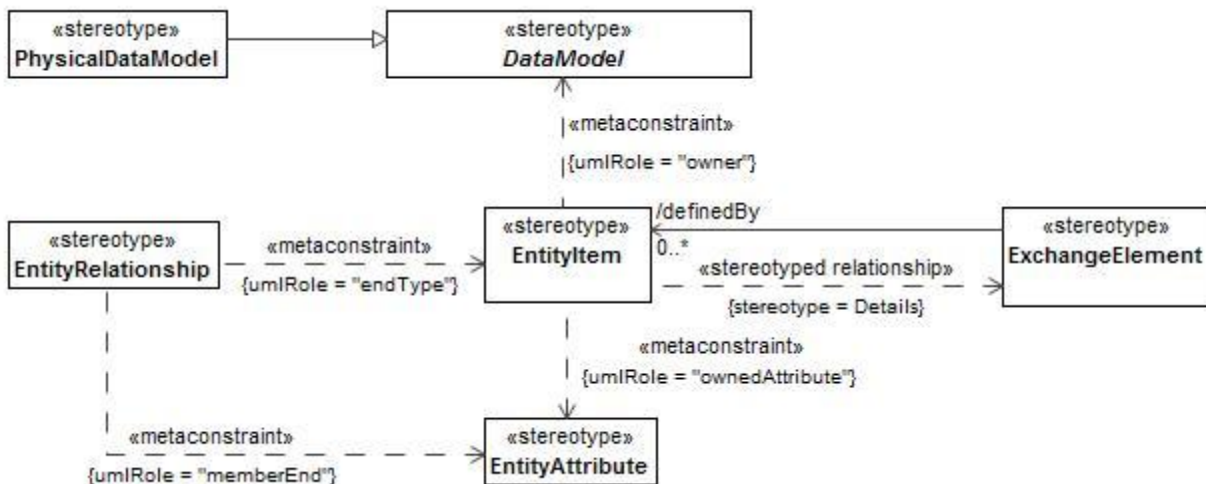

Figure B:36 - SV-11/DIV-3

B.1.6.6 SV-12

MODAF: The Service Provision View (SV-12) specifies configurations of resources that can deliver a service, and the levels of service those resources can deliver in different environments.
 DoDAF: NA

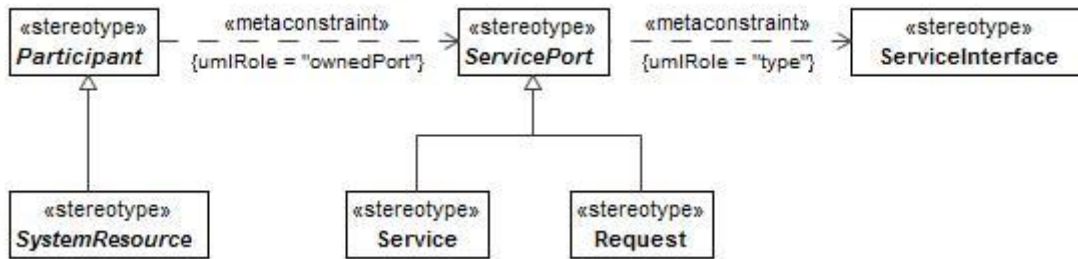

Figure B:37 - SV-12

B.1.6.7 SV-2/SvcV-2

MODAF: The Systems Communications Description (SV-2a/2b/2c) series of views is intended for the representation of communications networks and pathways that link communications systems, and provides details regarding their configuration.
 DoDAF: A Systems Resource Flow Description (SV-2) DoDAF-described View specifies the resource flows between Systems and may also list the protocol stacks used in connections.

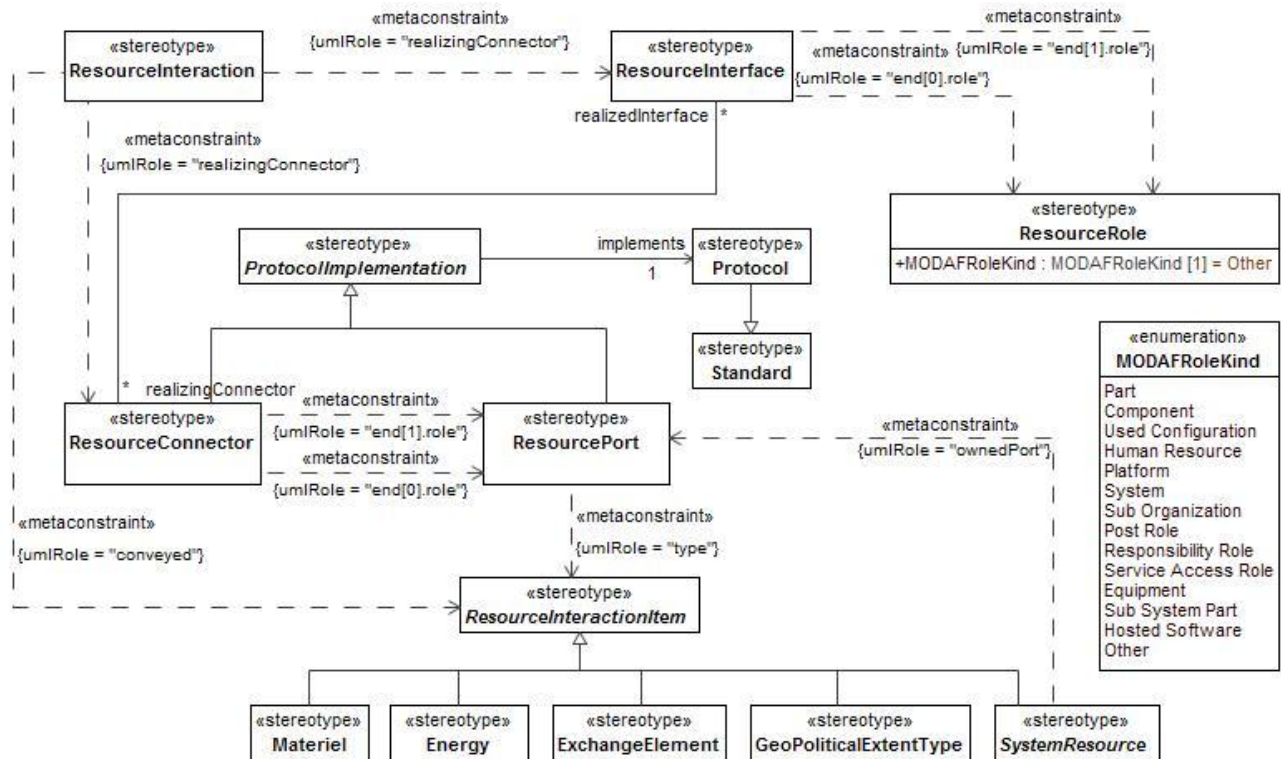

Figure B:38 - SV-2/SvcV-2

B.1.6.8 SV-3/SvcV-3a/SvcV-3b

MODAF: The Resource Interaction Matrix provides a tabular summary of the resource interactions specified in the SV-1 for the Architecture.

DoDAF: The Systems – Systems Matrix (SV-3) DoDAF-described View provides a tabular summary of the system interactions specified in the SV-1 for the Architecture.

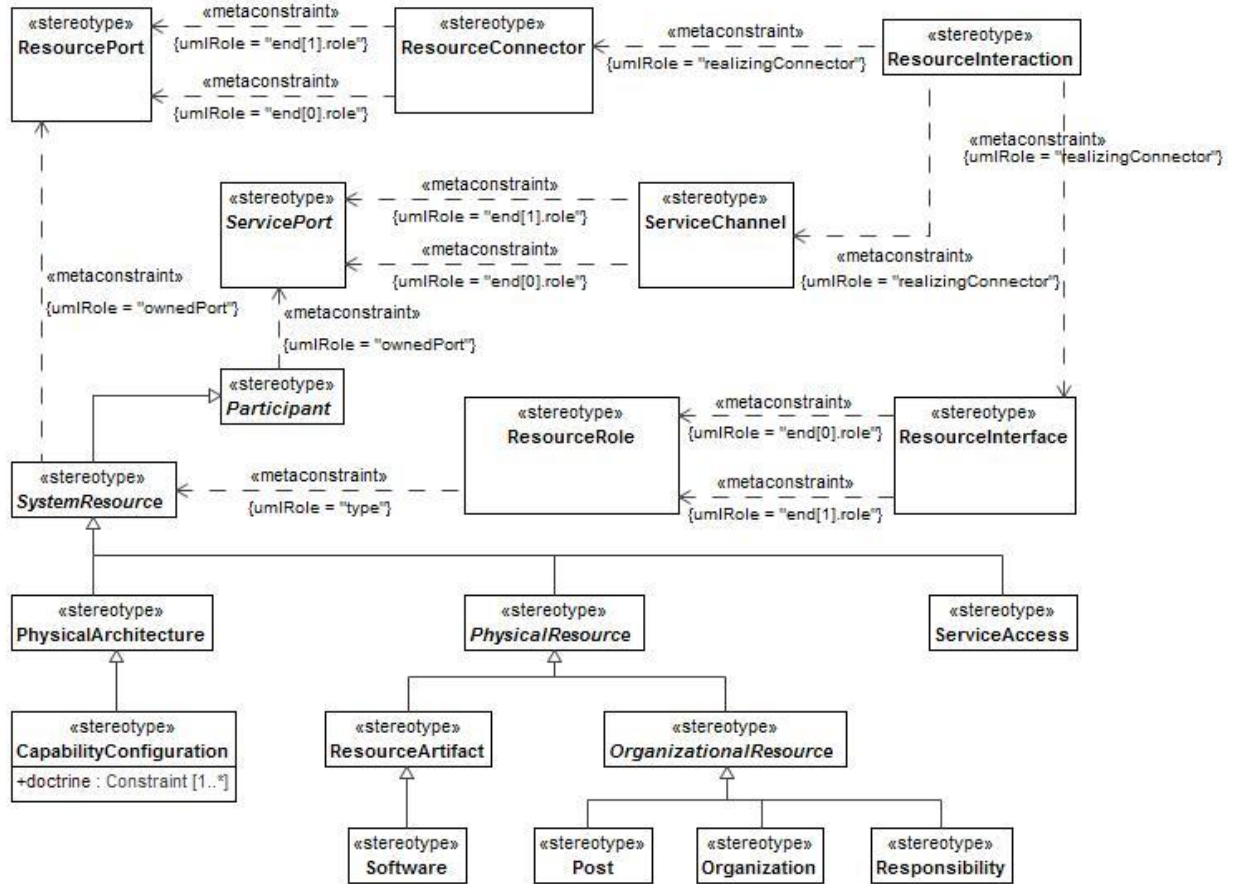

Figure B:39 - SV-3/SvcV-3a/SvcV-3b

B.1.6.9 SV-4/SvcV-4

MODAF: Functionality Descriptions (SV-4) address human and system functionality.

DoDAF: The Systems Functionality Description (SV-4) DoDAF-described View addresses human and system functionality.

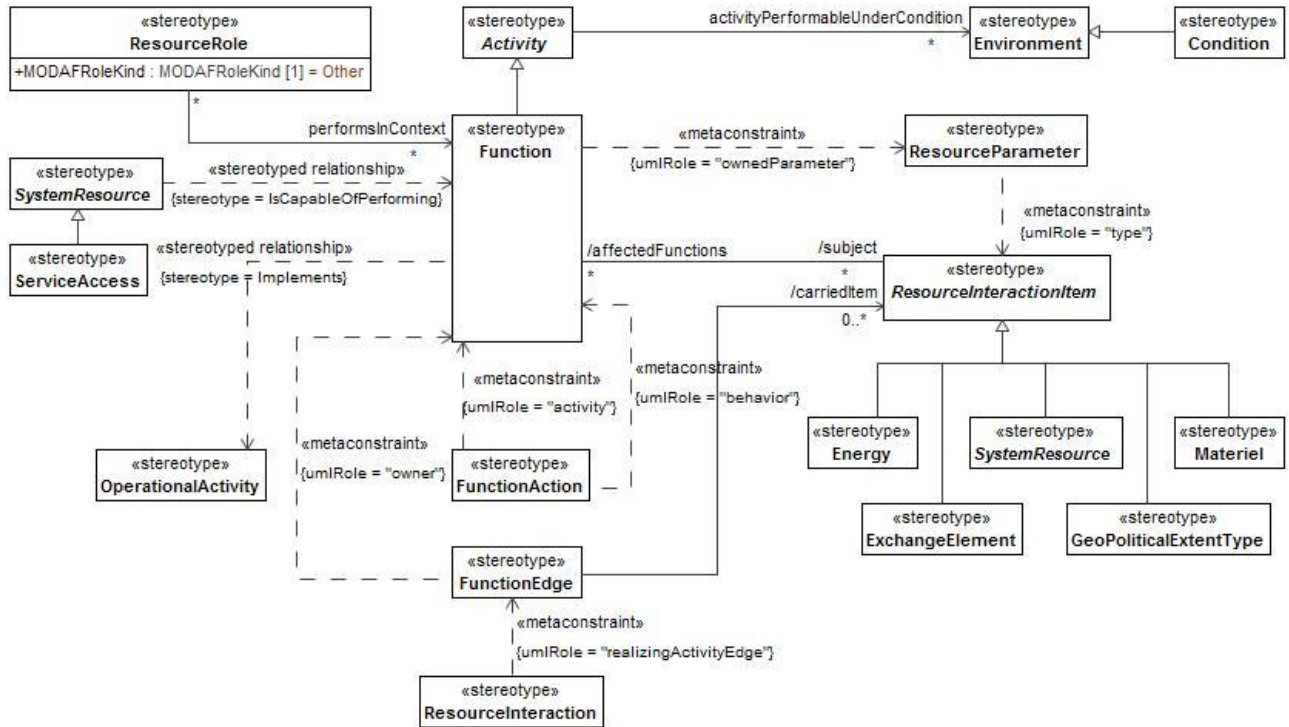

Figure B:40 - SV-4/SvcV-4

B.1.6.10 SV-5/SvcV-5

MODAF: This view has been expanded for the Service Orientated community by allowing for Service Functions as well as Operational Activities.

DoDAF: The Operational Activity to Systems Function Traceability Matrix (SV-5a) DoDAF-described View depicts the mapping of system functions (and, optionally, the capabilities and performers that provide them) to operational activities and thus identifies the transformation of an operational need into a purposeful action performed by a system or solution.

The Operational Activity to Systems Traceability Matrix (SV-5b) DoDAF-described View depicts the mapping of systems (and, optionally, the capabilities and performers that provide them) to operational activities and thus identifies the transformation of an operational need into a purposeful action performed by a system or solution.

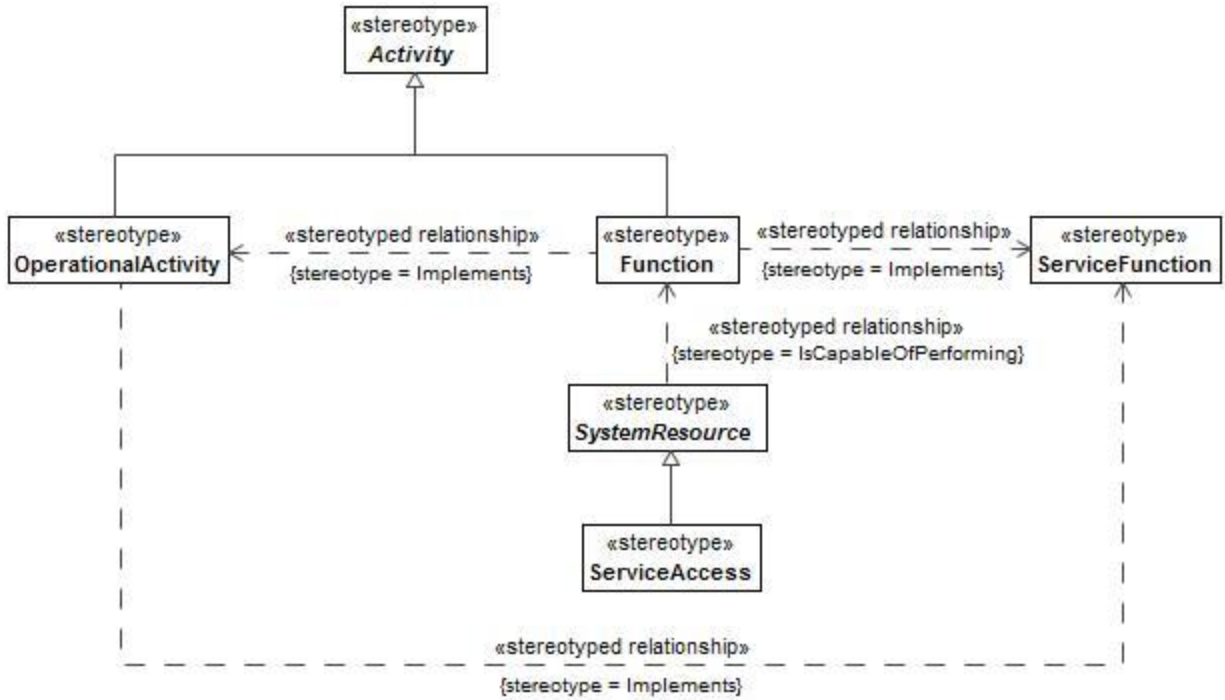

Figure B:41 - SV-5/SvcV-5

B.1.6.11 SV-6/SvcV-6

MODAF: The Systems Data Exchange Matrix specifies the characteristics of the system data exchanged between systems. The focus is on data crossing the system boundary.

DoDAF: The Systems Resource Flow Exchange Matrix DoDAF-described View specifies the characteristics of the system resource flows exchanged between systems. The focus is on resource crossing the system boundary.

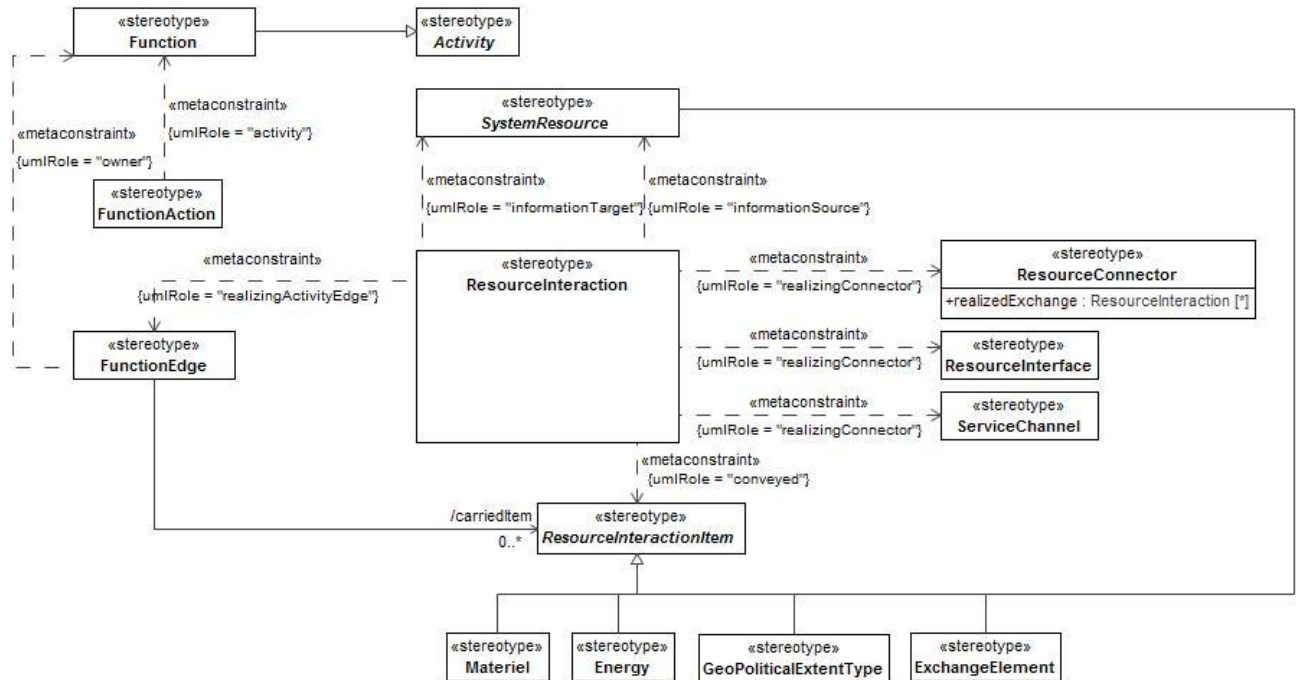

Figure B:42 - SV-6/SvcV-6

B.1.6.12 SV-7/SvcV-7

MODAF: The SV-7 is the Resource Performance Parameters Matrix and depicts the performance characteristics of a Resource (e.g., system, role, or capability configuration).

DoDAF: The SV-7 DoDAF-described View is the Systems Measures Matrix and depicts the measures (metrics) of resources.

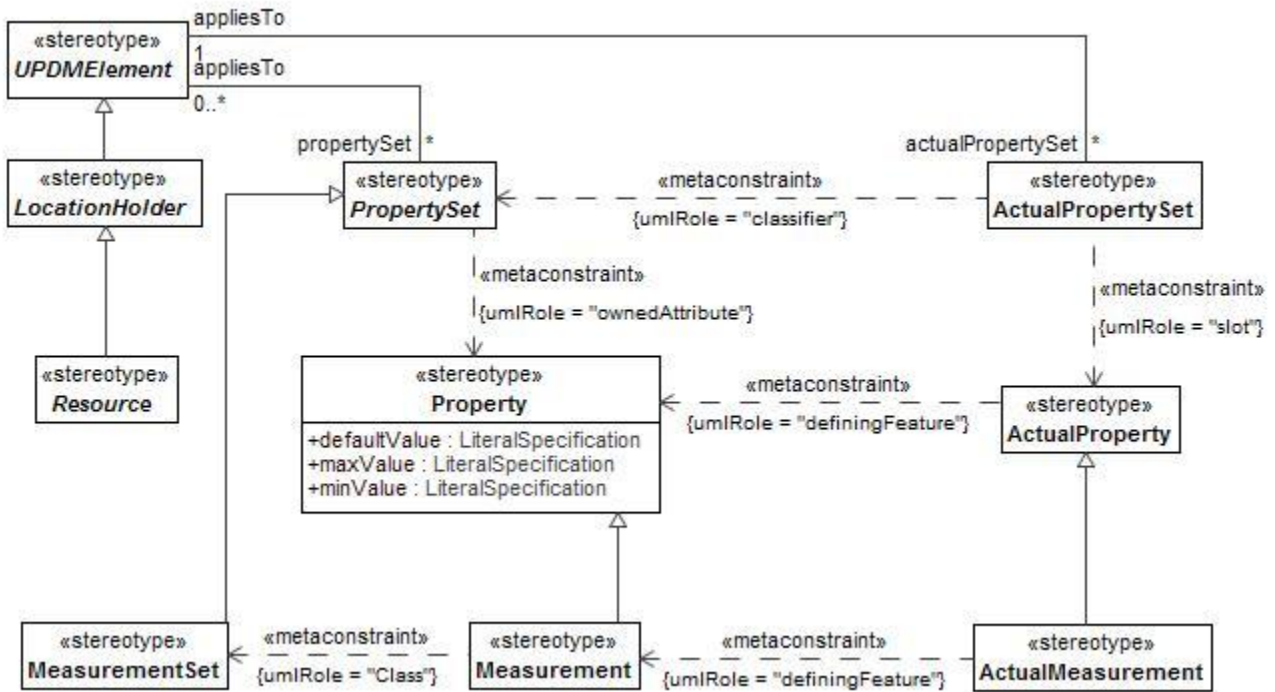

Figure B:43 - SV-7/SvcV-7

B.1.6.13 SV-8/SvcV-8

MODAF: The SV-8 provides an overview of how a capability configuration structure changes over time. It shows the structure of several capability configurations mapped against a timeline.

DoDAF: The Systems Evolution Description DoDAF-described View presents a whole lifecycle view of resources (systems), describing how it changes over time. It shows the structure of several resources mapped against a timeline.

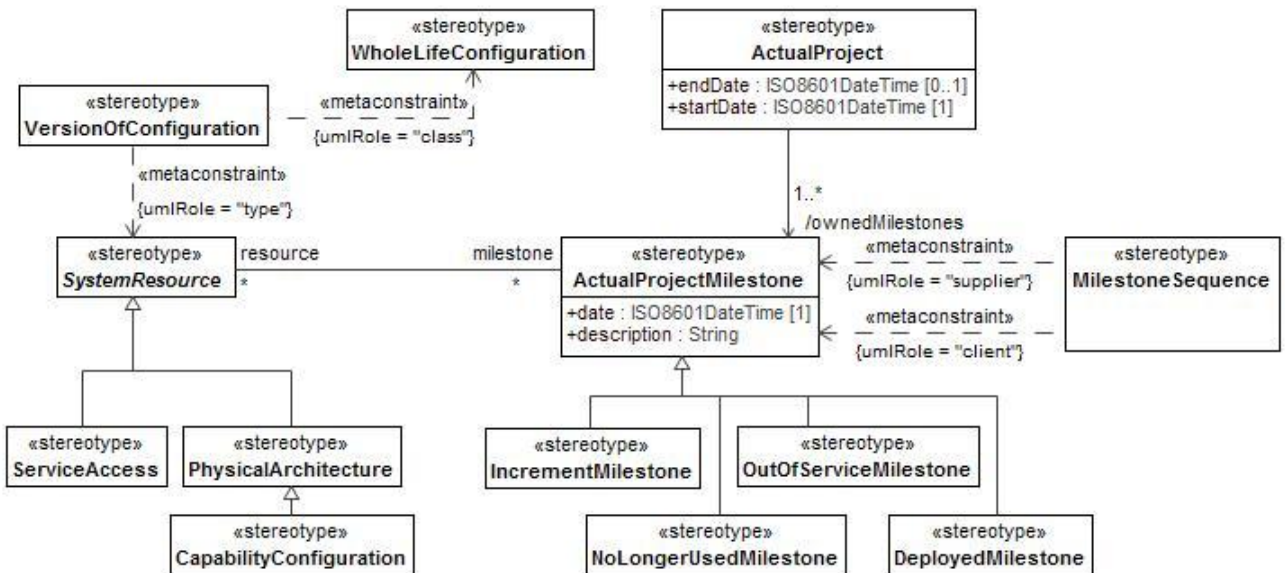

Figure B:44 - SV-8/SvcV-8

B.1.6.14 SV-9/SvcV-9

MODAF: The Technology & Skills Forecast defines the underlying current and expected supporting technologies and skills. Expected supporting technologies and skills are those that can be reasonably forecast given the current state of technology and skills, and expected improvements / trends. New technologies and skills will be tied to specific time periods, which can correlate against the time periods used in SV-8 milestones and linked to Enterprise Phases.

DoDAF: The Technology & Skills Forecast defines the underlying current and expected supporting technologies and skills. Expected supporting technologies and skills are those that can be reasonably forecast given the current state of technology and skills, and expected improvements / trends. New technologies and skills will be tied to specific time periods, which can correlate against the time periods used in SV-8 milestones and linked to Enterprise Phases.

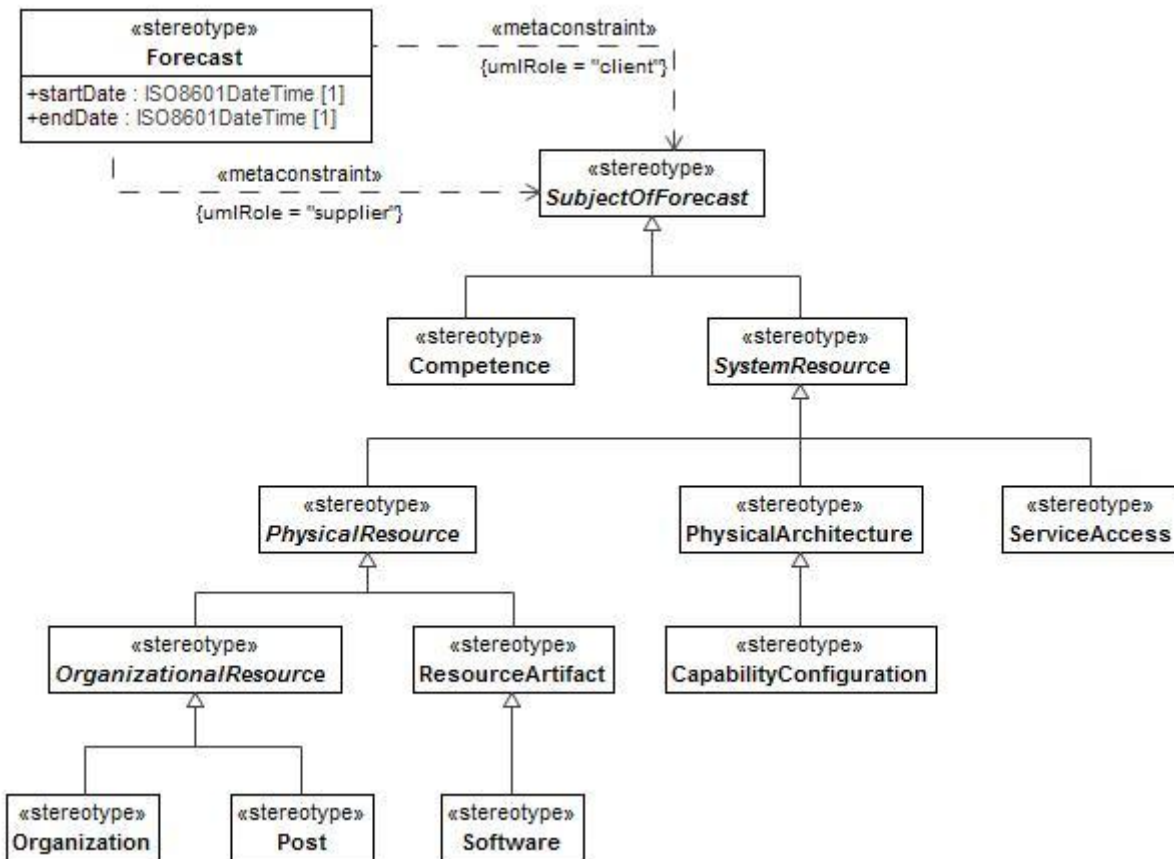

Figure B:45 - SV-9/SvcV-9

B.1.7 TV/StdV

MODAF: Technical Standards Views are extended from the core DoDAF views to include non-technical standards such as operational doctrine, industry process standards, etc.

DoDAF: The Standards Views within the Standards Viewpoint are the set of rules governing the arrangement, interaction, and interdependence of solution parts or elements.

B.1.7.1 TV-1&2&3/StdV-1&2

MODAF: Standards Profile (TV-1) defines the technical and non-technical standards, guidance and policy applicable to the architecture.

The Standards Forecast (TV-2) contains expected changes in technology-related standards and conventions, which

are documented in the TV-1 Product.

DoDAF: The Standards Profile StdV-1 DoDAF-described View defines the technical, operational, and business standards, guidance and policy applicable to the architecture.

The StdV-2 Standards Forecast DoDAF-described View contains expected changes in technology related standards, operational standards, or business standards and conventions, which are documented in the StdV-1 view.

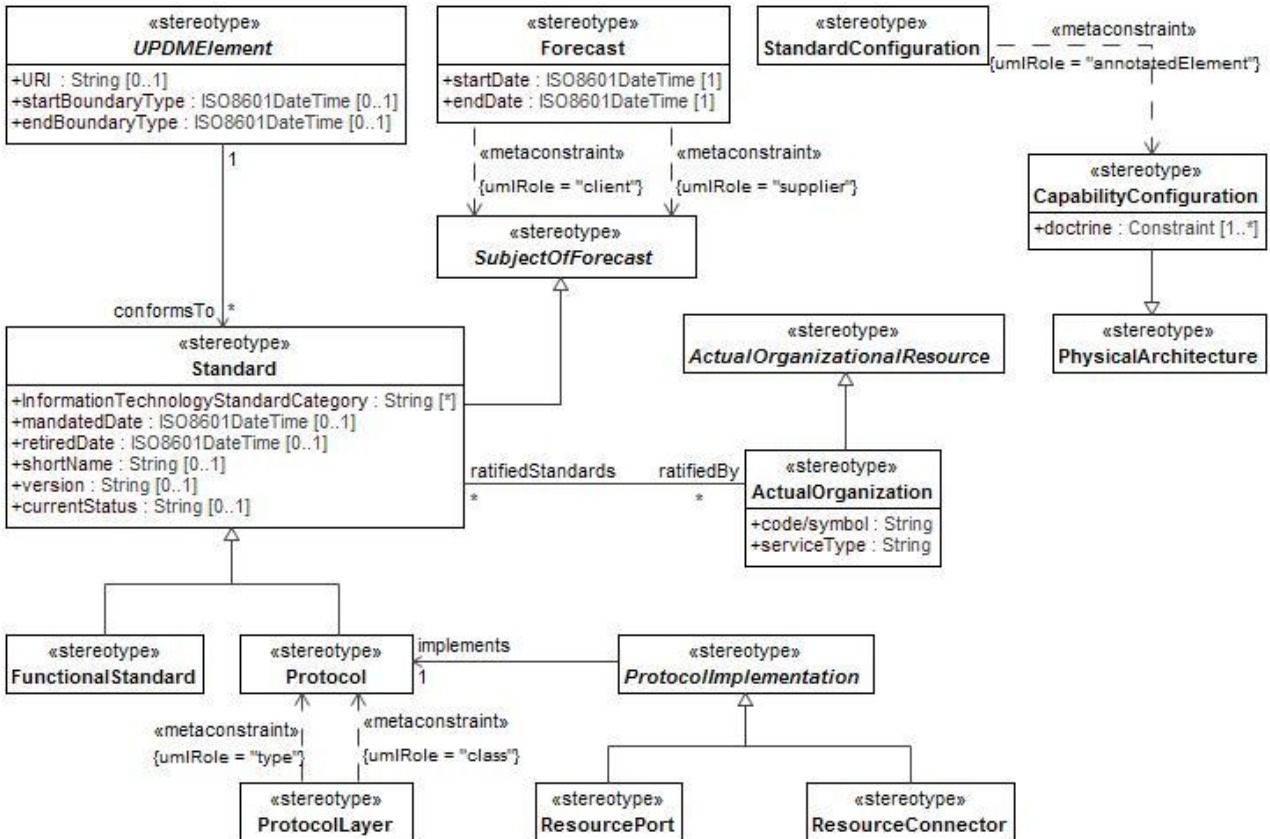

Figure B:46 - TV-1&2&3/StdV-1&2

Annex C UPDM Elements Traceability

(non-normative)

This Annex shows the traceability among UPDM stereotypes and DODAF/MODAF/NAF elements. There are different tables for the different mapping.

This mapping does not show all the elements in UPDM 2.0 or DoDAF 2.0.2. The elements not shown relate to:

- Abstract elements in UPDM.
- Elements that map to PowerTypes or PowerTypeTypes in DoDAF 2.0 as these are collections of sets that are derived from Types.
- Elements from the IDEAS foundation model that should not appear as part of DoDAF 2.0 architecture.

C.1 DoDAF-DM2, UPDM, and MODAF Mapping

DoDAF-DM2, UPDM, and MODAF Mapping		
DoDAF-DM2 Term	UPDM Profile Element	MODAF
Activity	Activity	Activity Composition
activityPartOfCapability	ActivityPartOfCapability	N/A
activityPartOfProjectType	ActivityPartOfProject	N/A
activityPerformableUnder Condition	activityPerformableUnderCondition	OperationalConstraint/ ResourceConstraint
instance of a Measure	ActualMeasurement	MeasurableProperty
Organization	ActualOrganization	ActualOrganization
Organization	ActualOrganization	ActualOrganization
N/A	ActualOrganizationRelationship	ActualOrganizationRelationship
N/A	ActualOrganizationRole	ActualOrganizationComposition
N/A	actualOrganizationRole for actualOrganization and actualPost.: broken down into three rows	ActualOrganization/ ActualOrganizationComposition/ ActualPost
N/A	ActualPerson	N/A
N/A	ActualPost	ActualPost
IndividualPersonRole	ActualPost/ IndividualPersonRole	ActualPost
Project	ActualProject	Project
N/A	ActualProjectMilestone	ProjectMilestone
N/A	ActualProjectMilestoneRole	ProjectWholePart
N/A	ActualProperty	N/A
N/A	ActualPropertySet	N/A
Representation	Alias	Alias
informationPedigree	Annotated UPDM element	N/A

DoDAF-DM2, UPDM, and MODAF Mapping		
DoDAF-DM2 Term	UPDM Profile Element	MODAF
N/A	ArbitraryConnector	ArbitraryConnection
ArchitecturalDescription	ArchitecturalDescription	ArchitecturalDescription
N/A	ArchitecturalReference	ArchitecturalReference
Information	ArchitectureMetadata	ArchitectureMetadata
N/A	AsynchronousMessage	AsynchronousMessage
Capability	Capability	Capability
System	CapabilityConfiguration (MODAF) System (DoDAF)	CapabilityConfiguration
N/A	Climate	Climate
N/A	Command	Command
Skill	Competence	Competence
N/A	CompetenceProvider	N/A
SkillOfPersonRoleType	CompetenceRequirer	CompetenceForRole
wholePart	composition relationship	WholePart
Instance of a Performer in an operational context	ConceptRole	ItemInConcept
IndividualPerformer	ConceptRole/NodeRole/ResourceRole	Node/ExternalIndividual/ItemInConcept/ ResourceUsage
Condition	Condition	Condition
N/A	ConditionProperty	EnvironmentalProperty
measureTypeApplicableTo Activity	Constraint	N/A
N/A	Control	Control
activityProducesResource	Conveyed tag on System and FunctionEdges, implicit through direction	carried tag on OperationalActivityFlows
activityConsumesResource	Conveyed tag on System and FunctionEdges, implicit through direction	carried tag on OperationalActivityFlows
locationNamedByAddress	customkind on GeopoliticalExtent or LocationKind	N/A
N/A	DeployedMilestone	DeployedMilestone
representedBy	DescribedBy	Definition
desiredEffect	desiredEffect	N/A
desiredEffectDirectsActivity	desiredEffect	N/A
desiredEffectIsRealizedBy ProjectType	desiredEffect	N/A
desiredEffectOfCapability	desiredEffect	N/A
visionIsRealizedByDesired Effect	DesiredEffect	N/A
N/A	Details	definedBy

DoDAF-DM2, UPDM, and MODAF Mapping		
DoDAF-DM2 Term	UPDM Profile Element	MODAF
endBoundary	endBoundary tag	N/A
N/A	EnduringTask	EnduringTask
Materiel	Energy	Energy
N/A	EnterpriseGoal	EnterpriseGoal
N/A	EnterprisePhase	EnterpriseStructure
N/A	EnterprisePhase	EnterpriseStructure
N/A	EnterpriseVision	EnterpriseVision
N/A	EntityAttribute	Attribute
N/A	EntityItem	Entity
associationOfInformation	EntityRelationship	EntityRelationship
N/A	EntityRelationship	EntityRelationship
AssociationOfInformation	EntityRelationship/ AssociationOfInformation	EntityRelationship
Data	Enumeration of information kind	DataElement
DomainInformation	Enumeration of InformationKind	N/A
PedigreeInformation	Enumeration of InformationKind	N/A
partiesToAnAgreement	Enumeration of Rulekind	N/A
Agreement	Enumeration of Rulekind applied to constraint	OperationalConstraint, ResourceConstraint, ServicePolicy
Constraint	Enumeration of Rulekind applied to constraint	OperationalConstraint, ResourceConstraint, ServicePolicy
Guidance	Enumeration of Rulekind applied to constraint	OperationalConstraint, ResourceConstraint, ServicePolicy
N/A	Environment	Environment
N/A	EnvironmentProperty	EnvironmentalProperty
Resource	ExchangeElement	ResourceType
capabilityOfPerformer	Exhibits/CapabilityOfPerformer	CapabilityForNode
N/A	ExternalTuple	N/A
N/A	ExternalTupleType	N/A
N/A	ExternalType	ExternalType
N/A	FieldedCapability	FieldedCapability
N/A	FillsPost	N/A
N/A	Forecast	Forecast
Activity	Function	Function
N/A	FunctionAction	N/A
FunctionalStandard	FunctionalStandard	N/A
activityProducesResource / activityConsumesResource	FunctionEdge	FunctionEdge
GeoPoliticalExtent	GeoPoliticalExtent	NA

DoDAF-DM2, UPDM, and MODAF Mapping		
DoDAF-DM2 Term	UPDM Profile Element	MODAF
RealProperty	GeoPoliticalExtent with its GeoPoliticalExtentKind.	N/A
RealPropertyType	GeoPoliticalExtent with its GeoPoliticalExtentKind.	N/A
RegionOfCountry	GeoPoliticalExtent with its GeoPoliticalExtentKind.	N/A
regionOfCountryPartOfCountry	GeoPoliticalExtent with its GeoPoliticalExtentKind.	N/A
RegionOfCountryType	GeoPoliticalExtent with its GeoPoliticalExtentKind.	N/A
RegionOfWorld	GeoPoliticalExtent with its GeoPoliticalExtentKind.	N/A
RegionOfWorldType	GeoPoliticalExtent with its GeoPoliticalExtentKind.	N/A
Site	GeoPoliticalExtent with its GeoPoliticalExtentKind.	N/A
sitePartOfInstallation	GeoPoliticalExtent with its GeoPoliticalExtentKind.	N/A
SiteType	GeoPoliticalExtent with its GeoPoliticalExtentKind.	N/A
GeoPoliticalExtentType	GeoPoliticalExtentType	N/A
N/A	HighLevelOperationalConcept	HighLevelOperationalConcept
personRoleTypePartOf Performer	HumanResource or Organization type as part of a Performer	N/A
N/A	Implements	ActivityToFunctionMapping
namedBy	implicit in Tools	N/A
portPartOfPerformer	Implicit in UML.	N/A
typeInstance	Implicit Type usage relationship in Tools	N/A
WholePart of Capability	IncrementMilestone	CapabilityIncrement
Information	Information	N/A
InformationType	InformationType	N/A
GeoStationaryPoint	Location with specific use of locationKind.	Location
Line	Location with specific use of locationTypeKind.	N/A
linePartOfPlanarSurface	Location with specific use of locationTypeKind.	N/A
Location (and all subtypes)	Location, ActualLocation and LocationTypeKind	ActualLocation
resourceInLocationType	LocationHolder (abstract)	N/A
LocationType	LocationType	Location

DoDAF-DM2, UPDM, and MODAF Mapping		
DoDAF-DM2 Term	UPDM Profile Element	MODAF
axesDescribedBy	LocationType with specific use of locationTypeKind.	Location
CircularArea	LocationType with specific use of locationTypeKind.	Location
CircularAreaType	LocationType with specific use of locationTypeKind.	Location
coordinateCenterDescribedBy	LocationType with specific use of locationTypeKind.	Location
EllipticalArea	LocationType with specific use of locationTypeKind.	Location
EllipticalAreaType	LocationType with specific use of locationTypeKind.	Location
Facility	LocationType with specific use of locationTypeKind.	Location
facilityPartOfSite	LocationType with specific use of locationTypeKind.	Location
FacilityType	LocationType with specific use of locationTypeKind.	Location
GeoStationaryPointType	LocationType with specific use of locationTypeKind.	Location
LineType	LocationType with specific use of locationTypeKind.	N/A
PlanarSurface	LocationType with specific use of locationTypeKind.	Location
PlanarSurfaceType	LocationType with specific use of locationTypeKind.	N/A
Point	LocationType with specific use of locationTypeKind.	Location
pointPartOfLine	LocationType with specific use of locationTypeKind.	Location
pointPartOfPlanarSurface	LocationType with specific use of locationTypeKind.	Location
PointType	LocationType with specific use of locationTypeKind.	Location
PolygonArea	LocationType with specific use of locationTypeKind.	Location
PolygonAreaType	LocationType with specific use of locationTypeKind.	Location
PositionReferenceFrame	LocationType with specific use of locationTypeKind.	Location
RectangularArea	LocationType with specific use of locationTypeKind.	Location
RectangularAreaType	LocationType with specific use of locationTypeKind.	Location

DoDAF-DM2, UPDM, and MODAF Mapping		
DoDAF-DM2 Term	UPDM Profile Element	MODAF
RectangularAreaTypeType	LocationType with specific use of locationTypeKind.	Location
SolidVolume	LocationType with specific use of locationTypeKind.	Location
SolidVolumeType	LocationType with specific use of locationTypeKind.	Location
Surface	LocationType with specific use of locationTypeKind.	Location
SurfaceType	LocationType with specific use of locationTypeKind.	Location
Performer	LogicalArchitecture	LogicalArchitecture
DiV-1/Div-2	LogicalDataModel	LogicalDataModel
activityMapsToCapability	MapsToCapability	ActivityMapsToCapability
Material	Material	Artifact
AdaptabilityMeasure	Measurement	MeasurableProperty
MaintainabilityMeasure	Measurement	MeasurableProperty
Measure	Measurement	MeasurableProperty
NeedsSatisfactionMeasure	Measurement	MeasurableProperty
OrganizationalMeasure	Measurement	MeasurableProperty
PerformanceMeasure	Measurement	MeasurableProperty
PhysicalMeasure	Measurement	MeasurableProperty
ServiceLevel	Measurement	MeasurableProperty
SpatialMeasure	Measurement	MeasurableProperty
TemporalMeasure	Measurement	MeasurableProperty
desireMeasure	MeasurementSet	N/A
effectMeasure	MeasurementSet	N/A
MeasureableSkill	MeasurementSet	N/A
measureableSkillOfPersonRole Type	MeasurementSet	N/A
MeasureOfEffect	MeasurementSet	N/A
measureOfIndividual	MeasurementSet	N/A
measureOfIndividualEnd Boundary	MeasurementSet	N/A
measureOfIndividualPoint	MeasurementSet	N/A
measureOfIndividualStart Boundary	MeasurementSet	N/A
measureOfType	MeasurementSet	N/A
measureOfTypeActivity	MeasurementSet	N/A
measureOfTypeCondition	MeasurementSet	N/A
measureOfTypeProjectType	MeasurementSet	N/A

DoDAF-DM2, UPDM, and MODAF Mapping		
DoDAF-DM2 Term	UPDM Profile Element	MODAF
measureOfTypeResource	MeasurementSet	N/A
MeasureOfDesire	MeasuremetSet	N/A
MeasureType	MeasureType	N/A
Information	Metadata	Metadata
N/A	MilestoneSequence	MilestoneSequence
Mission	Mission	Mission
Name	Name is implicit in Tools	N/A
Needline (but not officially in DM2)	Needline	Needline
Node	Node	Node
N/A	NodeOperation	N/A
N/A	NodeParent	NodeParent
Port	NodePort, ResourcePort	ResourcePort/SystemPort
IndividualPerformer	NodeRole	N/A
N/A	NoLongerUsedMilestone	StatusAtMilestone
PedigreeInformation	OntologyReference	OntologyReference
Activity	OperationalActivity	OperationalActivity
Activity	OperationalActivityAction	OperationalActivityAction
activityProducesResource / activityConsumesResource	OperationalActivityEdge	OperationalActivityEdge
Rule	OperationalConstraint	OperationalConstraint
N/A	OperationalEventTrace	OperationalEventTrace
N/A	OperationalExchange	OrganizationalExchange, EnergyExchange, MaterialExchange, ConfigurationExchange, GeoPoliticalExtent
N/A	OperationalParameter	N/A
N/A	OperationalState	N/A
N/A	OperationalStateDescription	OperationalStateDescription
Organization	Organization	ActualOrganization
N/A	OrganizationalProjectRelationship	OrganizationalProjectRelationship
OrganizationType	OrganizationType	OrganizationType
N/A	OutOfServiceMilestone	N/A
describedBy	ownedelement description in UML	N/A
activityPerformedByPerformer	OwnsProcess	ProcessOwner
Performer	Participant	N/A
Performer	Performer	Node
activityPerformedByPerformer	Performs/ ActivityPerformedByPerformer	NodeHasBehavior/FunctionsUpon/ ActsUpon
N/A	Person	N/A

DoDAF-DM2, UPDM, and MODAF Mapping		
DoDAF-DM2 Term	UPDM Profile Element	MODAF
whole part of a PersonRoleType	PersonType	N/A
System	PhysicalArchitecture	PhysicalArchitecture
DIV-3	PhysicalDataModel	PhysicalDataModel
Performer	PhysicalResource	PhysicalAsset
PersonRoleType	Post	PostType
N/A	Process	Process
Project	Project	Project
Activity	ProjectActivity	N/A
N/A	ProjectMilestone	ProjectMilestone
N/A	ProjectMilestoneRole	N/A
N/A	ProjectOwnership	ProjectOwnership
N/A	ProjectSequence	ProjectSequence
N/A	ProjectStatus	ProjectStatus
N/A	ProjectTheme	ProjectTheme
ProjectType	ProjectType	ProjectType
N/A	Property	N/A
N/A	PropertySet	N/A
N/A	Protocol	Protocol
TechnicalStandard	ProtocolImplementation	ProtocolImplementation
TechnicalStandard	ProtocolLayer	ProtocolLayer
skillOfPersonRoleType	ProvidesCompetence	ProvidesCompetence
ServicePort	Request	Requires
skillOfPersonRoleType	RequiresCompetence	CompetenceForRole
Material	ResourceArtifact	Artefact
N/A	ResourceConnector	SystemPortConnector
N/A	ResourceEventTrace	N/A
N/A	ResourceInteraction	ResourceInteraction
Data	ResourceInteractionItem	DataElement
portPartOfPerformer/ Port	ResourceInterface	N/A
N/A	ResourceOperation	N/A
N/A	ResourceParameter	N/A
materialPartOfPerformer	ResourceRole of Performer	N/A
N/A	ResourceState	N/A
N/A	ResourceStateMachine	N/A
N/A	Responsibility	N/A
PersonRoleType	RoleType	
Rule	Rule	Standard

DoDAF-DM2, UPDM, and MODAF Mapping		
DoDAF-DM2 Term	UPDM Profile Element	MODAF
ruleConstrainsActivity	Rule with specific RuleKind	OperationalConstraint/ ResourceConstraint
N/A	SameAs	SameAs
SecurityAttributesGroup	SecurityAttributesGroup	N/A
Grouping of organizations sharing a common security policy	SecurityDomain	N/A
Service	Service/Request	Service
serviceEnablesAccessToResource	Service/Request through ownedPort	ProvideService/RequiredService
ServicePort	ServiceAccess	N/A
ServicePort	ServiceAccess (DoDAF)	N/A
N/A	ServiceAttribute	ServiceAttribute
ServiceDescription	ServiceDescription	N/A
servicePortDescribedBy	ServiceDescription, service interface, ServiceLevel	N/A
N/A	ServiceFeature	N/A
Activity	ServiceFunction	ServiceFunction
N/A	ServiceFunctionAction	N/A
activityProducesResource / activityConsumesResource	ServiceFunctionEdge	N/A
ServiceInteractionSpecification	ServiceInteraction	ServiceInteractionSpecification
ServiceDescription	ServiceInterface	ServiceInterface
ServiceLevel	ServiceLevelValue	ServiceLevelValue
N/A	ServiceLevelValueSet	ServiceLevelValueSet
N/A	ServiceMessage	N/A
N/A	ServiceMessageHandler	N/A
N/A	ServiceOperation	ServiceInterfaceOperation
N/A	ServiceParameter	ServiceInterfaceParameter
Agreement	ServicePolicy	ServicePolicy
ServicePort	ServicePort	ServiceInterface
N/A	ServiceStateMachine	N/A
Skill	Skill	Competence
Skill	Skill	Skill
skillOfPersonRoleType	SkillOfPersonType	ProvidesCompetence/ RequiresCompetence
Materiel	Software	Software
FunctionalStandard	Standard	Standard
Standard	Standard	Standard
N/A	StandardConfiguration	StandardConfiguration

DoDAF-DM2, UPDM, and MODAF Mapping		
DoDAF-DM2 Term	UPDM Profile Element	MODAF
Activity	StandardOperationalActivity	StandardOperationalActivity
startBoundary	startBoundary tag	N/A
N/A	StatusIndicators	StatusIndicator
N/A	StereotypeExtension	StereotypeExtension
Address	String on ActualLocation	Location
MeasureTypeUnitsOfMeasure	SysML DimensionType	N/A
System	System	ResourceArtifact/ Capability Configuration
TechnicalStandard	TechnicalStandard	Standard
N/A	TemporalPart	EnterpriseTemporalPart
N/A	Trustline	Trustline
N/A	Trustline	Trustline
superSubType	UML inheritance	N/A
Country	Use GeoPoliticalExtent with appropriate geopoliticalExtentKind	N/A
GeoFeature	Use GeoPoliticalExtent with appropriate geopoliticalExtentKind	Location
Installation	Use GeoPoliticalExtent with appropriate geopoliticalExtentKind	N/A
InstallationType	Use GeoPoliticalExtent with appropriate geopoliticalExtentKind	N/A
CountryType	Use GeoPoliticalExtenttype with appropriate geopoliticalExtentTypeKind	N/A
GeoFeatureType	Use GeoPoliticalExtenttype with appropriate geopoliticalExtentTypeKind	Location
N/A	VersionOfConfiguration	VersionOfConfiguration
N/A	View	View
N/A	Viewpoint	Viewpoint
Vision	Vision	EnterpriseVision/ VisionStatement
Vision	VisionStatement	VisionStatement
N/A	WholeLifeConfiguration	WholeLifeConfiguration
N/A	WholeLifeEnterprise	WholeLifeEnterprise

Table C:1 - DoDAF-DM2, UPDM, and MODAF Mapping

C.2 UPDM to NAF Elements Traceability

NAF 3.1 was based on MODAF 1.2.003 and contains a few additions compared to MODAF. If it is compared with MODAF 1.2.004 the number of differences increases. However, the intent of the differences is approximately the same as the additions made in 1.2.004 with some exceptions such as security handling, etc. Based on the limited number of difference between the two meta-models, it is a simple statement of fact that UPDM fully supports NAF.

The list below itemizes the differences between NAF 3.1 and MODAF 1.2.003 with some explanations as to why they are there.

Table C:2 shows the traceability among the NAF 3.1 Views and their elements and those of the MODAF Views and their elements within the UPDM Profile.

NAF 3.1 and MODAF View Comparison	
NAF View/Element	MODAF View/Element
NAV-1 Overview and summary information	AV-1 Overview and summary information
NAV-1 Architectural Product	AV-1 Architectural product
NAV-2 Integrated dictionary	AV-2
NAV-3 Metadata	-
The following two views contain elements that are already in AV-2 in MODAF and a specific view in order to textually describe architecture compliance.	
NAV-3a Architecture compliance statement	
NAV-3b Metadata extensions	
NAV Effectivity	Effectivity
NAV Environment	Environment
NAV Measurable properties	Measurable properties
NAV Requirements	Requirements
NCV-1 Capability vision	StV-1
NCV-2 Capability taxonomy	StV-2
NCV-3 Capability phasing	StV-3
NCV-4 Capability dependencies	StV-4
NCV-5 Capability to organizational deployment mapping	StV-5
NCV-6 Operational activity to capability mapping	StV-6
NOV-1 High level operational concept description	OV-1
NOV-2 Operational node relationship description	OV-2
NOV-3 Operational information exchange matrix	OV-3

NAF 3.1 and MODAF View Comparison	
NAF View/Element	MODAF View/Element
NOV-4 Organizational relationships chart Typical	OV-4 Typical
NOV-4 Organizational relationships chart Actual	OV-4 actual
NOV-5 Operational activity model	OV-5
NOV-6 Operational activity sequence and timing description	OV-6
NOV-6a Operational rule model	OV-6a
NOV-6b Operational state transition description	OV-6b
NOV-6c Operational event-trace description	OV-6c
NOV-7 Information model	OV-7
NSOV-1 Service taxonomy	SOV-1
NSOV-2 Service definition	SOV-2
NSOV-3 Capability to service mapping	SOV-3
NSOV-4 Service constraints, state model and interaction specification	SOV-4
SOV-5 Service functionality	SOV-5
NSOV-6 Service composition	-
<p>The NSOV-6 Service composition view has a complicated history. When the service views were created in MODAF 1.1 and included as proposed it was placed as SOV-3. When MODAF 1.2 was created it was not included since the appreciation of what the intent was less than clear in MOD. The elements that were needed to create it still exist in the MODAF meta-model and this is still the case in MODAF 1.2.004. When NAF 3.1 as created the view was retained but in order to align with MODAF 1.2.003 it was moved from its original place and became view NSOV-6 instead of 3. The reasoning behind this view has to do with reuse of existing specifications of services and therefore ties together with any discussion concerning the separation of the SoaML concept of service and the specification of services which is what both the NAF and MODAF views are about.</p>	
NSV-1 Resource Interaction specification	SV-1
NSV-1 Resources specification	SV-1
NSV Competence	Competence
NSV-2 Systems communications description	
NSV-2a System port specification	SV-2a

NAF 3.1 and MODAF View Comparison	
NAF View/Element	MODAF View/Element
NSV-2b System port connectivity	SV-2b
NSV-2c System connectivity clusters	SV-2c
NSV-2d Systems communications quality requirements -	
The NSV-2d Systems communications quality requirements view contains exactly the same elements as NSV-2b with the exception of one additional element namely Network. This is unique to NAF and is a specialization of System. Since it has no additional relationships or attributes, it is essentially equivalent to System.	
NSV-3 Resource Interaction Matrix	SV-3
NSV-4 System Functionality description	SV-4
NSV-5 System function to operational activity traceability matrix	SV-5
NSV-6 Systems data exchange matrix	SV-6
NSV-7 System quality requirements description	SV-7
NSV-8 System configuration management	SV-8
NSV-9 Technology and skills forecast	SV-9
NSV-10 Resource constraints, state transitions and even-trace description	SV-10
NSV-10a Resource constraints specification	SV-10a
NSV-10b Resource state transition description	SV-10b
NSV-10c Resource event trace description	SV-10c
NSV-1 1 System data model -	
NSV-1 1a Logical data model -	The meta-model for this is the same as for NOV-7. The level of detail differs however.
NSV-1 1b Physical data model	SV-1 1
NSV-12 Service provision	SV-12
NTV-1&2 Standards profile and standards forecast	TV-1&2
NTV-3 Standard configurations	TV-3
NPV-1 Programme portfolio relationships	AcV-1

NAF 3.1 and MODAF View Comparison	
NAF View/Element	MODAF View/Element
NPV-2 Programme to capability mapping	AcV-2

Table C:2 - NAF 3.1 and MODAF View Comparison

C.2.1 Element additions in NAF 3.1 compared to MODAF 1.2.003

- **AV:** ArchitectureComplianceStatement - A comment stereotype enabling statements of architectural compliance that can be attached to various elements.
- **OV:** OperationalActivityFlowItem - An element created in order to allow transfer of other things between activities than information elements. A slightly different way was used to achieve the same purpose in MODAF 1.2.004. Supported in UPDM.
- OperationalExchangeMessage - An element intended to allow the handling of messages in an NOV-6c showing other things than just information elements. A slightly different mechanism was used to achieve the same purpose in MODAF 1.2.004. Supported in UPDM.
- **SV:** Energy (Class) - Inserted to handle UPDM 1.0 Energy. Is contained in MODAF 1.2.004. Supported in UPDM.
- FunctionAction (CallBehaviorAction) - Inserted to make NSV-4 equivalent to NOV-5. Done in MODAF 1.2.004 but differently. Supported in UPDM.
- FunctionComposition (Association) - Inserted to allow decomposition of functions. Not included explicitly in MODAF 1.2.004. Supported in UPDM.
- FunctionFlowItem - A system equivalent of OperationalActivityFlowItem. Done in MODAF 1.2.004 but differently. Supported in UPDM.
- FunctionInputPin - Inserted to make NSV-4 equivalent to NOV-5. Done in MODAF 1.2.004 but differently. Supported in UPDM.
- FunctionOutputPin - Inserted to make NSV-4 equivalent to NOV-5. Done in MODAF 1.2.004 but differently. Supported in UPDM.
- Network (Property) - A specialization of System desired by NATO. Not included in MODAF 1.2.004. Not supported in UPDM.
- ResourceExchangeMessage (Message) - Inserted in order to allow sequence diagrams to show something other than information elements. Done in MODAF 1.2.004 but differently. Supported in UPDM.
- ResourcesWithMaterielContent (Class) - Inserted as a container for various items enabling exchange of material as well as whole capability configurations. Not done in MODAF 1.2.004 implying that physical architectures or capability configurations cannot be exchanged in MODAF 1.2.004. Supported in UPDM.

C.2.2 DoDAF 2.0 to MODAF 1.2 Views Traceability

Table C:3 shows the traceability between the DoDAF 2.0 and MODAF 1.2 views. It is evident from the table that there is sufficient mapping between most of the views.

Traceability between the DoDAF 2.0 and MODAF 1.2 Views.		
DoDAF 2 views	MODAF 1.2 views	Comment

Traceability between the DoDAF 2.0 and MODAF 1.2 Views.		
DoDAF 2 views	MODAF 1.2 views	Comment
AV-1 Overview and summary	AV-1 Overview and summary information	-
AV-2 Integrated dictionary	AV-2 Integrated dictionary	-
OV-1 High level operational concept graphic description	OV-1 a High Level Operational Concept Graphics, OV-1b Operational Concept Description, OV-1c Operational Performance attributes	-
OV-2 Operational resource flow description	OV-2 Operational Node Relationships Description	-
OV-3 Operational Resource flow matrix	OV-3 Operational Information Exchange Matrix	-
OV-4 Organizational relationships chart	OV-4 Organizational Relationships Chart	-
OV-5a Operational activity decomposition tree	OV-5 Operational Activity Model	Both DoDAF diagrams is dealt with in the same MODAF diagram.
OV-5b Operational activity model	OV-5 Operational Activity Model	Both DoDAF diagrams is dealt with in the same MODAF diagram.
OV-6a Operational rules model	OV-6a Operational Rules Model	-
OV-6b State transition description	OV-6b Operational state transition description	-
OV-6c Event-trace description	OV-6b Operational event-trace description	-
StdV-1 Standards profile	TV-1 Standards profile	-
StdV-2 Standards forecast	TV-2 Standards forecast	-
PV-1 Project portfolio relationships	AcV-1 Acquisition clusters	-
PV-2 Project timelines	AcV-2 Programme timelines	-
PV-3 Project to capability mapping	-	It is difficult to see any difference to this and CV-3 Capability phasing. At least it is covered by StV-3 Capability phasing.
CV-1 Vision	StV-1 Enterprise vision	-
CV-2 Capability taxonomy	StV-2 Capability taxonomy	-
CV-3 Capability phasing	StV-3 Capability phasing	-
CV-4 Capability dependencies	StV-4 Capability dependencies	-
CV-5 Capability to organizational mapping	StV-5 Capability to organization deployment mapping	-

Traceability between the DoDAF 2.0 and MODAF 1.2 Views.		
DoDAF 2 views	MODAF 1.2 views	Comment
CV-6 Capability to operational activities mapping	StV-6 Operational activity to capability mapping	It should be noted that DoDAF has no counterpart of StandardOperationalActivities which is the reason behind this view in MODAF.
CV-7 Capability to services mapping	SOV-3 Capability to service mapping	See handling of services below since this is where the connection break down between MODAF and DoDAF 2.0 to a large extent.
DIV-1 Conceptual data model	-	This looks like the NAF 3.1 NOV-7 concept but has no direct counterpart in MODAF.
DIV-2 Logical data model	OV-7 Information Model	-
DIV-3 Physical data model	SV-1 1 Physical schema	-
SV-1 Systems interface description	SV-1 Resources interaction specification	-
SV-2 Systems resource flow description	SV-2a System port specification, SV-2b System to system port connectivity description, SV-2c System connectivity clusters	-
SV-3 Systems - systems matrix	SV-3 Resource interaction matrix	-
SV-4 Systems functionality description	SV-4 Functionality description	-
SV-5a Operational activity to systems traceability matrix	-	There is no direct counterpart to this traceability in a direct form in MODAF
SV-5b Operational activity to systems function traceability matrix	SV-5 Function to Operational activity traceability matrix	-
SV-6 Systems resource flow matrix	SV-6 Systems data exchange matrix	-
SV-7 Systems measures matrix	SV-7 Resource performance parameters matrix	-
SV-8 Systems - systems evolution matrix	SV-8 Capability configuration management	-
SV-9 Systems technology & skills forecast	SV-9 Technology and skills forecast	-
SV-10a Systems rules model	SV-10a Resource constraints specification	-
SV-10b Systems state transition description	SV-10b Resource state transitions description	-
SV-10c Systems event-trace description	SV-10c Resource event-trace description	-

Traceability between the DoDAF 2.0 and MODAF 1.2 Views.		
DoDAF 2 views	MODAF 1.2 views	Comment
Services handling in MODAF 1.2.004 and DoDAF 2.0	The services concept in MODAF and DoDAF differ significantly, they are therefore treated differently in this table with connections shown only when a limited semblance exists. The MODAF or DoDAF counterparts here are written in italics.	
-	SOV-1 Service taxonomy	No formal taxonomy view for services exist in DoDAF 2.0
-	SOV-2 Service interface specification	SvcV-2 is a possible candidate but the definitions in MODAF go a lot deeper than in DoDAF 2.0. The comparison also disregards the fact that services in MODAF are specifications of services whereas services in DoDAF seem to describe implementations in specific performers, albeit somewhat more abstract than real implementation descriptions. This is a general caveat and applies to all MODAF view comments below.
-	SOV-3 Capability to service mapping	Presumably this maps somewhat to CV- 7 in DoDAF 2. The general caveat applies.
-	SOV-4a Service constraints	This maps somewhat to SvcV-10a in DoDAF 2. The general caveat applies.
-	SOV-4b Service state model	This maps somewhat to SvcV-10b in DoDAF 2. The general caveat applies.
-	SOV-4c Service interaction specification	This maps somewhat to SvcV-10c in DoDAF 2. The general caveat applies.
-	SOV-5 Service functionality	This maps somewhat to SvcV-4 in DoDAF 2. The general caveat applies.
-	SV-12a Service provision	This maps somewhat to SvcV-1 in DoDAF 2. Since this discusses realizations of services the mapping may well be somewhat stronger than previously described. DoDAF Service would here be viewed as ServiceLevel in MODAF.
-	SV-12b Service composition	This maps somewhat to SvcV-2 in DoDAF 2. Since this discusses realizations of services the mapping may well be somewhat stronger than previously described. DoDAF Service would here be viewed as ServiceLevel in MODAF.
SvcV-1 Services context description	SV-12a Service provision	See above
SvcV-2 Services resource flow description	SV-12b Service composition	See above

Traceability between the DoDAF 2.0 and MODAF 1.2 Views.		
DoDAF 2 views	MODAF 1.2 views	Comment
SvcV-3a Systems - services matrix	SV-12a Service provision	The MODAF reference is not a Matrix, the data intended should be derivable from this MODAF view however.
SvcV-3b Services - services matrix	SV-12b Service composition	The MODAF reference is not a Matrix, the data intended should be derivable from this MODAF view however.
SvcV-4 Services functionality description	SOV-5 Service functionality, (perhaps more SV-4)	The general caveat applies.
SvcV-5 Operational activity to services traceability	SV-5 Service function to Operational activity traceability matrix.	The general caveat applies.
SvcV-6 Services resource flow matrix	SV-12a Service provision	See above
SvcV-7 Services measures matrix	SV-7 Resource performance parameters matrix	The general caveat applies.
SvcV-8 Services evolution description	SV-8 Capability configuration management	The general caveat applies.
SvcV-9 Services technology & skills forecast	SV-9 Technology and skills forecast	The general caveat applies.
SvcV-10a Services rules model	SOV-4a Service constraints perhaps more SV-1 0a.	The general caveat applies.
SvcV-10b Services state transition description	SOV-4b Service state model perhaps more SV-1 0b	The general caveat applies.
SvcV-10c Services event-trace description	SOV-4c Service interaction specification perhaps more SV-1 0c	The general caveat applies.

Table C:3 - Traceability between the DoDAF 2.0 and MODAF 1.2 views.

Annex D Sample Problem

(non-normative)

D.1 Purpose

The purpose of this annex is to illustrate how UPDM can support DODAF and MODAF requirements for organizations developing Network Enabled Capability (NEC) systems using some of the basic features of the specification. This example provides a model which illustrates a sample of DoDAF and MODAF views addressing the problem space described below.

D.2 Scope

The scope of this example is to provide diagrams for the views (DoDAF Models) that are most used and most requested by the defense community. The intent is to select portions of the sample problem to illustrate how the diagrams can be applied, and demonstrate some of the possible interrelationships among the model elements in the different diagrams. The sample problem does not highlight all of the features of the specification as that would take several hundred pages.

D.3 Problem Scenario

D.3.1 Problem Domain Suitability

The problem domain is civilian maritime search and rescue (SAR). Civilian SAR was selected for several reasons:

- UK MODAF 1.1 has previously used this domain to illustrate its framework².
- The scenario and modeling was easily updated to include UPDM concepts including US DoDAF 2.0.
- SAR is internationally recognized problem domain with easy-to-recognize typical scenarios.
- SAR is based on publicly available International Agreements³ and implementing or conforming National Plans including the US⁴ and the UK⁵.
- The documentation is generally unclassified as opposed to many equivalent defense or military plans.
- Subject matter experts and periodicals are readily available⁶.

² See Acknowledgements.

³ See for example, International Aeronautical and Maritime Search and Rescue (IAMSAR) Manual, 2007 ed., 6th ed. London: IMO; Montreal: ICAO, 2007. IAMSAR Manual is by jointly published by the International Maritime Organization (IMO) and the International Civil Aviation Organization (ICAO). It consists of a three volume set: Volume I is Organization and Management; Volume II is Mission Coordination; & Volume III is Mobile Facilities.

⁴ See for example, U.S. National Search and Rescue Supplement (NSS) to the International Aeronautical and Maritime Search and Rescue Manual. National Search and Rescue Plan of the United States (US National SAR Plan). [http://www.uscg.mil/hq/cg5/cg534/manuals/Natl_SAR_Plan\(2007\).pdf](http://www.uscg.mil/hq/cg5/cg534/manuals/Natl_SAR_Plan(2007).pdf)

⁵ See for example, Search and Rescue Framework for the United Kingdom of Great Britain and Northern Ireland, Queen's Printer and Controller, June 2002. (Published by MCGA - Maritime & Coastguard Agency, Spring Place, 105 Commercial Road, Southampton. SO15 1EG.) "The organization for Search and Rescue (SAR) in the UK is an amalgam of separate Governments Departments, the emergency services, and other organizations. A number of charities and voluntary organizations dedicated to SAR also play a significant role. The purpose of this document is to provide a management framework for SAR in the UK. (back cover)" http://www.mcga.gov.uk/c4mca-uk/mcga-uk_sar_framework_document.pdf

- The domain is sufficiently large and complex involving mixed human, software, and hardware solutions. As such, it will support the current specification that includes parametric modeling from systems engineering (SysML)⁷ as well as future evolutions of UPDM that may include more national and multinational architecture frameworks. Several of the countries share usage of the same automated information systems and sensors.

D.3.2 Acknowledgements

The scenario is derived from the UK Search and Rescue framework, which is publicly available on the Internet⁸. The sample problem is based on a concept derived by VEGA under contract for the UK MOD⁹. The UPDM Group acknowledges its debt owed to the authors of the original problem:

- Ian Bailey of Model Futures
- Peter Bryant of Logica
- Paul King of Vega

We have modified it to make it more generic in order to allow it to apply to SAR architecture for any country. This allows us to communicate the use of UPDM without the need for too much detail or getting involved in the particular procedures of any given country. Consequently, there will be "errors" in the specifics of the procedures. Any suggestions on how to improve the model would of course be gratefully received by the UPDM Group.

D.3.3 Summary

We have included as many of the UPDM diagrams as is possible given that the tools for creating diagrams compliant with UPDM 2.0 will not be created until after the release of this specification. In addition, presenting an architecture is something like telling a story with the exception that in this case the elements interrelate to an extent that it is difficult to pick a natural order. Consequently we have decided to present them by view as that will at least make them easier to find when attempting to cross reference them. As UPDM 1.0 has more in common with MODAF 1.2, the models were created in the MODAF version of UPDM and the labels changed to correspond to DoDAF 2.0 terminology.

Those familiar with the terminology in DoDAF 2.0 and MODAF 1.2 are aware that the two architecture frameworks are different. In order to avoid having to show a MODAF and a DODAF diagram for each example, simple variants for each diagram are described. Where they are significantly different duplicate diagrams are shown.

D.3.4 The "Yacht in Distress" Scenario

The Sample Problem applies UPDM to a common scenario in civilian maritime Search and Rescue (SAR) operations -- a yacht in distress. A monitoring unit picks up the distress signal from the yacht and passes it on to the Command and Control (C2) Center. The C2 Center coordinates the search and rescue operation among helicopters, a naval ship and a civilian voluntary sea rescue organization. This sub clause is structured to show each diagram in the context of how it might be used in such an example problem.

⁶ See for example, ON SCENE - The Journal of U.S. Coast Guard Search and Rescue. Summer 2008, "Exceptional SAR Stories," pp. 29-40 for more detailed scenarios similar to the Problem Scenario and Fall 2003, "SPECIAL SECTION - SAR Case Studies: A Review," pp. 18-28 regarding performance standards.

⁷ See USCG, "SAR System Performance Benchmark" - "Percent of lives saved from imminent danger in the maritime environment" and sub benchmarks. http://uscg.mil/hq/cg5/cg534/SAR_Program_Info.asp (Current as of 29 April 2009).

⁸ See "MODAF: Examples: Search and Rescue Example: and the corresponding files are at http://www.modaf.org.uk/file_download/33/SAR.zip (as of 29 April 2009).

⁹ <http://www.modaf.org.uk/vExamples/163/search-and-rescue-example>.

D.4 Diagrams

D.4.1 Package Overview (Structure of the Sample Model)

Table D:1 below provides definitions for acronyms used in this sample problem.

Sample Model SAR Acronyms	
Acronym	Expansion
DoT	Department of Transport
NIMROD	Aircraft name
MRA	Maritime Role Aircraft
ESM	Electronic Signal Monitoring
TDM	Time Division Multiplex
MRT	Maritime Rescue Team
SAR	Search and Rescue
C2	Command and Control

Table D:1 - Acronyms

D.4.2 Flow of SAR Example Models

Figure D:1 shows the flow of the SAR example models through the different viewpoints. Beginning with the All Viewpoint, the natural progression is through the key Strategic Views, the key Operational Views, the key Service Oriented Views, the key Systems Views, and finally to the Acquisition Views. Following that are some fit for purpose views to demonstrate additional analysis and definition capabilities.

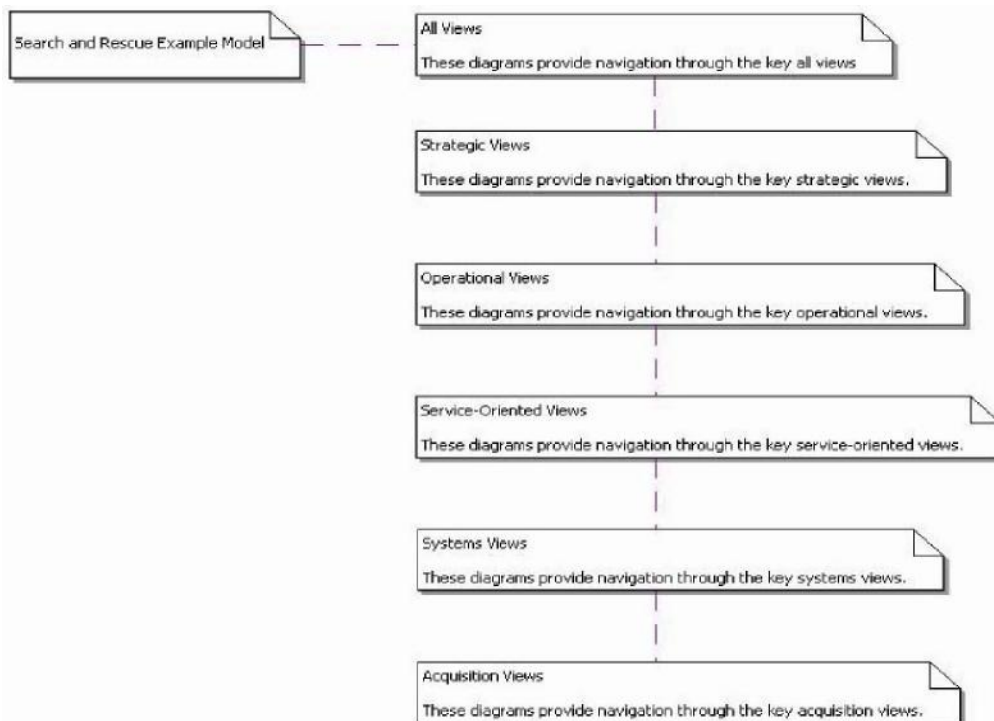

Figure D:1 - Diagram Flow

D.5 All Views

The All Views provide overview and summary information as well as an integrated dictionary. This information is provided in a consistent form that allows quick reference and comparison among architectures.

D.6 AV-1 Enterprise Definition

The text shown in Figure D:2 provides executive-level summary information in a consistent form that allows quick reference and comparison between architectural descriptions. It includes assumptions, constraints, and limitations that may affect high-level decisions relating to an architecture-based work program.

Architecture Project Identification

- Name: SAR Architecture
- Architect: Bill Firenz
- Developing Organization: Maritime & Coastguard Agency
- Assumptions and Constraints: None
- Approval Authority: Howard Overtree, Project Manager
- Date Completed: TBD

Scope

- Views & Products Developed:
 - Acquisition views: AcV-1, AcV-2, AcV-3
 - All views: AV-1, AV-2, AV-3
 - Operational views: OV-1a, OV-1b, OV-1c, OV-1d, OV-2, OV-3, OV-4, OV-5, OV-6a, OV-6b, OV-6c, OV-7
 - Service Orientated views: SOV-1, SOV-2, SOV-3, SOV-4a, SOV-4b, SOV-5
 - Strategic views: StV-1, StV-2, StV-3, StV-4, StV-5, StV-6
 - System views: SV-1, SV-2, SV-3, SV-4, SV-5, SV-6, SV-7, SV-8, SV-9, SV-10a, SV-10b, SV-10c, SV-11, SV-12
 - Technical views: TV-1, TV-2, TV-3
 - Time Frames Addressed: Present
 - Organizations Involved: Dept. of Transport, Maritime & Coastguard Agency

Purpose and Viewpoint

- Purpose of the Architecture: To detect and locate mariners, aviators, and recreational enthusiasts in distress
- Architecture Viewpoint: Users of the system

Context

- Mission: Manage, coordinate and implement SAR activities
- Doctrine, Goals & Vision: TBD

- Rules, Criteria & Conventions: TBD
- Tools and File Formats:
 - Tools: UML, IDE, Word, and Excel
 - File Formats: DOCX, XLS and UML IDE Models

Findings

- Analysis Results: TBD
- Recommendations: TBD

Figure D:2 - AV-1

D.6.1 AV-2 Architecture Dictionary

Architecture development projects not using model-based techniques would often create an initial dictionary defining terms and names for the different model elements. Diagrams created in Microsoft PowerPoint or Visio would then be checked against this dictionary to ensure compliance. A model-based architecture using UPDM has in-built consistency in that elements appearing on different diagrams will have the same name as they are the same object. Consequently, the AV- 2 diagrams are reports generated from the model, which itself is the architecture dictionary. Table D:2 shows a generated report of the operational activities in the model. There are fields for the name, the complete name in the model package hierarchy, the definition of the activity, the alias, and any elements for which this is the same.

DoDAF 2.0 variant: In DoDAF 2.0 the Operational Activity would simply be called an Activity.

OperationalActivity				
Name	Full Scoped Name	Definition	Alias	Same As
Monitor For Distress Signal	SAR Architecture::Operational Activities::Monitor For Distress Signal			
Process Warning Order	SAR Architecture::Operational Activities::Process Warning Order			
Receive Distress Signal	SAR Architecture::Operational Activities::Receive Distress Signal			
Rescue	SAR Architecture::Operational Activities::Rescue			
Search	SAR Architecture::Operational Activities::Search			
Send Distress Signal	SAR Architecture::Operational Activities::Send Distress Signal			
Send Warning Order	SAR Architecture::Operational Activities::Send Warning Order			
Transit To SAR Operation	SAR Architecture::Operational Activities::Transit To SAR Operation			

Table D:2 - AV-2 Operational Activity Dictionary report

Table D:3 shows the generated report of the Capability Configurations in the model. The fields are the same as the previous report in Table D:2.

DoDAF 2.0 Variant: In DoDAF 2.0 the Capability Configuration would be a Performer.

CapabilityConfiguration				
Name	Full Scoped Name	Definition	Alias	Same As
Automated Rescue Unit v1	SAR Architecture::Resources::Capability Configurations::Automated Rescue Unit v1			
Control Center	SAR Architecture::Resources::Capability Configurations::Control Center			
Maritime Rescue Architecture v1	SAR Architecture::Resources::Capability Configurations::Maritime Rescue Architecture v1			
Maritime Rescue Unit v1	SAR Architecture::Resources::Capability Configurations::Maritime Rescue Unit v1			
Maritime Rescue Unit v2	SAR Architecture::Resources::Capability Configurations::Maritime Rescue Unit v2			
Monitor	SAR Architecture::Resources::Capability Configurations::Monitor			

Table D:3 - AV-2 Capability Configuration Dictionary report

D.6.2 AV Measurements Definition (Fit for Purpose)

Figure D:3 shows the class diagram version of the measurements diagram. This provides a means of defining types of measurements that are important to the system. These consist of measurable quantitative measurements. It defines the measurements that are important to the capabilities in the strategic view such as find time and persistence, shown later.

These concepts are defined in All Views, as they can pertain to all elements in all views of the model. Metrics specific to System elements are addressed in the SV-7. As there is no diagram MODAF or DoDAF in All Views for expressing this information, we have created a new diagram. This could be called AV-n, Measurements Definition or other suitable name. This is an example of the extensibility features provided by UML and SysML enabling the easy creation of fit for purpose views.

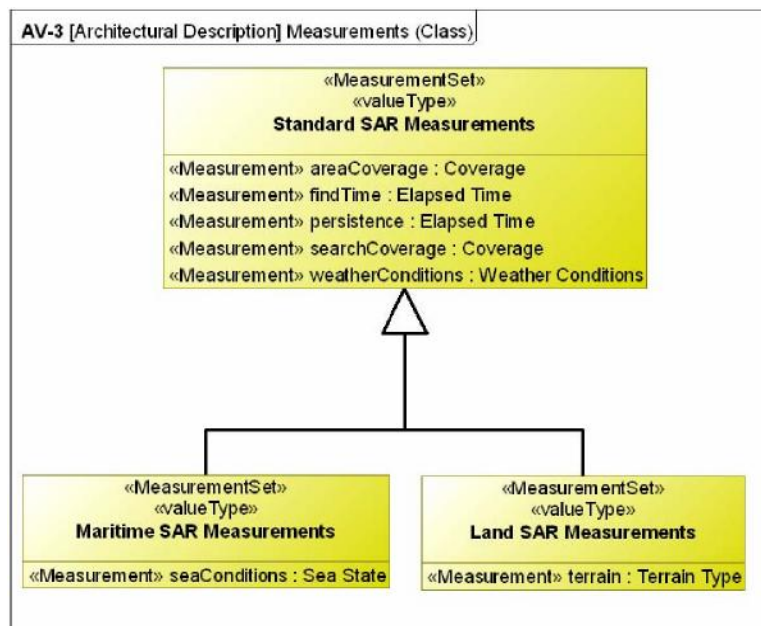

Figure D:3 - AV Measurements Class Diagram

D.6.3 AV Measurements Instances (Fit For Purpose)

Figure D:4 shows the instance diagram version of the measurements diagram. Instances of the measurements can be created and associated with architecture elements. In this case, they define the initial, required, and final values for SAR capabilities.

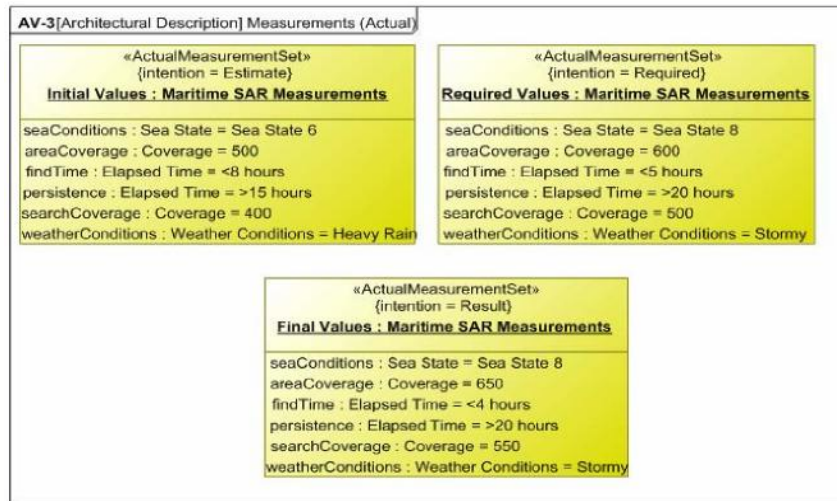

Figure D:4 - AV Measurements Instance Diagram

D.6.4 SysML Value Definitions - Fit For Purpose View

This SysML Block Definition Diagram (BDD) in Figure D:5 is used to define the value types, units and dimensions used in the measurements for the typical and actual measurements. This allows a more precise definition of the values and eliminates ambiguity. This is another example of a fit for purpose view.

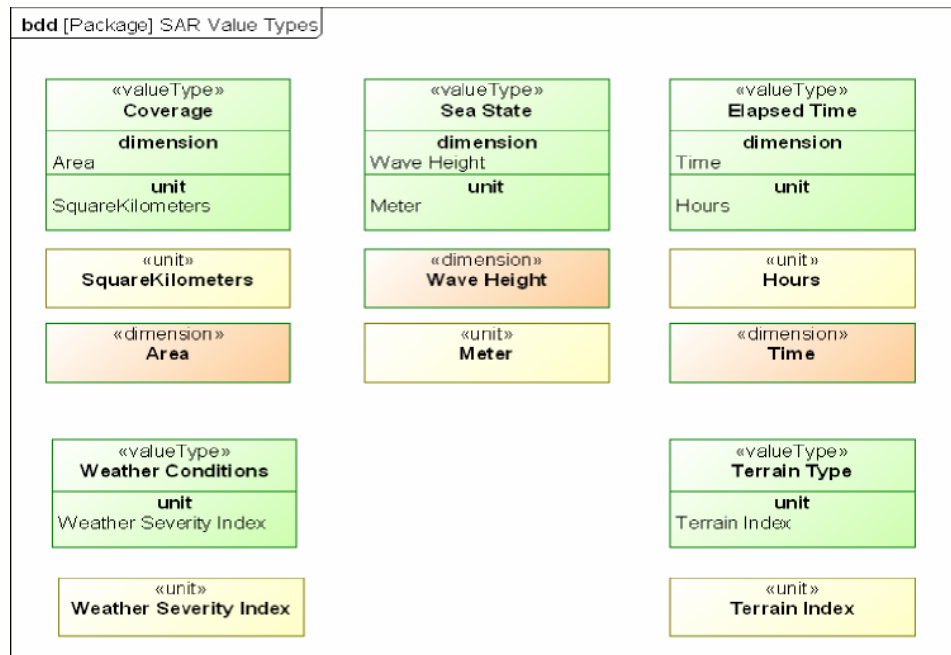

Figure D:5 - SysML BDD Units, Dimensions, and Value Types

D.6.5 SysML Requirements - Fit For Purpose View

One of the two principal extensions to OMG SysML is support for requirements. The "requirement" stereotype extends class to specify the textual "shall" statement and capture the requirement id#. The requirement diagram

is used to integrate the system models with text based requirements that are typically captured in requirements management tools. The UML containment relationship (circle with a plus sign) is used to decompose a requirement into its constituent requirements. A requirement is related to other key modeling artifacts via a set of stereotyped dependencies. The "deriveReq" and "satisfy" dependencies describe the derivation of requirements from other requirements and the satisfaction of requirements by design, respectively. The "verify" dependency shows the link from a test case to the requirement or requirements it verifies. In addition, the UML "refine" dependency is used to indicate that an OMG SysML model element is a refinement of a textual requirement, and "a copy" relationship is used to show reuse of a requirement within a different requirement hierarchy. The rationale concept can be used to annotate any model element to identify supporting rationale including analysis and trade studies for a derived requirement, a design or some other decision.

As UPDM level L1 has been built upon SysML, requirements can be integrated into the model. SysML traceability relationships can be used as shown in Figure D:6. The capabilities trace to the requirements and the Activities refine the requirements. System elements developed later in the design cycle will satisfy these requirements.

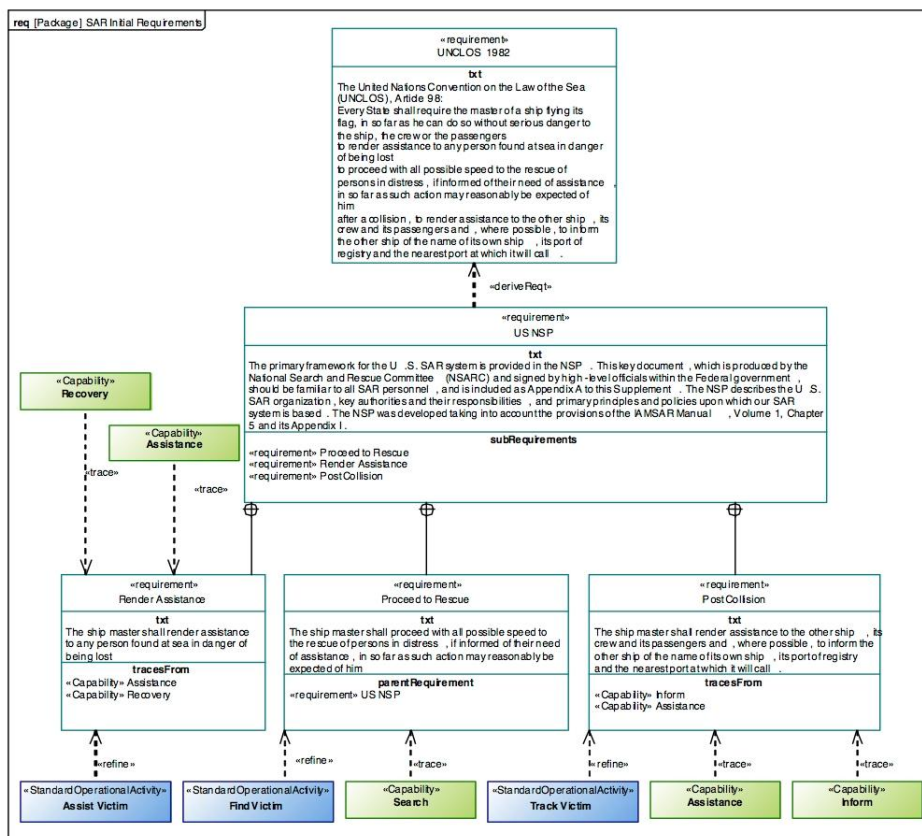

Figure D:6 - SysML Requirements

D.6.6 Strategic/Capability Views

The diagrams in the Strategic View (DoDAF 2.0 Capability Model) provide a capability view of the SAR operation. These views will show the relationships between these capabilities and between the capabilities and the resources required to realize them.

D.6.7 StV-1 Capability Vision (DoDAF CV-1)

Figure D:7 describes the strategic context for Search and Rescue Capabilities. It outlines the vision for a capability area over a specified period of time. It describes how high level goals and strategy are to be delivered in terms of capability. The concepts of the Whole Life Enterprise and Enterprise Phase are not elements in DoDAF 2.0.

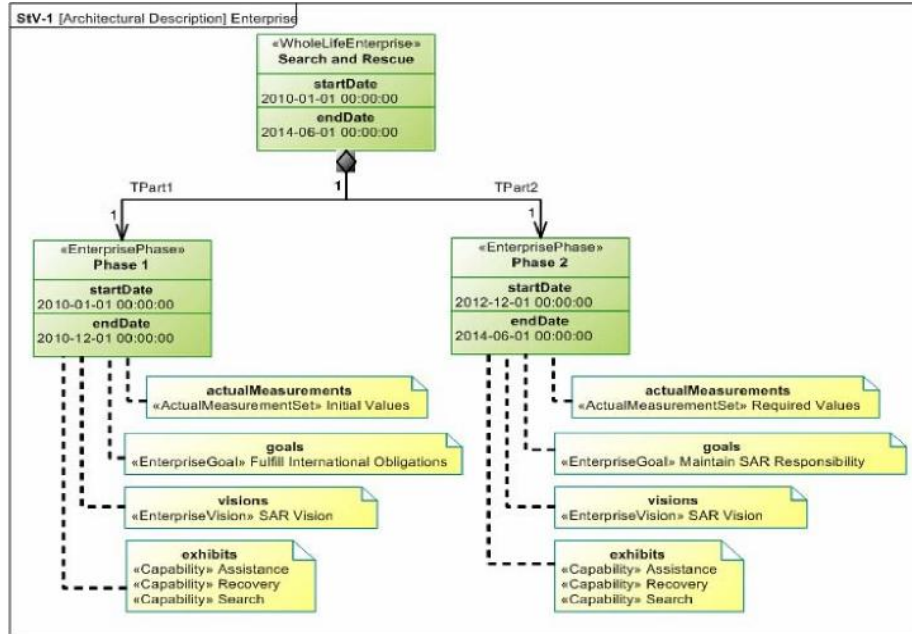

Figure D:7 - StV-1 Enterprise View

D.6.8 StV-2 Capability Taxonomy (DoDAF CV-2)

Capabilities need to be characterized in terms of the properties they need to exhibit which enable the enterprise to use them to achieve the enterprise goals, as well as their relationships in an inheritance hierarchy. In Figure D:8 we have characterized Maritime SAR in terms of required values. These are defined in Figure D:8 and include the length of a Maritime SAR operation, the sea conditions in which Maritime SAR must be deliverable, the search area covered by an operation and the time to find a victim.

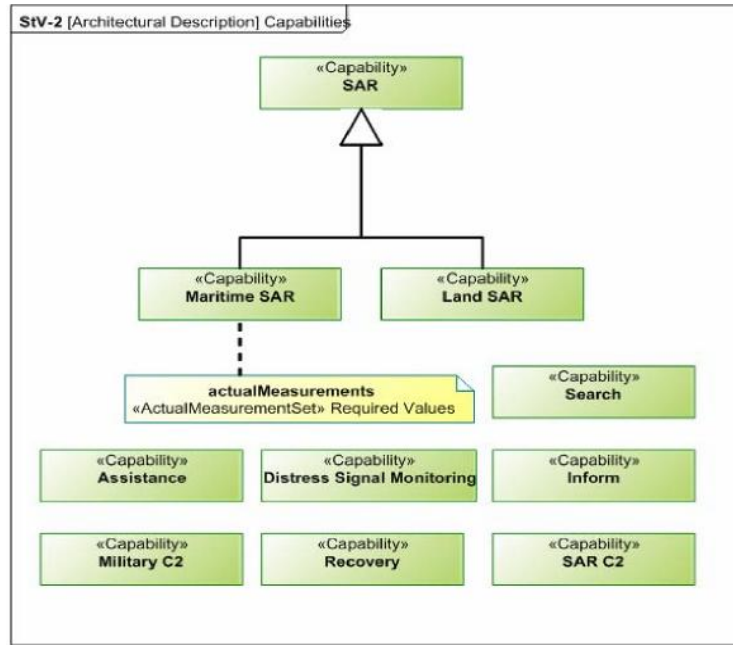

Figure D:8 - StV-2 Capability Taxonomy

D.6.9 StV-3 Capability Phasing (DoDAF CV-3)

StV-3 addresses the planned achievement of capability at different points in time or during specific periods of time, i.e., capability phasing. The example shown in Table D:4 is a generated report showing the capabilities, the systems that realize these capabilities and when they will be deployed and taken out of service, and the measurements that they are expected to achieve. Information for this report is defined using the AcV-3 Actual Projects diagram, the AV-3 measurements diagram, and the StV-2 Capability Taxonomy diagram.

	2010												2011											
	J	F	M	A	M	J	J	A	S	O	N	D	J	F	M	A	M	J	J	A	S	O	N	D
Assistance	Maritime Rescue Unit v1 (SAR Manual Project I)																							
seaConditions = Sea State 6 areaCoverage = 500 funcTime = <8 hours persistence = >15 hours searchCoverage = 400 weatherConditions = Heavy Rain																								
[no measurements]																								
													Maritime Rescue Unit v2 (SAR Manual Project II)											
seaConditions = Sea State 8 areaCoverage = 600 funcTime = <5 hours persistence = >20 hours searchCoverage = 500 weatherConditions = Stormy																								
Search	Maritime Rescue Unit v1 (SAR Manual Project I)																							
seaConditions = Sea State 6 areaCoverage = 500 funcTime = <8 hours persistence = >15 hours searchCoverage = 400 weatherConditions = Heavy Rain																								
[no measurements]																								
													Maritime Rescue Unit v2 (SAR Manual Project II)											
seaConditions = Sea State 8 areaCoverage = 600 funcTime = <5 hours persistence = >20 hours searchCoverage = 500 weatherConditions = Stormy																								

Table D:4 - StV-3 Capability Phasing

D.6.10 StV-4 Capability Clusters (DoDAF CV-4)

This StV-4 view addresses the logical grouping of capabilities and the dependencies between them. In Figure D:9, SAR Command and Control depends on the Military C2 Capability. Similarly, the Assistance, Search and Recovery Capabilities are dependent upon the SAR C2 Capability, which in turn is dependent upon the Distress Signal Monitoring Capability. The UML composite structure diagram in Figure D:9 provides a means to define capabilities within a specific context, in this case search and rescue. The dependencies are scoped to this context.

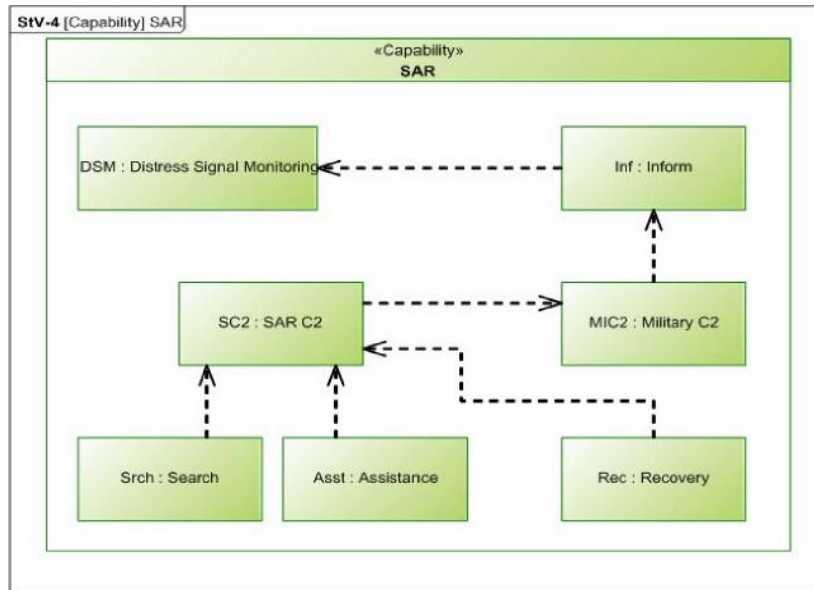

Figure D:9 - StV-4

D.6.11 StV-4 Capability Clusters Class Diagram (DoDAF CV-4)

Figure D:10 shows the class diagram version of the capability clusters. Dependencies can be defined between the capabilities, but there is no means to define a specific context.

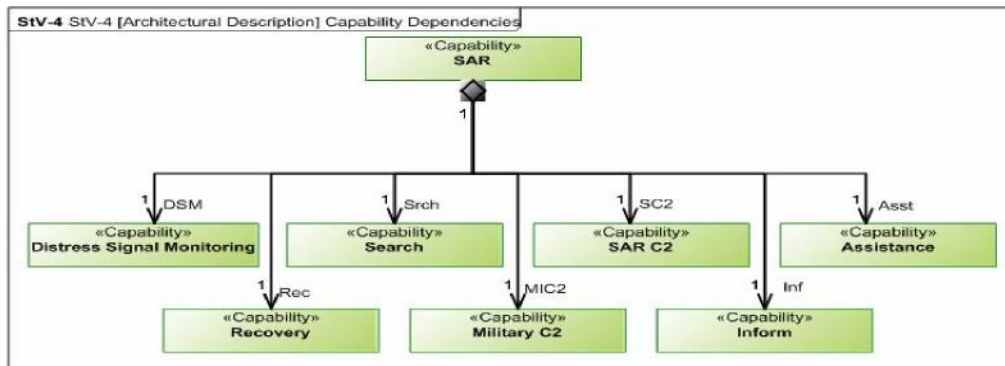

Figure D:10 - StV-4 Alternative View

D.6.12 StV-5 Capability to Organization Deployment (DoDAF CV-5)

Table D:5 shows the generated StV-5 table. The StV-5 defines Capability to Organization Deployment Mapping. It shows the planned capability deployment for a resource and the responsible organization. The StV-5 View is used to support the capability management process and, in particular, assist the planning of fielding. For example, the Assistance Capability is supported by the Maritime Rescue Unit. The Volunteer Rescue Organization and Maritime and Coastguard Agency are responsible for them.

		<u>Capabilities</u>			
		Assistance	Inform	Recovery	Search
<u>Organizational Resources</u>	«ActualOrganization» Coastguard	Maritime Rescue Unit v1	Maritime Rescue Unit v1	Maritime Rescue Unit v1	Maritime Rescue Unit v1
		Maritime Rescue Unit v2	Maritime Rescue Unit v2	Maritime Rescue Unit v2	Maritime Rescue Unit v2
	«ActualOrganization» Maritime & Coastguard Agency	Maritime Rescue Unit v1	Maritime Rescue Unit v1	Maritime Rescue Unit v1	Maritime Rescue Unit v1
		Maritime Rescue Unit v2	Maritime Rescue Unit v2	Maritime Rescue Unit v2	Maritime Rescue Unit v2
	«ActualOrganization» Volunteer Rescue Organization	Maritime Rescue Unit v1	Maritime Rescue Unit v1	Maritime Rescue Unit v1	Maritime Rescue Unit v1
		Maritime Rescue Unit v2	Maritime Rescue Unit v2	Maritime Rescue Unit v2	Maritime Rescue Unit v2

Table D:5 - StV-5

D.6.13 StV-6 Operational Activity to Capability Mapping (DoDAF CV-6)

This view, Figure D:11, identifies how operational activities support capabilities. Figure D:11 shows that in order to achieve Search and Assistance Capabilities, certain Standard Operational Activities must be performed, including Monitor Health and Provide Medical Assistance.

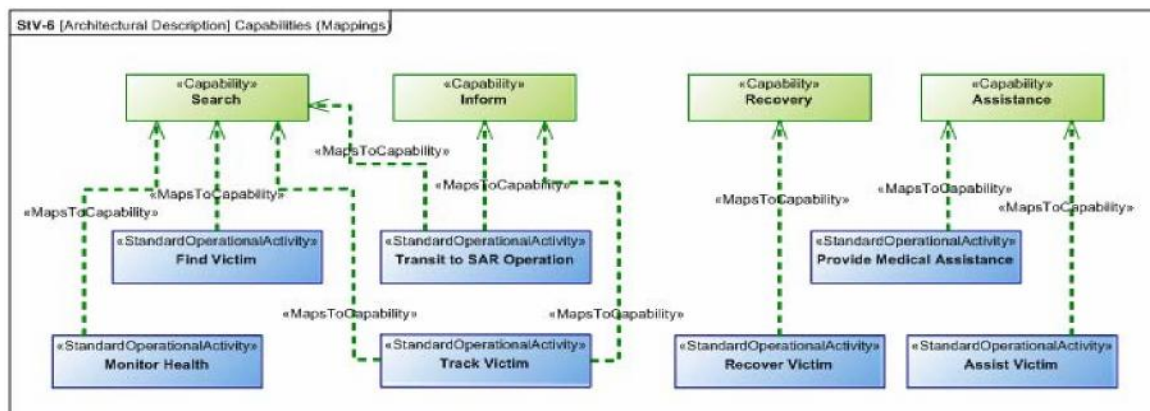

Figure D:11 - StV-6

D.7 Operational Views

The Operational Views identify what needs to be accomplished in the SAR operation and who needs to accomplish it. These views describe the tasks and activities, operational elements and exchanges of information, systems and energy that are required to conduct the operations.

D.7.1 OV-1a Operational Context Graphic

This diagram, Figure D:12, of the Maritime rescue sets the context by illustrating the search and rescue operation at sea involving a yacht in distress. The diagram shows that the monitoring unit picks up the distress calls of

the yacht and sends them to a Command and Control (C2) center, which coordinates the operation among helicopters, a naval ship, and a rescue boat.

In the OV-1a, each model element depicted may include a graphical depiction to help convey its intended meaning. The spatial relationships of the elements on the diagram sometimes convey their relative position, although this is not specifically captured in the semantics. A brief description of the interactions between the elements is provided. It may represent abstract conceptual relationships and will be refined in subsequent diagrams.

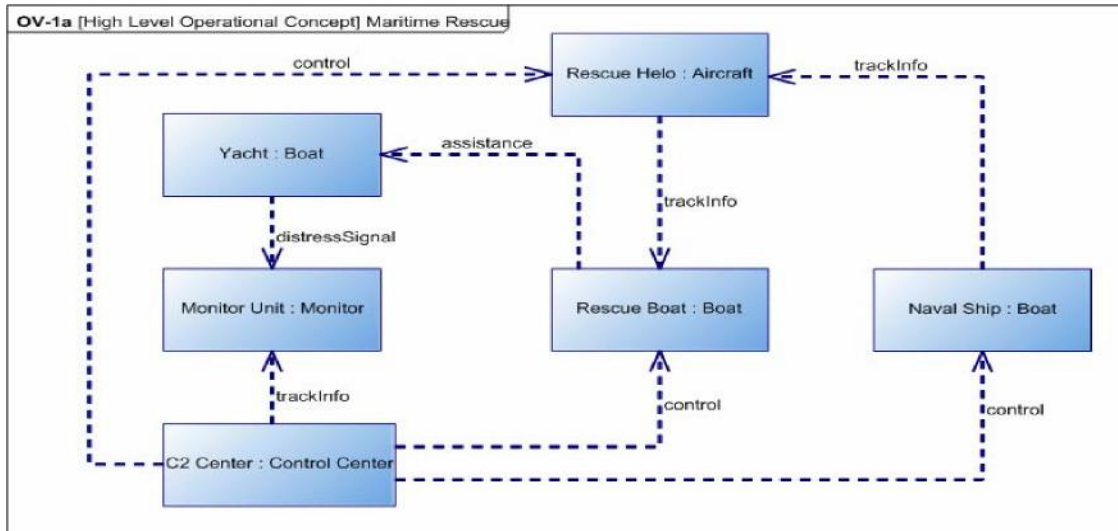

Figure D:12 - OV-1a

As shown in Figure D:13, a pictorial background can be included to provide additional context. The elements on the diagram are exactly the same. They are simply represented as graphics rather than boxes. This helps to communicate with domain experts who may not be familiar with architectural frameworks. They are also shown as graphics, symbols, and photos to demonstrate that any graphic can be used. The yacht is shown pictured as a lifeboat to emphasize that they are in distress.

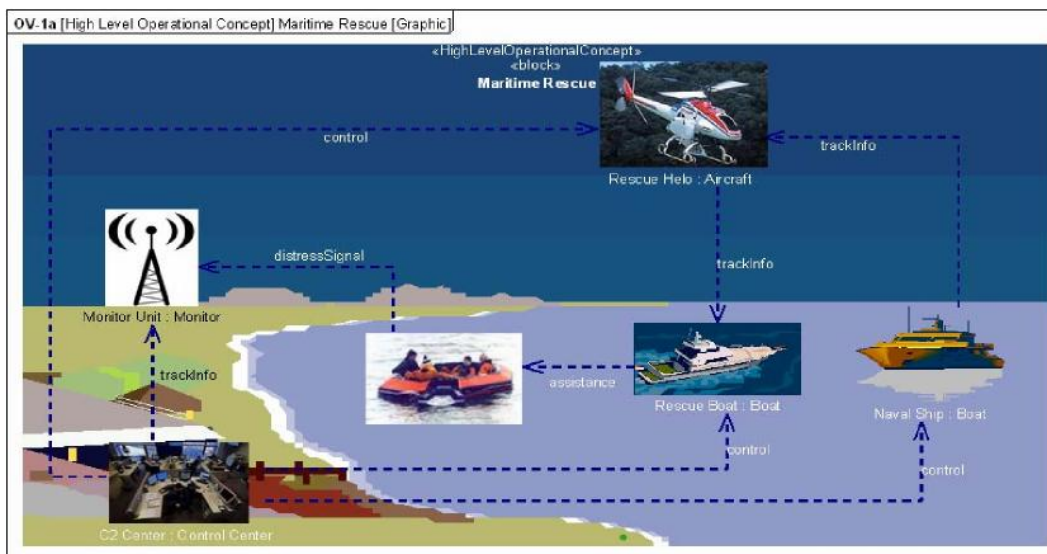

Figure D:13 - Alternate OV-1a

D.7.2 OV-1 b Operational Context Description

The text shown below in Figure D:14 describes the scenario depicted in Figure D:13. There is normally an OV-1b associated with each OV-1a.

The "Yacht in Distress" Scenario

The Sample Problem applies UPDM to a common scenario in civilian maritime Search and Rescue (SAR) operations -- a Yacht in distress. A Monitor Unit picks up the distressSignal from the Yacht and passes it on to the Command and Control (C2 Center). The C2 Center coordinates the search and rescue operation among the Rescue Helo, a Naval Ship and a Rescue Boat.

This model is based on a UK MOD example model.

D.7.3 OV-1c Operational Context Measurements

The OV-1c shown in Table D:6 provides a summary of the measures that the architecture is expected to achieve. These measures are defined in the AV-3 actual measurements diagram. The units and dimensions attached to the measurements were defined using the SysML BDD shown in Figure D:5. This view is not found in DoDAF 2.0, but could be a fit for purpose view.

Actual Measurement Set								
Name	Name	Intention	Measurement	Minimum Value	Actual Value	Maximum Value	Unit	Dimension
Maritime Rescue	Initial Values	Estimate	seaConditions	Sea State 1	Sea State 6	Sea State 10	Meter	Wave Height
			areaCoverage	100	500	1000	SquareKilometers	Area
		findTime	4	<8 hours	8	Hours	Time	
		persistence	5	>15 hours	22	Hours	Time	
		searchCoverage	200	400	600	SquareKilometers	Area	
	Required Values	Required	seaConditions	Sea State 1	Sea State 8	Sea State 10	Meter	Wave Height
			areaCoverage	100	600	1000	SquareKilometers	Area
		findTime	4	<5 hours	8	Hours	Time	
		persistence	5	>20 hours	22	Hours	Time	
		searchCoverage	200	500	600	SquareKilometers	Area	
	Final Values	Result	seaConditions	Sea State 1	Sea State 8	Sea State 10	Meter	Wave Height
			areaCoverage	100	650	1000	SquareKilometers	Area
		findTime	4	<4 hours	8	Hours	Time	
		persistence	5	>20 hours	22	Hours	Time	
		searchCoverage	200	550	600	SquareKilometers	Area	
		weatherConditions	Calm	Stormy	Hurricane	Weather Severity Index		

Table D:6 - OV-1c

D.7.4 OV-1d Operational Context Use Cases (Fit for Purpose)

A Mission defines a functional goal that the stakeholders have. This aligns well with the definition of a Use Case. As UPDM is built on UML and SysML, it is possible to create Use Case diagrams showing the missions, their relationships, and the stakeholders involved in the mission. Figure D:14 defines the missions required for search and rescue.

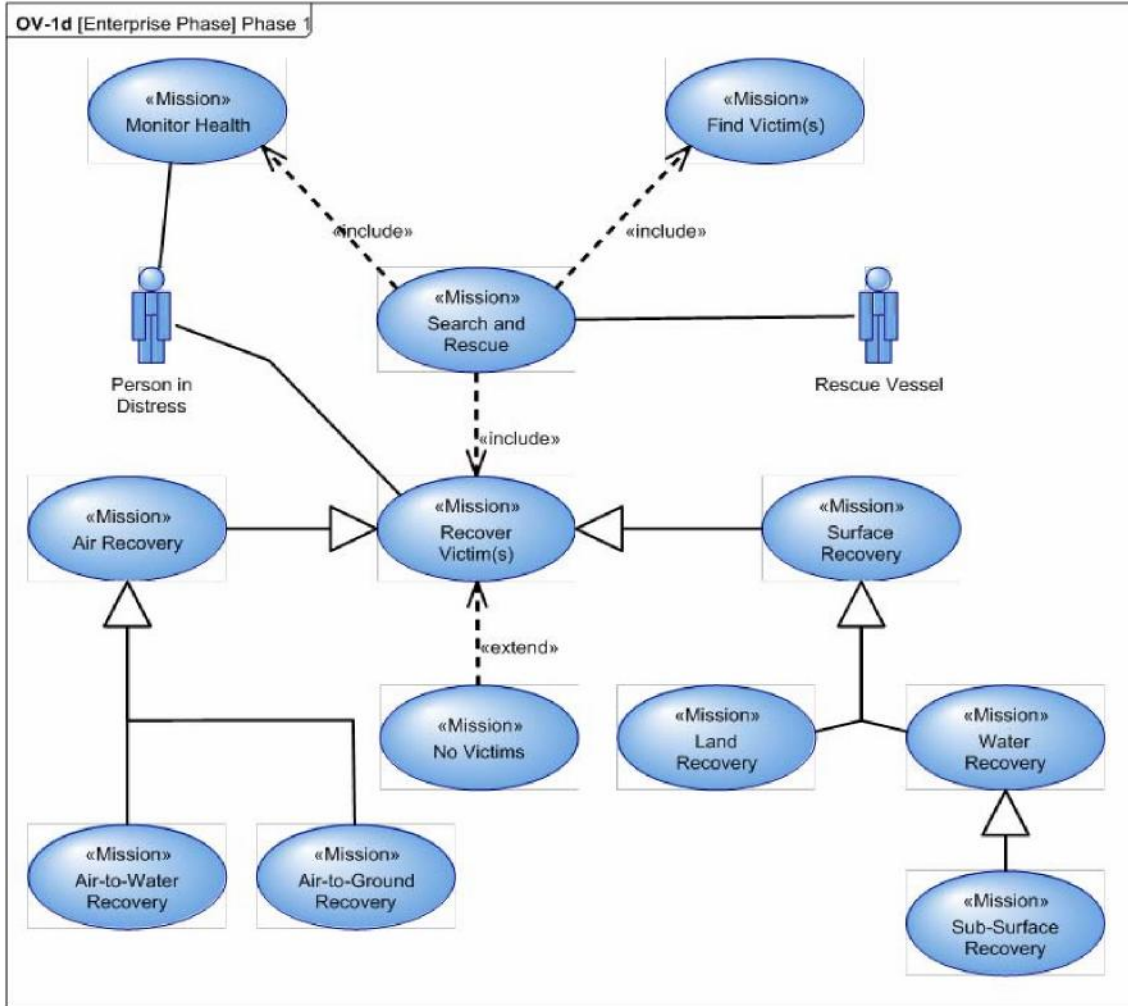

Figure D:14 - OV-1d

D.7.5 OV-2 Operational Node Connectivity Description (DoDAF Operational Resource Flow Description)

The OV-2 diagrams in Figures D. 16, D. 17, and D. 18 depict the key players in the SAR operation and the interactions for information exchange. It identifies the different types of nodes (Performer in DoDAF) in the SAR operation: Person in Distress, Monitoring Node, Tactical C2 Node, SAR Asset Controller, Search Node, Rescue Node, and Place of Safety. This diagram indicates the need to exchange information between the operational nodes and also shows the interactions between these nodes. Other interactions can be exchanged between the nodes such as equipment, energy, and so forth. The OV-5 view shows the operational activities undertaken by a few select nodes. Figure D:15 is the class diagram version of the OV-2.

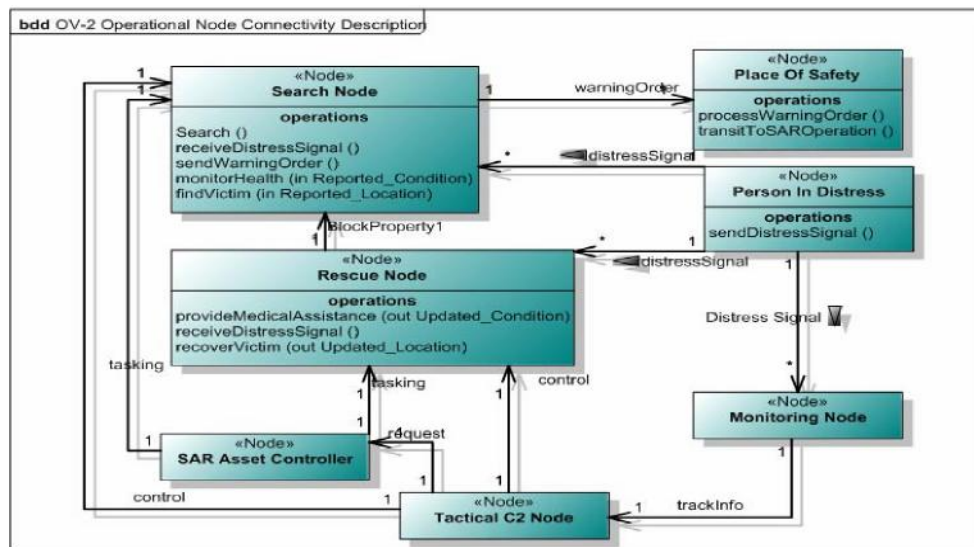

Figure D:15 - OV-2 Class Diagram

Figure D:16 shows an alternate way to display the OV-2. It can be illustrated as above with IO associations or as below using connectors and SysML Item Flows without flow ports as in Figure D:16 or with flow ports as in Figure D:17. Figure D:17 also shows the service ports. These define services that are required or provided by these nodes.

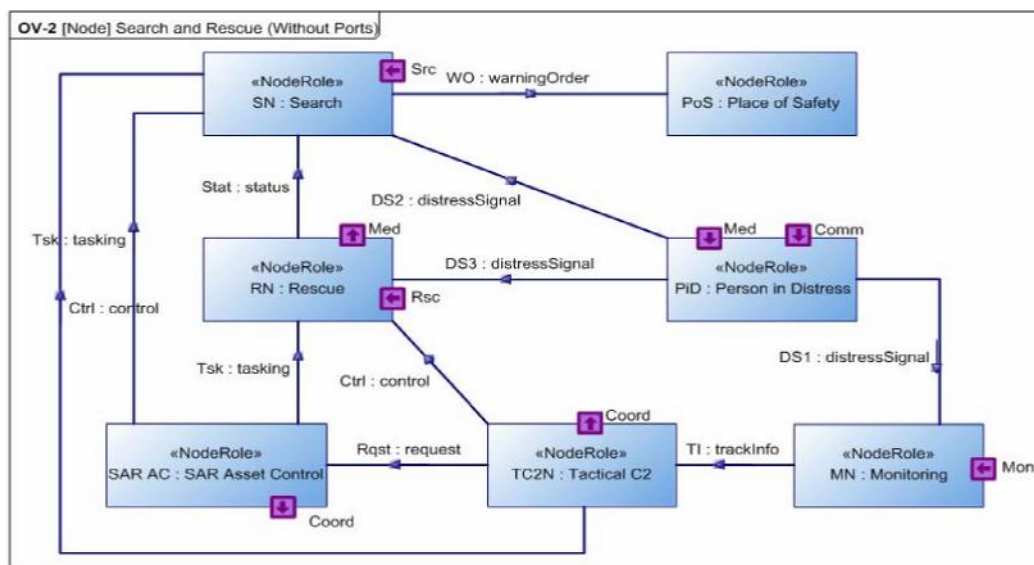

Figure D:16 - Alternate OV-2 SysML Version without Service Ports

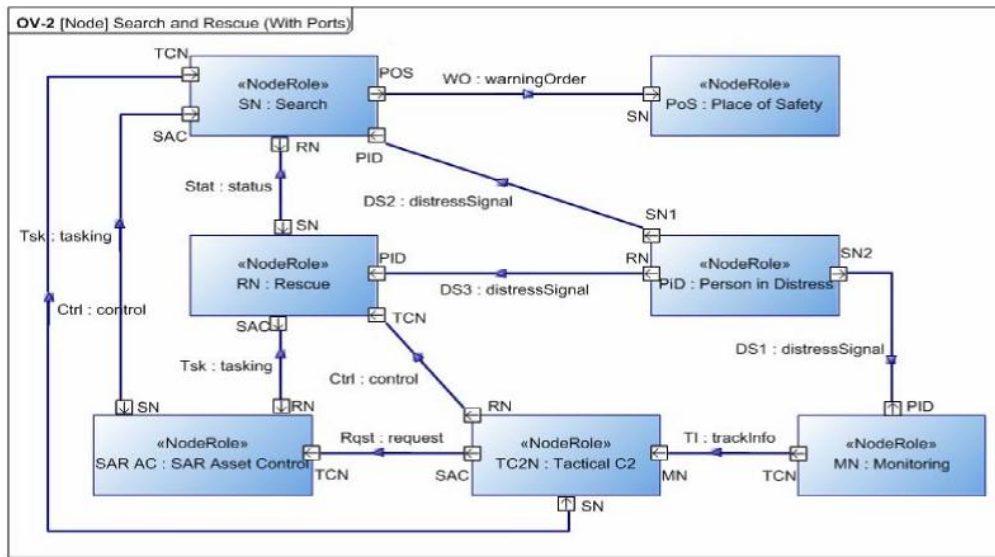

Figure D:17 - Alternate OV-2 with SysML Flow Ports

Figure D:17 shows the SysML version with Flow Ports and Item Flows. The typed ports mean that the user can constrain the elements that can flow in and out of the port. This means that consistency checks can be performed on the ports to ensure that the flows correspond to the allowed elements. The stereotypes have also been removed to aid readability.

D.7.6 OV-3 Operational Exchange Summary (DoDAF Operational Resource Flow Matrix)

Table D:7 shows the operational exchanges between nodes. The OV-3 can include Information Exchanges associated with a Needline as well as Information Elements carried by one or more Information Exchange. Reports can also be generated summarizing other types of exchanges. The report show the producing and consuming nodes, and the activities performed by those nodes that produced and consumed the interchange. This provides a validation capability for the architecture in that the blank boxes for the producing and consuming activities indicates that further work needs to be done on the architecture: exchanges are being made for no apparent purpose. There is an important distinction between DoDAF and MODAF in this regard. Exchanges (activityConsumesResource in DoDAF) can only take place as a result of an activity.

Information		Producer		Needline	Consumer	
Name	Conveyed	Node	Operational Activity	Name	Node	Operational Activity
Ctrl	control	Tactical C2		TC2N - RN	Rescue	
Ctrl	control	Tactical C2		TC2N - SN	Search	
DS1	distressSignal	Person in Distress		PID - MN	Monitoring	
DS2	distressSignal	Person in Distress	Send Distress Signal	SN1 - PID	Search	Receive Distress Signal
DS3	distressSignal	Person in Distress	Send Distress Signal	RN - PID	Rescue	Receive Distress Signal
Hqst	request	Tactical C2		SAC - TCN	SAR Asset Control	
Stat	status	Rescue		RN - SN	Search	
TI	trackInfo	Monitoring		TCN - MN	Tactical C2	
Tsk	tasking	SAR Asset Control		RN - SAC	Rescue	
Tsk	tasking	SAR Asset Control		SAR AC - SN	Search	
WO	warningOrder	Search	Send Warning Order	SN - PoS	Place of Safety	Process Warning Order

Table D:7 - OV-3

D.7.7 OV-4 Organizational Relationships Chart

The OV-4 illustrates the command structure or relationships (as opposed to relationships with respect to a business process flow) among human roles, organizations, or organization types that are the key players in the SAR operation.

The OV-4 exists in two forms - typical (typical command structure) and actual (organization chart for a department or agency). Figure D:18, the typical OV-4, shows the possible relationships between organizations and posts. It is also possible to define types of people who are capable of filling these posts. For example, a Qualified Lifeguard could become an MRT Swimmer. The class diagram defines a template from which the actual organization will be created. The actual organizations, posts, and relationships must comply with this template. In fact, it is not possible to add an element not defined in the template. This ensures a consistent model. Matrix organizations can also be created as multiple structures can be created. This provides both flexibility and structure.

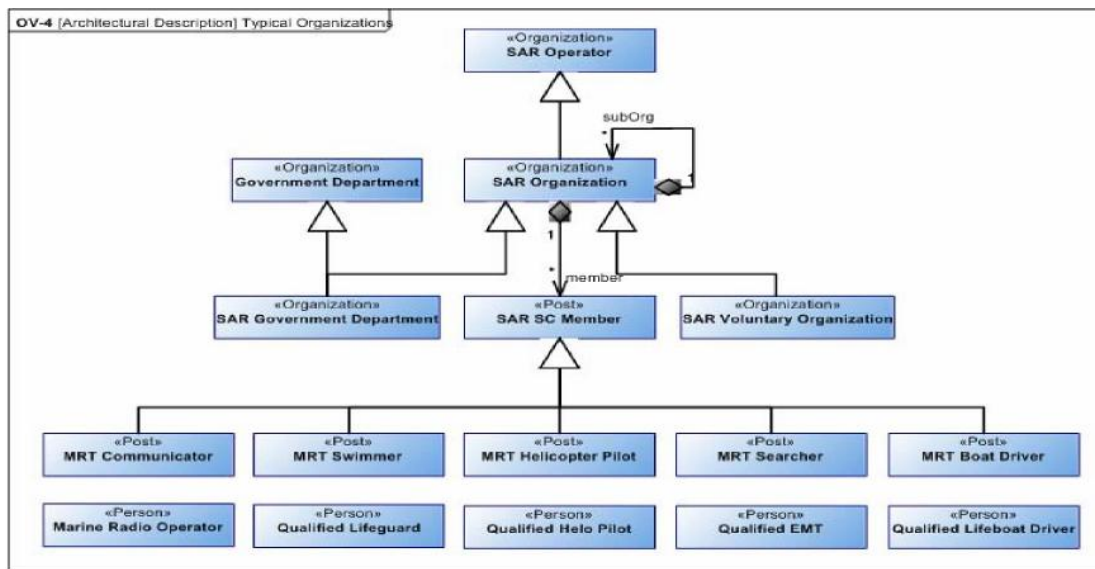

Figure D:18 - OV-4 Typical

The actual OV-4, shown in Figure D:19, depicts the structure of the organization, the actual posts (Person Type in DoDAF) and the actual persons (IndividualPerson in DoDAF) who fill those posts. The diagram can also be annotated with the start and end dates for this for the people filling those posts. For example, Peter Pilot fills the post of Rescue Helo Pilot, which is a member of the Coast Guard, which is a sub organization of the Maritime and Coastguard Agency.

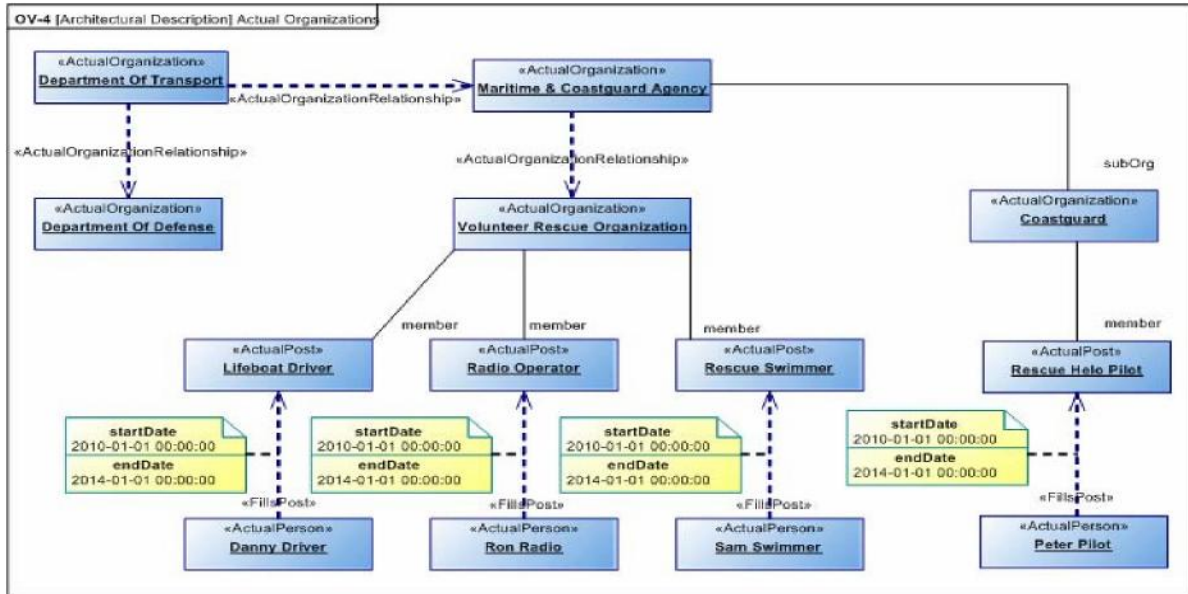

Figure D:19 - OV-4 Actual

D.7.8 OV-5 Operational Activity Model (DoDAF Operational Activity Decomposition Tree - OV-5A)

Figure D:20 describes the operations that are normally conducted in the different nodes of a Search and Rescue operation. This view shows the operational activities which are performed by the Search Node and Rescue Node. The class diagram views provides a means of breaking down activities to lower level activities as well as indicating the nodes that perform the activities.

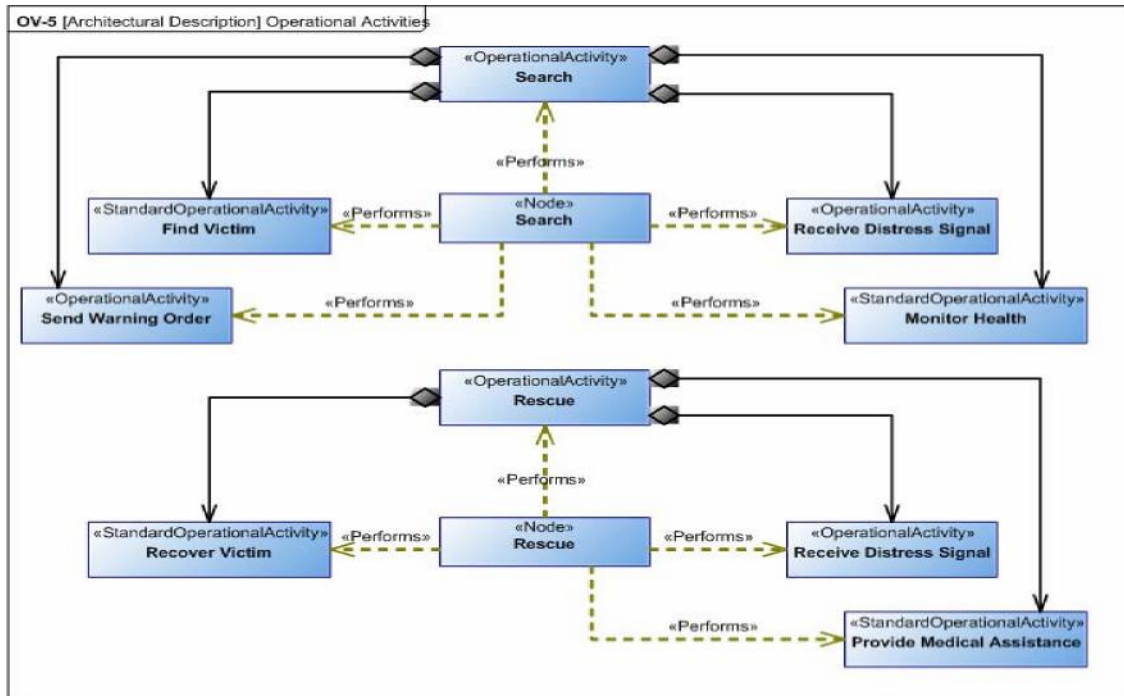

Figure D:20 - OV-5

Figure D:21 shows the OV-5 as an activity diagram. It describes Operational Activity Actions, Input/Output flows between activities and to/from activities that are outside the scope of the context of the activity diagram. The example shows the execution of the search activity. There is a horizontally nested swim lane which is the search and rescue context. Inside this context are the nodes that were defined within the OV-2. This is an example of how UPDM ensures structural consistency across the model. Activities displayed within the swimlanes are allocated to the node that owns the swim lane.

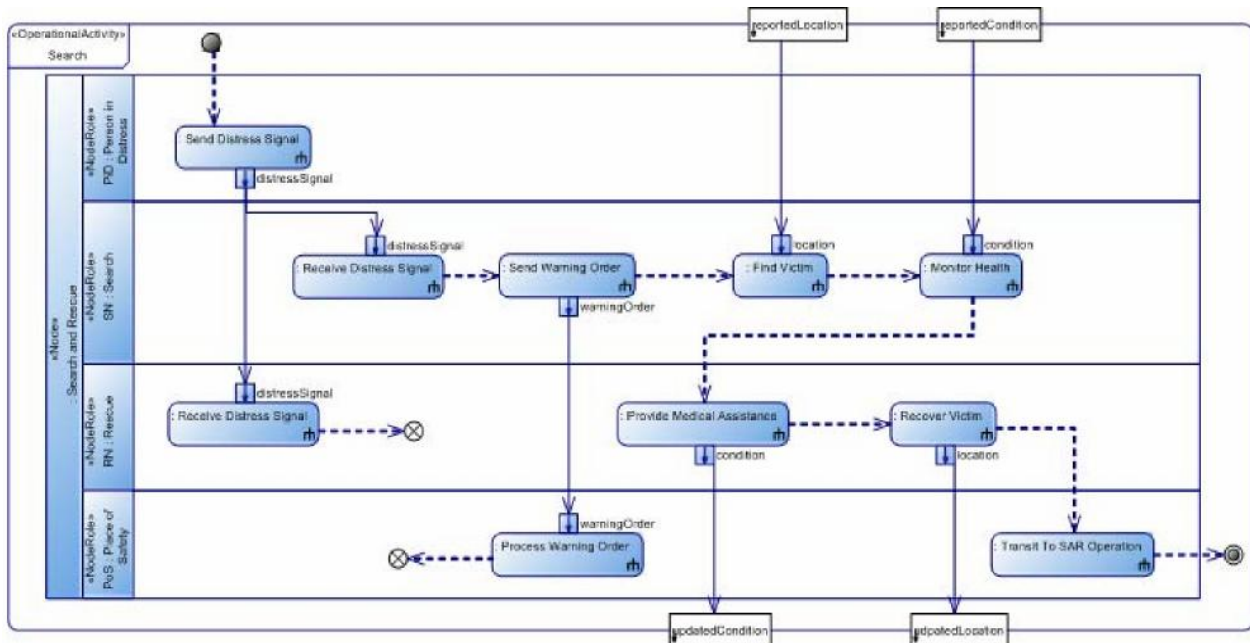

Figure D:21 - Alternate OV-5

D.7.9 OV-6a Operational Rules Model (Same in DoDAF)

Table D:8 is a generated report showing the operational constraints associated with operational elements such as nodes, organizations, Activities, etc.

Operational Element		Operational Constraint	
Type	Name	Name	Text
«Node»	Place of Safety	Location Constraints	The place of safety shall be isolated from the weather to ensure safety of the person n Distress.
«OperationalActivity»	Monitor For Distress Signal	Distress Signal Monitoring	Distress signals shall be monitored 24/7.
«OperationalActivity»	Search	Personnel Safety	Search personnel shall operate on a shift system to ensure that they can perform to maximum efficiency.
«OperationalActivity»	Send Distress Signal	Distress Signal Range	The maximum range for distress signals shall be posted at all ports and marinas.
«OperationalActivity»	Transit To SAR Operation	[none]	[none]

Table D:8 - OV-6a Operational Constraints

D.7.10 OV-6b Operational State Transition Description

Figure D:22 describes the operational states of the Search Node, the behaviors that take place within those states, the transitions between the states and the events and guards that cause those transitions to take place. For example, the search node is waiting for a distress signal. When one is received, the warning order is sent out and the search node transitions to searching for victim.

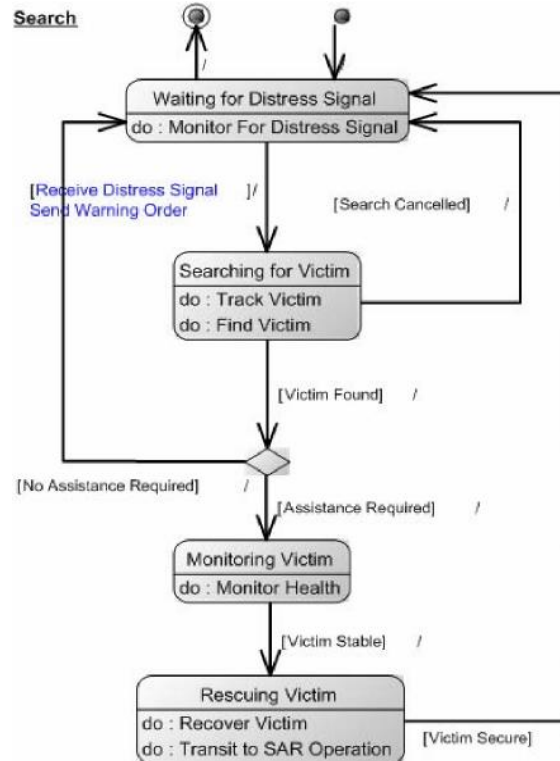

Figure D:22 - OV-6b

D.7.11 OV-6c Operational Event Trace Description

The OV-6c is used to define time based behavioral scenarios between operational elements. The interactions can be service operations as well as the interactions defined on the OV-2 and OV-5 diagrams. Figure D:23 shows the sequence of interactions for a search and rescue scenario.

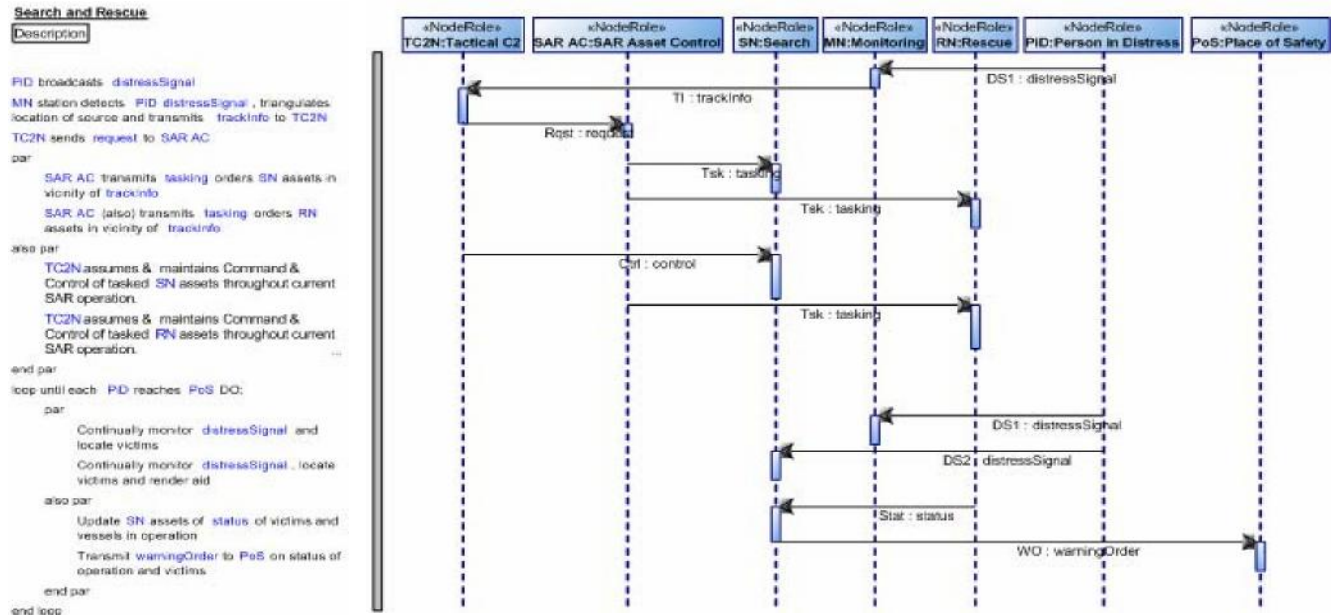

Figure D:23 - OV-6c

D.7.12 OV-7 Logical Data Model (DoDAF DIV-1/DIV-2)

The OV-7 view shown in Figure D:24 describes the information elements and entities used in the operational context. The boxes show the information items and the lines represent their inter-relationships. Attributes can be used to show the characteristics of the information items. The "represents entity" dependencies show the information elements that represent the entity items. These are used on the OV-2 and other diagrams.

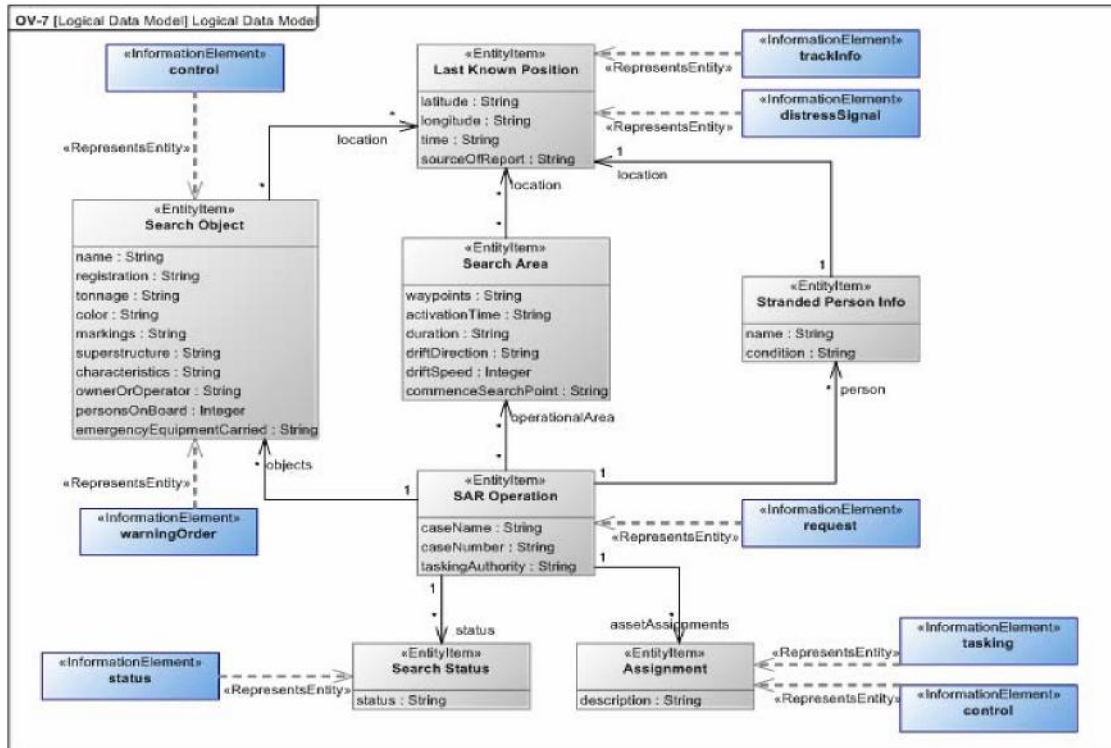

Figure D:24 - OV-7

D.8 Service Oriented Views (DoDAF SvcV-1)

The Service Oriented views describe the services needed to directly support the Search and Rescue operations described in the Operational View and System View. They are normally used when creating Service Oriented Architectures (SOA). The Service Oriented Views do not specify how the service is to be implemented, but the requirements for the services. The implementation of the services is normally implemented by the Systems Views. In this example, various services are defined to support Search and Rescue capabilities.

D.8.1 SOV-1 Service Taxonomy

The SOV-1 view specifies the hierarchy of services as well as the relationships between them. Figure D:25 shows the hierarchy of services within the Search and Rescue Service with Land and Maritime Search and Rescue Services as specializations of the SAR Service. Additional services are also defined to support SAR such as Communications, Coordination and so forth. These will be used in the rest of the SOVs as well as the OV and SV.

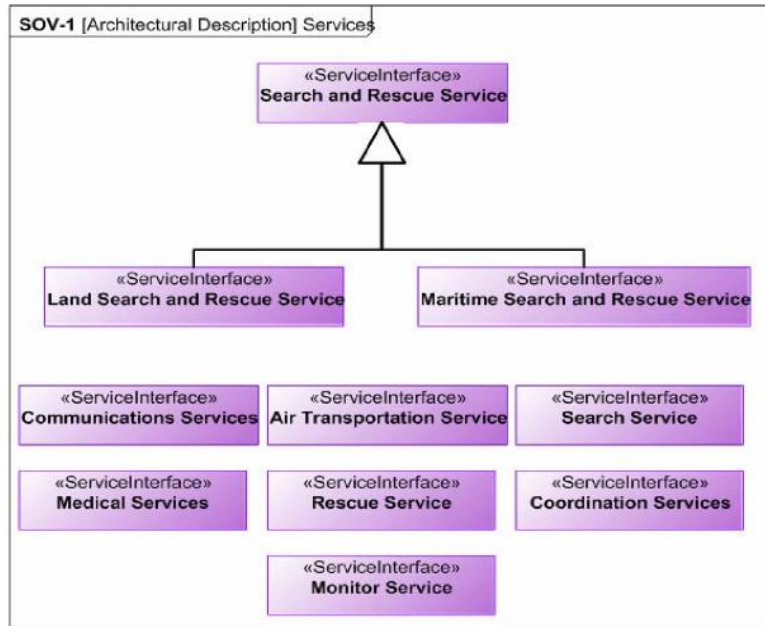

Figure D:25 - SOV-1

D.8.2 SOV-2 Service Interface Specification (DoDAF SvcV-2)

Figure D:26 defines the interfaces that will provide access to the services and those required by services. Many UPDM elements can provide and consume services. Specifying the interface for the service provides a means of determining compatibility between service consumers and providers. Service operations and attributes can also be defined on the SOV-2. Figure D:26 shows the interfaces for the services defined on the SOV- 1, and the operations and parameters of the operations provided by the interfaces.

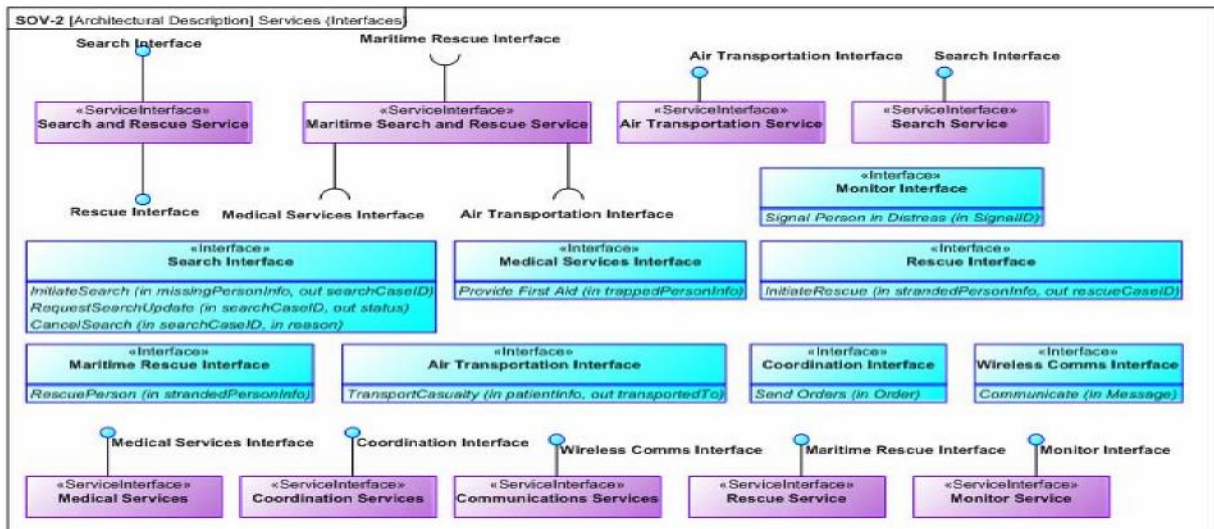

Figure D:26 - SOV-2

D.8.3 SOV-3 Capability to Service Mapping (DoDAF CV-7)

Figure D:27 shows which services contribute to the achievement of a capability. In this example, the Land Search and Rescue Service exposes (supports/realizes) the Land SAR Capability. Likewise, the Maritime Search and Rescue Service exposes the Maritime SAR Service. MODAF 1.2.004 specifies that the service must completely realize the capability it exposes. Additional services and capabilities are also shown.

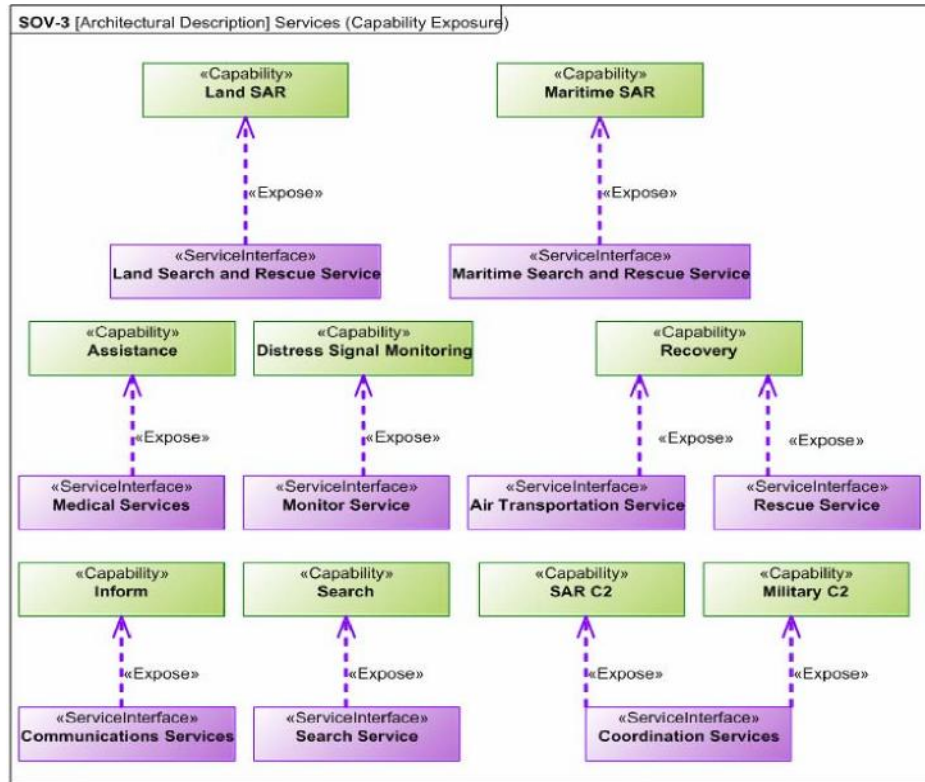

Figure D:27 - SOV-3

D.8.4 SOV-4a Service Behaviors and Constraints (DoDAF SvcV-10a)

The SOV-4a defines constraints that must be adhered to by Consumers and Providers of the Services via Service Policies. This also provides a means of performing trade-off analysis of the possible service providers. As a minimum it defines a set of criteria to determine whether or not the service provider meets the provision requirements defined by the constraints. Table D:9 shows a sample of the services and their associated service policies.

Service Interface	Service Policy	
	Name	Text
Land Search and Rescue Service	Driving Record	Any member involved in the operation of road vehicles must have a clean driving record.
Maritime Search and Rescue Service	Swim	All members of the rescue team must be able to swim.
Search and Rescue Service	FirstAid	All members of the rescue team must be able to perform basic first aid.
	Danger	No member of the search and rescue team should put themselves in unnecessary danger.

Table D:9 - SOV-4a Service Policies

D.8.5 SOV-4b Service Behaviors and Constraints (DoDAF SvcV-10b)

The SOV-4b defines behavioral constraints that must be adhered to by Consumers and Providers of the Services. Specifically it defines the state based behavior of the service defining the states, transitions between those states, the events that cause those transitions to take place and behaviors within those states. Figure D:28 shows the state diagram describing the state based behavior of the Maritime Search and Rescue Service.

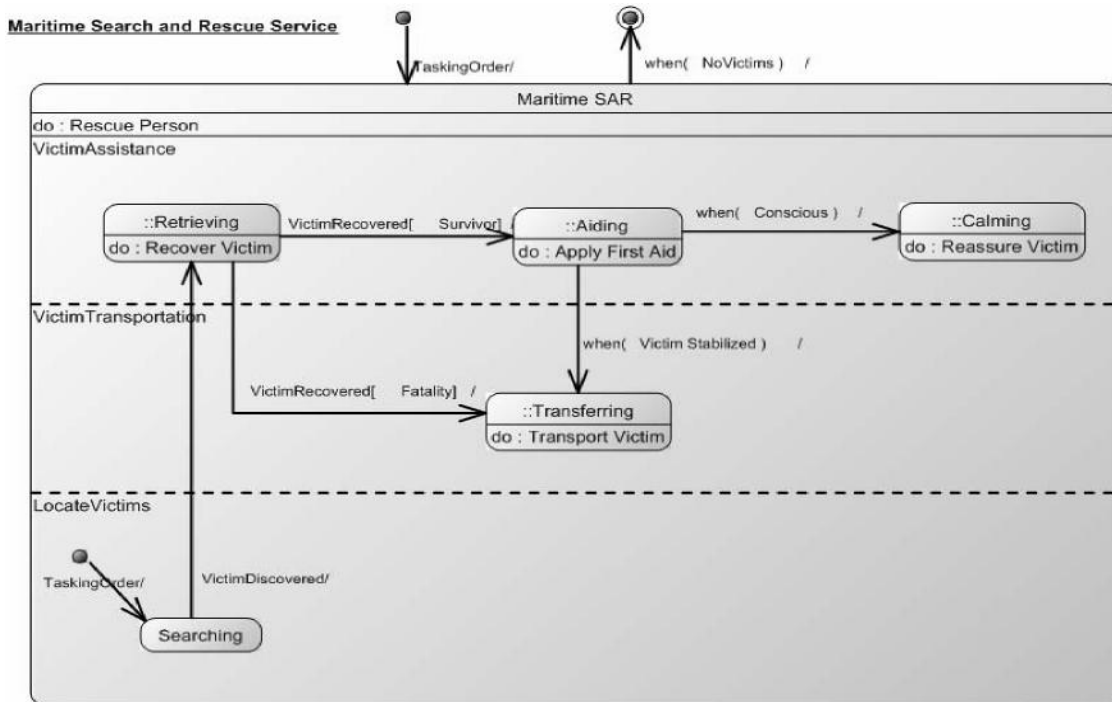

Figure D:28 - SOV-4b

D.8.6 SOV-5 Service Functionality (DoDAF SvcV-4)

Figure D:29 defines the Service Functions to describe the abstract behavior of each Service Operation. It specifies the set of functions that the service implementation is expected to perform. In this example, the Maritime Search and Rescue service provides the rescue function. This function is further decomposed to its sub-functions.

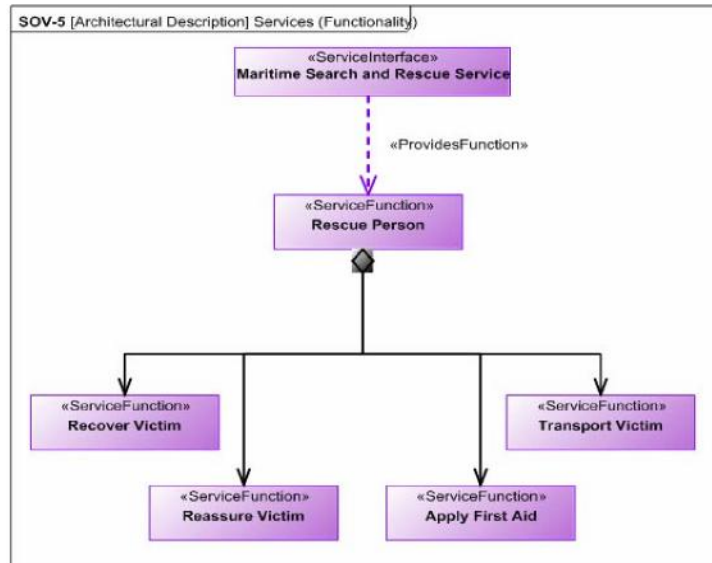

Figure D:29 - SOV-5

D.9 Systems Views

These views describe the resources that realize the SAR capabilities or implement services. They describe resource functions, interactions between resources, and can provide detailed system interface models. System views can describe the "as-is" and/or "to-be" configuration. In addition, several different configurations can be created to perform trade-off analysis. When used in conjunction with SysML, the systems should be developed to the degree that they define the requirements for actual systems that will be implemented. Developing the system views to too much detail will unnecessarily constrain the solution and will involve duplication of work.

System elements can include more than just physical systems. They can include software, organizational resources such as organizations, posts and roles. MODAF defines the concept of a Capability Configuration which is a composition of resources that can deliver a capability. As in the operational views, interactions can consist of more than just information and can include Posts, organizations, capability configurations, energy, and software.

D.9.1 SV-1 Resource Interaction Specification (DoDAF Systems Interface Description)

The SV-1 defines the structure and internal flows of the system architectures to demonstrate how they realize the logical architecture defined in the operational views. The interfaces and interactions are defined at the level of specifying a need for the systems to interact and the way in which they do so. These systems can be decomposed to any level required. Figure D:30 shows the Capability Configuration of a Maritime Rescue Unit. The Maritime Rescue Unit is comprised of the Maritime Rescue Team (MRT), and the roles that make up the MRT, as well as the components that enable them to fulfill their role. This example shows that the Role of Driver is filled by a MRT Member who must interact with a MR Boat.

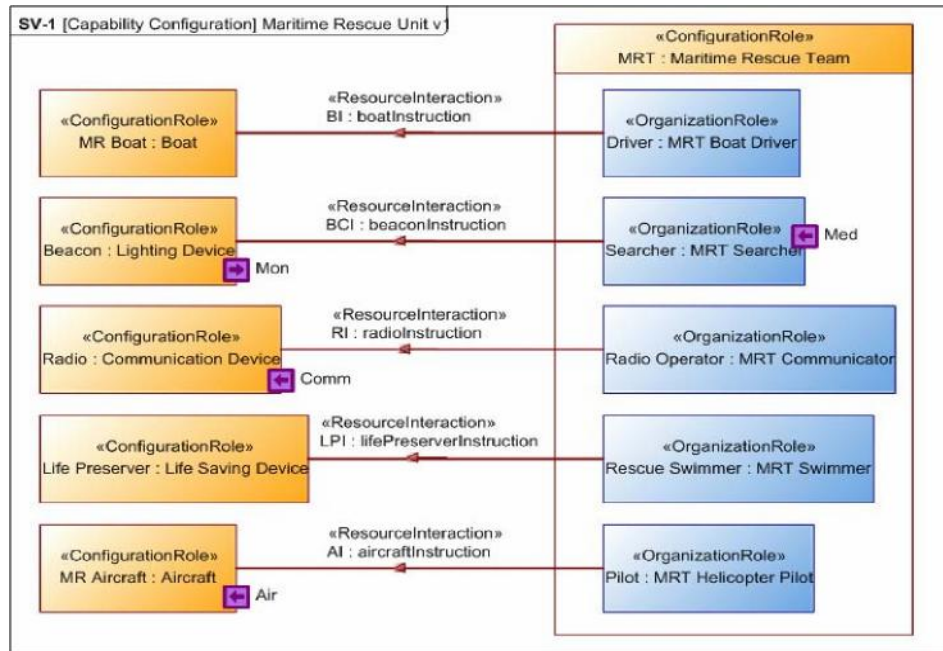

Figure D:30 - SV-1 Maritime Rescue Unit

D.9.2 SV-2 Systems Communications Description (DoDAF System Resource Flow Description)

The SV-2 defines the communications networks and pathways that link the systems as well as providing details about the configuration. MODAF defines 3 separate views for Port Specification (SV-2a), System to System Port Connectivity (SV-2b), and System Connectivity Clusters (SV-2c). All these details can be shown by using the Internal Block Diagram as has been implemented in UPDM. System Protocols and Standards can also be shown. Figure D:31 shows systems interconnections for a number of entities in a maritime search and rescue scenario.

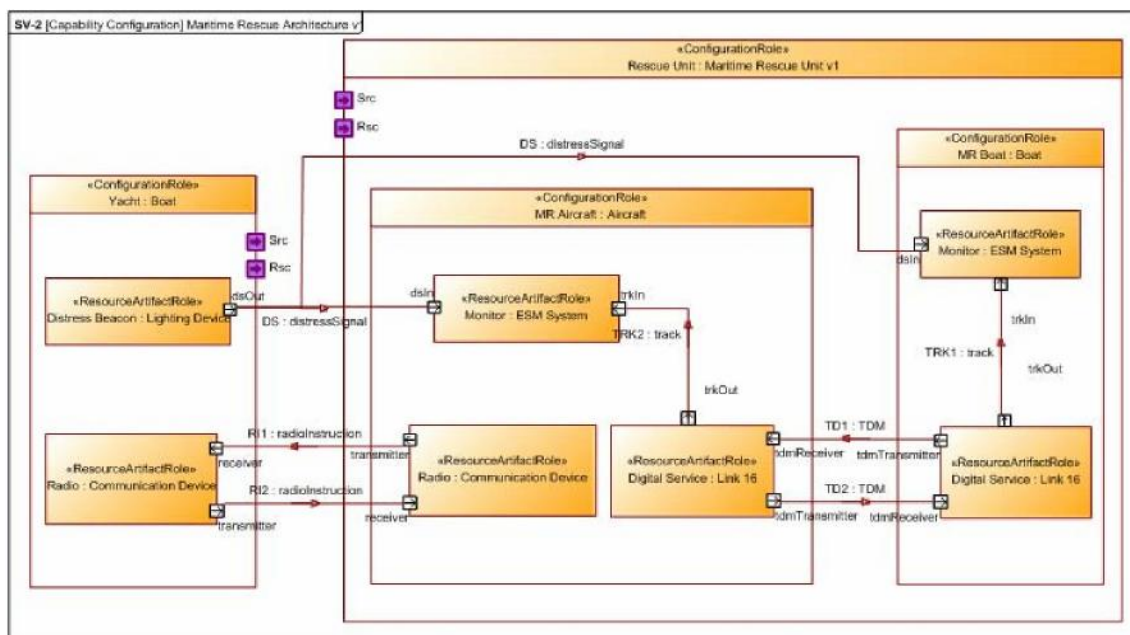

Figure D:31 - SV-2

D.9.3 SV-3 Resource Interaction Matrix (DoDAF Systems - Systems Matrix)

The SV-3 is a summary report of the interactions defined in the SV- 1. It expresses the connections between the system elements. Table D:10 does this in the form of a matrix. For simplicity and readability, the matrix has been reduced to show only those systems that are connected.

	«Resource Artifact» Aircraft	«Resource Artifact» Boat	«Resource Artifact» Communication Device	«Resource Artifact» ESM System	«Resource Artifact» Life Saving Device	«Resource Artifact» Lighting Device	«Resource Artifact» Link 16	«Resource Artifact» Safety Device
«Post» MRT Boat Driver		X						
«Post» MRT Communicator			X					
«Post» MRT Helicopter Pilot	X							
«Post» MRT Searcher						X		
«Post» MRT Swimmer					X			
«ResourceArtifact» Communication Device			X					
«ResourceArtifact» Lighting Device				X				
«ResourceArtifact» Link 16				X			X	
«ResourceArtifact» Safety Device								

Table D:10 - SV-3 System Connectivity Matrix

D.9.4 SV-4 Functionality Description (DoDAF Systems Functionality Description)

The SV-4 defines the functions carried out by the different types of Resources. This includes organizational resources such as posts and organizations. Two forms can be used. Figure D:32 shows a hierarchical breakdown of the Rescue Victim function. It is also possible to show the resource that is performing the action. This provides a mapping of resource usage to function.

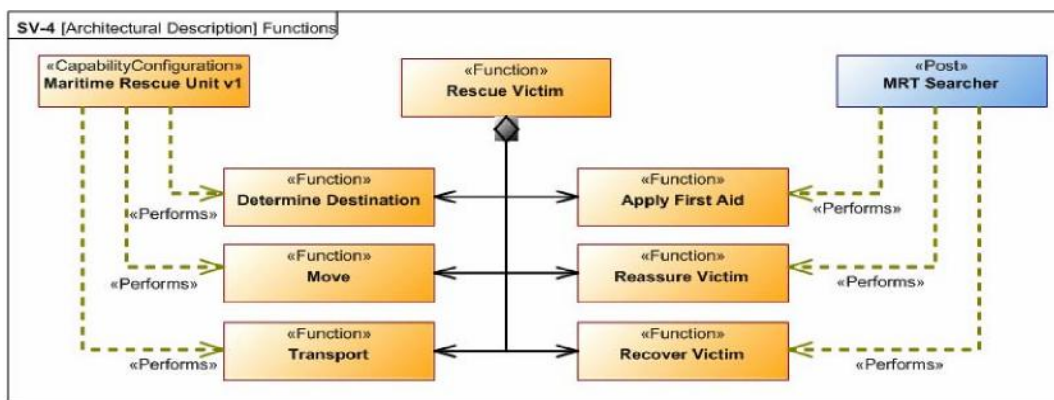

Figure D:32 - SV-4

Figure D:33 is the other type of SV-4 and takes the format of an activity diagram. It shows the Resources using Functions, the operational step-by-step workflows and the overall flow of control The Maritime Rescue Unit

v1 and the MRT Searcher are represented as swim lanes. It shows the functions used by these Resources, the order in which they take place, and the interactions between them to implement the Rescue Victim Activity.

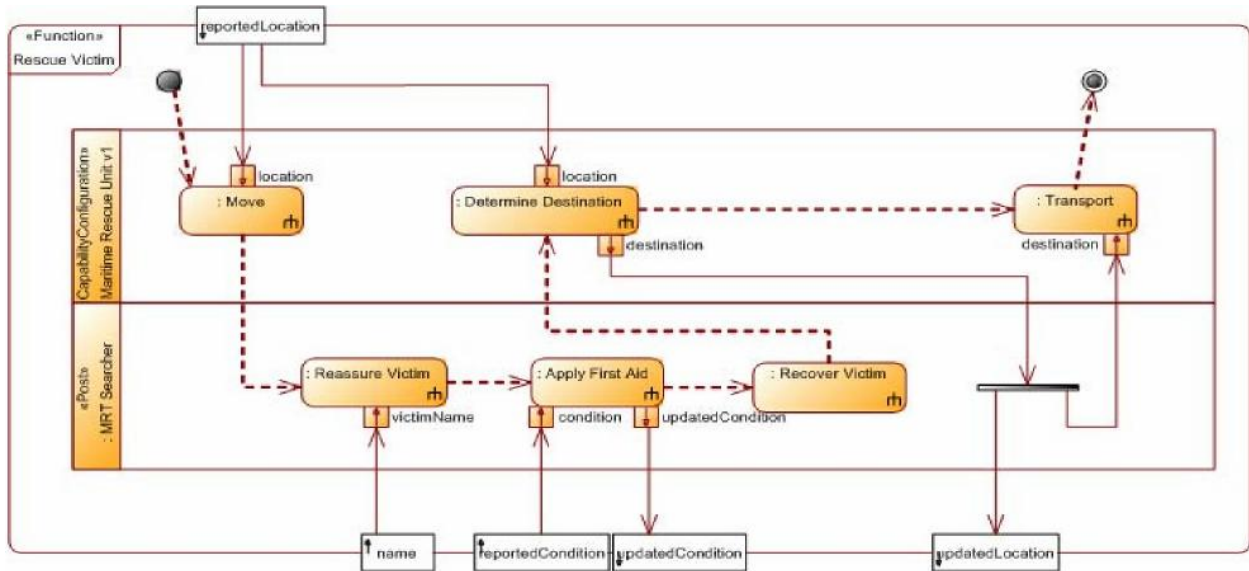

Figure D:33 - SV-4 Activity Diagram

D.9.5 SV-5 Function to Operational Activity/Service Function Traceability

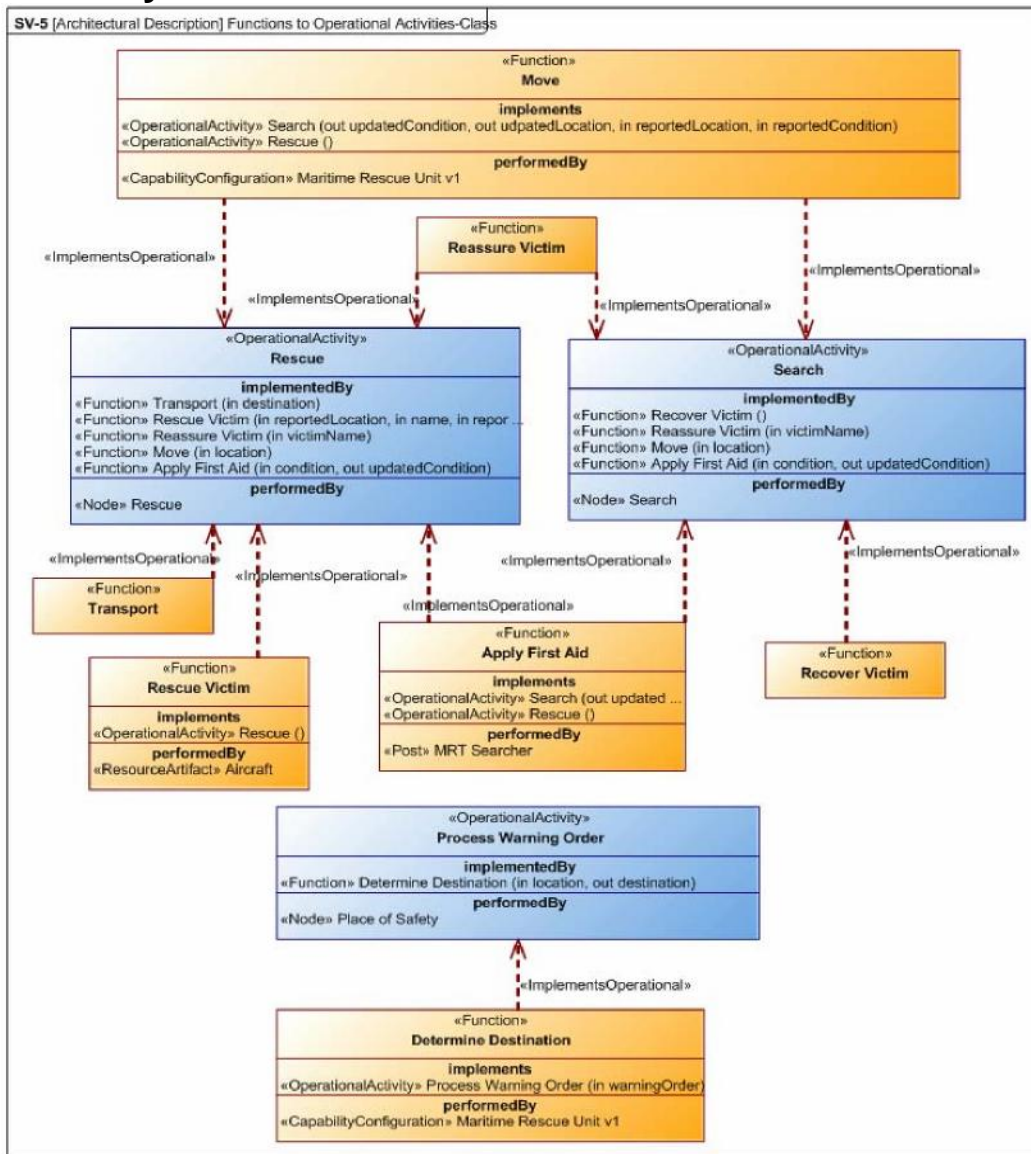

Figure D:34 - SV-5

The SV-5 view is used to show how System Functions support Operational Activities and Service Functions. UPDM also provides a graphical view to define these relationships. Figure D:34 shows the SAR Activities and those System Functions that implement them. This provides an essential requirements traceability capability as well as a means of validating the overall architecture. Functions that do not implement operational activities may be superfluous, and operational activities that are not implemented by functions have not been fully analyzed.

D.9.6 SV-5 System Function to Operational Activity/Service Function Traceability Matrix

Table D:11 summarizes the traceability between the system functions and operational activities in matrix form. It has been simplified for readability.

Realizing Function	Monitor For Distress Signal	Process Warning Order	Rescue	Search
	Apply First Aid			X
Determine Destination		X		
Move			X	X
Reassure Victim			X	X
Recover Victim				X
Rescue Victim			X	
Search				
Transport			X	

Table D:11 - SV-5

D.9.7 SV-6 System Exchange Matrix (DoDAF Systems Resource Flow Matrix)

The SV-6 summarizes the interactions between the resources in the SV-1 and SV-2. Table D:12 shows the interactions between the SAR resources. Additional fields can also be included such as measurements associated with the exchange.

Resource Interaction		Producer	Connector / Interface	Consumer
Name	Conveyed	Resource	Name	Resource
AI	aircraftInstruction	MRT Helicopter Pilot	Resource Interface	Aircraft
BCI	beaconInstruction	MRT Searcher	Resource Interface	Lighting Device
BI	boatInstruction	MRT Boat Driver	Resource Interface	Boat
DS	distressSignal	Lighting Device	Resource Connector	ESM System
DS	distressSignal	Lighting Device	Resource Connector	ESM System
LPI	lifePreserverInstruction	MRT Swimmer	Resource Interface	Life Saving Device
RI	radioInstruction	MRT Communicator	Resource Interface	Communication Device
RI1	radioInstruction	Communication Device	Resource Connector	Communication Device
RI2	radioInstruction	Communication Device	Resource Connector	Communication Device
TD1	TDM	Link 16	Resource Connector	Link 16
TD2	TDM	Link 16	Resource Connector	Link 16
TRK1	track	Link 16	Resource Connector	ESM System
TRK2	track	Link 16	Resource Connector	ESM System

Table D:12 - SV-6

D.9.8 SV-7 Resource Performance Parameters (DoDAF Systems Measures Matrix)

This view defines the types of measurements that are important to the system resources. It consists of measurable, qualitative properties. It is normally shown in tabular form. Figure D:35 shows the Capability Configurations that are linked to the various measurements.

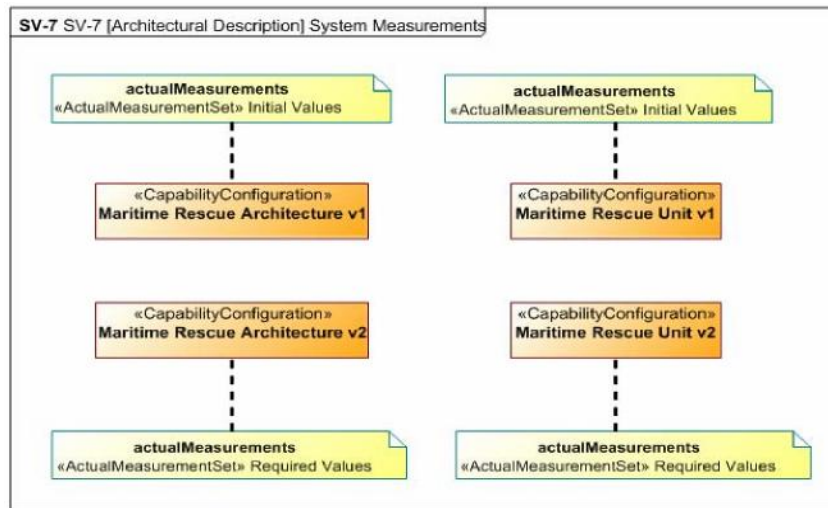

Figure D:35 - SV-7

Table D:13 shows the SV-7 in tabular format, specifying qualitative and quantitative characteristics of resources. These are the same measurements that were defined in Figure D:3 and Figure D:4. This is a generated report.

		Actual Measurement Set						
Name	Name	Intention	Measurement	Minimum Value	Actual Value	Maximum Value	Unit	Dimension
Maritime Rescue Unit v1	Initial Values	Estimate	seaConditions	Sea State 1	Sea State 6	Sea State 10	Meter	Wave Height
			areaCoverage	100	500	1000	SquareKilometers	Area
			findTime	4	<8 hours	8	Hours	Time
			persistence	5	>15 hours	22	Hours	Time
			searchCoverage	200	400	600	SquareKilometers	Area
			weatherConditions	Calm	Heavy Rain	Hurricane	Weather Severity Index	
Maritime Rescue Unit v2	Required Values	Required	seaConditions	Sea State 1	Sea State 8	Sea State 10	Meter	Wave Height
			areaCoverage	100	600	1000	SquareKilometers	Area
			findTime	4	<5 hours	8	Hours	Time
			persistence	5	>20 hours	22	Hours	Time
			searchCoverage	200	500	600	SquareKilometers	Area
			weatherConditions	Calm	Stormy	Hurricane	Weather Severity Index	
	Final Values	Result	seaConditions	Sea State 1	Sea State 8	Sea State 10	Meter	Wave Height
			areaCoverage	100	650	1000	SquareKilometers	Area
			findTime	4	<4 hours	8	Hours	Time
			persistence	5	>20 hours	22	Hours	Time
Monitor			searchCoverage	200	550	600	SquareKilometers	Area
			weatherConditions	Calm	Stormy	Hurricane	Weather Severity Index	

Table D:13 - SV-7 in Tabular Format

D.9.9 SV-8 System Capability Configuration Management (DoDAF Systems Evolution Matrix)

The SV-8 view is used to show the whole lifecycle of a resource showing how its configuration changes over time. It shows the capabilities, the resources that implement those capabilities, and any constituent components. Table D:14 shows the lifecycles for Assistance, Search, and Distress Signal Monitoring. Note that Distress Signal Monitoring does not have any implementing resources. This is also useful information.

Capability Name	Realizing Resource		Milestone Dates					
	Name	Components	2010-01-01	2010-07-01	2010-08-01	2010-11-01	2011-01-01	2011-05-01
Assistance	«Capability Configuration» Maritime Rescue Unit v2				Increment			Out Of Service
	«Capability Configuration» Maritime Rescue Unit v1	«Resource Artifact» Lighting Device	Increment			Out Of Service		
		«Resource Artifact» Life Saving Device						
		«Resource Artifact» Aircraft						
«Resource Artifact» Boat								
	«Organization» Maritime Rescue Team							
	«Resource Artifact» Communication Device							
	«Capability Configuration» Automated Rescue Unit v1		Increment			Out Of Service		
Distress Signal Monitoring								
Search	«Capability Configuration» Maritime Rescue Unit v2				Increment			Out Of Service
	«Capability Configuration» Maritime Rescue Unit v1	«Resource Artifact» Lighting Device	Increment			Out Of Service		
		«Resource Artifact» Life Saving Device						
		«Resource Artifact» Aircraft						
«Resource Artifact» Boat								
	«Organization» Maritime Rescue Team							
	«Resource Artifact» Communication Device							
	«Capability Configuration» Automated Rescue Unit v1		Increment			Out Of Service		

Table D:14 - SV-8

D.9.10 SV-9 Technology and Skills Forecast (DoDAF Systems Technology and Skills Forecast)

The SV-9 provides a summary of the current and emerging technologies and skills that impact on the Resources that constitute the architecture. The example shown in Figure D:36 and Table D:15 shows the technology forecasts for the resource artifacts used in the systems views. Reports can also be created for competencies (Skill in DoDAF), posts (PersonType in DoDAF), organizations (OrganizationType in DoDAF), etc.

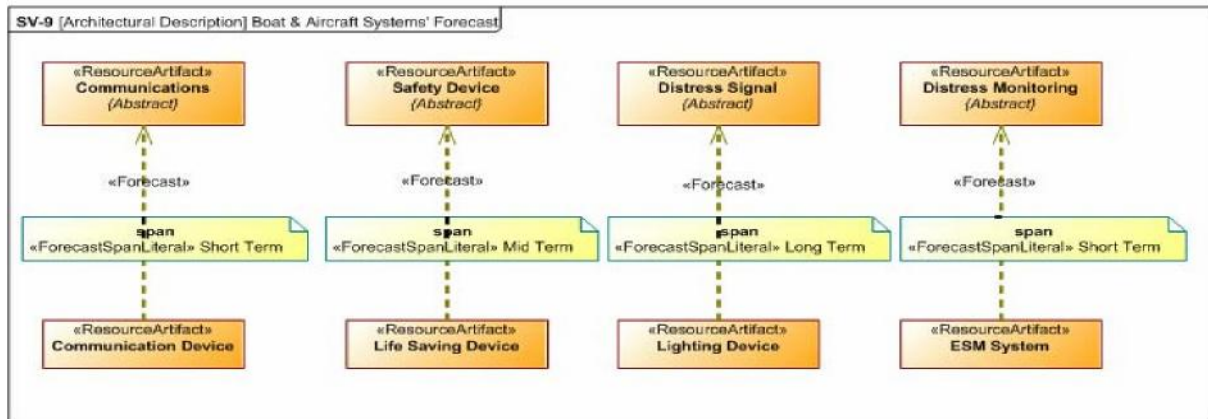

Figure D:36 - SV-9

D.9.11 SV-9 Technology and Skills Forecast

Table D:15 shows the tabular view of the technology forecast for the system resources.

Category Type	Category	Short Term	Long Term	Mid Term
«ResourceArtifact»	Communications	Communication Device		
«ResourceArtifact»	Distress Monitoring	ESM System		
«ResourceArtifact»	Distress Signal		Lighting Device	
«ResourceArtifact»	Safety Device			Life Saving Device

Table D:15 - SV-9

D.9.12 SV-10a System Rules and Constraints (DoDAF Systems Rules Model)

The SV-4 defines the functional specification of the behavior of the system resources. The SV-10a, SV-10b, and SV-10c augment this by defining the constraints, state behavior, and sequence of interactions of the resources. Table D:16 defines the constraints on a sample of system resources.

Resource Constraint		
Name	Name	Text
Boat	GMDSS Vessel Requirements	Ships subject to Title II Part II and Part III of the Communications Act of 1934, as amended have to fit GMDSS equipment under FCC Regulation 47 CFR 80 Subpart W. These include all ships, including fishing vessels, to be navigated in the open sea outside of a harbor or port, except: Ships other than passenger vessels less than 300 gross tonnage, Passenger ships having six passengers or less, U.S. government ships, Yachts of less than 600 gross tons, Vessels in tow, Ships navigating solely on any bays, sounds, rivers or protected waters within the U.S., Ships being navigated within the Great Lakes of North America, and Small passenger ships meeting the requirements of 47 CFR 80 Subpart S.
	Marine Vessel Communications	Mariners need to be able to communicate with other ships of any size or nationality. Mariners need to be able to receive and send urgent maritime safety information. Mariners need to be able to send or receive distress alerts in an emergency to or from rescue coordination centers ashore and nearby ships anywhere in the world.
	Radio Watch Keeping	In general, any vessel equipped with a VHF marine radiotelephone (whether voluntarily or required to) must maintain a watch on channel 16 (156.800 MHz) whenever the radiotelephone is not being used to communicate.
Communication Device	Distress System Usage	The radiotelephone alarm signal is used only in a distress, including when a person has been lost overboard and the assistance of other vessels is required.
	GMDSS Equipment Operation	A GMDSS Radio Operator's License is necessary for a person to use required GMDSS equipment.
Lighting Device	Distress System Usage	The radiotelephone alarm signal is used only in a distress, including when a person has been lost overboard and the assistance of other vessels is required.
Safety Device	[none]	[none]

Table D:16 - Systems Rules and Constraints

D.9.13 SV-10b Resource State Transition Description (DoDAF System State Transition Description)

The SV-10b uses a state diagram to describe the resource's responses to the various events that it can receive. It can also be to show the operational states of the resource. Figure D:37 shows the state based behavior for the aircraft.

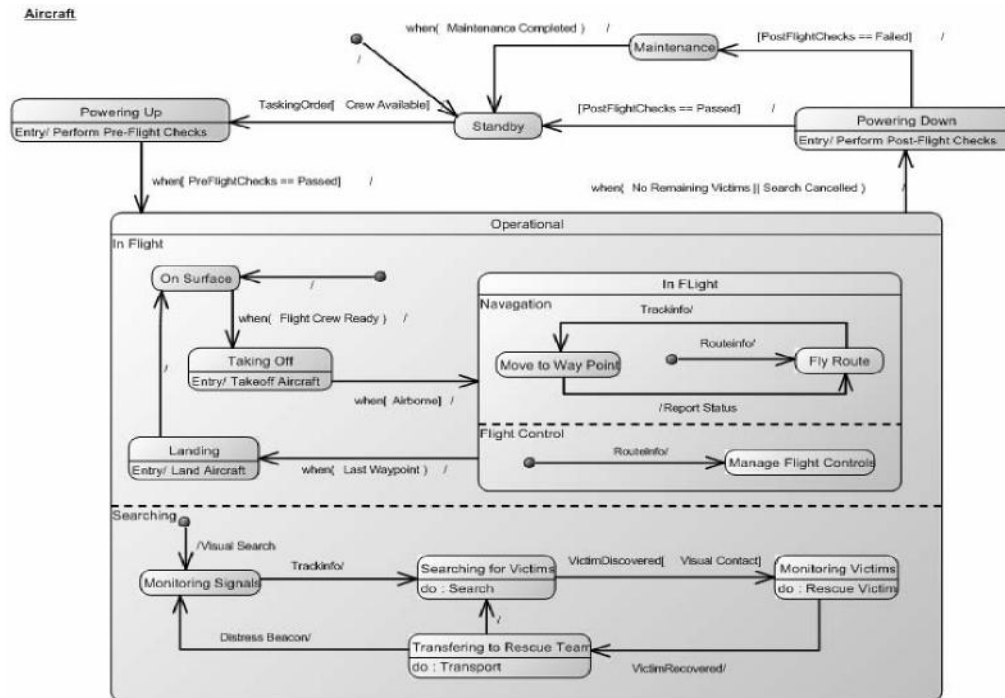

Figure D:37 - SV-10b

D.9.14 SV-10c Resource Event Trace Description (DoDAF System Event Trace Description)

The SV-1 0c defines a sequence of interaction between system resources in time order normally to execute a scenario or to fulfill some other functional requirement. This diagram is normally used once the architecture has been well defined. It is useful as a means of determining if sufficient interactions and system resources have been defined to allow the architecture to fulfill its functional requirements. Figure D:38 shows a search and rescue scenario.

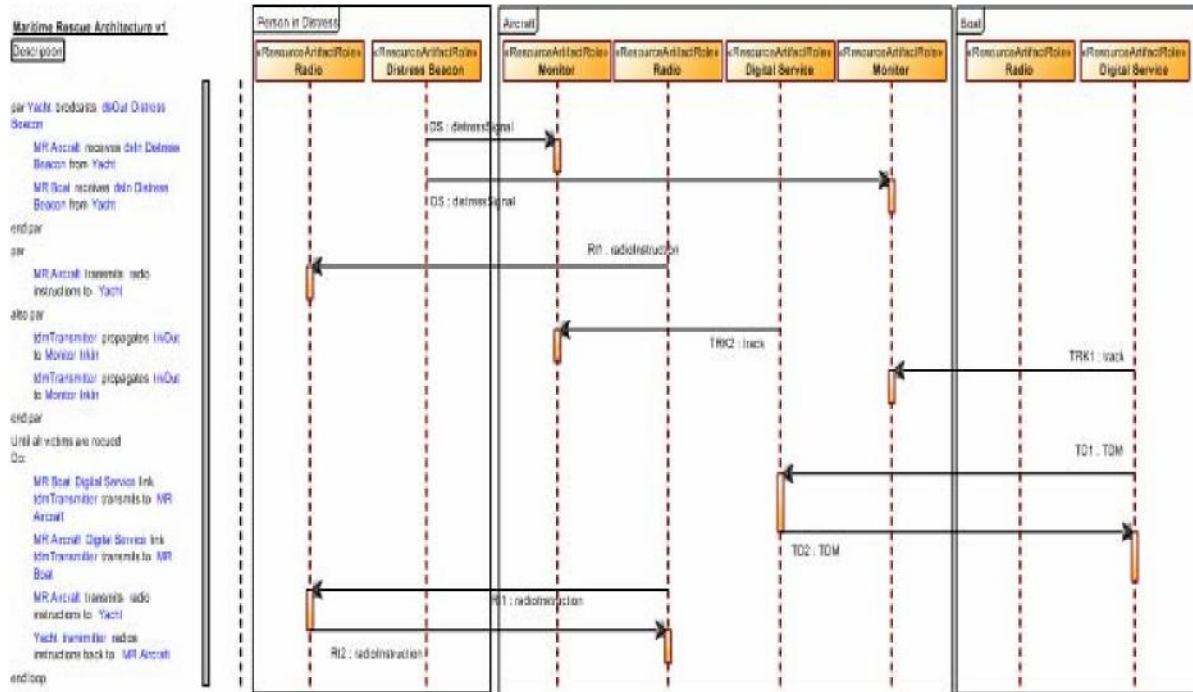

Figure D:38 - SV-10c

D.9.15 Physical Schema (DoDAF DIV-3)

The SV-1 1 defines the structure of various kinds of system data that are utilized by the system resources. These are the data elements used by the SV-1, SV-2, SV-4, and SV-1 0c interactions. Data elements are defined that are defined by entities. These entities can have complex structures. Figure D:39 shows the initial stages of the definition of the SAR data model.

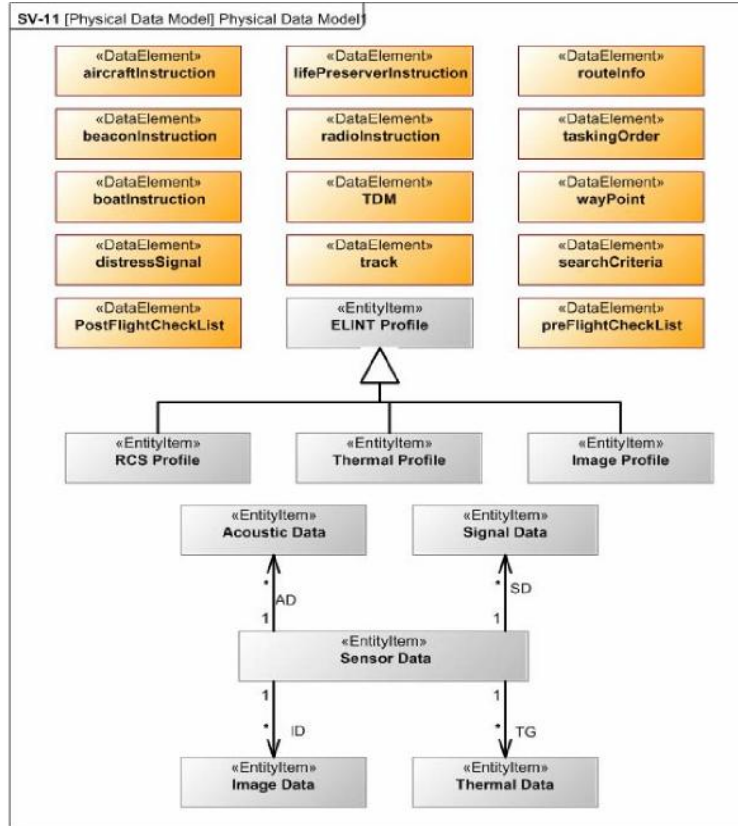

Figure D:39 - SV-11

D.9.16 System Service Provision

The SV-12 is used to describe the system resources that deliver services. This takes the form of a matrix report. The service provision relationship is provided by the service point on the SV-1 and SV-2 diagrams. Table D:17 shows the system resources that provide these services. Note that they can be Posts, System Artifacts, Capability Configurations, etc.

	Air Transportation Service	Communications Services	Medical Services	Rescue Service	Search Service
«CapabilityConfiguration» Maritime Rescue Unit v1				X	X
«Post» MRT Searcher			X		
«ResourceArtifact» Aircraft	X				
«ResourceArtifact» Boat					
«ResourceArtifact» Communication Device		X			

Table D:17 - SV-12

D.10 Acquisition Views (DoDAF Project Views)

The Acquisition views identify top-level tasks in the acquisition process. They help you understand how resources, assets, and capabilities are acquired during the life of the project. It gives you the ability to perform analysis to determine if the resources can be obtained, if they are available in the time they are needed, and the overall effect on the schedule. They can also show whether or not complete coverage of the Defense Lines of Development (DLOD) (known as DOTMLPF in the DoD) are fully covered.

D.10.1 AcV-1 System of Systems Acquisition Clusters (DoDAF PV-1)

The AcV- 1 represents an organizational perspective of the program. It allows the user to model the organizational structures needed to manage a portfolio of projects. Table D:18 shows who is responsible for the SAR Project, as well as the project type.

Project Owner	Actual Project
Department Of Transport	SAR Manual Project I
	SAR Automation Project
	SAR Manual Project II

Table D:18 - AcV-1

D.10.2 AcV-2 Program Timeline (DoDAF PV-2)

The AcV-2 Program Timeline diagram allows management the ability to view a summary of project status across the complete program timeline. It also provides a means of viewing the DLOD status for each of the defined milestones for the project. This and the AcV-3 diagram provide much of the information for the StV-3 (DoDAF CV-3) view. Figure D:40 shows the 3 projects and their associated milestones. They are spaced according to time order. The pie charts represent the DLODs and their meaning is defined on the key to the right. The example is somewhat artificial in that the milestones are all spaced 6 months apart. This has been done for clarity of reading.

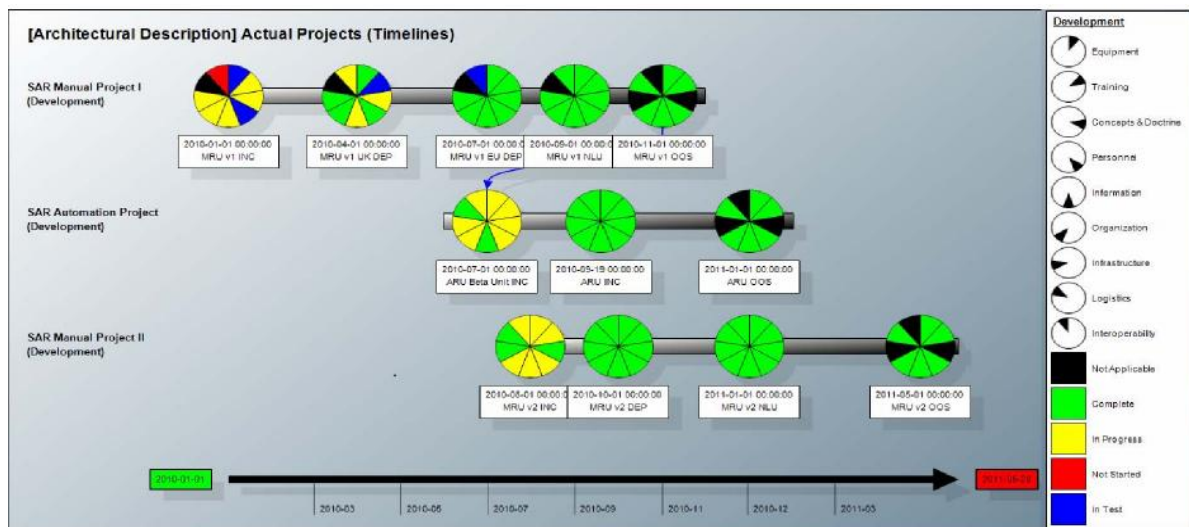

Figure D:40 - AcV-2

D.10.3 AcV-3 Typical Project (DoDAF PV-3)

The AcV-3 class diagram provides a means of defining projects and project types. In Figure D:41, the development project can contain other development projects. Development projects contain milestones containing project themes corresponding to DLOD (DoD DOTMLPF) themes.

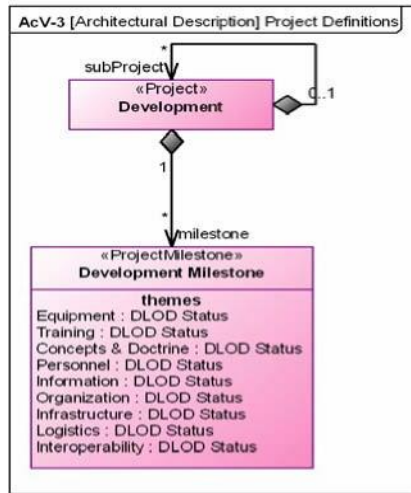

Figure D:41 - AcV-3 Class Diagram

D.10.4 AcV-3 Actual Project Instance (DoDAF PV-3)

The AcV-3 provides a means of defining actual projects and actual project milestones. In Figure D:42 three SAR projects and their project milestones are shown.

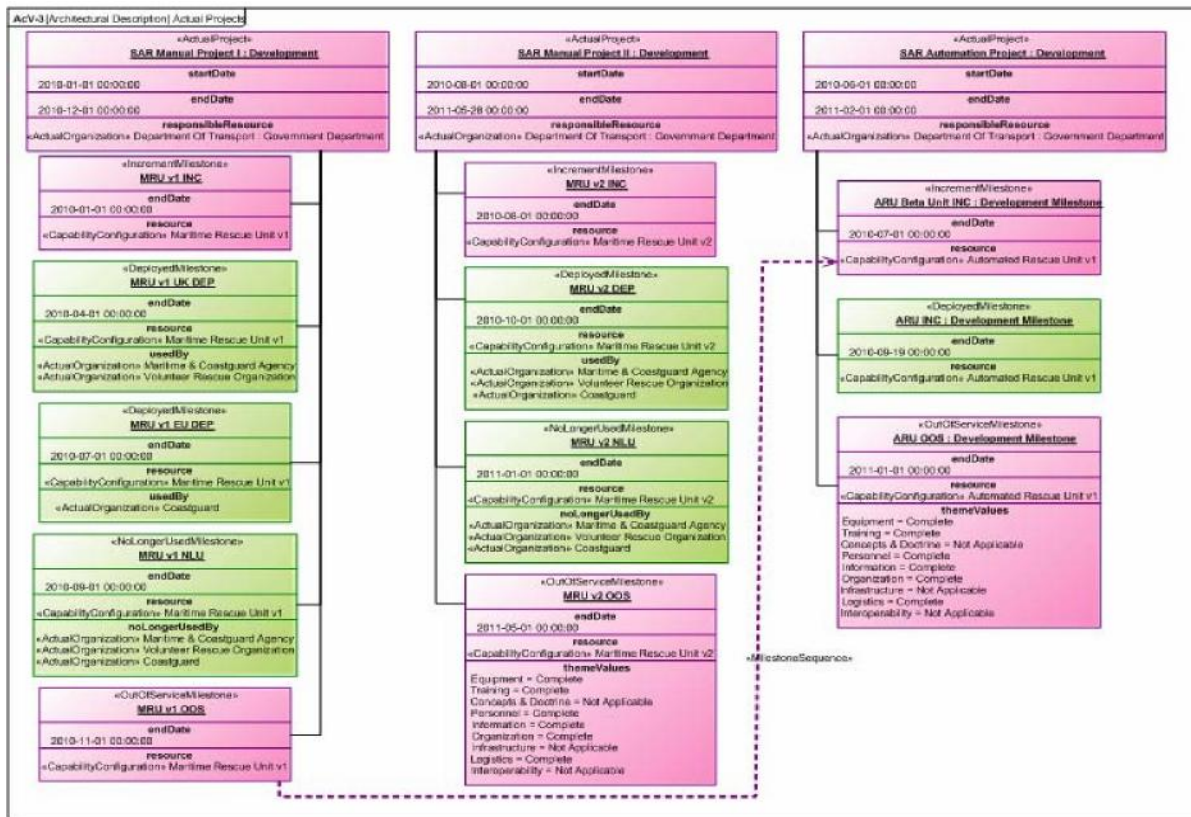

Figure D:42 - AcV-3 Actual

The project also contains increment and deployment milestones that provide a means of showing when resources are deployed and rendered out of service as well as capability increments. An example out of service milestone is shown in Figure D:43.

«OutOfServiceMilestone» ARU OOS : Development Milestone
endDate 2011-01-01 00:00:00
resource
themeValues Equipment = Complete Training = Complete Concepts & Doctrine = Not Applicable Personnel = Complete Information = Complete Organization = Complete Infrastructure = Not Applicable Logistics = Complete Interoperability = Not Applicable

Figure D:43 - AcV-3 Additional Milestone Types

D.11 Technical Views (DoDAF Standards Views)

The Technical views identify the standards, rules, policy and guidance that are applicable to parts of the architecture and the architecture as a whole. Communications protocols can also be defined.

D.11.1 TV-1 Standards Profile (DoDAF StdV-1)

The TV-1 report is in the form of a matrix and summarizes the architecture elements that conform to the various defined standards. Table D:19 shows the conforming elements on the left and the applicable standards across the top. Systems can conform to multiple standards as in the Link 16.

	«Standard» Global Maritime Distress and Safety System (GMDSS)	«Standard» MGN 324 Operational Guidance on the Use Of VHF Radio and Automatic Identification Systems	«Standard» MIL-STD-6016	«Standard» STANAG 5516	«Standard» USCG Marine Radio Information For Boaters
«ResourceArtifact» Communication Device (SAR Architecture::Resources::Resource Artifacts)		X			X
«ResourceArtifact» ESM System (SAR Architecture::Resources::Resource Artifacts)	X				
«ResourceArtifact» Lighting Device (SAR Architecture::Resources::Resource Artifacts)	X				
«ResourceArtifact» Link 16 (SAR Architecture::Resources::Resource Artifacts)			X	X	
«ResourcePort» dsIn (SAR Architecture::Resources::Resource Artifacts::FSM System)	X				
«ResourcePort» dsOut (SAR Architecture::Resources::Resource Artifacts::Lighting Device)	X				
«ResourcePort» receiver (SAR Architecture::Resources::Resource Artifacts::Communication Device)		X			X
«ResourcePort» tdmReceiver (SAR Architecture::Resources::Resource Artifacts::Link 16)			X	X	
«ResourcePort» tdmTransmitter (SAR Architecture::Resources::Resource Artifacts::Link 16)			X	X	
«ResourcePort» transmitter (SAR Architecture::Resources::Resource Artifacts::Communication Device)		X			X

Table D:19 - TV-1

D.11.2 TV-2 Standards Forecast (DoDAF StdV-2)

UPDM provides a class diagram and report format for the TV-2. The class diagram form provides a means of defining the standards and their attributes as well as linking the standards forecasts to them. Figure D:44 shows the various SAR standards provided by ASTM. ASTM International, originally known as the American Society for Testing and Materials (ASTM) is now an international standards body with standards ranging from safety in recreational aviation, to fiber optic cable installations in underground utilities, to homeland security. More information on them can be found at www.ASTM.org. The spans shown are for illustration purposes only. They are normally shown to denote emerging standards.

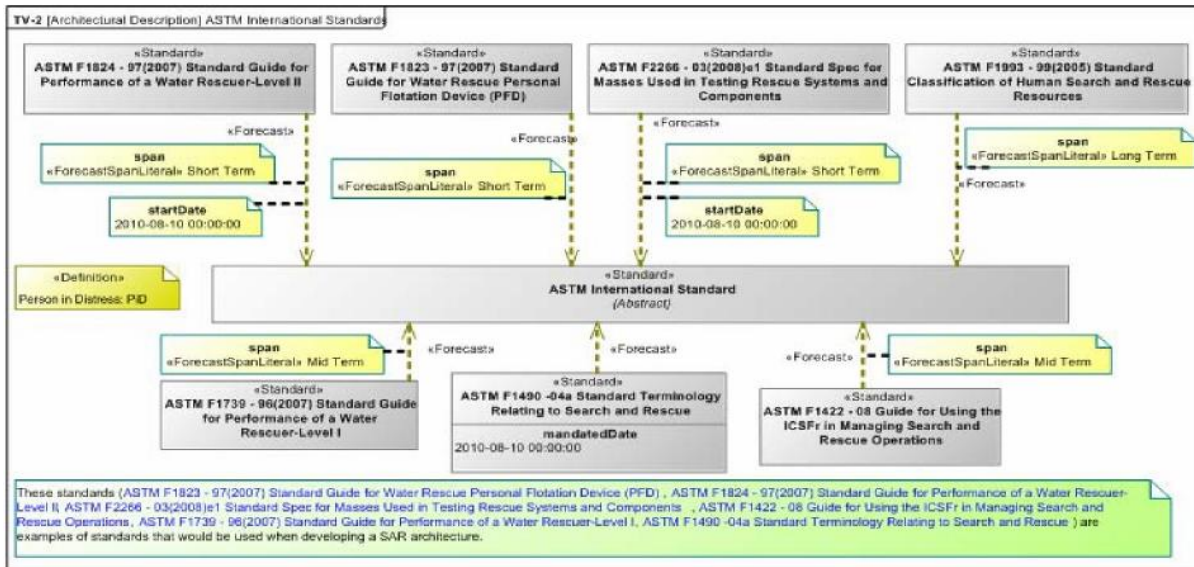

Figure D:44 - TV-2

Figure D:45 shows a variety of standards for marine radio, Link 16, and distress monitoring. These are part of the Capability Configuration shown in the SV-2 diagram.

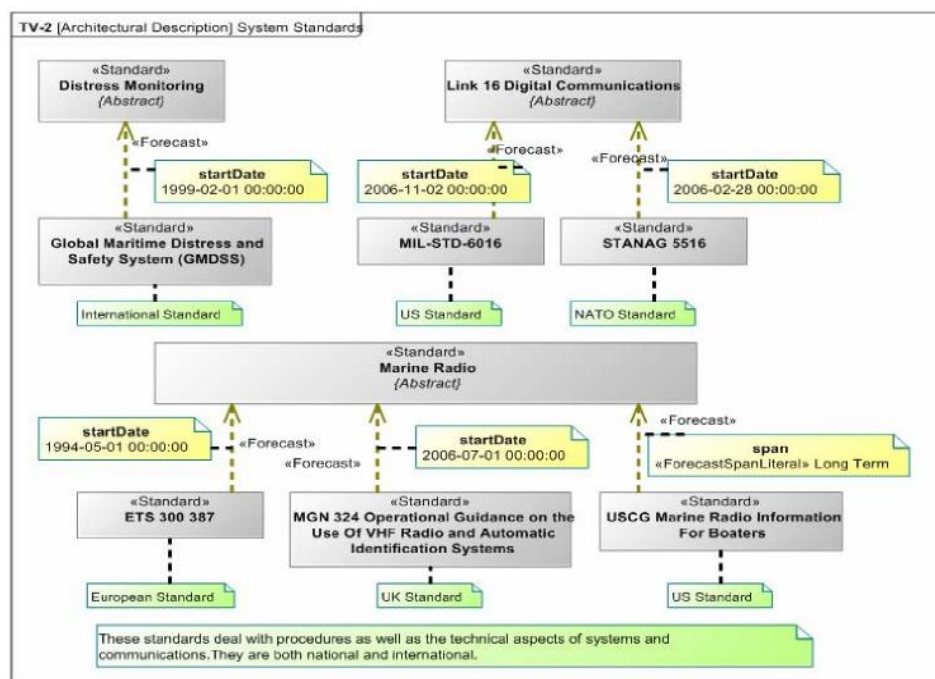

Figure D:45 - TV-2

D.11.3 TV-2 Standards Forecast Tabular Form (DoDAF StdV-2)

Table D:20 shows a summary of the ASTM international standards.

Category Type	Category	Mid Term	Short Term	Long Term	[Undefined]
«Standard»	ASTM International Standard	ASTM F 1422 - 06 Guide for Using the ICSFR in Managing Search and Rescue Operations ASTM F 1739 - 96(2007) Standard Guide for Performance of a Water Rescuer-Level I	ASTM F2266 - 03(2006)e1 Standard Spec for Masses Used in Testing Rescue Systems and Components ASTM F 1823 - 97(2007) Standard Guide for Water Rescue Personal Flotation Device (PFD) ASTM F 1824 - 97(2007) Standard Guide for Performance of a Water Rescuer Level II	ASTM F 1993 - 99(2005) Standard Classification of Human Search and Rescue Resources	ASTM F 1490 -04a Standard Terminology Relating to Search and Rescue

Table D:20 - TV-2

D.12 A Simple Example of SysML Parametrics D.12.1 SysML Parametrics

Parametric diagrams are used to describe constraints on system properties to support engineering analysis. In order to support this type of modeling a ConstraintBlock has been introduced into OMG SysML. A ConstraintBlock defines a set of parameters and one or more constraints on the parameters. The parameters and the connectors do not have direction by default. Hence, the constraint relationships are acausal in nature. Causality can be automatically interpreted based on the state of the model (i.e., what variables are known and what are unknown). These ConstraintBlocks are used in a parametric diagram to constrain system properties. ConstraintBlocks may be used to express mathematical equations such as 'F=moa' and 'a = dv/dt,' or statistical values and utility functions such as might be used in trade studies. Based on the reusable concept of a block new ConstraintBlocks can be built by reusing more primitive ConstraintBlocks such as basic mathematical operators. As shown in Figure D:46, blocks can also own constraint blocks. Blocks can also own parametric diagrams. This is in fact more consistent, more scalable, more persistent, and can be less confusing for people new to parametric diagrams.

SysML also defines a model of value types that can have units and dimensions and probability distributions. The value types are used to type properties of blocks. The Parametric Diagram is a specialized variant of an internal block diagram that restricts diagram elements to represent constraint blocks, their parameters, and the block properties that they bind to. Both parameters and properties may be represented as small "pin-like" boxes to help make the diagrams more scalable.

For more information on Parametric diagrams and SysML, refer to the following documents:

- <http://eislab.gatech.edu/pubs/conferences/2007-incose-is-1-peak-primer/>
- [http://eislab.gatech.edu/pubs/conferences/2007-incose-is-2-peak-diversity /](http://eislab.gatech.edu/pubs/conferences/2007-incose-is-2-peak-diversity/)

D.12.1 Scenario Overview

The search and rescue organization is considering using Unmanned Aerial Vehicles (UAV) to perform set search patterns. One of the parameters of search and rescue is to determine how long it will take to cover a specific search area. Various parameters are number of aircraft, crew availability, aircraft speed, aircraft total flight time, etc. With this information they can budget how many aircraft, crew, etc. they will need to help them achieve their goals. The Little Eye model was created by InterCAX to define such a scenario and demonstrate how parametrics can be used to provide trade-off analysis to answer these questions. We are grateful to them for letting us use their example.

D.12.2 SV-3 System Context

The Little Eye System Block Definition Diagram (BDD) shown in Figure D:46 defines the context of the problem definition. It contains the Aircraft, Crew, and Fuel. They each have a set of values corresponding to the properties to be used in the trade-off analysis. For example, the crew has properties of Crew Time On, Number Available Crews, and Number Crews. These will be used as parameters for the parametric equations.

The System Availability Equation and the Scanning Equations are owned by the Little Eye System defining the context. The crew has the Crew Availability Equation; the Fuel has the Fuel Availability Equation; and finally, Aircraft has the Aircraft, Night Camera, and Day Camera Availability Equations and the Aircraft Duty Cycle Equation. These equations used together will determine the optimum values for the system configurations.

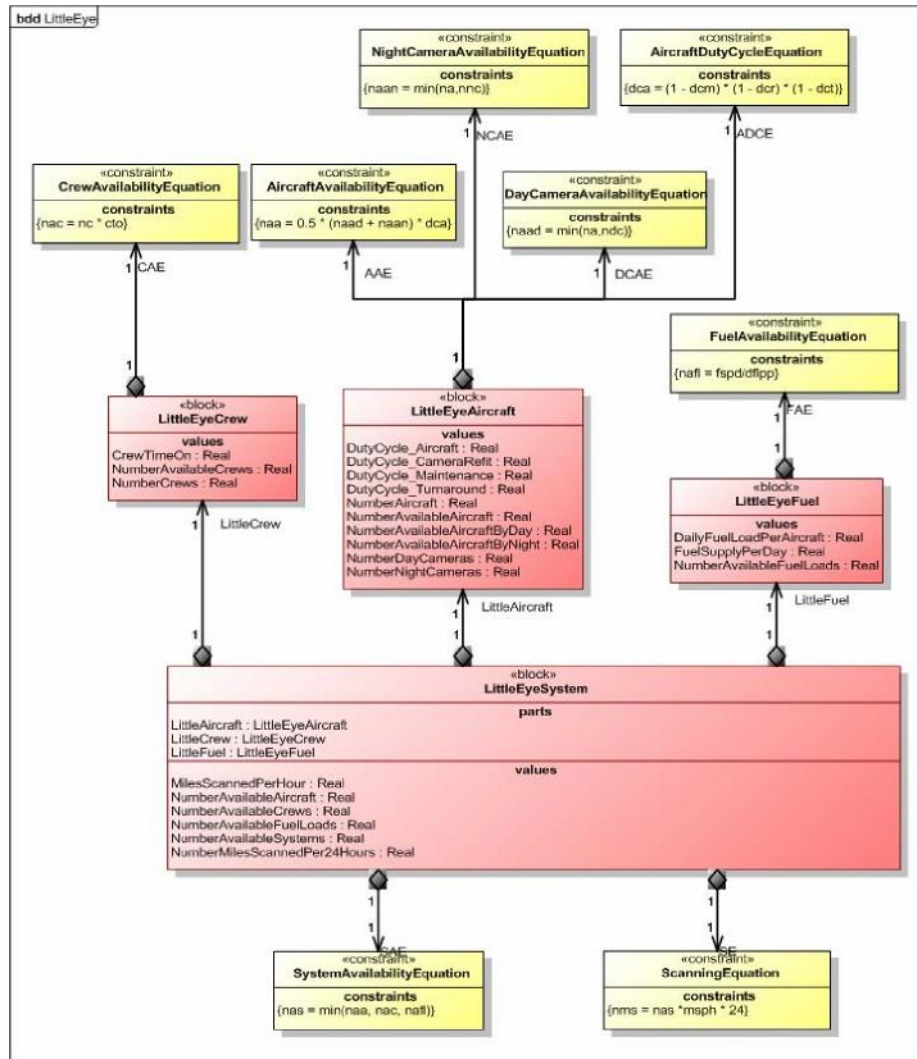

Figure D:46 - Block Definition Diagram

D.12.3 System Parametrics

Figure D:47 shows the Aircraft, Crew, and Fuel value types linked to the System Context values.

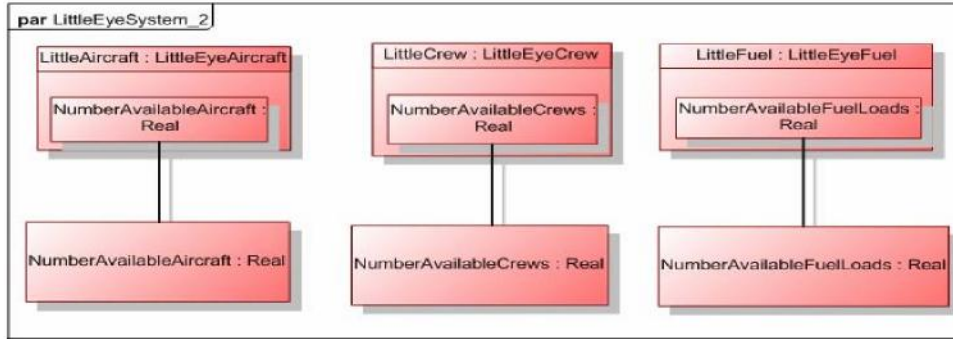

Figure D:47 - System Parametrics

D.12.4 Parametric Equations

Figure D:48 Shows the System Availability and Scanning Equations, their parameters, the value properties, and the relationships between them.

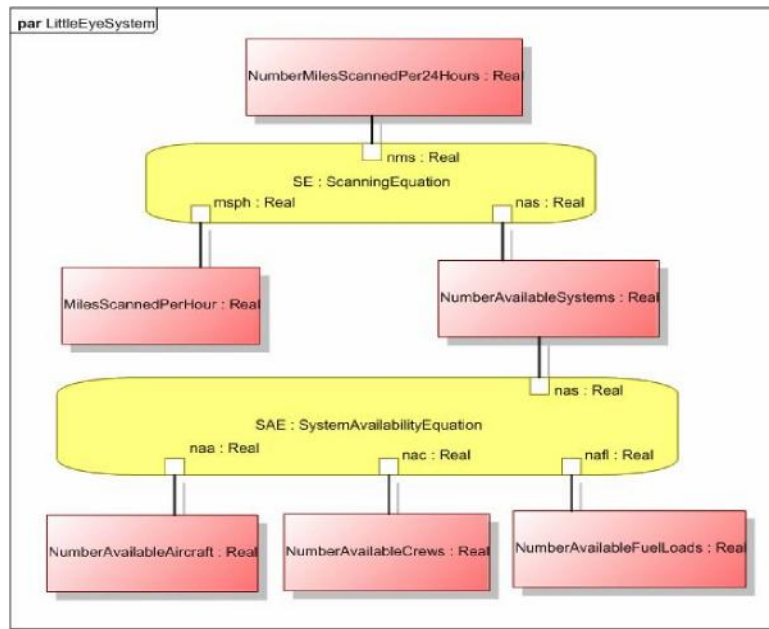

Figure D:48 - Scanning and Availability Equations

Figure D:49 shows the Fuel Availability Equation:

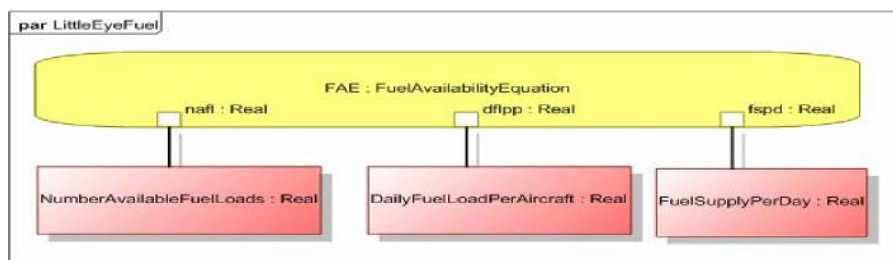

Figure D:49 - Fuel Availability Equation

Figure D:50 shows the Crew Availability Equation.

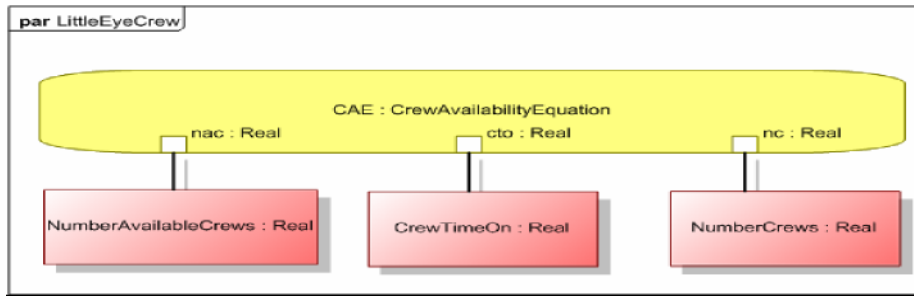

Figure D:50 - Crew Availability Equation

Figure D:51 shows the constraint properties in Little Eye Aircraft. All these parametric equations can be combined together to define the trade-off analysis definition to provide a means of calculating the optimum configuration.

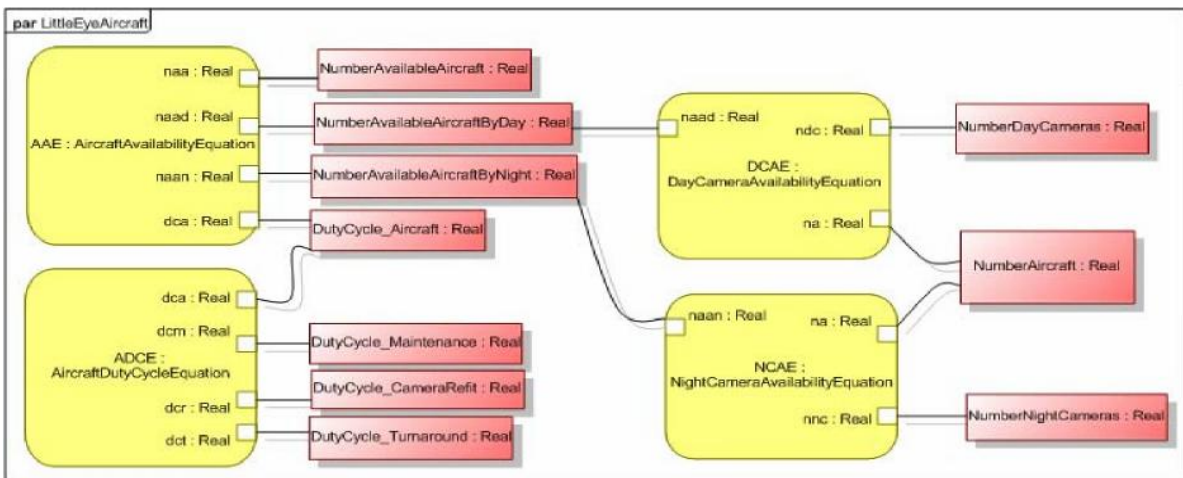

Figure D:51 - Aircraft System Parametric

D.12.5 Instance Diagram

To perform the trade-off analysis calculations an instance diagram of the system components is created as shown in Figure D:52. Initial values are created for some of the value properties as a means of defining set values against which the equation solver can work.

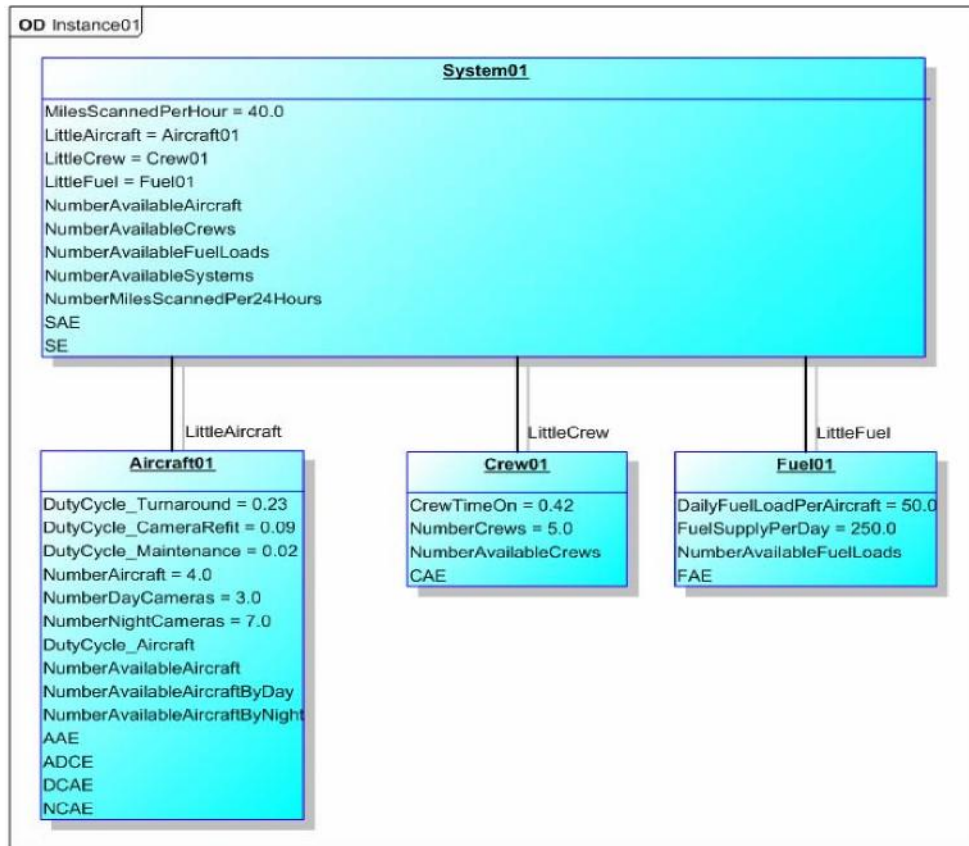

Figure D:52 - System Instance Diagram

Annex E Bibliography

0

- MOD Architectural Framework, Version 1.2, 23 June 2008, Office of Public Sector Information, [http:// www.modaf.org.uk/](http://www.modaf.org.uk/)
- DoD Dictionary of Military Terms, <http://www.dtic.mil/doctrine/jel/doddict/index.html>
- Joint Doctrine Joint Force Employment Briefing, <http://www.dtic.mil/doctrine/jrm/plans.pdf>
- Joint Forces Staff College, Joint Planning and Operations Course, http://www.jfsc.ndu.edu/schools_programs/jpoc/course_materials/default.asp
- Doctrine for Joint Operations, http://www.dtic.mil/doctrine/jel/new_pubs/jp3_0.pdf
- Joint Doctrine for countering air and missile threats, http://www.dtic.mil/doctrine/jel/new_pubs/jp3_01.pdf
- Joint Communications System, http://www.dtic.mil/doctrine/jel/new_pubs/jp6_0.pdf
- Federal Information Processing Standards Publication (FIPS PUB) 183 -- INTEGRATION DEFINITION FOR FUNCTION MODELING (IDEF0), issued by the National Institute of Standards and Technology after approval by the Secretary of Commerce pursuant to Section 111(d) of the Federal Property and Administrative Services Act of 1949 as amended by the Computer Security Act of 1987, Public Law 100-235.