

# UPDATED Property and Casualty Data Model Specification

Beta 2 document

---

OMG Document Number: [dtc/13-04-05](#)

## Submission Contact Points

William Jenkins  
Penn National Insurance  
[WBurrellJenkins@gmail.com](mailto:WBurrellJenkins@gmail.com)

Randall Molnar  
CSC Corporation  
[rmolnar@csc.com](mailto:rmolnar@csc.com)

Bruce Wallman, PhD  
IBM Corporation  
[bwallman@us.ibm.com](mailto:bwallman@us.ibm.com)

Thomas Ford  
LiquidHub, Inc  
[tom.ford@liquidhub.com](mailto:tom.ford@liquidhub.com)

## USE OF SPECIFICATION TERMS, CONDITIONS & NOTICES

The material in this document details an Object Management Group specification in accordance with the terms, conditions and notices set forth below. This document does not represent a commitment to implement any portion of this specification in any company's products. The information contained in this document is subject to change without notice.

### LICENSES

The companies listed above have granted to the Object Management Group, Inc. (OMG) a nonexclusive, royalty-free, paid up, worldwide license to copy and distribute this document and to modify this document and distribute copies of the modified version. Each of the copyright holders listed above has agreed that no person shall be deemed to have infringed the copyright in the included material of any such copyright holder by reason of having used the specification set forth herein or having conformed any computer software to the specification.

Subject to all of the terms and conditions below, the owners of the copyright in this specification hereby grant you a fully paid up, nonexclusive, nontransferable, perpetual, worldwide license (without the right to sublicense), to use this specification to create and distribute software and special purpose specifications that are based upon this specification, and to use, copy, and distribute this specification as provided under the Copyright Act; provided that: (1) both the copyright notice identified above and this permission notice appear on any copies of this specification; (2) the use of the specifications is for informational purposes and will not be copied or posted on any network computer or broadcast in any media and will not be otherwise resold or transferred for commercial purposes; and (3) no modifications are made to this specification. This limited permission automatically terminates without notice if you breach any of these terms or conditions. Upon termination, you will destroy immediately any copies of the specifications in your possession or control.

### PATENTS

The attention of adopters is directed to the possibility that compliance with or adoption of OMG specifications may require use of an invention covered by patent rights. OMG shall not be responsible for identifying patents for which a license may be required by any OMG specification, or for conducting legal inquiries into the legal validity or scope of those patents that are brought to its attention. OMG specifications are prospective and advisory only. Prospective users are responsible for protecting themselves against liability for infringement of patents.

### GENERAL USE RESTRICTIONS

Any unauthorized use of this specification may violate copyright laws, trademark laws, and communications regulations and statutes. This document contains information which is protected by copyright. All Rights Reserved. No part of this work covered by copyright herein may be reproduced or used in any form or by any means-graphic, electronic, or mechanical, including photocopying, recording, taping, or information storage and retrieval systems--without permission of the copyright owner.

### DISCLAIMER OF WARRANTY

WHILE THIS PUBLICATION IS BELIEVED TO BE ACCURATE, IT IS PROVIDED "AS IS" AND MAY CONTAIN ERRORS OR MISPRINTS. THE OBJECT MANAGEMENT GROUP AND THE COMPANIES LISTED ABOVE MAKE NO WARRANTY OF ANY KIND, EXPRESS OR IMPLIED, WITH REGARD TO THIS PUBLICATION, INCLUDING BUT NOT LIMITED TO ANY WARRANTY OF TITLE OR OWNERSHIP, IMPLIED WARRANTY OF MERCHANTABILITY OR WARRANTY OF FITNESS FOR A PARTICULAR PURPOSE OR USE. IN NO EVENT SHALL THE OBJECT MANAGEMENT GROUP OR ANY OF THE COMPANIES LISTED ABOVE BE LIABLE FOR ERRORS CONTAINED HEREIN OR FOR DIRECT, INDIRECT, INCIDENTAL, SPECIAL, CONSEQUENTIAL, RELIANCE OR COVER DAMAGES, INCLUDING LOSS OF PROFITS, REVENUE, DATA OR USE, INCURRED BY ANY USER OR ANY THIRD

PARTY IN CONNECTION WITH THE FURNISHING, PERFORMANCE, OR USE OF THIS MATERIAL, EVEN IF ADVISED OF THE POSSIBILITY OF SUCH DAMAGES.

The entire risk as to the quality and performance of software developed using this specification is borne by you. This disclaimer of warranty constitutes an essential part of the license granted to you to use this specification.

#### RESTRICTED RIGHTS LEGEND

Use, duplication or disclosure by the U.S. Government is subject to the restrictions set forth in subparagraph (c) (1) (ii) of The Rights in Technical Data and Computer Software Clause at DFARS 252.2277013 or in subparagraph (c)(1) and (2) of the Commercial Computer Software Restricted Rights clauses at 48 C.F.R. 52.22719 or as specified in 48 C.F.R. 22772022 of the DoD F.A.R. Supplement and its successors, or as specified in 48 C.F.R. 12.212 of the Federal Acquisition Regulations and its successors, as applicable. The specification copyright owners are as indicated above and may be contacted through the Object Management Group, 140 Kendrick Street, Needham, MA 02494, U.S.A.

#### TRADEMARKS

MDA®, Model Driven Architecture®, UML®, UML Cube logo®, OMG Logo®, CORBA® and XMI® are registered trademarks of the Object Management Group, Inc., and Object Management Group™, OMG™, Unified Modeling Language™, Model Driven Architecture Logo™, Model Driven Architecture Diagram™, CORBA logos™, XMI Logo™, CWM™, CWM Logo™, IIOPT™, IMM™, MOF™, OMG Interface Definition Language (IDL)™, and OMG Systems Modeling Language (OMG SysML)™ are trademarks of the Object Management Group. All other products or company names mentioned are used for identification purposes only, and may be trademarks of their respective owners.

#### COMPLIANCE

The copyright holders listed above acknowledge that the Object Management Group (acting itself or through its designees) is and shall at all times be the sole entity that may authorize developers, suppliers and sellers of computer software to use certification marks, trademarks or other special designations to indicate compliance with these materials.

Software developed under the terms of this license may claim compliance or conformance with this specification if and only if the software compliance is of a nature fully matching the applicable compliance points as stated in the specification. Software developed only partially matching the applicable compliance points may claim only that the software was based on this specification, but may not claim compliance or conformance with this specification. In the event that testing suites are implemented or approved by Object Management Group, Inc., software developed using this specification may claim compliance or conformance with the specification only if the software satisfactorily completes the testing suites.

### **OMG's Issue Reporting Procedure**

All OMG specifications are subject to continuous review and improvement. As part of this process we encourage readers to report any ambiguities, inconsistencies, or inaccuracies they may find by completing the Issue Reporting Form listed on the main web page <http://www.omg.org>, under Documents, Report a Bug/Issue (<http://www.omg.org/technology/agreement.htm>).

# Preface

## OMG

Founded in 1989, the Object Management Group, Inc. (OMG) is an open membership, not-for-profit computer industry standards consortium that produces and maintains computer industry specifications for interoperable, portable and reusable enterprise applications in distributed, heterogeneous environments. Membership includes Information Technology vendors, end users, government agencies, and academia.

OMG member companies write, adopt, and maintain its specifications following a mature, open process. OMG's specifications implement the Model Driven Architecture® (MDA®), maximizing ROI through a full-lifecycle approach to enterprise integration that covers multiple operating systems, programming languages, middleware and networking infrastructures, and software development environments. OMG's specifications include: UML® (Unified Modeling Language™); CORBA® (Common Object Request Broker Architecture); CWM™ (Common Warehouse Metamodel); and industry-specific standards for dozens of vertical markets.

More information on the OMG is available at <http://www.omg.org/>.

## OMG Specifications

As noted, OMG specifications address middleware, modeling, and vertical domain frameworks. A catalog of all OMG Specifications Catalog is available from the OMG website at:

[http://www.omg.org/technology/documents/spec\\_catalog.htm](http://www.omg.org/technology/documents/spec_catalog.htm)

Specifications within the Catalog are organized by the following categories:

### OMG Modeling Specifications

- UML
- MOF
- XMI
- CWM
- OMG SysML™
- Other Profile specifications.

### OMG Middleware Specifications

- CORBA/IIOP
- DDS and the DDS Interoperability Protocol, RTPS
- IDL/Language Mappings
- Specialized CORBA specifications
- CORBA Component Model (CCM)



## Platform Specific Model and Interface Specifications

- CORBA services
- CORBA facilities
- OMG Domain specifications
- OMG Embedded Intelligence specifications
- OMG Security specifications.

All of the OMG's formal specifications may be downloaded without charge from our website. (Products implementing OMG specifications are available from individual suppliers.) Copies of specifications, available in PostScript and PDF format, may be obtained from the Specifications Catalog cited above or by contacting the Object Management Group, Inc. at:

OMG Headquarters  
140 Kendrick Street  
Suite 300  
Needham, MA 02494  
USA  
Tel: +17814440404  
Fax: +17814440320  
Email: [pubs@omg.org](mailto:pubs@omg.org)

Certain OMG specifications are also available as ISO standards. Please consult <http://www.iso.org>.

## Typographical Conventions

The type styles shown below are used in this document to distinguish programming statements from ordinary English. However, these conventions are not used in tables or section headings where no distinction is necessary.

Times/Times New Roman 10 pt.: Standard body text

**Helvetica/Arial 10 pt. Bold: OMG Interface Definition Language (OMG IDL) and syntax elements.**

*Courier 10 pt. Bold: Programming language elements.*

Helvetica/Arial 10 pt: Exceptions

Terms that appear in italics are defined in the glossary. Italic text also represents the name of a document, specification, or other publication.

## Issues

The reader is encouraged to report any technical or editing issues/problems with this specification to <http://www.omg.org/technology/agreement.htm>.

<b>Part One</b> .....	1
1.1 Introduction.....	1
1.2 Submission Overview.....	1
1.3 Contributing Organizations and Individuals.....	1
1.4 Resolution of RFP Requirement and Requests.....	3
1.5 Benefits.....	5
1.5.1 Introduction.....	5
1.5.2 Benefits of an Industry Standard Data Model.....	5
1.5.3 Using an Industry Standard Data Model.....	6
1.5.4 Conclusion.....	7
1.6 Proof of Concept.....	8
1.6.1 Penn National OMG Value Proposition.....	8
1.6.2 Harleysville Insurance Company OMG Value Proposition.....	8
1.6.3 Major International Insurance Carrier OMG Value Proposition.....	9
 <b>Part Two</b> .....	 10
2.1 Scope.....	10
2.2 Conformance.....	10
2.3 Data Model Guidelines and Standards.....	12
2.3.1 Purpose of Data Models.....	12
2.3.2 Types of Data Models.....	12
2.3.3 Naming Practices.....	14
2.3.4 Data Model Definition Practices.....	15
2.3.5 Data Model Object Definition Practices.....	17
2.3.6 Standard Abbreviations.....	21
2.3.7 How to Read a Logical Data Model.....	23
2.3.8 Normative References.....	32
2.3.9 Terms and Definitions.....	32
 <b>Part Three</b> .....	 34
3.1 Specification.....	34
3.1.1 Conceptual Data Model.....	35
3.1.2 Party Subject Area Model.....	37
3.1.3 Account and Agreement Subject Area Model.....	38
3.1.4 Policy Subject Area Model.....	39
3.1.5 Claim Subject Area Model.....	40
3.1.6 Assessment Subject Area Model.....	41
3.1.7 Agreement Role Subject Area Model.....	42

3.1.8 Claim Role Subject Area Model..... 43

3.1.9 Staffing Role Subject Area Model ..... 44

3.1.10 Party Subtype Subject Area Model ..... 45

3.1.11 Insurable Object Subtype Subject Area Model ..... 46

3.1.12 Money Subtype Subject Area Model ..... 47

3.1.13 Event Subtype Subject Area Model ..... 48

3.1.14 Product Coverage Reference Subject Area Model..... 49

3.2 Glossary of Data Model Terms and Definitions ..... 50

3.2.1 Subject Area Definitions ..... 50

3.2.2 Entity Definitions ..... 53

3.2.3 Attribute Definitions..... 78

3.2.4 Relationship Definitions..... 97

3.2.5 Domain Definitions ..... 118

3.3 Model/Term Cross Reference ..... 138

3.3.1 Subject Area Entities ..... 138

3.3.2 Entity Attributes ..... 171

3.4 Business Terms Reference Glossary..... 203

**Part Four** ..... 262

8.1 Changes or Extensions to Existing OMG Specifications ..... 262

# Part One

## 1.1 Introduction

This specification is submitted in response to: "Information Models for Property and Casualty Insurance RFP" (OMG Document finance/07-06-07).

## 1.2 Submission Overview

This submission responds to a request for proposals from the Object Management Group (OMG) for 'Information Models' to address the data management needs of the Property and Casualty (P&C) insurance community. This submission uses OMG's Model Driven Architecture principles and related standards (<http://www.omg.org/mda/>). Also, this submission uses existing P&C industry standards (e.g., IBM's IAA) as a source for the proposed P&C Business Glossary and associated models. Both points satisfy requirements found in the OMG's Request for Proposals (RFP) for a P&C industry standard data model.

The scope for this initiative includes the U.S. P&C marketplace for claims data and policy data. In addition data which transcends or is common to these two areas have been incorporated into a core or reference model, e.g. name, address.

This submission does not include initial submission models incorporating billing, agency, reinsurance or other functions within the insurance value chain. These are to be addressed in subsequent releases

## 1.3 Contributing Organizations and Individuals

The following are the submitting organizations of this specification in response to the above RFP. The individuals referenced as the contact points are authorized by the established P&C Work Group to officially state the group's position relative to the submission, including matters related to copyright ownership, etc.

<u>Organization</u>	<u>Individual</u>
ACE Insurance Group	Michael Gallo
Cindy Maike Associates	Cindy Maike
CSC Corporation	Randy Molnar
CTS Consulting	Charlie Schaefer
Gail Austin Associates	Gail Austin
Garza Data Consulting	Susan Garza
Harleysville Insurance Group	Charles Wiberly
IBM Corporation	Bruce Wallman
LiquidHub	Tom Ford

Thomas Ford 2/20/13 2:04 AM  
Formatted: Width: 8.5", Height: 11"

Thomas Ford 2/20/13 11:52 PM  
Formatted: No bullets or numbering

	Allyson Frank Anne Marie Smith
Mark Gorman & Associates	Mark Gorman
Penn National Insurance	Bill Jenkins Kevin Kauffman Steve Zerby
TCS	Dennis Maroney
21 <sup>st</sup> Century Insurance	Lisa Cummins Willy Passerallo

### Copyright Notice

Each of the submitting organizations listed above: (i) grants to the Object Management Group, Inc. (OMG) a nonexclusive, royalty-free, paid up, worldwide license to copy and distribute this document and to modify this document and distribute copies of the modified version, and (ii) grants to each member of the OMG a nonexclusive, royalty-free, paid up, worldwide license to make up to fifty (50) copies of this document for internal review purposes only and not for distribution, and (iii) has agreed that no person shall be deemed to have infringed the copyright in the included material of any such copyright holder by reason of having used any OMG specification that may be based hereon or having conformed any computer software to such specification."

The submitters wish to acknowledge and thank the following organizations and individuals who contributed to the development of these specifications.

<u>Individual</u>	<u>Organization</u>
Richard Affenit	Main Street America Group
Paul Ayoub	Employers Insurance
Donald Chapin	Business Semantics
Paul Dolbec	Oracle Corp
Denise Garth	Innovation Group
Art Hill	Unisys Corp.
Tom King	Oracle Corp
Manfred R. Koethe	888Solutions Corp.
Erin Marzolf	Philadelphia Insurance
Pete Rivett	Adaptive
Harsh Sharma	Citibank
John D. Vale	Accenture

## 1.4 Resolution of RFP Requirement and Requests

The following outlines the requirements as depicted in the OMG RFP, "Information Models for Property and Casualty Insurance", dated June 6, 2007. Each of the referenced standards below lists the original paragraph number from the RFP in brackets. The requirements are printed in bold Times-Roman type. Following each requirement is a response of how the requirement is satisfied by this specification. The response is in Arial type.

**{6.1.2/6.5.1} Glossary of Business Terms as described in 6.1.2 e.g.**

**Submitters are urged to not only submit a standard Glossary of P&C Business Terms but also the ability to accommodate valid variations. Business terms must be defined in English.**

**The following metadata associated with each Business Term must also be provided:**

- **Format**
- **Source (data, version)**

**Relationships between terms must be defined, such as:**

- **Generalizations/specifications**
- **Synonyms/aliases**
- **Related terms**

This specification defines the basic business terms and entities used for conducting business from a reference/core, policy and claims perspective for the P&C insurance industry. These terms were compiled and defined through available industry (insurance) dictionaries, Subject Matter Experts (SMEs) and donated industry artifacts, e.g. IBM; IAA Business Glossary.

These sources were the basic sources for data definition and relationship identification.

This standard business glossary of P&C terms was used to develop the conceptual model (CDM). The business glossary allowed for the identification and grouping of subject areas such that the same subject area names across the models to assist traceability.

**{6.1.3/6.5.2} Submitters must provide a P&C Conceptual Data Model as described in 6.1.3. A Conceptual Data Model (CDM) representing P&C business concepts with a target audience of business SMEs, data modelers and business analysts.**

**The CDM shall consist of business Entities and Relationships.**

**Each shall be mapped to one or more Terms in the Business Glossary.**

**The CDM shall be represented using either UML or the CWMX Entity Relationship metamodel.**

**The CDM shall be visualized using one or more of the following notations: UML, IDEFIX, IE, ORM**

This specification is a visual depiction of business concepts and their relationships at a high level. It describes "things" that matter to the business. "Party buys a "Policy" that can be an Auto policy, Home policy are examples. The P&C CDM was and must be developed using the standard P&C business glossary.

**{6.1.4/6.5.1} A fully attributed Logical (ER) Data Model with appropriate identifiers, logical data types and relationships as described in 6.1.4.**

**The LDM shall consist of Entities, Attributes, Relationships and Subject Areas.**

**Each shall be mapped to one or more Terms in the Business Glossary.**

**The LDM shall be represented using the CWMX Entity Relationship metamodel.**

**The LDM shall be visualized using one or more of the following notations: IDEFIX, IE.**

This specification was developed further refining the CDM by identifying Attributes that are pertinent to a business concept represented as an "Entity" ("Policy" for example). It captures additional details about the "Policy" including unique ways to identify a "Policy" as well as details of how a "Policy" may be related to other business concepts like "Party". The LDM is derived from the CDM and is platform independent.

**{6.1.2/6.1.6} Submitters may provide a P&C Dimensional Model (aka Star Schema) that consists of "Fact" Tables and "Dimensions" as described in 6.1.6.**

**The dimensional model may be expressed using the CWM OLAP and Relational metamodels.**

**Each element may be mapped to one or more elements in the LDM**

**It may be visualized using one or more of the following notations: IDEFIX, IE.**

**The Dimensional Model may also be provided as a non-normative SQL Data Definition Language file.**

**A list of Fact Tables other than those described in section 6.1.6 for the Dimensional/ Analytical model is an optional requirement.**

The chart below represents a recap of the mandatory requirements as depicted in the original "Information Models for Property and Casualty Insurance" RFP Section 6.5 and outlined above. The chart references the outlined mandatory deliverables, the page number from the original RFP describing this mandatory requirement and if this submission the section and page where this mandatory requirement can be found in this submission document.

Requirement	RFP Section/Page No.	Submission Doc. Section/Page No.
Glossary of P&C Business Terms	Section 6.5.1 Page 17	Section 4 Page 25-53
P&C Conceptual Model (CDM)	Section 6.5.2 Page 18	Section 5.3 Page 56
P&C Logical Data Model (LDM)	Section 6.5.3 Page 19	Section 6 Page 58-70
Model Object Definitions	Section 6.5.4 Page 20	Section 7 Page 71-142

## 1.5 Benefits

### 1.5.1 Introduction

Industry surveys, research papers, and industry publications report that most organizations today either have implemented or are beginning data integration or data conversion efforts. Data is viewed, especially in the insurance industry, as a strategic asset. There is a push for organizations to embrace and use Service Oriented Architecture (SOA) for the rapid development and deployment of IT systems. The foundation of SOA is standardized business processes based on standardized data. There is a lack of standardized data across the insurance industry, even though all insurance companies employ many of the same concepts (Party, Location, Transaction, etc.) This lack of standards hampers the development of SOA initiatives for the insurance industry, and contributes to the difficulty of rationalizing data across companies for industry-level comparisons.

The common, inherent complexities of the property and casualty insurance industry can make modeling a very difficult endeavor for those companies whose size does not support a large and dedicated data modeling / data management staff. Having the opportunity to leverage an industry standard model can accelerate these companies' development of a data management approach to application development and information sharing.

An enterprise data model helps establish a common framework and language within an organization and across the industry, improving communications and expediting the development, integration and enhancement of applications and their quality. In addition, having a common framework and language within the industry improves communication across partner organizations, and ultimately saves time and money by eliminating the need to build and use "translators" across all communicating parties. A standard data dictionary and data model is the basis of this communication that also allows organizations to control and track the language of data (meta data).

### 1.5.2 Benefits of an Industry Standard Data Model

Industry standard models that have been developed by industry participants provide many tangible and strategic benefits over models developed by individual vendors, including:

1. Accurate and common representation and exchange of information and internal and external business rules, based on accepted knowledge of industry concepts.
2. Consistency across applications and improved accuracy of information, providing users with repeatable, reliable results and a higher level of data quality. These benefits enable the development of Service Oriented Architectures (SOA) and to standardization for terms and meanings (meta data).
3. Reduced data redundancies and increased data sharing, making the application development process more efficient and faster



4. Information sharing across multiple vendor products thereby facilitating interoperability and flexibility of choice. Also, standard models provide for more rapid access to data and commonly used definitions and other meta data.
5. Fewer redundant applications and reduced development of needless interdependent processes, thereby preventing efforts to build multiple interfaces/translators. Benefits include more efficient processing for new business approaches or data requests.
6. Fewer redundant data stores since the use of a standard model provides a single source of validated data across the organization.
7. Increased resiliency to platform changes by having the flexibility to deploy the same model on a new platform of choice with minimal change(s). This benefit enables flexibility in integrating operations from a merger or acquisition (M&A); also this capability provides the opportunity to allow work to be done by outside resources (operational outsourcing).
8. More efficient and smaller investment in time for educating new design and development staff or consultants.
9. Even when not applied in its entirety, a standard model can facilitate or serve as a reference for any data modeling / application development or enhancement effort.
10. An industry standard, open-source data model provides a more efficient, low-cost solution versus purchased industry models that are proprietary to a vendor or dependent upon a particular technical solution.

### **1.5.3 Using an Industry Standard Data Model**

Once an organization has chosen to adopt an industry standard data model, how could they use it? There are many ways to leverage the benefits of using an industry standard enterprise data model, including:

1. Use the standard model as the organization's enterprise model, either in its current form or with appropriate organization-specific modifications. This will reduce the amount of time needed to construct an organization's enterprise data model significantly.
2. Use the industry standard data model to identify omissions (gaps) in the organization's existing enterprise data model. Doing so will enable refinement of the organization's enterprise data model, improving its usability across the organization.
3. Use the standard model's data definitions and terms as the basis for an organization-specific data dictionary, or adopt the standard model's definitions without changes. This will enable the development of a common vocabulary for the organization, based on industry standard terms and definitions, thereby

reducing confusion across business units. It also contributes to the development of a robust data governance and stewardship program, by giving the stewards the foundation for their efforts.

4. Use all the meta data provided in the industry standard data model as the basis for the organization's meta data management approach and as the foundation for building the organization's meta data repository. Using the meta data from the industry standard data model will facilitate the rapid development of a meta data management program that enables more effective data integration and conversion.
5. Use the standard model's dimensional model as the basis for the organization's dimensional model for data warehousing. Developing an organization-specific dimensional data model requires significant time and experience, and presupposes that an atomic level enterprise model exists. Using the industry standard data model as the foundation for the dimensional model significantly reduces the time needed for this activity.
6. Use the conceptual data model entities as the basis for establishing the organization's master data management (MDM) categories and content. Use the logical data model's attributes to refine the actual master data elements for the organization's MDM facility. Effective master data management requires the implementation of an enterprise data model (standard or specific) and leveraging an industry standard data model can reduce the time needed to identify the MDM classes and attributes significantly.
7. Use the standard model as a reference for any data modeling / application development or enhancement effort, whether the organization is using SOA or not. Data integration, as a result of company mergers or conversion from legacy applications is a data-intensive effort. Having the reference capabilities of an industry model can facilitate data integration and conversion from both internal and external sources by providing an orientation for translating one application's data to another application. Also, if the organization has adopted an SOA approach to data integration and manipulation, standardizing the data through the implementation of an enterprise data model will enable SOA with fewer challenges than if attempted without standardized data.

## 1.5.4 Conclusion

The Object Management Group (OMG) has developed a property-casualty insurance enterprise data model; it was created by representatives from many carriers using experts in each subject area. This model can provide all of the benefits listed above, and can be used in all the ways listed here. Some organizations have begun to use it successfully, and others are exploring the incorporation of this industry standard enterprise data model into their data management programs.

## 1.6 Proof of Concept

Below are several testimonials /value propositions concerning the use of the available artifacts today:

### 1.6.1 Penn National OMG Value Proposition

At Penn National Insurance, we've recently began a project to globalize our customer data among various disparate, internal systems; each of them generating their own unique customer ID's. At the beginning of the project, we spent a full week attempting to develop a data model for our centralized customer information. Needless to say, we didn't get very far after a full week. Each of the team members had their own idea of how the data model should look (which is often what happens from company to company without a standard model in place). After looking at the OMG model, we scrapped our original design and decided to use the OMG data model as a template for building our customer data repository. We studied the model to see what pieces we could incorporate now to satisfy our requirements without deviating from the OMG Model. Thus, we decided to use the "Party" object (and all associated child nodes) for our client data. In doing this, we saved at least 6 weeks of design time. In addition, the OMG model prevented us from "reinventing the wheel". As we move forward expanding the scope of our project, we will continue to utilize the OMG Model as a basis (template) and will only deviate when our business requires it.

Kevin Kauffman, MCSD

Sr. Application Development Specialist Web

Architecture and Agency Systems

Penn National Insurance

P.O. Box 2361

2 N. 2nd St. Harrisburg, PA 17105

800.388.4764 Ext.

[kkauffman@pnat.com](mailto:kkauffman@pnat.com) [www.PennNationalInsurance.com](http://www.PennNationalInsurance.com)

### 1.6.2 Harleysville Insurance Company OMG Value Proposition

At Harleysville Insurance we are looking at this industry specific data model as an enterprise level reference tool. The gatekeepers of this information will be the Business Information Systems team, who is responsible for overall business intelligence applications, data modeling, data quality and metadata management. Our primary usage will in populating the enterprise metadata repository, especially with business definitions of data elements a definitive one doesn't exist internally. The glossary information from this model will be used to stimulate discussion with

business information consumers.

From a data model development perspective, this model will serve as a starting point for new initiatives by providing a starting point that fits the P&C business model. It will also be used as a "sounding board" for existing data models to ascertain completeness and applicability for the business.

James Danner

Harleysville Insurance Company

### **1.6.3 Major International Insurance Carrier OMG Value Proposition**

The data model will become a reference point from which we can develop a logical enterprise view of our organization without going through the pain points associated with starting from a blank sheet. It will serve as a basis for many of our smaller data base initiatives as well as provide us with a basis for our Metadata and Master Data Management initiatives which are just getting underway. It can also serve as a conduit to enhance the communication between the varied business units within our organization through the use of standardized framework and language within our organization.

# Part Two

## 2.1 Scope

This submission responds to a proposal from the Object Modeling Group (OMG) for 'Information Models' RFP. The RFP is identified by the document number finance/2007-06-07, <http://www.omgwiki.org/pcwg/doku.php?id=start> to address the data management needs of the Property and Casualty (P&C) insurance community. This submission uses OMG's Model Driven Architecture principles and related standards (<http://www.omg.org/mda/>). Also, this submission uses existing P&C industry standards (e.g., IBM's IAA) as a source for the proposed P&C Business Glossary and associated models. Both points satisfy requirements found in the OMG's Request for Proposals (RFP) for a P&C industry standard data model.

The scope for this initiative includes the U.S.P&C marketplace data for the core Party, Policy and Claims Subject Areas. Additional data models have been included to sub-types and roles and to further describe the major entity concepts of Accounts and Agreements, Assessments, Events, and Money.

This submission does not include initial submission models incorporating billing, agency, reinsurance or other functions within the insurance value chain. These are to be addressed in subsequent OMG specification.

## 2.2 Conformance

Many organizations of varying types may desire to use the P&C Data Model in varying ways. We encourage all interested organizations (carriers, vendors, consultancies, agencies, etc.) to explore ways to use this model to its best advantage. However, for an organization to be considered to have implemented this model in conformance with the OMG standard, the following conceptual major data entities must be implemented exactly as represented in this submission document. All other entities can be extended or collapsed as the organization's needs dictate.

Major Property and Casualty Data Model Entities:

- Account
- Activity
- Agreement
- Claim
- Communication
- Coverage
- Event
- Geographic Location
- Insurable Object
- Location Address

- Money
- Party
- Policy
- Policy Coverage Detail
- Policy Deductible
- Policy Limit
- Product
- Product Coverage
- Reinsurance Agreement
- Reinsurance Coverage

## 2.3 Data Model Guidelines and Standards

The following section contains proposed conceptual and logical (to physical) data modeling practices.

### 2.3.1 Purpose of Data Models

We develop logical data models because of what data models represent and what they should achieve:

- Business rules about data
- A means of graphically depicting how data can be shared and stored non-redundantly
- A way of defining data requirements in accordance with a set of rules and common methodology
- A picture of the business data that is technology-independent and in business terms
- Means of defining and certifying business data requirements
- Provides the data structure definition for a project.
- THE integrator for all data sharing, master data, and data warehouse efforts
- Framework and methodology for managing data integrity
- Specification for the meaning of the data elements, structures, relationships, technical names and data types
- Basis for database design

### 2.3.2 Types of Data Models

- **Business or Conceptual Data Model**

A conceptual data model is a high-level data model identifying major entities and relationships of importance to the business. It does not resolve “many-to-many relationships, may not contain any attributes, and may not be “normalized”. It is like a roadmap to more detailed logical models and enables all users of detail models to quickly grasp the scope, terminology and concepts used in the model.

- **Logical Data Model**

A logical data model contains the full definition of the entities, attributes, and relationships needed to satisfy the business and technical requirements for data within the scope of the effort begin undertaken. It represents the business meaning and rules for the data independent of technical considerations such as software, hardware, or performance.

- **Physical Data Model**

A physical data model should be the physical representation of the logical data model, with any added physical constructs necessary to build databases. The physical data model defines the tables (from entities), columns (from attributes), and keys, foreign keys, and constraints (from relationships) and indexes necessary to find and retrieve data.

A physical data model may also be “reverse engineered” from an existing database in order to describe and understand the database in a meaningful pictorial representation.

- **Dimensional Data Model**

A dimensional data model is a specialized data model that is designed to facilitate analytics. It has a limited scope of data usually focused on a business or client function, and represents the data in “fact” and “dimension” tables. While it is considered a “physical only” model, the logical version of this with business terms and definitions is the recommended practice. The kinds of terms, systems, and designs that are associated with dimensional models include data marts, star schema, snowflake schema, and business intelligence.

- **Vendor Product Data Models**

Vendor products do have underlying data models that should be requested for review if a vendor product is being used to fulfill a business need. If a vendor product is going to be used, it is highly recommended that at least a conceptual data model (and ideally a fully attributed logical data model) be constructed to represent the business data requirements. Then the requirements data model can be compared to the vendor’s data model and a true assessment of the vendor data management can be made.

- **Enterprise**

An enterprise data model is a high level conceptual, and evolutionary logical, data model that represents a concept of all the major business entities and relationships. It can therefore be used for strategic planning, and for determining the scope, content, and interrelationships of specific tactical solutions.

An enterprise data model does not take three years to develop, as was the case with previous efforts. It can be done with a group of business people over the course of a month on a part-time basis. It is highly recommended as a roadmap for information excellence.

- **Operational**

Operational data models are designed to support operational systems which usually have specific and relatively stable requirements if the scope is properly defined. These are usually event or transaction systems handling high volumes. A detailed relational model with a lower level of abstraction is desirable for this type of data model.

- **Data Warehouse**

Data warehouses have continually evolving requirements and can therefore be requirements-generalized. Flexibility is the key, and therefore a more highly abstracted, highly normalized, relational data model is desirable.

- **Data Mart**

A data mart is an information resource designed to meet the needs of a set of functional reports and analysis. A dimensional data model is normally used to support these. The dimensions for the mart should come from common data stores (reference or metadata) and the fact data should come from the relational business data or from derivation rules used in the transformation to the data mart.



If there is no relational data warehouse to source the data mart, then some operational data store or staging area is needed. The latter should be modeled and defined as a relational data model.

### 2.3.3 Naming Practices

Below are the practices to be followed for all data naming needs. This includes all data model objects and metadata formats.

1. Generally speaking, there are “business names” and “technical names” for data objects.
  - Business names are used in all conceptual and logical level objects
  - Technical names are used only for physical objects and are generated by algorithm from the corresponding logical object (when there is one).
2. Business names are fully spelled out English names with no delimiters and are Title Case (e.g. “Transaction Effective Date”)
3. Technical names can be of 2 types:
  - Abbreviated names for any technology that does not permit full names of at least 80 characters throughout. Abbreviation standards are further discussed below.
  - Composite English Names with no spaces (e.g. “TransactionEffectiveDate”)
4. Name is always singular.
5. Names are nouns and adjectives and do not (usually) contain possessives, articles, conjunctions, verbs, or prepositions.
  - Do not use organization names, business process names, or project names when naming data objects. These are subject to change and the need for data usually outlives organization and process.
  - Use names that have general business context and meaning and if necessary, use generic business function names for context.
6. The terms to be used for data names are the commonly-used, understood, and simple business names. Every business word that is used should be defined in a business "glossary of terms" and every term must be defined with all business interpretation variations explained. The terms should be considered in view of the entire enterprise and not just that of a single company or department.
7. When business names are used very inconsistently or if there is no common business term to describe what is needed, a new term can be defined. If this is done, a glossary of terms and the data element definition must clearly explain the term.

## 2.3.4 Data Model Definition Practices

This section provides the standards and guidelines for defining data models.

These practices apply to all model types and to all methodologies.

1. Model Template Usage
  - These standards are used to define data model templates in the data modeling tool, and that assists in using the standard practices.
2. Model Naming
  - Models are ideally named for what they are intended to represent and serve, such as business function, and not for the project acronym or name.
  - Models have a complete definition that defines their scope and intent
  - Model Names adhere to all the above standards and also include:
  - Versions of models must be maintained as part of the name – see below
3. Subject Area Definition
  - Subject Areas are usually business subjects that help to keep like objects together.
  - Generally, there should be no more than 15 to 20 entities in a subject area
  - The above being impossible sometimes, there can be one conceptual type model for a subject area and multiple sub-models within the major Subject Areas.
  - It's very important to show how entities outside the Subject Area are related to each Subject Area. This is shown in the Conceptual model and each Logical model subject area should show the connecting entity to adjacent subject areas.
  - There should be no unconnected objects within a subject area.
4. Model Diagram Types and Naming
  - Model Diagrams are what they say – layouts of models. Because conceptual, logical, and physical models use varying “real estate”, it is better to maintain various layouts for these. Also, maintaining a layout for entity definition only versus a fully attributed model layout will provide ease of publication and maintenance. So, common model diagram labels will be:
    - Conceptual
    - Entity
    - Logical
    - Physical
    - Dimensional
5. Conceptual Data Model
  - These should be used to demonstrate the business meaning of the model and the scope, depth, and breadth of the model that provide business capability
  - The technical correctness of the model is less important than the business “story”
  - Embellish these with extra text, color and abstractions.
  - A high level model should fit on one page or panel
  - Despite the high level, full definition is absolutely essential and this should become part of the project deliverables.
  - A good conceptual model speaks to the competence of the developers and inspires confidence of the sponsors and business partners.

- A conceptual model should always be the beginning “data picture” for any information initiative. This is the basis of validating initial concepts and requirements.
6. Logical Data Model
    - The logical model is a detail representation of the data requirements for the scope of the model.
    - All artifacts in the logical data model are fully defined and annotated with examples in the definition
    - See below for practices of defining the subject areas, entities, attributes, domains, and relationships for the logical (and physical) data models.
    - Depending on the application of the model, the logical model may be highly abstracted or not abstracted; it may be requirements-specific or requirements-generalized; it may be highly normalized vs. lightly normalized; it may be subject oriented vs. function oriented.
  7. Dimensional Data Model
    - The Dimensional Data Model is a specialized physical data model to facilitate multi-dimensional analysis (OLAP) in data marts.
    - Like other physical data models, this is a technology-specific representation of the logical data model and is suitable for DBMS and OLAP tool implementation.
    - Although often thought of as a physical-only model, the dimensional data model should also emanate directly from a corresponding logical data model.
    - The underlying logical data model should have, as part of its definition, the derivation rules for the generation of the dimensional schema.
  8. Change Management
    - Prior to the first official release of each type of model, changes are tracked as needed internally by the project team to enable effective coordination
    - After a model has been “released” (shown to anyone outside the development group, or used for any testing, etc.), changes need to be formally tracked.
    - Changes should be described and tracked within the data modeling tool and published to the work group and any other impacted persons and organizations.
    - Changes that are made after production implementation need to be incorporated into the life cycle and change management processes for the enterprise.
    - The exact practices for integrating model development and changes into the life cycle management process will be developed.
  9. Retention of History and Changes
    - A history of data model changes and rationale can be kept in the data modeling tool.
    - Practices for using this capability and integrating this with life cycle management need to be developed.

## 2.3.5 Data Model Object Definition Practices

This section provides the norms for defining each of the data model objects. For each of the defined objects, a full business-oriented definition is needed and is defined in the data model. For major business terms, a reference to a Glossary should be included.

### 1. Entity Definition

- An Entity represents a person, organization, place, thing, or concept of interest to the enterprise
- An Entity can represent a very broad and varied set of instance data, or it can be very specific (e.g. Party vs. Vendor, Associate, Contact, Customer, etc, etc). This is referred to as levels of abstraction.

### 2. Subtype Definition

- Subtypes are very useful for showing the types of data that are represented in a more generic entity. For example, in the party model, there could be subtypes to show the types of parties that are encompassed and the data that may be unique to each type of party.
- Subtypes can also show the business rules about which of the subtypes are mutually exclusive vs. overlapping. For example, an employee may also be a customer, but a vendor and an employee may be mutually exclusive.
- Subtypes may be used in the logical model for the above purpose but not implemented in the physical model.

### 3. Attribute Definition

- Attributes are usually defined within an entity by first naming the logical business keys and identifying them as such. These become the primary key for the entity.
- Attributes can be named generically within the context of an entity, that is, the Entity Name need not be added to the Attribute Name, with the possible exception of the primary key. For example, consider the following:

Contact	Associate
Contact ID	Associate ID
Name	Name
Routing Description	Routing Description
Phone Number	Position ID
E-Mail Address	Office Phone Number
	Mobile Phone Number
	E-Mail Address

- The Attributes above the line are Primary Key attributes (see below). The other attributes are non-identifying attributes. Name, Routing Description, and E-Mail Address are common to both of them. It is clear that Name in Contact is the Contact Name and Name in Associate is the Associate Name and it is not necessary to further qualify it.

#### 4. Data Element Definition

- A data element is a fact of importance to the business, regardless of where it resides or what it is describing. For example, Country Code is a data element that can be defined outside of the context of any entity. It can and should have a common and standard set of values that are used by the enterprise. When Country Code is used as an attribute of a specific company's location, there would be a small subset of Country values allowed for this purpose. So there can be common reference entities for data elements and subsets of these for attributes.
- So, an attribute is a description of something and is using a data element in the context of some entity.
- Data elements often surface in data models as "Code" or "Reference" lists or tables, where all the valid values, or "domains" are specified and described. These may also be managed as "master data"

#### 5. Domain Definition

- As stated above in Definitions, a domain is a theoretical or actual set of all possible values for an attribute or data element. The domain may be a set of common code values, a theoretical set of all possible valid Gregorian dates, a First Name that is standardized at 40 characters regardless of where it is used.
- Domains provide consistency of properties for data elements and attributes that have the same logical "domain" of values.
- Every attribute in a data model is connected to a domain that provides for consistent names, data types, lengths, value sets, and validity rules.
- A domain can be thought of at the data element level as a means of conforming all the attribute implementations of that data element.

#### 6. Class Words for Attributes, Data Elements, Domains

- All attribute and data element (see below) names end in a standard "class word" that identifies the kind of attribute being defined. Below is a table showing all the class words to be used, with an addendum showing other candidate class words and the rationale not to be used.
- Class Word Abbreviations are also provided. They are used when migrating logical data model items to physical form. Physical Data models are implemented using Data Base Management System technologies that may limit the number of characters for names and may not permit full names of at least 80 characters throughout. Class word abbreviations ensure naming consistency in physical models.
- The rationale for this is not only consistency, but the flexibility of providing for families of data names (such as Client Name, Client Address, Client Race Code, Client Birth Date, etc.) and the understanding it facilitates (as to what to expect to find in this data element).
- In the table below, the **commonly used business class words are in bold blue**, and the less used and technical class words are in black.

#### Standard Class Words

Class Word	Class Word Abbreviation	Definition
<b>Count</b>	CT	Use for an enumeration of items and in lieu of "Number of". Is the number of objects or occurrences.
<b>Date</b>	DT	Full Year, Month, and Day content

DateTime	DTM	Full specification of date and time to the maximum precision (at least nanosecond) allowed in the DBMS being used. Do not use for business data - use when system-assigned time sequence is needed.
<b>Description</b>	DSC	All descriptive free-form text.
Factor	FCTR	A multiplier based on unity (1) used to index a base number.
Flag	FLG	A technical implementation of an indicator that may be used for efficiency. Values are 0 or 1 only where 0 = No or Off and 1 = Yes or On.
<b>Identifier</b>	ID	A sole unique Identity for an object or entity that is independent of every other object. (can stand on its own to identify an object).
<b>Indicator</b>	IND	Use only for data that can be defined as Yes, No, or Not Applicable (null), Name must specify the meaning of the yes and no.
<b>Name</b>	NM	Use for labels of objects - usually a short, "displayable" recognition assist.
		See description for longer text items.
<b>Number</b>	NO	Identifying a relative item that is unique only within another major category, usually an ID; or to state a number that is not a count or quantity, for example Age Number
<b>Percent</b>	PCT	A ratio of two base numbers expressed as a percentage. Use term Percent, not Percentage, for the business name.
<b>Quantity</b>	QTY	Storing various measures of quantities from very small to very large and with varying degrees of precision, for example, Dispensed Quantity
Rate	RT	A multiplier per specified unit, such as Service Unit Daily Rate
Series	SRS	Use for a repeating group of the same data element. For example, Contact Preference Series consists of repeating locality types, such as Home, Office, Roam, Secondary Residence.
Set	SET	Use for a group name of a structured set of data or decomposable taxonomy. For example, SIC (Standard Industry Classification) Set where first two positions are Industry Group and last two are Specific Industry.
Time	TM	Specifying the hour, minute, and second
Value	VLU	Used when cell content can be anything, (for example, in a metadata store, defining "Cell Value"). If used, there needs to be an interpretive attribute to describe the actual data type.

**Class Words For Future Use**

Potential Class Word Name	Class Word Abbreviation	Data Type	Used For
Image	IMG	Blob, Picture, etc.	Use for picture
Sound	ADO	Sound Wave	Use for sound object
Video	VDO	Video	Moving pictures and sound
Multi-Media	MM	Multi-Media Object	Combined sound and graphics not limited to the above

**Class Words Not To Be Used and Rationale**

Potential Class Word	Use Instead	Rationale
Average	Appropriate class word for average.	Use " Average Amount", "Average Count", "Average Quantity", etc.
Group	Set	The term group is used extensively in the healthcare industry for Employer Groups, Provider Groups, etc. Use of the term Set will help to maintain distinctions.
Length	Count	Use "Length Count" with specific metric specified as qualifier.
Status	Code	Use "Status Code". Avoid overuse of status codes.
Title	Name	Use "Title Name" for the title portion of a name.
Type	Code	Use "Type Code" or Type ID
Text	Description or Name	Not used - used description instead. This is a data type, not a class word.
Dimension		
Volume		

## 7. Relationship Definition

- Relationships are the **verb or verb phrase** that link two entities together.
- This is used to form a sentence between the entity that is the “**one**” side of the relationship and entity that is the “**many**” side of the relationship; e.g. An **account groups** zero, one, or many **policies**
- Every relationship in the model must have a defined relationship.
- Relationships can be defined in both directions, but only the one to many is recommended.
- A subtype automatically has a relationship of “is a” (e.g. Party **is a** Person)

## 2.3.6 Standard Abbreviations

1. Abbreviations are used only for physical and dimensional data models (*later, some abbreviation norms for display may provide for abbreviations*)
2. Each word is abbreviated by using the initial standard list. This is in a standard naming naming file
3. All technical names are derived automatically from the standard naming file.
4. The general rules for forming abbreviations for single words are:
  - First letter of abbreviation is first letter of word (consonant or vowel)
  - Subsequent letters of abbreviation are the consonants of the word
  - Only one of a double consonant is used (e.g. middle="mdl")
  - A maximum of 5 characters are used to abbreviate a single word
  - The last letter of the abbreviation can be a vowel is that is prominent in the pronunciation of the word (e.g. value = "vlu")
  - The resulting abbreviation must be unique to one base word
  - Word endings for tense, verb forms, plural (etc.) do not yield separate abbreviations (e.g. Service, Servicing, and Serviced are all abbreviated as "SRVC").
5. The general rules for forming abbreviations for object names are:
  - Abbreviation is all upper case
  - The word abbreviation components are separated by an underscore or hyphen as the technology in use requires (e.g. ITM\_UNT\_PRC)
  - The total length of an abbreviated name may be limited by the technology being used. Use the most restrictive length of all technologies used by an application to determine the maximum length of an abbreviated data name or standardize at a max of 25
  - For data elements (and some other construct names), the last word is always a "Class Word" and that is never dropped from the abbreviated name. See above table of class words.
  - When length problems occur, proceed to the compound word abbreviation suggestions to shorten the overall abbreviation.
  - When length problems occur, consider whether a word can be omitted from the abbreviation without losing much meaning or uniqueness.
  - Never allow a technical tool to truncate an abbreviated name that is too long. - use the alternate suggestions instead to comprise an abbreviation that has integrity.
6. Exceptions to the above are as follows;



- If a common usage abbreviation exists, use it (e.g., Organization = "ORG", Management = "MGT", etc.)
- **HOWEVER:**
  - Don't overdue the overrides to the rules as it will make it more difficult for people to use the standard abbreviation names
  - Resist the temptation to assume that everyone abbreviates some terms the same way. For example, LOC may seem obvious for Location until you learn that this is Level of Care for in some business world. Go with the common standard and as people adapt to it, the real names will be more intuitive.
- If the word is very short and the abbreviation could be confusing, use a vowel to distinguish based on the pronunciation of the word (e.g. Role = "rol", Rule = "rul" versus both would be "rl"; also Date = "dt" because of common use, while Data is "dat")
- Multiple Words and Phrases:
  - If a common discipline or business acronym applies, use it (e.g. Return on Investment = "ROI")
  - If there are common business phrases or acronyms, then use the acronym or one abbreviation for the compound term or phrase (e.g. Employer Identification Number = "EIN"; Dun & Bradstreet Number = "DUNS").
- As noted in the Business Data Naming, organization names and specific system or process names should not be used in data names.
- The components of the abbreviated name follow the standards for business naming, and therefore progress from general to specific. Data elements end with a "class word" and so the abbreviations will follow that pattern.

## 2.3.7 How to Read a Logical Data Model

### Data Model Basics: Entities, Attributes and Relationships

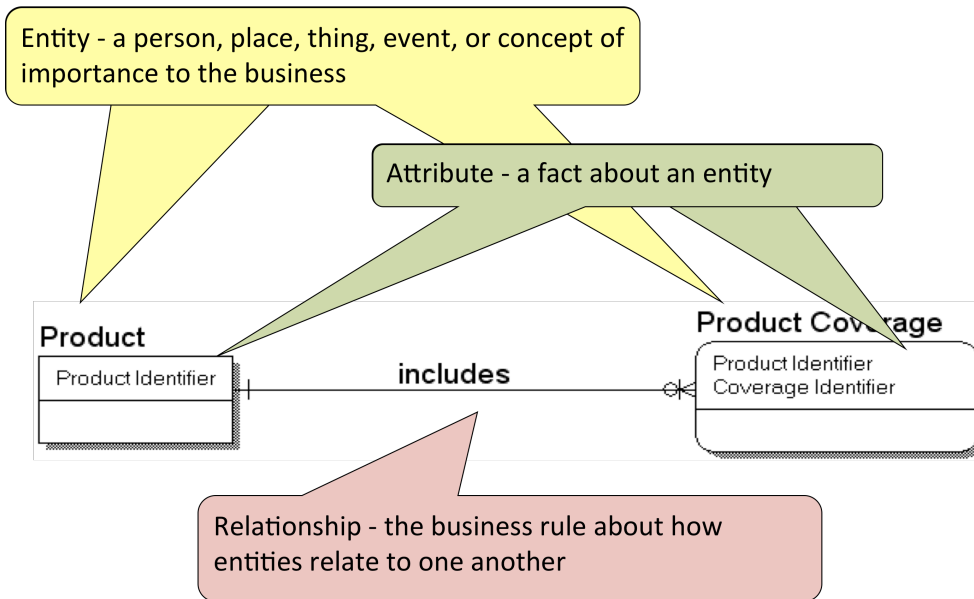

# Entity Definition

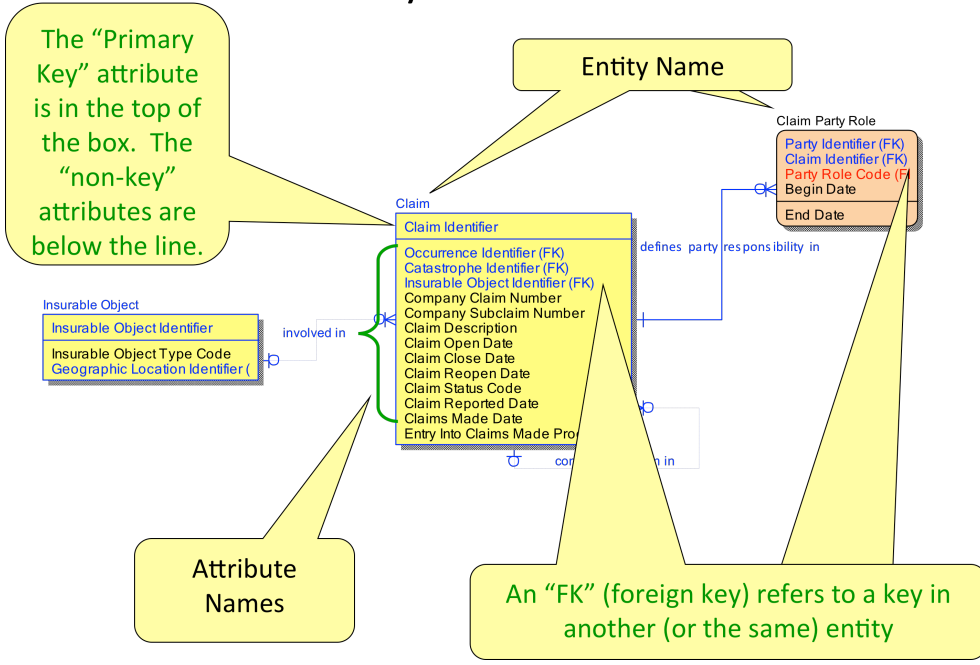

# Relationships

## Notation and Cardinality

IE – Information Engineering Modeling Notation  
uses “crows feet” to show relationship cardinality

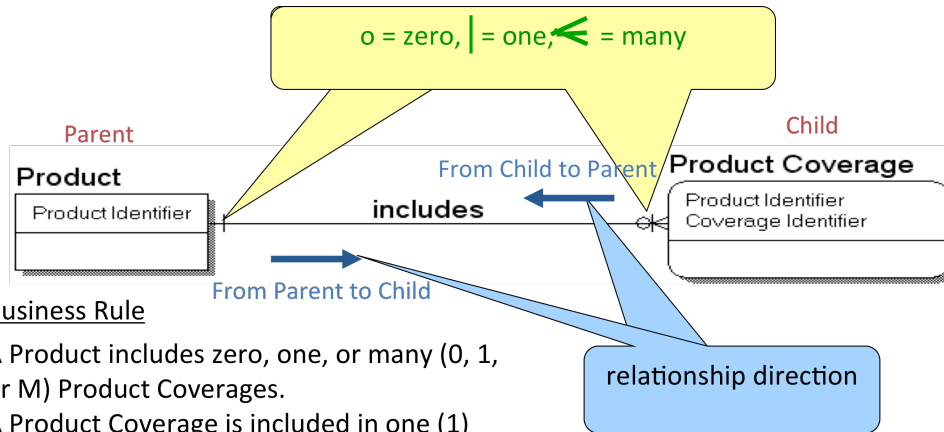

### Business Rule

A Product includes zero, one, or many (0, 1, or M) Product Coverages.

A Product Coverage is included in one (1) Product.

Only Display Parent to Child Relationship to avoid diagram clutter.

# Associative Entities

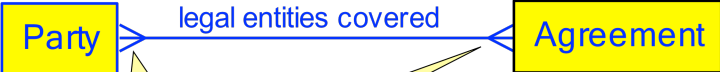

Conceptual Data Models often contain "Many to Many" Relationships. In this example many Parties have legal entities covered in many Agreements, but one cannot determine which Parties are associated with which Agreements.

In the Logical Data Model, an "Associative Entity" (Agreement Party Role) is created to resolve the Many to Many Relationship. In this case, the Associative Entity defines not only which Parties are associated with which Agreements, but also the Role that each Party plays in the Agreement.

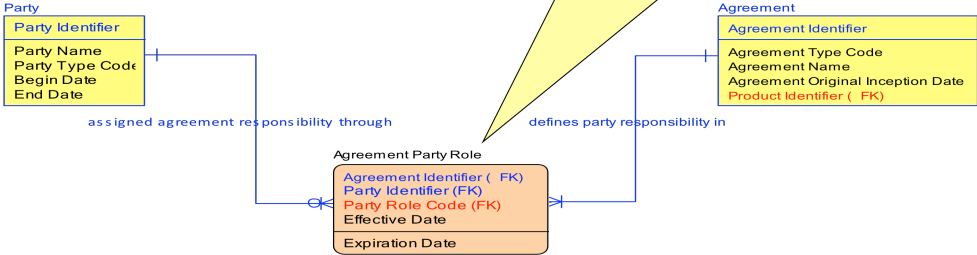

## Mandatory and Optional Relationships

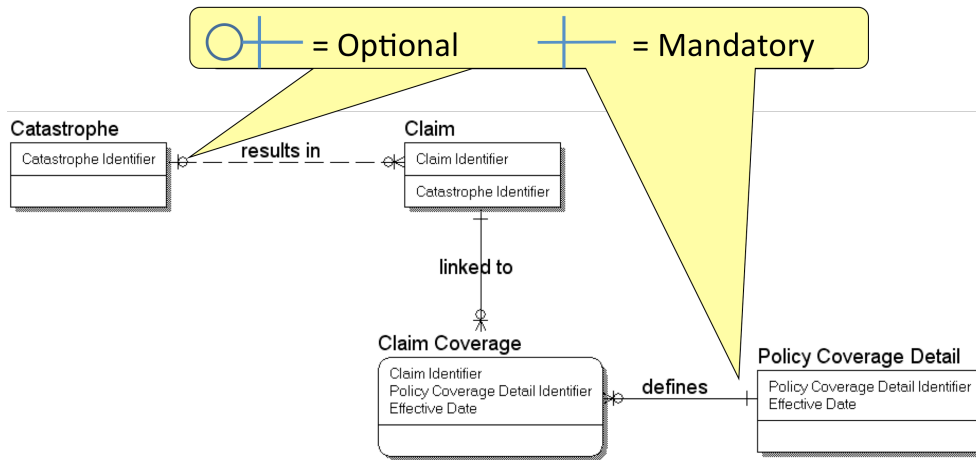

An Optional Relationship could possibly happen but it may not. A Catastrophe could result in a claim, but not always.  
A Mandatory Relationship must occur. Policy Coverage Detail always defines Claim Coverage.

# Identifying and Non-Identifying Relationships

A dotted or dashed line represents a “Non-Identifying Relationship” in which the Primary Key in the Parent Entity becomes a regular Foreign Key Attribute in the Child Entity and is not part of the Primary Key.

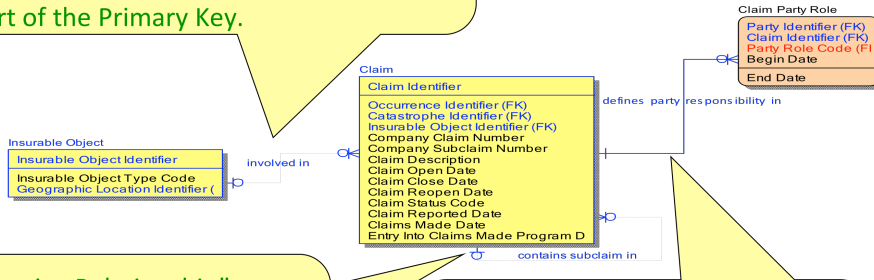

A “Recursive Relationship” represents a hierarchical relationship within an Entity. In this example, there is a sub-claim within a claim.

A solid line represents an “Identifying Relationship” in which the Primary Key in the Parent Entity becomes part of the Primary Key in the Child Entity.

# Independent and Dependent Entities

A box with sharp corners indicates an Independent Entity, that can stand alone on its own.

A box with rounded corners indicates a Dependent Entity that can exist only because of its relationship with another Parent Entity. It cannot stand alone.

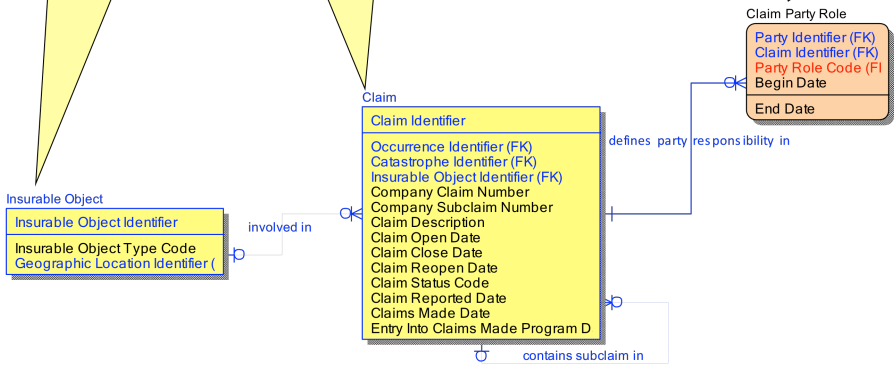



## Inclusive Subtype Relationships (1:0-1)

Business Rule: An Account Role can be a Prospect and/or a Customer

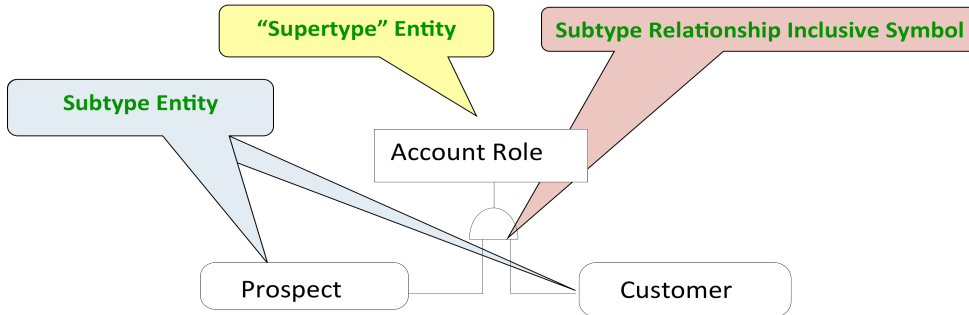

*An Account Role is a 0-1 Prospect*

*An Account Role is a 0-1 Customer*

An open half circle shows an "inclusive relationship".

An Account Role can be a Prospect and/or a Customer.

Note: Conceptual Models display the name of the Entity within the entity box and do not show attributes. This example is based on a Conceptual Model. A Logical Model displays the Entity name on outside and on top of the box, and includes attributes.

## Exclusive Subtype Relationship 1:0-1)

Business Rule: A Party can be a Person or an Organization.

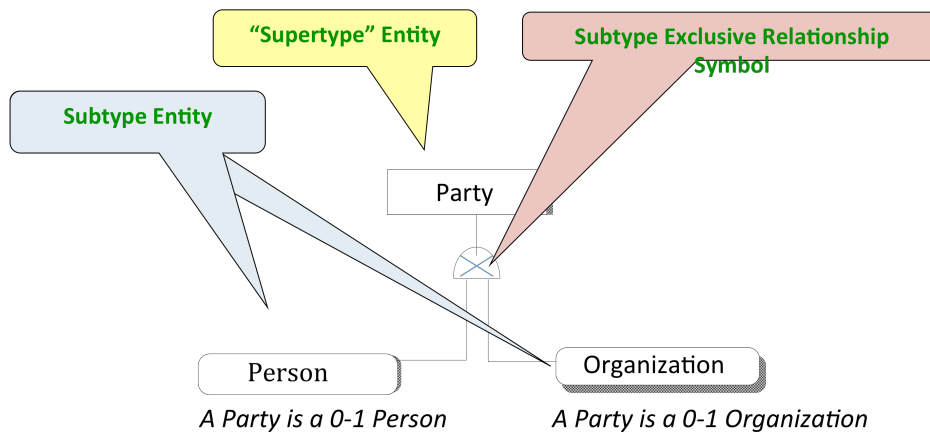

A half circle with an X within shows an "exclusive relationship".  
A Party can be either a Person or an Organization, but cannot be both.

Note: Conceptual Models display the name of the Entity within the entity box and do not show attributes. This example is based on a Conceptual Model. A Logical Model displays the Entity name on outside and on top of the box, and includes attributes.

## 2.3.8 Normative References

The following normative documents contain provisions which, through reference in this text, constitute provisions of this specification. For dated references, subsequent amendments to, or revisions of, any of these publications do not apply.

- Conceptual Data Model
- Logical Data Models:
  - OMG Party Subject Area Model
  - OMG Account and Agreement Subject Area Model
  - OMG Policy Subject Area Model
  - OMG Claim Subject Area Model
  - OMG Assessment Subject Area Model
  - OMG Agreement Role Subject Area Model
  - OMG Claim Party Role Subject Area Model
  - OMG Staffing Party Role Subject Area Model
  - OMG Party Subtype Subject Area Model
  - OMG Insurable Object Subtype Subject Area Model
  - OMG Money Subtype Subject Area Model
  - OMG Event Subtype Subject Area Model
  - OMG Product Coverage Reference Subject Area Model

- 1 Generation of XMI-CWM (Common Warehouse Metamodel) for interoperability - **submitted as an Annex Document Attachment**

## 2.3.9 Terms and Definitions

As part of this submission a Glossary of Data Model Terms and Definitions generated from the Data Model has been provided in section 3.2. This section provides definitions for the following:

- 2 Subject Areas
- 3 Entities
- 4 Attributes
- 5 Relationships
- 6 Domains

Section 3.3 contains cross reference information identifying where in the model the term is used. This section provides a listing of:

- Subject Area Entities
- Entity Attributes

A Reference Glossary of Common Insurance Business Terms and Definitions has been provided in section 3.4

Thomas Ford 2/20/13 10:27 PM

**Formatted:** Bulleted + Level: 1 + Aligned at: 0.25" + Indent at: 0.5"

Thomas Ford 2/20/13 10:27 PM

**Formatted:** Bulleted + Level: 1 + Aligned at: 0.25" + Indent at: 0.5"

Thomas Ford 2/20/13 10:27 PM

**Formatted:** Bulleted + Level: 1 + Aligned at: 0" + Indent at: 0.25"

Thomas Ford 2/20/13 10:27 PM

**Formatted:** Outline numbered + Level: 1 + Numbering Style: 1, 2, 3, ... + Start at: 1 + Alignment: Left + Aligned at: 0" + Indent at: 0.41"

Thomas Ford 2/20/13 10:27 PM

**Formatted:** Outline numbered + Level: 1 + Numbering Style: 1, 2, 3, ... + Start at: 1 + Alignment: Left + Aligned at: 0" + Indent at: 0.41"

Thomas Ford 2/20/13 10:27 PM

**Formatted:** Bulleted + Level: 1 + Aligned at: 0.75" + Indent at: 1"



# Part Three

## 3.1 Specification

These deliverables represent thirteen (13) logical data models for the major lines of Property and Casualty business in the United States geographic territory, leading off with a conceptual data model to serve as a reference or core model representing common data entities transcending all or most P&C insurance business processes (e.g., party, claim, geographic location, insurable object, etc.).

### 3.1.1 Conceptual Data Model

As stated above in the standards section, a conceptual data model is a high-level data model that identifies major entities and relationships of importance to the business. It does not resolve “many-to-many relationships, may not contain any attributes, and may not be “normalized”. It is like a roadmap to more detailed logical models and enables all users of detail models to quickly grasp the scope, terminology and concepts used in the model.

The Property and Casualty Conceptual Data Model below is an example of the above norms. It presents the major objects (entities) and their relationships and represents the major concepts of the business and of the succeeding Logical Data Model.

The Legend in the model diagram demonstrates the use of color to highlight the major entities and concepts.

The major features of the Conceptual Data Model are:

- Party is a major entity that relates to almost all the other major entities as it defines how people, organizations, and groups are involved in the insurance and financial services business involving agreements, policies, claims, insurable objects, etc. With the use of party, many other data requirements can be made common and managed more efficiently.
  - The Communication entity permits all contact information and preferences to be established for all types of parties
  - Geographic Locations can be defined and connected to Party and to other entities.
  - “Insurable Objects” can be defined with respect to their interested parties and referenced by multiple agreements
- Agreement is a focal point for the data model because it is a “Supertype” for all insurance, financial, and service contracts. Examples of agreements for this initial data model are Policy and Reinsurance Agreement.
- Policy is the major feature for this release of the data model as all the remaining major objects are related to it.
  - Policy Coverage Detail is a key link among Policy, Claim, and Reinsurance
  - Claim is tied to Policy though Policy Coverage Detail
  - Policy ties to Coverage and Product
- Claim is tied to Party, Insurable Object, Policy Coverage Detail, and Reinsurance.
- Money is a common entity at the conceptual level to emphasis the importance of common management of financial amounts. In the Logical Data Model, Money s defined in Policy Amount and Claim Amount entities.
- Product, Coverage, and Location Address are examples of the “master” reference data that can improve the integrity of data and which companies can populate with their data.

- Finally, the model is bound together with time management, traceability, and metadata using common constructs for Event and Activity and additional Reference and Master data.

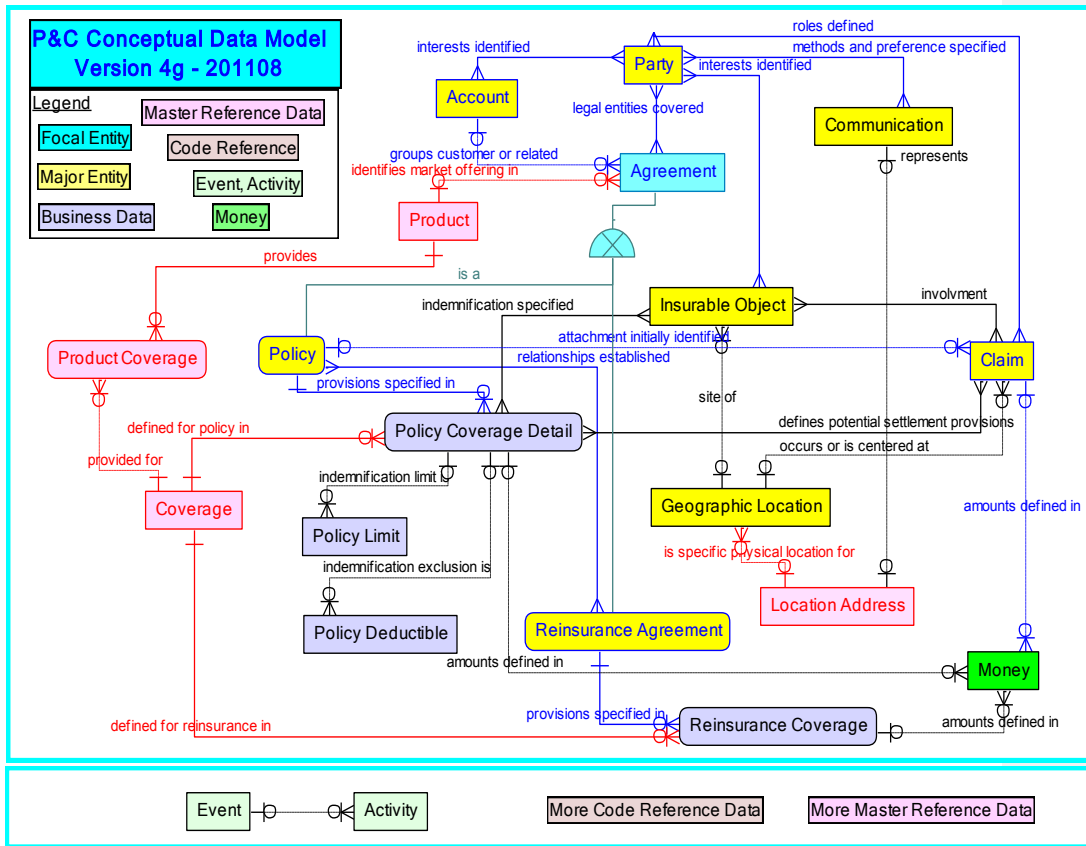

### 3.1.2 Party Subject Area Model

The Party Subject Area shows that all persons, organizations, and groups can be represented as "parties" and parties can then be related to other major objects with specified roles. The Party design also provides for a common approach to describing communication identifiers, relationships between parties, and legal identifiers. Examples of the use of the party types is also shown.

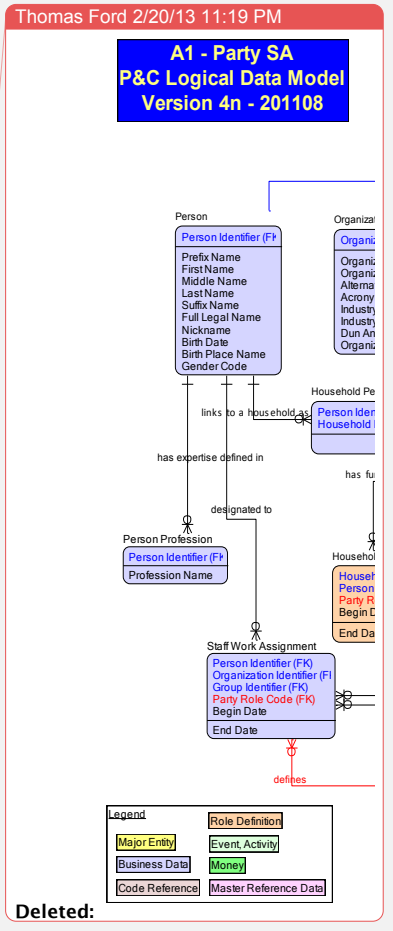
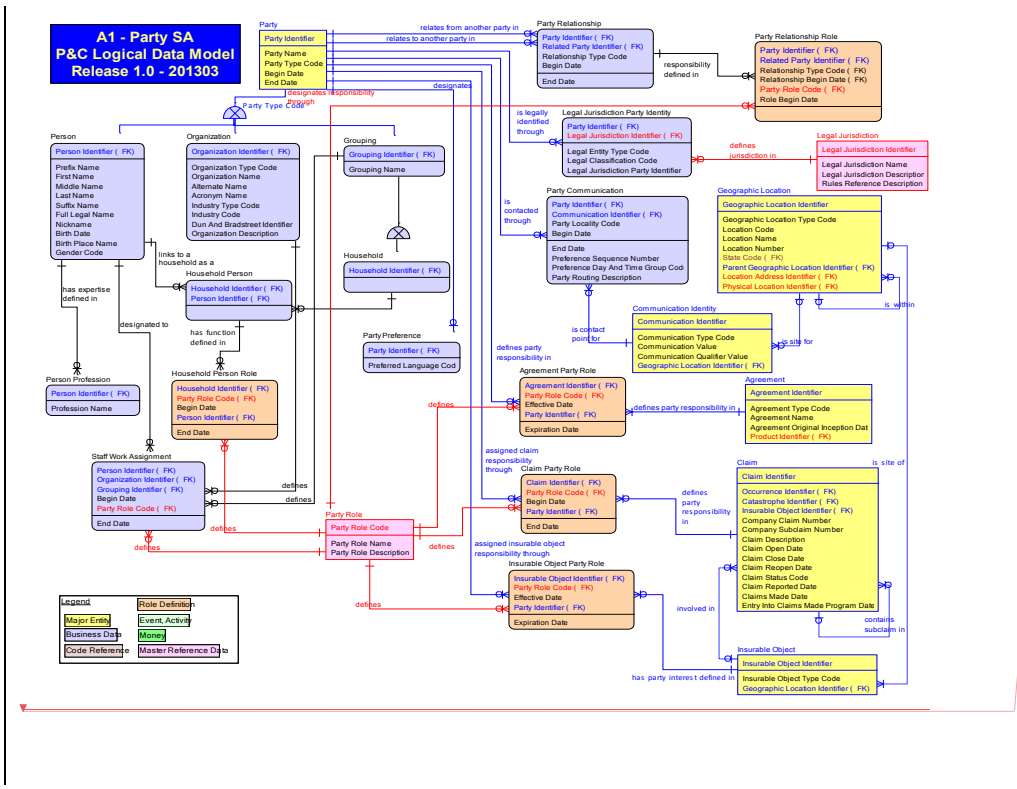



### 3.1.3 Account and Agreement Subject Area Model

The Account and Agreement Subject Area presents the common framework for establishing customer-oriented accounts and company-oriented financial services agreements. Party Role is used to relate all parties to account and agreement, and various agreement types are identified. Refer to the Agreement Role Subject Area for examples of the roles involved with agreements.

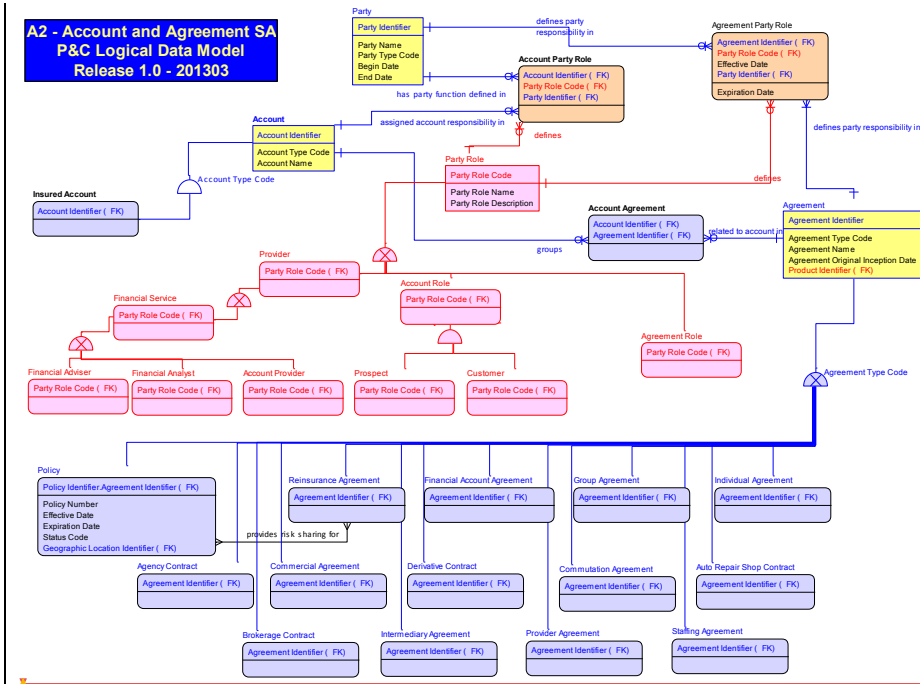

Thomas Ford 2/20/13 11:30 PM

**A2 - Account and Agreement SA P&C Logical Data Model Version 4.0 - 201108**

**Legend**

Major Entity	Role Definition
Business Data	Event Activity
Code Reference	Master Reference Data

Account Type

Insured Account  
Account Identifier (FK)

Financial Service  
Party Role Code (FK)

Financial Adviser  
Party Role Code (FK)

Financial Analyst  
Party Role Code (FK)

Policy  
Policy Identifier (FK)  
Policy Number  
Effective Date  
Expiration Date  
Status Code  
Geographic Location Identifier (FK)

Agency Contract  
Agreement Identifier (FK)

Account Role  
Party Role Code (FK)

Account Agreement  
Account Identifier (FK)  
Agreement Identifier (FK)

Agreement  
Agreement Identifier  
Agreement Type Code  
Agreement Name  
Agreement Original Inception Date  
Product Identifier (FK)

Agreement Party Role  
Agreement Identifier (FK)  
Party Role Code (FK)  
Effective Date  
Party Identifier (FK)  
Expiration Date

Agreement Role  
Party Role Code (FK)

Reinsurance Agreement  
Agreement Identifier (FK)

Financial Account Agreement  
Agreement Identifier (FK)

Group Agreement  
Agreement Identifier (FK)

Individual Agreement  
Agreement Identifier (FK)

Agency Contract  
Agreement Identifier (FK)

Commercial Agreement  
Agreement Identifier (FK)

Derivative Contract  
Agreement Identifier (FK)

Commutation Agreement  
Agreement Identifier (FK)

Auto Repair Shop Contract  
Agreement Identifier (FK)

Brokerage Contract  
Agreement Identifier (FK)

Intermediary Agreement  
Agreement Identifier (FK)

Provider Agreement  
Agreement Identifier (FK)

Stalling Agreement  
Agreement Identifier (FK)

**Deleted:**  
Unknown  
**Formatted:** Font:(Default)  
Times-New-Roman, 10 pt

### 3.1.4 Policy Subject Area Model

The Policy Subject Area defines the common features of an insurance policy and shows how they are related to parties and agreement. Common constructs for Geographic Location and Insurable Objects allow for these to be shared above the level of a Policy. A common entity for policy monies allows for all types of amounts to be defined at all policy levels.

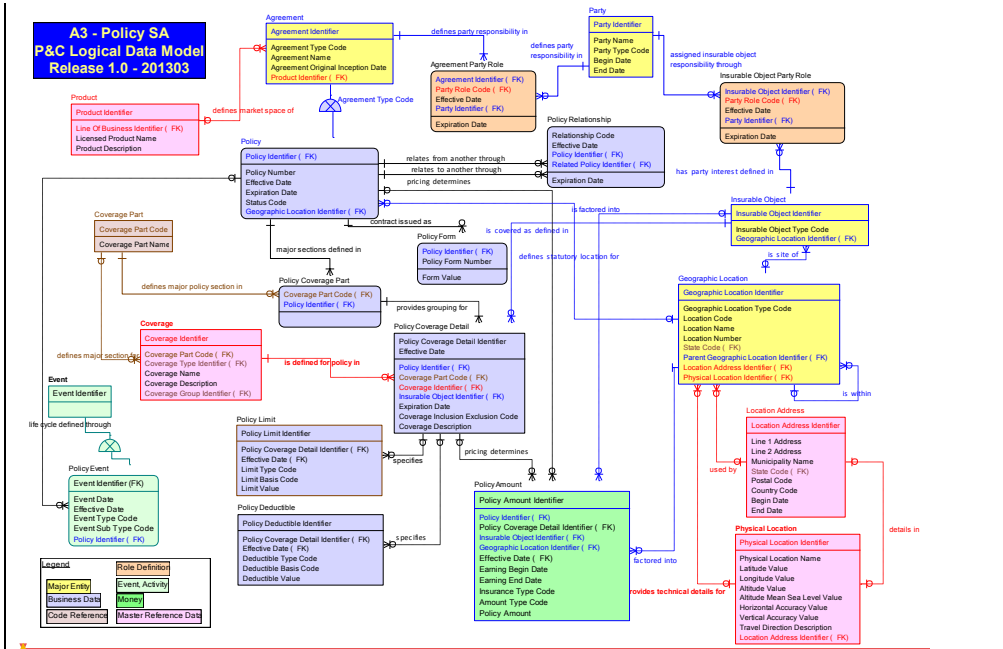

Thomas Ford 2/20/13 11:33 PM

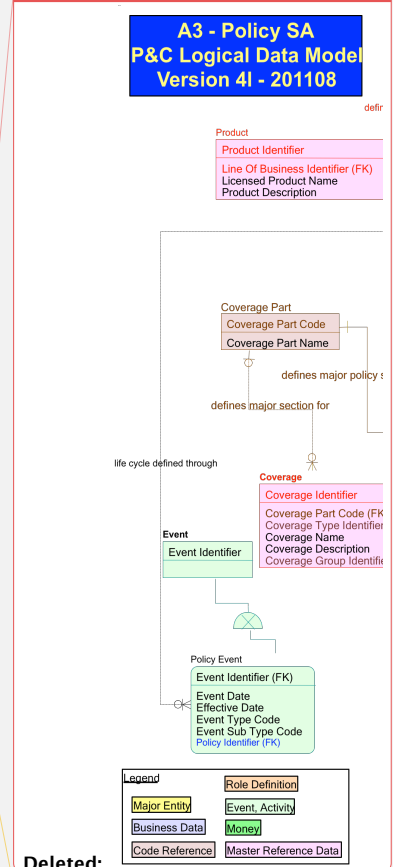

**Deleted:**  
 Unknown  
 Formatted: Font:(Default)  
 Times-New-Roman, 10 pt

### 3.1.5 Claim Subject Area Model

The Claim Subject Area defines the major entities involved in claims management, beginning with an occurrence resulting in claims and sub-claims, and the option of arbitration and litigation being involved in claim settlement. As with all areas of the model, the relationships and roles of parties is defined for the major entities. The relationship of claim to coverage is shown, and a common entity for all claims monies is defined. Refer to the Claim Role Subject Area for examples of the roles involved with claims.

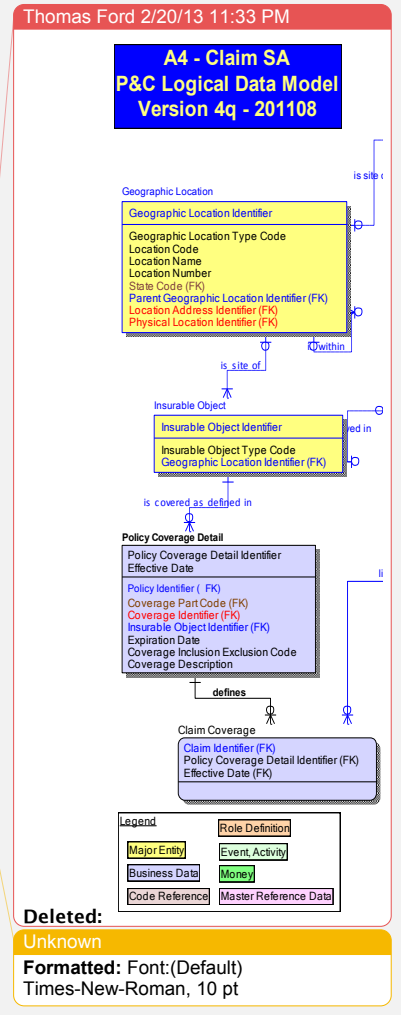
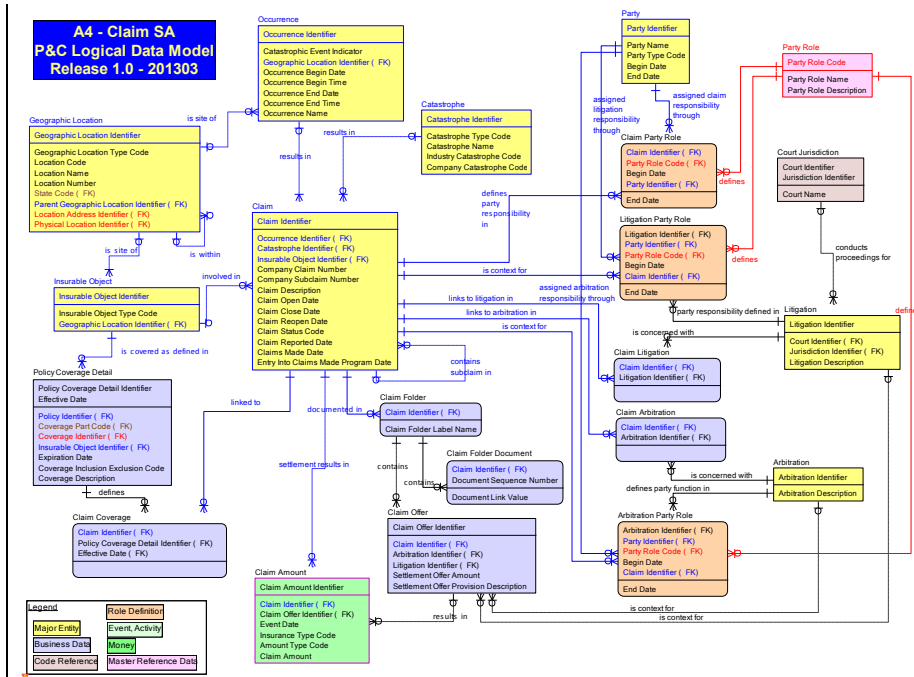

### 3.1.6 Assessment Subject Area Model

The Assessment Subject Area shows the types of assessments that apply to the insurance and financial business. These provide for oversight, risk assessment, financial information and valuation of assets. Assessments are related to other major entities such as agreement, insurable object and claim, with party roles for assessment being defined in the common metaphor.

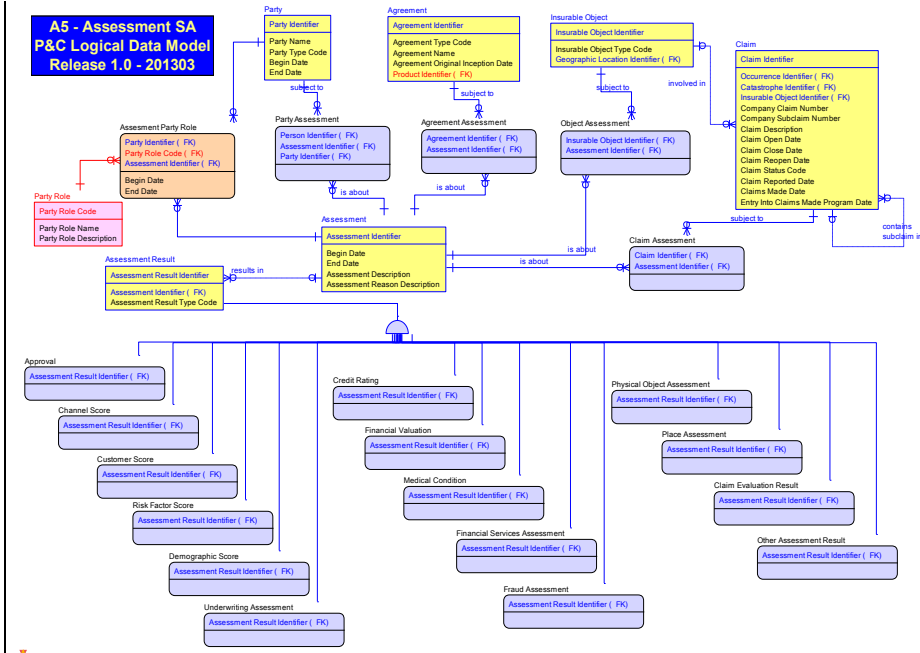

Thomas Ford 2/20/13 11:36 PM

**A5 - Assessment SA P&C Logical Data Model Version 4m - 201108**

This diagram shows a subset of the entities and relationships from the first diagram, focusing on Assessment Party Role, Party Role, and Assessment Result. It includes the following entities and their attributes:

- Assessment Party Role:** Party Identifier (FK), Assessment Identifier (FK), Party Role Code (FK), Begin Date, End Date.
- Party Role:** Party Role Code (PK), Party Role Name, Party Role Description.
- Assessment Result:** Assessment Result Identifier (FK), Assessment Identifier (FK), Assessment Result Type Code.

Key relationships include:
 

- Party Role *defines* Assessment Party Role
- Assessment Party Role *party function defined in* Assessment

The diagram also shows a hierarchy of Assessment Result types:
 

- Authorization
- Channel Score
- Customer Score
- Risk Factor Score
- Demographic S
- Under
- Asse

**Deleted:**  
Unknown  
**Formatted:** Font:(Default)  
Times-New-Roman, 10 pt

### 3.1.7 Agreement Role Subject Area Model

The Agreement Role Subject Area shows examples of the roles that can be involved in agreements. While these roles would become Role Codes in an implementation, it is usable to display them for understanding.

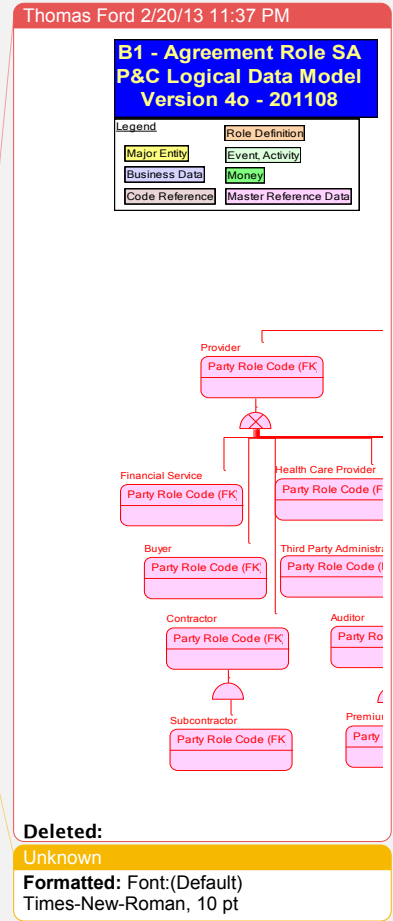
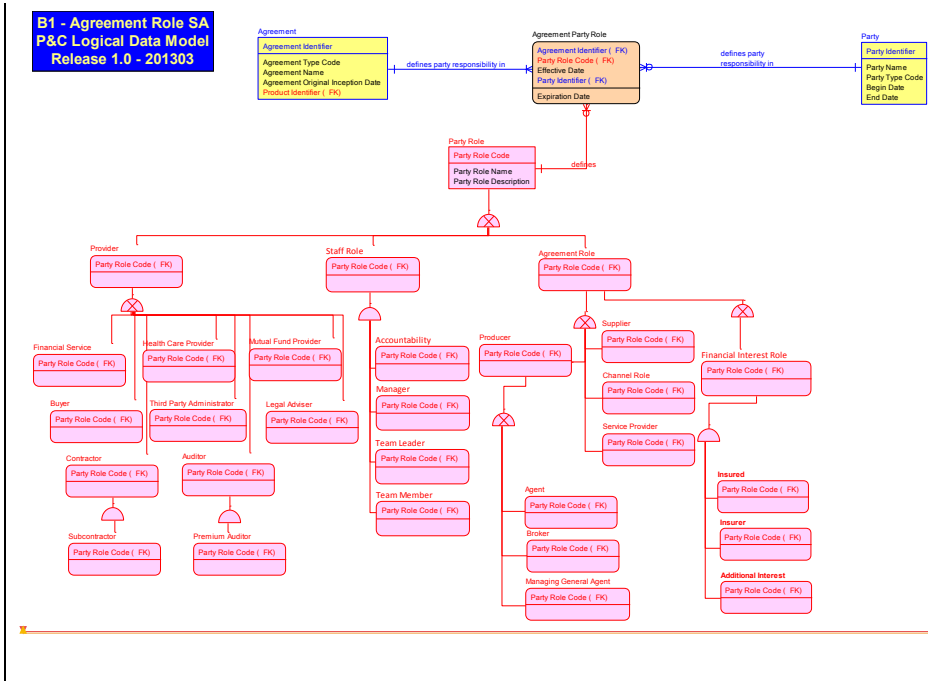

**Deleted:**  
 Unknown  
 Formatted: Font:(Default)  
 Times-New-Roman, 10 pt

### 3.1.8 Claim Role Subject Area Model

The Claim Party Role Subject Area shows examples of the roles that can be involved in claims. While these roles would become Role Codes in an implementation, it is usable to display them for understanding.

Thomas Ford 2/20/13 11:40 PM  
Deleted: Party

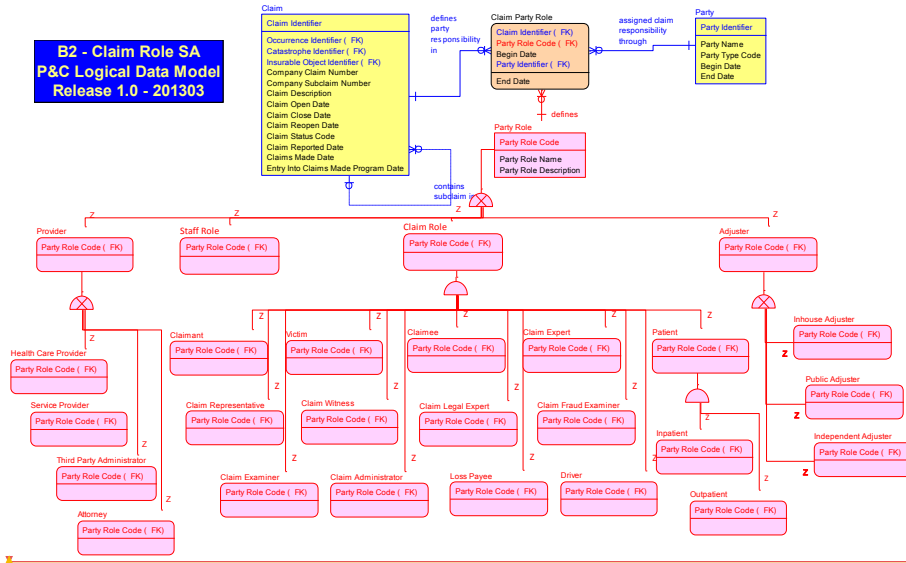

Thomas Ford 2/20/13 11:40 PM

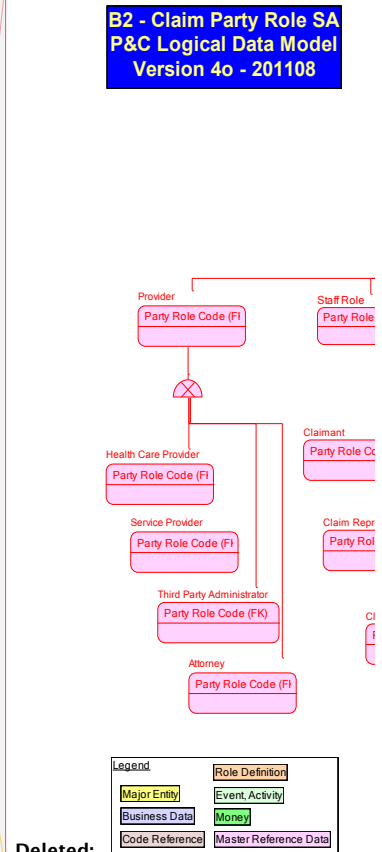

Deleted: Unknown  
Formatted: Font:(Default)  
Times-New-Roman, 10 pt

### 3.1.9 Staffing Role Subject Area Model

The Staffing Role Subject Area shows examples of the roles that can be involved in staffing. While these roles would become Role Codes in an implementation, it is usable to display them for understanding. This subject area also shows the entities of interest with respect to the classification and assignment of staff, which supports the operational aspects of insurance and financial services.

Thomas Ford 2/20/13 11:41 PM  
Deleted: Party

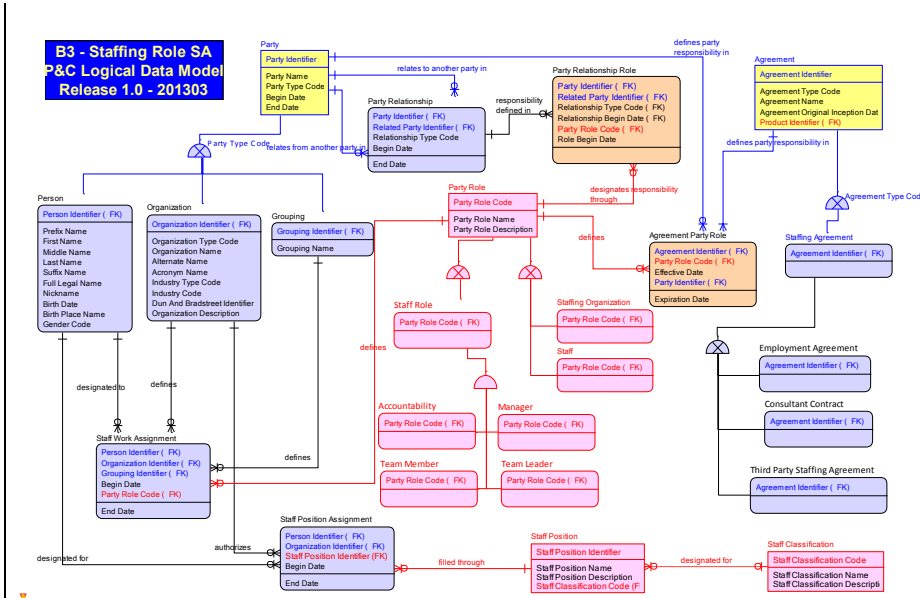

Thomas Ford 2/20/13 11:41 PM  
**B3 - Staffing Party Role SA P&C Logical Data Model Version 4n - 201108**

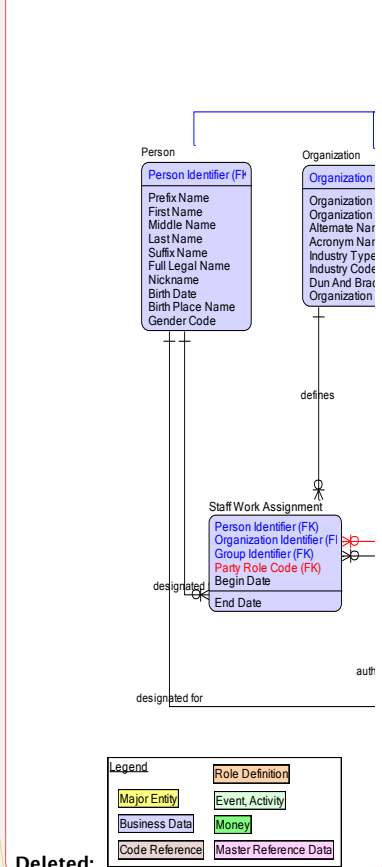

Deleted:  
Unknown  
Formatted: Font:(Default)  
Times-New-Roman, 10 pt

Legend	
Major Entity	Role Definition
Business Data	Event, Activity
Code Reference	Money
	Master Reference Data

### 3.1.10 Party Subtype Subject Area Model

The Party Subtype Subject Area shows examples of the classifications of organization and group. It also provides examples of the use of organization and the optional ways of defining organization hierarchies. The use of party relationship is demonstrated as a common way of managing party person, organization, and group relationships.

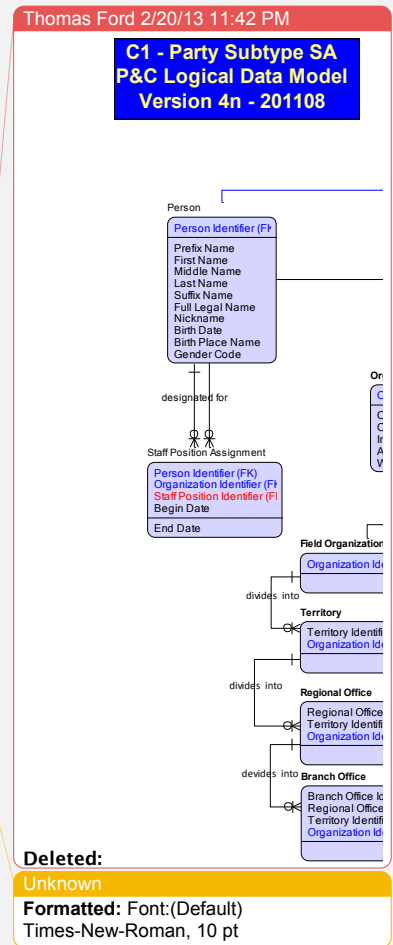
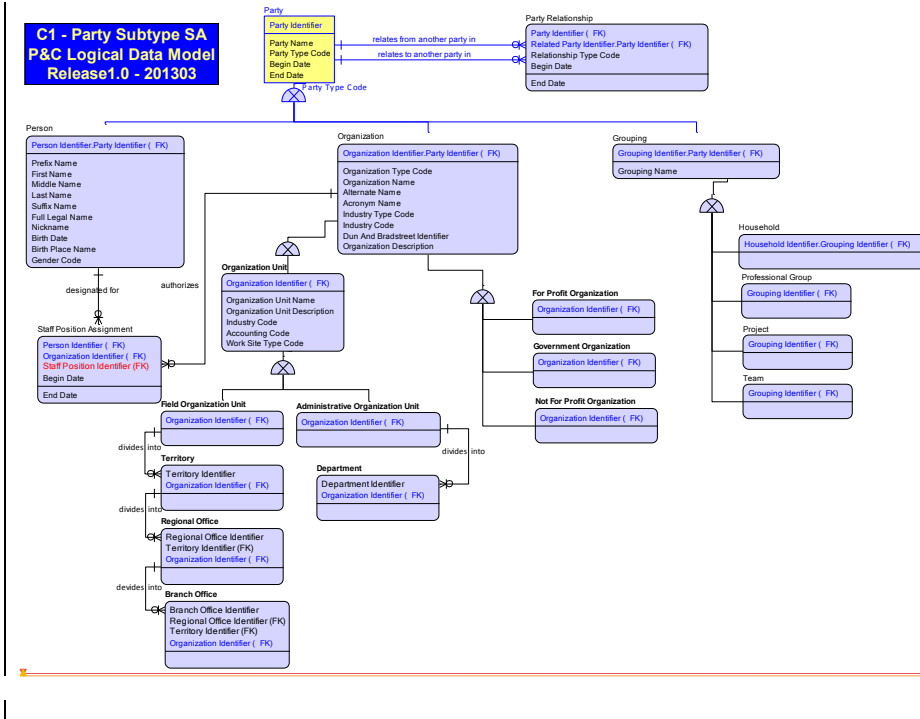

**Deleted:**  
Unknown  
Formatted: Font:(Default)  
Times-New-Roman, 10 pt



### 3.1.11 Insurable Object Subtype Subject Area Model

The Insurable Object Subtype Subject Area shows examples of the varied objects that can be involved in insurance. Some subtypes require further specialized information and may involve implementation of the subtypes, whereas some objects can be commonly described at the object level.

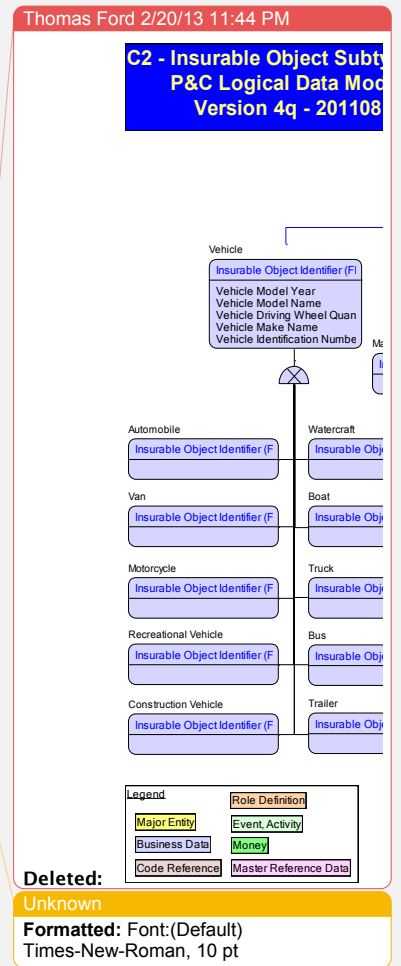
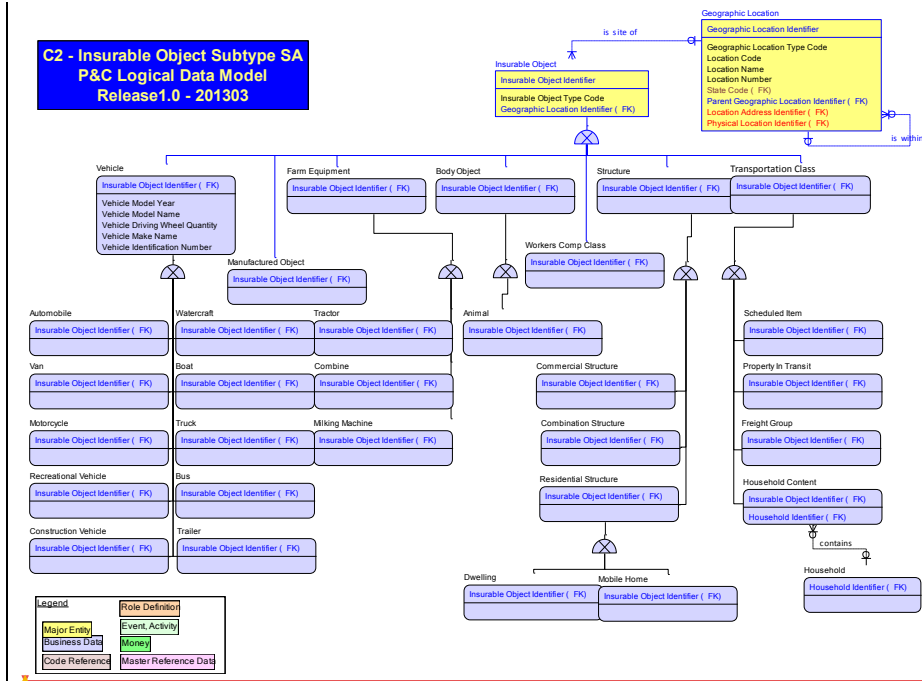

### 3.1.12 Money Subtype Subject Area Model

The "Money" Subtype Subject Area shows the various classifications of policy and claim monies, and is useful for the understanding of what is represented in the Policy Amount and Claim Amount entities.

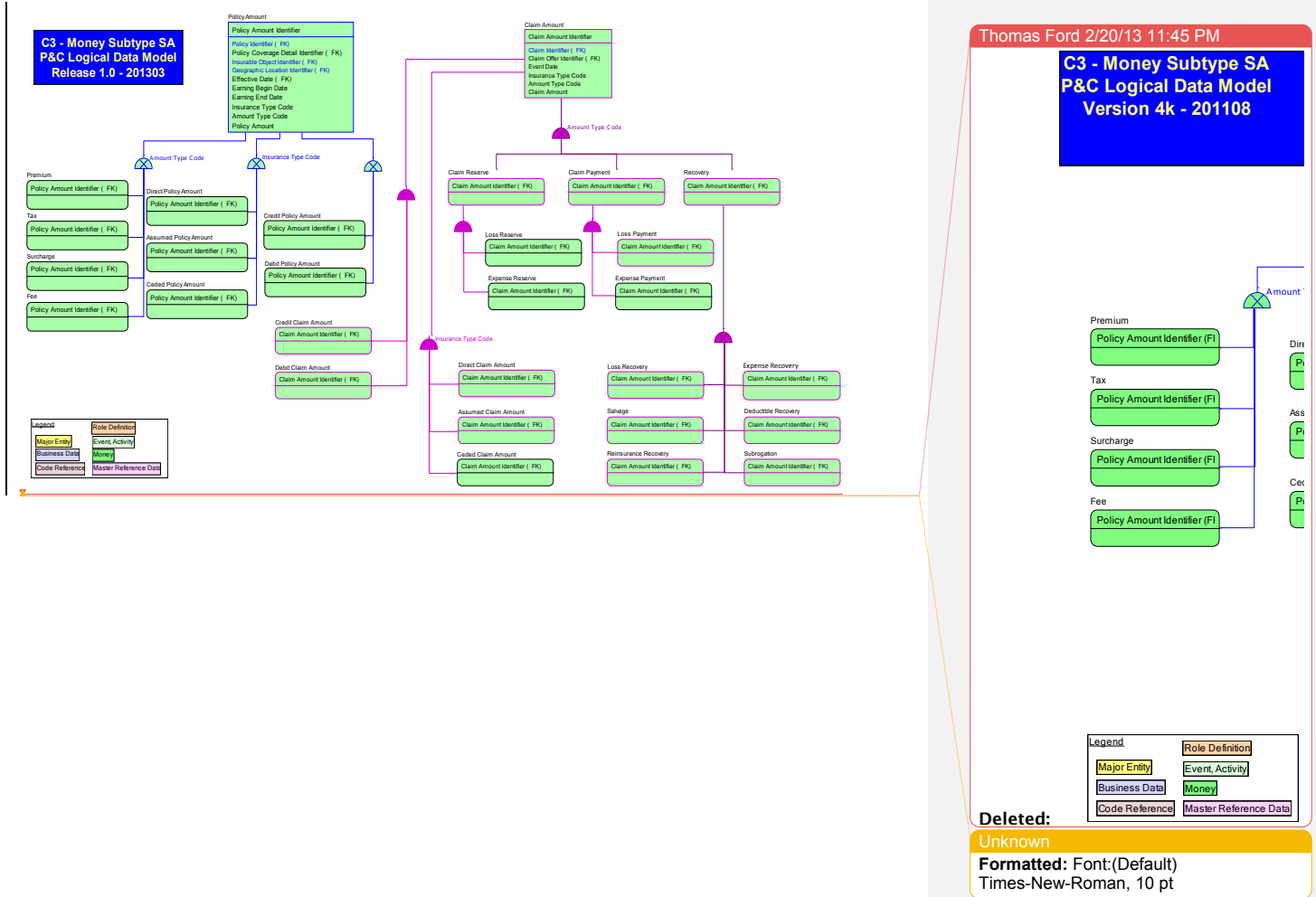

### 3.1.13 Event Subtype Subject Area Model

The Event Subject Area shows the subtypes of events defined to date for policy.

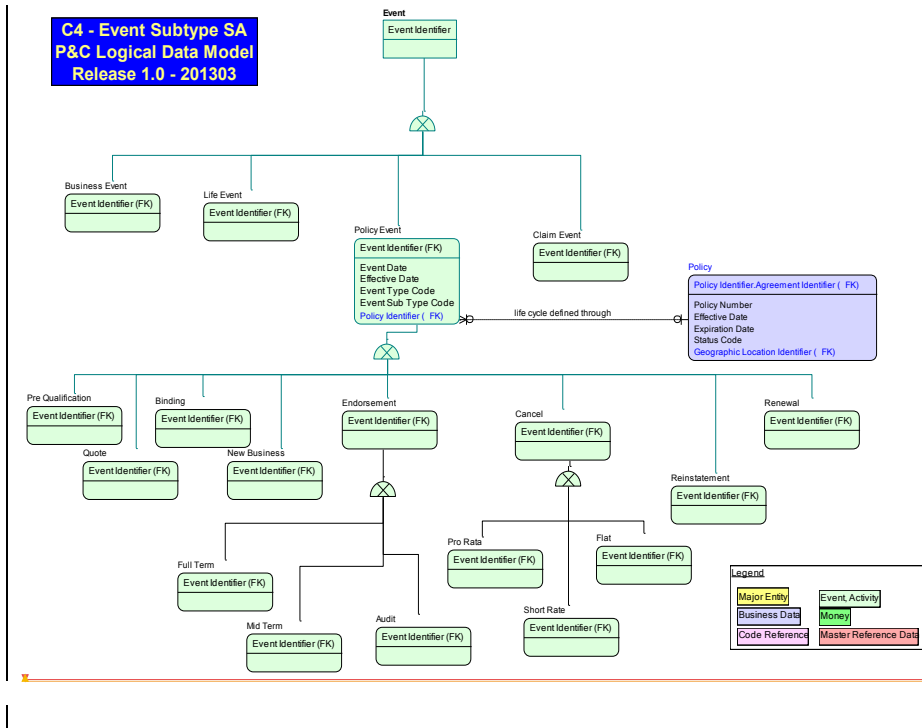

Thomas Ford 2/20/13 11:46 PM

**C4 - Event Subtype SA**  
**P&C Logical Data Model**  
**Version 4m - 201107**

**Deleted:**  
**Unknown**  
**Formatted:** Font:(Default)  
 Times-New-Roman, 10 pt

### 3.1.14 Product Coverage Reference Subject Area Model

The Product Coverage Reference Subject Area shows the entities involved in defining the company products and coverage. This is the framework for defining master data for the offerings of the company, and assuring integrity of the policy data.

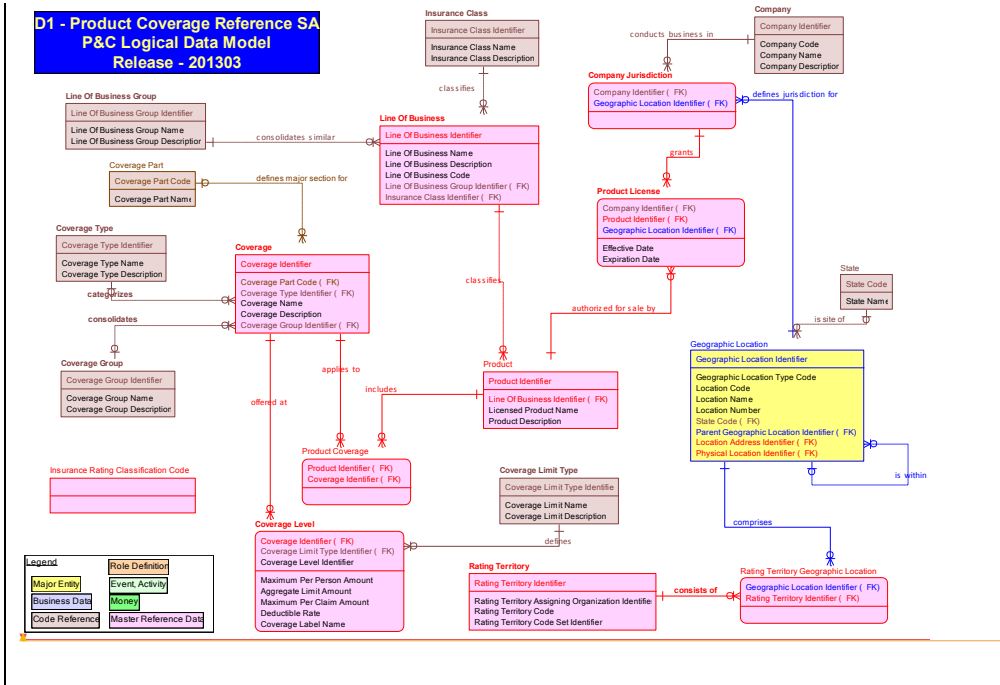

#### Other Subject Areas Not Included in this Document:

The "Main Subject Area" contains all the model objects in the entire data model. For this Property and Casualty Data Model, the main subject area may contain extra model objects that have not yet been included in the specific Subject Areas.

The "Diagram Spacing Template" contains objects useful for designing entity layouts for the subject area diagrams and is not included in the publishable objects.

Thomas Ford 2/20/13 11:47 PM

### D1 - Product Coverage P&C Logical Data Version 4p - 20

**Line Of Business Group**  
 Line Of Business Group Identifier  
 Line Of Business Group Name  
 Line Of Business Group Description

**Coverage Part**  
 Coverage Part Code  
 Coverage Part Name

**Coverage Type**  
 Coverage Type Identifier  
 Coverage Type Name  
 Coverage Type Description

**Coverage Group**  
 Coverage Group Identifier  
 Coverage Group Name  
 Coverage Group Description

**Insurance Rating Classification Code**

**Legend**

Major Entity	Event, Activity
Business Data	Money
Code Reference	Master Reference Data

**Deleted:**  
 Unknown  
 Formatted: Font:(Default)  
 Times-New-Roman, 10 pt

## 3.2 Glossary of Data Model Terms and Definitions

### 3.2.1 Subject Area Definitions

The Section below provides a listing of all subject areas included in the P&C Data Model, and the text definitions for each subject area. The subject areas are listed in hierarchical order starting with the Main Subject Area, the "A" level being the Major Subject Areas: Party, Account and Agreement, Policy, Claim and Assessment – the "B" level containing the Roles: Agreement, Claim and Staffing Roles – the "C" level lists the Subtypes: Party, Insurable Object, Money, and Event Subtypes, and the "D" level with Product Coverage Reference.

Subject Area Name	Subject Area Definition
<Main Subject Area>	The "Main Subject Area" contains all the model objects in the entire data model. For this Property and Casualty Data Model, the main subject area may contain extra model objects that have not yet been included in the specific Subject Areas.
A1 - Party	The Party Subject Area shows that all persons, organizations, and groups can be represented as "parties" and that parties can then be related to other major objects with specified roles. The Party design also provides for a common approach to describing communication identifiers, relationships between parties, and legal identifiers. Examples of the use of the party types is also shown.
A2 - Account and Agreement	The Account and Agreement Subject Area presents the common framework for establishing customer-oriented accounts and company-oriented financial services agreements. Party Role is used to relate all parties to account and agreement, and various agreement types are identified. Refer to the Agreement Role Subject Area for examples of the roles involved with agreements.
A3 - Policy	The Policy Subject Area defines the common features of an insurance policy and shows how they are related to parties and agreement. Common constructs for Geographic Location and Insurable Objects allow for these to be shared above the level of a Policy. A common entity for policy monies allows for all types of amounts to be defined at all policy levels.

Subject Area Name	Subject Area Definition
A4 - Claim	The Claim Subject Area defines the major entities involved in claims management, beginning with an occurrence resulting in claims and subclaims, and the option of arbitration and litigation being involved in claim settlement. As with all areas of the model, the relationships and roles of parties is defined for the major entities. The relationship of claim to coverage is shown, and a common entity for all claims monies is defined. Refer to the Claim Role Subject Area for examples of the roles involved with claims.
A5 - Assessment	The Assessment Subject Area shows the types of assessments that apply to the insurance and financial business. These provide for oversight, risk assessment, financial information and valuation of assets. Assessments are related to other major entities such as agreement, insurable object and claim, with party roles for assessment being defined in the common metaphor.
B1 - Agreement Role	The Agreement Role Subject Area shows examples of the roles that can be involved in agreements. While these roles would become Role Codes in an implementation, it is usable to display them for understanding.
B2 - Claim Role	The Claim Role Subject Area shows examples of the roles that can be involved in claims. While these roles would become Role Codes in an implementation, it is usable to display them for understanding.
B3 - Staffing Role	The Staffing Role Subject Area shows examples of the roles that can be involved in staffing. While these roles would become Role Codes in an implementation, it is usable to display them for understanding. This subject area also shows the entities of interest with respect to the classification and assignment of staff, which supports the operational aspects of insurance and financial services.
C1 - Party Subtype	The Party Subtype Subject Area shows examples of the classifications of organization and group. It also provides examples of the use of organization and the optional ways of defining organization hierarchies. The use of party relationship is demonstrated as a common way of managing party person, organization, and group relationships.
C2 - Insurable Object Subtype	The Insurable Object Subtype Subject Area shows examples of the varied objects that can be involved in insurance. Some subtypes require further specialized information and may involve implementation of the subtypes, whereas some objects can be commonly described at the object level.
C3 - Money Subtype	The "Money" Subtype Subject Area shows the various classifications of policy and claim monies, and is useful for the understanding of what is represented in the Policy Amount and Claim Amount entities.
C4 - Event Subtype	The Event Subject Area shows the subtypes of events defined to date for policy.

Subject Area Name	Subject Area Definition
D1 - Product Coverage Reference	The Product Coverage Reference Subject Area shows the entities involved in defining the company products and coverages. This is the framework for defining master data for the offerings of the company, and assuring integrity of the policy data.

### 3.2.2 Entity Definitions

The section below provides a listing of all entities included in the P&C Data Model, and the text definition for each entity. The entities are listed in alphabetical order.

Entity Name	Entity Definition	Change
Account	Account is a business arrangement providing for regular dealings or services such as multiple policies and contracts.	
Account Agreement	Account Agreement is an relationship between account and agreement. It can be used to relate multiple agreements to a single account such as for billing.	
Account Party Role	Account Party Role defines how the Party relates to the Account.	
Account Provider	Account Provider is a Role played by a Party who, in the context of an account agreement, provides an account and the related account facilities to the account holder.	
Account Role	Account Role relates a Party to a Role within an Account.	
Accountability	Accountability is a Role played by a Party who is responsible for an Account or Project or Assessment or any other object or activity.	
Additional Interest	Additional Interest is a Role played by a Party who has financial or risk interest in an Agreement.	
Adjuster	Adjuster is a role played by a Party who handles a claim brought against an insurance company or syndicate.	change
Administrative Organization Unit	An Administrative Organization Unit is a management structure of an organization that represents reporting relationships and responsibilities.	
Agency Contract	Agency Contract is a type of agreement that stipulates the business arrangement between an insurance agency, and the insurer it represents.	



Entity Name	Entity Definition	Change
Agent	Agent is a Role played by a Party who sells and services insurance policies in either of two classifications: 1. Independent agent represents at least two insurance companies. 2. Captive Agent represents only one company and sells only its policies.	change
Agreement	Agreement is language that defines the terms and conditions of a legally binding contract among the identified parties, ordinarily leading to a contract. Examples; policy, reinsurance agreement, staff agreement.	
Agreement Assessment	Agreement Assessment relates an Assessment to an Agreement.	
Agreement Party Role	Agreement Party Role defines how a Party relates to the agreement. Examples: Party is a primary named insured on a policy agreement; Party is a broker who sold the agreement.	
Agreement Role	Agreement Role relates a Party to a Role within an Agreement.	
Animal	Animal is an Insured Object that can be farm livestock, a zoo animal, a pet, or any other animal that could be insured.	
Approval	Approval is an authorization given by a role player for the execution of a business activity.	NEW
Arbitration	Arbitration is the process of settling a dispute by an appointed third party outside court.	change
Arbitration Party Role	Arbitration Party Role defines how the Party relates to the agreement,	
Assessment Party Role	Assessment Party Role defines how the Party relates to the Assessment.	
Assessment	Assessment is a formal evaluation of a particular person, organization, or thing that enables business decisions to be made. Examples: Credit Score, Underwriting Evaluation, Medical Condition.	change
Assessment Result	An Assessment Result is the outcome of the assessment. There may be multiple results for one assessment.	

Entity Name	Entity Definition	Change
Assumed Claim Amount	Assumed Claim Amount classifies monies as belonging to a claim that relates to a policy that has assumed from another company.	
Assumed Policy Amount	Assumed Policy Amount classifies monies as belonging to a policy that is assumed from another company.	
Attorney	Attorney is a Role played by a Person who is legally appointed to transact business on another's behalf.	
Audit	Audit (herein Premium Audit) is a transaction that occurs generally after the policy term has expired, to see if the exposures were accurate or if any post term changes need to be made and more premium billed or a credit given. Example: a premium audit may be conducted of a company insured under a workers compensation policy to assure appropriate premium has been charged based on risk location and insured workers job.	
Auditor	Auditor is a Role played by a Party who performs either operational or financial reviews (audits).	
Auto Repair Shop Contract	Auto Repair Shop Contract is a kind of Agreement where a Repair Facility may be selected by the insurer to perform appraisals only or perform appraisals and repairs.	change
Automobile	An Automobile is an Insured Object that is a self-propelled passenger vehicle designed for operation on ordinary roads and typically having four wheels.	
Binding	Binding is the act of providing insurance coverage between the time an Insurance company accepts the risk and is ready to issue the permanent policy.	
Boat	A Boat is an Insured Object that is a vessel that carries passengers or freight over water.	

Entity Name	Entity Definition	Change
Body Object	Body Object is an Insurable Object such as a human body part, a life form such as a lab organism, or an animal.	
Branch Office	A Branch Office is an Organization Unit that is a local business location of an insurance company that markets and/or services its products and lines of insurance within and to a specified geographic location.	
Broker	Broker is a Role played by a Party who searches the marketplace in the interest of clients, not insurance companies.	
Brokerage Contract	Brokerage Contract is a subtype of an Agreement that defines business arrangements between a Brokerage business and another insurance or financial institution.	
Bus	A Bus is an Insurable Object that is a public or private conveyance vehicle used to transport people, e.g. School Bus.	
Business Event	Business Event is a significant change during the existence of an organization that is of interest to an insurer organization because of the potential resulting change(s) to the underlying organization's risk.	change
Buyer	Buyer is a person or organization that is responsible for acquiring goods or services that are provided for in a provider agreement.	
Cancel	Cancel is the act of annulling a Policy by the insured of by the Insurance Company. The policy is no longer in-force as of the date of cancellation or an agreed upon date.	
Catastrophe	Catastrophe is a destructive event of significant importance. Due to both the scope and the scale of losses under the event, it is classified separately from other loss events. These events may also be formally classified by a political entity whose jurisdiction the event took place.	
Ceded Claim Amount	Ceded Claim Amount identifies claim monies as being owed by a reinsurer.	
Ceded Policy Amount	Ceded Policy Amount identifies policy monies as being owed to a reinsurer.	

Entity Name	Entity Definition	Change
Channel Role	Channel Role is when a person or an organization has an agreement with an insurance company to sell or service the latter's products and, as such, to act on behalf of the insurer (e.g. salaried call center network, broker, agent).	change
Channel Score	Channel Score is a kind of Assessment Result that indicates the relative success of the channel in marketing, and servicing products and services on behalf of the insurer.	
Claim	Claim is a request for indemnification by an insurance company for loss incurred from an insured peril or hazard.	change
Claim Administrator	Claim Administrator is a Role played by a Party who is designated by the insurance company, to manage the administration and handling of a claim.	
Claim Amount	Claim Amount is the money being paid or collected for settling a claim and paying the claimants, reinsurers, other insurers, and other interested parties. Claim amounts are classified by various attributes.	
Claim Arbitration	Claim Arbitration is an associative entity that relates a Claim to an Arbitration.	
Claim Assessment	Claim Assessment is an associative entity that relates a Claim to an Assessment.	
Claim Coverage	Claim Coverage is an associative entity that relates a Claim to the Policy Coverage under which the claim is paid.	
Claim Evaluation Result	Claim Evaluation Result is the outcome of a Claim Assessment.	
Claim Event	Claim Event is a subtype of Event that identifies and describes the accident or occurrence that triggered the claim.	
Claim Examiner	A Claim Examiner is a Role played by a Party who is assigned to the claim to determine its legitimacy and provide feedback to the insurance company.	
Claim Expert	A Claim Expert is a role played by a Party who provides advice on matters associated with the claim.	
Claim Folder	A Claim Folder is the physical file in which all claim documents are maintained.	
Claim Folder Document	Claim Folder Document is written information such as agreements, financial	

Entity Name	Entity Definition	Change
	statements, offers, proposals, etc., to provide backup and depth to agreed-upon or discussed claim matters.	
Claim Fraud Examiner	A Claim Fraud Examiner is a Role played by a Party whose goal is to determine whether fraud has occurred or is occurring, and to determine who is responsible for the fraud.	
Claim Legal Expert	A Claim Legal Expert is a Role played by a Party who provides legal advice on matters relating to the claim.	
Claim Litigation	Claim Litigation is a legal proceeding that may be a lawsuit about a claim or a settlement out of court.	
Claim Offer	A Claim Offer is a proposal made by an insurer to a claimant or third party in order to settle a claim.	change
Claim Party Role	Claim Party Role defines any Party's involvement or role in a Claim. Examples: claimant, adjuster, victim.	
Claim Payment	Claim Payment is the amount paid for loss or expense to settle a claim in whole or in part.	
Claim Representative	A Claim Representative is a representative acting on behalf of the insurance company to mediate relations and initially settle disputes with it's members or other Third Parties.	
Claim Reserve	Claim Reserve is the amount of expected loss over the life of the Claim.	
Claim Role	Claim Role is a subtype of Party Role that organizes the roles specific to Claim.	
Claim Witness	Claim Witness is a Role of an individual or group or organization having first hand knowledge of the circumstances, events or surrounding the occurrence of an event that resulted in a request for indemnification from an insurance company.	change
Claimant	Claimant is a Role of a Person or Organization who asserts a loss and the right to demand payment of compensation or benefits or indemnification of loss.	
Claimee	Claimee is a role played by a Party who submits a claim to an insurance company.	

Entity Name	Entity Definition	Change
	(see also Claimant.)	
Combination Structure	A Combination Structure is an Insurable Object that is used both for human habitation and for use by retail, wholesale, office, hotel or service users, or for manufacturing or other industrial purposes.	
Combine	A Combine is a piece of farm machinery used to harvest crops, e.g. wheat.	
Commercial Agreement	Commercial Agreement is a Contract, such as an insurance policy, between one organization and another organization dealing with the commercial business activity of one of the organizations.	
Commercial Structure	Commercial Structure is an Insurable Object that is a property intended for use by retail, wholesale, office, hotel or service users, or for manufacturing or other industrial purposes.	
Communication Identity	Communication Identity provides contact information specifications that can be utilized for communicating with a party. It specifies Communication Type (e.g., physical address, email, phone, Facebook) and Communication Value (e.g., phone number, email address, site address).	change
Commutation Agreement	A Commutation Agreement is a kind of Agreement between a ceding insurer and the reinsurer that provides for the valuation, payment, and complete discharge of all obligations between the parties under a particular reinsurance contract.	change
Company	Company is a formal, legally registered entity, created for the purpose of conducting business.	
Company Jurisdiction	Company Jurisdiction is a legal entity or recognized political subdivision that defines where an insurance company can operate and which products can be sold and serviced by the company.	change
Construction Vehicle	A Construction Vehicle is a motorized vehicle used in the course of building and moving anything.	

Entity Name	Entity Definition	Change
Consultant Contract	Consultant Contract is a subtype of Agreement that outlines the working arrangement for a consultant.	
Contractor	Contractor is a Role played by a Person who contracts to do work for another. An Independent Contractor makes an agreement to do a specific piece of work, retaining control of the means and method of doing the job. Examples of independent contractors are physicians, lawyers, construction contractors, engineers, and others engaged in a profession in which they offer their services to the public.	
Court Jurisdiction	Court Jurisdiction specifies a specific court within a specific jurisdiction (legal and physical area) that administers justice.	change
Coverage	Coverage is the definition of the risks being provided indemnification, and the level of indemnification being provided under an insurance policy. In property insurance, coverage lists perils insured against, properties covered, locations covered, individuals insured, and the limits of indemnification. In life insurance, coverage provides living and death benefits.	
Coverage Group	Coverage Group is the aggregation of coverage under a broader business classification to group them for reporting purposes, e.g. a group of liability coverage, a group of property coverage.	
Coverage Level	Coverage Level is one of the possible limits of indemnification provided under a coverage.	
Coverage Limit Type	Coverage Limit Type is the category of indemnification limit that is applied under a coverage.	
Coverage Part	Coverage Part is a section of an insurance Policy that organizes coverages at a high level, usually property versus liability.	
Coverage Type	Coverage Type defines the categories for different types of coverages, e.g. is the coverage for liability, for physical damage, for no fault.	

Entity Name	Entity Definition	Change
Credit Claim Amount	Credit Claim Amount is any Claim Amount that offsets the amount paid for a claim.	
Credit Policy Amount	Credit Policy Amount is any Policy Amount that offsets the revenue for a policy.	
Credit Rating	Credit Rating is a rating typically provided by a financial institution or rating service indicating the likelihood of a Party to meet financial commitments based on past behavior and current financial position.	
Customer	Customer is a Role played by a Party to whom an insurer is currently supplying (or has supplied in the past) services, goods, or benefits.	
Customer Score	Customer Score is a kind of Assessment Result that assigns points to each customer based on specific criteria in order to be able to rank order customers against the dependent variable measured by that criteria.	change
Debit Claim Amount	Debit Claim Amount is any amount that is paid for a claim, including monies paid to claimants and claim expenses.	
Debit Policy Amount	Debit Policy Amount is any amount that is owed to the company for insurance (called premium), or taxes and surcharges.	
Deductible Recovery	Deductible Recovery is a subtype of Claim Amount that represents from the individual responsible for the deductible payment the amount of deductible associated with a loss payment under a claim.	
Demographic Score	Demographic Score is an Assessment Result that is used to rank orders, risks, or individuals based on a table of points assigned to pre-identified demographic characteristics of the risk or individual.	
Department	Department is an Organization Unit that groups individuals with common or related jobs to accomplish certain common or related functions. Example: payroll department.	
Derivative Contract	Derivative Contract is a kind of Agreement where the value of the contract is based on derived variables or characteristics, such as an index of commodity prices.	



Entity Name	Entity Definition	Change
Direct Claim Amount	Direct Claim Amount classifies monies as belonging to a claim that relates to a policy that is directly written by the company.	
Direct Policy Amount	Direct Policy Amount classifies monies as belonging to a Policy that is written directly by the company.	
Driver	Driver is a Role played by a Person who operates a vehicle.	
Dwelling	A Dwelling is an Insured Object that is a structure or part of a structure used as a place of residence by human beings.	
Employment Agreement	Employment Agreement is a written Agreement between employer and employee, stating the terms of employment in an organization.	
Endorsement	Endorsement is a supplementary coverage option added to the base policy in order to expand or extend the coverage provided. From a financial perspective, endorsements may have an effect on the total premium paid for a policy, or may not have an impact on the premium paid for the policy.	change
Event	Event is anything that happens, or is contemplated as happening. From an insurance perspective, an event is a situation that may impact the risk or indemnification covered by a policy.	
Expense Payment	Expense Payment is the amount paid for the expenses to settle a claim in whole or in part.	NEW
Expense Recovery	Expense Recovery is the reimbursement of part or all of an Expense Payment.	NEW
Expense Reserve	Expense Reserve is the amount set aside for the expected expenses to settle a Claim.	NEW
Farm Equipment	Farm Equipment is an Insured Object that is Equipment commonly used on a Farm, for example a tractor, cultivator, plow, combine, grain elevator, milking machine, etc.	change
Fee	Fee is a charge imposed on the insurance company on an insurance policy either as a service fee and/or from a government entity as a tax on the premium charged.	

Entity Name	Entity Definition	Change
Field Organization Unit	A Sales Organization Unit is an example of the use of Party to define a company's internal organization geographic locations, usually to support sales and marketing operations.	change
Financial Account Agreement	A Financial Account Agreement is a kind of Agreement that is between a financial services provider and an account holder and is related to the management of a financial account.	
Financial Adviser	Financial Adviser is a Role played by a Person as a professional adviser offering financial counsel. Some financial advisers charge a fee and earn commissions on the products they recommend to implement their advice. Other advisers only charge fees and do not sell any products or accept commissions. Some financial advisers are generalists, while others specialize in specific areas, such as investing, insurance, estate planning or taxes.	
Financial Analyst	Financial Analyst is a Role played by a Party who works for a financial institution and is responsible for research and analysis of specific financial instruments, portfolios and strategies.	
Financial Interest Role	Financial Interest Role identifies the monetary or monetarily valued interest a party has in the coverage. Examples are insured, beneficiary, etc.	
Financial Service	Financial Services Role is a subtype for Party Agreement Roles includes Insurer, Policyholder, Assignee, etc.	
Financial Services Assessment	Financial Services Assessment is a kind of Assessment Result that focuses on the finances of an individual or organization based on pre-defined characteristics that identify the financial or monetary risks represented by the firm.	
Financial Valuation	Financial Valuation is an assessment result expressed in financial units.	
Flat	Flat is a Cancellation Event subtype that represents the full cancellation of a policy where the policy is deemed to have never	change

Entity Name	Entity Definition	Change
	existed, no risk indemnification has been provided, and a full return of premium is granted.	
For Profit Organization	For Profit Organization is a subtype of Organization and Party that is a means of classifying an organization.	
Fraud Assessment	Fraud Assessment is a subtype of Assessment Result that identifies whether fraud has occurred or is occurring, the extent and impact of the fraud, and to determine who is responsible for the fraud.	
Freight Group	Freight Group is a kind of Insurable Object Group that addresses responsibility for in transit goods.	
Full Term	Full term is a type of endorsement where the changes made are effective on the policy effective date and apply for the full term of the policy.	
Geographic Location	A Geographic Location is a bounded area defined by nature, by an external authority (such as a government) or for an internal business purpose. Used to identify a location in space that may or may not be a structured address, Examples: country, city, continent, postal area, risk area, postal address, property address.	
Government Organization	Government Organization is a kind of Organization with control of any asset, industry, or enterprise at any level, national, regional or local (municipal).	change
Group Agreement	Group Agreement is a kind of contractual insurance Agreement provided to the employer and detailing coverage provided to the group.	
Grouping	Grouping is an informal collection of people banded together through a common situation. Example: Household or Project Team or professional group.	NEW
Health Care Provider	Health Care Provider is a Role played by a Party who provides services concerned with the maintenance or restoration of the health of the body or mind.	
Household	Household is a set of individuals, usually resident at the same address, and members of the same nuclear or extended family, who share a common economic interest and who are to be treated for certain purposes (for	change

Entity Name	Entity Definition	Change
	example, marketing campaigns) as a unit.	
Household Content	Household Content is a categorization and description of all Insurable Objects (personal property) within a residence, which details all items covered and indemnified in the event an insurance claim must be filed.	change
Household Person	Household Person is an individual who resides within a household.	
Household Person Role	Household Person Role defines an individual's function within a household, such as head of household.	
Independent Adjuster	Independent Adjuster is a Role played by a Party who handles a claim brought against an insurance company or syndicate, and who is not an employee of the Insurance company.	change
Individual Agreement	Individual Agreement is a kind of legal or contractual Agreement that an Individual voluntarily enters.	
Inhouse Adjuster	Inhouse Adjuster is a Role played by a Party as an Adjuster who is an employee of the Insurer or under contract by the Insurer.	
Inpatient	Inpatient is a Role played by a Person who is formally admitted (or hospitalized) to an institution for treatment and/or care and stays for a minimum of one night in the hospital or other institution providing inpatient care.	
Insurable Object	An Insurable Object is an item which may be included or excluded from an insurance coverage or policy, either as the object for which possible damages of the object or loss of the object is insured, or as the object for which damages caused by the object are insured. Examples: residence, vehicle, class of employees.	
Insurable Object Party Role	Insurable Object Party Role defines how the Party and the Insurable Object are related. Examples: person is driver of vehicle, organization owns property.	
Insurance Class	Insurance Class is the high level type or line of insurance business in which the organization is engaged, e.g. Property and Casualty or Life Insurance.	
Insurance Rating Classification Code	Insurance Rating Classification Code is a Code that varies by insurance line of	change

Entity Name	Entity Definition	Change
	business and is used to define the rate for calculating premiums for various coverages, types of insurable objects, and locations.	
Insured	Insured is a Role played by a Party whose interest in the subject matter of the insurance is protected under the policy. The insured does not necessarily need to be the policyholder or the beneficiary.	
Insured Account	Insured Account is an account at a brokerage firm, bank, savings and loan association or credit union that is insured either by a federal or private insurance. This could also be an organization that has one or more contractual relationships with a commercial lines insurer.	
Insurer	Insurer is a Role played by a Party who provides insurance.	
Intermediary Agreement	An Intermediary Agreement is a kind of Agreement that defines the ways in which an intermediary can act on behalf of an insurance company.	
Legal Adviser	Legal Adviser is a Role played by a Party who is employed by another Party to give legal guidance and advice on the way the latter party conducts business.	
Legal Jurisdiction	Legal Jurisdiction is a geographic or topical area of authority for a specific government entity.	
Legal Jurisdiction Party Identity	Legal Jurisdiction Party Identity provides the identifier by which a party is known to the designated legal jurisdiction, such as a drivers license number for a given state jurisdiction.	
Life Event	Life Event is an incident that occurs during the lifetime of a Party and that may have importance in a decision by the party to contemplate the purchase of insurance, e.g. the birth of a child, a birthday, a graduation event.	
Line Of Business	Line of Business is the kind of insurance business in which the organization is engaged, e.g. property, liability, life, health.	
Line Of Business Group	Line of Business Group is the aggregation of insurance coverages or contracts by an insurance carrier, either for internal reporting purposes or external reporting purposes.	
Litigation	Litigation is a judicial contest through which legal rights are sought to be determined and enforced.	

Entity Name	Entity Definition	Change
Litigation Party Role	Litigation Party Role defines how the Party relates to a Litigation case.	
Location Address	Postal Address is a Contact Point that is an address used for the delivery of letters and packages by an external mailing or packaging service, at a place where the recipient usually lives or works. Note that the exact structure of a postal address is likely to change depending on the country of the postal address.	
Loss Payee	Loss Payee is a Role played by a Party to whom losses under the policy will be payable (e.g. a mortgagee).	
Loss Payment	Loss Payment is the amount paid to claimants to settle a claim.	NEW
Loss Recovery	Loss Recovery is the reimbursement of part or all of a Loss Payment.	NEW
Loss Reserve	Loss Reserve is the amount set aside for expected loss over the life of the Claim.	NEW
Manager	Manager is a role played by an individual within an organization who defines and communicates the work activities of others, makes decisions regarding the allocation of resources, and legally engages in relationships with individuals and organizations outside the organization.	
Managing General Agent	Managing General Agent is a role played by a wholesale insurance intermediary with the authority to accept placements from (and often to appoint) retail agents on behalf of an insurer. Managing general agents generally provide underwriting and administrative services, such as policy issuance, on behalf of the insurers they represent. These arrangements are most common in the surplus lines marketplace. Typically, MGAs benefit insurers because such expertise is	change

Entity Name	Entity Definition	Change
	not always available within the company and would be more costly to develop on an in-house basis.	
Manufactured Object	Manufactured Object is an Insurable Object that was made by machine or by industrial process.	
Medical Condition	Medical Condition is an assessment of the health state and physical condition of person, that may be covered or indemnified by an insurance policy.	
Mid Term	Mid Term is a type of endorsement that is applied to a policy whereby the changes are made and effective at a point in time after the effective date and before the expiration date of a policy term, and not from the effective date of the policy.	
Milking Machine	Milking Machine is an Insurable Object that is a kind of Farm Equipment and is an electric machine for milking cows.	
Mobile Home	Mobile Home is an Insured Object that is a dwelling unit manufactured in a factory and designed to be transported to a site and semi permanently attached.	
Motorcycle	Motorcycle is an Insured Object that is a two or three wheeled automotive vehicle for one or two people.	
Mutual Fund Provider	Mutual Fund Provider is a kind of Service Provider who offers shares in an investment company that uses the capital to buy a diverse group of stocks from other companies based on a stated set of investment objectives.	change
New Business	New Business is a policy transaction by which an insurance policy is purchased by or sold to an individual or organization where no current relationship exists for that policy type with the insurance company. This operation is recognized when the first premium is collected.	
Not For Profit Organization	Not For Profit Organization is a kind of Organization that has received a current and appropriate government designation as a Not for Profit entity.	

Entity Name	Entity Definition	Change
Object Assessment	Object Assessment is the review and evaluation of a specific insured item for validation of coverage.	
Occurrence	Occurrence is an event that results in bodily injury and/or property damage to a third party. A clause that is common to most liability insurance policies stipulates that all bodily injuries and/or property damages resulting from the same general conditions are interpreted as resulting from one occurrence and thus subject to the policy limits per occurrence.	
Organization	An Organization is a Party that is a business concern or a group of individuals that are systematically bound by a common purpose. Organizations may be legal entities in their own right. Examples: commercial organizations such as limited companies, publicly quoted multinationals, subsidiaries.	
Organization Unit	An Organization Unit is a Division, Department, Territory or any other entity that is used to manage company operations. Some but not all Organization Units are legal entities.	change
Other Assessment Result	Other Assessment Result is a kind of Assessment Result that is not covered by other commonly listed options available.	
Outpatient	Outpatient is a Role played by a Person who is not formally admitted to a facility (physician's private office, hospital outpatient center or ambulatory-care center) for treatment and/or care and who does not stay overnight.	
Party	Party is a Person, Organization or Grouping that can enter into a contract or other legal proceeding, or which plays a role in the insurance industry.	
Party Assessment	Party Assessment is an associative entity that relates a Party to an Assessment.	



Entity Name	Entity Definition	Change
Party Communication	Party Communication links a party to a Communication Identity. Examples; a person has a phone number; an organization has a website: both have an address.	
Party Preference	Party Preference records preferences (in addition to communication ones) such as language for persons or groups.	
Party Relationship	Party Relationship defines how two parties are linked to each other, such as person works for an organization.	
Party Relationship Role	Party Relationship Role defines the role that one party plays with respect to another party, such as a person working for an organization plays the role of team leader. Party Relationship defines what a party is; Role defines what a party does.	
Party Role	Party Role defines how a Party relates to another entity. Role is the definition of what a Person, Organization, or Grouping DOES whereas Relationship is about what a party IS.	change
Patient	Patient is a Role played by a Person who is in contact with the health care system seeking attention for a health condition.	
Person	Person is a Party who is a human being, either alive or dead.	
Person Profession	Person Profession is a title or career category that describes how an individual earns a living. Examples: Doctor, Lawyer, Teacher, Carpenter, Entertainer.	
Physical Location	Physical Location is an area bounded by parameters such as Latitude and Longitude, Altitude, Depth, etc.	
Physical Object Assessment	Physical Object Assessment is an assessment type that measures the risks represented by ownership, utilization or proximity of the physical object. It collects information regarding the likelihood of the object to contribute to the probability of future loss under an insurance policy or contract issued.	
Place Assessment Policy Policy Amount	Place Assessment is information regarding a location and/or physical structure that may impact its likelihood to contribute to the probability of future events that may increase the risk under an insurance policy	

Entity Name	Entity Definition	Change
	or contract issued.	
	Policy is a kind of written Agreement that puts insurance coverage into effect.	
	Policy Amount is a central entity for defining all the monies associated with a Policy.	change
Policy Coverage Detail	Policy Coverage Detail defines the specific coverages within the terms of a Policy.	
Policy Coverage Part	Policy Coverage Part is a major section of a Policy that organizes the coverages. Typically, there are Coverage Parts for property and liability.	
Policy Deductible	Policy Deductible defines the Deductibles (attachment point for coverage) associated with the policy coverages. Deductibles are the loss amounts paid by the insured before insurance payments apply.	
Policy Event	Policy Event is an event that deals with servicing an insurance policy. Examples would include Policy Renewal, Reinstatement, Cancellation, etc.	
Policy Form	A Policy Form is a typical document that explains the insurance coverages for a policy. These are usually standard industry forms augmented by insurer-specific cover pages and specialized addendums.	change
Policy Limit	Policy Limit defines the Limits (highest amount of coverage or other limit expression such as number of days compensation) associated with the policy coverages.	
Policy Relationship	Policy Relationship defines the relationship between two policies.	
Pre Qualification	Pre Qualification is an Event resulting from the process of assuring that a risk will be acceptable and a policy will be issued before either the application is received or the policy is fully underwritten.	change
Premium	Premium is money amount that is charged for the amount of insurance and the coverage terms provided under the policy.	

Entity Name	Entity Definition	Change
Premium Auditor	Premium Auditor is the Role that determines the exposure basis for an insurance policy, i.e., payroll, sales, or vehicle count, after the end of a policy period to determine the actual (audited) exposure for the purpose of making a final calculation of the premium and premium taxes.	
Pro Rata	Pro Rata is a type of cancellation Event where the policy is deemed to have been effective for a period of time and only a pro rata amount of premium is returned based on the time the policy was effective. The calculation methodology for the pro rata amount can change from insurance company to insurance company.	
Producer	Producer is a role played by a Person who sells and services insurance policies in the jurisdictions for which the person is licensed, and for the companies for which the producer is appointed.	
Product	Product is the definition of what is agreed between the insurance company and its customers as an item to be purchased as part of an insurance agreement.	
Product Coverage	Product Coverage is an associative entity that relates a Product to a Coverage. It is a master reference data entity whose data specifies which Coverages apply to which Products.	
Product License	Product License is an associative entity that relates a Product to a Jurisdiction in which the Product is licensed. It is a master reference data entity whose data specifies which Products are licensed in which Jurisdictions (usually States).	
Professional Group	Professional Grouping is a subtype example of a Grouping that is a subtype of Party.	
Project	Project is a subtype example of a Grouping that is a subtype of Party.	
Property In Transit	Property in Transit is a kind of Insured Object Group that is property being transported in any vehicle.	
Prospect	Prospect is a Role played by a Party who is a potential purchaser of an insurance product.	
Provider	Provider is a role played by a party to provide a service or to take responsibility for people who contract with them.	

Entity Name	Entity Definition	Change
Provider Agreement	Provider Agreement is a kind of Agreement between an individual or organization which provides products and/or services, and the individual or organization contracting for the products and/or services.	
Public Adjuster	Public Adjuster is a Role played by a Party who, as an Adjuster, represents the interests of the claimant.	
Quote	Quote is a type of Event that is a price estimate for an insurance policy. The estimate is considered not to be binding.	change
Rating Territory	Rating Territory is a code developed to charge a adequate premium for the risk within that geographic area.	
Rating Territory Geographic Location	Rating Territory Geographic Location is an associative entity that relates a Rating Territory to a Geographic Location. It is a master reference entity whose data specifies the Geographic Locations within the various Rating Territories.	
Recovery	Recovery is a kind of Claim Financial in which the insurance company attempts to recoup monies distributed in error or monies due it through the actions or inactions of others.	
Recreational Vehicle	Recreational Vehicle is an Insured Object that is a vehicle designed for recreation, as in camping.	
Regional Office	A Regional Office is an Organization Unit of an insurance company's operations that may market, underwrite, and service the company's lines of business within a specified geographical area.	
Reinstatement	Reinstatement is a transaction that is applied to a policy to bring it back to actively insured status from a state where the policy was cancelled.	
Reinsurance Agreement	Reinsurance Agreement is a kind of Agreement between the Reinsurer and the Ceding Company that stipulates the manner in which the insurance liability written on various Risks insured by the Ceding Company is to be shared, and the cost of	

Entity Name	Entity Definition	Change
	the risk sharing to the Ceding Company.	
Reinsurance Recovery	Reinsurance Recovery is the act of providing the appropriate information and validation of a loss in order to receive payment from a reinsurance organization providing either facultative or treaty reinsurance.	
Renewal	Renewal is the action of continuing the coverage provided by a policy from one term to the next when the original term expires.	change
Residential Structure	A Residential Structure is an Insured Object that is used for human habitation.	
Risk Factor Score	Risk Factor Score is a kind of Assessment Result that evaluates and ranks orders the contribution a common factor has on the underlying Insurable Object.	change
Salvage	Salvage is the attempt by an Insurance Company to recover value from an object during the handling of a claim.	
Scheduled Item	A Scheduled Item is a kind of Insured Object that is specifically listed in a property insurance contract, and insured separately from the standard property insurance in order to receive the full value for a loss. Examples are: Expensive jewelry, furs, paintings, electronics, etc.	
Service Provider	Service Provider is a party that provides services to or for the insurance organization. Examples include: doctors, hospitals, laboratories, paramedics, garages, experts, vendors and other financial institutions.	
Short Rate	Short Rate is a subtype of Cancellation which is a subtype of Policy Event. Short Rate means that when a policy is cancelled, the returned amount of premium is less than the "pro rata" proportion of the time the policy was in effect.	
Staff	Staff is a Role played by a Person when working for compensation, whether direct or indirect, for another Party in return for stipulated services.	
Staff Classification	Staff Classification is a designation of staff persons as to benefit eligibility and level within an organization.	

Entity Name	Entity Definition	Change
Staff Position	Staff Position defines the specific job functions in the company.	
Staff Position Assignment	A Staff Position Assignment is an Organization Unit that is a particular position in an organization which has a job title, responsibilities, and salary range and may have other attributes such as office location, place in the reporting hierarchy, etc.	
Staff Role	Staff Role defines the position and status of a person in an organization for a period of time.	
Staff Work Assignment	Staff Work Assignment tracks the association between a staff person and a work area or work group within an organization. Example: a person works in an organization and is assigned to a project team.	
Staffing Agreement	A Staffing Agreement is a written Agreement between employer and employee, stating the terms of employment in an organization.	
Staffing Organization	A Staffing Organization (Employer) is a role played by a Party when that Party hires and pays wages, thereby providing a livelihood to individuals who perform work.	change
State	State provides a reference list of U.S. States and Canadian Provinces.	
Structure	A Structure is an Insured Object that is a man-made building or construction.	
Subcontractor	Subcontractor is a Role played by a Party to whom a General Contractor or other subcontractor sublets part or all of a contract.	
Subrogation	Subrogation is the legal process by which an insurance company, after paying a loss, seeks to recover the amount of the loss from another party who is legally liable for it.	change

Entity Name	Entity Definition	Change
Supplier	Supplier is a Role played by a Party who supplies materials, products, or services to others; firm in either the wholesale or the retail supply business.	
Surcharge	Surcharge is a charge imposed in excess of standard or normal charges for products and services provided during an insurance activity. The surcharge may be imposed by a governmental organization, an insurance company, or a third party providing goods and services during an insurance event.	
Tax	Tax is a charge imposed by a governmental organization on individual and organizations in exchange for governmental goods and services.	
Team	Team is a subtype example of a Grouping that is a subtype of Party.	
Team Leader	Team Leader is Role played by a Party responsible for running a project or managing a group of people that provide support.	
Team Member	Team Member is Role played by a Party assigned to a project or who is part of a work group that provides support.	
Territory	Territory is a subtype of Organization and is an example of how a company's organization structure can be represented as Party and Party Relationship.	
Third Party Administrator	Third Party Administrator is an organization that is not an insurance carrier but is contracted to provide administrative services on behalf of the insurance carrier.	
Third Party Staffing Agreement	Third Party Staffing Agreement is an example of Agreement with a third party to provide human resources for company.	
Tractor	Tractor is an Insurable Object that is a kind of Farm Equipment and is a powerful motor-driven vehicle with large, heavy treads used for pulling farm equipment.	
Trailer	A Trailer is an Insured Object that is pulled by another Vehicle and is used for transporting something.	
Transportation Class	Transportation Class is a subtype of Insurable Object that describes the kinds of Transportation being insured. Transportation is a type of "Inland Marine" insurance.	

Entity Name	Entity Definition	Change
Truck	A Truck is an Insured Object that is any of various motor vehicles designed for carrying or pulling loads.	
Underwriting Assessment	Underwriting Assessment is an evaluation provided by an Underwriter who is reviewing the proposed new or renewal policy to determine willingness to accept the risk. Items that might be evaluated are the limits of insurance being requested, the demographics of the location, the demographics of the requestor, the condition of the Insurable Object, etc.	
Van	A Van is an Insured Object that is a usually enclosed Vehicle used for the transportation of goods or animals.	
Vehicle	A Vehicle is an Insured Object that is a conveyance for transporting people and/or goods.	
Victim	Victim is a Role played by a Party who is affected by any kind of loss, condition or event that results in the submission of a claim.	
Watercraft	A Watercraft is an Insured Object that is a Vehicle made for transportation on water and primarily used for personal use. It may be motorized or may be manually propelled.	
Workers Comp Class	Workers Comp Class is a Job classification covered by a policy providing insurance coverage on medical and indemnity losses of employees of an organization.	
Authorization	see Approval	DELETED
Group	see Grouping	DELETED



### 3.2.3 Attribute Definitions

This section provides a listing of all attributes included in the P&C Data Model, and the text definition for each attribute. The attributes are listed in alphabetical order.

Attribute Name	Attribute Definition	Domain Name	Change
Account Identifier	Account Identifier is the unique identifier of an Account.	Account Identifier	
Account Name	Account Name is the wording used to name an Account.	Medium Name	
Account Type Code	Account Type Code represents the kind of account. Examples: Customer account, billing account, sales account.	Account Type Code	
Accounting Code	Accounting Code is the budget or general ledger code that can apply to any monies of a business.	Accounting Code	
Acronym Name	Acronym Name is an abbreviated version of an Organization's name. Example: IBM, SMS, NBC.	Short Name	
Aggregate Limit Amount	Aggregate Limit Amount is a limit of coverage that specifies the maximum amount (or other limit expression such as number of days) to be paid regardless of any other factor.	Amount	
Agreement Identifier	Agreement Identifier is the unique identifier of an Agreement.	Agreement Identifier	
Agreement Name	Agreement Name is the wording used to name an Agreement.	Medium Name	
Agreement Original Inception Date	Agreement Original Inception Date is the date that an agreement first became effective and is never changed.	Inception Date	
Agreement Type Code	Agreement Type Code represents an Agreement category. Examples: reinsurance agreement, commercial agreement, service agreement	Agreement Type Code	
Alternate Name	Alternate Name is an alias or additional name used by an Organization.	Long Name	
Altitude Mean Sea Level Value	Altitude Mean Sea Level Value is the average sea level height.	Medium Variable Value	
Altitude Value	Altitude Value is the vertical distance or height measured upward from sea level to a point in	Medium Variable Value	

Attribute Name	Attribute Definition	Domain Name	Change
	the atmosphere.		
Amount Type Code	Amount Type Code defines the category to which a monetary amount will be applied. Example: premium, commission, taxes, surcharge.	Amount Type Code	
Arbitration Description	Arbitration Description is the text that defines a dispute resolution mechanism designed to help aggrieved parties recover damages.	Long Description	change
Arbitration Identifier	Arbitration Identifier is the unique identifier of a dispute resolution mechanism designed to help aggrieved parties recover damages.	Arbitration Identifier	
Assessment Description	Assessment Description is text used to describe an Assessment such as a Person or Object.	Long Description	
Assessment Identifier	Assessment Identifier is the unique identifier of a grouping of Assessments such as a Person or Object.	Assessment Identifier	
Assessment Reason Description	Assessment Reason Description defines the reason for the Assessment such as Fraud or Credit Rating check.	Medium Description	
Assessment Result Identifier	Assessment Result Identifier is a unique identifier for the result of an assessment.	Assessment Result Identifier	
Assessment Result Type Code	Assessment Result Type Code represents the definition of the Result of an Assessment. Examples: Excellent Credit, Fraud Risk, Unfavorable Demographic Location	Assessment Result Type Code	
Begin Date	Begin Date is a date used throughout the model to reflect the best known date on which the related data was recorded or changed. It may be the date of change notification, the date of change was entered to a system (preferably the system of record), or the date that the related database was updated. The date that is used should be consistent throughout the implemented solution.	Begin Date	change

Attribute Name	Attribute Definition	Domain Name	Change
Birth Date	Birth Date is the year, month, and day that a person was born.	Date	
Birth Place Name	Birth Place Name is the city and state, province, prefecture, land, county (or other general areas) or country in which a person was born.	Medium Name	change
Branch Office Identifier	Branch Office Identifier is the Party ID for a Branch Office which is a subtype of Organization which is subtype of Party, and is an example of the use of Party to describe this lowest level of a company's organization structure.	Party Identifier	
Catastrophe Identifier	Catastrophe Identifier is the unique identifier for a Catastrophe.	Catastrophe Identifier	
Catastrophe Name	Catastrophe Name is the wording assigned to a catastrophe by regulatory agency or Insurance Company.	Medium Name	
Catastrophe Type Code	Catastrophe Type Code represents the type of severe loss characterized by extreme force and/or sizable financial loss.	Catastrophe Type Code	
Catastrophic Event Indicator	Catastrophic Event Indicator indicates that an occurrence is the result of a severe loss characterized by extreme force and/or sizable financial loss.	Indicator	
Claim Amount	Claim Amount is the financial amount reserved or paid in connection with a claim.	Amount	
Claim Amount Identifier	Claim Amount Identifier is the unique identifier of the financial amount reserved, paid, or collected in connection with a claim.	Claim Amount Identifier	
Claim Close Date	Claim Close Date is the date that a claim is considered resolved.	Date	
Claim Description	Claim Description is the text describing the circumstances which resulted in a claim.	Long Description	
Claim Folder Label Name	Claim Folder Label Name is the wording used to identify a Claim Folder.	Medium Name	
Claim Identifier	Claim Identifier is the unique identifier for a Claim.	Claim Identifier	
Claim Offer Identifier	Claim Offer Identifier is the unique identifier for a Claim Offer.	Claim Offer Identifier	

Attribute Name	Attribute Definition	Domain Name	Change
Claim Open Date	Claim Open Date is the date that a claim or sub claim file is set up and a potential claim is acknowledged.	Date	
Claim Reopen Date	Claim Reopen Date is the date a previously closed claim is reopened for further examination and additional handling.	Date	
Claim Reported Date	Claim Reported Date is the date a claim is filed and recorded by the Insurance carrier responsible for handling the claim.	Date	
Claim Status Code	Claim Status Code represents the current state of a claim setup and resolution. Example: Open, Pending Arbitration, In Litigation, Closed.	Claim Status Code	
Claims Made Date	Claims Made Date is the date on which claims were made during the extended reporting period of claims-made contracts.	Date	
Communication Identifier	Communication Identifier is the unique identifier for a communication specification used to contact a party, such as a telephone number or address.	Communication Identifier	
Communication Qualifier Value	Communication Qualifier Value further describes a communication specification such as a telephone extension, or a floor or room number within a building.	Long Variable Value	
Communication Type Code	Communication Type Code represents the kind of communication.	Communication Type Code	change
Communication Value	Communication Value is the value assigned to a communication mechanism. Examples: the characters of the phone number or email address.	Long Variable Value	change
Company Catastrophe Code	Company Catastrophe Code is the Code assigned to a Catastrophe by the Company.	Company Catastrophe Code	
Company Claim Number	Company Claim Number is the number or alpha-numeric assigned to a claim by the company.	Company Claim Number	
Company Code	Company Code represents a statutory insurance company. It can be self defined by the insurance company, or a standard code such as a NAIC company	Company Code	

Attribute Name	Attribute Definition	Domain Name	Change
	code.		
Company Description	Company Description is the text that describes the insurance company.	Code Description	
Company Identifier	Company Identifier is a unique identifier for a company.	Company Identifier	
Company Name	Company Name is the legal name of the insurance company.	Code Name	change
Company Subclaim Number	Company Subclaim Number is the number assigned by the company to identify a specific claim for a specific entity that is part of a larger claim.	Company Subclaim Number	
Country Code	Country Code is an abbreviation that is unique for each country.	Country Code	
Court Identifier	Court Identifier is a unique identifier for each court name and jurisdiction.	Court Identifier	
Court Name	Court Name is the official name of a court.	Medium Name	
Coverage Description	Coverage Description is a free form text definition of a coverage.	Long Description	
Coverage Group Description	Coverage Group Description is text that provides more detail about Coverage Group.	Medium Description	
Coverage Group Identifier	Coverage Group Identifier is a unique identifier for a Coverage Group.	Coverage Group Identifier	
Coverage Group Name	Coverage Group Name is the name given to the grouping of coverages.	Medium Name	
Coverage Identifier	Coverage Identifier is the unique identifier of a Coverage.	Coverage Identifier	
Coverage Inclusion Exclusion Code	Coverage Inclusion Exclusion Code designates whether a coverage is included or specifically excluded from the related insurance policy.	Coverage Inclusion Exclusion Code	
Coverage Label Name	Coverage Label Name is a consistent short name used to identify a coverage on documents and reports.	Long Name	
Coverage Level Identifier	Coverage Level Identifier is a unique identifier of the Coverage Level definition.	Coverage Level Identifier	
Coverage Limit Description	Coverage Limit Description is the textual description of the Coverage Limit.	Medium Description	

Attribute Name	Attribute Definition	Domain Name	Change
Coverage Limit Name	Coverage Limit Name is the name given to the Coverage Limit Type, e.g. Specified Amount, Insurance to Value.	Medium Name	
Coverage Limit Type Identifier	Coverage Limit Type Identifier is a unique identifier of a Coverage Limit Type.	Coverage Limit Type Identifier	
Coverage Name	Coverage Name is the wording used to name a coverage.	Long Name	
Coverage Part Code	Coverage Part Code is an abbreviation for the Coverage Part of an insurance policy.	Coverage Part Code	
Coverage Part Name	Coverage Part Name is the wording used to distinguish a Coverage Part of a policy.	Medium Name	
Coverage Type Description	Coverage Type Description is the textual description of the Coverage Type.	Code Description	
Coverage Type Identifier	Coverage Type Identifier is the unique identifier of a coverage category	Coverage Type Identifier	
Coverage Type Name	Coverage Type Name is the name given to the Coverage Type, e.g. Liability, Property, No Fault.	Medium Name	
Deductible Basis Code	Deductible Basis Code identifies whether the related Deductible Value is an amount or a percentage or number of days, etc. that will be used to determine what an insured person is expected to pay before reimbursement from the insurance company begins.	Deductible Basis Code	
Deductible Rate	Deductible Rate is a rating factor used to calculate the premium charge for the deductible based on the Coverage Level and Deductible selected.	Rate	
Deductible Type Code	Deductible Type Code represents the kind of deductible, such as per occurrence, per person, etc.	Deductible Type Code	
Deductible Value	Deductible Value is the actual monetary amount, percentage or time period. Examples: \$500, 10%, 90 days.	Deductible Value	
Department Identifier	Department Identifier is a subtype of Party Identifier for an Organization that is a Department.	Organization Identifier	

Attribute Name	Attribute Definition	Domain Name	Change
Document Link Value	Document Link Value is an electronic address that identifies the location of a document.	Long Variable Value	
Document Sequence Number	Document Sequence Number defines the order in which documents are presented.	Sequence Number	
Dun And Bradstreet Identifier	Dun and Bradstreet Identifier is the unique DUNS Number identifier assigned to a legal entity by Dun & Bradstreet.	Dun And Bradstreet Identifier	
Earning Begin Date	Earning Begin Date is the date on which earnings will start to be recorded and accumulated for the associated Policy Amount.	Begin Date	
Earning End Date	Earning End Date is the date on which earnings will stop being recorded and accumulated for the associated Policy Amount.	End Date	
Effective Date	Effective Date is a point in time for when a contractual provision commences or goes into effect.	Effective Date	
End Date	End Date is the year, month, and day on which the associated data is no longer relevant or is scheduled to stop.	End Date	
Entry Into Claims Made Program Date	Entry Into Claims Made Program Date is the date that the insured registered with the claims made program.	Date	
Event Date	Event Date is the date on which a transaction or insurance-related happening takes place.	Event Date	
Event Identifier	Event Identifier is a unique identifier of an Event.	Event Identifier	
Event Sub Type Code	Event Sub Type Code represents a lower categorization of an event. Examples: within a policy event are renewal and cancellation.	Event Sub Type Code	
Event Type Code	Event Type Code represents the kind of an event. Examples: life event, business event, policy event or loss event.	Event Type Code	
Expiration Date	Expiration Date is the year, month, and day when a contractual term or coverage is ended or when a policy expires.	Expiration Date	
First Name	First Name is the given name of a Person Party.	Short Name	

Attribute Name	Attribute Definition	Domain Name	Change
Form Value	Form Value is the set of characters used to identify an attachment to a property and casualty policy that makes it operative.	Policy Form Value	
Full Legal Name	Full Legal Name is the name of a Person or Organization party, spelled out in full. Example: John D. Smith, Ph.D.	Medium Name	
Gender Code	Gender Code represents the sex of an Individual. Values are F= Female, M = Male and U = Unknown or Not Applicable.	Gender Code	
Geographic Location Identifier	Geographic Location Identifier is the unique identifier of a bounded area defined by nature, by an external authority (such as a government) or for an internal business purpose. Used to identify a location in space that is not a structured address, for example: country, city, continent, postal area, risk area.	Geographic Location Identifier	
Geographic Location Type Code	Geographic Location Type Code represents the type of Geographic Location, e.g. a State or a county, or a building location.	Geographic Location Type Code	
Grouping Identifier	Group Identifier is the unique Party Identifier of a Group, which is a subtype of Party.	Grouping Identifier	NEW
Grouping Name	Group Name is the name assigned to a Group.	Medium Name	NEW
Horizontal Accuracy Value	Horizontal Accuracy Value defines the horizontal location for a property, e.g. 1.000 feet from the hydrant.	Medium Variable Value	
Household Identifier	Household Identifier is the unique identifier of a Household, and, as a subtype of Group, is also a Group and Party Identifier.	Grouping Identifier	
Industry Catastrophe Code	Industry Catastrophe Code is a code assigned by regulatory agency to identify a single major loss occurring on a specified date or to a single loss incurred over a number of days.	Industry Catastrophe Code	
Industry Code	Industry Code is an external classification of industries, such as	Industry Code	



Attribute Name	Attribute Definition	Domain Name	Change
	an SIC (Standard Industry Classification Code). Example: 63nnnnnn is the classification series for Insurance Carriers.		
Industry Type Code	Industry Type Code represents an Industry category that is important to the company. Example: Financial Institution, Healthcare.	Industry Type Code	
Insurable Object Identifier	Insurable Object Identifier is the unique identifier of an item relevant to an Insurance coverage or policy as an inclusion or an exclusion.	Insurable Object Identifier	change
Insurable Object Type Code	Insurable Object Type Code represents a category of an item figuring in an insurance coverage or policy, having commercial or exchange value that is owned by a business, institution, or individual or adds to one's wealth or estate. These objects can be real (land and attachments) and personal (movable effects not attached to land).	Insurable Object Type Code	
Insurance Class Description	Insurance Class Description is the textual description of the Insurance Class.	Code Description	change
Insurance Class Identifier	Insurance Class Identifier is the unique identifier for an Insurance Class.	Insurance Class Identifier	change
Insurance Class Name	Insurance Class Name is the name given to the Insurance Class.	Code Name	
Insurance Type Code	Insurance Type Code represents the category under which risk is assumed. Examples: Direct for policies directly issued by a company; Assumed for risks assumed from another company; Ceded for portions of risk ceded to another insurer.	Insurance Type Code	change
Jurisdiction Identifier	Jurisdiction Identifier uniquely identifies a geographic or topical area of authority for a specific government entity.	Jurisdiction Identifier	

Attribute Name	Attribute Definition	Domain Name	Change
Last Name	Last Name is the family name of an Individual Party.	Short Name	
Latitude Value	Latitude Value is the value on a grid of the globe that locates the point horizontally East to West.	Latitude Or Longitude	
Legal Classification Code	Legal Classification Code represents a legal category under which the Party can operate.	Legal Classification Code	
Legal Entity Type Code	Legal Entity Type Code represents a category of person or organization that has the legal standing to enter into a contract and may be sued for failure to perform as agreed in the contract. It can be a type of partnership, corporation, or other organization having the capacity to negotiate contracts, assume financial obligations, and pay off debts. Examples: Stock, Mutual, Fraternal, Reciprocal Exchange.	Legal Entity Type Code	
Legal Jurisdiction Description	Legal Jurisdiction Description defines a geographic or topical area of authority for a specific government entity.	Code Description	
Legal Jurisdiction Identifier	Legal Jurisdiction Identity uniquely identifies a geographic or topical area of authority for a specific government entity.	Legal Jurisdiction Identifier	
Legal Jurisdiction Name	Legal Jurisdiction Name is the wording assigned to a geographic or topical area of authority for a specific government entity.	Code Name	

Attribute Name	Attribute Definition	Domain Name	Change
Legal Jurisdiction Party Identifier	Legal Jurisdiction Party Identifier is the Legal Jurisdiction's Identifier for a Party. Example: State of PA. Taxpayer ID for a Company.	Legal Jurisdiction Party Identifier	
Licensed Product Name	Licensed Product Name is the name given to an offering of protection against a risk or a service related to protection that has been authorized by a regulatory agency to be marketed to the public.	Medium Name	
Limit Basis Code	Limit Basis Code represents the basis on which to specify the maximum extent of coverage that will be provided by an insurance policy. Examples: Amount, Percentage, Days.	Limit Basis Code	
Limit Type Code	Limit Type Code represents a category of limit coverage that will be provided by an insurance policy. Examples: Per Occurance, Per Person.	Limit Type Code	
Limit Value	Limit Value is the actual limit amount or percentage that will be provided by an insurance policy.	Limit Value	
Line 1 Address	Line 1 Address is the initial line of an address usually providing a building identifier and a street.	Medium Address	
Line 2 Address	Line 2 Address is the second line of an address that further qualifies an address. Example: XYZ Building Suite 123 or Apt F.	Medium Address	
Line Of Business Code	Line Of Business Code represents the line of business, or how the insured wants to track their products, e.g. CP - Commercial Property, CA - Commercial Auto.	Line Of Business Code	
Line Of Business Description	Line Of Business Description is the textual description of the line of business coverage, e.g. Commercial Property, Commercial Auto.	Code Description	

Attribute Name	Attribute Definition	Domain Name	Change
Line Of Business Group Description	Line Of Business Group Description is the textual description of the Line of business group.	Code Description	
Line Of Business Group Identifier	Line Of Business Group Identifier is a unique identifier for a set of Lines of Business that can be grouped for reporting and analysis.	Line Of Business Group Identifier	
Line Of Business Group Name	Line Of Business Group Name is the textual description of Line of Business Group.	Code Name	
Line Of Business Identifier	Line Of Business Identifier uniquely identifies a major kind of insurance product, such as automobile, business owners, etc.	Line Of Business Identifier	
Line Of Business Name	Line Of Business Name is the identifying label given to a line of business by the company, or by insurance organizations and regulators. Examples: P&C, Oil & Natural Gas, Fixed Income Investments.	Code Name	change
Litigation Description	Litigation Description is the text verbiage used to define the type or extent of litigation.	Long Description	
Litigation Identifier	Litigation Identifier uniquely identifies a process of filing a lawsuit in the appropriate jurisdiction to settle a legal dispute or controversy through which legal rights are sought to be determined and enforced.	Litigation Identifier	
Location Address Identifier	Location Address Identifier is assigned by the insurance carrier to uniquely identify a physical site that generally includes street number, street, city, state/province, postal code, and country. This location can be a structure that contains a home, commercial building, vehicle or items to be insured, as well as a site where a party can receive mail.	Location Address Identifier	
Location Code	Location Code is assigned externally by an insured party to represent one of their locations.	Location Code	
Location Name	Location Name is the wording assigned to name a place.	Medium Name	

Attribute Name	Attribute Definition	Domain Name	Change
Location Number	Location Number is a number assigned and used internally by an insured party to identify one of their locations.	Medium Variable Value	
Longitude Value	Longitude Value is the value on a grid of the globe that locates the point Vertically north to south.	Latitude Or Longitude	
Maximum Per Claim Amount	Maximum Per Claim Amount is the Limit that can be paid for any single event for which a claim is reported. This amount is inclusive of all coverage provided by an insurance policy.	Amount	
Maximum Per Person Amount	Maximum Per Person Amount is the Limit that can be paid to any person for the specified coverage per claim.	Amount	
Middle Name	Middle name is a second name used by an individual to further differentiate their name, and is often represented with an initial.	Short Name	
Municipality Name	Municipality Name is the wording used to identify limited geographic area responsible for maintenance of throughways as well as a myriad of public services.	Medium Name	
Nickname	Nickname is a shorter version of a person's name or an alternate name by which the person prefers to be addressed. Example: Bill for William.	Short Name	
Occurrence Begin Date	Occurrence Begin Date is the date that a potential loss event commenced.	Begin Date	
Occurrence Begin Time	Occurrence Begin Time is the time of day at which a potential loss event commenced.	Time	
Occurrence End Date	Occurrence End Date is the date that marks the ending of an event occurrence.	End Date	
Occurrence End Time	Occurrence End Time is the time of day at which an event occurrence ceased.	Time	
Occurrence Identifier	Occurrence Identifier uniquely identifies an event occurrence.	Occurrence Identifier	
Occurrence Name	Occurrence Name is the wording used to provide a familiar label for an event occurrence.	Medium Name	

Attribute Name	Attribute Definition	Domain Name	Change
Organization Description	Organization Description is text used to describe an Organization.	Long Description	
Organization Identifier	Organization Identifier is the unique Party Identifier that is role-named to clarify the party as an organization.	Organization Identifier	
Organization Name	Organization Name is the wording used to identify an Organization and should be the legal name for the organization.	Medium Name	
Organization Type Code	Organization Type Code is used to distinguish various types of internal and external organization.	Organization Type Code	
Organization Unit Description	Organization Unit Description provides distinguishing characteristics for the specific unit.	Medium Description	
Organization Unit Name	Organization Unit Name is the formal and distinct name for an organization unit within an overall Organization.	Medium Name	
Parent Geographic Location Identifier	Parent Geographic Location Identifier is the unique identifier of a recursive higher level bounded area defined by nature, by an external authority (such as a government) or for an internal business purpose. Used to identify a location in space that is not a structured address, for example: country, city, continent, postal area, risk area.	Geographic Location Identifier	
Party Identifier	Party Identifier is a unique identifier of Person, Organization or Grouping that can enter into a contract or other legal proceeding, and plays a role in the insurance industry.	Party Identifier	
Party Locality Code	Party Locality Code represents the physical location of the party.	Locality Code	
Party Name	Party Name is the wording used to name and (at least partially) identify a Person, Organization or Grouping that can enter into a contract or other legal proceeding, or play a role in the insurance industry.	Medium Name	
Party Role Code	Party Role Code is an abbreviation of name of the role that a Party plays with respect to another entity.	Party Role Code	change

Attribute Name	Attribute Definition	Domain Name	Change
Party Role Description	Party Role Description is text that defines how a Party relates to another entity.	Code Description	
Party Role Name	Party Role Name is the wording used to label a Party Role.	Code Name	
Party Routing Description	Party Routing Description is the text definition of how information is to be sent to a party.	Medium Description	
Party Type Code	Party Type Code is an abbreviation that defines the kind of Party. Example: Person, Organization, Grouping.	Party Type Code	
Person Identifier	Person Identifier is the unique Party Identifier that is role-named to clarify the party as a person.	Person Identifier	
Physical Location Identifier	Physical Location Identifier is the unique identifier for a Physical Location.	Physical Location Identifier	
Physical Location Name	Physical Location Name is name given to the physical location of the property, e.g. Rockefeller Center.	Medium Name	
Policy Amount	Policy Amount is the monetary value of the insurance coverage premium, fees, commissions and related expenses (such as taxes and surcharges) for a policy.	Amount	
Policy Amount Identifier	Policy Amount Identifier is the unique identifier of the monetary value of the insurance coverage premium, fees, commissions and related expenses (such as taxes and surcharges) for a policy.	Policy Amount Identifier	
Policy Coverage Detail Identifier	Policy Coverage Detail Identifier is the unique identifier of each of the specific coverages within a Policy.	Policy Coverage Detail Identifier	
Policy Deductible Identifier	Policy Deductible Identifier is the unique identifier of the amount of money that the policyholders must pay out of their pockets before reimbursements from the insurance company begin.	Policy Deductible Identifier	
Policy Form Number	Policy Form Number is the number assigned to the policy form that identifies the form.. This is usually established by the state or by ISO (Insurance Services Office)	Policy Form Value	NEW

Attribute Name	Attribute Definition	Domain Name	Change
Policy Identifier	Policy Identifier is the unique identifier of a policy.	Agreement Identifier	
Policy Limit Identifier	Policy Limit Identifier is the unique identifier for each limit for each coverage, or for the entire policy, that is provided by an insurance policy.	Policy Limit Identifier	
Policy Number	Policy Number is the external identification for a policy.	Policy Number Value	
Postal Code	Postal Code represents an alphanumeric code assigned to groups of addresses by various national postal systems throughout the world to facilitate mail delivery.	Postal Code	
Preference Day And Time Group Code	Preference Day and Time Group Code represents the day and/or time that a party prefers to be contacted.	Day And Time Group Code	
Preference Sequence Number	Preferred Sequence Number is a relatively assigned order of an entry listed within another qualifying attribute for a Party's preference.	Sequence Number	
Preferred Language Code	Preferred Language Code is the designation for the language of choice for an Organization, Person, or Grouping.	Language Code	
Prefix Name	Prefix Name is the title added to the beginning of a name to further qualify. Examples: Mr., Mrs., Ms, Dr.	Prefix-Suffix Name	
Product Description	Product Description is the free form text definition that describes a product.	Medium Description	
Product Identifier	Product Identifier is the unique identifier for a product.	Product Identifier	
Profession Name	Profession Name is the wording used to describe how an individual earns a living. Examples: Doctor, Lawyer, Teacher, Carpenter, Entertainer.	Medium Name	
Rating Territory Assigning Organization Identifier	Rating Territory Assigning Organization Identifier is the Party Identifier of the Organization that manages the Rating Territory being defined.	Organization Identifier	
Rating Territory	Rating Territory Code represents a	Rating Territory Code	



Attribute Name	Attribute Definition	Domain Name	Change
Code	geographic area that is used to determine insurance rates.		
Rating Territory Code Set Identifier	Rating Territory Code Set Identifier is the unique identifier for a set of Rating Territory Codes.	Rating Territory Code Set Identifier	
Rating Territory Identifier	Rating Territory Identifier is the unique identifier for a Rating Territory.	Rating Territory Identifier	
Regional Office Identifier	Regional Officer Identifier is a Party Identifier for a Regional Office that can be a subtype of Organization which is subtype of Party and is an example of the use of Party to describe a company's organization structure.	Party Identifier	
Related Party Identifier	Related Party Identifier is the unique identifier of a relationship between one party and another party.	Party Identifier	
Related Policy Identifier	Related Policy Identifier is the unique identifier of a policy that is related to another policy.	Agreement Identifier	
Relationship Begin Date	Relationship Begin Date is the best known date on which a relationship began.	Begin Date	
Relationship Code	Relationship Code represents a relationship that ties entities together.	Relationship Code	
Relationship Type Code	Relationship Type Code represents the kind of relationship that links one entity to another. Example: Business, Family, Reporting.	Relationship Type Code	
Role Begin Date	Role Begin Date is the best known date on which a role of a person or organization or grouping begins.	Begin Date	
Rules Reference Description	Rules Reference Description is the text used to refer or link to rules related to the entity.	Long Description	
Settlement Offer Amount	Settlement Offer Amount is the compensation offered by the insurance carrier to settle an insured's claim.	Amount	
Settlement Offer Provision Description	Settlement Offer Provision Description is the text definition of a settlement offer provision.	Long Description	
Staff Classification Code	Staff Classification Code represents classes of employees versus consultants, based on part and full time, benefit eligibility, etc.	Staff Classification Code	

Attribute Name	Attribute Definition	Domain Name	Change
	for a staff person.		
Staff Classification Description	Staff Classification Description is the full position description.	Medium Description	
Staff Classification Name	Staff Classification Name is the official name for the related Staff Classification Code.	Code Name	
Staff Position Description	Staff Position Description is the full position description	Code Description	
Staff Position Identifier	Staff Position Identifier is the unique identifier for a Staff Position that is a specific job function.	Staff Position Identifier	
Staff Position Name	Staff Position Name is the job or role title.	Code Name	
State Code	State Code is a two character representation of a U.S. state or Canadian Province.	State Code	
State Name	State Name is the given name of the State, e.g. Pennsylvania, New York.	Code Name	
Status Code	Status Code represents the state of the related entity at a point in time. Examples: A = Active, P = Pending, C = Cancelled, T = Terminated.	Status Code	
Suffix Name	Suffix Name is an extension added to the end of a name to further qualify it. Examples: M.D, PhD, Jr, Sr, III.	Prefix-Suffix Name	
Territory Identifier	Territory Identifier is a subtype of Organization which is subtype of Party and is an example of the use of Party to describe a company's organization structure. The Territory definition is often used for marketing or sales territories.	Party Identifier	
Travel Direction Description	Travel Direction Description provides the instructions for driving to a particular location.	Medium Description	
Vehicle Driving Wheel Quantity	Vehicle Driving Wheel Quantity if the number of wheels that control the vehicle, (2 or 4).	Quantity	
Vehicle Identification Number	Vehicle Identification Number (VIN) in an alphanumeric series that includes make, model, and serial number for each vehicle.	Medium Variable Value	
Vehicle Make Name	Vehicle Make Name is the market brand name for the maker of the	Short Name	

Attribute Name	Attribute Definition	Domain Name	Change
	vehicle. Example: Ford, Toyota.		
Vehicle Model Name	Vehicle Model Name is the market name for type of vehicle. Example: Accord EX, Blazer.	Short Name	
Vehicle Model Year	Vehicle Model Year is the annual series of vehicle model manufacturing. Example; 2010 model year vehicles may be manufactured from mid 2009 through mid 2010.	Year	
Vertical Accuracy Value	Vertical Accuracy Value is the height of a location, for example 4,000 foot height up the mountain.	Medium Variable Value	
Work Site Type Code	Work Site Type Code defines the kind of workplace. Example: Office Building, Plant, Farm.	Work Site Type Code	

### 3.2.4 Relationship Definitions

This section provides a listing of all relationships included in the P&C Data Model, and the text definition for each relationship. The relationships are listed in alphabetical order by Parent Entity.

Parent Entity Name	Parent to Child Phrase	Relationship Cardinality	Child Entity Name	Relationship Type	Charge
Account	can be a	Zero-to-One	Insured Account	Subtype	change
Account	has party function defined in	One-to-Zero-One-or-More	Account Party Role	Identifying	
Account	groups	One-to-Zero-One-or-More	Account Agreement	Identifying	
Account Role	can be a	Zero-to-One	Prospect	Subtype	change
Account Role	can be a	Zero-to-One	Customer	Subtype	change
Adjuster	can be a	Zero-to-One	Public Adjuster	Subtype	change
Adjuster	can be a	Zero-to-One	Inhouse Adjuster	Subtype	change
Adjuster	can be a	Zero-to-One	Independent Adjuster	Subtype	change
Administrative Organization Unit	divides into	One-to-Zero-One-or-More	Department	Identifying	
Agreement	can be a	Zero-to-One	Reinsurance Agreement	Subtype	change
Agreement	can be a	Zero-to-One	Financial Account Agreement	Subtype	change
Agreement	can be a	Zero-to-One	Brokerage Contract	Subtype	change
Agreement	can be a	Zero-to-One	Policy	Subtype	change
Agreement	can be a	Zero-to-One	Agency Contract	Subtype	change

Parent Entity Name	Parent to Child Phrase	Relationship Cardinality	Child Entity Name	Relationship Type	Charge
Agreement	can be a	Zero-to-One	Individual Agreement	Subtype	change
Agreement	can be a	Zero-to-One	Intermediary Agreement	Subtype	change
Agreement	can be a	Zero-to-One	Auto Repair Shop Contract	Subtype	change
Agreement	defines	One-to-One-or-More (P)	Agreement Party Role	Identifying	
	party				
	responsibility				
	in				
Agreement	can be a	Zero-to-One	Commutation Agreement	Subtype	change
Agreement	can be a	Zero-to-One	Provider Agreement	Subtype	change
Agreement	can be a	Zero-to-One	Staffing Agreement	Subtype	change
Agreement	subject to	One-to-Zero-One-or-More	Agreement Assessment	Identifying	
Agreement	related to account in	One-to-Zero-One-or-More	Account Agreement	Identifying	
Agreement	can be a	Zero-to-One	Group Agreement	Subtype	change
Agreement	can be a	Zero-to-One	Commercial Agreement	Subtype	change
Agreement	can be a	Zero-to-One	Derivative Contract	Subtype	change
Agreement Role	can be a	Zero-to-One	Service Provider	Subtype	change
Agreement Role	can be a	Zero-to-One	Channel Role	Subtype	change
Agreement Role	can be a	Zero-to-One	Producer	Subtype	change
Agreement Role	can be a	Zero-to-One	Financial Interest Role	Subtype	change

Parent Entity Name	Parent to Child Phrase	Relationship Cardinality	Child Entity Name	Relationship Type	Charge
Agreement Role	can be a	Zero-to-One	Supplier	Subtype	change
Arbitration	defines party function in	One-to-Zero-One-or-More	Arbitration Party Role	Identifying	
Arbitration	is concerned with	One-to-Zero-One-or-More	Claim Arbitration	Identifying	
Arbitration	is context for	Zero-or-One-to-Zero-One-or-More	Claim Offer	Non-identifying	
Assessment	is about	One-to-Zero-One-or-More	Claim Assessment	Identifying	
Assessment	is about	One-to-Zero-One-or-More	Agreement Assessment	Identifying	
Assessment	is about	One-to-Zero-One-or-More	Object Assessment	Identifying	
Assessment		One-to-Zero-One-or-More	Assesment Party Role	Identifying	
Assessment	is about	One-to-Zero-One-or-More	Party Assessment	Identifying	
Assessment	results in	Zero-or-One-to-Zero-One-or-More	Assessment Result	Non-identifying	
Assessment Result	can be a	Zero-to-One	Claim Evaluation Result	Subtype	change
Assessment Result	can be a	Zero-to-One	Underwriting Assessment	Subtype	change
Assessment Result	can be a	Zero-to-One	Financial Services Assessment	Subtype	change
Assessment Result	can be a	Zero-to-One	Demographic Score	Subtype	change
Assessment Result	can be a	Zero-to-One	Financial Valuation	Subtype	change
Assessment Result	can be a	Zero-to-One	Medical Condition	Subtype	change
Assessment Result	can be a	Zero-to-One	Other Assessment Result	Subtype	change
Assessment Result	can be a	Zero-to-One	Physical Object Assessment	Subtype	change
Assessment Result	can be a	Zero-to-One	Place Assessment	Subtype	change

Parent Entity Name	Parent to Child Phrase	Relationship Cardinality	Child Entity Name	Relationship Type	Charge
Assessment Result	can be a	Zero-to-One	Risk Factor Score	Subtype	change
Assessment Result	can be a	Zero-to-One	Approval	Subtype	change
Assessment Result	can be a	Zero-to-One	Channel Score	Subtype	change
Assessment Result	can be a	Zero-to-One	Fraud Assessment	Subtype	change
Assessment Result	can be a	Zero-to-One	Credit Rating	Subtype	change
Assessment Result	can be a	Zero-to-One	Customer Score	Subtype	change
Auditor	can be a	Zero-to-One	Premium Auditor	Subtype	change
Body Object	can be a	Zero-to-One	Animal	Subtype	change
Cancel	can be a	Zero-to-One	Short Rate	Subtype	change
Cancel	can be a	Zero-to-One	Pro Rata	Subtype	change
Cancel	can be a	Zero-to-One	Flat	Subtype	change
Catastrophe	results in	Zero-or-One-to-Zero-One-or-More	Claim	Non-identifying	
Claim	documented in	One-to-Zero-One-or-More	Claim Folder	Identifying	
Claim	links to arbitration in	One-to-Zero-One-or-More	Claim Arbitration	Identifying	
Claim	linked to	One-to-Zero-One-or-More	Claim Coverage	Identifying	
Claim	settlement results in	One-to-Zero-One-or-More	Claim Amount	Non-identifying	
Claim	Contains subclaim in	Zero-or-One-to-Zero-One-or-More	Claim	Non-identifying	
Claim	Defines party responsibility in	One-to-Zero-One-or-More	Claim Party Role	Identifying	
Claim	is context for	One-to-Zero-One-or-	Litigation Party Role	Identifying	

Parent Entity Name	Parent to Child Phrase	Relationship Cardinality	Child Entity Name	Relationship Type	Charge
		More			
Claim	is context for	One-to-Zero-One-or-More	Arbitration Party Role	Identifying	
Claim	subject to	One-to-Zero-One-or-More	Claim Assessment	Identifying	
Claim	links to litigation in	One-to-Zero-One-or-More	Claim Litigation	Identifying	
Claim Amount	can be a	Zero-to-One	Ceded Claim Amount	Subtype	change
Claim Amount	can be a	Zero-to-One	Debit Claim Amount	Subtype	change
Claim Amount	can be a	Zero-to-One	Recovery	Subtype	change
Claim Amount	can be a	Zero-to-One	Credit Claim Amount	Subtype	change
Claim Amount	can be a	Zero-to-One	Claim Payment	Subtype	change
Claim Amount	can be a	Zero-to-One	Direct Claim Amount	Subtype	change
Claim Amount	can be a	Zero-to-One	Assumed Claim Amount	Subtype	change
Claim Amount	can be a	Zero-to-One	Claim Reserve	Subtype	change
Claim Folder	contains	One-to-Zero-One-or-More	Claim Offer	Non-identifying	
Claim Folder	contains	One-to-Zero-One-or-More	Claim Folder Document	Identifying	
Claim Offer	results in	Zero-or-One-to-Zero-One-or-More	Claim Amount	Non-identifying	
Claim Payment	can be a	Zero-to-One	Loss Payment	Subtype	change
Claim Payment	can be a	Zero-to-One	Expense Payment	Subtype	change
Claim Reserve	can be a	Zero-to-One	Loss Reserve	Subtype	change
Claim Reserve	can be a	Zero-to-One	Expense Reserve	Subtype	change
Claim Role	can be a	Zero-to-One	Claim Witness	Subtype	change
Claim Role	can be a	Zero-to-One	Loss Payee	Subtype	change
Claim Role	can be a	Zero-to-One	Patient	Subtype	change



Parent Entity Name	Parent to Child Phrase	Relationship Cardinality	Child Entity Name	Relationship Type	Charge
Claim Role	can be a	Zero-to-One	Claimee	Subtype	change
Claim Role	can be a	Zero-to-One	Claim Examiner	Subtype	change
Claim Role	can be a	Zero-to-One	Claim Legal Expert	Subtype	change
Claim Role	can be a	Zero-to-One	Claim Administrator	Subtype	change
Claim Role	can be a	Zero-to-One	Claim Fraud Examiner	Subtype	change
Claim Role	can be a	Zero-to-One	Driver	Subtype	change
Claim Role	can be a	Zero-to-One	Claim Expert	Subtype	change
Claim Role	can be a	Zero-to-One	Claim Representative	Subtype	change
Claim Role	can be a	Zero-to-One	Victim	Subtype	change
Claim Role	can be a	Zero-to-One	Claimant	Subtype	change
Communication Identity	is contact point for	One-to-Zero-One-or-More	Party Communication	Identifying	
Company	conducts business in	One-to-Zero-One-or-More	Company Jurisdiction	Identifying	

Parent Entity Name	Parent to Child Phrase	Relationship Cardinality	Child Entity Name	Relationship Type	Charge
Company Jurisdiction	grants	One-to-Zero-One-or-More	Product License	Identifying	
Contractor	can be a	Zero-to-One	Subcontractor	Subtype	change
Court Jurisdiction	Conducts proceedings for	Zero-or-One-to-Zero-One-or-More	Litigation	Non-identifying	
Coverage	applies to	One-to-Zero-One-or-More	Product Coverage	Identifying	
Coverage	offered at	One-to-Zero-One-or-More	Coverage Level	Identifying	
Coverage	is defined for policy in	One-to-Zero-One-or-More	Policy Coverage Detail	Non-identifying	
Coverage Group	consolidates	Zero-or-One-to-Zero-One-or-More	Coverage	Non-identifying	
Coverage Limit Type	defines	One-to-Zero-One-or-More	Coverage Level	Identifying	
Coverage Part	defines major policy section in	One-to-Zero-One-or-More	Policy Coverage Part	Identifying	
Coverage Part	defines major section for	Zero-or-One-to-Zero-One-or-More	Coverage	Non-identifying	
Coverage Type	categorizes	Zero-or-One-to-Zero-One-or-More	Coverage	Non-identifying	
Endorsement	can be a	Zero-to-One	Mid Term	Subtype	change
Endorsement	can be a	Zero-to-One	Audit	Subtype	change
Endorsement	can be a	Zero-to-One	Full Term	Subtype	change
Event	can be a	Zero-to-One	Claim Event	Subtype	change
Event	can be a	Zero-to-One	Policy Event	Subtype	change
Event	can be a	Zero-to-One	Life Event	Subtype	change

Parent Entity Name	Parent to Child Phrase	Relationship Cardinality	Child Entity Name	Relationship Type	Charge
Event	can be a	Zero-to-One	Business Event	Subtype	change
Farm Equipment	can be a	Zero-to-One	Tractor	Subtype	change
Farm Equipment	can be a	Zero-to-One	Milking Machine	Subtype	change
Farm Equipment	can be a	Zero-to-One	Combine	Subtype	change
Field Organization Unit	divides into	One-to-Zero-One-or-More	Territory	Identifying	
Financial Interest Role	can be a	Zero-to-One	Insured	Subtype	change
Financial Interest Role	can be a	Zero-to-One	Insurer	Subtype	change
Financial Interest Role	can be a	Zero-to-One	Additional Interest	Subtype	change
Financial Service	can be a	Zero-to-One	Financial Analyst	Subtype	change
Financial Service	can be a	Zero-to-One	Financial Adviser	Subtype	change
Financial Service	can be a	Zero-to-One	Account Provider	Subtype	change
Geographic Location	is site for	Zero-or-One-to-Zero-One-or-More	Communication Identity	Non-identifying	
Geographic Location	comprises	One-to-Zero-One-or-More	Rating Territory Geographic Location	Identifying	
Geographic Location	defines jurisdiction for	One-to-Zero-One-or-More	Company Jurisdiction	Identifying	
Geographic Location	is factored into	One-to-Zero-One-or-More	Policy Amount	Non-identifying	

Parent Entity Name	Parent to Child Phrase	Relationship Cardinality	Child Entity Name	Relationship Type	Charge
Geographic Location	is site of	Zero-or-One-to-Zero-One-or-More	Occurrence	Non-identifying	
Geographic Location	defines statutory location for	Zero-or-One-to-Zero-One-or-More	Policy	Non-identifying	
Geographic Location	is site of	Zero-or-One-to-One-or-More (P)	Insurable Object	Non-identifying	
Geographic Location	is within	Zero-or-One-to-Zero-One-or-More	Geographic Location	Non-identifying	
Grouping	defines	One-to-Zero-One-or-More	Staff Work Assignment	Identifying	
Grouping	can be a	Zero-to-One	Professional Group	Subtype	change
Grouping	can be a	Zero-to-One	Team	Subtype	change
Grouping	can be a	Zero-to-One	Household	Subtype	change
Grouping	can be a	Zero-to-One	Project	Subtype	change
Household	includes	One-to-Zero-One-or-More	Household Person	Identifying	
Household	contains	Zero-or-One-to-Zero-One-or-More	Household Content	Non-identifying	
Household Person	has function defined in	One-to-Zero-One-or-More	Household Person Role	Identifying	
Insurable Object	is factored into	Zero-or-One-to-Zero-One-or-More	Policy Amount	Non-identifying	
Insurable Object	can be a	Zero-to-One	Manufactured Object	Subtype	change

Parent Entity Name	Parent to Child Phrase	Relationship Cardinality	Child Entity Name	Relationship Type	Charge
Insurable Object	is covered as defined in	One-to-Zero-One-or-More	Policy Coverage Detail	Non-identifying	
Insurable Object	can be a	Zero-to-One	Transportation Class	Subtype	change
Insurable Object	has party interest defined in	One-to-Zero-One-or-More	Insurable Object Party Role	Identifying	
Insurable Object	can be a	Zero-to-One	Farm Equipment	Subtype	change
Insurable Object	involved in	Zero-or-One-to-Zero-One-or-More	Claim	Non-identifying	
Insurable Object	can be a	Zero-to-One	Body Object	Subtype	change
Insurable Object	can be a	Zero-to-One	Structure	Subtype	change
Insurable Object	subject to	One-to-Zero-One-or-More	Object Assessment	Identifying	
Insurable Object	can be a	Zero-to-One	Vehicle	Subtype	change
Insurable Object	can be a	Zero-to-One	Workers Comp Class	Subtype	change
Insurance Class	classifies	One-to-Zero-One-or-More	Line Of Business	Non-identifying	
Legal Jurisdiction	defines	One-to-Zero-One-or-More	Legal Jurisdiction Party Identity	Identifying	
	jurisdiction in				
Line Of Business	classifies	One-to-Zero-One-or-More	Product	Non-identifying	
Line Of Business	consolidates	One-to-Zero-One-or-	Line Of Business	Non-identifying	

Parent Entity Name	Parent to Child Phrase	Relationship Cardinality	Child Entity Name	Relationship Type	Charge
Group	similar	More			
Litigation	party responsibility defined in	One-to-Zero-One-or-More	Litigation Party Role	Identifying	
Litigation	is context for	Zero-or-One-to-Zero-One-or-More	Claim Offer	Non-identifying	
Litigation	is concerned with	One-to-Zero-One-or-More	Claim Litigation	Identifying	
Location Address	details in	Zero-or-One-to-Zero-or-One (Z)	Physical Location	Non-identifying	
Location Address	used by	Zero-or-One-to-Zero-One-or-More	Geographic Location	Non-identifying	
Occurrence	results in	Zero-or-One-to-One-or-More (P)	Claim	Non-identifying	
Organization	can be a	Zero-to-One	Government Organization	Subtype	change
Organization	can be a	Zero-to-One	Not For Profit Organization	Subtype	change
Organization	can be a	Zero-to-One	For Profit Organization	Subtype	change
Organization	can be a	Zero-to-One	Organization Unit	Subtype	change
Organization	defines	One-to-Zero-One-or-More	Staff Work Assignment	Identifying	
Organization	authorizes	One-to-Zero-One-or-More	Staff Position Assignment	Identifying	
Organization Unit	can be a	Zero-to-One	Field Organization Unit	Subtype	change

Parent Entity Name	Parent to Child Phrase	Relationship Cardinality	Child Entity Name	Relationship Type	Charge
Organization Unit	can be a	Zero-to-One	Administrative Organization Unit	Subtype	change
Insurable Object	can be a	Zero-to-One	Vehicle	Subtype	change
Insurable Object	can be a	Zero-to-One	Workers Comp Class	Subtype	change
Insurance Class	classifies	One-to-Zero-One-or-More	Line Of Business	Non-identifying	
Legal Jurisdiction	Defines jurisdiction in	One-to-Zero-One-or-More	Legal Jurisdiction Party Identity	Identifying	
Line Of Business	classifies	One-to-Zero-One-or-More	Product	Non-identifying	
Line Of Business Group	consolidates similar	One-to-Zero-One-or-More	Line Of Business	Non-identifying	
Litigation	party responsibility defined in	One-to-Zero-One-or-More	Litigation Party Role	Identifying	
Litigation	is context for	Zero-or-One-to-Zero-One-or-More	Claim Offer	Non-identifying	
Litigation	is concerned with	One-to-Zero-One-or-More	Claim Litigation	Identifying	
Location Address	details in	Zero-or-One-to-Zero-or-One (Z)	Physical Location	Non-identifying	
Location Address	used by	Zero-or-One-to-Zero-One-or-More	Geographic Location	Non-identifying	
Occurrence	results in	Zero-or-One-to-One-or-More (P)	Claim	Non-identifying	

Parent Entity Name	Parent to Child Phrase	Relationship Cardinality	Child Entity Name	Relationship Type	Charge
Organization	can be a	Zero-to-One	Government Organization	Subtype	change
Organization	can be a	Zero-to-One	Not For Profit Organization	Subtype	change
Organization	can be a	Zero-to-One	For Profit Organization	Subtype	change
Organization	can be a	Zero-to-One	Organization Unit	Subtype	change
Organization	defines	One-to-Zero-One-or-More	Staff Work Assignment	Identifying	
Organization	authorizes	One-to-Zero-One-or-More	Staff Position Assignment	Identifying	
Organization Unit	can be a	Zero-to-One	Field Organization Unit	Subtype	change
Organization Unit	can be a	Zero-to-One	Administrative Organization Unit	Subtype	change
Insurable Object	can be a	Zero-to-One	Vehicle	Subtype	change
Insurable Object	can be a	Zero-to-One	Workers Comp Class	Subtype	change
Insurance Class	classifies	One-to-Zero-One-or-More	Line Of Business	Non-identifying	
Legal Jurisdiction	Defines jurisdiction in	One-to-Zero-One-or-More	Legal Jurisdiction Party Identity	Identifying	
Line Of Business	classifies	One-to-Zero-One-or-More	Product	Non-identifying	
Line Of Business Group	consolidates similar	One-to-Zero-One-or-More	Line Of Business	Non-identifying	
Litigation	party responsibility defined in	One-to-Zero-One-or-More	Litigation Party Role	Identifying	
Litigation	is context for	Zero-or-One-to-Zero-One-or-More	Claim Offer	Non-identifying	



Parent Entity Name	Parent to Child Phrase	Relationship Cardinality	Child Entity Name	Relationship Type	Charge
Litigation	is concerned with	One-to-Zero-One-or-More	Claim Litigation	Identifying	
Location Address	details in	Zero-or-One-to-Zero-or-One (Z)	Physical Location	Non-identifying	
Location Address	used by	Zero-or-One-to-Zero-One-or-More	Geographic Location	Non-identifying	
Occurrence	results in	Zero-or-One-to-One-or-More (P)	Claim	Non-identifying	
Organization	can be a	Zero-to-One	Government Organization	Subtype	change
Organization	can be a	Zero-to-One	Not For Profit Organization	Subtype	change
Organization	can be a	Zero-to-One	For Profit Organization	Subtype	change
Organization	can be a	Zero-to-One	Organization Unit	Subtype	change
Organization	defines	One-to-Zero-One-or-More	Staff Work Assignment	Identifying	
Organization	authorizes	One-to-Zero-One-or-More	Staff Position Assignment	Identifying	
Organization Unit	can be a	Zero-to-One	Field Organization Unit	Subtype	change
Organization Unit	can be a	Zero-to-One	Administrative Organization Unit	Subtype	change
Party	assigned account responsibility in	One-to-Zero-One-or-More	Account Party Role	Identifying	
Party	assigned claim responsibility through	One-to-Zero-One-or-More	Claim Party Role	Identifying	

Parent Entity Name	Parent to Child Phrase	Relationship Cardinality	Child Entity Name	Relationship Type	Charge
Party	can be a	Zero-to-One	Organization	Subtype	change
Party	Is contacted through	One-to-Zero-One-or-More	Party Communication	Identifying	
Party	assigned insurable object responsibility through	One-to-Zero-One-or-More	Insurable Object Party Role	Identifying	
Party	relates from another party in	One-to-Zero-One-or-More	Party Relationship	Identifying	
Party		One-to-Zero-One-or-More	Assesment Party Role	Identifying	
Party	can be a	Zero-to-One	Grouping	Subtype	change
Party	relates to another party in	One-to-Zero-One-or-More	Party Relationship	Identifying	
Party	assigned arbitration responsibility through	One-to-Zero-One-or-More	Arbitration Party Role	Identifying	
Party	Assigned litigation responsibility through	One-to-Zero-One-or-More	Litigation Party Role	Identifying	
Party	can be a	Zero-to-One	Person	Subtype	change
Party	defines party responsibility in	One-to-Zero-One-or-More	Agreement Party Role	Identifying	
Party	is legally identified	One-to-Zero-One-or-More	Legal Jurisdiction Party Identity	Identifying	

Parent Entity Name	Parent to Child Phrase	Relationship Cardinality	Child Entity Name	Relationship Type	Charge
	through				
Party	designates	One-to-Zero-or-One (Z)	Party Preference	Identifying	
Party	subject to	One-to-Zero-One-or-More	Party Assessment	Identifying	
Party Relationship	Responsibility defined in	One-to-Zero-One-or-More	Party Relationship Role	Identifying	
Party Role	defines	One-to-Zero-One-or-More	Claim Party Role	Identifying	
Party Role	defines	One-to-Zero-One-or-More	Staff Work Assignment	Identifying	
Party Role	can be a	Zero-to-One	Agreement Role	Subtype	change
Party Role	can be a	Zero-to-One	Staff Role	Subtype	change
Party Role	can be a	Zero-to-One	Provider	Subtype	change
Party Role	defines	One-to-Zero-One-or-More	Agreement Party Role	Identifying	
Party Role	can be a	Zero-to-One	Adjuster	Subtype	change
Party Role	can be a	Zero-to-One	Claim Role	Subtype	change
Party Role	defines	One-to-Zero-One-or-More	Insurable Object Party Role	Identifying	
Party Role	defines	One-to-Zero-One-or-More	Arbitration Party Role	Identifying	
Party Role	can be a	Zero-to-One	Account Role	Subtype	change
Party Role	defines	One-to-Zero-One-or-More	Litigation Party Role	Identifying	
Party Role	defines	One-to-Zero-One-or-More	Account Party Role	Identifying	

Parent Entity Name	Parent to Child Phrase	Relationship Cardinality	Child Entity Name	Relationship Type	Charge
Party Role	designates responsibility through	One-to-Zero-One-or-More	Party Relationship Role	Identifying	
Party Role	defines	One-to-Zero-One-or-More	Household Person Role	Identifying	
Party Role	can be a	Zero-to-One	Staff	Subtype	change
Party Role	can be a	Zero-to-One	Staffing Organization	Subtype	change
Party Role		One-to-Zero-One-or-More	Assesment Party Role	Identifying	
Patient	can be a	Zero-to-One	Inpatient	Subtype	change
Patient	can be a	Zero-to-One	Outpatient	Subtype	change
Person	links to a household as a	One-to-Zero-One-or-More	Household Person	Identifying	
Person	designated to	One-to-Zero-One-or-More	Staff Work Assignment	Identifying	
Person	has expertise defined in	One-to-Zero-One-or-More	Person Profession	Identifying	
Person	subject to	One-to-Zero-One-or-More	Party Assessment	Identifying	
Person	designated for	One-to-Zero-One-or-More	Staff Position Assignment	Identifying	
Physical Location	provides technical details for	Zero-or-One-to-Zero-One-or-More	Geographic Location	Non-identifying	
Policy	relates from another through	One-to-Zero-One-or-More	Policy Relationship	Identifying	
Policy	major sections defined in	One-to-One-or-More (P)	Policy Coverage Part	Identifying	
Policy	relates to another through	One-to-Zero-One-or-More	Policy Relationship	Identifying	

Parent Entity Name	Parent to Child Phrase	Relationship Cardinality	Child Entity Name	Relationship Type	Charge
Policy	pricing determines	Zero-or-One-to-Zero-One-or-More	Policy Amount	Non-identifying	
Policy	life cycle defined through	Zero-or-One-to-Zero-One-or-More	Policy Event	Non-identifying	
Policy	contract issued as	One-to-Zero-One-or-More	Policy Form	Identifying	
Policy Amount	can be a	Zero-to-One	Fee	Subtype	change
Policy Amount	can be a	Zero-to-One	Credit Policy Amount	Subtype	change
Policy Amount	can be a	Zero-to-One	Ceded Policy Amount	Subtype	change
Policy Amount	can be a	Zero-to-One	Assumed Policy Amount	Subtype	change
Policy Amount	can be a	Zero-to-One	Surcharge	Subtype	change
Policy Amount	can be a	Zero-to-One	Tax	Subtype	change
Policy Amount	can be a	Zero-to-One	Premium	Subtype	change
Policy Amount	can be a	Zero-to-One	Direct Policy Amount	Subtype	change
Policy Amount	can be a	Zero-to-One	Debit Policy Amount	Subtype	change
Policy Coverage Detail	specifies	Zero-or-One-to-Zero-One-or-More	Policy Limit	Non-identifying	
Policy Coverage Detail	defines	One-to-Zero-One-or-More	Claim Coverage	Identifying	
Policy Coverage Detail	pricing determines	Zero-or-One-to-Zero-One-or-More	Policy Amount	Non-identifying	
Policy Coverage Detail	specifies	Zero-or-One-to-Zero-One-or-More	Policy Deductible	Non-identifying	
Policy Coverage Part	provides grouping for	One-to-One-or-More (P)	Policy Coverage Detail	Non-identifying	
Policy Event	can be a	Zero-to-One	Binding	Subtype	change
Policy Event	can be a	Zero-to-One	Pre Qualification	Subtype	change
Policy Event	can be a	Zero-to-One	New Business	Subtype	change
Policy Event	can be a	Zero-to-One	Endorsement	Subtype	change
Policy Event	can be a	Zero-to-One	Cancel	Subtype	change
Policy Event	can be a	Zero-to-One	Reinstatement	Subtype	change

Parent Entity Name	Parent to Child Phrase	Relationship Cardinality	Child Entity Name	Relationship Type	Charge
Policy Event	can be a	Zero-to-One	Renewal	Subtype	change
Policy Event	can be a	Zero-to-One	Quote	Subtype	change
Producer	can be a	Zero-to-One	Broker	Subtype	change
Producer	can be a	Zero-to-One	Agent	Subtype	change
Producer	can be a	Zero-to-One	Managing General Agent	Subtype	change
Product	defines market space of	Zero-or-One-to-Zero-One-or-More	Agreement	Non-identifying	
Product	includes	One-to-Zero-One-or-More	Product Coverage	Identifying	
Product	authorized for sale by	One-to-Zero-One-or-More	Product License	Identifying	
Provider	can be a	Zero-to-One	Mutual Fund Provider	Subtype	change
Provider	can be a	Zero-to-One	Legal Adviser	Subtype	change
Provider	can be a	Zero-to-One	Auditor	Subtype	change
Provider	can be a	Zero-to-One	Financial Service	Subtype	change
Provider	can be a	Zero-to-One	Contractor	Subtype	change
Provider	can be a	Zero-to-One	Buyer	Subtype	change
Provider	can be a	Zero-to-One	Attorney	Subtype	change
Provider	can be a	Zero-to-One	Health Care Provider	Subtype	change
Provider	can be a	Zero-to-One	Third Party Administrator	Subtype	change
Rating Territory	consists of	One-to-Zero-One-or-More	Rating Territory Geographic Location	Identifying	
Recovery	can be a	Zero-to-One	Loss Recovery	Subtype	change
Recovery	can be a	Zero-to-One	Expense Recovery	Subtype	change
Recovery	can be a	Zero-to-One	Deductible Recovery	Subtype	change
Recovery	can be a	Zero-to-One	Salvage	Subtype	change
Recovery	can be a	Zero-to-One	Subrogation	Subtype	change
Recovery	can be a	Zero-to-One	Reinsurance Recovery	Subtype	change
Regional Office	divides into	One-to-Zero-One-or-More	Branch Office	Identifying	
Reinsurance	provides risk	Many-to-Many	Policy	Many-Many	

Parent Entity Name	Parent to Child Phrase	Relationship Cardinality	Child Entity Name	Relationship Type	Charge
Agreement	sharing for				
Residential Structure	can be a	Zero-to-One	Mobile Home	Subtype	change
Residential Structure	can be a	Zero-to-One	Dwelling	Subtype	change
Staff Classification	designated for	Zero-or-One-to-Zero-One-or-More	Staff Position	Non-identifying	
Staff Position	filled through	One-to-Zero-One-or-More	Staff Position Assignment	Identifying	
Staff Role	can be a	Zero-to-One	Accountability	Subtype	change
Staff Role	can be a	Zero-to-One	Manager	Subtype	change
Staff Role	can be a	Zero-to-One	Team Leader	Subtype	change
Staff Role	can be a	Zero-to-One	Team Member	Subtype	change
Staffing Agreement	can be a	Zero-to-One	Employment Agreement	Subtype	change
Staffing Agreement	can be a	Zero-to-One	Third Party Staffing Agreement	Subtype	change
Staffing Agreement	can be a	Zero-to-One	Consultant Contract	Subtype	change
State	contains	Zero-or-One-to-Zero-One-or-More	Location Address	Non-identifying	
State	is site of	Zero-or-One-to-Zero-One-or-More	Geographic Location	Non-identifying	
Structure	can be a	Zero-to-One	Commercial Structure	Subtype	change
Structure	can be a	Zero-to-One	Residential Structure	Subtype	change
Structure	can be a	Zero-to-One	Combination Structure	Subtype	change
Territory	divides into	One-to-Zero-One-or-More	Regional Office	Identifying	
Transportation Class	can be a	Zero-to-One	Scheduled Item	Subtype	change
Transportation Class	can be a	Zero-to-One	Freight Group	Subtype	change
Transportation Class	can be a	Zero-to-One	Household Content	Subtype	change

Parent Entity Name	Parent to Child Phrase	Relationship Cardinality	Child Entity Name	Relationship Type	Charge
Transportation Class	can be a	Zero-to-One	Property In Transit	Subtype	change
Vehicle	can be a	Zero-to-One	Watercraft	Subtype	change
Vehicle	can be a	Zero-to-One	Trailer	Subtype	change
Vehicle	can be a	Zero-to-One	Recreational Vehicle	Subtype	change
Vehicle	can be a	Zero-to-One	Truck	Subtype	change
Vehicle	can be a	Zero-to-One	Automobile	Subtype	change
Vehicle	can be a	Zero-to-One	Construction Vehicle	Subtype	change
Vehicle	can be a	Zero-to-One	Van	Subtype	change
Vehicle	can be a	Zero-to-One	Motorcycle	Subtype	change
Vehicle	can be a	Zero-to-One	Bus	Subtype	change
Vehicle	can be a	Zero-to-One	Boat	Subtype	change



### 3.2.5 Domain Definitions

This section provides a listing of all domains included in the P&C Data Model, and the text definitions for each domain. The domains are listed hierarchically based on the parent domain. Within each parent domain, the domain logical names are listed alphabetically.

Domain Type	Domain Parent	Domain Name	Domain Definition	Domain Data Type	Change
<default>				CHAR(18)	
Blob				LARGE BINARY	
Datetime				DATE	
Datetime	Datetime	Date	Date is a Gregorian date that includes year, month, and day only, and should be stored in that order. It does not include time of day.	DATE	
Datetime	Date	Begin Date	Begin Date is the month, day and year on which something is scheduled to start.	DATE	change
Datetime	Date	Effective Date	Effective Date is the date on which something was activated and went into effect.	DATE	change
Datetime	Date	End Date	End Date is the month, day and year on which something is scheduled to stop.	DATE	change
Datetime	Date	Event Date	Event Date is the date that an event took place.	DATE	change

Domain Type	Domain Parent	Domain Name	Domain Definition	Domain Data Type	Change
Datetime	Date	Expiration Date	Expiration Date is the date on which something is no longer active or valid.	DATE	change
Datetime	Date	Inception Date	Inception Date is the original effective date of a contract that can be renewed and continue from one time period to another.	DATE	
Datetime	Datetime	Time	Time specifies the Hour, Minute, and Second of a 24-hour day.	TIME	
Number				INTEGER	
Number	Number	Amount	Amount is a Number expressed to represent a monetary value.	DECIMAL(15,2)	
Number	Number	Date Component	Date Component is a Year or Month or Day Number to be used when only a portion of a date is needed.	INTEGER	change
Number	Date Component	Day Number	Day is the numbered date within a Month. Examples: 01-31.	NUMBER(2)	
Number	Date Component	Month Number	Month is the numbered month within a year. Examples: 1-12.	NUMBER(2)	
Number	Date Component	Quarter Number	Quarter is the designated period of time that would represent 1/4th of a year which in sum would add to 4 quarters of a full gregorian year.	INTEGER	NEW
Number	Date Component	Year Number	Year is the number of the year. Example: 1999, 2000, 2020.	NUMBER(4)	

Domain Type	Domain Parent	Domain Name	Domain Definition	Domain Data Type	Change
Number	Number	Identifier	Identifier is a whole number assigned to uniquely identify an instance within a designated entity.	INTEGER	
Number	Identifier	Account Identifier	Account Identifier is the unique Identifier for an Account.	INTEGER	
Number	Identifier	Agreement Identifier	Agreement Identifier is the unique Identifier for an Agreement.	INTEGER	
Number	Identifier	Arbitration Identifier	Arbitration Identifier is the unique Identifier for an Arbitration arrangement.	INTEGER	change
Number	Identifier	Assessment Identifier	Assessment Identifier is the unique identifier for an Assessment.	INTEGER	change
Number	Identifier	Assessment Result Identifier	Assessment Result Identifier is the unique identifier for an Assessment Result.	INTEGER	
Number	Identifier	Catastrophe Identifier	Catastrophe Identifier is the unique identifier for a Catastrophe.	INTEGER	
Number	Identifier	Claim Amount Identifier	Claim Amount Identifier is the unique identifier for a Claim Amount.	INTEGER	change
Number	Identifier	Claim Identifier	Claim Identifier is the unique identifier for a Claim.	INTEGER	
Number	Identifier	Claim Offer Identifier	Claim Offer Identifier is the unique identifier for a Claim Offer.	INTEGER	
Number	Identifier	Communication Identifier	Communication Identifier is the unique identifier for a Communication arrangement.	INTEGER	change

Domain Type	Domain Parent	Domain Name	Domain Definition	Domain Data Type	Change
Number	Identifier	Company Identifier	Company Identifier is the unique identifier for Company.	INTEGER	
Number	Identifier	Court Identifier	Court Identifier is the unique identifier for a Court.	INTEGER	change
Number	Identifier	Coverage Group Identifier	Coverage Group Identifier is the unique identifier for a Coverage Group.	INTEGER	
Number	Identifier	Coverage Identifier	Coverage Identifier is the unique identifier for a Coverage.	INTEGER	
Number	Identifier	Coverage Level Identifier	Coverage Level Identifier is the unique identifier for a Coverage Level.	INTEGER	change
Number	Identifier	Coverage Limit Type Identifier	Coverage Limit Type Identifier is the unique identifier for a Coverage Limit Type.	INTEGER	
Number	Identifier	Coverage Type Identifier	Coverage Type Identifier is the unique identifier for a Coverage Type.	INTEGER	
Number	Identifier	Date Identifier	Date Identifier is a unique number for each year, month, and day (can be the numbers for yyymmdd)	INTEGER	NEW
Number	Identifier	Dun And Bradstreet Identifier	Dun And Bradstreet Identifier is the unique DUNS Number identifier assigned to a legal entity by Dun & Bradstreet.	INTEGER	
Number	Identifier	Event Identifier	Event Identifier is the unique identifier for an Event.	INTEGER	

Domain Type	Domain Parent	Domain Name	Domain Definition	Domain Data Type	Change
Number	Identifier	Geographic Location Identifier	Geographic Location Identifier is the unique identifier for a Geographic Location.	INTEGER	change
Number	Identifier	Grouping Identifier	Grouping Identifier of the unique Party Identifier for a Grouping.	INTEGER	NEW
Number	Identifier	Insurable Object Identifier	Insurable Object Identifier is the unique identifier for an Insurable Object.	INTEGER	change
Number	Identifier	Insurance Class Identifier	Insurance Class Identifier is the unique identifier for an Insurance Class.	INTEGER	
Number	Identifier	Jurisdiction Identifier	Jurisdiction Identifier is the unique identifier for a Jurisdiction.	INTEGER	change
Number	Identifier	Legal Jurisdiction Identifier	Legal Jurisdiction Identifier is the unique identifier for a Legal Jurisdiction.	INTEGER	change
Number	Identifier	Legal Jurisdiction Party Identifier	Legal Jurisdiction Party Identifier is the unique identifier assigned by a Legal Jurisdiction to identify a Party.	INTEGER	change
Number	Identifier	Line Of Business Group Identifier	Line Of Business Group Identifier is the unique identifier for a Line Of Business Group.	INTEGER	change
Number	Identifier	Line Of Business Identifier	Line Of Business Identifier is the unique identifier for a Line of Business.	INTEGER	change
Number	Identifier	Litigation Identifier	Litigation Identifier is the unique identifier for a Litigation proceeding.	INTEGER	change

Domain Type	Domain Parent	Domain Name	Domain Definition	Domain Data Type	Change
Number	Identifier	Location Address Identifier	Location Address Identifier is the unique identifier for a Location Address.	INTEGER	change
Number	Identifier	Occurrence Identifier	Occurrence Identifier is the unique identifier for an Occurrence.	INTEGER	change
Number	Identifier	Party Identifier	Party Identifier is the unique identifier for a Party.	INTEGER	change
Number	Party Identifier	Organization Identifier	Organization Identifier is the unique identifier for a Party that is an Organization or Organization Unit.	INTEGER	change
Number	Organization Identifier	Branch Office Identifier	Branch Office is an Organization Unit that is a local business location of an insurance company that markets and/or services its products and lines of insurance within and to a specified geographic location.	INTEGER	NEW
Number	Organization Identifier	Department Identifier	Department is an Organization Unit that groups individuals with common or related jobs to accomplish certain common or related functions. An example is the Payroll Department.	INTEGER	NEW
Number	Organization Identifier	Regional Office Identifier	A Regional Office is an Organization Unit of an insurance company's operations that may market, underwrite, and service the company's lines of business within a specified geographical area.	INTEGER	NEW
Number	Organization Identifier	Territory Identifier	Territory is a subtype of Organization and is an example of how a company's organization structure can be represented as Party and Party Relationship.	INTEGER	NEW

Domain Type	Domain Parent	Domain Name	Domain Definition	Domain Data Type	Change
Number	Party Identifier	Person Identifier	Person Identifier is the unique identifier for a Party that is a Person.	INTEGER	change
Number	Identifier	Physical Location Identifier	Physical Location Identifier is the unique identifier for a Physical Location.	INTEGER	change
Number	Identifier	Policy Amount Identifier	Policy Amount Identifier is the unique identifier for a Policy Amount.	INTEGER	change
Number	Identifier	Policy Coverage Detail Identifier	Policy Coverage Detail Identifier is the unique identifier for a Policy Coverage Detail entry.	INTEGER	change
Number	Identifier	Policy Deductible Identifier	Policy Deductible Identifier is the unique identifier for a Policy Deductible entry.	INTEGER	change
Number	Identifier	Policy Identifier	Policy Identifier is the unique identifier for a Policy.	INTEGER	
Number	Identifier	Policy Limit Identifier	Policy Limit Identifier is the unique identifier for a Policy Limit entry.	INTEGER	change
Number	Identifier	Product Identifier	Product Identifier is the unique identifier for a Product.	INTEGER	
Number	Identifier	Rating Territory Code Set Identifier	Rating Territory Code Set Identifier is the unique identifier for a set of Rating Territory Codes.	INTEGER	
Number	Identifier	Rating Territory Identifier	Rating Territory Identifier is the unique identifier for a Rating Territory.	INTEGER	

Domain Type	Domain Parent	Domain Name	Domain Definition	Domain Data Type	Change
Number	Identifier	Staff Position Identifier	Staff Position Identifier is the unique identifier for Staff Position.	INTEGER	change
Number	Number	Percent	Percent is a number expressed in relation to a total of 100 percent, in decimal form.	DECIMAL(7,4)	
Number	Number	Quantity	Quantity is the number of items against which arithmetic functions can be applied.	INTEGER	
Number	Number	Rate	Rate is a multiplier used to calculate an amount or quantity and is usually expressed as a rate per unit.	DECIMAL(5,5)	
Number	Number	Sequence Number	Sequence Number is a relative order of an entry listed within another qualifying attribute.	INTEGER	
String				VARCHAR(20)	
String	Address		Address is text that defines a single line of a physical or mailing location or and an electronic link or address. Based on an associated type code, the format and content can be validated.	VARCHAR(1000)	NEW



Domain Type	Domain Parent	Domain Name	Domain Definition	Domain Data Type	Change
String	Address	Long Address	Long Address is an extra long amount of text that defines a link to a specific webpage or a long electronic address or a long unformatted physical address.	VARCHAR(1000)	change
String	Address	Medium Address	Medium Address is averaged sized text that defines a physical or mailing location or an electronic link or address.	VARCHAR(200)	change
String	Address	Short Address	Short Address is one line of text or a single address for a physical location or e-mail address.	VARCHAR(100)	change
String	String	Code	Code is a value used to represent a condition of a data element.	VARCHAR(20)	
String	Code	Account Type Code	Account Type Code represents an Account category. Examples: customer account, billing account, sales account.	VARCHAR(5)	
String	Code	Accounting Code	Accounting Code represents an accounting mechanism to which monies are associated for accounting purposes. Example: General Ledger.	VARCHAR(20)	change
String	Code	Agreement Type Code	Agreement Type Code represents an Agreement category. Examples: reinsurance agreement, commercial agreement, service agreement.	VARCHAR(5)	
String	Code	Amount Type Code	Amount Type Code represents an amount category.	VARCHAR(20)	change

Domain Type	Domain Parent	Domain Name	Domain Definition	Domain Data Type	Change
String	Code	Assessment Result Type Code	Assessment Result Type Code represents the type of assessment being done. Examples: underwriting assessment, valuation assessment.	VARCHAR(20)	change
String	Code	Catastrophe Type Code	Catastrophe Type Code represents the kind of catastrophe. Example: hurricane, flood.	VARCHAR(20)	
String	Code	Claim Status Code	Claim Status Code represents the status of a claim. Examples: Active, Pended, Closed.	VARCHAR(5)	change
String	Code	Communication Type Code	Communication Type Code represents the kind of communication.	VARCHAR(20)	
String	Code	Company Catastrophe Code	Company Catastrophe Code is the Code assigned to a Catastrophe by the Company.	VARCHAR(8)	
String	Code	Company Code	Company Code represents a statutory insurance company. It can be self defined by the insurance company, or a standard code such as a NAIC company code.	VARCHAR(5)	
String	Code	Contact Preference Code	Contact Preference Code represents the communication options selected by a party through which they want to be contacted.	VARCHAR(20)	

Domain Type	Domain Parent	Domain Name	Domain Definition	Domain Data Type	Change
String	Code	Country Code	Country Code is an abbreviation that is unique for each country.	CHAR(3)	
String	Code	Coverage Inclusion Exclusion Code	Coverage Inclusion Exclusion Code represents a coverage as included or excluded in the policy. Examples: I - Inclusion E - Exclusion	CHAR(1)	change
String	Code	Coverage Part Code	Coverage Part Code is an abbreviation for the Coverage Part of an insurance policy.	VARCHAR(20)	
String	Code	Day And Time Group Code	Day and Time Group Code represents a general and relative set of time frames. Examples:"WDWH" for Week Days during Work Hours, "WE" for Weekends.	VARCHAR(20)	
String	Code	Day Code	The code which represents the day of a week. Example: MON= Monday, SAT=Saturday.	CHAR(3)	NEW
String	Code	Day Type Code	Day Type Code is a code that can be used to differentiate between work days, weekend days, and holidays.	VARCHAR(20)	NEW
String	Code	Deductible Basis Code	Deductible Basis Code identifies whether the related Deductible Value is an amount or a percentage or number of days, etc. that will be used to determine what an insured	VARCHAR(20)	

Domain Type	Domain Parent	Domain Name	Domain Definition	Domain Data Type	Change
			is expected to pay before reimbursement from the insurance company begins.		
String	Code	Deductible Type Code	Deductible Type Code represents the kind of deductible. Examples: per occurrence, per person.	VARCHAR(20)	
String	Code	Event Sub Type Code	Event Sub Type Code represents a lower level categorization of an event.	VARCHAR(20)	change
String	Code	Event Type Code	Event Type Code represents the kind of an event. Examples: life event, business event, policy event or loss event.	VARCHAR(20)	
String	Code	Gender Code	Gender Code represents the sex of the individual. Examples: F for female, M for Male.	CHAR(1)	
String	Code	Geographic Location Type Code	Geographic Location Type Code represents the type of Geographic Location. Example: State, County, or a building location.	VARCHAR(20)	

Domain Type	Domain Parent	Domain Name	Domain Definition	Domain Data Type	Change
String	Code	Industry Catastrophe Code	Industry Catastrophe Code is a Code assigned by a regulatory agency to identify a single major loss occurring on a specified date or to a single loss incurred over a number of days.	VARCHAR(8)	
String	Code	Industry Code	Industry Code is an external classification of industries, such as an SIC (Standard Industry Classification Code). Example: 63nnnnnn is the classification series for Insurance Carriers.	VARCHAR(20)	
String	Code	Industry Type Code	Industry Type Code represents an Industry category that is important to the company. Examples: Insurance, Banking, Pharmaceutical, Utility.	VARCHAR(5)	
String	Code	Insurable Object Type Code	Insurable Object Type Code represents a category of an item figuring in an insurance coverage or policy, having commercial or exchange value that is owned by a business, institution, or individual or adds to one's wealth or estate. These objects can be real (land and attachments) and personal (movable effects not attached to land).	VARCHAR(20)	
String	Code	Insurance Type Code	Insurance Type Code represents the Insurance Type. Examples: Direct, Assumed, Ceded	CHAR(1)	change

Domain Type	Domain Parent	Domain Name	Domain Definition	Domain Data Type	Change
String	Code	Language Code	Language Code represents a specific language.	VARCHAR(20)	
String	Code	Legal Classification Code	Legal Classification Code represents a legal category under which the Party can operate.	VARCHAR(20)	
String	Code	Legal Entity Type Code	Legal Entity Type Code represents a category of person or organization that has the legal standing to enter into a contract and may be sued for failure to perform as agreed in the contract.	VARCHAR(20)	change
String	Code	Limit Basis Code	Limit Basis Code represents the basis on which to specify the maximum extent of coverage that will be provided by an insurance policy. Example: Amount, Percentage, Days.	VARCHAR(20)	
String	Code	Limit Type Code	Limit Type Code represents the kind of limit that will be provided by an insurance policy. Examples: Per Occurrence, Per Person.	VARCHAR(20)	
String	Code	Line Of Business Code	Line Of Business Code represents a type of major Product Line. Examples: Commercial Auto, Homeowners.	VARCHAR(20)	change
String	Code	Locality Code	Locality Code represents a location category used by a party. Examples: home, work, second residence.	VARCHAR(20)	

Domain Type	Domain Parent	Domain Name	Domain Definition	Domain Data Type	Change
String	Code	Location Code	Location Code represents an externally assigned identification for a location.	VARCHAR(20)	
String	Code	Month Code	A standard 3 position abbreviation for each month of a year. Example: FEB=February; AUG=August	CHAR(3)	NEW
String	Code	Organization Type Code	Organization Type Code is used to distinguish various types of internal and external organizations.	VARCHAR(20)	
String	Code	Party Role Code	Party Role Code is an abbreviation of name of the role that a Party plays with respect to another entity.	VARCHAR(20)	
String	Code	Party Type Code	Party Type Code is an abbreviation that defines the kind of Party. Example: Person, Organization, Grouping.	CHAR(1)	
String	Code	Postal Code	Postal Code represents an alphanumeric code assigned to groups of addresses by various national postal systems throughout the world to facilitate mail delivery.	VARCHAR(20)	
String	Code	Rating Territory Code	Rating Territory Code represents a geographic area that is used to determine insurance rates.	VARCHAR(20)	
String	Code	Relationship Code	Relationship Code represents a relationship that ties entities together.	VARCHAR(20)	

Domain Type	Domain Parent	Domain Name	Domain Definition	Domain Data Type	Change
String	Code	Relationship Type Code	Relationship Type Code represents the kind of relationship that links one entity to another. Example: Business, Family, Reporting.	VARCHAR(20)	
String	Code	Staff Classification Code	Staff Classification Code defines the kind of Staff as Employee or Contractor, the eligible benefits, and level of a staff person.	VARCHAR(20)	
String	Code	State Code	State Code is a two character representation of a U.S. state or Canadian Province.	CHAR(2)	
String	Code	Status Code	Status Code represents the state of the related entity at a point in time. Examples: A = Active, P = Pending, C = Cancelled, T = Terminated.	VARCHAR(20)	
String	Code	Work Site Type Code	Work Site Type Code defines the kind of workplace. Example: Office Building, Plant, Farm.	VARCHAR(20)	
String	String	Description	Description is text that further defines the meaning and relevance of an object.	VARCHAR(1000)	
String	Description	Long Description	Long Description is expanded text used to define an object.	VARCHAR(5000)	
String	Description	Medium Description	Medium Description is a generic medium-length text to describe an object.	VARCHAR(2000)	



Domain Type	Domain Parent	Domain Name	Domain Definition	Domain Data Type	Change
String	Medium Description	Code Description	Code Description is text that further defines the meaning of a code.	VARCHAR(2000)	
String	Description	Short Description	Short Description is a generic short text definition for an object	VARCHAR(1000)	
String	String	Indicator	Indicator is a one character code that identifies if a condition is met or not met. Values are: Y = yes, N = no, blank = unknown or not applicable.	CHAR(1)	
String	String	Medium Name	Medium Name is an average length name for codes or non-legal objects.	VARCHAR(100)	
String	Medium Name	Code Name	Code Name is the text or label associated with a Code value.	VARCHAR(100)	
String	String	Name	Name is the wording used to provide a familiar label for any object or party. Names may not be unique and so additional attributes are needed to uniquely identify any specific object or party. Therefore names are never used as identifiers.	VARCHAR(200)	

Domain Type	Domain Parent	Domain Name	Domain Definition	Domain Data Type	Change
String	Name	Day Name	Day Name is the name of a day in a week.	CHAR(9)	NEW
String	Name	Long Name	Long Name is the full name of any object, such as the entire legal name of an Organization, Group or full name of an Individual.	VARCHAR(200)	
String	Name	Month Name	Month Name is full English name of a Month.	CHAR(9)	NEW
String	Name	Prefix-Suffix Name	Prefix-Suffix Name is a title or name extension. Examples: Mr., Mrs., Ms., Dr., Jr., Sr., III, M.D., PhD.	VARCHAR(20)	
String	Name	Short Name	Short Name is a brief name used for an object or a partial name of an individual, such as first, last or middle name.	VARCHAR(40)	
String	String	Variable Value	Variable Value is an amount, code or any other type of data that can contain syntax (such as hyphen separators) and delimiters as needed for interpretation and display.	VARCHAR(1000)	

Domain Type	Domain Parent	Domain Name	Domain Definition	Domain Data Type	Change
String	Variable Value	Company Claim Number	Company Claim Number is the number or alpha-numeric assigned to a claim by the company.	VARCHAR(20)	
String	Variable Value	Company Subclaim Number	Company Subclaim Number identifies a claim within a claim. It can be an alpha-numeric value.	VARCHAR(5)	change
String	Variable Value	Deductible Value	Deductible Value is the actual value of a monetary amount, percentage or time period. Examples: \$500, 10%, 90 days	VARCHAR(100)	
String	Variable Value	Latitude Or Longitude	Latitude or Longitude is a metric expressed in a common format to identify a position on the globe. The values can be expressed as Degree, Minute, Second, Decimal.	VARCHAR(20)	
String	Variable Value	Limit Value	Limit Value is the actual limit amount or percentage that will be provided by an insurance policy.	VARCHAR(100)	
String	Variable Value	Policy Number Value	Policy Number Value is a value assigned to uniquely identify an insurance policy that can be expressed in letters, numbers or characters.	VARCHAR(50)	Deleted
String	Variable Value	Policy Form Number Value	Party Form Number Value (called Policy Form Number) is the (often non-numeric) set of characters used to identify an attachment to a property and casualty policy. This "value" is usually established by the	VARCHAR(50)	NEW

Domain Type	Domain Parent	Domain Name	Domain Definition	Domain Data Type	Change
			state or by a rating bureau (i.e., the Insurance Services Office (ISO)), or by the insurance company.		
String	Variable Value	Variable Identifier Value	Variable Identifier Value is an externally assigned value or identifier. Example: phone number, company site number	VARCHAR(1000)	
String	Variable Identifier Value	Long Variable Value	Long Variable Value is text that can contain syntax or delimiters as needed for interpretation and display, such as a web link. Example: <a href="http://www.naic.org/store_jir.htm">http://www.naic.org/store_jir.htm</a>	VARCHAR(1000)	NEW
String	Variable Identifier Value	Medium Variable Value	Medium Variable Value is a number, date, or text that may contain syntax or delimiters as needed for interpretation and display. Example: (212) 645-2387, extension 437	VARCHAR(100)	NEW

## 3.3 Model/Term Cross Reference

### 3.3.1 Subject Area Entities

This section lists all entities included within a subject area data model. An entity can be included in several subject areas.

Subject Area Name	Entity Name
<Main Subject Area>	Account
<Main Subject Area>	Account Agreement
<Main Subject Area>	Account Party Role
<Main Subject Area>	Account Provider
<Main Subject Area>	Account Role
<Main Subject Area>	Accountability
<Main Subject Area>	Additional Interest
<Main Subject Area>	Adjuster
<Main Subject Area>	Administrative Organization Unit
<Main Subject Area>	Agency Contract
<Main Subject Area>	Agent
<Main Subject Area>	Agreement
<Main Subject Area>	Agreement Assessment
<Main Subject Area>	Agreement Party Role
<Main Subject Area>	Agreement Role
<Main Subject Area>	Animal
<Main Subject Area>	Approval
<Main Subject Area>	Arbitration
<Main Subject Area>	Arbitration Party Role
<Main Subject Area>	Assesment Party Role
<Main Subject Area>	Assessment
<Main Subject Area>	Assessment Result
<Main Subject Area>	Assumed Claim Amount

Subject Area Name	Entity Name
<Main Subject Area>	Assumed Policy Amount
<Main Subject Area>	Attorney
<Main Subject Area>	Audit
<Main Subject Area>	Auditor
<Main Subject Area>	Auto Repair Shop Contract
<Main Subject Area>	Automobile
<Main Subject Area>	Binding
<Main Subject Area>	Boat
<Main Subject Area>	Body Object
<Main Subject Area>	Branch Office
<Main Subject Area>	Broker
<Main Subject Area>	Brokerage Contract
<Main Subject Area>	Bus
<Main Subject Area>	Business Event
<Main Subject Area>	Buyer
<Main Subject Area>	Cancel
<Main Subject Area>	Catastrophe
<Main Subject Area>	Ceded Claim Amount
<Main Subject Area>	Ceded Policy Amount
<Main Subject Area>	Channel Role
<Main Subject Area>	Channel Score
<Main Subject Area>	Claim
<Main Subject Area>	Claim Administrator
<Main Subject Area>	Claim Amount
<Main Subject Area>	Claim Arbitration
<Main Subject Area>	Claim Assessment
<Main Subject Area>	Claim Coverage
<Main Subject Area>	Claim Evaluation Result
<Main Subject Area>	Claim Event
<Main Subject Area>	Claim Examiner

Subject Area Name	Entity Name
<Main Subject Area>	Claim Expert
<Main Subject Area>	Claim Folder
<Main Subject Area>	Claim Folder Document
<Main Subject Area>	Claim Fraud Examiner
<Main Subject Area>	Claim Legal Expert
<Main Subject Area>	Claim Litigation
<Main Subject Area>	Claim Offer
<Main Subject Area>	Claim Party Role
<Main Subject Area>	Claim Payment
<Main Subject Area>	Claim Representative
<Main Subject Area>	Claim Reserve
<Main Subject Area>	Claim Role
<Main Subject Area>	Claim Witness
<Main Subject Area>	Claimant
<Main Subject Area>	Claimee
<Main Subject Area>	Combination Structure
<Main Subject Area>	Combine
<Main Subject Area>	Commercial Agreement
<Main Subject Area>	Commercial Structure
<Main Subject Area>	Communication Identity
<Main Subject Area>	Commutation Agreement
<Main Subject Area>	Company
<Main Subject Area>	Company Jurisdiction
<Main Subject Area>	Construction Vehicle
<Main Subject Area>	Consultant Contract
<Main Subject Area>	Contractor
<Main Subject Area>	Court Jurisdiction
<Main Subject Area>	Coverage
<Main Subject Area>	Coverage Group
<Main Subject Area>	Coverage Level

Subject Area Name	Entity Name
<Main Subject Area>	Coverage Limit Type
<Main Subject Area>	Coverage Part
<Main Subject Area>	Coverage Type
<Main Subject Area>	Credit Claim Amount
<Main Subject Area>	Credit Policy Amount
<Main Subject Area>	Credit Rating
<Main Subject Area>	Customer
<Main Subject Area>	Customer Score
<Main Subject Area>	Debit Claim Amount
<Main Subject Area>	Debit Policy Amount
<Main Subject Area>	Deductible Recovery
<Main Subject Area>	Demographic Score
<Main Subject Area>	Department
<Main Subject Area>	Derivative Contract
<Main Subject Area>	Direct Claim Amount
<Main Subject Area>	Direct Policy Amount
<Main Subject Area>	Driver
<Main Subject Area>	Dwelling
<Main Subject Area>	Employment Agreement
<Main Subject Area>	Endorsement
<Main Subject Area>	Event
<Main Subject Area>	Expense Payment
<Main Subject Area>	Expense Recovery
<Main Subject Area>	Expense Reserve
<Main Subject Area>	Farm Equipment
<Main Subject Area>	Fee
<Main Subject Area>	Field Organization Unit
<Main Subject Area>	Financial Account Agreement
<Main Subject Area>	Financial Adviser
<Main Subject Area>	Financial Analyst



Subject Area Name	Entity Name
<Main Subject Area>	Financial Interest Role
<Main Subject Area>	Financial Service
<Main Subject Area>	Financial Services Assessment
<Main Subject Area>	Financial Valuation
<Main Subject Area>	Flat
<Main Subject Area>	For Profit Organization
<Main Subject Area>	Fraud Assessment
<Main Subject Area>	Freight Group
<Main Subject Area>	Full Term
<Main Subject Area>	Geographic Location
<Main Subject Area>	Government Organization
<Main Subject Area>	Group Agreement
<Main Subject Area>	Grouping
<Main Subject Area>	Health Care Provider
<Main Subject Area>	Household
<Main Subject Area>	Household Content
<Main Subject Area>	Household Person
<Main Subject Area>	Household Person Role
<Main Subject Area>	Independent Adjuster
<Main Subject Area>	Individual Agreement
<Main Subject Area>	Inhouse Adjuster
<Main Subject Area>	Inpatient
<Main Subject Area>	Insurable Object
<Main Subject Area>	Insurable Object Party Role
<Main Subject Area>	Insurance Class
<Main Subject Area>	Insurance Rating Classification Code
<Main Subject Area>	Insured
<Main Subject Area>	Insured Account
<Main Subject Area>	Insurer
<Main Subject Area>	Intermediary Agreement

Subject Area Name	Entity Name
<Main Subject Area>	Legal Adviser
<Main Subject Area>	Legal Jurisdiction
<Main Subject Area>	Legal Jurisdiction Party Identity
<Main Subject Area>	Life Event
<Main Subject Area>	Line Of Business
<Main Subject Area>	Line Of Business Group
<Main Subject Area>	Litigation
<Main Subject Area>	Litigation Party Role
<Main Subject Area>	Location Address
<Main Subject Area>	Loss Payee
<Main Subject Area>	Loss Payment
<Main Subject Area>	Loss Recovery
<Main Subject Area>	Loss Reserve
<Main Subject Area>	Manager
<Main Subject Area>	Managing General Agent
<Main Subject Area>	Manufactured Object
<Main Subject Area>	Medical Condition
<Main Subject Area>	Mid Term
<Main Subject Area>	Milking Machine
<Main Subject Area>	Mobile Home
<Main Subject Area>	Motorcycle
<Main Subject Area>	Mutual Fund Provider
<Main Subject Area>	New Business
<Main Subject Area>	Not For Profit Organization
<Main Subject Area>	Object Assessment
<Main Subject Area>	Occurrence
<Main Subject Area>	Organization
<Main Subject Area>	Organization Unit
<Main Subject Area>	Other Assessment Result
<Main Subject Area>	Outpatient

Subject Area Name	Entity Name
<Main Subject Area>	Party
<Main Subject Area>	Party Assessment
<Main Subject Area>	Party Communication
<Main Subject Area>	Party Preference
<Main Subject Area>	Party Relationship
<Main Subject Area>	Party Relationship Role
<Main Subject Area>	Party Role
<Main Subject Area>	Patient
<Main Subject Area>	Person
<Main Subject Area>	Person Profession
<Main Subject Area>	Physical Location
<Main Subject Area>	Physical Object Assessment
<Main Subject Area>	Place Assessment
<Main Subject Area>	Policy
<Main Subject Area>	Policy Amount
<Main Subject Area>	Policy Coverage Detail
<Main Subject Area>	Policy Coverage Part
<Main Subject Area>	Policy Deductible
<Main Subject Area>	Policy Event
<Main Subject Area>	Policy Form
<Main Subject Area>	Policy Limit
<Main Subject Area>	Policy Relationship
<Main Subject Area>	Pre Qualification
<Main Subject Area>	Premium
<Main Subject Area>	Premium Auditor
<Main Subject Area>	Pro Rata
<Main Subject Area>	Producer
<Main Subject Area>	Product
<Main Subject Area>	Product Coverage
<Main Subject Area>	Product License

Subject Area Name	Entity Name
<Main Subject Area>	Professional Group
<Main Subject Area>	Project
<Main Subject Area>	Property In Transit
<Main Subject Area>	Prospect
<Main Subject Area>	Provider
<Main Subject Area>	Provider Agreement
<Main Subject Area>	Public Adjuster
<Main Subject Area>	Quote
<Main Subject Area>	Rating Territory
<Main Subject Area>	Rating Territory Geographic Location
<Main Subject Area>	Recovery
<Main Subject Area>	Recreational Vehicle
<Main Subject Area>	Regional Office
<Main Subject Area>	Reinstatement
<Main Subject Area>	Reinsurance Agreement
<Main Subject Area>	Reinsurance Recovery
<Main Subject Area>	Renewal
<Main Subject Area>	Residential Structure
<Main Subject Area>	Risk Factor Score
<Main Subject Area>	Salvage
<Main Subject Area>	Scheduled Item
<Main Subject Area>	Service Provider
<Main Subject Area>	Short Rate
<Main Subject Area>	Staff
<Main Subject Area>	Staff Classification
<Main Subject Area>	Staff Position
<Main Subject Area>	Staff Position Assignment
<Main Subject Area>	Staff Role
<Main Subject Area>	Staff Work Assignment
<Main Subject Area>	Staffing Agreement

Subject Area Name	Entity Name
<Main Subject Area>	Staffing Organization
<Main Subject Area>	State
<Main Subject Area>	Structure
<Main Subject Area>	Subcontractor
<Main Subject Area>	Subrogation
<Main Subject Area>	Supplier
<Main Subject Area>	Surcharge
<Main Subject Area>	Tax
<Main Subject Area>	Team
<Main Subject Area>	Team Leader
<Main Subject Area>	Team Member
<Main Subject Area>	Territory
<Main Subject Area>	Third Party Administrator
<Main Subject Area>	Third Party Staffing Agreement
<Main Subject Area>	Tractor
<Main Subject Area>	Trailer
<Main Subject Area>	Transportation Class
<Main Subject Area>	Truck
<Main Subject Area>	Underwriting Assessment
<Main Subject Area>	Van
<Main Subject Area>	Vehicle
<Main Subject Area>	Victim
<Main Subject Area>	Watercraft
<Main Subject Area>	Workers Comp Class
A1 - Party	Agreement
A1 - Party	Agreement Party Role
A1 - Party	Claim
A1 - Party	Claim Party Role
A1 - Party	Communication Identity
A1 - Party	Geographic Location

Subject Area Name	Entity Name
A1 - Party	Grouping
A1 - Party	Household
A1 - Party	Household Person
A1 - Party	Household Person Role
A1 - Party	Insurable Object
A1 - Party	Insurable Object Party Role
A1 - Party	Legal Jurisdiction
A1 - Party	Legal Jurisdiction Party Identity
A1 - Party	Organization
A1 - Party	Party
A1 - Party	Party Communication
A1 - Party	Party Preference
A1 - Party	Party Relationship
A1 - Party	Party Relationship Role
A1 - Party	Party Role
A1 - Party	Person
A1 - Party	Person Profession
A1 - Party	Staff Work Assignment
A2 - Account and Agreement	Account
A2 - Account and Agreement	Account Agreement
A2 - Account and Agreement	Account Party Role
A2 - Account and Agreement	Account Provider
A2 - Account and Agreement	Account Role
A2 - Account and Agreement	Agency Contract
A2 - Account and Agreement	Agreement
A2 - Account and Agreement	Agreement Party Role
A2 - Account and Agreement	Agreement Role
A2 - Account and Agreement	Auto Repair Shop Contract
A2 - Account and Agreement	Brokerage Contract
A2 - Account and Agreement	Commercial Agreement

Subject Area Name	Entity Name
A2 - Account and Agreement	Commutation Agreement
A2 - Account and Agreement	Customer
A2 - Account and Agreement	Derivative Contract
A2 - Account and Agreement	Financial Account Agreement
A2 - Account and Agreement	Financial Adviser
A2 - Account and Agreement	Financial Analyst
A2 - Account and Agreement	Financial Service
A2 - Account and Agreement	Group Agreement
A2 - Account and Agreement	Individual Agreement
A2 - Account and Agreement	Insured Account
A2 - Account and Agreement	Intermediary Agreement
A2 - Account and Agreement	Party
A2 - Account and Agreement	Party Role
A2 - Account and Agreement	Policy
A2 - Account and Agreement	Prospect
A2 - Account and Agreement	Provider
A2 - Account and Agreement	Provider Agreement
A2 - Account and Agreement	Reinsurance Agreement
A2 - Account and Agreement	Staffing Agreement
A3 - Policy	Agreement
A3 - Policy	Agreement Party Role
A3 - Policy	Coverage
A3 - Policy	Coverage Part
A3 - Policy	Event
A3 - Policy	Geographic Location
A3 - Policy	Insurable Object
A3 - Policy	Insurable Object Party Role
A3 - Policy	Location Address
A3 - Policy	Party
A3 - Policy	Physical Location

Subject Area Name	Entity Name
A3 - Policy	Policy
A3 - Policy	Policy Amount
A3 - Policy	Policy Coverage Detail
A3 - Policy	Policy Coverage Part
A3 - Policy	Policy Deductible
A3 - Policy	Policy Event
A3 - Policy	Policy Form
A3 - Policy	Policy Limit
A3 - Policy	Policy Relationship
A3 - Policy	Product
A4 - Claim	Arbitration
A4 - Claim	Arbitration Party Role
A4 - Claim	Catastrophe
A4 - Claim	Claim
A4 - Claim	Claim Amount
A4 - Claim	Claim Arbitration
A4 - Claim	Claim Coverage
A4 - Claim	Claim Folder
A4 - Claim	Claim Folder Document
A4 - Claim	Claim Litigation
A4 - Claim	Claim Offer
A4 - Claim	Claim Party Role
A4 - Claim	Court Jurisdiction
A4 - Claim	Geographic Location
A4 - Claim	Insurable Object
A4 - Claim	Litigation
A4 - Claim	Litigation Party Role
A4 - Claim	Occurrence
A4 - Claim	Party
A4 - Claim	Party Role



Subject Area Name	Entity Name
A4 - Claim	Policy Coverage Detail
A5 - Assessment	Agreement
A5 - Assessment	Agreement Assessment
A5 - Assessment	Approval
A5 - Assessment	Assesment Party Role
A5 - Assessment	Assessment
A5 - Assessment	Assessment Result
A5 - Assessment	Channel Score
A5 - Assessment	Claim
A5 - Assessment	Claim Assessment
A5 - Assessment	Claim Evaluation Result
A5 - Assessment	Credit Rating
A5 - Assessment	Customer Score
A5 - Assessment	Demographic Score
A5 - Assessment	Financial Services Assessment
A5 - Assessment	Financial Valuation
A5 - Assessment	Fraud Assessment
A5 - Assessment	Insurable Object
A5 - Assessment	Medical Condition
A5 - Assessment	Object Assessment
A5 - Assessment	Other Assessment Result
A5 - Assessment	Party
A5 - Assessment	Party Assessment
A5 - Assessment	Party Role
A5 - Assessment	Physical Object Assessment
A5 - Assessment	Place Assessment
A5 - Assessment	Risk Factor Score
A5 - Assessment	Underwriting Assessment
B1 - Agreement Role	Accountability
B1 - Agreement Role	Additional Interest

Subject Area Name	Entity Name
B1 - Agreement Role	Agent
B1 - Agreement Role	Agreement
B1 - Agreement Role	Agreement Party Role
B1 - Agreement Role	Agreement Role
B1 - Agreement Role	Auditor
B1 - Agreement Role	Broker
B1 - Agreement Role	Buyer
B1 - Agreement Role	Channel Role
B1 - Agreement Role	Contractor
B1 - Agreement Role	Financial Interest Role
B1 - Agreement Role	Financial Service
B1 - Agreement Role	Health Care Provider
B1 - Agreement Role	Insured
B1 - Agreement Role	Insurer
B1 - Agreement Role	Legal Adviser
B1 - Agreement Role	Manager
B1 - Agreement Role	Managing General Agent
B1 - Agreement Role	Mutual Fund Provider
B1 - Agreement Role	Party
B1 - Agreement Role	Party Role
B1 - Agreement Role	Premium Auditor
B1 - Agreement Role	Producer
B1 - Agreement Role	Provider
B1 - Agreement Role	Service Provider
B1 - Agreement Role	Staff Role
B1 - Agreement Role	Subcontractor
B1 - Agreement Role	Supplier
B1 - Agreement Role	Team Leader
B1 - Agreement Role	Team Member
B1 - Agreement Role	Third Party Administrator

Subject Area Name	Entity Name
B2 - Claim Role	Adjuster
B2 - Claim Role	Attorney
B2 - Claim Role	Claim
B2 - Claim Role	Claim Administrator
B2 - Claim Role	Claim Examiner
B2 - Claim Role	Claim Expert
B2 - Claim Role	Claim Fraud Examiner
B2 - Claim Role	Claim Legal Expert
B2 - Claim Role	Claim Party Role
B2 - Claim Role	Claim Representative
B2 - Claim Role	Claim Role
B2 - Claim Role	Claim Witness
B2 - Claim Role	Claimant
B2 - Claim Role	Claimee
B2 - Claim Role	Driver
B2 - Claim Role	Health Care Provider
B2 - Claim Role	Independent Adjuster
B2 - Claim Role	Inhouse Adjuster
B2 - Claim Role	Inpatient
B2 - Claim Role	Loss Payee
B2 - Claim Role	Outpatient
B2 - Claim Role	Party
B2 - Claim Role	Party Role
B2 - Claim Role	Patient
B2 - Claim Role	Provider
B2 - Claim Role	Public Adjuster
B2 - Claim Role	Service Provider
B2 - Claim Role	Staff Role
B2 - Claim Role	Third Party Administrator
B2 - Claim Role	Victim

Subject Area Name	Entity Name
B3 - Staffing Role	Accountability
B3 - Staffing Role	Agreement
B3 - Staffing Role	Agreement Party Role
B3 - Staffing Role	Consultant Contract
B3 - Staffing Role	Employment Agreement
B3 - Staffing Role	Grouping
B3 - Staffing Role	Manager
B3 - Staffing Role	Organization
B3 - Staffing Role	Party
B3 - Staffing Role	Party Relationship
B3 - Staffing Role	Party Relationship Role
B3 - Staffing Role	Party Role
B3 - Staffing Role	Person
B3 - Staffing Role	Staff
B3 - Staffing Role	Staff Classification
B3 - Staffing Role	Staff Position
B3 - Staffing Role	Staff Position Assignment
B3 - Staffing Role	Staff Role
B3 - Staffing Role	Staff Work Assignment
B3 - Staffing Role	Staffing Agreement
B3 - Staffing Role	Staffing Organization
B3 - Staffing Role	Team Leader
B3 - Staffing Role	Team Member
B3 - Staffing Role	Third Party Staffing Agreement
C1 - Party Subtype	Administrative Organization Unit
C1 - Party Subtype	Branch Office
C1 - Party Subtype	Department
C1 - Party Subtype	Field Organization Unit
C1 - Party Subtype	For Profit Organization
C1 - Party Subtype	Government Organization

Subject Area Name	Entity Name
C1 - Party Subtype	Grouping
C1 - Party Subtype	Household
C1 - Party Subtype	Not For Profit Organization
C1 - Party Subtype	Organization
C1 - Party Subtype	Organization Unit
C1 - Party Subtype	Party
C1 - Party Subtype	Party Relationship
C1 - Party Subtype	Person
C1 - Party Subtype	Professional Group
C1 - Party Subtype	Project
C1 - Party Subtype	Regional Office
C1 - Party Subtype	Staff Position Assignment
C1 - Party Subtype	Team
C1 - Party Subtype	Territory
C2 - Insurable Object Subtype	Animal
C2 - Insurable Object Subtype	Automobile
C2 - Insurable Object Subtype	Boat
C2 - Insurable Object Subtype	Body Object
C2 - Insurable Object Subtype	Bus
C2 - Insurable Object Subtype	Combination Structure
C2 - Insurable Object Subtype	Combine
C2 - Insurable Object Subtype	Commercial Structure
C2 - Insurable Object Subtype	Construction Vehicle
C2 - Insurable Object Subtype	Dwelling
C2 - Insurable Object Subtype	Farm Equipment
C2 - Insurable Object Subtype	Freight Group
C2 - Insurable Object Subtype	Geographic Location
C2 - Insurable Object Subtype	Household
C2 - Insurable Object Subtype	Household Content
C2 - Insurable Object Subtype	Insurable Object

Subject Area Name	Entity Name
C2 - Insurable Object Subtype	Manufactured Object
C2 - Insurable Object Subtype	Milking Machine
C2 - Insurable Object Subtype	Mobile Home
C2 - Insurable Object Subtype	Motorcycle
C2 - Insurable Object Subtype	Property In Transit
C2 - Insurable Object Subtype	Recreational Vehicle
C2 - Insurable Object Subtype	Residential Structure
C2 - Insurable Object Subtype	Scheduled Item
C2 - Insurable Object Subtype	Structure
C2 - Insurable Object Subtype	Tractor
C2 - Insurable Object Subtype	Trailer
C2 - Insurable Object Subtype	Transportation Class
C2 - Insurable Object Subtype	Truck
C2 - Insurable Object Subtype	Van
C2 - Insurable Object Subtype	Vehicle
C2 - Insurable Object Subtype	Watercraft
C2 - Insurable Object Subtype	Workers Comp Class
C3 - Money Subtype	Assumed Claim Amount
C3 - Money Subtype	Assumed Policy Amount
C3 - Money Subtype	Ceded Claim Amount
C3 - Money Subtype	Ceded Policy Amount
C3 - Money Subtype	Claim Amount
C3 - Money Subtype	Claim Payment
C3 - Money Subtype	Claim Reserve
C3 - Money Subtype	Credit Claim Amount
C3 - Money Subtype	Credit Policy Amount
C3 - Money Subtype	Debit Claim Amount
C3 - Money Subtype	Debit Policy Amount
C3 - Money Subtype	Deductible Recovery
C3 - Money Subtype	Direct Claim Amount

Subject Area Name	Entity Name
C3 - Money Subtype	Direct Policy Amount
C3 - Money Subtype	Expense Payment
C3 - Money Subtype	Expense Recovery
C3 - Money Subtype	Expense Reserve
C3 - Money Subtype	Fee
C3 - Money Subtype	Loss Payment
C3 - Money Subtype	Loss Recovery
C3 - Money Subtype	Loss Reserve
C3 - Money Subtype	Policy Amount
C3 - Money Subtype	Premium
C3 - Money Subtype	Recovery
C3 - Money Subtype	Reinsurance Recovery
C3 - Money Subtype	Salvage
C3 - Money Subtype	Subrogation
C3 - Money Subtype	Surcharge
C3 - Money Subtype	Tax
C4 - Event Subtype	Audit
C4 - Event Subtype	Binding
C4 - Event Subtype	Business Event
C4 - Event Subtype	Cancel
C4 - Event Subtype	Claim Event
C4 - Event Subtype	Endorsement
C4 - Event Subtype	Event
C4 - Event Subtype	Flat
C4 - Event Subtype	Full Term
C4 - Event Subtype	Life Event
C4 - Event Subtype	Mid Term
C4 - Event Subtype	New Business
C4 - Event Subtype	Policy
C4 - Event Subtype	Policy Event

Subject Area Name	Entity Name
C4 - Event Subtype	Pre Qualification
C4 - Event Subtype	Pro Rata
C4 - Event Subtype	Quote
C4 - Event Subtype	Reinstatement
C4 - Event Subtype	Renewal
C4 - Event Subtype	Short Rate
D1 - Product Coverage Reference	Company
D1 - Product Coverage Reference	Company Jurisdiction
D1 - Product Coverage Reference	Coverage
D1 - Product Coverage Reference	Coverage Group
D1 - Product Coverage Reference	Coverage Level
D1 - Product Coverage Reference	Coverage Limit Type
D1 - Product Coverage Reference	Coverage Part
D1 - Product Coverage Reference	Coverage Type
D1 - Product Coverage Reference	Geographic Location
D1 - Product Coverage Reference	Insurance Class
D1 - Product Coverage Reference	Insurance Rating Classification Code
D1 - Product Coverage Reference	Line Of Business
D1 - Product Coverage Reference	Line Of Business Group
D1 - Product Coverage Reference	Product
D1 - Product Coverage Reference	Product Coverage
D1 - Product Coverage Reference	Product License
D1 - Product Coverage Reference	Rating Territory
D1 - Product Coverage Reference	Rating Territory Geographic Location
D1 - Product Coverage Reference	State
A3 - Policy	Policy Coverage Detail
A3 - Policy	Policy Coverage Part
A3 - Policy	Policy Deductible
A3 - Policy	Policy Event
A3 - Policy	Policy Form



Subject Area Name	Entity Name
A3 - Policy	Policy Limit
A3 - Policy	Policy Relationship
A3 - Policy	Product
A4 - Claim	Arbitration
A4 - Claim	Arbitration Party Role
A4 - Claim	Catastrophe
A4 - Claim	Claim
A4 - Claim	Claim Amount
A4 - Claim	Claim Arbitration
A4 - Claim	Claim Coverage
A4 - Claim	Claim Folder
A4 - Claim	Claim Folder Document
A4 - Claim	Claim Litigation
A4 - Claim	Claim Offer
A4 - Claim	Claim Party Role
A4 - Claim	Court Jurisdiction
A4 - Claim	Geographic Location
A4 - Claim	Insurable Object
A4 - Claim	Litigation
A4 - Claim	Litigation Party Role
A4 - Claim	Occurrence
A4 - Claim	Party
A4 - Claim	Party Role
A4 - Claim	Policy Coverage Detail
A5 - Assessment	Agreement
A5 - Assessment	Agreement Assessment
A5 - Assessment	Approval
A5 - Assessment	Assesment Party Role
A5 - Assessment	Assessment
A5 - Assessment	Assessment Result

Subject Area Name	Entity Name
A5 - Assessment	Channel Score
A5 - Assessment	Claim
A5 - Assessment	Claim Assessment
A5 - Assessment	Claim Evaluation Result
A5 - Assessment	Credit Rating
A5 - Assessment	Customer Score
A5 - Assessment	Demographic Score
A5 - Assessment	Financial Services Assessment
A5 - Assessment	Financial Valuation
A5 - Assessment	Fraud Assessment
A5 - Assessment	Insurable Object
A5 - Assessment	Medical Condition
A5 - Assessment	Object Assessment
A5 - Assessment	Other Assessment Result
A5 - Assessment	Party
A5 - Assessment	Party Assessment
A5 - Assessment	Party Role
A5 - Assessment	Physical Object Assessment
A5 - Assessment	Place Assessment
A5 - Assessment	Risk Factor Score
A5 - Assessment	Underwriting Assessment
B1 - Agreement Role	Accountability
B1 - Agreement Role	Additional Interest
B1 - Agreement Role	Agent
B1 - Agreement Role	Agreement
B1 - Agreement Role	Agreement Party Role
B1 - Agreement Role	Agreement Role
B1 - Agreement Role	Auditor
B1 - Agreement Role	Broker
B1 - Agreement Role	Buyer

Subject Area Name	Entity Name
B1 - Agreement Role	Channel Role
B1 - Agreement Role	Contractor
B1 - Agreement Role	Financial Interest Role
B1 - Agreement Role	Financial Service
B1 - Agreement Role	Health Care Provider
B1 - Agreement Role	Insured
B1 - Agreement Role	Insurer
B1 - Agreement Role	Legal Adviser
B1 - Agreement Role	Manager
B1 - Agreement Role	Managing General Agent
B1 - Agreement Role	Mutual Fund Provider
B1 - Agreement Role	Party
B1 - Agreement Role	Party Role
B1 - Agreement Role	Premium Auditor
B1 - Agreement Role	Producer
B1 - Agreement Role	Provider
B1 - Agreement Role	Service Provider
B1 - Agreement Role	Staff Role
B1 - Agreement Role	Subcontractor
B1 - Agreement Role	Supplier
B1 - Agreement Role	Team Leader
B1 - Agreement Role	Team Member
B1 - Agreement Role	Third Party Administrator
B2 - Claim Role	Adjuster
B2 - Claim Role	Attorney
B2 - Claim Role	Claim
B2 - Claim Role	Claim Administrator
B2 - Claim Role	Claim Examiner
B2 - Claim Role	Claim Expert
B2 - Claim Role	Claim Fraud Examiner

Subject Area Name	Entity Name
B2 - Claim Role	Claim Legal Expert
B2 - Claim Role	Claim Party Role
B2 - Claim Role	Claim Representative
B2 - Claim Role	Claim Role
B2 - Claim Role	Claim Witness
B2 - Claim Role	Claimant
B2 - Claim Role	Claimee
B2 - Claim Role	Driver
B2 - Claim Role	Health Care Provider
B2 - Claim Role	Independent Adjuster
B2 - Claim Role	Inhouse Adjuster
B2 - Claim Role	Inpatient
B2 - Claim Role	Loss Payee
B2 - Claim Role	Outpatient
B2 - Claim Role	Party
B2 - Claim Role	Party Role
B2 - Claim Role	Patient
B2 - Claim Role	Provider
B2 - Claim Role	Public Adjuster
B2 - Claim Role	Service Provider
B2 - Claim Role	Staff Role
B2 - Claim Role	Third Party Administrator
B2 - Claim Role	Victim
B3 - Staffing Role	Accountability
B3 - Staffing Role	Agreement
B3 - Staffing Role	Agreement Party Role
B3 - Staffing Role	Consultant Contract
B3 - Staffing Role	Employment Agreement
B3 - Staffing Role	Grouping
B3 - Staffing Role	Manager

Subject Area Name	Entity Name
B3 - Staffing Role	Organization
B3 - Staffing Role	Party
B3 - Staffing Role	Party Relationship
B3 - Staffing Role	Party Relationship Role
B3 - Staffing Role	Party Role
B3 - Staffing Role	Person
B3 - Staffing Role	Staff
B3 - Staffing Role	Staff Classification
B3 - Staffing Role	Staff Position
B3 - Staffing Role	Staff Position Assignment
B3 - Staffing Role	Staff Role
B3 - Staffing Role	Staff Work Assignment
B3 - Staffing Role	Staffing Agreement
B3 - Staffing Role	Staffing Organization
B3 - Staffing Role	Team Leader
B3 - Staffing Role	Team Member
B3 - Staffing Role	Third Party Staffing Agreement
B1 - Agreement Role	Subcontractor
B1 - Agreement Role	Supplier
B1 - Agreement Role	Team Leader
B1 - Agreement Role	Team Member
B1 - Agreement Role	Third Party Administrator
B2 - Claim Role	Adjuster
B2 - Claim Role	Attorney
B2 - Claim Role	Claim
B2 - Claim Role	Claim Administrator
B2 - Claim Role	Claim Examiner
B2 - Claim Role	Claim Expert
B2 - Claim Role	Claim Fraud Examiner
B2 - Claim Role	Claim Legal Expert

Subject Area Name	Entity Name
B2 - Claim Role	Claim Party Role
B2 - Claim Role	Claim Representative
B2 - Claim Role	Claim Role
B2 - Claim Role	Claim Witness
B2 - Claim Role	Claimant
B2 - Claim Role	Claimee
B2 - Claim Role	Driver
B2 - Claim Role	Health Care Provider
B2 - Claim Role	Independent Adjuster
B2 - Claim Role	Inhouse Adjuster
B2 - Claim Role	Inpatient
B2 - Claim Role	Loss Payee
B2 - Claim Role	Outpatient
B2 - Claim Role	Party
B2 - Claim Role	Party Role
B2 - Claim Role	Patient
B2 - Claim Role	Provider
B2 - Claim Role	Public Adjuster
B2 - Claim Role	Service Provider
B2 - Claim Role	Staff Role
B2 - Claim Role	Third Party Administrator
B2 - Claim Role	Victim
B3 - Staffing Role	Accountability
B3 - Staffing Role	Agreement
B3 - Staffing Role	Agreement Party Role
B3 - Staffing Role	Consultant Contract
B3 - Staffing Role	Employment Agreement
B3 - Staffing Role	Grouping
B3 - Staffing Role	Manager
B3 - Staffing Role	Organization

Subject Area Name	Entity Name
B3 - Staffing Role	Party
B3 - Staffing Role	Party Relationship
B3 - Staffing Role	Party Relationship Role
B3 - Staffing Role	Party Role
B3 - Staffing Role	Person
B3 - Staffing Role	Staff
B3 - Staffing Role	Staff Classification
B3 - Staffing Role	Staff Position
B3 - Staffing Role	Staff Position Assignment
B3 - Staffing Role	Staff Role
B3 - Staffing Role	Staff Work Assignment
B3 - Staffing Role	Staffing Agreement
B3 - Staffing Role	Staffing Organization
B3 - Staffing Role	Team Leader
B3 - Staffing Role	Team Member
B3 - Staffing Role	Third Party Staffing Agreement
B1 - Agreement Role	Subcontractor
B1 - Agreement Role	Supplier
B1 - Agreement Role	Team Leader
B1 - Agreement Role	Team Member
B1 - Agreement Role	Third Party Administrator
B2 - Claim Role	Adjuster
B2 - Claim Role	Attorney
B2 - Claim Role	Claim
B2 - Claim Role	Claim Administrator
B2 - Claim Role	Claim Examiner
B2 - Claim Role	Claim Expert
B2 - Claim Role	Claim Fraud Examiner
B2 - Claim Role	Claim Legal Expert
B2 - Claim Role	Claim Party Role

Subject Area Name	Entity Name
B2 - Claim Role	Claim Representative
B2 - Claim Role	Claim Role
B2 - Claim Role	Claim Witness
B2 - Claim Role	Claimant
B2 - Claim Role	Claimee
B2 - Claim Role	Driver
B2 - Claim Role	Health Care Provider
B2 - Claim Role	Independent Adjuster
B2 - Claim Role	Inhouse Adjuster
B2 - Claim Role	Inpatient
B2 - Claim Role	Loss Payee
B2 - Claim Role	Outpatient
B2 - Claim Role	Party
B2 - Claim Role	Party Role
B2 - Claim Role	Patient
B2 - Claim Role	Provider
B2 - Claim Role	Public Adjuster
B2 - Claim Role	Service Provider
B2 - Claim Role	Staff Role
B2 - Claim Role	Third Party Administrator
B2 - Claim Role	Victim
B3 - Staffing Role	Accountability
B3 - Staffing Role	Agreement
B3 - Staffing Role	Agreement Party Role
B3 - Staffing Role	Consultant Contract
B3 - Staffing Role	Employment Agreement
B3 - Staffing Role	Grouping
B3 - Staffing Role	Manager
B3 - Staffing Role	Organization
B3 - Staffing Role	Party



Subject Area Name	Entity Name
B3 - Staffing Role	Party Relationship
B3 - Staffing Role	Party Relationship Role
B3 - Staffing Role	Party Role
B3 - Staffing Role	Person
B3 - Staffing Role	Staff
B3 - Staffing Role	Staff Classification
B3 - Staffing Role	Staff Position
B3 - Staffing Role	Staff Position Assignment
B3 - Staffing Role	Staff Role
B3 - Staffing Role	Staff Work Assignment
B3 - Staffing Role	Staffing Agreement
B3 - Staffing Role	Staffing Organization
B3 - Staffing Role	Team Leader
B3 - Staffing Role	Team Member
B3 - Staffing Role	Third Party Staffing Agreement
B3 - Staffing Role	Staff Classification
B3 - Staffing Role	Staff Position
B3 - Staffing Role	Staff Position Assignment
B3 - Staffing Role	Staff Role
B3 - Staffing Role	Staff Work Assignment
B3 - Staffing Role	Staffing Agreement
B3 - Staffing Role	Staffing Organization
B3 - Staffing Role	Team Leader
B3 - Staffing Role	Team Member
B3 - Staffing Role	Third Party Staffing Agreement
C1 - Party Subtype	Administrative Organization Unit
C1 - Party Subtype	Branch Office
C1 - Party Subtype	Department
C1 - Party Subtype	Field Organization Unit
C1 - Party Subtype	For Profit Organization

Subject Area Name	Entity Name
C1 - Party Subtype	Government Organization
C1 - Party Subtype	Grouping
C1 - Party Subtype	Household
C1 - Party Subtype	Not For Profit Organization
C1 - Party Subtype	Organization
C1 - Party Subtype	Organization Unit
C1 - Party Subtype	Party
C1 - Party Subtype	Party Relationship
C1 - Party Subtype	Person
C1 - Party Subtype	Professional Group
C1 - Party Subtype	Project
C1 - Party Subtype	Regional Office
C1 - Party Subtype	Staff Position Assignment
C1 - Party Subtype	Team
C1 - Party Subtype	Territory
C2 - Insurable Object Subtype	Animal
C2 - Insurable Object Subtype	Automobile
C2 - Insurable Object Subtype	Boat
C2 - Insurable Object Subtype	Body Object
C2 - Insurable Object Subtype	Bus
C2 - Insurable Object Subtype	Combination Structure
C2 - Insurable Object Subtype	Combine
C2 - Insurable Object Subtype	Commercial Structure
C2 - Insurable Object Subtype	Construction Vehicle
C2 - Insurable Object Subtype	Dwelling
C2 - Insurable Object Subtype	Farm Equipment
C2 - Insurable Object Subtype	Freight Group
C2 - Insurable Object Subtype	Geographic Location
C2 - Insurable Object Subtype	Household
C2 - Insurable Object Subtype	Household Content

Subject Area Name	Entity Name
C2 - Insurable Object Subtype	Insurable Object
C2 - Insurable Object Subtype	Manufactured Object
C2 - Insurable Object Subtype	Milking Machine
C2 - Insurable Object Subtype	Mobile Home
C2 - Insurable Object Subtype	Motorcycle
C2 - Insurable Object Subtype	Property In Transit
C2 - Insurable Object Subtype	Recreational Vehicle
C2 - Insurable Object Subtype	Residential Structure
C2 - Insurable Object Subtype	Scheduled Item
C2 - Insurable Object Subtype	Structure
C2 - Insurable Object Subtype	Tractor
C2 - Insurable Object Subtype	Trailer
C2 - Insurable Object Subtype	Transportation Class
C2 - Insurable Object Subtype	Truck
C2 - Insurable Object Subtype	Van
C2 - Insurable Object Subtype	Vehicle
C2 - Insurable Object Subtype	Watercraft
C2 - Insurable Object Subtype	Workers Comp Class
C3 - Money Subtype	Assumed Claim Amount
C3 - Money Subtype	Assumed Policy Amount
C3 - Money Subtype	Ceded Claim Amount
C3 - Money Subtype	Ceded Policy Amount
C3 - Money Subtype	Claim Amount
C3 - Money Subtype	Claim Payment
C3 - Money Subtype	Claim Reserve
C3 - Money Subtype	Credit Claim Amount
C3 - Money Subtype	Credit Policy Amount
C3 - Money Subtype	Debit Claim Amount
C3 - Money Subtype	Debit Policy Amount
C3 - Money Subtype	Deductible Recovery

Subject Area Name	Entity Name
C3 - Money Subtype	Direct Claim Amount
C3 - Money Subtype	Direct Policy Amount
C3 - Money Subtype	Expense Payment
C3 - Money Subtype	Expense Recovery
C3 - Money Subtype	Expense Reserve
C3 - Money Subtype	Fee
C3 - Money Subtype	Loss Payment
C3 - Money Subtype	Loss Recovery
C3 - Money Subtype	Loss Reserve
C3 - Money Subtype	Policy Amount
C3 - Money Subtype	Premium
C3 - Money Subtype	Recovery
C3 - Money Subtype	Reinsurance Recovery
C3 - Money Subtype	Salvage
C3 - Money Subtype	Subrogation
C3 - Money Subtype	Surcharge
C3 - Money Subtype	Tax
C4 - Event Subtype	Audit
C4 - Event Subtype	Binding
C4 - Event Subtype	Business Event
C4 - Event Subtype	Cancel
C4 - Event Subtype	Claim Event
C4 - Event Subtype	Endorsement
C4 - Event Subtype	Event
C4 - Event Subtype	Flat
C4 - Event Subtype	Full Term
C4 - Event Subtype	Life Event
C4 - Event Subtype	Mid Term
C4 - Event Subtype	New Business
C4 - Event Subtype	Policy

Subject Area Name	Entity Name
C4 - Event Subtype	Policy Event
C4 - Event Subtype	Pre Qualification
C4 - Event Subtype	Pro Rata
C4 - Event Subtype	Quote
C4 - Event Subtype	Reinstatement
C4 - Event Subtype	Renewal
C4 - Event Subtype	Short Rate
D1 - Product Coverage Reference	Company
D1 - Product Coverage Reference	Company Jurisdiction
D1 - Product Coverage Reference	Coverage
D1 - Product Coverage Reference	Coverage Group
D1 - Product Coverage Reference	Coverage Level
D1 - Product Coverage Reference	Coverage Limit Type
D1 - Product Coverage Reference	Coverage Part
D1 - Product Coverage Reference	Coverage Type
D1 - Product Coverage Reference	Geographic Location
D1 - Product Coverage Reference	Insurance Class
D1 - Product Coverage Reference	Insurance Rating Classification Code
D1 - Product Coverage Reference	Line Of Business
D1 - Product Coverage Reference	Line Of Business Group
D1 - Product Coverage Reference	Product
D1 - Product Coverage Reference	Product Coverage
D1 - Product Coverage Reference	Product License
D1 - Product Coverage Reference	Rating Territory
D1 - Product Coverage Reference	Rating Territory Geographic Location
D1 - Product Coverage Reference	State

### 3.3.2 Entity Attributes

This section lists all the attributes within an entity shown on a data model.

Log. Seq.	Entity Name	Attribute Name	Required	Is PK	Is FK	Domain Name
1	Account	Account Identifier	Yes	Yes	No	Account Identifier
2	Account	Account Name	No	No	No	Medium Name
3	Account	Account Type Code	No	No	No	Account Type Code
4	Account Agreement	Account Identifier	Yes	Yes	Yes	Account Identifier
5	Account Agreement	Agreement Identifier	Yes	Yes	Yes	Agreement Identifier
6	Account Party Role	Account Identifier	Yes	Yes	Yes	Account Identifier
7	Account Party Role	Party Identifier	Yes	Yes	Yes	Party Identifier
8	Account Party Role	Party Role Code	Yes	Yes	Yes	Party Role Code
9	Account Provider	Party Role Code	Yes	Yes	Yes	Party Role Code
10	Account Role	Party Role Code	Yes	Yes	Yes	Party Role Code
11	Accountability	Party Role Code	Yes	Yes	Yes	Party Role Code
12	Additional Interest	Party Role Code	Yes	Yes	Yes	Party Role Code
13	Adjuster	Party Role Code	Yes	Yes	Yes	Party Role Code
14	Administrative Organization Unit	Organization Identifier	Yes	Yes	Yes	Organization Identifier

15	Agency Contract	Agreement Identifier	Yes	Yes	Yes	Agreement Identifier
16	Agent	Party Role Code	Yes	Yes	Yes	Party Role Code
17	Agreement	Agreement Identifier	Yes	Yes	No	Agreement Identifier
18	Agreement	Agreement Name	No	No	No	Medium Name
19	Agreement	Agreement Original Inception Date	No	No	No	Inception Date
20	Agreement	Agreement Type Code	No	No	No	Agreement Type Code
21	Agreement	Product Identifier	No	No	Yes	Product Identifier
22	Agreement Assessment	Agreement Identifier	Yes	Yes	Yes	Agreement Identifier
23	Agreement Assessment	Assessment Identifier	Yes	Yes	Yes	Assessment Identifier
24	Agreement Party Role	Agreement Identifier	Yes	Yes	Yes	Agreement Identifier
25	Agreement Party Role	Effective Date	Yes	Yes	No	Effective Date
26	Agreement Party Role	Expiration Date	No	No	No	Expiration Date
27	Agreement Party Role	Party Identifier	Yes	Yes	Yes	Party Identifier
28	Agreement Party Role	Party Role Code	Yes	Yes	Yes	Party Role Code
29	Agreement Role	Party Role Code	Yes	Yes	Yes	Party Role Code
30	Animal	Insurable Object Identifier	Yes	Yes	Yes	Insurable Object Identifier
31	Approval	Assessment Result Identifier	Yes	Yes	Yes	Assessment Result Identifier
32	Arbitration	Arbitration Description	No	No	No	Long Description

33	Arbitration	Arbitration Identifier	Yes	Yes	No	Arbitration Identifier
34	Arbitration Party Role	Arbitration Identifier	Yes	Yes	Yes	Arbitration Identifier
35	Arbitration Party Role	Begin Date	Yes	Yes	No	Begin Date
36	Arbitration Party Role	Claim Identifier	Yes	Yes	Yes	Claim Identifier
37	Arbitration Party Role	End Date	No	No	No	End Date
38	Arbitration Party Role	Party Identifier	Yes	Yes	Yes	Party Identifier
39	Arbitration Party Role	Party Role Code	Yes	Yes	Yes	Party Role Code
40	Assesment Party Role	Assessment Identifier	Yes	Yes	Yes	Assessment Identifier
41	Assesment Party Role	Begin Date	No	No	No	Begin Date
42	Assesment Party Role	End Date	No	No	No	End Date
43	Assesment Party Role	Party Identifier	Yes	Yes	Yes	Party Identifier
44	Assesment Party Role	Party Role Code	Yes	Yes	Yes	Party Role Code
45	Assessment	Assessment Description	No	No	No	Long Description
46	Assessment	Assessment Identifier	Yes	Yes	No	Assessment Identifier
47	Assessment	Assessment Reason Description	No	No	No	Medium Description
48	Assessment	Begin Date	No	No	No	Begin Date
49	Assessment	End Date	No	No	No	End Date



50	Assessment Result	Assessment Identifier	No	No	Yes	Assessment Identifier
51	Assessment Result	Assessment Result Identifier	Yes	Yes	No	Assessment Result Identifier
52	Assessment Result	Assessment Result Type Code	No	No	No	Assessment Result Type Code
53	Assumed Claim Amount	Claim Amount Identifier	Yes	Yes	Yes	Claim Amount Identifier
54	Assumed Policy Amount	Policy Amount Identifier	Yes	Yes	Yes	Policy Amount Identifier
55	Attorney	Party Role Code	Yes	Yes	Yes	Party Role Code
56	Audit	Event Identifier	Yes	Yes	Yes	Event Identifier
57	Auditor	Party Role Code	Yes	Yes	Yes	Party Role Code
58	Auto Repair Shop Contract	Agreement Identifier	Yes	Yes	Yes	Agreement Identifier
59	Automobile	Insurable Object Identifier	Yes	Yes	Yes	Insurable Object Identifier
60	Binding	Event Identifier	Yes	Yes	Yes	Event Identifier
61	Boat	Insurable Object Identifier	Yes	Yes	Yes	Insurable Object Identifier
62	Body Object	Insurable Object Identifier	Yes	Yes	Yes	Insurable Object Identifier
63	Branch Office	Branch Office Identifier	Yes	Yes	No	Party Identifier
64	Branch Office	Organization Identifier	Yes	Yes	Yes	Organization Identifier
65	Branch Office	Regional Office Identifier	Yes	Yes	Yes	Party Identifier
66	Branch Office	Territory Identifier	Yes	Yes	Yes	Party Identifier
67	Broker	Party Role Code	Yes	Yes	Yes	Party Role Code

68	Brokerage Contract	Agreement Identifier	Yes	Yes	Yes	Agreement Identifier
69	Bus	Insurable Object Identifier	Yes	Yes	Yes	Insurable Object Identifier
70	Business Event	Event Identifier	Yes	Yes	Yes	Event Identifier
71	Buyer	Party Role Code	Yes	Yes	Yes	Party Role Code
72	Cancel	Event Identifier	Yes	Yes	Yes	Event Identifier
73	Catastrophe	Catastrophe Identifier	Yes	Yes	No	Catastrophe Identifier
74	Catastrophe	Catastrophe Name	No	No	No	Medium Name
75	Catastrophe	Catastrophe Type Code	No	No	No	Catastrophe Type Code
76	Catastrophe	Company Catastrophe Code	No	No	No	Company Catastrophe Code
77	Catastrophe	Industry Catastrophe Code	No	No	No	Industry Catastrophe Code
78	Ceded Claim Amount	Claim Amount Identifier	Yes	Yes	Yes	Claim Amount Identifier
79	Ceded Policy Amount	Policy Amount Identifier	Yes	Yes	Yes	Policy Amount Identifier
80	Channel Role	Party Role Code	Yes	Yes	Yes	Party Role Code
81	Channel Score	Assessment Result Identifier	Yes	Yes	Yes	Assessment Result Identifier
82	Claim	Catastrophe Identifier	No	No	Yes	Catastrophe Identifier
83	Claim	Claim Close Date	No	No	No	Date
84	Claim	Claim Description	No	No	No	Long Description
85	Claim	Claim Identifier	Yes	Yes	No	Claim Identifier

86	Claim	Claim Open Date	No	No	No	Date
87	Claim	Claim Reopen Date	No	No	No	Date
88	Claim	Claim Reported Date	No	No	No	Date
89	Claim	Claim Status Code	No	No	No	Claim Status Code
90	Claim	Claims Made Date	No	No	No	Date
91	Claim	Company Claim Number	No	No	No	Company Claim Number
92	Claim	Company Subclaim Number	No	No	No	Company Subclaim Number
93	Claim	Entry Into Claims Made Program Date	No	No	No	Date
94	Claim	Insurable Object Identifier	No	No	Yes	Insurable Object Identifier
95	Claim	Occurrence Identifier	No	No	Yes	Occurrence Identifier
96	Claim Administrator	Party Role Code	Yes	Yes	Yes	Party Role Code
97	Claim Amount	Amount Type Code	No	No	No	Amount Type Code
98	Claim Amount	Claim Amount	No	No	No	Amount
99	Claim Amount	Claim Amount Identifier	Yes	Yes	No	Claim Amount Identifier
100	Claim Amount	Claim Identifier	Yes	No	Yes	Claim Identifier
101	Claim Amount	Claim Offer Identifier	No	No	Yes	Claim Offer Identifier
102	Claim Amount	Event Date	No	No	No	Event Date
103	Claim Amount	Insurance Type Code	No	No	No	Insurance Type Code

104	Claim Arbitration	Arbitration Identifier	Yes	Yes	Yes	Arbitration Identifier
105	Claim Arbitration	Claim Identifier	Yes	Yes	Yes	Claim Identifier
106	Claim Assessment	Assessment Identifier	Yes	Yes	Yes	Assessment Identifier
107	Claim Assessment	Claim Identifier	Yes	Yes	Yes	Claim Identifier
108	Claim Coverage	Claim Identifier	Yes	Yes	Yes	Claim Identifier
109	Claim Coverage	Effective Date	Yes	Yes	Yes	Effective Date
110	Claim Coverage	Policy Coverage Detail Identifier	Yes	Yes	Yes	Policy Coverage Detail Identifier
111	Claim Evaluation Result	Assessment Result Identifier	Yes	Yes	Yes	Assessment Result Identifier
112	Claim Event	Event Identifier	Yes	Yes	Yes	Event Identifier
113	Claim Examiner	Party Role Code	Yes	Yes	Yes	Party Role Code
114	Claim Expert	Party Role Code	Yes	Yes	Yes	Party Role Code
115	Claim Folder	Claim Folder Label Name	No	No	No	Medium Name
116	Claim Folder	Claim Identifier	Yes	Yes	Yes	Claim Identifier
117	Claim Folder Document	Claim Identifier	Yes	Yes	Yes	Claim Identifier
118	Claim Folder Document	Document Link Value	No	No	No	Long_Variable_Value
119	Claim Folder Document	Document Sequence Number	Yes	Yes	No	Sequence Number
120	Claim Fraud Examiner	Party Role Code	Yes	Yes	Yes	Party Role Code
121	Claim Legal Expert	Party Role Code	Yes	Yes	Yes	Party Role Code
122	Claim Litigation	Claim Identifier	Yes	Yes	Yes	Claim Identifier

123	Claim Litigation	Litigation Identifier	Yes	Yes	Yes	Litigation Identifier
124	Claim Offer	Arbitration Identifier	No	No	Yes	Arbitration Identifier
125	Claim Offer	Claim Identifier	Yes	No	Yes	Claim Identifier
126	Claim Offer	Claim Offer Identifier	Yes	Yes	No	Claim Offer Identifier
127	Claim Offer	Litigation Identifier	No	No	Yes	Litigation Identifier
128	Claim Offer	Settlement Offer Amount	No	No	No	Amount
129	Claim Offer	Settlement Offer Provision Description	No	No	No	Long Description
130	Claim Party Role	Begin Date	Yes	Yes	No	Begin Date
131	Claim Party Role	Claim Identifier	Yes	Yes	Yes	Claim Identifier
132	Claim Party Role	End Date	No	No	No	End Date
133	Claim Party Role	Party Identifier	Yes	Yes	Yes	Party Identifier
134	Claim Party Role	Party Role Code	Yes	Yes	Yes	Party Role Code
135	Claim Payment	Claim Amount Identifier	Yes	Yes	Yes	Claim Amount Identifier
136	Claim Representative	Party Role Code	Yes	Yes	Yes	Party Role Code
137	Claim Reserve	Claim Amount Identifier	Yes	Yes	Yes	Claim Amount Identifier
138	Claim Role	Party Role Code	Yes	Yes	Yes	Party Role Code
139	Claim Witness	Party Role Code	Yes	Yes	Yes	Party Role Code
140	Claimant	Party Role Code	Yes	Yes	Yes	Party Role Code
141	Claimee	Party Role Code	Yes	Yes	Yes	Party Role Code
142	Combination Structure	Insurable Object Identifier	Yes	Yes	Yes	Insurable Object Identifier

143	Combine	Insurable Object Identifier	Yes	Yes	Yes	Insurable Object Identifier
144	Commercial Agreement	Agreement Identifier	Yes	Yes	Yes	Agreement Identifier
145	Commercial Structure	Insurable Object Identifier	Yes	Yes	Yes	Insurable Object Identifier
146	Communication Identity	Communication Identifier	Yes	Yes	No	Communication Identifier
147	Communication Identity	Communication Qualifier Value	No	No	No	Long_Variable_Value
148	Communication Identity	Communication Type Code	No	No	No	Communication Type Code
149	Communication Identity	Communication Value	No	No	No	Long_Variable_Value
150	Communication Identity	Geographic Location Identifier	No	No	Yes	Geographic Location Identifier
151	Commutation Agreement	Agreement Identifier	Yes	Yes	Yes	Agreement Identifier
152	Company	Company Code	No	No	No	Company Code
153	Company	Company Description	No	No	No	Code Description
154	Company	Company Identifier	Yes	Yes	No	Company Identifier
155	Company	Company Name	No	No	No	Code Name
156	Company Jurisdiction	Company Identifier	Yes	Yes	Yes	Company Identifier
157	Company Jurisdiction	Geographic Location Identifier	Yes	Yes	Yes	Geographic Location Identifier
158	Construction Vehicle	Insurable Object Identifier	Yes	Yes	Yes	Insurable Object Identifier

159	Consultant Contract	Agreement Identifier	Yes	Yes	Yes	Agreement Identifier
160	Contractor	Party Role Code	Yes	Yes	Yes	Party Role Code
161	Court Jurisdiction	Court Identifier	Yes	Yes	No	Court Identifier
162	Court Jurisdiction	Court Name	No	No	No	Medium Name
163	Court Jurisdiction	Jurisdiction Identifier	Yes	Yes	No	Jurisdiction Identifier
164	Coverage	Coverage Description	No	No	No	Long Description
165	Coverage	Coverage Group Identifier	No	No	Yes	Coverage Group Identifier
166	Coverage	Coverage Identifier	Yes	Yes	No	Coverage Identifier
167	Coverage	Coverage Name	No	No	No	Long Name
168	Coverage	Coverage Part Code	No	No	Yes	Coverage Part Code
169	Coverage	Coverage Type Identifier	No	No	Yes	Coverage Type Identifier
170	Coverage Group	Coverage Group Description	No	No	No	Medium Description
171	Coverage Group	Coverage Group Identifier	Yes	Yes	No	Coverage Group Identifier
172	Coverage Group	Coverage Group Name	No	No	No	Medium Name
173	Coverage Level	Aggregate Limit Amount	No	No	No	Amount
174	Coverage Level	Coverage Identifier	Yes	Yes	Yes	Coverage Identifier
175	Coverage Level	Coverage Label Name	No	No	No	Long Name

176	Coverage Level	Coverage Level Identifier	Yes	Yes	No	Coverage Level Identifier
177	Coverage Level	Coverage Limit Type Identifier	Yes	Yes	Yes	Coverage Limit Type Identifier
178	Coverage Level	Deductible Rate	No	No	No	Rate
179	Coverage Level	Maximum Per Claim Amount	No	No	No	Amount
180	Coverage Level	Maximum Per Person Amount	No	No	No	Amount
181	Coverage Limit Type	Coverage Limit Description	No	No	No	Medium Description
182	Coverage Limit Type	Coverage Limit Name	No	No	No	Medium Name
183	Coverage Limit Type	Coverage Limit Type Identifier	Yes	Yes	No	Coverage Limit Type Identifier
184	Coverage Part	Coverage Part Code	Yes	Yes	No	Coverage Part Code
185	Coverage Part	Coverage Part Name	No	No	No	Medium Name
186	Coverage Type	Coverage Type Description	No	No	No	Code Description
187	Coverage Type	Coverage Type Identifier	Yes	Yes	No	Coverage Type Identifier
188	Coverage Type	Coverage Type Name	No	No	No	Medium Name
189	Credit Claim Amount	Claim Amount Identifier	Yes	Yes	Yes	Claim Amount Identifier
190	Credit Policy Amount	Policy Amount Identifier	Yes	Yes	Yes	Policy Amount Identifier
191	Credit Rating	Assessment Result Identifier	Yes	Yes	Yes	Assessment Result Identifier



192	Customer	Party Role Code	Yes	Yes	Yes	Party Role Code
193	Customer Score	Assessment Result Identifier	Yes	Yes	Yes	Assessment Result Identifier
194	Debit Claim Amount	Claim Amount Identifier	Yes	Yes	Yes	Claim Amount Identifier
195	Debit Policy Amount	Policy Amount Identifier	Yes	Yes	Yes	Policy Amount Identifier
196	Deductible Recovery	Claim Amount Identifier	Yes	Yes	Yes	Claim Amount Identifier
197	Demographic Score	Assessment Result Identifier	Yes	Yes	Yes	Assessment Result Identifier
198	Department	Department Identifier	Yes	Yes	No	Organization Identifier
199	Department	Organization Identifier	Yes	Yes	Yes	Organization Identifier
200	Derivative Contract	Agreement Identifier	Yes	Yes	Yes	Agreement Identifier
201	Direct Claim Amount	Claim Amount Identifier	Yes	Yes	Yes	Claim Amount Identifier
202	Direct Policy Amount	Policy Amount Identifier	Yes	Yes	Yes	Policy Amount Identifier
203	Driver	Party Role Code	Yes	Yes	Yes	Party Role Code
204	Dwelling	Insurable Object Identifier	Yes	Yes	Yes	Insurable Object Identifier
205	Employment Agreement	Agreement Identifier	Yes	Yes	Yes	Agreement Identifier
206	Endorsement	Event Identifier	Yes	Yes	Yes	Event Identifier
207	Event	Event Identifier	Yes	Yes	No	Event Identifier
208	Expense Payment	Claim Amount Identifier	Yes	Yes	Yes	Claim Amount Identifier

209	Expense Recovery	Claim Amount Identifier	Yes	Yes	Yes	Claim Amount Identifier
210	Expense Reserve	Claim Amount Identifier	Yes	Yes	Yes	Claim Amount Identifier
211	Farm Equipment	Insurable Object Identifier	Yes	Yes	Yes	Legal Jurisdiction Identifier
212	Fee	Policy Amount Identifier	Yes	Yes	Yes	Policy Amount Identifier
213	Field Organization Unit	Organization Identifier	Yes	Yes	Yes	Organization Identifier
214	Financial Account Agreement	Agreement Identifier	Yes	Yes	Yes	Agreement Identifier
215	Financial Adviser	Party Role Code	Yes	Yes	Yes	Party Role Code
216	Financial Analyst	Party Role Code	Yes	Yes	Yes	Party Role Code
217	Financial Interest Role	Party Role Code	Yes	Yes	Yes	Party Role Code
218	Financial Service	Party Role Code	Yes	Yes	Yes	Party Role Code
219	Financial Services Assessment	Assessment Result Identifier	Yes	Yes	Yes	Assessment Result Identifier
220	Financial Valuation	Assessment Result Identifier	Yes	Yes	Yes	Assessment Result Identifier
221	Flat	Event Identifier	Yes	Yes	Yes	Event Identifier
222	For Profit Organization	Organization Identifier	Yes	Yes	Yes	Organization Identifier
223	Fraud Assessment	Assessment Result Identifier	Yes	Yes	Yes	Assessment Result Identifier
224	Freight Group	Insurable Object Identifier	Yes	Yes	Yes	Insurable Object Identifier
225	Full Term	Event Identifier	Yes	Yes	Yes	Event Identifier

226	Geographic Location	Geographic Location Identifier	Yes	Yes	No	Geographic Location Identifier
227	Geographic Location	Geographic Location Type Code	No	No	No	Geographic Location Type Code
228	Geographic Location	Location Address Identifier	No	No	Yes	Location Address Identifier
229	Geographic Location	Location Code	No	No	No	Location Code
230	Geographic Location	Location Name	No	No	No	Medium Name
231	Geographic Location	Location Number	No	No	No	Medium_Variable Value
232	Geographic Location	Parent Geographic Location Identifier	No	No	Yes	Geographic Location Identifier
233	Geographic Location	Physical Location Identifier	No	No	Yes	Physical Location Identifier
234	Geographic Location	State Code	No	No	Yes	State Code
235	Government Organization	Organization Identifier	Yes	Yes	Yes	Organization Identifier
236	Group Agreement	Agreement Identifier	Yes	Yes	Yes	Agreement Identifier
237	Grouping	Grouping Identifier	Yes	Yes	Yes	Grouping Identifier
238	Grouping	Grouping Name	No	No	No	Medium Name
239	Health Care Provider	Party Role Code	Yes	Yes	Yes	Party Role Code
240	Household	Household Identifier	Yes	Yes	Yes	Grouping Identifier
241	Household Content	Household Identifier	No	No	Yes	Grouping Identifier

242	Household Content	Insurable Object Identifier	Yes	Yes	Yes	Insurable Object Identifier
243	Household Person	Household Identifier	Yes	Yes	Yes	Grouping Identifier
244	Household Person	Person Identifier	Yes	Yes	Yes	Person Identifier
245	Household Person Role	Begin Date	Yes	Yes	No	Begin Date
246	Household Person Role	End Date	No	No	No	End Date
247	Household Person Role	Household Identifier	Yes	Yes	Yes	Grouping Identifier
248	Household Person Role	Party Role Code	Yes	Yes	Yes	Party Role Code
249	Household Person Role	Person Identifier	Yes	Yes	Yes	Person Identifier
250	Independent Adjuster	Party Role Code	Yes	Yes	Yes	Party Role Code
251	Individual Agreement	Agreement Identifier	Yes	Yes	Yes	Agreement Identifier
252	Inhouse Adjuster	Party Role Code	Yes	Yes	Yes	Party Role Code
253	Inpatient	Party Role Code	Yes	Yes	Yes	Party Role Code
254	Insurable Object	Geographic Location Identifier	No	No	Yes	Geographic Location Identifier
255	Insurable Object	Insurable Object Identifier	Yes	Yes	No	Insurable Object Identifier
256	Insurable Object	Insurable Object Type Code	No	No	No	Insurable Object Type Code
257	Insurable Object Party Role	Effective Date	Yes	Yes	No	Effective Date

258	Insurable Object Party Role	Expiration Date	No	No	No	Expiration Date
259	Insurable Object Party Role	Insurable Object Identifier	Yes	Yes	Yes	Insurable Object Identifier
260	Insurable Object Party Role	Party Identifier	Yes	Yes	Yes	Party Identifier
261	Insurable Object Party Role	Party Role Code	Yes	Yes	Yes	Party Role Code
262	Insurance Class	Insurance Class Description	No	No	No	Code Description
263	Insurance Class	Insurance Class Identifier	Yes	Yes	No	Insurance Class Identifier
264	Insurance Class	Insurance Class Name	No	No	No	Code Name
265	Insured	Party Role Code	Yes	Yes	Yes	Party Role Code
266	Insured Account	Account Identifier	Yes	Yes	Yes	Account Identifier
267	Insurer	Party Role Code	Yes	Yes	Yes	Party Role Code
268	Intermediary Agreement	Agreement Identifier	Yes	Yes	Yes	Agreement Identifier
269	Legal Adviser	Party Role Code	Yes	Yes	Yes	Party Role Code
270	Legal Jurisdiction	Legal Jurisdiction Description	No	No	No	Code Description
271	Legal Jurisdiction	Legal Jurisdiction Identifier	Yes	Yes	No	Legal Jurisdiction Identifier
272	Legal Jurisdiction	Legal Jurisdiction Name	No	No	No	Code Name
273	Legal Jurisdiction	Rules Reference Description	No	No	No	Long Description
274	Legal Jurisdiction Party Identity	Legal Classification Code	No	No	No	Legal Classification Code

275	Legal Jurisdiction Party Identity	Legal Entity Type Code	No	No	No	Legal Entity Type Code
276	Legal Jurisdiction Party Identity	Legal Jurisdiction Identifier	Yes	Yes	Yes	Legal Jurisdiction Identifier
277	Legal Jurisdiction Party Identity	Legal Jurisdiction Party Identifier	No	No	No	Legal Jurisdiction Party Identifier
278	Legal Jurisdiction Party Identity	Party Identifier	Yes	Yes	Yes	Party Identifier
279	Life Event	Event Identifier	Yes	Yes	Yes	Event Identifier
280	Line Of Business	Insurance Class Identifier	Yes	No	Yes	Insurance Class Identifier
281	Line Of Business	Line Of Business Code	No	No	No	Line Of Business Code
282	Line Of Business	Line Of Business Description	No	No	No	Code Description
283	Line Of Business	Line Of Business Group Identifier	Yes	No	Yes	Line Of Business Group Identifier
284	Line Of Business	Line Of Business Identifier	Yes	Yes	No	Line Of Business Identifier
285	Line Of Business	Line Of Business Name	No	No	No	Code Name
286	Line Of Business Group	Line Of Business Group Description	No	No	No	Code Description
287	Line Of Business Group	Line Of Business Group Identifier	Yes	Yes	No	Line Of Business Group Identifier
288	Line Of Business Group	Line Of Business Group Name	No	No	No	Code Name
289	Litigation	Court Identifier	No	No	Yes	Court Identifier
290	Litigation	Jurisdiction Identifier	No	No	Yes	Jurisdiction Identifier
291	Litigation	Litigation Description	No	No	No	Long Description

292	Litigation	Litigation Identifier	Yes	Yes	No	Litigation Identifier
293	Litigation Party Role	Begin Date	Yes	Yes	No	Begin Date
294	Litigation Party Role	Claim Identifier	Yes	Yes	Yes	Claim Identifier
295	Litigation Party Role	End Date	No	No	No	End Date
296	Litigation Party Role	Litigation Identifier	Yes	Yes	Yes	Litigation Identifier
297	Litigation Party Role	Party Identifier	Yes	Yes	Yes	Party Identifier
298	Litigation Party Role	Party Role Code	Yes	Yes	Yes	Party Role Code
299	Location Address	Begin Date	No	No	No	Begin Date
300	Location Address	Country Code	No	No	No	Country Code
301	Location Address	End Date	No	No	No	End Date
302	Location Address	Line 1 Address	No	No	No	Medium Address
303	Location Address	Line 2 Address	No	No	No	Medium Address
304	Location Address	Location Address Identifier	Yes	Yes	No	Location Address Identifier
305	Location Address	Municipality Name	No	No	No	Medium Name
306	Location Address	Postal Code	No	No	No	Postal Code
307	Location Address	State Code	No	No	Yes	State Code
308	Loss Payee	Party Role Code	Yes	Yes	Yes	Party Role Code
309	Loss Payment	Claim Amount Identifier	Yes	Yes	Yes	Claim Amount Identifier
310	Loss Recovery	Claim Amount Identifier	Yes	Yes	Yes	Claim Amount Identifier
311	Loss Reserve	Claim Amount Identifier	Yes	Yes	Yes	Claim Amount Identifier

312	Manager	Party Role Code	Yes	Yes	Yes	Party Role Code
313	Managing General Agent	Party Role Code	Yes	Yes	Yes	Party Role Code
314	Manufactured Object	Insurable Object Identifier	Yes	Yes	Yes	Insurable Object Identifier
315	Medical Condition	Assessment Result Identifier	Yes	Yes	Yes	Assessment Result Identifier
316	Mid Term	Event Identifier	Yes	Yes	Yes	Event Identifier
317	Milking Machine	Insurable Object Identifier	Yes	Yes	Yes	Insurable Object Identifier
318	Mobile Home	Insurable Object Identifier	Yes	Yes	Yes	Insurable Object Identifier
319	Motorcycle	Insurable Object Identifier	Yes	Yes	Yes	Insurable Object Identifier
320	Mutual Fund Provider	Party Role Code	Yes	Yes	Yes	Party Role Code
321	New Business	Event Identifier	Yes	Yes	Yes	Event Identifier
322	Not For Profit Organization	Organization Identifier	Yes	Yes	Yes	Organization Identifier
323	Object Assessment	Assessment Identifier	Yes	Yes	Yes	Assessment Identifier
324	Object Assessment	Insurable Object Identifier	Yes	Yes	Yes	Insurable Object Identifier
325	Occurrence	Catastrophic Event Indicator	No	No	No	Indicator
326	Occurrence	Geographic Location Identifier	No	No	Yes	Geographic Location Identifier
327	Occurrence	Occurrence Begin Date	No	No	No	Begin Date
328	Occurrence	Occurrence Begin Time	No	No	No	Time



329	Occurrence	Occurrence End Date	No	No	No	End Date
330	Occurrence	Occurrence End Time	No	No	No	Time
331	Occurrence	Occurrence Identifier	Yes	Yes	No	Occurrence Identifier
332	Occurrence	Occurrence Name	No	No	No	Medium Name
333	Organization	Acronym Name	No	No	No	Short Name
334	Organization	Alternate Name	No	No	No	Long Name
335	Organization	Dun And Bradstreet Identifier	No	No	No	Dun And Bradstreet Identifier
336	Organization	Industry Code	No	No	No	Industry Code
337	Organization	Industry Type Code	No	No	No	Industry Type Code
338	Organization	Organization Description	No	No	No	Long Description
339	Organization	Organization Identifier	Yes	Yes	Yes	Organization Identifier
340	Organization	Organization Name	No	No	No	Medium Name
341	Organization	Organization Type Code	No	No	No	Organization Type Code
342	Organization Unit	Accounting Code	No	No	No	Accounting Code
343	Organization Unit	Industry Code	No	No	No	Industry Code
344	Organization Unit	Organization Identifier	Yes	Yes	Yes	Organization Identifier
345	Organization Unit	Organization Unit Description	No	No	No	Medium Description
346	Organization Unit	Organization Unit Name	No	No	No	Medium Name
347	Organization Unit	Work Site Type Code	No	No	No	Work Site Type Code

348	Other Assessment Result	Assessment Result Identifier	Yes	Yes	Yes	Assessment Result Identifier
349	Outpatient	Party Role Code	Yes	Yes	Yes	Party Role Code
350	Party	Begin Date	No	No	No	Begin Date
351	Party	End Date	No	No	No	End Date
352	Party	Party Identifier	Yes	Yes	No	Party Identifier
353	Party	Party Name	No	No	No	Medium Name
354	Party	Party Type Code	No	No	No	Party Type Code
355	Party Assessment	Assessment Identifier	Yes	Yes	Yes	Assessment Identifier
356	Party Assessment	Party Identifier	Yes	Yes	Yes	Party Identifier
357	Party Assessment	Person Identifier	Yes	Yes	Yes	Person Identifier
358	Party Communication	Begin Date	Yes	Yes	No	Begin Date
359	Party Communication	Communication Identifier	Yes	Yes	Yes	Communication Identifier
360	Party Communication	End Date	No	No	No	End Date
361	Party Communication	Party Identifier	Yes	Yes	Yes	Party Identifier
362	Party Communication	Party Locality Code	Yes	Yes	No	Locality Code
363	Party Communication	Party Routing Description	No	No	No	Medium Description
364	Party Communication	Preference Day And Time Group Code	No	No	No	Day And Time Group Code
365	Party Communication	Preference Sequence Number	No	No	No	Sequence Number
366	Party Preference	Party Identifier	Yes	Yes	Yes	Party Identifier

367	Party Preference	Preferred Language Code	No	No	No	Language Code
368	Party Relationship	Begin Date	Yes	Yes	No	Begin Date
369	Party Relationship	End Date	No	No	No	End Date
370	Party Relationship	Party Identifier	Yes	Yes	Yes	Party Identifier
371	Party Relationship	Related Party Identifier	Yes	Yes	Yes	Party Identifier
372	Party Relationship	Relationship Type Code	Yes	Yes	No	Relationship Type Code
373	Party Relationship Role	Party Identifier	Yes	Yes	Yes	Party Identifier
374	Party Relationship Role	Party Role Code	Yes	Yes	Yes	Party Role Code
375	Party Relationship Role	Related Party Identifier	Yes	Yes	Yes	Party Identifier
376	Party Relationship Role	Relationship Begin Date	Yes	Yes	Yes	Begin Date
377	Party Relationship Role	Relationship Type Code	Yes	Yes	Yes	Relationship Type Code
378	Party Relationship Role	Role Begin Date	Yes	Yes	No	Begin Date
379	Party Role	Party Role Code	Yes	Yes	No	Party Role Code
380	Party Role	Party Role Description	No	No	No	Code Description
381	Party Role	Party Role Name	No	No	No	Code Name
382	Patient	Party Role Code	Yes	Yes	Yes	Party Role Code
383	Person	Birth Date	No	No	No	Date
384	Person	Birth Place Name	No	No	No	Medium Name
385	Person	First Name	No	No	No	Short Name
386	Person	Full Legal Name	No	No	No	Medium Name
387	Person	Gender Code	No	No	No	Gender Code

388	Person	Last Name	No	No	No	Short Name
389	Person	Middle Name	No	No	No	Short Name
390	Person	Nickname	No	No	No	Short Name
391	Person	Person Identifier	Yes	Yes	Yes	Person Identifier
392	Person	Prefix Name	No	No	No	Prefix-Suffix Name
393	Person	Suffix Name	No	No	No	Prefix-Suffix Name
394	Person Profession	Person Identifier	Yes	Yes	Yes	Person Identifier
395	Person Profession	Profession Name	No	No	No	Medium Name
396	Physical Location	Altitude Mean Sea Level Value	No	No	No	Medium_Variable Value
397	Physical Location	Altitude Value	No	No	No	Medium_Variable Value
398	Physical Location	Horizontal Accuracy Value	No	No	No	Medium_Variable Value
399	Physical Location	Latitude Value	No	No	No	Latitude Or Longitude
400	Physical Location	Location Address Identifier	No	No	Yes	Location Address Identifier
401	Physical Location	Longitude Value	No	No	No	Latitude Or Longitude
402	Physical Location	Physical Location Identifier	Yes	Yes	No	Physical Location Identifier
403	Physical Location	Physical Location Name	No	No	No	Medium Name
404	Physical Location	Travel Direction Description	No	No	No	Medium Description
405	Physical Location	Vertical Accuracy Value	No	No	No	Medium_Variable Value
406	Physical Object Assessment	Assessment Result Identifier	Yes	Yes	Yes	Assessment Result Identifier

407	Place Assessment	Assessment Result Identifier	Yes	Yes	Yes	Assessment Result Identifier
408	Policy	Effective Date	No	No	No	Effective Date
409	Policy	Expiration Date	No	No	No	Expiration Date
410	Policy	Geographic Location Identifier	No	No	Yes	Geographic Location Identifier
411	Policy	Policy Identifier	Yes	Yes	Yes	Agreement Identifier
412	Policy	Policy Number	No	No	No	Policy Number Value
413	Policy	Status Code	No	No	No	Status Code
414	Policy Amount	Amount Type Code	No	No	No	Account Type Code
415	Policy Amount	Earning Begin Date	No	No	No	Begin Date
416	Policy Amount	Earning End Date	No	No	No	End Date
417	Policy Amount	Effective Date	No	No	Yes	Effective Date
418	Policy Amount	Geographic Location Identifier	Yes	No	Yes	Geographic Location Identifier
419	Policy Amount	Insurable Object Identifier	No	No	Yes	Insurable Object Identifier
420	Policy Amount	Insurance Type Code	No	No	No	Insurance Type Code
421	Policy Amount	Policy Amount	No	No	No	Amount
422	Policy Amount	Policy Amount Identifier	Yes	Yes	No	Policy Amount Identifier
423	Policy Amount	Policy Coverage Detail Identifier	No	No	Yes	Policy Coverage Detail Identifier
424	Policy Amount	Policy Identifier	No	No	Yes	Agreement Identifier
425	Policy Coverage Detail	Coverage Description	No	No	No	Medium Description

426	Policy Coverage Detail	Coverage Identifier	Yes	No	Yes	Coverage Identifier
427	Policy Coverage Detail	Coverage Inclusion Exclusion Code	No	No	No	Coverage Inclusion Exclusion Code
428	Policy Coverage Detail	Coverage Part Code	Yes	No	Yes	Coverage Part Code
429	Policy Coverage Detail	Effective Date	Yes	Yes	No	Effective Date
430	Policy Coverage Detail	Expiration Date	No	No	No	Expiration Date
431	Policy Coverage Detail	Insurable Object Identifier	Yes	No	Yes	Insurable Object Identifier
432	Policy Coverage Detail	Policy Coverage Detail Identifier	Yes	Yes	No	Policy Coverage Detail Identifier
433	Policy Coverage Detail	Policy Identifier	Yes	No	Yes	Agreement Identifier
434	Policy Coverage Part	Coverage Part Code	Yes	Yes	Yes	Coverage Part Code
435	Policy Coverage Part	Policy Identifier	Yes	Yes	Yes	Agreement Identifier
436	Policy Deductible	Deductible Basis Code	No	No	No	Deductible Basis Code
437	Policy Deductible	Deductible Type Code	No	No	No	Deductible Type Code
438	Policy Deductible	Deductible Value	No	No	No	Deductible Value
439	Policy Deductible	Effective Date	No	No	Yes	Effective Date
440	Policy Deductible	Policy Coverage Detail Identifier	No	No	Yes	Policy Coverage Detail Identifier
441	Policy Deductible	Policy Deductible Identifier	Yes	Yes	No	Policy Deductible Identifier
442	Policy Event	Effective Date	No	No	No	Effective Date
443	Policy Event	Event Date	No	No	No	Event Date

444	Policy Event	Event Identifier	Yes	Yes	Yes	Event Identifier
445	Policy Event	Event Sub Type Code	No	No	No	Event Sub Type Code
446	Policy Event	Event Type Code	No	No	No	Event Type Code
447	Policy Event	Policy Identifier	No	No	Yes	Agreement Identifier
448	Policy Form	Form Value	No	No	No	Policy Form Value
449	Policy Form	Policy Form Number	Yes	Yes	No	Policy Form Value
450	Policy Form	Policy Identifier	Yes	Yes	Yes	Agreement Identifier
451	Policy Limit	Effective Date	No	No	Yes	Effective Date
452	Policy Limit	Limit Basis Code	No	No	No	Limit Basis Code
453	Policy Limit	Limit Type Code	No	No	No	Limit Type Code
454	Policy Limit	Limit Value	No	No	No	Limit Value
455	Policy Limit	Policy Coverage Detail Identifier	No	No	Yes	Policy Coverage Detail Identifier
456	Policy Limit	Policy Limit Identifier	Yes	Yes	No	Policy Limit Identifier
457	Policy Relationship	Effective Date	Yes	Yes	No	Effective Date
458	Policy Relationship	Expiration Date	No	No	No	Expiration Date
459	Policy Relationship	Policy Identifier	Yes	Yes	Yes	Agreement Identifier
460	Policy Relationship	Related Policy Identifier	Yes	Yes	Yes	Agreement Identifier
461	Policy Relationship	Relationship Code	Yes	Yes	No	Relationship Code
462	Pre Qualification	Event Identifier	Yes	Yes	Yes	Event Identifier
463	Premium	Policy Amount Identifier	Yes	Yes	Yes	Policy Amount Identifier
464	Premium Auditor	Party Role Code	Yes	Yes	Yes	Party Role Code

465	Pro Rata	Event Identifier	Yes	Yes	Yes	Event Identifier
466	Producer	Party Role Code	Yes	Yes	Yes	Party Role Code
467	Product	Licensed Product Name	No	No	No	Medium Name
468	Product	Line Of Business Identifier	Yes	No	Yes	Line Of Business Identifier
469	Product	Product Description	No	No	No	Medium Description
470	Product	Product Identifier	Yes	Yes	No	Product Identifier
471	Product Coverage	Coverage Identifier	Yes	Yes	Yes	Coverage Identifier
472	Product Coverage	Product Identifier	Yes	Yes	Yes	Product Identifier
473	Product License	Company Identifier	Yes	Yes	Yes	Company Identifier
474	Product License	Effective Date	No	No	No	Effective Date
475	Product License	Expiration Date	No	No	No	Expiration Date
476	Product License	Geographic Location Identifier	Yes	Yes	Yes	Geographic Location Identifier
477	Product License	Product Identifier	Yes	Yes	Yes	Product Identifier
478	Professional Group	Grouping Identifier	Yes	Yes	Yes	Grouping Identifier
479	Project	Grouping Identifier	Yes	Yes	Yes	Grouping Identifier
480	Property In Transit	Insurable Object Identifier	Yes	Yes	Yes	Insurable Object Identifier
481	Prospect	Party Role Code	Yes	Yes	Yes	Party Role Code
482	Provider	Party Role Code	Yes	Yes	Yes	Party Role Code



483	Provider Agreement	Agreement Identifier	Yes	Yes	Yes	Agreement Identifier
484	Public Adjuster	Party Role Code	Yes	Yes	Yes	Party Role Code
485	Quote	Event Identifier	Yes	Yes	Yes	Event Identifier
486	Rating Territory	Rating Territory Assigning Organization Identifier	Yes	No	No	Organization Identifier
487	Rating Territory	Rating Territory Code	No	No	No	Rating Territory Code
488	Rating Territory	Rating Territory Code Set Identifier	No	No	No	Rating Territory Code Set Identifier
489	Rating Territory	Rating Territory Identifier	Yes	Yes	No	Rating Territory Identifier
490	Rating Territory Geographic Location	Geographic Location Identifier	Yes	Yes	Yes	Geographic Location Identifier
491	Rating Territory Geographic Location	Rating Territory Identifier	Yes	Yes	Yes	Rating Territory Identifier
492	Recovery	Claim Amount Identifier	Yes	Yes	Yes	Claim Amount Identifier
493	Recovery	Claim Amount Identifier	Yes	Yes	No	Claim Amount Identifier
494	Recreational Vehicle	Insurable Object Identifier	Yes	Yes	Yes	Insurable Object Identifier
495	Regional Office	Organization Identifier	Yes	Yes	Yes	Organization Identifier
496	Regional Office	Regional Office Identifier	Yes	Yes	No	Party Identifier
497	Regional Office	Territory Identifier	Yes	Yes	Yes	Party Identifier

498	Reinstatement	Event Identifier	Yes	Yes	Yes	Event Identifier
499	Reinsurance Agreement	Agreement Identifier	Yes	Yes	Yes	Agreement Identifier
500	Reinsurance Recovery	Claim Amount Identifier	Yes	Yes	Yes	Claim Amount Identifier
501	Renewal	Event Identifier	Yes	Yes	Yes	Event Identifier
502	Residential Structure	Insurable Object Identifier	Yes	Yes	Yes	Insurable Object Identifier
503	Risk Factor Score	Assessment Result Identifier	Yes	Yes	Yes	Assessment Result Identifier
504	Salvage	Claim Amount Identifier	Yes	Yes	Yes	Claim Amount Identifier
505	Scheduled Item	Insurable Object Identifier	Yes	Yes	Yes	Insurable Object Identifier
506	Service Provider	Party Role Code	Yes	Yes	Yes	Party Role Code
507	Short Rate	Event Identifier	Yes	Yes	Yes	Event Identifier
508	Staff	Party Role Code	Yes	Yes	Yes	Party Role Code
509	Staff Classification	Staff Classification Code	Yes	Yes	No	Staff Classification Code
510	Staff Classification	Staff Classification Description	No	No	No	Medium Description
511	Staff Classification	Staff Classification Name	No	No	No	Code Name
512	Staff Position	Staff Classification Code	No	No	Yes	Staff Classification Code
513	Staff Position	Staff Position Description	No	No	No	Code Description

514	Staff Position	Staff Position Identifier	Yes	Yes	No	Staff Position Identifier
515	Staff Position	Staff Position Name	No	No	No	Code Name
516	Staff Position Assignment	Begin Date	Yes	Yes	No	Begin Date
517	Staff Position Assignment	End Date	No	No	No	End Date
518	Staff Position Assignment	Organization Identifier	Yes	Yes	Yes	Organization Identifier
519	Staff Position Assignment	Person Identifier	Yes	Yes	Yes	Person Identifier
520	Staff Position Assignment	Staff Position Identifier	Yes	Yes	Yes	Staff Position Identifier
521	Staff Role	Party Role Code	Yes	Yes	Yes	Party Role Code
522	Staff Work Assignment	Begin Date	Yes	Yes	No	Begin Date
523	Staff Work Assignment	End Date	No	No	No	End Date
524	Staff Work Assignment	Grouping Identifier	Yes	Yes	Yes	Grouping Identifier
525	Staff Work Assignment	Organization Identifier	Yes	Yes	Yes	Organization Identifier
526	Staff Work Assignment	Party Role Code	Yes	Yes	Yes	Party Role Code
527	Staff Work Assignment	Person Identifier	Yes	Yes	Yes	Person Identifier
528	Staffing Agreement	Agreement Identifier	Yes	Yes	Yes	Agreement Identifier
529	Staffing Organization	Party Role Code	Yes	Yes	Yes	Party Role Code
530	State	State Code	Yes	Yes	No	State Code
531	State	State Name	No	No	No	Code Name

532	Structure	Insurable Object Identifier	Yes	Yes	Yes	Insurable Object Identifier
533	Subcontractor	Party Role Code	Yes	Yes	Yes	Party Role Code
534	Subrogation	Claim Amount Identifier	Yes	Yes	Yes	Claim Amount Identifier
535	Supplier	Party Role Code	Yes	Yes	Yes	Party Role Code
536	Surcharge	Policy Amount Identifier	Yes	Yes	Yes	Policy Amount Identifier
537	Tax	Policy Amount Identifier	Yes	Yes	Yes	Policy Amount Identifier
538	Team	Grouping Identifier	Yes	Yes	Yes	Grouping Identifier
539	Team Leader	Party Role Code	Yes	Yes	Yes	Party Role Code
540	Team Member	Party Role Code	Yes	Yes	Yes	Party Role Code
541	Territory	Organization Identifier	Yes	Yes	Yes	Organization Identifier
542	Territory	Territory Identifier	Yes	Yes	No	Party Identifier
543	Third Party Administrator	Party Role Code	Yes	Yes	Yes	Party Role Code
544	Third Party Staffing Agreement	Agreement Identifier	Yes	Yes	Yes	Agreement Identifier
545	Tractor	Insurable Object Identifier	Yes	Yes	Yes	Insurable Object Identifier
546	Trailer	Insurable Object Identifier	Yes	Yes	Yes	Insurable Object Identifier
547	Transportation Class	Insurable Object Identifier	Yes	Yes	Yes	Insurable Object Identifier

548	Truck	Insurable Object Identifier	Yes	Yes	Yes	Insurable Object Identifier
549	Underwriting Assessment	Assessment Result Identifier	Yes	Yes	Yes	Assessment Result Identifier
550	Van	Insurable Object Identifier	Yes	Yes	Yes	Insurable Object Identifier
551	Vehicle	Insurable Object Identifier	Yes	Yes	Yes	Insurable Object Identifier
552	Vehicle	Vehicle Driving Wheel Quantity	No	No	No	Quantity
553	Vehicle	Vehicle Identification Number	No	No	No	Medium_Variable_Value
554	Vehicle	Vehicle Make Name	No	No	No	Short Name
555	Vehicle	Vehicle Model Name	No	No	No	Short Name
556	Vehicle	Vehicle Model Year	No	No	No	Year
557	Victim	Party Role Code	Yes	Yes	Yes	Party Role Code
558	Watercraft	Insurable Object Identifier	Yes	Yes	Yes	Insurable Object Identifier
559	Workers Comp Class	Insurable Object Identifier	Yes	Yes	Yes	Insurable Object Identifier

## 3.4 Business Terms Reference Glossary

A Glossary is an alphabetical list of terms and acronyms in a particular area of knowledge with the definitions for those terms. In this deliverable, the knowledge areas would be Insurance or Data Modeling.

The Glossary provides definition of insurance and data model terms that are relevant to the Data Model. It is not the intent of the Glossary to teach insurance or data modeling; rather it is to support consistent meaning of terms and to improve the understanding of the data model.

A Data Model is a graphical representation of the things and concepts of importance to the business, and how these are related. It also includes the facts that are needed to run the business and to build the databases and systems in support the business.

Definitions of the data model objects, such as entities, attributes, and domains, are in the data model and published with the model. These definitions explain the model constructs and their role in the model, and do not necessarily have the same definition as the Glossary (when the terms exist in both). Not every model object is relevant to the Glossary, for example, the “domains” such as “Amount” and “Number” are useful for the Data Model but not the Glossary.

Following is an example of a Glossary entry and its related Data Model entries that demonstrates the above guidelines.

In the Glossary, Deductible is defined as “Deductible is the amount of money (or could be expressed as number of days, a percentage, etc.) representing the part of a loss amount that the insured is required to pay before any indemnification payment is provided by the insurance company. Once the deductible is met, the insurance amount to be paid is the excess over the amount of the deductible.”

In the Data Model: the Deductible is supported in the Policy Deductible Entity defined as “Policy Deductible defines the Deductibles (attachment point for coverage) associated with the policy coverage. Deductibles are the loss amounts paid by the insured before insurance payments apply.”

- Deductible Type Code represents the kind of deductible, such as per occurrence, per person, etc.
- Deductible Basis Code identifies whether the related Deductible Value is an amount or a percentage or number of days, etc. that will be used to determine what an insured is expected to pay before reimbursement from the insurance company begins.
- Deductible Value is the actual monetary amount, percentage or time period. Examples: \$500, 10%, 90 days.

The glossary explains what a deductible is, whereas the data model provides for recording data about the Deductible, so the existence of the deductible is known in the model if there is a Deductible Type Code Deductible Basis code, and Deductible Value.

Below are the guidelines used to comprise and manage the Glossary and Data Model definitions:

- Terms are singular, Title Case.
- Data Model Entities usually have a companion Glossary entry.
- The Glossary definition of an object may be more extensive and explanatory of the business meaning, while the Data Model definition states the model context of the object.
- Some Data Model Attributes may have a companion Glossary entry when the attribute represents an important business fact and concept. As with entities, the definition in the data model may differ somewhat from the Glossary entry.
- Glossary entries that have no direct relationship to the Data Model provide may be related to the model through the designated "Context" or by direct reference to the Data Model constructs.
- Glossary entries have a "Context" designation that associates the term definition and usage to a Data Model or Business subject.

The Context designations used are:

<u>Standard Context Values</u>	<u>Description</u>
<u>General Insurance Term</u>	<u>Terms that are generally used in the insurance industry</u>
<u>Account</u>	<u>Data Model Subject Area</u>
<u>Agreement</u>	<u>Data Model Subject Area</u>
<u>Assessment</u>	<u>Data Model Subject Area</u>
<u>Claim</u>	<u>Data Model Subject Area</u>
<u>Communication</u>	<u>Terms and Entities describing communication methods that are not in a separate Subject Area</u>
<u>Coverage</u>	<u>Data Model Subject Area</u>
<u>Event</u>	<u>Data Model Subject Area</u>
<u>Insurable Object</u>	<u>Data Model Subject Area</u>

<u>Location</u>	<u>Terms and Entities describing geographic areas that are not in a separate Subject Area</u>
<u>Money</u>	<u>Data Model Subject Area</u>
<u>Party</u>	<u>Data Model Subject Area</u>
<u>Party Role</u>	<u>Data Model Subject Area</u>
<u>Policy</u>	<u>Data Model Subject Area</u>
<u>Product Coverage</u>	<u>Data Model Subject Area</u>
<u>Data Model</u>	<u>Terms Used to describe and define the Data Model</u>

- Glossary entries also have a "Source" designation that identifies where the definition came from. The possible sources are:

<u>Definition Source Values</u>	<u>Description</u>
<u>ACORD</u>	<u>Initial ACORD definitions donated to the Work Group</u>
<u>Barron's Business Terms</u>	<u>Book - Barron's Business Guides</u>
<u>Barron's Insurance Terms</u>	<u>Book - Barron's Business Guides</u>
<u>dictionary.com</u>	<u>Online general dictionary reference</u>
<u>Dictionary of Insurance</u>	<u>Book - Complete Dictionary of Insurance Terms (Samaroo)</u>
<u>IBM IAA</u>	<u>Initial IBM Insurance Application Architecture (IAA) definitions donated to the Work Group</u>
<u>IRMI.com</u>	<u>Online Dictionary of International Risk Management Institute (IRMI)</u>
<u>LOMA Glossary</u>	<u>Online Glossary by Life Office Management Association (LOMA)</u>
<u>Webster's</u>	<u>Book - general dictionary reference</u>
<u>Wikipedia</u>	<u>Online Dictionary - Wikipedia</u>
<u>Insurance Work Group</u>	<u>P&amp;C Data Model Work Group</u>
<u>Charlie Schaefer</u>	<u>P&amp;C Data Model Work Group Industry Expert</u>

Thomas Ford 2/20/13 10:34 PM  
Formatted Table



<b>Business Term</b>	<b>Definition</b>	<b>Context</b>	<b>Definition Source</b>	<b>Change</b>
Accident	Accident is an event involving an object of insurance that results in a potential insurance loss or claim. In the data model, an Accident is a kind of Occurrence.	Claim	Insurance Work Group	
Account	Account is a business arrangement that defines a relationship between two or more parties as to how they intend to engage in regular dealings or provide services. Examples: Multiple policies and Contracts.	Account	Charlie Schaefer	
Account Agreement	Account Agreement is a relationship between account and agreement. It can be used to relate multiple agreements to a single account such a for billing.	Agreement	IBM IAA	change
Account Holder	Account Holder is a person or business in possession of one or more agreements that form an account relationship with another person or organization. This is represented in the data model in the account party role entity.	Party Role	Insurance Work Group	change
Account Provider	Account Provider is a role played by a financial services provider who, in the context of an account agreement, provides an account and the related account facilities to the account holder.	Party Role	Barron's Insurance Terms	
Accountability	Accountability is a Role played by a Party who is responsible for an Account or Project or Assessment or any other object or activity.	Party Role	Insurance Work Group	NEW
Actuary	Actuary is a Role of a person who conducts statistical studies and determine the rates, reserves, and dividends for insurance policies. Actuaries are specialized mathematicians certified by the insurance industry.	General Insurance Term	Barron's Insurance Terms	NEW

Additional Interest	Additional Interest is a Role played by a Party who has financial or risk interest in an Agreement. Also another person, firm, or entity enjoying the same protection as the named insured. Examples include but are not limited to: Mortgagee, Certificate Holder, Lien Holder.	Party Role	Insurance Work Group	NEW
Address	Address is text that defines a single line of a physical and/or mailing location or an electronic link or address. Based on an associated type code, the format and content can be validated.	Communication	Insurance Work Group	NEW
Adjuster	Adjuster is a Role played by a Party who handles a claim brought against an insurance company or syndicate. The adjuster evaluates the merits of each claim and makes recommendations. An adjuster's actions include: collating details, validating cover, resolving disputes and agreeing where appropriate to settle claims at a fair price. The adjustor is subject to authority limits defined by company policy, contract, experience or line of business.	Party Role	Barron's Insurance Terms	
Administrative Organization Unit	Administrative Organization Unit is responsible for the terms and conditions of the contract.	Party	Insurance Work Group	
Agency	Agency is a type of organization whose goal is to sell and service insurance. The Agency is appointed by the insurance company and is licensed by a government jurisdiction to sell insurance.	Party	Insurance Work Group	

Agency Contract	Agency Contract is a type of agreement that stipulates the business arrangement between an insurer and an insurance agency it appoints to represent it.. Examples; Business arrangement details such as ownership of renewals, commission percentages, and duties and responsibilities of each party are usually spelled out in this agreement.	Agreement	Insurance Work Group	
Agent	Agent is a role played by a Party who solicits, negotiates, sells effects and services contracts of insurance in behalf of an insurance company who appoints it. The party assumes either of two classifications: 1. Independent agent represents at least two insurance companies. Captive Agent represents only one company and sells only its policies. . Description; The agent's right to exercise various functions, authority, and obligations, as well as the obligations of the insurer to the agent, are subject to the terms of the agency contract with the insurer, to statutory law, and to common law.	Party Role	Insurance Work Group	
Aggregate Limit Amount	Aggregate Limit Amount is a limit of coverage that specifies the maximum amount (or other limit expression such as number of days) to be paid regardless of any other factor.	Product Coverage	Insurance Work Group	change
Agreement	Agreement is a mutual assent between two or more legally competent parties, whereby each party promises to do, or not to do, something; a transaction involving two or more legally competent parties, whereby each has reciprocal rights to demand performance of what is promised. Examples: Agreements include but are not limited to: a policy, an agency contract, an Auto repair shop contract, a brokerage contract and an employment agreement.	Agreement	Insurance Work Group	
Agreement Original Inception Date	Agreement Original Inception Date is the date that an agreement first became effective and is never changed.	Agreement	Insurance Work Group	NEW

Animal	Animal is an Insurable Object that can be farm livestock, a zoo animal, a pet, or any other animal that could be insured.	Insurable Object	IBM IAA	
Application Form	Application Form is a document containing pre-formatted questions about a prospective customer of insurance services used to determine the eligibility and acceptability of a risk for the insurance coverage requested.	Policy	Insurance Work Group	
Appraisal	Appraisal is the act of estimating the cost to repair, replace or otherwise make available for its intended use an insured item that has suffered damage or loss.	Assessment	Insurance Work Group	
Approval	Approval is an authorization given by a role player for the execution of a business activity. This was formerly called Authorization.	Assessment	Insurance Work Group	NEW
Arbitration	Arbitration is the process of settling a dispute by an appointed third party outside court. In disputes arising out of a contract containing an arbitration clause, the parties involved may either go to court or appoint someone (an arbitrator) to settle the dispute. The agreement to go to arbitration does not preclude either of the parties taking legal proceedings if it desires.	Claim	Insurance Work Group	
Assessment	Assessment is a formal evaluation of a particular person, organization, or thing that enables business decisions to be made. Examples: Credit Score, Underwriting Evaluation, Medical Condition.	Assessment	Insurance Work Group	change
Assessment Result	Assessment Result is the outcome of the assessment. There may be multiple results for one assessment.	Assessment	Insurance Work Group	

Assignee	Assignee is a Role played by a Party to whom rights to an insurance benefit are assigned.	Party Role	Insurance Work Group	
Assumed	Assumed is a state for a risk in which a party other than the original party to the risk assessment and acceptance becomes accountable for the risk.	Money	Barron's Insurance Terms	
Attorney	Attorney is a Role played by a Person who is appointed to transact legal business on another's behalf. Examples: An Attorney-At-Law is a person admitted to practice law in a jurisdiction, authorized to perform both civil and criminal legal functions for clients. These functions include drafting of legal documents, giving legal advice, and representing clients before courts, administrative agencies, boards, etc. OR An Attorney-In-Fact is one who is authorized to act for another under a power of attorney, which may be general or limited in scope. A person need not be an Attorney-At-Law to be an Attorney-In-Fact.	Party Role	Insurance Work Group	
Audit	Audit (herein Premium Audit) is a transaction that occurs generally after the policy term has expired, to see if the exposures were accurate or if any post term changes need to be made and more premium billed or a credit given. Example: a premium audit may be conducted of a company insured under a workers compensation policy to assure appropriate premium has been charged based on risk location and insured	Event	Insurance Work Group	

	workers job.			
Auditor	Auditor is a Role played by a Party who performs either operational or financial reviews (audits).	Party Role	Insurance Work Group	
Authorization	Authorization is an approval given by a role player for payments to be executed or services (activity occurrences) to be received. In the Data Model, <b>this term was changed to Approval</b> because Authorization is a reserved word in the technical environment.	Assessment	Insurance Work Group	change
Auto Repair Shop Contract	Auto Repair Shop A kind of Agreement where a Repair Facility may be selected by the insurer to perform appraisals only or perform appraisals and repairs. If selected to be "in contract" the agreement implies the insurer will "make known" or identify in marketing material this shop to insurer's policyholders in exchange for the repair shop's freedom to appraise without inspection or validation (inside guidelines) the correction necessary to repair vehicle to pre-accident conditions. Claim costs are reduced due to the reduction/ elimination of re-inspection costs usually incurred; being removed from the appraisal process.	Agreement	Insurance Work Group	
Automobile	Insurable Object that is a self-propelled passenger vehicle designed for operation on ordinary roads and typically having four wheels.	Insurable Object	Barron's Insurance Terms	

Beneficiary	Beneficiary is an individual or organization that receives or has the legal right to receive the benefit payments of an insurance policy.	Party Role	Insurance Work Group	
Benefit	Benefit is the contractually granted financial outcome provided by an insurance policy.	Policy	Insurance Work Group	
Binder	Binder is a kind of Agreement that provides temporary insurance under a contract which provides coverage between risk acceptance and until a permanent policy is issued. In Property and Casualty insurance, some agents have authority to bind the insurance company to coverage until a policy can be issued. For example, the purchaser of an automobile can call the agent, who can then bind the insurance company to temporary coverage.	Agreement	Barron's Insurance Terms	
Binding	Binding is the act of providing insurance coverage between the time an Insurance company accepts the risk and is ready to issue the permanent policy.	Event	Insurance Work Group	
Boat	Boat is an Insurable Object that is a vessel that carries passengers or freight over water.	Insurable Object	Insurance Work Group	
Body Object	Body Object is an Insurable Object such as a human body part, a life form such as a lab organism, or an animal.	Insurable Object	Insurance Work Group	
Branch Office	Branch Office is an Organization Unit that is a local business location of an insurance company that markets and/or services its products and lines of insurance within and to a specified geographic location.	Party	ACORD	

Broker	Broker is a Role played by a Party who searches the insurance marketplace for potential providers of appropriate and adequate insurance coverage in the interest of the potential insured, not in the interest of the insurance companies.	Party Role	Insurance Work Group	
Brokerage Contract	Brokerage Contract is a kind of agreement between two firms, detailing and describing the basis and terms of their business relationship wherein one (the broker) acts on behalf of the other (the contract holder) in identifying, evaluating and recommending insurance alternatives from a variety of insurers.	Agreement	Insurance Work Group	
Bus	Bus is an Insurable Object that is a public or private conveyance vehicle used to transport people, e.g. School Bus.	Insurable Object	Barron's Insurance Terms	
Business Activity	Business Activity Identifies the type of actions, behaviors, processes, performances, or outcomes a business organization or the professionals in it are involved in.	Event	IBM IAA	
Business Event	Business Event is a significant incident in the existence of an organization that is of interest to an insurer organization (such as relocation, merger, acquisition, expansion, occupation of a new premises) and may be a trigger for insurance marketing activities because of the potential resulting change(s) to the underlying organization's risk.	Event	Insurance Work Group	



Buyer	Buyer is a person or organization that is responsible for acquiring goods or services that are provided for in a provider agreement.	Party Role	IBM IAA	
Cancel	Cancel is the act of annulling a Policy by the insured or by the Insurance Company. The policy is no longer in-force as of the date of cancellation or an agreed upon date.	Event	Insurance Work Group	
Captive Agent	Captive Agent is a licensed and appointed member of an insurance agency who is an employee of an insurance organization or who can generate new policies only for a single insurance organization.	Party Role	Barron's Insurance Terms	
Catastrophe	Catastrophe is a destructive event of significant importance. Due to both the scope and the scale of losses under the event, it is classified separately from other loss events. These events may also be formally classified by a political entity within whose jurisdiction the event took place	Claim	Insurance Work Group	
Catastrophic Event Indicator	Catastrophic Event Indicator indicates that an occurrence is the result of a severe loss characterized by extreme force and/or sizable financial loss.	Claim	Insurance Work Group	change

Caused Event	Caused Event is an Event that is a loss event which did not occur spontaneously and can be attributed to a particular action, inaction, circumstance, or set of circumstances from which the event occurred.	Event	Insurance Work Group	
Ceded	Ceded is the state of having transferred a risk or part of a risk to another insurer. Example: ceded premium is revenue paid to another insurance company in exchange for transferring the risk of the (direct-written) policy to that other insurance company.	Money	Insurance Work Group	
Channel Role	Channel Role is a Role played by a Party that represents the marketing, selling or servicing of financial services agreements. The role player can be a person (an agent or a broker), an organization (an agency) or a virtual party (a web site or a kiosk). Every Channel Role can play multiple selling channel and servicing channel roles, one for each financial services agreement.	Party Role	Insurance Work Group	change
Channel Score	Channel Score is a kind of Assessment Result that indicates the relative success of the channel in marketing and servicing products, and services on behalf of the insurer.	Assessment	Insurance Work Group	
Claim	Claim is a request by an insured for indemnification from an insurance company for loss incurred from an insured peril or hazard. Example: A homeowner files a claim if he or she suffered damage because of a fire, theft, or other loss.	Claim	Insurance Work Group	change
Claim Administrator	Claim Administrator is a Role played by a Party who is designated by the insurance company, to manage the handling of a claim from the first notice to the resolution of the claim .	Party Role	IBM IAA	
Claim Amount	Claim Amount is the financial amount reserved or paid in connection with a claim.	Money	Insurance Work Group	NEW

Claim Close Date	Claim Close Date is the date that a claim is considered resolved.	Claim	Insurance Work Group	NEW
Claim Event	Claim Event is a subtype of Event that identifies and describes the accident or occurrence that triggered the claim.	Event	Insurance Work Group	NEW
Claim Examiner	Claim Examiner is a Role played by a Party who is assigned to the claim to determine its legitimacy and provide feedback to the insurance company.	Party Role	IBM IAA	
Claim Expense	Claim Expense is a cost incurred in adjusting a claim. Claim expenses include such items as attorneys' fees and investigation expenses (e.g., witness interviews).	Money	Insurance Work Group	
Claim Expert	Claim Expert is a Role played by a Party who provides advice on matters associated with the claim.	Party Role	Insurance Work Group	
Claim Feature	Claim Feature is a subgrouping of the claim that represents the individual claimants (each being a feature) on one claim and/or individual losses that are covered under the policy (i.e. - a property loss as one feature of the claim and a liability loss as another feature on the same claim. This is also called a "Sub-Claim", which is used in the model.	Claim	Charlie Schaefer	change
Claim Folder	Claim Folder is the physical file all claim documents are maintained in.	Claim	Insurance Work Group	
Claim Folder Supporting Document	Claim Folder Supporting Document is written information such as agreements, financial statements, offers, proposals, etc., to provide backup and depth to agreed-upon or discussed claim matters.	Claim	Insurance Work Group	NEW

Claim Fraud Assessment	Claim Fraud Assessment is a kind of Assessment Result based upon the evaluation of an action by which a person intentionally uses false information in an unfair or unlawful attempt to collect benefits or payments under an insurance policy.	Assessment	Barron's Business Terms	
Claim Fraud Examiner	Claim Fraud Examiner is a Role played by a Party whose goal is to determine whether claim fraud has occurred or is occurring, and to determine who is responsible for the claim fraud.	Party Role	Insurance Work Group	
Claim Legal Expert	Claim Legal Expert is a Role played by a Party who provides legal advice on matters relating to the claim.	Party Role	Barron's Business Terms	
Claim Offer	Claim Offer is a proposal made by an insurer to a claimant or third party in order to settle a claim. Sometimes, alternative offers are made so that the claimant has different options to settle the claim. Each of these options is represented by a different claim offer. A claim offer could also be the set of benefits requested by the claimant in the context of this claim.	Claim	Insurance Work Group	
Claim Office	Claim Office is the local business office of an insurance company that processes claims. Normally the jurisdiction of a claims office is defined by a territory.	Party	Insurance Work Group	
Claim Open Date	Claim Open Date is the date that a claim or subclaim file is set up and a potential claim is acknowledged.	Claim	Insurance Work Group	NEW
Claim Payment	Claim Payment is the amount paid for loss or expense to settle a claim in whole or in part for which the details are broken down by claim feature or subtype (such as by claimant and type of claim (property, liability, etc.)).	Claim	Charlie Schaefer	change
Claim Reopen Date	Claim Reopen Date is the date a previously closed claim is reopened for further examination and additional handling.	Claim	Insurance Work Group	NEW

Claim Reported Date	Claim Reported Date is the date a claim is filed and recorded by the Insurance carrier responsible for handling the claim.	Claim	Insurance Work Group	NEW
Claim Representative	Claim Representative is a Role of a person who acts on behalf of the insurance company to mediate relations and initially settle disputes with it's members or other Third Parties.	Party Role	Barron's Business Terms	change
Claim Reserve	Claim Reserve is the amount of expected loss or expected expense over the life of the Claim and is broken down by claim feature or subtype (such as by claimant and type of claim (property, liability, etc.)).	Money	Charlie Schaefer	change
Claim Witness	Claim Witness is a Role of an individual or group or organization having first hand knowledge of the circumstances, events or surrounding the occurrence of an event that resulted in a request for indemnification from an insurance company.	Party Role	Insurance Work Group	
Claimant	Claimant is a Role of a Peron or Organization who asserts a loss and the right to demand payment of compensation or benefits or indemnification of loss.	Party Role	IBM IAA	
Claims Made Date	Claims Made Date is the date on which claims were made during the extended reporting period of claims-made contracts.	Claim	Insurance Work Group	NEW
Client	Client in insurance is usually a third party who contractually agrees to pay for insurance coverage on others not related to them (such as an employer providing coverage for employees) or agrees to allow others contractually related to them to purchase coverage. A Customer is normally an individual; a Client is normally an organization.	Party	Insurance Work Group	
Code	Code is a value used to represent a condition of a data element.	General Insurance Term	Insurance Work Group	NEW

Combination Structure	Combination Structure is an Insurable Object that is used both for human habitation and for use by retail, wholesale, office, hotel or service users, or for manufacturing or other industrial purposes. An example of a Combination Structure is apartments over a store.	Insurable Object	Barron's Insurance Terms	
Combine	Combine is a piece of farm machinery used to harvest crops, e.g. wheat.	Insurable Object	Insurance Work Group	
Commercial Agreement	Commercial Agreement is a Contract, such as an insurance policy, between one organization and another organization dealing with the commercial business activity of one of the organizations.	Agreement	Insurance Work Group	
Commercial Structure	Commercial Structure is an Insurable Object that is a property intended for use by retail, wholesale, office, hotel or service users, or for manufacturing or other industrial purposes. Examples include but are not limited to: shopping centers, office buildings, hotels and motels, and resorts or restaurants.	Insurable Object	Insurance Work Group	
Communication	Communication is an interaction between two or more people that is enabled by physical presence, telephone, electronic mail, written letters, social media, etc.	Communication	Insurance Work Group	NEW
Communication Profile	Communication Profile is contact information that shows the characteristics, needs, and preferences of an individual. This may include visual preferences, hearing preferences, cognitive preferences and mobility preferences. This is represented in the data model as Party Communication and Party Preference.	Communication	Barron's Business Terms	
Commutation Agreement	Commutation Agreement is a kind of Agreement between a ceding insurer and the reinsurer that provides for the valuation, payment, and complete discharge of all obligations between the parties under a particular reinsurance contract. It is used if an insurer is withdrawing from underwriting a class of business.	Agreement	IRMI.com	

Company	Company is a formal, legally registered entity, created for the purpose of conducting business.	Party	Insurance Work Group	
Company Jurisdiction	Company Jurisdiction is a legal entity or recognized political subdivision that defines where an insurance company can operate and which products can be sold and serviced by the company.	Product Coverage	Barron's Business Terms	
Construction Vehicle	Construction Vehicle is a motorized vehicle used in the course of building and moving anything.	Insurable Object	Insurance Work Group	
Contract	Contract is a formal written agreement outlining the terms and conditions agreed upon between two parties.	Agreement	Insurance Work Group	
Contractor	Contractor is a Role played by a Person who legally agrees or engages in a legal agreement to do work for another. An Independent Contractor makes an agreement to do a specific piece of work, retaining control of the means and method of doing the job. Examples of independent contractors are physicians, lawyers, construction contractors, and others engaged in a profession in which they offer their services to the public.	Party Role	Insurance Work Group	
Court Jurisdiction	Court Jurisdiction is an associative entity that resolves the many-to-many relationship between the Court and the Jurisdiction entities: A Court may administer justice within many Jurisdictions and a Jurisdiction may be granted to many Courts. The legal or physical area over which a court is permitted to administer justice.	General Insurance Term	Insurance Work Group	

Coverage	Coverage is the definition of the risks being provided indemnification, and the level of indemnification being provided under an insurance policy. In property insurance, coverage lists perils insured against, properties covered, locations covered, individuals insured, and the limits of indemnification. In life insurance, coverage provides living and death benefits.	Product Coverage	Wikipedia	
Coverage Available	Coverage Available is the coverage that can be selected from a pick list for the Product in order to determine the final coverage listed in the policy and the final premiums to be charged.	Product Coverage	Insurance Work Group	
Coverage Description	Coverage Description is a term or set of terms that define the coverage provided or in consideration of being provided under an insurance policy or policies.	Product Coverage	Insurance Work Group	
Coverage Group	Coverage Group is the aggregation of coverage under a broader business classification to group them for reporting purposes, e.g. a group of liability coverage, a group of property coverage.	Product Coverage	Insurance Work Group	
Coverage Level	Coverage Level is one of the possible limits of indemnification provided under a coverage.	Product Coverage	Insurance Work Group	
Coverage Limit	Coverage Limit is the maximum amount of insurance provided for each coverage or indemnification type found in an insurance policy.	Product Coverage	Insurance Work Group	
Coverage Limit Type	Coverage Limit Type is the category of indemnification limit that is applied under a coverage.	Product Coverage	Insurance Work Group	
Coverage Option	Coverage Option is a choice from among multiple additions that can be made to an existing policy or a new policy being written.	Product Coverage	Insurance Work Group	



Coverage Part	Coverage Part is a section of an insurance Policy that organizes coverages at a high level, usually property versus liability.	Product Coverage	Insurance Work Group	NEW
Coverage Type	Coverage Type defines the categories for different types of coverages, e.g. is the coverage for liability, for physical damage, for no fault.	Product Coverage	Wikipedia	
Credit Adjustment	Credit Adjustment is a type of monetary adjustment that is applied to the base or manual premium calculated that will reduce the premium based on some evaluation rule or practice of the insurer.	Money	Insurance Work Group	NEW
Credit Rating	Credit Rating is the acceptability of the party for credit transactions (including good, fair and cash only). The rating is normally applied by credit rating agencies or credit granting financial institutions. This is one characteristic that can be used to assess the underwriting, financial and operational risk represented by an entity requesting indemnification.	Assessment	Charlie Schaefer	
Customer	Customer is a role played by a Party to whom an insurer is currently supplying (or has supplied in the past) services, goods, or benefits in exchange for consideration in the form of premium payments. Someone who pays for coverage on themselves, or an object or person of importance to them.	Party Role	Barron's Insurance Terms	
Customer Score	Customer Score is a kind of Assessment Result that assigns points to each customer based on specific criteria in order to be able to rank order customers against the dependent variable measured by that criteria. Examples of dependent variables are expected loss ratio, expected loss severity, propensity for a catastrophic event, etc.	Assessment	Insurance Work Group	

Deductible	Deductible is the amount of money (or could be expressed as number of days, a percentage, etc.) representing the part of a loss amount that the insured is required to pay before any indemnification payment is provided by the insurance company. Once the deductible is met, the insurance amount to be paid is the excess over the amount of the deductible.	Product Coverage	IBM IAA	change
Deductible Rate	Deductible Rate is a rating factor used to calculate the premium charge for the deductible based on the Coverage Level and Deductible selected.	Product Coverage	Insurance Work Group	NEW
Deductible Recovery	Deductible Recovery is a kind of Recovery that retrieves from the individual responsible for the deductible payment the amount of deductible associated with a loss payment under a claim.	Money	Insurance Work Group	
Demographic	Demographic is a set of characteristics defining a population or a segment of the population. The characteristics may define the risk of the population, or may define the propensity of the population to make a particular decision (apply for insurance, cancel insurance, file a claim, renew a policy, etc.).	General Insurance Term	Insurance Work Group	
Demographic Score	Demographic Score is an Assessment Result that is used to rank orders risks or individuals based on a table of points assigned to pre-identified demographic characteristics of the risk or individual.	Assessment	Insurance Work Group	
Department	Department is an Organization Unit that groups individuals with common or related jobs to accomplish certain common or related functions. An example is the Payroll Department.	Party	Insurance Work Group	
Derivative Contract	Derivative Contract is a kind of Agreement where the value of the contract is based on derived variables or characteristics, such as an index of commodity prices.	Agreement	Insurance Work Group	

Direct Written Premium	Direct Written Premium is money applied to a policy based on the assumption that indemnification is being provided for the entire term of the policy. See also "Earned Premium".	Money	Insurance Work Group	change
Doing Business As Name	Doing Business As Name is the name of a person's business that may be included in an insurance contract or policy.	Party	Insurance Work Group	
Driver	Driver is a Role played by a Person who operates a vehicle.	Party Role	Barron's Business Terms	
Dun And Bradstreet	Dun And Bradstreet is a publically traded company that licenses information on businesses and corporations for use in credit decisions, business-to-business marketing and supply chain management.	Party	Wikipedia	NEW
Dun And Bradstreet Number	Dun And Bradstreet Number is a numeric code that is a unique identifier for an organization with a data file in Dun and Bradstreet's commercial credit data base. The Dun and Bradstreet code is also known as a DUNS Number.	Party	Insurance Work Group	NEW
Dwelling	Dwelling is an Insured Object that is a structure or part of a structure used as a place of residence by human beings.	Insurable Object	Barron's Business Terms	
Earned Premium	Earned Premium is an accounting calculation for recognizing premium revenue over time from the effective date to the termination date of an insurance policy. This is most useful for allocating expenses and losses to the policy to determine the profitability of a policy and/or a line of business at a given point in time.	Money	Insurance Work Group	NEW
Effective Date	Effective Date is the calendar date on which an insurance company begins providing coverage to an insured under an insurance policy or contract that has been written and is in	Policy	Insurance Work Group	NEW

	effect. The coverage normally begins at 12:01am on this date.			
Email Address	Email Address is a contact point that is used to communicate electronically with another individual or organization. The address is normally an alpha-numeric string, usually of the form username@host.domain.	Communication	Insurance Work Group	
Employee	Employee is a Role played by a Person working for or providing stipulated services contractually and exclusively for another Party in return for compensation, whether direct or indirect .	Party Role	Insurance Work Group	
Employee Classification	Employee Classification is a pre-defined system for grouping employees of like job responsibility and like working roles and responsibilities. Employee classification is especially important for determination of Workers Compensation pricing required to cover the indemnification risk implied by the employees of an insured employer.	Party	Insurance Work Group	
Employer	Employer is a Role played by a Party who hires and pays wages, thereby providing a livelihood to individuals who perform work. The employment relationship confers authority on the employer, who has the right to control and direct the work to be performed. An employer also has the right to engage or discharge an employee and furnish the working location and supplies. An employer is responsible for the collection and remission of federal income and Social Security taxes from employees' compensation.	Party Role	IBM IAA	
Employment Agreement	Employment Agreement is a written Agreement between employer and employee, stating the terms of employment in an organization.	Agreement	IBM IAA	
Employment Position	Employment Position is a job classification for an employed person.	Party	Insurance Work Group	

Endorsement	Endorsement is a change in some provision of a policy and frequently involves changes in coverage for which premium may be increased or reduced.	Event	IBM IAA	change
Entry Into Claims Made Program Date	Entry Into Claims Made Program Date is the date that the insured registered with the claims made program.	Claim	Insurance Work Group	NEW
Event	Event is anything that happens, or is contemplated as happening. From an insurance perspective, an event is a situation that may impact the risk or indemnification covered by a policy.	Event	Insurance Work Group	
Event Date	Event Date is the date on which a transaction or insurance-related happening takes place.	Event	Insurance Work Group	NEW
Event Template	Event Template is a form, document or descriptor, which captures defined and selected event parameters as variables. An event template captures and defines single events by replacing the variables with values. Examples: Send of any message.	Event	Insurance Work Group	
Exposure	Exposure is the extent of the maximum impact of potential loss on the indemnification provided under a policy, as measured by an exposure base, such as payroll, receipts, area, or units produced.	Policy	Insurance Work Group	
Exposure Base	Exposure Base is the number, extent or size of the underlying items from which an insurance company determines the maximum amount of risk being accepted if a policy is written.	Policy	Insurance Work Group	
Facultative	Facultative is a type of reinsurance agreement whereby the reinsurance is purchased separately on a policy by policy basis. The reinsurance is not effective until the policy has been issued.	General Insurance Term	Insurance Work Group	NEW

Farm Equipment	Farm Equipment is an Insurable Object that is commonly used on a Farm, for example a tractor, cultivator, plow, combine, grain elevator, milking machine, etc. Motorized Vehicles that are Farm Equipment are unlicensed for public road use.	Insurable Object	Insurance Work Group	
Fee	Fee is a charge by the insurance company on an insurance policy either as a service fee and/or from a government entity as a tax on the premium charged.	Money	Charlie Schaefer	NEW
Financial Account	Financial Account is a fund used to track and report on monetary transactions between its owner or holder and individuals or organizations making monetary demands on the owner or holder.	Account	Insurance Work Group	
Financial Adviser	Financial Adviser is a Role played by a Person as a professional adviser offering financial counsel. Some financial advisers charge a fee and earn commissions on the products they recommend to implement their advice. Other advisers only charge fees and do not sell any products or accept commissions. Some financial advisers are generalists, while others specialize in specific areas, such as investing, insurance, estate planning or taxes.	Party Role	Insurance Work Group	
Financial Analyst	Financial Analyst is a Role played by a Party who works for a financial institution and is responsible for research and analysis of specific financial instruments, portfolios and strategies.	Party Role	Insurance Work Group	
Financial Assessment	Financial Assessment is the evaluation of the financial condition of a person or a company based on certain factors e.g. the credit score of a person, the financial ratios of a company, and the impact of that assessment on the risks being indemnified or covered under an insurance policy.	Assessment	Insurance Work Group	
Financial Institution	Financial Institution is a firm that provides financial products and services to consumers and organizations. Insurance is one form of financial institution along with banking, credit unions, investment management firms, etc. They are usually a kind of Organization whose main goal is to make a profit and provide financial benefit for owners, shareholders, and other fiscal	Party Role	Insurance Work Group	change

	entities.			
Financial Interest	Financial Interest is the potential monetary outcome that could accrue to an individual or organization based on an event or occurrence.	General Insurance Term	Insurance Work Group	
Financial Interest Role	Financial Interest Role identifies the monetary or monetarily valued interest a party has in a financial instrument such as an insurance Agreement. Examples are insured, beneficiary, etc.	Party Role	Insurance Work Group	change
Financial Services Assessment	Financial Services Assessment is a kind of Assessment Result that focuses on the finances of an individual or organization based on pre-defined characteristics that identify the financial or monetary risks represented by the firm.	Assessment	Insurance Work Group	
Financial Services Company	Financial Services Company is an insurance company legally granted the ability to solicit, evaluate and write insurance business in a jurisdiction.	Party Role	Insurance Work Group	
Financial Services Provider	Financial Services Provider is an entity providing products and services that impact the monetary holdings of individuals and organizations.	Party Role	Insurance Work Group	
Financial Services Role	Financial Services Role is a Party Agreement Roles such as Insurer, Policyholder, Assignee, etc.	Party Role	Insurance Work Group	
Financial Valuation	Financial Valuation is an assessment result expressed in financial units.	Assessment	Insurance Work Group	
Flat	Flat is a type of Cancellation whereby the policy is deemed to have never existed, no risk indemnification has been provided, and a full return of premium is granted.	Event	Insurance Work Group	
Form	Form is a document that provides a template for the recording of variable information or which describes the standard details of a contract, such as insurance forms attached to a policy.	Policy	Insurance Work Group	change

Fraud Examiner	Fraud Examiner is a Role played by a Party whose goal is to determine whether fraud has occurred or is occurring, the extent and impact of the fraud, and to determine who is responsible for the fraud.	Party Role	Insurance Work Group	
Freight Group	Freight Group is a kind of Insurable Object Group that addresses responsibility for in transit goods.	Insurable Object	Insurance Work Group	
Full Term	Full term is a type of endorsement where the changes made are effective on the policy effective date and apply for the full term of the policy.	Event	Insurance Work Group	
Geographic Location	Geographic Location is a bounded area defined by nature, by an external authority (such as a government) or for an internal business purpose. Used to identify a location in space that may or may not be a structured address, Examples: country, city, continent, postal area, risk area, postal address, property address.	Location	Insurance Work Group	
Goods	Goods are physical items to be received during a purchase activity. In insurance, goods may refer to Insurable Objects or to insurance contracts, agreements, endorsements, or policy amendments.	General Insurance Term	Insurance Work Group	
Government Organization	Government Organization is a kind of Organization with control of any asset, industry, or enterprise at any level, national, regional or local (municipal).	Party Role	Insurance Work Group	
Group	Group is a type of Party that has an informal structure of Persons and/or Organizations and is not incorporated, such as a household, a project team, or special interest group.	Party	Insurance Work Group	
Group Agreement	Group Agreement is a kind of contractual insurance Agreement provided to the employer and detailing coverage provided to the group.	Agreement	IRMI.com	
Hazard	Hazard is a circumstance that increases the likelihood or probable severity of a loss,	Product Coverage	Barron's Insurance Terms	NEW



Head Count	Head Count is a numeric representation of the number of employees and other individuals who are employed by or formally work for an organization.	Party	Insurance Work Group	
Health Care Provider	Health Care Provider is a Role played by a Party, generally a doctor, physician assistant, nurse, nurse practitioner, etc. who provides medical services for their patients.	Party Role	Insurance Work Group	
Household	Household is a set of individuals (a Party Group in the Data Model) usually resident at the same address, and members of the same nuclear or extended family, who share a common economic interest and who are to be treated for certain purposes (for example, marketing campaigns) as a unit.	Party	Insurance Work Group	
Household Content	Household Content is a categorization and description of all Insurable Objects (personal property) within a residence, which details all items covered and indemnified in the event an insurance claim must be filed.	Insurable Object	Insurance Work Group	
Inception Date	Inception Date is the original effective date of a contract that can be renewed and continue from one time period to another.	Agreement	Insurance Work Group	NEW
Incident	Incident is an Event defined within a policy that may or may not result in Loss.	Event	Insurance Work Group	
Indemnify	Indemnify is the act of returning someone who has sustained a loss to the position they were in before the loss occurred.	General Insurance Term	Dictionary of Insurance	NEW

Indemnity	Indemnity is compensation for loss. In Property and Casualty insurance, the objective is to restore the insured to the same (not better or worse) financial condition after the loss as they were before the loss.	General Insurance Term	Barron's Insurance Terms	NEW
Independent Adjuster	Independent Adjuster is a Role played by a Party who handles a claim brought against an insurance company or syndicate, and who is not an employee of the Insurance company. An insurance company will hire independent adjusters when risks are relatively remote from an insurer's home office or branch office, when the number of like risks in the portfolio are small and when the risks require specialized expertise to be handled appropriately. The adjuster evaluates the merits of each claim and makes recommendations. An adjuster's actions include: collating details, validating coverage, resolving disputes and agreeing where appropriate to settle claims at a fair price. The adjustor is subject to authority limits defined by company policy, contract, experience or line of business.	Party Role	Insurance Work Group	
Independent Agent	Independent Agent is a licensed and appointed member of an insurance agency who is not an employee of an insurance organization, but who is responsible for generating new policies and servicing existing policies on their behalf.	Party Role	Insurance Work Group	
Individual Agreement	Individual Agreement is a kind of legal or contractual Agreement that an Individual voluntarily enters.	Agreement	Insurance Work Group	

Industry Code	Industry Code is an external classification of industries, such as an SIC (Standard Industry Classification Code). Example: 63nnnnnn is the classification series for Insurance Carriers.	Party	Insurance Work Group	NEW
In-House Adjuster	In-House Adjuster is a Role played by a Party who handles a claim brought against an insurance company or syndicate, and who is an employee of the insurance company.	Party Role	Insurance Work Group	
Inpatient	Inpatient is a Role played by a Person who is formally admitted (or hospitalized) to an institution for treatment and/or care and stays for a minimum of one night in the hospital or other institution providing inpatient care.	Party Role	Insurance Work Group	
Insurable Object	Insurable Object is an item which may be included or excluded from an insurance coverage or policy, either as the object for which possible damages to the object or loss of the object is insured, or as the object for which damages caused by the object are insured. These objects can be real (land and attachments) and personal (movable effects not attached to land). Examples: residence, vehicle, class of employees.	Insurable Object	Insurance Work Group	change
Insurable Object Owner	Insurable Object Owner is a Role played by a Party that has financial ownership of an object covered against financial loss by an insurance policy or contract.	Party Role	Insurance Work Group	
Insurance Agency	Insurance Agency is an organization formed to market, sell and service insurance contracts from insurers with whom the organization has been appointed and within a territory by which the organization has been licensed.	Party Role	Insurance Work Group	
Insurance Carrier	Insurance Carrier is a company that provides protection against a risk in the form of insurance coverage. This term is synonymous with insurer, insurance company, or carrier.	Party Role	Insurance Work Group	
Insurance Class	Insurance Class is the type or line of insurance business in which the organization is engaged, e.g. Property and Casualty or Life Insurance.	Product Coverage	Insurance Work Group	

Insurance Company	Insurance Company is an organization providing protection for life, health, property or casualty risks based on formal written agreements that are purchased by individuals or organizations.	Party Role	Insurance Work Group	
Insurance Contract	Insurance Contract is a document legally binding an insurance company and an insured individual to the terms and conditions outlined in the document pertaining to the purchase, maintenance, support and fulfillment of the insurance coverage defined in the document.	Agreement	Insurance Work Group	
Insurance Policy	Insurance Policy is a legally binding contract between an insurance organization and an individual or business organization outlining the responsibilities of both parties, the kind and amount of coverage, limits of coverage and cost of coverage.	Policy	Insurance Work Group	
Insurance Product	Insurance Product is a kind of financial services product provided by an insurance carrier to indemnify a risk.	Product Coverage	Insurance Work Group	
Insurance Service	Insurance Service is a task performed to support or deliver on the promises of an insurance policy.	General Insurance Term	Insurance Work Group	
Insured	Insured is a Role played by a Party whose risk or other interest in the subject matter of the insurance is indemnified under the policy. The insured does not necessarily need to be the policyholder or the beneficiary.	Party Role	Insurance Work Group	
Insured Account	Insured Account is an account at a brokerage firm, bank, savings and loan association or credit union that is insured either by a federal or private insurance. This could also be an organization that has one or more contractual relationships with a commercial lines insurer.	Account	Insurance Work Group	
Insurer	Insurer is a Role played by a Party who provides insurance policies and indemnifies individuals and organizations against loss.	Party Role	IBM IAA	

Intermediary Agreement	Intermediary Agreement is a kind of Agreement that defining the ways in which an intermediary can act on behalf of the financial services company. This includes the specification of the authorized territory, the authorized line of business, the compensation conditions, and so on.	Agreement	Insurance Work Group	
Legal Adviser	Legal Advisor is a Role played by a Third Party to give legal guidance and advice on the way the latter party conducts business.	Party Role	Insurance Work Group	
Legal Identifier	Legal Identifier is a term representing a unique alpha numeric code for identification of an individual or organization within a legal jurisdiction.	Party	Insurance Work Group	
Legally Competent Party	Legally Competent Party is a Party having the right under law to make decisions, engage in business relationships, commit to contractual terms and engage in legally required activities on behalf of themselves, others, and/or organizations.	Party	Insurance Work Group	
Life Event	Life Event is an incident that occurs during the lifetime of a Party and that may have importance in a decision by the party to contemplate the purchase of insurance, e.g. the birth of a child, a birthday, a graduation event.	Event	Insurance Work Group	
Life Of A Claim	Life Of A Claim is the period of time between the first notice of loss or first report of injury, and the final settlement of a claim. This period may cover several years, especially for some personal injury claims or claims that may result in litigation. Claim reserves are set aside at the time of the claim to cover demand for benefits in the future.	Claim	Insurance Work Group	
Limit	Limit, or Policy Limit, defines the highest amount that could be paid (or can be another limit expression such as number of days of compensation), associated with the policy coverages.	Product Coverage	Insurance Work Group	NEW
Line Of Business	Line of Business is the kind of insurance business in which the organization is engaged, e.g. property, liability, life, health.	Product Coverage	Charlie Schaefer	

Line Of Business Group	Line Of Business Group is the aggregation of insurance policies, coverages or contracts by an insurance carrier, either for internal reporting purposes or external reporting purposes.	Product Coverage	Insurance Work Group	
Lines Of Insurance	Lines Of Insurance is a grouping of lines of business for reporting purposes, e.g. Property insurance, Liability insurance, Life Insurance.	Product Coverage	Insurance Work Group	
Litigation	Litigation is a judicial contest through which legal rights are sought to be determined and enforced.	Claim	Insurance Work Group	
Location Address	Location Address is a Contact Point that is an address used for the delivery of letters and packages by an external mailing or packaging service, at a place where the recipient usually lives or works. Note that the exact structure of a postal address is likely to change depending on the country of the postal address.	Location	Insurance Work Group	NEW
Loss	Loss is the total amount paid under an insurance company for a claim. This includes the actual amount paid to the beneficiary, the amount paid to any individuals or organizations involved in adjusting the claim, and any amount reserved for future payment.	Money	Insurance Work Group	
Loss Event	Loss Event is a specific incident that results or may result in a claim for an insurance benefit. Examples include death, theft, car accident, fire and hospitalization.	Event	Insurance Work Group	
Loss Payee	Loss Payee is a Role played by a Party to whom payments for loss under a policy will be payable (e.g. a mortgagee).	Party Role	Insurance Work Group	

Mailing Preference	Mailing Preference is a choice made by an individual or an organization on the first physical postal address at which to receive deliveries from a postal carrier or service. Mailing Preference is implemented in the data model as Party Communication that resolves the many-to-many relationship between a Party and the Communication Identity that points to the Location and Address entities.	Communication	Insurance Work Group	
Manager	Manager is a role played by an individual within an organization who defines and communicates the work activities of others, makes decisions regarding the allocation of resources, and legally engages in relationships with individuals and organizations outside the organization.	Party Role	Insurance Work Group	NEW
Managing General Agent	Managing General Agent is a role played by a wholesale insurance intermediary with the authority to accept placements from (and often to appoint) retail agents on behalf of an insurer. Managing general agents generally provide underwriting and administrative services, such as policy issuance, on behalf of the insurers they represent. These arrangements are most common in the surplus lines marketplace. Typically, MGAs market more unusual coverage, such as professional liability, for which specialized expertise is required to underwrite policies. MGAs benefit insurers because such expertise is not always available within the company and would be more costly to develop on an in-house basis.	Party Role	Insurance Work Group	
Manufactured Object	Manufactured Object is an Insurable Object that was made by machine or by industrial process.	Insurable Object	Insurance Work Group	
Maximum Per Claim Amount	Maximum Per Claim Amount is the Limit that can be paid for any single event for which a claim is reported. This amount is inclusive of all coverage provided by an insurance policy.	Product Coverage	Insurance Work Group	NEW

Maximum Per Person Amount	Maximum Per Person Amount is the Limit that can be paid to any person for the specified coverage per claim.	Product Coverage	Insurance Work Group	NEW
Medical Condition	Medical Condition is an assessment of the health state and physical condition of person, that may be covered or indemnified by an insurance policy. Medical Conditions include injuries, disease, disability, and can include objective measures such as height, weight and blood pressure.	Assessment	Insurance Work Group	change
Mid Term	Mid Term is a type of endorsement that is applied to a policy whereby the changes are made and effective at a point in time after the effective date and before the expiration date of a policy term, and not from the effective date of the policy.	Event	Insurance Work Group	
Milking Machine	Milking Machine is an Insurable Object that is a kind of Farm Equipment and is a machine for milking cows.	Insurable Object	Insurance Work Group	
Mobile Communication Preference	Mobile Communication Preference identifies and defines how an individual expects to receive information or engage in conversation when not at a physical structure that has a hard wired communication device. IN the data model, this is contained in Party Communication and Communication Identity.	Communication	Insurance Work Group	NEW
Mobile Home	Mobile Home is an Insurable Object that is a dwelling unit manufactured in a factory and designed to be transported to a site and semi permanently attached.	Insurable Object	Insurance Work Group	
Model Specification	Model Specification identifies the manufacturer's designated model name and features of Insurable Objects including but not limited to trucks, aircraft, or automobiles.	Insurable Object	Insurance Work Group	
Money	Money is any financial amount that can apply to any of the major business products and services, such as policy, claim, transaction, etc. To date, these are in the data model as Policy Amount and Claim Amount.	Money	Insurance Work Group	change



Money Provision	Money Provision is a summary of potential and contractual monetary flows, defined by their timing, effective dates, method of payment and so on. The primary use of money provisions in an insurance company is to represent premium payment schedules and insurance benefit limits as defined in an insurance policy. It can also be used to represent an amount referenced in a loan, a commission amount, a salary, a bonus, an expense associated to an internal or external cost, an interest amount and so on. Examples are: Premiums and Limits.	Money	Insurance Work Group	
Motorcycle	Motorcycle is an Insurable Object that is a two or three wheeled automotive vehicle for one or two people.	Insurable Object	Insurance Work Group	
Mutual Fund Provider	Mutual Fund Provider is a kind of Service Provider who offers shares in an investment company that uses the capital to buy a diverse group of stocks from other companies based on a stated set of investment objectives. Supplier is a Role played by a Party who supplies materials, products, or services to others; firm in either the wholesale or the retail supply business.	Party Role	Insurance Work Group	
Name	Name is the wording used to provide a familiar label for any object or party. Names may not be unique and so additional attributes are needed to uniquely identify any specific object or party. Therefore names are never used as identifiers.	General Insurance Term	Insurance Work Group	NEW
Natural Event	Natural Event is an occurrence of a type where indemnification or insurance coverage may apply such as an earthquake or forest fire or mudslide or hurricane. In the data model, a specific Natural Event is represented as an Occurrence and possibly also as a Catastrophe.	Claim	Insurance Work Group	

New Business	New Business is a policy transaction by which an insurance policy is purchased by or sold to an individual or organization where no current relationship exists for that policy type with the insurance company. This operation is recognized when the first premium is collected.	Event	Insurance Work Group	
Not For Profit Organization	Not For Profit Organization is a kind of Organization that has received a current and appropriate government designation as a Not for Profit entity.	Party	Insurance Work Group	
Number	Number is a numeric value that can be expressed as a decimal, exponent, positive or negative value, and against which one can perform arithmetic functions.	General Insurance Term	Insurance Work Group	NEW
Object Assessment	Object Assessment is the review and evaluation of a specific insured item for validation of coverage.	Assessment	Insurance Work Group	
Occupation	Occupation is a kind of activity describing a person's usual or principal work or business activity, role and responsibility, esp. as a means of earning a living; vocation.	Party	Insurance Work Group	
Occurrence	Occurrence is an event that results in bodily injury and/or property damage to a third party. A clause that is common to most liability insurance policies stipulates that all bodily injuries and/or property damages resulting from the same general conditions are interpreted as resulting from one occurrence and thus subject to the policy limits per occurrence.	Claim	Insurance Work Group	

Offer	Offer is an amount or item of value to be provided by an insurance company in exchange for an individual or organization agreeing to terminate or settle a claim.	Claim	Insurance Work Group	
Opponent Third Party	Opponent Third Party is an individual or group involved in the settlement of a claim whose interests are opposed to the interests of the insurance company attempting to settle the claim.	Claim	Insurance Work Group	
Organization	Organization is a Party which is a business concern or a group of individuals that are systematically bound by a common purpose. Organizations may be legal entities in their own right. This includes commercial organizations such as corporations, limited liability companies, partnerships, publicly quoted multinationals, subsidiaries etc. It also includes more informal groupings such as clubs, societies, charities and interest groups consisting of two or more people. The example sub-types that have been included in the model are: Association, Trust, Company, Affinity group, Professional group.	Party	Insurance Work Group	
Organizational Event	Organizational Event is a business entity change such as a merger or acquisition.	Event	Insurance Work Group	
Other Assessment Result	Other Assessment Result is a kind of Assessment Result that is not covered by other commonly listed options available.	Assessment	Insurance Work Group	
Outpatient	Outpatient is a Role played by a Person who is not formally admitted to a facility (physician's private office, hospital outpatient center or ambulatory-care center) for treatment and/or care and who does not stay overnight.	Party Role	Insurance Work Group	
Pager	Pager is a contact point that is a pocket-size electronic device whose signal notifies a person of an important message, sometimes displaying the telephone number to be called.	Communication	Insurance Work Group	

Party	Party is a Person, Organization or Grouping that can enter into a contract or other legal proceeding, or which plays a role in the insurance industry.	Party	Insurance Work Group	
Party Role	Party Role is a responsibility assumed by a Party in relation to something. Examples: Agreement Party Role – Party enters into an Agreement via an Agreement Party Role OR Insurable Item Party Role – Party owns or is financially accountable for an Insurable Item via an Insured Item Party Role OR Claim Party Role – Party files or submits a Claim via a Claim Party Role.	Party Role	Insurance Work Group	
Patient	Patient is a Role played by a Person who is in contact with the health care system seeking attention for a health condition.	Party Role	Insurance Work Group	
Payment	Payment is a transfer of money between two parties or between two money repositories of the same party in exchange for indemnification contractually provided, services received or products acquired. A payment could be made either by the insurance company or by a third party.	Event	Insurance Work Group	
Payment Due	Payment Due is the monetary amount this is to be paid in exchange for insurance policies, products or coverages provided, or in payment for services provided.	Money	Insurance Work Group	
Permanent Policy	Permanent Policy is a document, contract or agreement issued by an insurance company providing insurance coverage for a person, object or location from the effective date until the agreement is cancelled or the person, object or location no longer exists.	Policy	Insurance Work Group	change
Person	Person is a Party who is an individual human being, either alive or dead.	Party	Insurance Work Group	
Person Assessment	Person Assessment is the evaluation of a person (a type of Party), such as the condition of their health, their blood pressure, their height and weight. All these factors would have a bearing on their fitness for insurance. Defines the evaluation	Assessment	Insurance Work Group	

	of an individual that measures their likelihood of contribution to the probability of future events that may increase the risk under an insurance policy or contract issued.			
Personal Event	Personal Event is a life event such as a marriage or retirement. For P&C a personal event is an event that changes the underlying relationship with the insurance company. Examples would include the sale of an automobile and the purchase of another one, the sale of a house and the purchase of another one, a child receiving a license and needing to be included under a current policy, etc.	Event	Insurance Work Group	
Personal Inland Marine Insurance	Personal Inland Marine Insurance is a kind of Personal Line Insurance designed to insure exposures that cannot be conveniently or reasonably confined to a fixed location or insured at a standard rate under a standard form. Examples: valuable items, parcel post, trailers.	Product Coverage	Insurance Work Group	change
Personal Line Insurance	Personal Line Insurance is a kind of Property and Casualty insurance that is written on the personal, real and non-business related property of an individual (or individuals).	Product Coverage	Insurance Work Group	
Physical Location	Physical Location is an area bounded by parameters such as Latitude and Longitude, Altitude, Depth, etc.	Location	Insurance Work Group	
Physical Object Assessment	Physical Object Assessment is an assessment type that measures the risks represented by ownership, utilization or proximity of the physical object. It collects information regarding the likelihood of the object to contribute to the probability of future loss under an insurance policy or contract issued.	Assessment	Insurance Work Group	
Place Assessment	Place Assessment is information regarding a location and/or physical structure that may impact its likelihood to contribute to the probability of future events that may increase the risk under an insurance policy or contract issued.	Assessment	Insurance Work Group	

Policy	Policy is a legal document that defines a written Agreement between an insurance company and an individual or organization that puts insurance coverage into effect.	Policy	Insurance Work Group	
Policy Coverage	Policy Coverage defines the limits, terms and conditions of the type and extent of insurance or indemnification provided to an individual or organization under a contractual agreement of insurance.	Product Coverage	Insurance Work Group	
Policy Coverage Part	Policy Coverage Part is a major section of a Policy that organizes the coverages. Typically, there are Coverage Parts for property and liability.	Product Coverage	Insurance Work Group	NEW
Policy Deductible	Policy Deductible defines the Deductibles (attachment point for coverage) associated with the policy coverages. Deductibles are the loss amounts paid by the insured before insurance payments apply.	Product Coverage	Insurance Work Group	NEW
Policy Event	Policy Event is an event that deals with servicing an insurance policy. Examples would include Policy Renewal, Reinstatement, Cancellation, etc.	Event	Insurance Work Group	
Policy Form	Policy Form is a document that explains the insurance coverages for a policy. These are usually standard industry forms augmented by insurer-specific cover pages and specialized addendums.	Policy	Insurance Work Group	NEW
Policy Form Number Value	Party Form Number Value (called Policy Form Number) is the (often non-numeric) set of characters used to identify an attachment to a property and casualty policy. This "value" is usually established by the state or by a rating bureau (i.e., the Insurance Services Office (ISO)), or by the insurance company.	Policy	Insurance Work Group	NEW
Policy Limit	Policy Limit defines the Limits (highest amount of coverage or other limit expression such as number of days compensation) associated with the policy coverages.	Product Coverage	Insurance Work Group	NEW

Policy Number	Policy Number is the external identification for a policy and may include alpha policy types as well as numbers.	Policy	Insurance Work Group	NEW
Policy Relationship	Policy Relationship defines the relationship between two policies.	Policy	Insurance Work Group	
Policy Term	Policy Term is the agreed maximum period of time for which an individual or organization applies for or is granted coverage under an insurance policy, contract or agreement. Typical Policy Terms are one year or six months, with provision for "renewal" after that duration of time. Normally, rates can change at the end of each Policy Term. The actual retrospective Policy Term is the period of time during which a policy is in force - the time between the Policy Effective Date and the Policy Termination Date (the Expiration Date or a Cancellation Date).	Policy	Insurance Work Group	change
Policyholder	Policyholder is an individual or organization who owns an insurance policy.	Party Role	Insurance Work Group	
Postal Address	Postal Address is a Contact Point that is an address used for the delivery of letters and packages by an external mailing or package delivery service, at a place where the recipient usually lives or works. Note that the exact structure of a postal address is likely to change depending on the country of the postal address.	Location	Insurance Work Group	
Postal Code	Postal Code represents an alphanumeric code assigned to groups of addresses by various national postal systems throughout the world to facilitate mail delivery.	Location	Insurance Work Group	NEW
Pre Qualification	Pre-Qualification is an Event resulting from the process of assuring that a risk will be acceptable and a policy will be issued before either the application is received or the policy is	Event	Insurance Work Group	

	fully underwritten.			
Preferred Language	Preferred Language is the designation for the language of choice for the related Organization, Person, or Grouping.	Communication	Insurance Work Group	
Preferred Provider	Preferred Provider is a Role that designates as preferred an organization or individual which provides contracting services on behalf of an insurer to a claimant.	Party Role	Insurance Work Group	
Premium	Premium is the money amount that is charged for the amount of insurance and the coverage terms provided under the policy.	Money	Insurance Work Group	
Premium Auditor	Premium Auditor is the Role that determines the exposure basis for an insurance policy, i.e., payroll, sales, or vehicle count, after the end of a policy period to determine the actual (audited) exposure for the purpose of making a final calculation of the premium and premium taxes.	Party Role	Insurance Work Group	
Pro Rata	Pro Rata is a type of cancellation Event where the policy is deemed to have been effective for a period of time and only a pro rata amount of premium is returned based on the time the policy was effective. The calculation methodology for the pro rata amount can change from insurance company to insurance company.	Event	Insurance Work Group	
Producer	Producer is a Role played by a Person who sells and services insurance policies in the jurisdictions for which the person is licensed, and for the companies for which the producer is appointed.	Party Role	Insurance Work Group	
Product	Product is the definition of what is agreed between the insurance company and its customers as an item to be purchased as part of an insurance agreement.	Product Coverage	Insurance Work Group	



Property In Transit	Property in Transit, also called Goods in Transit, pertains to the insurance for goods being shipped, for which the seller is usually responsible. The Property, or Goods, are represented in the data model as Insurable Objects.	Insurable Object	Insurance Work Group	change
Property Insurance	Property Insurance is indemnification written on physical structures, whether residential or commercial, or their contents.	Product Coverage	Insurance Work Group	
Prospect	Prospect is a Role played by a Party who is a potential purchaser of an insurance product.	Party Role	Insurance Work Group	
Prospective Customer	Prospective Customer is an individual or organization that may purchase an insurance policy in the near future.	Party Role	Insurance Work Group	
Provider	Provider is a Role played by a party to provide a service or to take responsibility for people who contract with them. Provider Roles are usually defined specifically, such as for a Healthcare Provider versus Financial Services Provider, etc.	Party Role	Insurance Work Group	NEW
Provider Agreement	Provider Agreement is a kind of Agreement between an individual or organization which provides products and/or services, and the individual or organization contracting for the products and/or services.	Agreement	Insurance Work Group	
Public Adjuster	Public Adjuster is a Role played by a Party who, as an Adjuster, represents the interests of the claimant rather than the insurance company.	Party Role	Insurance Work Group	
Quote	Quote is a type of Event that is a price estimate for an insurance policy. The estimate is considered not to be binding. The quote is usually based on a reduced set of the information required for an insurance policy, so the stated price can only be an approximation and may change when the required final information is provided and validated.	Event	Insurance Work Group	

Rating Territory	Rating Territory is a code developed to charge a adequate premium for the risk within that geographic area.	Location	Insurance Work Group	NEW
Recovery	Recovery is a kind of Claim activity in which the insurance company attempts to recoup monies distributed in error or monies due it through the actions or inactions of others. Recovery monies can result from Salvage, Subrogation, or Reinsurance.	Claim	Insurance Work Group	change
Recreational Vehicle	Recreational Vehicle is an Insured Object that is a vehicle designed for recreation, as in camping.	Insurable Object	Insurance Work Group	
Regional Office	Regional Office is an Organization Unit of an insurance company's operations that may market, underwrite, and service the company's lines of business within a specified geographical area.	Party	Insurance Work Group	
Reinstatement	Reinstatement is a transaction that is applied to a policy to bring it back to actively insured status from a state where the policy was cancelled.	Event	Insurance Work Group	
Reinsurance Agreement	Reinsurance Agreement is a kind of Agreement between the Reinsurer and the Ceding Company that stipulates the manner in which the insurance liability written on various Risks insured by the Ceding Company is to be shared, and the cost of the risk sharing to the Ceding Company.	Agreement	Insurance Work Group	
Reinsurance Contract	See Reinsurance Agreement.	Agreement	Insurance Work Group	change
Reinsurance Recovery	Reinsurance Recovery is the act of providing the appropriate information and validation of a loss(es) in order to receive payment from a reinsurance organization providing either facultative or treaty reinsurance.	Claim	Insurance Work Group	

Reinsurer	Reinsurer is an individual or organization who agrees contractually to share for a fee with the insurer of a risk the insurance liability written on the risk.	Party Role	Insurance Work Group	
Renewal	Renewal is the action of continuing the coverage provided by a policy from one term to the next when the original term expires. Renewal may result in changes to the original policy for terms such as premium amount, coverage terms, deductibles, limits of insurance, etc.	Event	Insurance Work Group	
Repair Facility	Repair Facility is an organization or location that repairs, replaces, or makes available for its intended use, a physical object that has suffered damage or loss.	Party	Insurance Work Group	
Residential Structure	Residential Structure is an Insurable Object that is used for human habitation.	Insurable Object	Insurance Work Group	
Rights	Rights are the ability contractually granted or implied for an individual or organization to make ownership decisions, apply changes, or receive benefits under an insurance policy.	General Insurance Term	Insurance Work Group	
Risk	Risk is when a person, physical object, location, or behavior is eligible for insurance coverage or indemnification by an insurance company.	General Insurance Term	Insurance Work Group	
Risk Factor Score		Assessment	Insurance Work Group	change
Risk Manager	Risk Manager is a Role played by a Party who is responsible for managing an organization's risks and minimizing the adverse impact of losses on the achievement of the organization's objectives. The risk manager is charged with identifying risks, evaluating risks, selecting the best techniques for treating identified risks, implementing the chosen risk management	Party Role	IRMI.com	NEW

	techniques, and regularly evaluating and monitoring the program.			
Sales Organization Unit	Sales Organization Unit is a business unit that is part of an internal or external Organization (defined as a Party) that is responsible for the sales (and possibly also marketing) of the insurance-related Products for which it is licensed and appointed to sell.	Party	Insurance Work Group	change
Sales Territory	Sales Territory is a geographic region in which a producer is both licensed and appointed to sell insurance products and services. This can be defined as an Organization Unit that is a subtype of Party. See also Rating Territory (not a Party) and Territory which can represent difference kinds of Organizational groupings.	Party	Insurance Work Group	NEW
Salvage	Salvage is the attempt by an Insurance Company to recover value from an object that is residual from the claim event but still has economic value.	Claim	Insurance Work Group	
Scheduled Item	Scheduled Item is an Insurable Object that is specifically listed in a property insurance contract, and insured separately from the standard property insurance in order to receive the full value for a loss. Examples are: expensive jewelry, furs, paintings, electronics, etc.	Insurable Object	Insurance Work Group	
Service Provider	Service Provider is a party that provides services to or for the insurance organization. Examples include: doctors, hospitals, laboratories, paramedics, garages, experts, vendors and other financial institutions.	Party Role	Insurance Work Group	

Services	Services are the provision of needed human knowledge, skill, or assistance that is delivered to a person or business. rather than physical items of value, that can be provided as insurable objects or provided through contractual obligation (such as claim settlement).	General Insurance Term	Insurance Work Group	change
Short Rate	Short Rate is a subtype of Cancellation which is a subtype of Policy Event. Short Rate means that when a policy is cancelled, the returned amount of premium is less than the "pro rata" proportion of the time the policy was in effect.	Event	Insurance Work Group	
Staff	Staff is a Role played by a Person when working for compensation, whether direct or indirect, for another Party in return for stipulated services.	Party Role	Insurance Work Group	NEW
Staff Classification	Staff Classification is a designation of staff persons as to benefit eligibility and level within an organization.	Party	Insurance Work Group	NEW
Staff Role	Staff Role defines the position and status of a person in an organization for a period of time.	Party Role	Insurance Work Group	NEW
Staff Work Assignment	Staff Work Assignment tracks the association between a staff person and a work area or work group within an organization. Example: a person works in an organization and is assigned to project team.	Party	Insurance Work Group	NEW
Staffing Agreement	Staffing Agreement is an Employment Agreement which is a written Agreement between employer and employee, stating the terms of employment in an organization.	Agreement	Insurance Work Group	NEW

Staffing Organization	Staffing Organization (Employer) is a Role played by a Party when that Party hires and pays wages, thereby providing a livelihood to individuals who perform work. The employment relationship confers authority on the employer, who has the right to control and direct the work to be performed. An employer also has the right to engage or discharge and furnish the working location and supplies. An employer is responsible for the collection and remission of federal income and Social Security taxes from employees' compensation.	Party Role	Insurance Work Group	NEW
State	State provides a reference list of U.S. States and Canadian Provinces.	Location	Insurance Work Group	NEW
Status	Status reflects the state, or condition, of a related entity (such as a policy or claim) at a given point in time or for a designation duration. Examples: Cancelled, Closed, Pending, etc.	General Insurance Term	Insurance Work Group	NEW
Structure	Structure is an Insurable Object that is a man-made building or construction.	Insurable Object	Insurance Work Group	
Subcontractor	Subcontractor is a Role played by a Party to whom a General Contractor or other subcontractor sublets part or all of a contract.	Party Role	Insurance Work Group	
Subrogation	Subrogation is the legal process by which an insurance company, after paying a loss, seeks to recover the amount of the loss or some portion of the loss from another party who is legally liable for it. For example, if a third party, through negligence, damages an insured's car and the insured's insurance company pays to restore the car, the insurance company has recourse against the third party for the costs involved. The insured cannot sue the third party for damage, since if successful; the insured could collect twice for the same damage.	Claim	Insurance Work Group	

Supplier	Supplier is a Role played by a Party who supplies materials, products, or services to others; firm in either the wholesale or the retail supply business.	Party Role	Insurance Work Group	NEW
Surcharge	Surcharge is a charge imposed in excess of standard or normal charges for products and services provided during an insurance activity. The surcharge may be imposed by a governmental organization, an insurance company, or a third party providing goods and services during an insurance event.	Money	Insurance Work Group	
Syndicate	Syndicate is a group of firms or organizations that in combination provide all required property and casualty insurance coverage, normally to a commercial organization.	Party	Insurance Work Group	
Task	Task is a step or sub-process that is executed to contribute to the fulfillment of a business unit of work. Examples: Claim Setup, Payment Issuance, Check Status.	Event	Insurance Work Group	change
Tax	Tax is a charge imposed by a governmental organization on individual and organizations in exchange for governmental goods and services.	Money	Insurance Work Group	NEW
Tax Identifier	Tax Identifier is a unique number or alphanumeric configuration that provides identification of an organization or individual by a taxing authority.	Party	Insurance Work Group	change
TDDTTY	TDDTTY is a telecommunications device for the deaf, a TDD is a Contact Point type that is an electronic device for text communication via a telephone line, used when one or more of the parties have hearing or speech difficulties. Another name for TDD is TTY (telephone typewriter or teletypewriter).	Communication	Insurance Work Group	
Team	Team is a subtype example of a Grouping that is a subtype of Party.	Party	Insurance Work Group	NEW

Team Leader	Team Leader is a Role that may apply to any major object that requires team support.	Party Role	Insurance Work Group	NEW
Team Member	Team Member is a Role that may apply to any major object that requires team support.	Party Role	Insurance Work Group	NEW
Telephone	Telephone is a Contact Point type that is an instrument for reproducing sounds at a distance; specifically, one in which sound is converted into electrical impulses for transmission (as by wire or radio waves) and then re-converted into sound for use by the receiving contact point.	Communication	Insurance Work Group	
Telephone Preference	Telephone Preference is a reference to Party Communication (Type would be "Phone") with Preference attributes.	Communication	Insurance Work Group	change
Temporary Insurance Contract	Temporary Insurance Contract is a kind of contract which provides insurance coverage to an insurable person, object, or location from the signature of an application for insurance until a decision is rendered by the insurance company on the acceptance of the risk and an insurance policy is officially generated. See also Binder.	Agreement	Insurance Work Group	change
Terms And Conditions	Terms and Conditions are the items listed in a formal agreement between two parties that outline the agreement, the deliverables, the legal constraints and the recourse for non-performance.	Agreement	Insurance Work Group	
Third Party	Third Party is a party, other than the insured or insurer, who has been involved in an action or series of actions relevant to an insurance agreement between the insured and insurer. An example would be an individual or organization which incurred a loss due to actions or omissions of the insured.	Party Role	Insurance Work Group	



Third Party Administrator	Third Party Administrator is an organization that is not an insurance carrier but is contracted to provide administrative services on behalf of the insurance carrier.	Party Role	Insurance Work Group	
Third Party Staffing Agreement	Third Party Staffing Agreement is an example of Agreement with a third party to provide human resources for company.	Agreement	Insurance Work Group	NEW
Time	Time specifies the Hour, Minute, and Second of a 24-hour day.	General Insurance Term	Insurance Work Group	NEW
Tractor	Tractor is an Insurable Object that is a kind of motor-driven vehicle used to handle various attachments and equipment.	Insurable Object	Charlie Schaefer	
Trailer	Trailer is an Insured Object that is pulled by another Vehicle and is used for transporting something.	Insurable Object	Insurance Work Group	
Training	Training is a development event attended by an intermediary or an employee to achieve full competence in some knowledge based or activity based aspect of the insurance industry. It may be organized internally by the insurer or offered by third parties. It may lead to a status recognized internally by the insurer, or to externally-recognized industry qualifications.	Event	Insurance Work Group	
Transaction	Transaction is an activity that, when conducted, represents the conduct of business between two or more parties in creating an agreement, fulfilling the terms of an agreement, exchanging monies, or changing an agreement.	Event	Insurance Work Group	
Transportation Class	Transportation Class is a subtype of Insurable Object that describes the kinds of Transportation being insured. Transportation is a type of "Inland Marine" insurance. This is also the Class Code used for Rating (see Class Codes).	Insurable Object	Insurance Work Group	NEW
Treaty	Treaty is a type of reinsurance agreement whereby the reinsurance terms and conditions have already been agreed to contractually between the issuing company and the	Agreement	Charlie Schaefer	NEW

	reinsurance company/ies. A treaty is written to cover relationships on multiple risks rather than a single risk.			
Truck	Truck is an Insurable Object that is any of various motor vehicles designed for carrying or pulling loads.	Insurable Object	Insurance Work Group	
Underwriter	Underwriter is a Role of a person who works for an insurer to determines if insurance risks should be accepted, and at what rate and price. The purpose of underwriting is to spread the risk among a pool of insureds in a manner that is equitable for the insureds and profitable for the insurer.	General Insurance Term	Barron's Insurance Terms	NEW
Underwriting Assessment	Underwriting Assessment is an evaluation provided by an Underwriter who is reviewing the proposed new or renewal policy to determine willingness to accept the risk. Items that might be evaluated are the limits of insurance being requested, the demographics of the location, the demographics of the requestor, the condition of the Insurable Object, etc.	Assessment	Insurance Work Group	
Units Produced	Units Produced is the insured production from a commercial manufacturing organization.	Party	Insurance Work Group	
Van	Van is an Insured Object that is a usually enclosed vehicle used for the transportation of goods or animals.	Insurable Object	Insurance Work Group	
Vehicle	Vehicle is an Insurable Object that is a conveyance for transporting people and/or goods.	Insurable Object	Insurance Work Group	
Victim	Victim is a Role played by a Party who is affected by any kind of loss, condition or event that results in the submission of a claim.	Party Role	Insurance Work Group	

Visual Communication Preferences	Visual Communication Preferences is a term used to identify or define how an individual expects to receive information or engage in conversation when the information or communication include or require visual contact between two or more parties. See Party Communication.	Communication	Insurance Work Group	
Watercraft	Watercraft is an Insurable Object that is a Vehicle made for transportation on water and primarily used for personal use. It may be motorized or may be manually propelled.	Insurable Object	Insurance Work Group	
Web Address	Web Address is a Contact Point type that is used by the World Wide Web browsers to locate and communicate with individuals, organizations and resources on the Internet. The addressing scheme is a Uniform Resource Locator or Universal Resource Locator (URL). See Party Communication.	Communication	Insurance Work Group	
Witness	Witness is an example of someone who has firsthand knowledge about a significant event through their senses (e.g. seeing, hearing, smelling, touching), and who can help certify important details and considerations regarding the event.	Party Role	Insurance Work Group	
Work Contact Point Indicator	Work Contact Point Indicator is a term describing or defining the method that an individual prefers to receive information or be engaged in a conversation by a third party while at their place of employment or the location at which they provide products and services to others for a fee. See Party Communication.	Communication	Insurance Work Group	
Workers Comp Class	Workers Comp Class is a Job classification covered by a policy providing insurance coverage on medical and indemnity losses of employees of an organization. See also Class Code.	Insurable Object	Insurance Work Group	NEW
Written Premium	Written Premium is the policy premium that is booked to the company financials as the amount the company will be due should the policy go full term.	Money	Insurance Work Group	NEW
Account Facility				Deleted

Activity				Deleted
Agreement Party Role				Deleted
Assessment Activity				Deleted
Campaign				Deleted
Campaign Cell				Deleted
Campaign Management				Deleted
Campaign Step				Deleted
Claim Folder Supporting Data				Deleted
Claim Party Role				Deleted
Claimee				Deleted

Class Codes				Deleted
Cognitive Communication Preferences				Deleted
Company Description				Deleted
Contact Point				Deleted
Contact Preference				Deleted
Credit				Deleted
Deductable Amount				Deleted
Deductable Rate				Deleted
Document Sequence Number				Deleted
Driving				Deleted

Dun And Bradstreet Code				Deleted
Earned				Deleted
Effetive Date				Deleted
Employment Classification				Deleted
Facultative Agreement				Deleted
Fees				Deleted
Geographic Area				Deleted
Hearing Communication Preferences				Deleted
Home Contact Point Indicator				Deleted
Insurable Object Group				Deleted

Location Insurable Object				Deleted
Management				Deleted
Marketing Strategy Activity				Deleted
Max Per Claim Amount				Deleted
Max Per Person Amount				Deleted
Mobility Communication Preferences				Deleted
Organization Description				Deleted
Other Personal Activity				Deleted
Particular Activity				Deleted
Product Description				Deleted

Product Line Of Business				Deleted
Proposed Insurable Object				Deleted
Proposed Insured				Deleted
Provider Role				Deleted
Regular Dealings				Deleted
Taxes				Deleted
Territory				Deleted
Treaty Agreement				Deleted
Workers Comp Classes				Deleted
Written				Deleted



## Part Four

### 8.1 Changes or Extensions to Existing OMG Specifications

None