

# Ground Equipment Monitoring Service (GEMS) Specification

## 1.1

---

OMG Document Number: dtc/2009-10-05

Standard document URL: <http://www.omg.org/spec/GEMS/1.1/PDF>

Associated File(s)\*: [http://www.omg.org/spec/GEMS/2009-10-03 \(XSD\)](http://www.omg.org/spec/GEMS/2009-10-03 (XSD))  
[http://www.omg.org/spec/GEMS/2009-10-06 \(XMI\)](http://www.omg.org/spec/GEMS/2009-10-06 (XMI))

---

Copyright © 2008, Object Management Group, Inc.

## USE OF SPECIFICATION - TERMS, CONDITIONS & NOTICES

The material in this document details an Object Management Group specification in accordance with the terms, conditions and notices set forth below. This document does not represent a commitment to implement any portion of this specification in any company's products. The information contained in this document is subject to change without notice.

## LICENSES

The companies listed above have granted to the Object Management Group, Inc. (OMG) a nonexclusive, royalty-free, paid up, worldwide license to copy and distribute this document and to modify this document and distribute copies of the modified version. Each of the copyright holders listed above has agreed that no person shall be deemed to have infringed the copyright in the included material of any such copyright holder by reason of having used the specification set forth herein or having conformed any computer software to the specification.

Subject to all of the terms and conditions below, the owners of the copyright in this specification hereby grant you a fully-paid up, non-exclusive, nontransferable, perpetual, worldwide license (without the right to sublicense), to use this specification to create and distribute software and special purpose specifications that are based upon this specification, and to use, copy, and distribute this specification as provided under the Copyright Act; provided that: (1) both the copyright notice identified above and this permission notice appear on any copies of this specification; (2) the use of the specifications is for informational purposes and will not be copied or posted on any network computer or broadcast in any media and will not be otherwise resold or transferred for commercial purposes; and (3) no modifications are made to this specification. This limited permission automatically terminates without notice if you breach any of these terms or conditions. Upon termination, you will destroy immediately any copies of the specifications in your possession or control.

## PATENTS

The attention of adopters is directed to the possibility that compliance with or adoption of OMG specifications may require use of an invention covered by patent rights. OMG shall not be responsible for identifying patents for which a license may be required by any OMG specification, or for conducting legal inquiries into the legal validity or scope of those patents that are brought to its attention. OMG specifications are prospective and advisory only. Prospective users are responsible for protecting themselves against liability for infringement of patents.

## GENERAL USE RESTRICTIONS

Any unauthorized use of this specification may violate copyright laws, trademark laws, and communications regulations and statutes. This document contains information which is protected by copyright. All Rights Reserved. No part of this work covered by copyright herein may be reproduced or used in any form or by any means--graphic,

electronic, or mechanical, including photocopying, recording, taping, or information storage and retrieval systems--without permission of the copyright owner.

#### DISCLAIMER OF WARRANTY

WHILE THIS PUBLICATION IS BELIEVED TO BE ACCURATE, IT IS PROVIDED "AS IS" AND MAY CONTAIN ERRORS OR MISPRINTS. THE OBJECT MANAGEMENT GROUP AND THE COMPANIES LISTED ABOVE MAKE NO WARRANTY OF ANY KIND, EXPRESS OR IMPLIED, WITH REGARD TO THIS PUBLICATION, INCLUDING BUT NOT LIMITED TO ANY WARRANTY OF TITLE OR OWNERSHIP, IMPLIED WARRANTY OF MERCHANTABILITY OR WARRANTY OF FITNESS FOR A PARTICULAR PURPOSE OR USE. IN NO EVENT SHALL THE OBJECT MANAGEMENT GROUP OR ANY OF THE COMPANIES LISTED ABOVE BE LIABLE FOR ERRORS CONTAINED HEREIN OR FOR DIRECT, INDIRECT, INCIDENTAL, SPECIAL, CONSEQUENTIAL, RELIANCE OR COVER DAMAGES, INCLUDING LOSS OF PROFITS, REVENUE, DATA OR USE, INCURRED BY ANY USER OR ANY THIRD PARTY IN CONNECTION WITH THE FURNISHING, PERFORMANCE, OR USE OF THIS MATERIAL, EVEN IF ADVISED OF THE POSSIBILITY OF SUCH DAMAGES.

The entire risk as to the quality and performance of software developed using this specification is borne by you. This disclaimer of warranty constitutes an essential part of the license granted to you to use this specification.

#### RESTRICTED RIGHTS LEGEND

Use, duplication or disclosure by the U.S. Government is subject to the restrictions set forth in subparagraph (c) (1) (ii) of The Rights in Technical Data and Computer Software Clause at DFARS 252.227-7013 or in subparagraph (c) (1) and (2) of the Commercial Computer Software - Restricted Rights clauses at 48 C.F.R. 52.227-19 or as specified in 48 C.F.R. 227-7202-2 of the DoD F.A.R. Supplement and its successors, or as specified in 48 C.F.R. 12.212 of the Federal Acquisition Regulations and its successors, as applicable. The specification copyright owners are as indicated above and may be contacted through the Object Management Group, 140 Kendrick Street, Needham, MA 02494, U.S.A.

#### TRADEMARKS

MDA®, Model Driven Architecture®, UML®, UML Cube logo®, OMG Logo®, CORBA® and XMI® are registered trademarks of the Object Management Group, Inc., and Object Management Group™, OMG™, Unified Modeling Language™, Model Driven Architecture Logo™, Model Driven Architecture Diagram™, CORBA logos™, XMI Logo™, CWM™, CWM Logo™, IIOP™, MOF™, OMG Interface Definition Language (IDL)™, and OMG SysML™ are trademarks of the Object Management Group. All other products or company names mentioned are used for identification purposes only, and may be trademarks of their respective owners.

## COMPLIANCE

The copyright holders listed above acknowledge that the Object Management Group (acting itself or through its designees) is and shall at all times be the sole entity that may authorize developers, suppliers and sellers of computer software to use certification marks, trademarks or other special designations to indicate compliance with these materials.

Software developed under the terms of this license may claim compliance or conformance with this specification if and only if the software compliance is of a nature fully matching the applicable compliance points as stated in the specification. Software developed only partially matching the applicable compliance points may claim only that the software was based on this specification, but may not claim compliance or conformance with this specification. In the event that testing suites are implemented or approved by Object Management Group, Inc., software developed using this specification may claim compliance or conformance with the specification only if the software satisfactorily completes the testing suites.

## **OMG's Issue Reporting Procedure**

All OMG specifications are subject to continuous review and improvement. As part of this process we encourage readers to report any ambiguities, inconsistencies, or inaccuracies they may find by completing the Issue Reporting Form listed on the main web page <http://www.omg.org>, under Documents, Report a Bug/Issue (<http://www.omg.org/technology/agreement.htm>).

# Table of Contents

|            |                                    |             |
|------------|------------------------------------|-------------|
| <b>1</b>   | <b>Scope</b>                       | <b>vii</b>  |
| <b>2</b>   | <b>Conformance</b>                 | <b>viii</b> |
| <b>3</b>   | <b>Normative References</b>        | <b>viii</b> |
| <b>4</b>   | <b>Terms and Definitions</b>       | <b>viii</b> |
| <b>5</b>   | <b>Acknowledgements</b>            | <b>ix</b>   |
| <b>6</b>   | <b>PIM</b>                         | <b>x</b>    |
| <b>6.1</b> | <b>Overview</b>                    | <b>x</b>    |
| <b>6.2</b> | <b>GEMS Use Cases</b>              | <b>x</b>    |
| 6.2.1      | GEMS User                          | xi          |
| 6.2.2      | Device Vendor                      | xi          |
| 6.2.3      | Define GEMS Device                 | xi          |
| 6.2.4      | Connect To Device                  | xi          |
| 6.2.5      | Send Directive                     | xi          |
| 6.2.6      | Configure Device                   | xii         |
| 6.2.7      | Obtain Configuration               | xii         |
| 6.2.8      | Save Configuration                 | xii         |
| 6.2.9      | Restore Configuration              | xiii        |
| 6.2.10     | Obtain Device Information          | xiii        |
| 6.2.11     | Proxy & Route GEMS Message         | xiii        |
| 6.2.12     | GEMS High Level Design             | xiv         |
| <b>6.3</b> | <b>GEMS UML Design</b>             | <b>xiv</b>  |
| 6.3.1      | Parameters                         | xvii        |
| 6.3.2      | Messages                           | xix         |
| 6.3.3      | Controlling and Monitoring Devices | xxiii       |
| <b>6.4</b> | <b>Directives</b>                  | <b>xxx</b>  |
| 6.4.1      | DirectiveMessage                   | xxx         |
| 6.4.2      | DirectiveResponse                  | xxx         |

|   |              |
|---|--------------|
| <b>6.5 GEMS Security</b>                        | <b>xxxii</b> |
| <b>6.6 GEMS Internationalization</b>            | <b>xxxii</b> |
| <b>6.7 Standard Devices</b>                     | <b>xxxii</b> |
| <b>7 PSM (XML)</b>                              | <b>xxxii</b> |
| <b>7.1 PIM To PSM Mapping</b>                   | <b>xxxii</b> |
| 7.1.1 GEMS_base_types.xsd                       | xxxii        |
| <b>7.2 XML Examples</b>                         | <b>xlvi</b>  |
| 7.2.1 Directive Message/Response                | xlvi         |
| 7.2.2 LoadConfig Message/Response               | i            |
| 7.2.3 GetConfigList Message / Response          | i            |
| 7.2.4 SetConfig Message/Response                | li           |
| 7.2.5 SaveConfig Message/Response               | liii         |
| 7.2.6 Various GetConfig Messages and a Response | liii         |
| <b>7.3 TCP/IP Message Structure</b>             | <b>iv</b>    |
| <b>8 PSM (ASCII)</b>                            | <b>lvi</b>   |
| <b>8.1 PIM to PSM Mapping</b>                   | <b>lvi</b>   |
| 8.1.1 Parameters                                | lvi          |
| 8.1.2 Reserved Words and Special Characters     | lviii        |
| 8.1.3 Message Header                            | lviii        |
| 8.1.4 Message Trailer                           | ix           |
| 8.1.5 ConnectMessage and Response               | ix           |
| 8.1.6 DisconnectMessage                         | lxi          |
| 8.1.7 GetConfigMessage and Response             | lxii         |
| 8.1.8 SetConfigMessage and Response             | lxiii        |
| 8.1.9 Save/LoadConfigMessage and Response       | lxiv         |
| 8.1.10 GetConfigListMessage and Response        | lxv          |
| 8.1.11 DirectiveMessage and Response            | lxvi         |
| <b>8.2 ASCII Examples</b>                       | <b>lxvii</b> |
| 8.2.1 ConnectMessage Example                    | lxvii        |
| 8.2.2 DisconnectMessage Example                 | lxviii       |
| 8.2.3 GetConfigMessage Example                  | lxviii       |
| 8.2.4 SetConfigMessage Example                  | lxviii       |

[8.2.5 SaveConfigMessage Example.....](#) [lxix](#)  
[8.2.6 LoadConfigMessage Example.....](#) [lxix](#)  
[8.2.7 DirectiveMessage Example.....](#) [lxx](#)  
**[8.3 TCP/IP Message Structure.....](#) [lxx](#)**



# Preface

## About the Object Management Group

### OMG

Founded in 1989, the Object Management Group, Inc. (OMG) is an open membership, not-for-profit computer industry standards consortium that produces and maintains computer industry specifications for interoperable, portable, and reusable enterprise applications in distributed, heterogeneous environments. Membership includes Information Technology vendors, end users, government agencies, and academia.

OMG member companies write, adopt, and maintain its specifications following a mature, open process. OMG's specifications implement the Model Driven Architecture® (MDA®), maximizing ROI through a full-lifecycle approach to enterprise integration that covers multiple operating systems, programming languages, middleware and networking infrastructures, and software development environments. OMG's specifications include: UML® (Unified Modeling Language™); CORBA® (Common Object Request Broker Architecture); CWM™ (Common Warehouse Metamodel); and industry-specific standards for dozens of vertical markets.

More information on the OMG is available at <http://www.omg.org/>.

### OMG Specifications

As noted, OMG specifications address middleware, modeling and vertical domain frameworks. A Specifications Catalog is available from the OMG website at:

[http://www.omg.org/technology/documents/spec\\_catalog.htm](http://www.omg.org/technology/documents/spec_catalog.htm)

Specifications within the Catalog are organized by the following categories:

#### OMG Modeling Specifications

UML

MOF

XMI

CWM

Profile specifications.

#### OMG Middleware Specifications

CORBA/IIOP

IDL/Language Mappings

Specialized CORBA specifications

CORBA Component Model (CCM).

## Platform Specific Model and Interface Specifications

CORBA services

CORBA facilities

OMG Domain specifications

OMG Embedded Intelligence specifications

OMG Security specifications.

All of OMG's formal specifications may be downloaded without charge from our website. (Products implementing OMG specifications are available from individual suppliers.) Copies of specifications, available in PostScript and PDF format, may be obtained from the Specifications Catalog cited above or by contacting the Object Management Group, Inc. at:

OMG Headquarters

140 Kendrick Street

Building A, Suite 300

Needham, MA 02494

USA

Tel: +1-781-444-0404

Fax: +1-781-444-0320

Email: [pubs@omg.org](mailto:pubs@omg.org)

Certain OMG specifications are also available as ISO standards. Please consult <http://www.iso.org>

## Typographical Conventions

The type styles shown below are used in this document to distinguish programming statements from ordinary English. However, these conventions are not used in tables or section headings where no distinction is necessary.

Times/Times New Roman - 10 pt.: Standard body text

**Helvetica/Arial - 10 pt. Bold:** OMG Interface Definition Language (OMG IDL) and syntax elements.

**Courier - 10 pt. Bold:** Programming language elements.

Helvetica/Arial - 10 pt: Exceptions

Terms that appear in *italics* are defined in the glossary. Italic text also represents the name of a document, specification, or other publication.

# Introduction

Communication with space vehicles often requires a sophisticated suite of ground equipment ranging from network devices to antennas. These devices work together to create an end-to-end signal-processing suite. For example, an antenna, frequency converter, demodulator, bit synchronizer, decryption device and frame synchronizer process a telemetry down-link signal before the end-user software receives the data. These devices must be configured to properly process the signal and provide status to user applications.

The GEMS specification defines a common messaging interface to do just this. The intent of GEMS is to define a lightweight, easy-to-use interface model suitable for control and status of nearly all types of devices within space related ground systems. In truth, these devices are not unique to space communications. Modern ground systems include many commercial devices such as networking devices and digital archive systems. While this specification focuses specifically on space applications, it is designed to apply to a broad range of devices.

To understand the GEMS design, it is useful to first look at it from a user's perspective. Typically, high-level software, such as a TT&C (Telemetry, Tracking & Commanding) application, controls the ground system equipment. The main purpose of these types of applications is controlling the space vehicle – a complicated task in its own right. The ground system enables communication between the TT&C applications and the space vehicle by performing low-level signal and data processing functions. While the ground system is a significant part of the signal processing capabilities, if operating properly it should be transparent to the user. Only initial configuration and basic status is needed. This should be simple and ideally use a standard model for all types of devices. That is where the GEMS model comes in. The GEMS model defines a simple, message-based interface suitable for controlling all types of devices using a variety of protocols and transport mechanisms. It allows system integrators to develop control and status applications that can easily interface with a wide range of device types.

From a vendor's perspective, a standard device control protocol should be relatively easy to implement and require limited resources. In addition, to ensure the widest possible range of integrations, the protocol should not require any specific third-party middleware implementation. Using GEMS, vendors achieve exactly this. The GEMS protocol is a lightweight protocol requiring only a TCP/IP connection. The Platform Independent Model (PIM) simply describes the messages and interactions necessary to configure and obtain status on a device. The Platform Specific Models (PSM) map the PIM to basic ASCII and XML messages. The ASCII PSM is intended for the most basic devices with limited processing capabilities. It is well suited for Serial (RS-232) and terminal style devices. The XML PSM incorporates the more sophisticated capabilities of XML such as XML Schemas and validation. While these capabilities require additional libraries, formatting and processing the messages is still quite simple.

The GEMS interface compliments other existing standards such as CCSDS SLE. The CCSDS SLE specification provides facility level interfaces but does not address the lower level device interfaces. It accomplishes this through a Service-Device mapping function. The GEMS specification enables a standard Service-Device mapping function to be created for a wide range of device types. The following figure depicts this interaction.

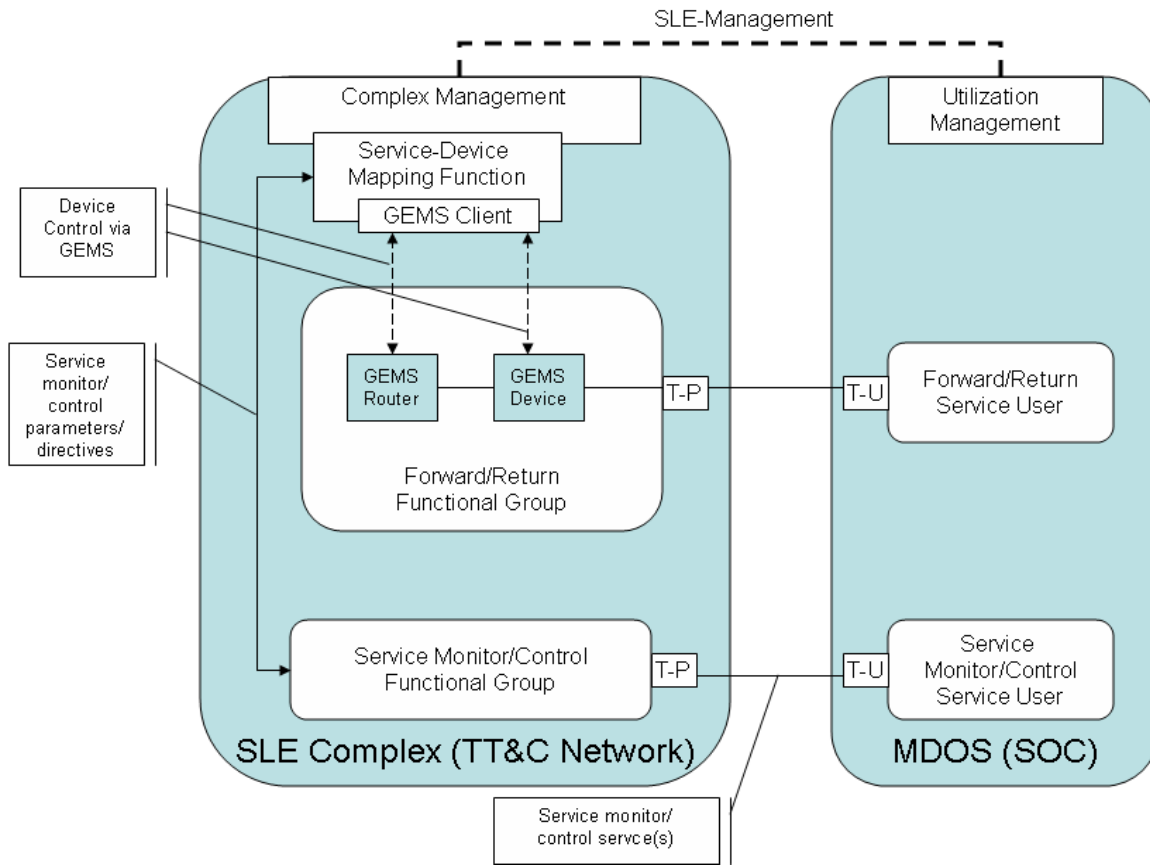

In this figure, the SLE Complex Management Service layers on top of the GEMS client to control the physical devices in the system.

# 1 Scope

The GEMS specification defines a lightweight standard for the control and status of typical ground equipment found in the space domain using a model driven approach. A conceptual model for the GEMS specification is shown below.

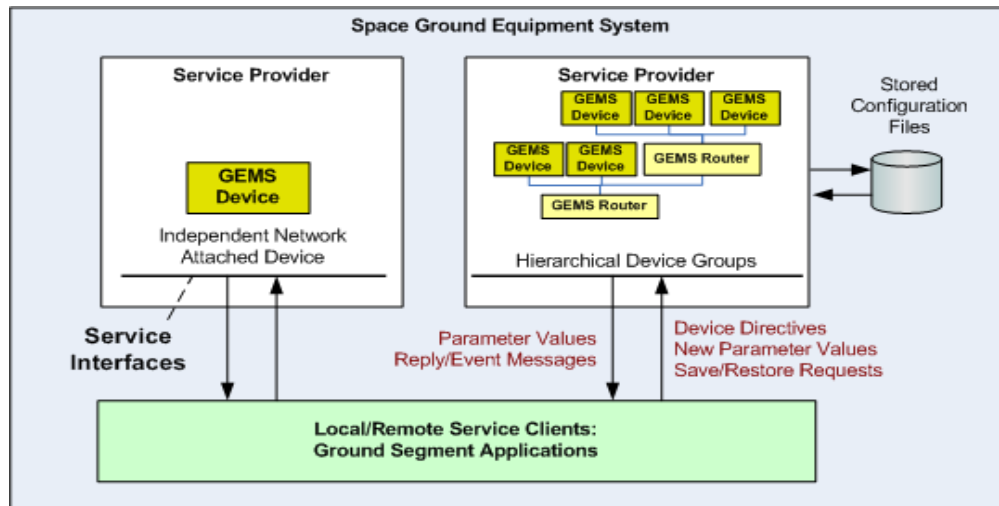

The GEMS specification is most commonly used for the control of a single device. However, in more complicated systems, multiple devices may be controlled using a single container message (MessageSequence) combined with a GEMS Proxy.

The GEMS PIM defines the message structure and behavior standard to all GEMS Devices. In the case of GEMS, the platform is defined as the middleware, network protocol or transport mechanism used to communicate with the device. By defining the platform at this level, the GEMS PIM focus primarily on the necessary message content and behavior and leaves the specifics of defining the message format and transporting that message to the PSMs.

Two GEMS PSM are defined. The raw GEMS-ASCII PSM is a terse ASCII-based protocol well suited for serial or terminal based devices. The focus of this PSM is short, human-readable messages that are easily formatted and processed. These messages are transported directly across either a network or serial bus. The GEMS-XML PSM utilizes the features of XML to provide message definition and validation. These messages use a HTML like header for transport across a network. Otherwise, GEMS-XML message leverage the structure inherent in an XML document to define the content.

Many other platform specific mappings of the GEMS PIM are possible. These potentially include other standard middleware or protocol definitions such as CORBA, SNMP or the GPIB-SCPI protocol. In fact, the large number of potential protocols used for device control further illustrates the need for the GEMS specification. By defining a specific mapping of each of these protocols to the GEMS PIM, automatic translation between these protocols is possible. This enables a device vendor to focus on the features and capabilities of the device without the need to support multiple protocols. Similarly, the device user can utilize a single protocol, with appropriate translators, to control numerous devices.

## 2 Conformance

The primary point of conformance is support of the PIM. Conformance to any defined PSM is optional, but if a defined platform is used, such as XML and raw ASCII, the implementation must conform to the appropriate PSM. In the event that a PSM does not exist for a specific protocol, implementers are encouraged to define a PSM and submit it for standardization to the OMG.

## 3 Normative References

**XML** Tim Bray, Jean Paoli, C.M. Sperberg-McQueen, and Eve Maler, editors. Extensible Markup Language (XML) 1.0 (Fourth Edition). World Wide Web Consortium, 2000. (See <http://www.w3.org/TR/2006/REC-xml-20060816>.)

**ASCII American National Standard for Information Systems – Coded Character Sets – 7 Bit American National Standard Code for Information Interchange (7-Bit ASCII)**, ANSI X3.4-1986, American National Standards Institute, Inc., March 26, 1986

## 4 Terms and Definitions

TT&C: Telemetry Tracking & Commanding

CCSDS: Consultative Committee for Space Data Systems

SLE: CCSDS Space Link Extensions

SNMP: Simple Network Management Protocol

GPIB: General Purpose Interface Bus

SCPI: General Command for Programmable Instrumentation

## 5 Acknowledgements

The specification was submitted by Real Time Logic Inc.

# 6 PIM

## 6.1 Overview

The GEMS specification defines a standard, platform independent model for controlling a wide range of devices. The GEMS model does not presume or try to define a specific system level architecture. Instead, it defines generic concepts such as devices, parameters and directives that are relatively simple to implement and provide system integrators common ways to control heterogeneous suites of space related ground equipment.

The central concept of GEMS is the GEMS device. GEMS devices have typed parameters, accept directives with typed arguments and can optionally save and restore their configuration using persistent storage. Users utilize the GEMS interface within the device to configure and obtain status.

For more sophisticated systems with multiple devices, a GEMS proxy is deployed and routes message traffic to a system of devices. This allows for several devices to be configured in a single transaction. In addition, the proxy often supports the Save/Restore functionality, thus keeping the GEMS devices simple.

The GEMS PIM consists of message related classes that allow the user to send directives, configure devices, obtain configuration information and device status, save the configuration and restore the configuration.

## 6.2 GEMS Use Cases

The following diagram depicts the GEMS use cases. These use cases define common interactions and activities associated with creating and using suites of devices.

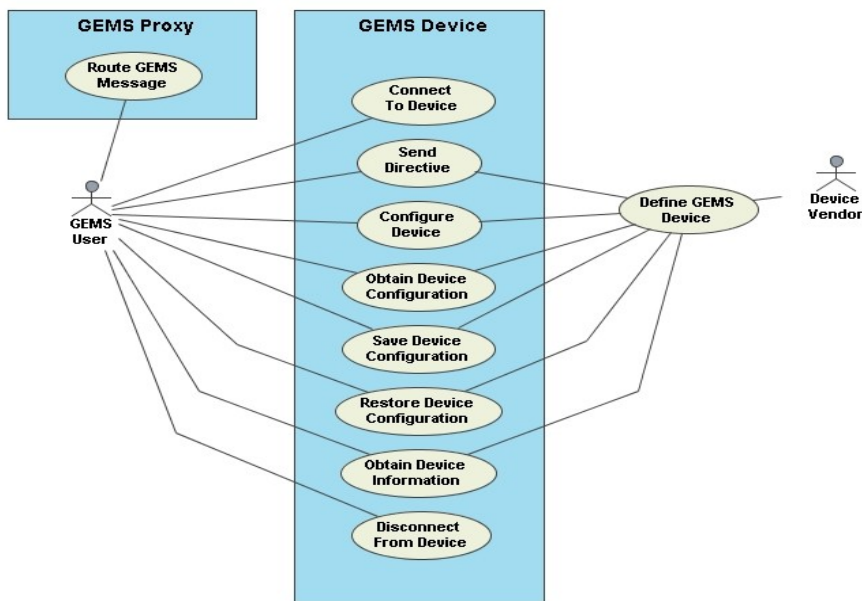

Figure 6.1 - GEMS Use Cases

### 6.2.1 GEMS User

This actor represents a user of a GEMS device or system. The GEMS user commonly takes the form of a controlling software application that uses the GEMS interface to manipulate a device or system of devices.

### 6.2.2 Device Vendor

As the name indicates, the *Device Vendor* is the manufacturer of the device supporting the GEMS interface. The *Device Vendor's* role is to define the parameters and directives supported by the device and provide those along with the device to the *System Integrator* and/or *GEMS User*.

### 6.2.3 Define GEMS Device

This use case represents the activities necessary to define a GEMS device. These include defining the names, types and ranges for all device parameters as well as the directives and associated arguments.

### 6.2.4 Connect To Device

The first action that a GEMS user must take to establish an interaction with a GEMS device is to connect to the device. In doing this, the GEMS user identifies whether control of the device or status only is requested. This is similar to requesting read/write access to a file. The GEMS device responds to a connection request by indicating whether or not the connection was successful and if successful, provides a token that the GEMS user will use in all future interactions with the device.

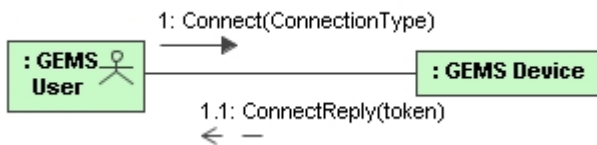

### 6.2.5 Send Directive

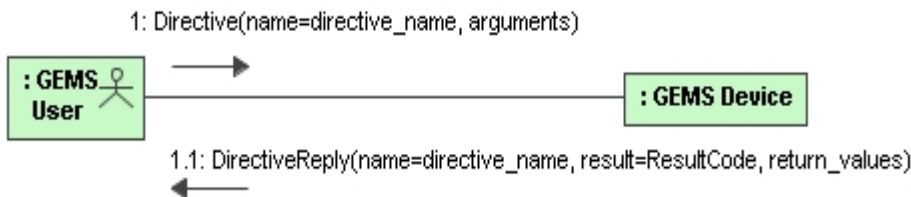

GEMS directives allow the user to manipulate the device or system in a scoped action. Common examples relating to ground system equipment are enabling modulation of a signal or sending a vehicle command. In this use case, the



user formats a GEMS directive message and sends it to the GEMS device. The GEMS device performs the actions necessary to fulfill the directive and then sends a reply message back to the user indicating the result of the directive. The response includes any return values appropriate for the directive.

### 6.2.6 Configure Device

A common use case is configuring a device. In this use case, the user sends a set of configuration parameters to the device. The device performs the appropriate validation of the parameters and then applies the values to its configuration. The GEMS device sends a response back to the user indicating success or failure. If successful, the response also includes the number of parameters affected.

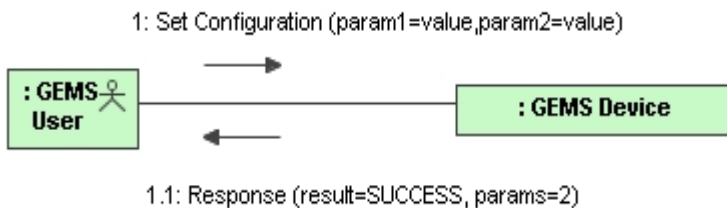

### 6.2.7 Obtain Configuration

In this use case, the user wishes to obtain information about the device configuration. The user sends a message to the GEMS device requesting configuration information. The request can specify specific parameters that the user wishes information on. The GEMS device receives the request and populates a reply with the appropriate parameters.

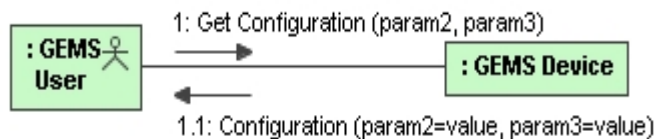

### 6.2.8 Save Configuration

A convenient use case in satellite operations is configuring the device for a specific space vehicle and then saving that configuration for later use. Often, configurations are saved for different missions. To accomplish this, the user sends a message requesting the GEMS device to save its configuration to local storage. The user specifies the name of the configuration for later recall.

This use case is optional since saving the configuration to persistent storage, such as a hard drive or Flash RAM, is not necessarily available on all types of devices. For these types of devices, it is expected that higher-level applications such as a GEMS router will provide this capability by first obtaining the device configuration and then writing it to persistent storage.

## 6.2.9 Restore Configuration

Once the user has saved a configuration to persistent storage, it can be recalled later. The user sends a restore configuration message to the GEMS device. The message includes the name of the configuration to restore. The GEMS device then loads that configuration and applies the values specified to the device. The response message indicates success or failure and the number of parameters modified.

It is not required for the named configuration to contain all device parameters. Only the parameters specified are modified. This enables a useful approach to controlling a device. GEMS users can load full configuration followed by selected subsets.

Like saving the configuration, this use case is optional for devices that do not have a persistent storage capability. In these cases, it is expected that higher-level software applications such as a GEMS router store the configurations and then apply those configurations to the device.

## 6.2.10 Obtain Device Information

In this use case, the user obtains information about what directives and parameters the GEMS device accepts. The user sends a message to the GEMS device requesting service information. The reply contains descriptions of the directives (including argument name and type information) and the parameters (including name, type and range information).

## 6.2.11 Proxy & Route GEMS Message

Typically, GEMS messages target a specific device. However, in more complex systems, it is convenient and sometimes required to manipulate multiple devices in a single transaction. In this case, multiple messages are combined into a message set and sent to a GEMS proxy for processing. The GEMS Proxy separates the messages and passes them to the designated targets sequentially.

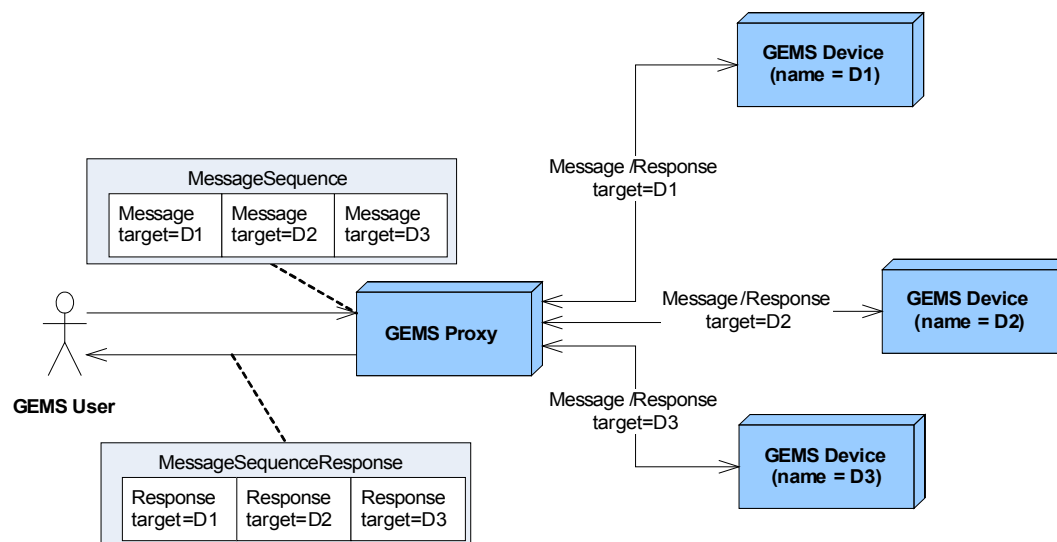

This capability is not required of GEMS devices, though it can be used to offer sequential execution of messages. A GEMS proxy can also provide functions such as Save/Restore and message logging. These functions are not required in a GEMS proxy.

A GEMS proxy is considered to be a device and can be the target of messages such as the SetConfigMessage and GetConfigMessage. The specifics of any proxy parameters, directives or other behavior is left to the implementor to define. At a minimum, in the event a GetConfigMessage is sent to a proxy, the resulting GetConfigResponse will contain at least one parameter named 'targets'. That parameter is a array of strings listing all of the targets handled by that specific proxy instance.

## 6.2.12 GEMS High Level Design

The GEMS protocol defines the basic message structure and interaction between a user and a GEMS device. It does not specify the exact parameters, types or ranges for any specific device or device type. That is beyond the scope of this specification. Instead, GEMS defines the approach to use when defining device specific parameters. The device vendor provides custom device information in a format compliant with the PIM and PSM used. To represent this interaction, GEMS defines two notional packages. These packages are not part of this specification. The *Custom Devices* package contains definitions of concrete devices. These devices meet the GEMS specification but are custom to a given vendor. The *Standard Devices* package contains definitions of standard devices, their parameters (names, types and ranges) and directives. It is envisioned that this package eventually becomes an addendum to this specification.

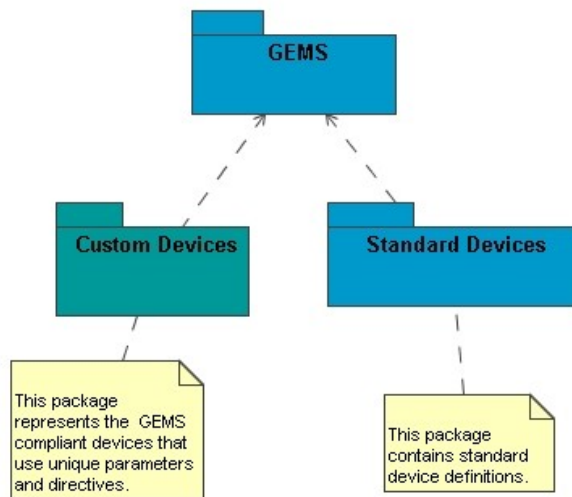

Figure 6.2 - GEMS Packages

Typically, the device vendor defines and maintains the associated GEMS device definitions. By supporting a GEMS interface, the device vendor enables customers to easily control the device in a standard manner following the GEMS model. However, there is no guarantee that the parameter names, types and ranges used will be interoperable with other similar devices produced by other vendors. For example, a common status parameter supported by receivers is *signal lock*. This parameter indicates when the receiver has locked on to the desired signal. One vendor might name that parameter LOCK\_STATE while another vendor might name it SIGNAL\_LOCK. To help standardize parameter choices a dictionary of device types and parameters will be developed.

## 6.3 GEMS UML Design

The following class diagram shows the GEMS classes and their relationships. At the top are the message classes. These classes define the various types of messages available through the GEMS protocol. Each message class, with the exception of the Disconnect class, has an associated response message. In several cases, the message contains one or more parameters.

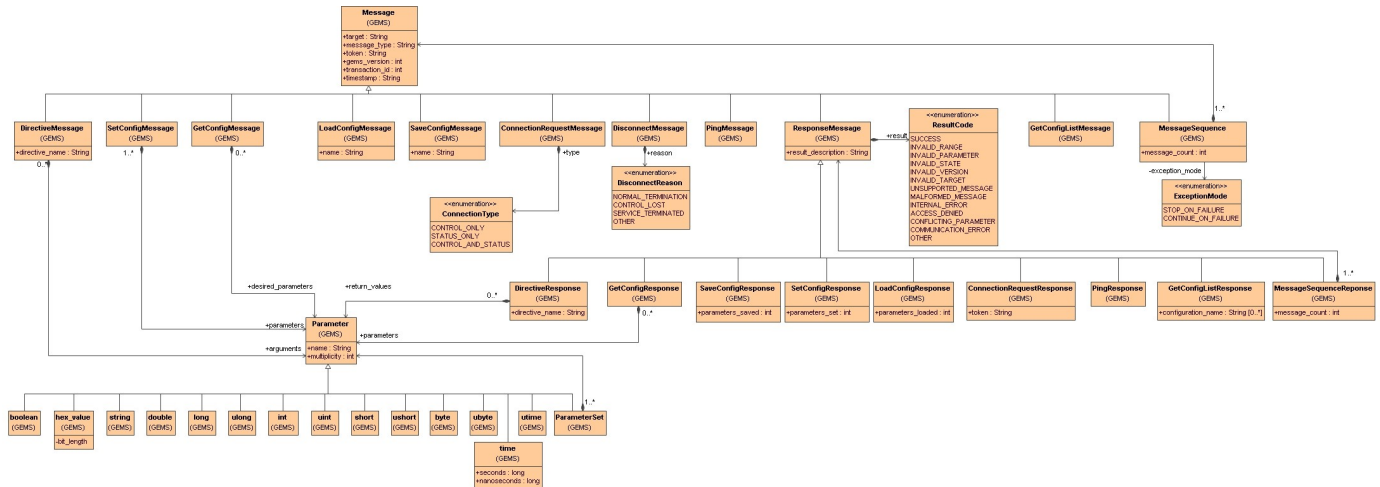

Figure 6.3 - GEMS UML

These classes are described in detail in the following sections.

### 6.3.1 Parameters

Parameters represent the actual values used to configure and provide status on a given device. Each Parameter has a name, type and a multiplicity. The name is a free text string and cannot contain any spaces. The multiplicity represents arrays of the same type. The specific implementation of the multiplicity is left to the PSM.

For completeness, the PIM defines both signed and unsigned types as well as a variety of integer sizes. If appropriate, these various integer types and precisions may be mapped to a single integer type within a PSM.

#### 6.3.1.1 UML Diagram

This diagram shows the base parameter class and all of the specific types.

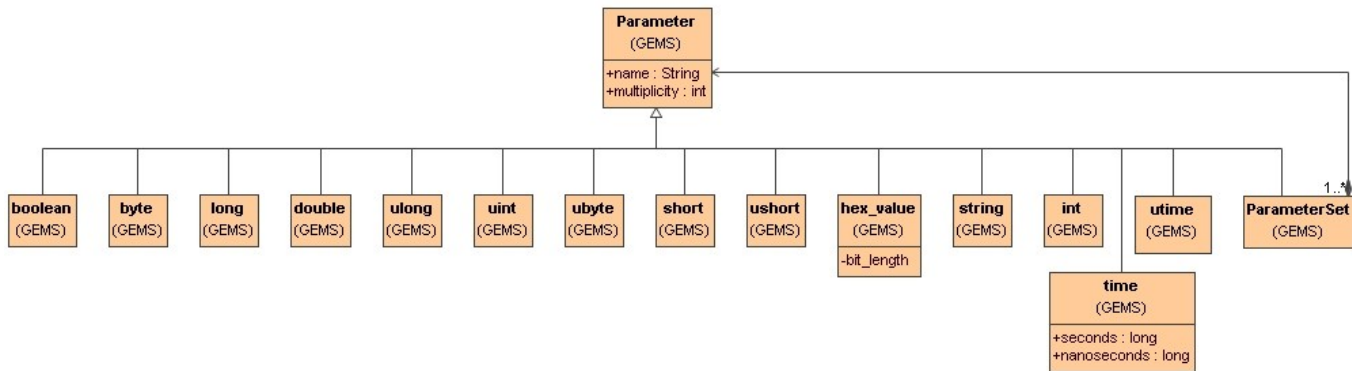

Figure 6.4 - GEMS Standard Types

#### 6.3.1.2 boolean

Represents a boolean true/false value.

#### 6.3.1.3 byte

Represents a single signed 8 bit byte or octet.

#### 6.3.1.4 ubyte

Represents a single unsigned 8 bit byte or octet.

#### 6.3.1.5 long

Represents a signed 8 byte value.

### **6.3.1.6 ulong**

Represents an unsigned 8 byte value.

### **6.3.1.7 int**

Represents a signed 4 byte value.

### **6.3.1.8 uint**

Represents an unsigned 4 byte value.

### **6.3.1.9 short**

Represents a signed 2 byte value.

### **6.3.1.10 ushort**

Represents an unsigned 2 byte value.

### **6.3.1.11 double**

Represents a double precision floating point number.

### **6.3.1.12 string**

Represents a free text ASCII string of characters.

### **6.3.1.13 hex\_value**

Represents an ASCII representation of a hexadecimal value. The string may optionally be preceded by a '0x'. In cases where the multiplicity is greater than one the bit\_length attribute of the hex\_values must all be equal.

### **6.3.1.14 time**

Represents the number of seconds and nanoseconds elapsed since midnight UTC of January 1, 1970. The time value is represented by integer values for seconds and nanoseconds.

### 6.3.1.15 utime

Represents a time value as Coordinated Universal Time (UTC). This format allows for the representation of leap seconds within a time parameter.

### 6.3.1.16 Parameter Sets

Parameter sets allow for the creation of mixed-type structures of parameters or “complex types” using the composite design pattern. The intent is to offer device vendors an option for creating arbitrarily complex data structures.

## 6.3.2 Messages

GEMS defines a set of messages that allow parameters and directives to be sent between a GEMS client and GEMS device. These messages all have a common header and structure. Each message sent to the GEMS device has a corresponding response.

The following diagram depicts the GEMS message class structure.

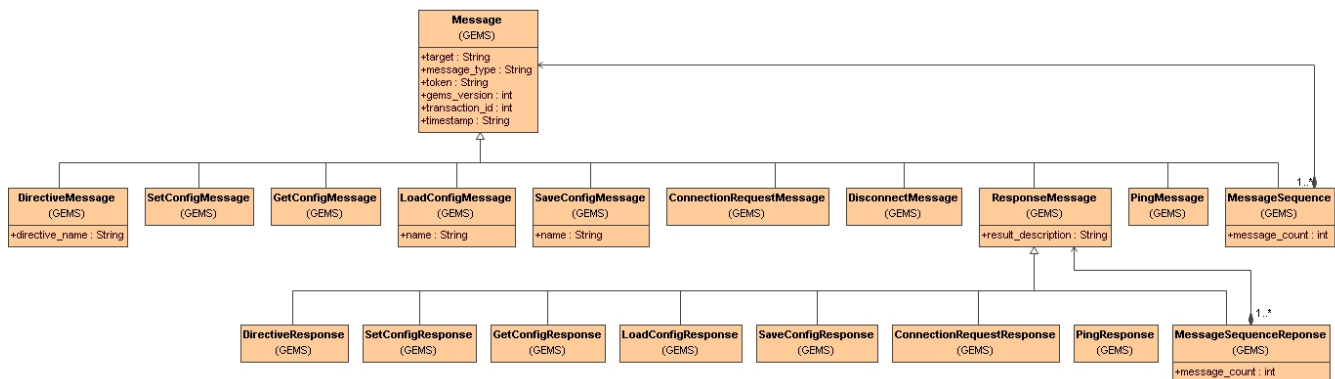

Figure 6.5 - GEMS Message Classes

### 6.3.2.1 Message Base Class

The Message base class defines the header information necessary to determine the target for the messages and other information such as the version number.



**Figure 6.6 - GEMS Message Base Class**

### **target**

The target is a free text field containing the name of the target device. For a single device, the target is a word naming the device. If the device is part of a system hierarchy, the levels within the hierarchy are concatenated using '/' characters similar to UNIX directory paths. This naming scheme allows GEMS proxies to properly route messages.

Example:

```
/SiteA/Modem/Modulator1
```

The target field is optional if the message is sent directly to the targeted device. For distributed systems that utilize a GEMS proxy, the proxy is responsible for mapping the target names to network addresses as necessary.

### **message\_type**

The message\_type field is an alpha-numeric field containing a message identifier for a specific message type. The specific values are defined in the PSM.

### **token**

The token field is a free-text field containing an ASCII token. The exact format and content of the token is dependent on the GEMS device. The GEMS device gives the token to the GEMS user as part of the initial connection. The token is then passed back to the GEMS device with every message.

While this specification does not define the use of the token field, it does offer recommendations. For example, if strict authentication is desired, a GEMS device can encode values in to the token that clearly identify the client and any privileges that client may have.

A common use of the message token is for limiting access to device control related features. When a client connect message is received, the message contains the type of access being requested (*e.g.* control or status). If there are currently no control clients connected, the GEMS device gives the control token to the new client. While this mechanism is not fool-proof, it does work well in controlled environments.

### **version**

The version field contains the version of GEMS message being used. It provides backwards compatibility. Currently only version 1 is supported.



## timestamp

The timestamp field provides useful debugging and message sorting information. The value in the field is the current time when the message is sent in UTC. The format of the field is defined in the PSM.

### 6.3.2.2 Response Messages

All GEMS response messages contain a result code and an optional free-text description. The result code indicates the success or failure of the original message. If a failure occurs, the specific result code can be inspected programmatically and the appropriate action taken. The acceptable result codes are as follows:

#### SUCCESS

This result code indicates that the associated message or directive was successful. The result\_description is optional.

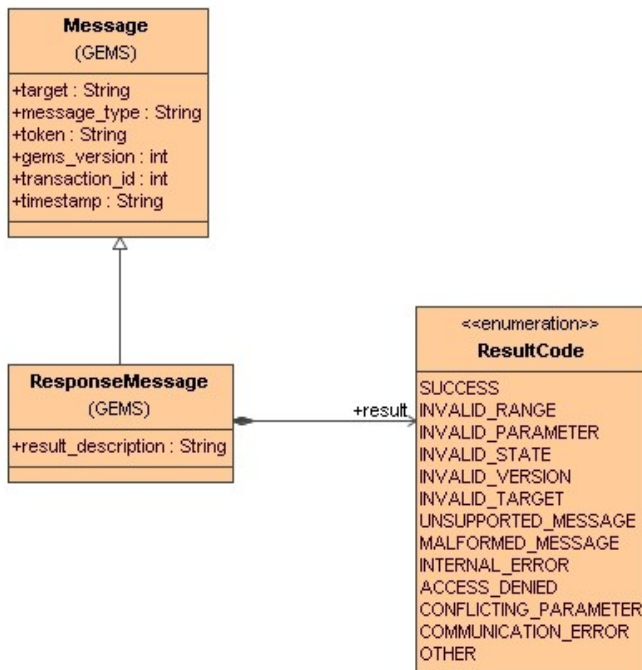

#### INVALID\_RANGE

This result code indicates that a parameter or argument within the associated message or directive was out of the acceptable range. In this error condition, the result\_description should contain a free-text description of which parameter was in error.

### **INVALID\_PARAMETER**

This result code indicates that an unsupported or unknown parameter was named in the associated message. In this error condition, the result\_description should contain a free-text description of which parameter was in error.

### **INVALID\_STATE**

This result code indicates that an invalid state was reached within the device or GEMS interface. Common reasons for this are attempts to set or get parameter values before a connection is established. In this error condition, the result\_description should contain a free-text description of the error.

### **INVALID\_VERSION**

This result code indicates that the GEMS message version was unrecognized or unsupported by the device. In this error condition, the result\_description should contain a list of the supported GEMS versions.

### **INVALID\_TARGET**

This result code indicates that the target was unrecognized. In this error condition, the result\_description should contain the provided (unrecognized) target.

### **UNSUPPORTED\_MESSAGE**

This result code indicates that the message type is not supported by the device. This applies to the optional save/restore messages. In this error condition, the result\_description should contain a free-text description of the error.

### **MALFORMED\_MESSAGE**

This result code indicates that the message was malformed or otherwise unrecognized. In this error condition, the reply message header should reflect as much of the original message as possible. The result description should contain the malformed message with any necessary modification such that the reply is properly formed.

### **INTERNAL\_ERROR**

This result code indicates that the device or proxy experienced an internal error while processing the original message. In this error condition, the result\_description should contain a free-text description of the error, if possible.

### **ACCESS\_DENIED**

This result code indicates that the GEMS user does not have appropriate access to invoke the action defined in the original message. This commonly is the result of a status-only client attempting to configuration the device using either a SetMessage or LoadConfigMessage. In this error condition, the result\_description should contain a free-text description of the error.

### **CONFLICTING\_PARAMETERS**

This result code indicates that the original message defined a set of parameters that conflicted with one another. For example, a device might have different ranges depending on the mode specified. In this error condition, the result\_description should identify the conflicting parameters.

## COMMUNICATION\_ERROR

This result code indicates that a communication error occurred. This commonly occurs as a result of network socket errors, serial bus errors or other transport mechanism errors. In this error condition, the result\_description should contain a description of the error, if possible.

## OTHER

This result code indicates that an error occurred not already defined in one of the other possible result codes. In this error condition, the result\_description should contain a description of the error. If necessary, other non-standard error codings may be used within the result\_description. However, it should be noted that these type of codings are not interoperable with other implementation and will be treated as free-text.

## 6.3.3 Controlling and Monitoring Devices

This section describes the process of controlling and monitoring GEMS devices.

### 6.3.3.1 Setting Configurations

To control a GEMS Device, the user sends a set of parameters. The parameters each have a name, type and value as described in Section 6.3.1. These parameters are applied in a transactional manner to the device. Validation checks are performed prior to changing the configuration of the device itself. If these checks fail (e.g., values out of range), the transaction is cancelled. A description of the error is sent back to the GEMS user in the response message. If all values validate, the new parameter settings are applied to the device.

The following diagram depicts this sequence.

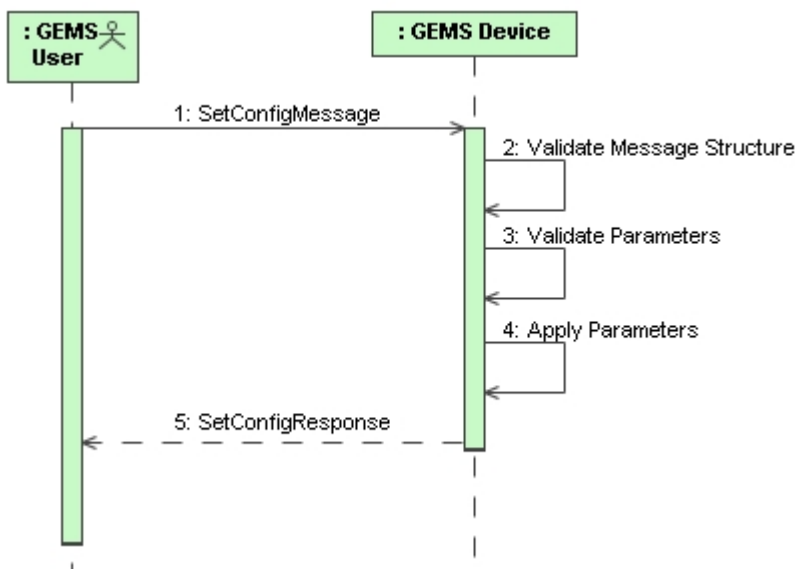

Figure 6.7 - Set Configuration Sequence

Errors found in steps 2 or 3 are immediately returned and no changes to the device configuration are made. In the event that an error occurs during step 4, the GEMS device attempts to return to the previous configuration if possible.

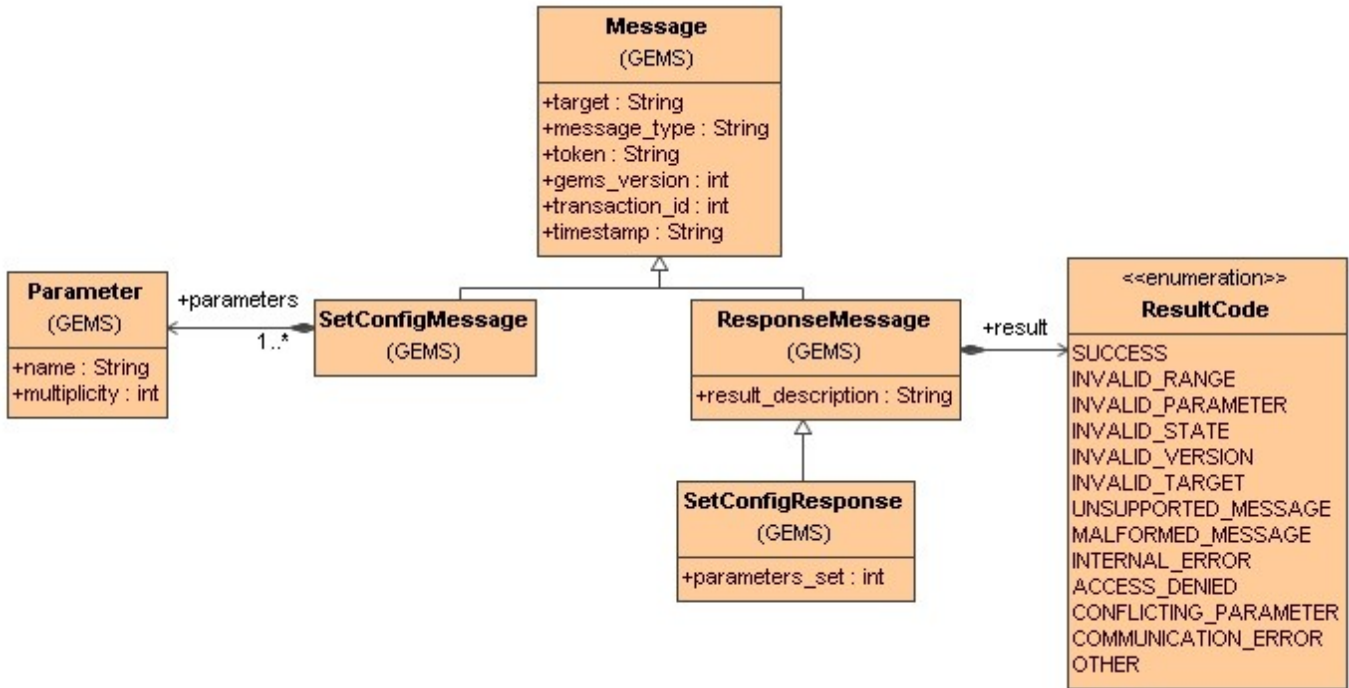

Figure 6.8 - Set Configuration Message Classes

### SetConfigMessage

The *SetConfigMessage* contains the list of parameters to set. These parameters are applied to the device as a single transaction.

### SetConfigResponse

The *SetConfigResponse* message indicates the result of the *SetConfigMessage*. This message has 2 parameters.

#### *parameters\_set*

The *parameters\_set* field indicates the number of parameters affected by the *SetConfigMessage*. This value provides the GEMS User feedback on the number of values actually modified. For example, a *SetConfigMessage* containing 20 parameter values might only change five parameters. From the perspective of the GEMS device, this is a valid request. However, the GEMS User might have expected to change 20 parameters.

### 6.3.3.2 Retrieving Configurations & Status

To obtain the current configuration of a device or monitor the runtime status of a device, the GEMS user sends a *GetConfigMessage*. The message can optionally contain the list of parameters desired. If specific parameters are specified, only those parameters are returned to the GEMS user. If no parameters are specified, then all device parameters are returned.

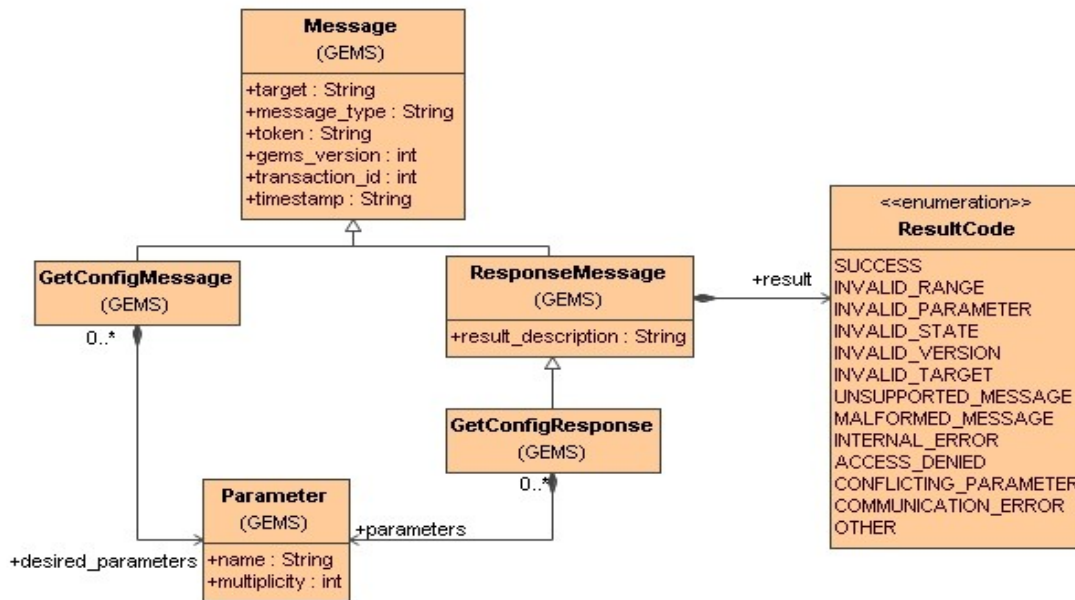

Figure 6.9 - GetConfigMessage UML

#### GetConfigMessage

The GetConfigMessage requests the current configuration from the GEMS device. The message can optionally contain a list of desired parameters.

#### GetConfigResponse

The GetConfigResponse message contains the device parameters requested.

### 6.3.3.3 Storing Configurations

To store a configuration, the GEMS User sends a SaveConfigMessage to the GEMS device. This message contains the desired name of the configuration. All device parameters are saved to this configuration. It is expected that multiple device configurations can be contained in a single named configuration. While, the format of the persisted configuration is at the vendor’s discretion, it is recommended that it use a standard PSM. For example, if ASCII files are used to store configuration information, an appropriate PSM such as XML should be used.

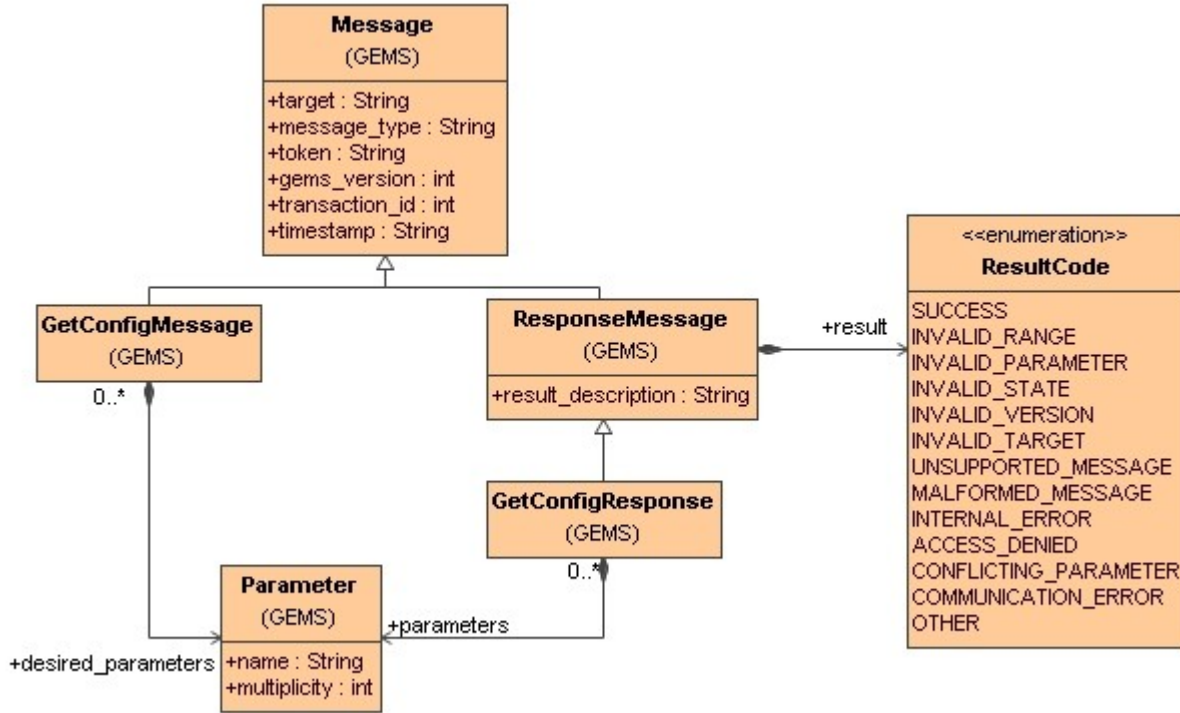

Figure 6.10 - Save Configuration UML

### SaveConfigMessage

The SaveConfigMessage contains the name of the configuration to save. The configuration name is a string containing a sequence of letters (A-Z) and/or numbers. Spaces are not allowed as they are not fully supported on all operating systems. The configuration name is case sensitive.

### SaveConfigResponse

The SaveConfigResponse contains the number of parameters saved if the save was successful. In the case of an error, the ResultCode indicates the type of error.

#### *parameters\_saved*

The *parameters\_saved* field indicates the number of parameters saved to the named configuration. This value provides the GEMS User feedback on the number of values actually saved. This value can be compared to a later restore configuration request as a means of ensuring expected behavior.

### 6.3.3.4 Restoring Configurations

To restore a named configuration to a GEMS device, the GEMS user sends a LoadConfigMessage. This message identifies the name of the configuration to load. The following diagram depicts the UML structure for these

messages.

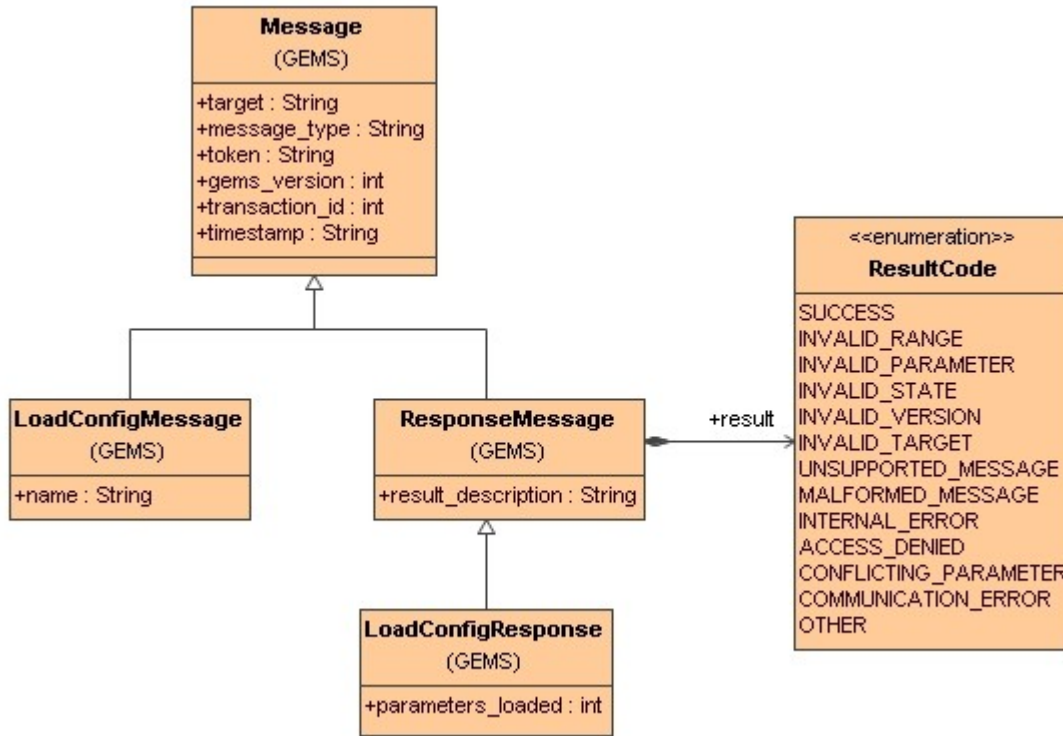

Figure 6.11 - Load Configuration UML

It is not required that the configuration contain a full set of parameter values.

### 6.3.3.5 LoadConfigMessage

The *LoadConfigMessage* identifies the name of the configuration to load.

### 6.3.3.6 LoadConfigResponse

The *LoadConfigResponse* contains the number of parameters loaded. If an error occurred, it also indicates whether or not the device was left in a valid state.

#### *parameters\_loaded*

The *parameters\_loaded* field indicates the number of parameters affected by the *LoadConfigMessage*. This value provides the GEMS User feedback on the number of values actually modified. For example, a configuration containing 20 parameter values might only change five parameters. From the perspective of the GEMS device, this is

a valid request. However, the GEMS User might have expected to change 20 parameters.

### 6.3.3.7 Retrieving Available Configurations

In order to restore a named configuration to a GEMS device, the GEMS user needs to be provided a mechanism for retrieving all the configurations available. This message identifies the list of configuration names available to load. The following diagram depicts the UML structure for these messages.

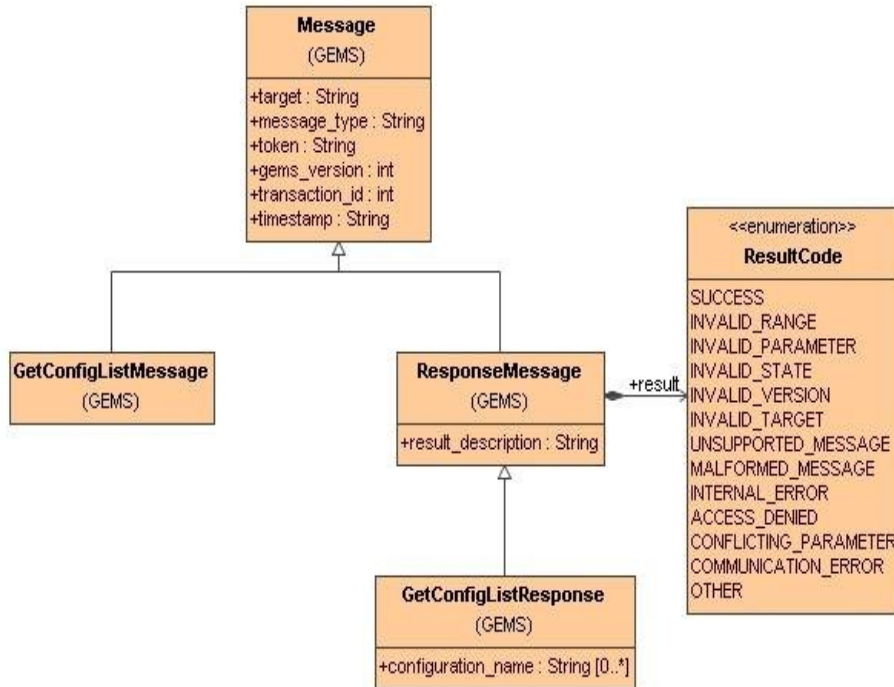

Figure 6.12 - Get Configuration List UML

#### GetConfigListMessage

The *GetConfigListMessage* does not contain any additional information above and beyond the base message class.

#### GetConfigListResponse

##### *configuration\_name*

The *configuration\_name* field contains all of the available configuration names for the GEMS device. The format of the names is dictated by the device developer.



## 6.4 Directives

Directives allow the GEMS user to invoke a scoped action on the GEMS device. These actions typically involve the purpose of the device rather than the configuration. For example, a device that formats space vehicle commands might have a *send\_vehicle\_command* directive. GEMS directives can have a list of parameters (or arguments) and can return values in the response.

The supported directives and associated arguments are defined by the vendor as part of the device definition. The format of this definition is based on the PSM used.

The following diagram shows the sequence of directive messages.

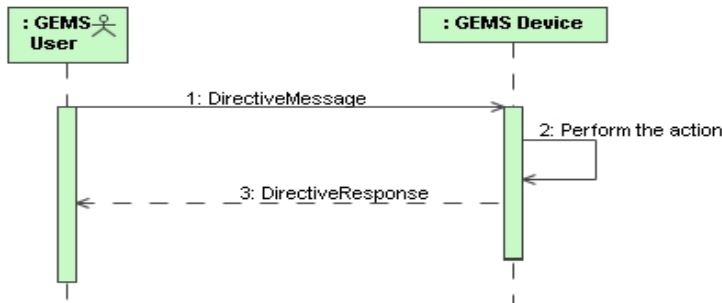

**Figure 6.12 - GEMS Directive Sequence**

The DirectiveMessage contains the name of the directive and the list of arguments. The response contains the name of the directive and a list of return values. If an error occurs, the ResultCode indicates the reason for the error.

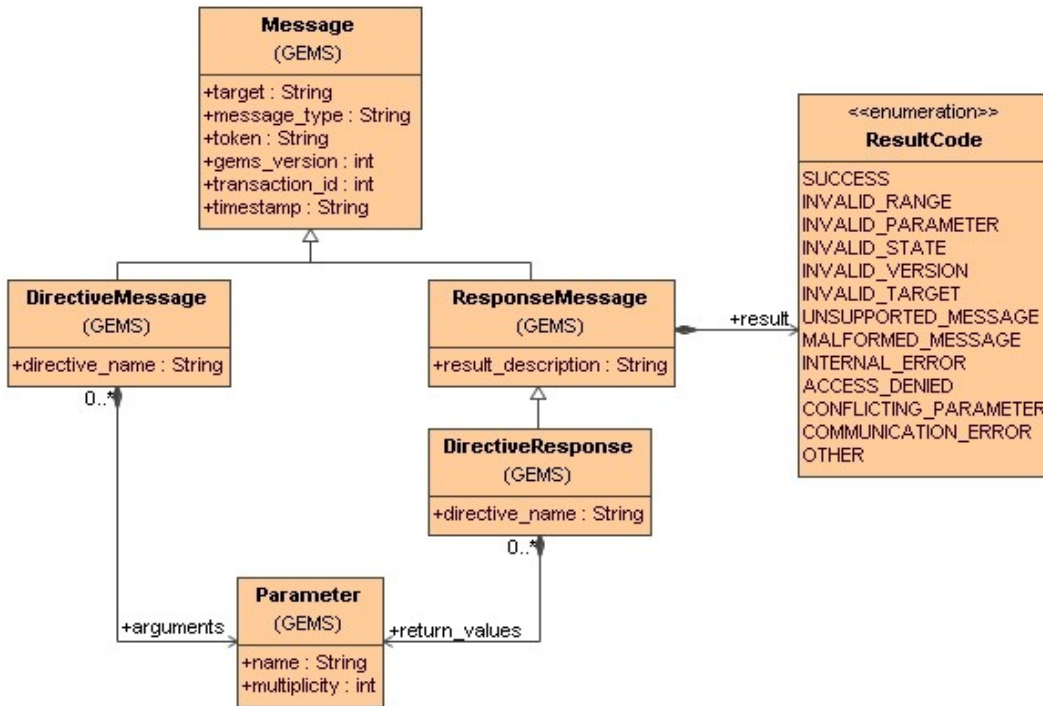

Figure 6.13 - Directive UML

### 6.4.1 DirectiveMessage

The DirectiveMessage contains the name of the directive and a list of arguments.

### 6.4.2 DirectiveResponse

The DirectiveResponse contains the name of the directive and a list of return values. The name is provided to allow the GEMS user to correlate the response with the original directive.

## 6.5 GEMS Security

The GEMS PIM defines only basic security concepts. GEMS Users connecting to a GEMS device are provided a token to use for all future interactions until a Disconnect message is sent or the connection is in some way broken (e.g. the socket is disconnected). In the basic GEMS model, the contents of the token is left undefined. Implementers of GEMS devices are encouraged to use the token to identify the client and the connection type. The encoding of this information varies between PSMs and between vendors.

Future addendums to this specification will address security policies, standard token encodings and access control.

## 6.6 GEMS Internationalization

At this time no consideration is provided for internationalization.

## 6.7 Standard Devices

In future revisions this section will contain industry standard device definitions. The intent of these definitions is to offer a degree of interoperability across device vendors. This allows GEMS users to swap GEMS devices of like types with minimal impact to application software.

# 7 PSM (XML)

XML (Extensible Markup Language) is a W3C initiative that allows information and services to be encoded with meaningful structure and semantics that computers and humans can understand. XML is great for information exchange, and can easily be extended to include user-specified and industry-specified tags.

The GEMS PSM mapping for XML leverages these capabilities to define and transfer GEMS messages. XML schemas provide a concise language for defining messages, device parameters and directives. These schemas also enable strict validation of the message contents all the way down to range values.

## 7.1 PIM To PSM Mapping

Most of the GEMS PIM TO PSM Mapping is captured in a single, standard XML schema file: GEMS\_base\_types.xsd. This file defines the message classes and parameters described in the PIM.

### 7.1.1 GEMS\_base\_types.xsd

The PIM to PSM mapping for GEMS is best described by working through the GEMS\_base\_types.xsd file itself. This file starts out with a standard XML header that defines the namespace and pulls in other standard XML schemas. These values are PSM specific and have no direct mapping to the GEMS PSM.

```
<?xml version="1.0" encoding="UTF-8"?>

<xsd:schema
  xmlns:xsd="http://www.w3.org/2001/XMLSchema"
  targetNamespace="http://www.omg.org/gems"
  xmlns:base="http://www.omg.org/gems"
  elementFormDefault="qualified"
  attributeFormDefault="unqualified">
```

### 7.1.1.1 Parameter Types

GEMS parameters map to specific complex types.

#### String Type

The mapping of the GEMS string type is defined in the following XML Schema.

```
<xsd:complexType name="StringParameter">
  <xsd:simpleContent>
    <xsd:extension base="xsd:string">
      <xsd:attribute name="ParameterType" fixed="string" type="xsd:string"/>
    </xsd:extension>
  </xsd:simpleContent>
</xsd:complexType>
```

#### Boolean Type

The mapping of the GEMS boolean type is defined in the following XML Schema.

```
<xsd:complexType name="BooleanParameter">
  <xsd:simpleContent>
    <xsd:extension base="xsd:boolean">
      <xsd:attribute name="ParameterType" fixed="boolean" type="xsd:string"/>
    </xsd:extension>
  </xsd:simpleContent>
</xsd:complexType>
```

#### Byte Type

The mapping of the GEMS byte type is defined in the following XML Schema.

```
<xsd:complexType name="ByteParameter">
  <xsd:simpleContent>
    <xsd:extension base="xsd:byte">
      <xsd:attribute name="ParameterType" fixed="byte" type="xsd:string"/>
    </xsd:extension>
  </xsd:simpleContent>
</xsd:complexType>
```

## Unsigned Byte Type

The mapping of the GEMS unsigned byte type is defined in the following XML Schema.

```
<xsd:complexType name="UnsignedByteParameter">
  <xsd:simpleContent>
    <xsd:extension base="xsd:unsignedByte">
      <xsd:attribute name="ParameterType" fixed="ubyte" type="xsd:string"/>
    </xsd:extension>
  </xsd:simpleContent>
</xsd:complexType>
```

## Hex Value

The mapping of the GEMS hex\_value type is defined in the following XML Schema.

```
<xsd:complexType name="HexParameter">
  <xsd:simpleContent>
    <xsd:extension base="xsd:hexBinary">
      <xsd:attribute name="ParameterType" fixed="hex" type="xsd:string"/>
      <xsd:attribute name="bit_length" type="xsd:int" use="required"/>
    </xsd:extension>
  </xsd:simpleContent>
</xsd:complexType>
```

## Double Type

The mapping of the GEMS double type is defined in the following XML Schema.

```
<xsd:complexType name="DoubleParameter">
  <xsd:simpleContent>
    <xsd:extension base="xsd:double">
      <xsd:attribute name="ParameterType" fixed="double" type="xsd:string"/>
    </xsd:extension>
  </xsd:simpleContent>
</xsd:complexType>
```

## Long Type

The mapping of the GEMS long type is defined in the following XML Schema.

```
<xsd:complexType name="LongParameter">
  <xsd:simpleContent>
    <xsd:extension base="xsd:long">
      <xsd:attribute name="ParameterType" fixed="long" type="xsd:string"/>
    </xsd:extension>
  </xsd:simpleContent>
</xsd:complexType>
```

### Unsigned Long Type

The mapping of the GEMS unsigned long type is defined in the following XML Schema.

```
<xsd:complexType name="UnsignedLongParameter">
  <xsd:simpleContent>
    <xsd:extension base="xsd:unsignedLong">
      <xsd:attribute name="ParameterType" fixed="ulong" type="xsd:string"/>
    </xsd:extension>
  </xsd:simpleContent>
</xsd:complexType>
```

### Integer Type

The mapping of the GEMS integer type is defined in the following XML Schema.

```
<xsd:complexType name="IntParameter">
  <xsd:simpleContent>
    <xsd:extension base="xsd:int">
      <xsd:attribute name="ParameterType" fixed="int" type="xsd:string"/>
    </xsd:extension>
  </xsd:simpleContent>
</xsd:complexType>
```

### Unsigned Integer Type

The mapping of the GEMS unsigned integer type is defined in the following XML Schema.

```
<xsd:complexType name="UnsignedIntParameter">
  <xsd:simpleContent>
    <xsd:extension base="xsd:unsignedInt">
      <xsd:attribute name="ParameterType" fixed="uint" type="xsd:string"/>
    </xsd:extension>
  </xsd:simpleContent>
</xsd:complexType>
```

```
        </xsd:extension>
    </xsd:simpleContent>
</xsd:complexType>
```

### Short Integer Type

The mapping of the GEMS short integer type is defined in the following XML Schema.

```
<xsd:complexType name="ShortParameter">
    <xsd:simpleContent>
        <xsd:extension base="xsd:short">
            <xsd:attribute name="ParameterType" fixed="short" type="xsd:string"/>
        </xsd:extension>
    </xsd:simpleContent>
</xsd:complexType>
```

### Unsigned Short Integer Type

The mapping of the GEMS unsigned short integer type is defined in the following XML Schema.

```
<xsd:complexType name="UnsignedShortParameter">
    <xsd:simpleContent>
        <xsd:extension base="xsd:unsignedShort">
            <xsd:attribute name="ParameterType" fixed="time" type="xsd:string"/>
        </xsd:extension>
    </xsd:simpleContent>
</xsd:complexType>
```

### Time Type

The mapping of the GEMS time type is defined in the following XML Schema.

```
<xsd:complexType name="TimeParameter">
    <xsd:simpleContent>
        <xsd:extension base="xsd:anySimpleType">
            <xsd:attribute name="ParameterType" fixed="time" type="xsd:string"/>
            <xsd:attribute name="seconds" type="xsd:int" use="required"/>
            <xsd:attribute name="nanoseconds" type="xsd:int" use="optional"/>
        </xsd:extension>
    </xsd:simpleContent>
```

```
</xsd:complexType>
```

## Utime Type

The mapping of the GEMS utime type is defined in the following XML Schema.

```
<xsd:complexType name="UtimeParameter">
  <xsd:simpleContent>
    <xsd:extension base="xsd:string">
      <xsd:attribute name="ParameterType" fixed="utime" type="xsd:string"/>
    </xsd:extension>
  </xsd:simpleContent>
</xsd:complexType>
```

The format of the UTC string is as follows:

yyyy-dayThh:mm:ss[.nnnnnnnnn]Z

where:      yyyy - four digits of year

          day – day of the year

          hh - hours (00 through 23)

          mm - minutes (00 through 59)

          ss[.nnnnnnnnn] – seconds.nanoseconds

          Z - the character "Z" denotes Greenwich Mean Time (GMT).

For example, "2009-273T09:14:50.02Z" represents 9:14:50.02 AM GMT on 30 September 2009. The fractional portion of the seconds in this example represents 20 milliseconds.

### 7.1.1.2 Parameters

GEMS Parameters are named values with a specific type. GEMS-XML maps this to a Parameter element that contains a single type element. The choice schema element constrains the parameter types to the available GEMS types.

```
<xsd:complexType name="Parameter">
  <xsd:sequence>
    <xsd:choice maxOccurs="unbounded" minOccurs="0">
      <xsd:element name="string" type="StringParameter"/>
      <xsd:element name="boolean" type="BooleanParameter"/>
      <xsd:element name="byte" type="ByteParameter"/>
      <xsd:element name="ubyte" type="UnsignedByteParameter"/>
    </xsd:choice>
  </xsd:sequence>
</xsd:complexType>
```



```

    <xsd:element name="hex_value" type="HexParameter"/>
    <xsd:element name="double" type="DoubleParameter"/>
    <xsd:element name="long" type="LongParameter"/>
    <xsd:element name="ulong" type="UnsignedLongParameter"/>
    <xsd:element name="int" type="IntParameter" />
    <xsd:element name="uint" type="UnsignedIntParameter" />
    <xsd:element name="short" type="ShortParameter" />
    <xsd:element name="ushort" type="UnsignedShortParameter" />
    <xsd:element name="time" type="TimeParameter" />
    <xsd:element name="utime" type="UtimeParameter" />
  </xsd:choice>
</xsd:sequence>
<xsd:attribute name="name" type="xsd:string" use="required"/>
<xsd:attribute name="type" type="xsd:string" use="optional"/>
<xsd:attribute name="multiplicity" type="xsd:int" default="1"/>
</xsd:complexType>

```

### 7.1.1.3 Parameter Sets

Parameter sets contain a heterogeneous grouping of parameters modeled after the Composite Design Pattern. The GEMS-XML mapping represents ParameterSets as a sequence of Parameters and/or ParameterSets.

```

<xsd:complexType name="ParameterSet">
  <xsd:sequence>
    <xsd:element name="Parameter" type="Parameter" minOccurs="0"
maxOccurs="unbounded"/>
    <xsd:element name="ParameterSet" type="ParameterSet" minOccurs="0"
maxOccurs="unbounded"/>
  </xsd:sequence>
  <xsd:attribute name="name" type="xsd:string" use="optional"/>
  <xsd:attribute name="type" type="xsd:string" use="optional"/>
  <xsd:attribute name="array" type="xsd:boolean" default="false"/>
</xsd:complexType>

```

#### 7.1.1.4 Message

The GEMS-XML mapping for the GEMS message class is shown in the XML schema below. The Message element contains attributes for the version, token, target, transaction\_id, and timestamp specified in UTC. The timestamp string format follows the format specified for the time type in the ASCII PSM which is “seconds.nanoseconds”. See Table 8.1.

```
<xsd:complexType name="MessageType">
  <xsd:attribute name="gems_version" type="xsd:int" use="required"/>
  <xsd:attribute name="token" type="xsd:string" use="optional"/>
  <xsd:attribute name="target" type="xsd:string" use="optional"/>
  <xsd:attribute name="transaction_id" type="xsd:long" use="optional"/>
  <xsd:attribute name="timestamp" type="xsd:string" use="optional"/>
</xsd:complexType>
```

#### 7.1.1.5 MessageSequence

The XML mapping for the GEMS MessageSequence is as follows:

```
<xsd:complexType name="MessageSequenceType">
  <xsd:complexContent>
    <xsd:restriction base="MessageType">
      <xsd:sequence>
        <xsd:element maxOccurs="unbounded" minOccurs="0" name="SetConfigMessage"
type="SetConfigMessageType"/>
        <xsd:element maxOccurs="unbounded" minOccurs="0" name="GetConfigMessage"
type="GetConfigMessageType"/>
        <xsd:element maxOccurs="unbounded" minOccurs="0" name="LoadConfigMessage"
type="LoadConfigMessageType"/>
        <xsd:element maxOccurs="unbounded" minOccurs="0" name="SaveConfigMessage"
type="SaveConfigMessageType"/>
        <xsd:element maxOccurs="unbounded" minOccurs="0" name="SetConfigResponse"
type="SetConfigResponseType"/>
        <xsd:element maxOccurs="unbounded" minOccurs="0" name="LoadConfigResponse"
type="LoadConfigResponseType"/>
        <xsd:element maxOccurs="unbounded" minOccurs="0" name="SaveConfigResponse"
type="SaveConfigResponseType"/>
      </xsd:sequence>
    </xsd:restriction>
  </xsd:complexContent>
```

```

</xsd:complexType>
<xsd:element name="MessageSequence" type="MessageSequenceType"/>

```

### 7.1.1.6 SetConfigMessage And GetConfigMessage

The XML mapping for GEMS uses the same schema definition for both SetConfigMessage and GetConfigMessage mappings.

```

<!-- Define a SetGetConfigMessageType -->
<xsd:complexType name="SetGetConfigMessageType">
  <xsd:complexContent>
    <xsd:restriction base="MessageType">
      <xsd:sequence>
        <xsd:element name="Parameter" type="Parameter" minOccurs="0"
maxOccurs="unbounded"/> <!-- 0 or more Parameters -->
        <xsd:element name="ParameterSet" type="ParameterSet" minOccurs="0"
maxOccurs="unbounded"/> <!-- 0 or more ParameterSets -->
      </xsd:sequence>
    </xsd:restriction>
  </xsd:complexContent>
</xsd:complexType>

<!-- Define a SetConfigMessage -->
<xsd:element name="SetConfigMessage" type="SetGetConfigMessageType"/>

<!-- Define a GetConfigMessage -->
<xsd:element name="GetConfigMessage" type="SetGetConfigMessageType"/>

```

### 7.1.1.7 LoadConfigMessage And SaveConfigMessage

The XML mapping for GEMS uses the same schema definition for both SetConfigMessage and GetConfigMessage mappings.

```

<!-- Define a LoadSaveConfigMessageType -->
<xsd:complexType name="LoadSaveConfigMessageType">
  <xsd:complexContent>

```

```

    <xsd:restriction base="MessageType">
      <xsd:sequence>
        <xsd:element name="name" type="StringParameter"/>
      </xsd:sequence>
    </xsd:restriction>
  </xsd:complexContent>
</xsd:complexType>

<!-- Define a LoadConfigMessage -->
<xsd:element name="LoadConfigMessage" type="LoadSaveConfigMessageType"/>

<!-- Define a SaveConfigMessage -->
<xsd:element name="SaveConfigMessage" type="LoadSaveConfigMessageType"/>

```

### 7.1.1.8 GetConfigListMessage

The XML mapping for a GEMS GetConfigListMessage is as follows:

```

<xsd:complexType name="GetConfigListMessageType">
  <xsd:complexContent>
    <xsd:extension base="MessageType">
    </xsd:extension>
  </xsd:complexContent>
</xsd:complexType>
<xsd:element name="GetConfigListMessage" type="GetConfigListMessageType"/>

```

### 7.1.1.9 ConnectionType

GEMS ConnectionType values are passed with the connection request and indicate the type of connection desired.

```

<xsd:simpleType name="ConnectionType">
  <xsd:restriction base="xsd:string">
    <xsd:enumeration value="CONTROL_ONLY"/>
    <xsd:enumeration value="STATUS_ONLY"/>
    <xsd:enumeration value="CONTROL_AND_STATUS"/>
  </xsd:restriction>

```

```
</xsd:simpleType>
```

#### 7.1.1.10 ConnectionRequestMessage

The XML mapping for the GEMS ConnectionRequestMessage is as follows:

```
<xsd:complexType name="ConnectionRequestMessageType">
  <xsd:complexContent>
    <xsd:extension base="MessageType">
      <xsd:sequence>
        <xsd:element maxOccurs="1" minOccurs="1" name="type"
type="ConnectionType"/>
      </xsd:sequence>
    </xsd:extension>
  </xsd:complexContent>
</xsd:complexType>

<xsd:element name="ConnectionRequestMessage" type="ConnectionRequestMessageType"/>
```

#### 7.1.1.11 DisconnectReason

GEMS DisconnectReason values are passed with the disconnect message and indicate the reason for disconnecting.

```
<xsd:simpleType name="DisconnectReason">
  <xsd:restriction base="xsd:string">
    <xsd:enumeration value="NORMAL_TERMINATION"/>
    <xsd:enumeration value="CONTROL_LOST"/>
    <xsd:enumeration value="SERVICE_TERMINATED"/>
    <xsd:enumeration value="OTHER"/>
  </xsd:restriction>
</xsd:simpleType>
```

#### 7.1.1.12 DisconnectMessage

The GEMS-XML mapping for the GEMS DisconnectMessage is as follows:

```
<xsd:complexType name="DisconnectMessageType">
  <xsd:complexContent>
    <xsd:extension base="MessageType">
```

```

        <xsd:sequence>
            <xsd:element maxOccurs="1" minOccurs="1" name="reason"
type="DisconnectReason"/>
        </xsd:sequence>
    </xsd:extension>
</xsd:complexContent>
</xsd:complexType>

<xsd:element name="DisconnectMessage" type="DisconnectMessageType"/>

```

### 7.1.1.13 ResultCode

The GEMS-XML mapping for the ResultCode utilizes an XML enumeration.

```

<xsd:simpleType name = "ResultCode">
    <xsd:restriction base = "xsd:string">
        <xsd:enumeration value = "SUCCESS"/>
        <xsd:enumeration value = "INVALID_RANGE"/>
        <xsd:enumeration value = "INVALID_PARAMETER"/>
        <xsd:enumeration value = "INVALID_STATE"/>
        <xsd:enumeration value = "INVALID_VERSION"/>
        <xsd:enumeration value = "INVALID_TARGET"/>
        <xsd:enumeration value = "CONFLICTING_PARAMETER"/>
        <xsd:enumeration value = "UNSUPPORTED_MESSAGE"/>
        <xsd:enumeration value = "MALFORMED_MESSAGE"/>
        <xsd:enumeration value = "COMMUNICATION_ERROR"/>
        <xsd:enumeration value = "INTERNAL_ERROR"/>
        <xsd:enumeration value = "ACCESS_DENIED"/>
        <xsd:enumeration value = "OTHER"/>
    </xsd:restriction>
</xsd:simpleType>

```

### 7.1.1.14 Response

The GEMS-XML mapping for the base ResponseMessage is as follows:

```

<xsd:complexType name="ResponseMessageType">
  <xsd:complexContent>
    <xsd:restriction base="MessageType">
      <xsd:sequence>
        <xsd:element minOccurs="1" maxOccurs="1" name="Result" type="ResultCode"/>
        <xsd:element minOccurs="0" maxOccurs="1" name="description"
type="xsd:string"/>
      </xsd:sequence>
    </xsd:restriction>
  </xsd:complexContent>
</xsd:complexType>

```

#### 7.1.1.15 LoadConfigResponse

The GEMS-XML mapping for the LoadConfigResponse is as follows:

```

<xsd:complexType name="LoadConfigResponseType">
  <xsd:complexContent>
    <xsd:extension base="ResponseMessageType">
      <xsd:sequence>
        <xsd:element maxOccurs="1" minOccurs="1" name="parameters_loaded"
type="xsd:int"/>
      </xsd:sequence>
    </xsd:extension>
  </xsd:complexContent>
</xsd:complexType>

<xsd:element name="LoadConfigResponse" type="LoadConfigResponseType"/>

```

#### 7.1.1.16 Save Config Response

The GEMS-XML mapping for the SaveConfigResponse message is as follows:

```

<xsd:complexType name="SaveConfigResponseType">
  <xsd:complexContent>
    <xsd:extension base="ResponseMessageType">
      <xsd:sequence>

```

```

                <xsd:element maxOccurs="1" minOccurs="1" name="parameters_saved"
type="xsd:int"/>
            </xsd:sequence>
        </xsd:extension>
    </xsd:complexContent>
</xsd:complexType>

<xsd:element name="SaveConfigResponse" type="SaveConfigResponseType"/>

```

### 7.1.1.17 Get Config List Response

The GEMS-XML mapping for the GetConfigListResponse message is as follows:

```

<xsd:complexType name="GetConfigListResponseType">
    <xsd:complexContent>
        <xsd:extension base="ResponseMessageType">
            <xsd:sequence>
                <xsd:element minOccurs="0" maxOccurs="unbounded" name="ConfigurationName"
type="xsd:string"/>
            </xsd:sequence>
        </xsd:extension>
    </xsd:complexContent>
</xsd:complexType>

<xsd:element name="GetConfigListResponse" type="GetConfigListResponseType"/>

```

### 7.1.1.18 SetConfigResponse

The GEMS-XML mapping for the SetConfigResponse message is as follows:

```

<xsd:complexType name="SetConfigResponseType">
    <xsd:complexContent>
        <xsd:extension base="ResponseMessageType">
            <xsd:sequence>
                <xsd:element maxOccurs="1" minOccurs="1" name="parameters_set"
type="xsd:int"/>
            </xsd:sequence>
        </xsd:extension>
    </xsd:complexContent>
</xsd:complexType>

```



```

        </xsd:extension>
    </xsd:complexContent>
</xsd:complexType>

<xsd:element name="SetConfigResponse" type="SetConfigResponseType"/>

```

### 7.1.1.19 GetConfigResponse

The GEMS-XML mapping for the GetConfigResponse message is as follows:

```

<!-- Define a GetConfigResponseType -->
<xsd:complexType name="GetConfigResponseType">
    <xsd:extension base="ResponseMessageType">
        <xsd:sequence>
            <xsd:element name="Parameter" type="Parameter" minOccurs="0"
maxOccurs="unbounded"/> <!-- 0 or more Parameters -->
            <xsd:element name="ParameterSet" type="ParameterSet" minOccurs="0"
maxOccurs="unbounded"/> <!-- 0 or more ParameterSet -->
        </xsd:sequence>
    </xsd:extension>
</xsd:complexType>

<!-- Define a GetConfigResponse -->
<xsd:element name="GetConfigResponse" type="GetConfigResponseType"/>

```

### 7.1.1.20 ConnectionRequestResponse

The GEMS-XML mapping for the ConnectionRequestResponse message is as follows:

```

<!-- Define a ConnectionRequestResponse -->
<xsd:complexType name="ConnectionRequestResponseType">
    <xsd:complexContent>
        <xsd:extension base="ResponseMessageType"/>
    </xsd:complexContent>
</xsd:complexType>

```

```
<xsd:element name="ConnectionRequestResponse" type="ConnectionRequestResponseType"/>
```

### 7.1.1.21 Directive Arguments

Directive arguments are represented in GEMS-XML as a sequence of Parameters.

```
<!--Define an ArgumentsType to be used by GEMS Directives -->
<xsd:complexType name="ArgumentsType">
  <xsd:sequence>
    <xsd:element maxOccurs="unbounded" minOccurs="0" name="Parameter"
type="Parameter"/>
  </xsd:sequence>
  <xsd:attribute name="directive_name" type="xsd:string" use="optional"/>
</xsd:complexType>
```

### 7.1.1.22 Directive Return Values

Directive return values are represented in GEMS-XML as a sequence of parameters.

```
<!--Define a ReturnValuesType to be used by GEMS Directive Responses -->
<xsd:complexType name="ReturnValuesType">
  <xsd:sequence>
    <xsd:element maxOccurs="unbounded" minOccurs="0" name="Parameter"
type="Parameter"/>
    <xsd:element maxOccurs="unbounded" minOccurs="0" name="ParameterSet"
type="ParameterSet"/>
  </xsd:sequence>
</xsd:complexType>
```

### 7.1.1.23 Directive Messages

The DirectiveMessage is the container for a directive. It is standard for all devices.

```
<!-- Define a DirectiveMessageType -->
<xsd:complexType name="DirectiveMessageType">
  <xsd:complexContent>
    <xsd:restriction base="MessageType">
      <xsd:sequence>
        <xsd:element minOccurs="1" maxOccurs="1" name="directive_name"
type="xsd:string"/>
      </xsd:sequence>
    </xsd:restriction>
  </xsd:complexContent>
</xsd:complexType>
```

```

                <xsd:element minOccurs="0" maxOccurs="1" name="arguments"
type="ArgumentsType"/>
            </xsd:sequence>
        </xsd:restriction>
    </xsd:complexContent>
</xsd:complexType>

<!-- Define a directive message -->
<xsd:element name="DirectiveMessage" type="DirectiveMessageType"/>

```

#### 7.1.1.24 Directive Response

The DirectiveResponse is the contain for a directive response. It is standard for all devices.

```

<!-- Define a DirectiveResponseType -->
<xsd:complexType name="DirectiveResponseType">
    <xsd:complexContent>
        <xsd:extension base="ResponseMessageType">
            <xsd:sequence>
                <xsd:element minOccurs="1" maxOccurs="1" name="directive_name"
type="xsd:string"/>
                <xsd:element minOccurs="0" maxOccurs="1" name="return_values"
type="ReturnValuesType"/>
            </xsd:sequence>
        </xsd:extension>
    </xsd:complexContent>
</xsd:complexType>

<!-- Define a directive response -->
<xsd:element name="DirectiveResponse" type="DirectiveResponseType"/>

```

#### 7.1.1.25 GEMS Scheme End

```

</xsd:schema>

```

## 7.2 XML Examples

This section contains example GEMS-XML messages.

### 7.2.1 Directive Message/Response

The following is an example of a directive message that activates a frame synchronizer. This particular directive does require one argument and returns one value.

#### 7.2.1.1 Directive Message Example

```
<DirectiveMessage
  xmlns="http://www.omg.org/gems"
  xmlns:xsi="http://www.w3.org/2001/XMLSchema-instance"
  xsi:schemaLocation="http://www.omg.org/gems GEMS_base_types.xsd"
  transaction_id="1234"
  token="CS12345"
  target="FrameSync1"
  gems_version="1">
  <directive_name>run</directive_name>
  <Parameter name="enable">
    <boolean>>true</boolean>
  </Parameter>
</DirectiveMessage>
```

#### 7.2.1.2 Directive Message Response Example

```
<DirectiveResponse
  xmlns="http://www.omg.org/gems"
  xmlns:xsi="http://www.w3.org/2001/XMLSchema-instance"
  xsi:schemaLocation="http://www.omg.org/gems GEMS_base_types.xsd"
  transaction_id="1234"
  token="CS12345"
  target="FrameSync1"
  gems_version="1">
  <Result>SUCCESS</Result>
  <directive_name>run</directive_name>
```

```
<Parameter name="enabled">
  <boolean>true</boolean>
</Parameter>
</DirectiveResponse>
```

## 7.2.2 LoadConfig Message/Response

The following is an example of a LoadConfigMessage

### 7.2.2.1 LoadConfigMessage Example

```
<LoadConfigMessage
  xmlns="http://www.omg.org/gems"
  xmlns:xsi="http://www.w3.org/2001/XMLSchema-instance"
  xsi:schemaLocation="http://www.omg.org/gems GEMS_base_types.xsd"
  transaction_id="1"
  token="CS12345"
  target="/SystemA/FrameSync1"
  gems_version="1">
  <name>configuration1.xml</name>
</LoadConfigMessage>
```

### 7.2.2.2 LoadConfigResponse Example

```
<LoadConfigResponse
  xmlns="http://www.omg.org/gems"
  xmlns:xsi="http://www.w3.org/2001/XMLSchema-instance"
  xsi:schemaLocation="http://www.omg.org/gems GEMS_base_types.xsd"
  transaction_id="1"
  token="CS12345"
  target="FrameSync1"
  gems_version="1">
  <Result>SUCCESS</Result>
  <parameters_loaded>10</parameters_loaded>
</LoadConfigResponse>
```

## 7.2.3 GetConfigList Message / Response

The following is an example of a GetConfigListMessage

### 7.2.3.1 GetConfigListMessage Example

```
<GetConfigListMessage
  xmlns="http://www.omg.org/gems"
  xmlns:xsi="http://www.w3.org/2001/XMLSchema-instance"
  xsi:schemaLocation="http://www.omg.org/gems GEMS_base_types.xsd"
  transaction_id="1234"
  token="CS12345"
  target="FrameSync1"
  gems_version="1"/>
```

### 7.2.3.2 GetConfigList Response Example

```
<GetConfigListResponse
  xmlns="http://www.omg.org/gems"
  xmlns:xsi="http://www.w3.org/2001/XMLSchema-instance"
  xsi:schemaLocation="http://www.omg.org/gems GEMS_base_types.xsd"
  transaction_id="1234"
  token="CS12345"
  target="FrameSync1"
  gems_version="1">
  <Result>SUCCESS</Result>
  <ConfigurationName>default.xml</ConfigurationName>
  <ConfigurationName>SpaceVehicle1.xml</ConfigurationName>
  <ConfigurationName>SpaceVehicle2.xml</ConfigurationName>
</GetConfigListResponse>
```

## 7.2.4 SetConfig Message/Response

The following is an example of a SetConfigMessage and its response. This example sends three parameters to be set. The last parameter provides an example of an array of values.

### 7.2.4.1 SetConfigMessage Example

```
<SetConfigMessage
  xmlns="http://www.omg.org/gems"
  xmlns:xsi="http://www.w3.org/2001/XMLSchema-instance"
  xsi:schemaLocation="http://www.omg.org/gems GEMS_base_types.xsd"
  transaction_id="2"
  token="CS12345"
  target="/SystemA/FrameSync1"
  gems_version="1">
  <Parameter name="frame_length_in_bits">
    <long>1024</long>
  </Parameter>
  <Parameter name="sync_pattern">
    <hex_value bit_length="22">faf320</hex_value>
  </Parameter>
  <Parameter name="telemetry_ports">
    <int>10001</int>
    <int>10002</int>
    <int>10003</int>
  </Parameter>
</SetConfigMessage>
```

### 7.2.4.2 SetConfigResponse Example

```
<SetConfigResponse
  xmlns="http://www.omg.org/gems"
  xmlns:xsi="http://www.w3.org/2001/XMLSchema-instance"
  xsi:schemaLocation="http://www.omg.org/gems GEMS_base_types.xsd"
  transaction_id="1"
  token="CS12345"
  target="/SystemA/FrameSync1"
  gems_version="1">
  <Result>SUCCESS</Result>
  <parameters_set>1</parameters_set>
```

```
</SetConfigResponse>
```

## 7.2.5 SaveConfig Message/Response

The following is an example of a SaveConfigMessage

### 7.2.5.1 SaveConfigMessage Example

```
<SaveConfigMessage
  xmlns="http://www.omg.org/gems"
  xmlns:xsi="http://www.w3.org/2001/XMLSchema-instance"
  xsi:schemaLocation="http://www.omg.org/gems GEMS_base_types.xsd"
  transaction_id="1"
  token="CS12345"
  target="FrameSync1"
  gems_version="1">
  <name>configuration1.xml</name>
</SaveConfigMessage>
```

### 7.2.5.2 SaveConfigResponse Example

```
<SaveConfigResponse
  xmlns="http://www.omg.org/gems"
  xmlns:xsi="http://www.w3.org/2001/XMLSchema-instance"
  xsi:schemaLocation="http://www.omg.org/gems GEMS_base_types.xsd"
  transaction_id="1"
  token="CS12345"
  target="/SystemA/FrameSync1"
  gems_version="1">
  <Result>SUCCESS</Result>
  <parameters_saved>10</parameters_saved>
</SaveConfigResponse>
```

## 7.2.6 Various GetConfig Messages and a Response

The following is an example of a GetConfigMessage requesting one parameter.

```
<GetConfigMessage
```



```
xmlns="http://www.omg.org/gems"
xmlns:xsi="http://www.w3.org/2001/XMLSchema-instance"
xsi:schemaLocation="http://www.omg.org/gems GEMS_base_types.xsd"
transaction_id="2"
token="CS12345"
target="FrameSync1"
gems_version="1">
  <Parameter name="frame_length_in_bits"/>
</GetConfigMessage>
```

GetConfigRequest with no parameters. This will return a GetConfigResponse with all available parameters and their values.

```
< GetConfigMessage
  xmlns="http://www.omg.org/gems"
  xmlns:xsi="http://www.w3.org/2001/XMLSchema-instance"
  xsi:schemaLocation="http://www.omg.org/gems GEMS_base_types.xsd"
  transaction_id="2"
  token="CS12345"
  target="FrameSync1"
  gems_version="1">
</GetConfigMessage>
```

### 7.2.6.1 GetConfigResponse Examples

GetConfigResponse for previous GetConfigMessage requesting the frame\_length\_in\_bits parameter.

```
< GetConfigResponse
  xmlns="http://www.omg.org/gems"
  xmlns:xsi="http://www.w3.org/2001/XMLSchema-instance"
  xsi:schemaLocation="http://www.omg.org/gems GEMS_base_types.xsd"
  transaction_id="2"
  token="CS12345"
  target="FrameSync1"
  gems_version="1">
  <Result>SUCCESS</Result>
```

```
<Parameter name="frame_length_in_bits">
  <long>2048</long>
</Parameter>
</GetConfigResponse>
```

GetConfigResponse for previous GetConfigMessage requesting all parameters. This example assumes that the device only has two parameters.

```
< GetConfigResponse
  xmlns="http://www.omg.org/gems"
  xmlns:xsi="http://www.w3.org/2001/XMLSchema-instance"
  xsi:schemaLocation="http://www.omg.org/gems GEMS_base_types.xsd"
  transaction_id="2"
  token="CS12345"
  target="FrameSync1"
  gems_version="1">
  <Result>SUCCESS</Result>
  <Parameter name="frame_length_in_bits">
    <long>2048</long>
  </Parameter>
  <Parameter name="sync_pattern">
    <hex_value bit_length="22">faf320</hex_value>
  </Parameter>
</GetConfigResponse>
```

## 7.3 TCP/IP Message Structure

Transfer of GEMS-XML messages across a network transport such as TCP/IP is done by simply writing the GEMS-XML message directly to the socket.

## 8 PSM (ASCII)

The ASCII PSM defines a simple ASCII message protocol usable across a variety of transport mechanisms, including networks, serial lines and internal data buses such as PCI. The message structure is human-readable and easy to process.

### 8.1 PIM to PSM Mapping

For the GEMS PIM TO PSM ASCII Mapping each supported message type is captured in a single table describing the message format. The message table defines the order of the fields within the message, the field tags placed within the message, and the field's original range of values (ROVs).

All messages consist of a standard message header, followed by data in a message body consisting of fields uniquely associated with each type of message. Each message is terminated using a standard message trailer and is constructed from ASCII character fields.

#### 8.1.1 Parameters

GEMS-ASCII parameters are represented within messages using a name, type, value triad as follows:

```
parameter_name:type=value
```

Multiplicity is represented using an array-like syntax common to many scripting languages. The values are specified using a comma separated list.

```
parameter_name[3]:type=value1,value2,value3
```

### 8.1.1.1 Parameter Types

The PSM ASCII Mapping supports all the parameter types defined by the GEMS PIM. The general format in ASCII for parameters is 'parameter\_name:parameter\_type=parameter\_value'. Following is a table of examples ASCII formats for all of the parameter types.

**Table 8.1 - Parameter Types and Formatting**

| Parameter Type | Example Format   | Comments  |
|----------------|--|---|
| string         | param:string=abc   |   |
| boolean        | param:bool=true  | 'true' and 'false' case insensitive   |
| byte           | param:byte=127   |   |
| ubyte          | param:ubyte=255  |   |
| hex_value      | param:hex_value=faf320/22<br>param:hex_value=0xfaf320/22 | Bit length attribute in parenthesis   |
| double         | param:double=10.12                                       |   |
| long           | param:long=-999999999                                    |   |
| ulong          | param:ulong=9999999999                                   |   |
| int            | param;int=-123   |   |
| uint           | param;uint=123   |   |
| short          | param:short=-12  |   |
| ushort         | param:ushort=12  |   |
| time           | param:time=111111111.222000000                           | Value is seconds.nanoseconds in UTC where nanoseconds are fractional.   |
| utime          | 2009-273T09:14:50.02Z                                    | yyyy-dayThh:mm:ss[.nnnnnnnnn]Z<br>yyyy - four digits of year<br>day - day of the year<br>hh - hours (00 through 23)<br>mm - minutes (00 through 59)<br>ss[.nnnnnnnnn] - seconds.nanoseconds<br>Z - the character "Z" denotes Greenwich Mean Time (GMT). |

### 8.1.1.2 Parameter Sets

In the PSM ASCII Mapping parameter sets may be defined by the additional use of colons. For example an array of integers would be represented as follows:

param:int[3]:int=1,int=2,int=3

Mixed parameter sets follow the same model:

mixed\_param\_set:set\_type=param\_1:int=1,param\_2:boolean=true,param\_3:string=a short string,

### 8.1.2 Reserved Words and Special Characters

The following words are reserved and should not be used as parameter or target names:

“|GEMS” and “|END|”

The following characters are special but can be escaped using the following escape sequences:

| Character | Escape Sequence |
|-----------|-----------------|
| &         | &a              |
|           | &b              |
| ,         | &c              |
| ;         | &s              |

These escape sequences were chosen for the ASCII PSM to allow for simple parsing. Notionally, implementations first tokenize on a vertical bar '|' character. Then, for messages containing parameters, split the parameter fields on the first equal sign '='. Escaped characters should only show up to the right of the equal sign in string parameters.

### 8.1.3 Message Header

The message header maps directly to the GEMS base message class. The first three fields are fixed length to simplify processing. After that, all fields are variable length and use the pipe symbol, |, as a delimiter.

The following diagram shows the message header and footer.

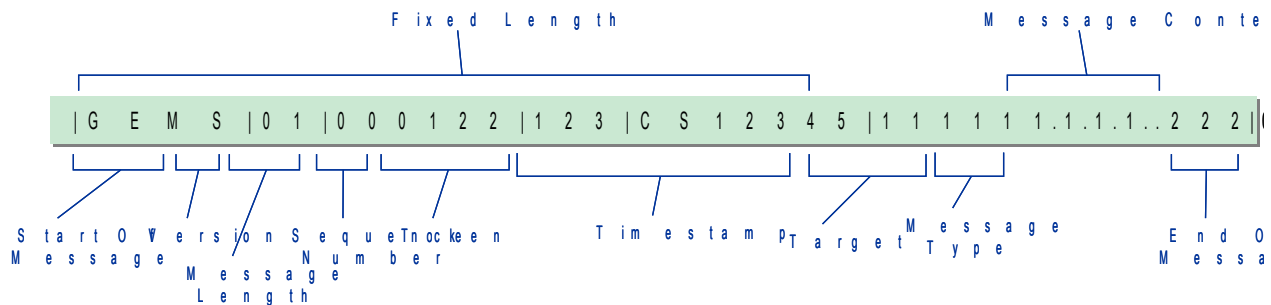

The following table defines each field, the expected field length and the range of values.

**Table 8.2 - Standard Request Message Fields**

| Field Names      | Length (char) | Range of Values    | Comments  |
|------------------|---------------|--------------------|---|
| Field Delimiter  | 1             |                    | Pipe character (ASCII 124)  |
| Start of Message | 4             | GEMS               | Invariant   |
| Field Delimiter  | 1             |                    | Pipe character (ASCII 124)  |
| GEMS Version     | 2             | 01 – 99            | Message Format Version  |
| Field Delimiter  | 1             |                    | Pipe character (ASCII 124)  |
| Message Length   | 6             | 000074 – 999999    | Total Length of the message (in bytes), including the start of message, standard header, message body and the end of message                            |
| Field Delimiter  | 1             |                    | Pipe character (ASCII 124)  |
| Transaction ID   | Variable      | 0-999,999,999      | Client specified transaction ID. The reply will reflect this number back to the client for message correlation.   |
| Field Delimiter  | 1             |                    | Pipe character (ASCII 124)  |
| Token            | Variable      | Alphanumeric       | Token provided by the device or proxy in the connect response.  |
| Field Delimiter  | 1             |                    | Pipe character (ASCII 124)  |
| Timestamp        | 19            | 11111111.222000000 | Timestamp of when the message was sent in UTC. Uses the format of the time parameter specified in: Table 8.1  |
| Field Delimiter  | 1             |                    | Pipe character (ASCII 124)  |
| Target           | Variable      | Alphanumeric       | The target field identifies the target of the message for the initial request and the source of the message for the reply.                              |
| Field Delimiter  | 1             |                    | Pipe character (ASCII 124)  |
| Message Type     | Variable      | Alphanumeric       | The Message Type identifies the type of message being sent. These types map directly to the PIM message types and are listed in the following sections. |
| Field Delimiter  | 1             |                    | Pipe character (ASCII 124)  |
| Message Body     | Variable      | Alphanumeric       | Specific to each supported message type. See following sections for definitions and examples.   |
| Field Delimiter  | 1             |                    | Pipe character (ASCII 124)  |
| End of Message   | 3             | END                | Invariant   |

The message header for a response contains the same first 7 fields as the message plus an additional 2 fields providing result codes and descriptions.

**Table 8.3 - Response Message Fields**

| Field Names        | Length (char) | Range of Values | Comments   |
|--------------------|---------------|-----------------|--|
| Standard Header    | Variable      | <See Table 8.2> |  |
| Field Delimiter    | 1             |                 | Pipe character (ASCII 124)   |
| Result Code        | Variable      | Alphanumeric    | One of the following GEMS PIM result codes:<br>SUCCESS<br>INVALID_RANGE<br>INVALID_PARAMETER<br>INVALID_TARGET<br>INVALID_VERSION<br>INVALID_STATE<br>CONFLICTING_PARAMETER<br>UNSUPPORTED_MESSAGE<br>MALFORMED_MESSAGE<br>COMMUNICATION_ERROR<br>INTERNAL_ERROR<br>ACCESS_DENIED<br>OTHER |
| Field Delimiter    | 1             |                 | Pipe character (ASCII 124)   |
| Result Description | Variable      | Alphanumeric    | Free text device specific description of the corresponding result code   |

### 8.1.4 Message Trailer

The message trailer ends all request and response messages and is represented as follows:

**Table 8.4 - Message Trailer Fields**

| Field Names     | Length (char) | Range of Values | Comments                   |
|-----------------|---------------|-----------------|----------------------------|
| Field Delimiter | 1             |                 | Pipe character (ASCII 124) |
| End of Message  | 3             | END             | Invariant                  |

### 8.1.5 ConnectMessage and Response

The following table describes the ConnectMessage body and response format.

### 8.1.5.1 ConnectMessage

Table 8.5 - Connect Request Message

| Field Names      | Length (char) | Range of Values | Comments   |
|------------------|---------------|-----------------|--|
| Standard Header  | Variable      | <See Table 8.2> | Message Type Field = CON   |
| Field Delimiter  | 1             |                 | Pipe character (ASCII 124)   |
| Connection Type  | Variable      | Alphanumeric    | Supported Values:<br>CONTROL_ONLY<br>CONTROL_AND_STATUS<br>STATUS_ONLY |
| Field Delimiter  | 1             |                 | Pipe character (ASCII 124)   |
| Standard Trailer | 3             | <See Table 8.4> |  |

### 8.1.5.2 ConnectMessage Response

The ConnectMessage Response nothing more than the standard response header and trailer with the message type set to CON-R. See Sections 8.1.3 and 8.1.4.

### 8.1.6 DisconnectMessage

The following table describes the DisconnectMessage body. There is no corresponding response message.

Table 8.6 - Disconnect Message Request

| Field Names       | Length (char) | Range of Values | Comments   |
|-------------------|---------------|-----------------|--|
| Standard Header   | Variable      | <See Table 8.2> | Message Type Field = DISC  |
| Field Delimiter   | 1             |                 | Pipe character (ASCII 124)   |
| Disconnect Reason | Variable      | Alphanumeric    | Supported Values:<br>NORMAL_TERMINATION<br>CONTROL_LOST<br>SERVICE_TERMINATED<br>OTHER |
| Field Delimiter   | 1             |                 | Pipe character (ASCII 124)   |
| Standard Trailer  | 3             | <See Table 8.4> |  |



## 8.1.7 GetConfigMessage and Response

The following tables describe the message body for the GetConfigMessage and it's corresponding response.

### 8.1.7.1 GetConfigMessage

**Table 8.7 - Get Configuration Request Message**

| Field Names          | Length (char) | Range of Values | Comments   |
|----------------------|---------------|-----------------|--|
| Standard Header      | Variable      | <See Table 8.2> | Message Type Field = GET   |
| Field Delimiter      | 1             |                 | Pipe character (ASCII 124)   |
| Number of Parameters | Variable      | Numeric         | Number of parameters requested. A blank entry indicates the client desires all parameters available.       |
| Field Delimiter      | 1             |                 | Pipe character (ASCII 124)   |
| Parameter Name 1     | Variable      | Alphanumeric    | Name of first parameter value requested.<br>Only required if Number of Parameters field is greater than 0. |
| Field Delimiter      | 1             |                 | Pipe character (ASCII 124)   |
| ...                  |               |                 |  |
| Parameter Name n     | Variable      | Alphanumeric    | Name of nth parameter requested.<br>Only required if Number of Parameters field is greater than n -1.      |
| Field Delimiter      | 1             |                 | Pipe character (ASCII 124)   |
| Standard Trailer     | 3             | <See Table 8.4> |  |

### 8.1.7.2 GetConfigMessage Response

**Table 8.8 - Get Configuration Response Message**

| Field Names              | Length (char) | Range of Values | Comments                   |
|--------------------------|---------------|-----------------|----------------------------|
| Standard Response Header | Variable      | <See Table 8.2> | Message Type = GET-R       |
| Field Delimiter          | 1             |                 | Pipe character (ASCII 124) |

| Field Names                   | Length (char) | Range of Values | Comments                            |
|-------------------------------|---------------|-----------------|-------------------------------------|
| Number of Parameters Returned | Variable      | Numeric         | Number of parameters returned.      |
| Field Delimiter               | 1             |                 | Pipe character (ASCII 124)          |
| Parameter Value 1             | Variable      | <See Table 8.1> | Value of first parameter requested. |
| Field Delimiter               | 1             |                 | Pipe character (ASCII 124)          |
| ...                           |               |                 |                                     |
| Parameter Value n             | Variable      | <See Table 8.1> | Value of nth parameter requested.   |
| Field Delimiter               | 1             |                 | Pipe character (ASCII 124)          |
| Standard Trailer              | 3             | <See Table 8.4> |                                     |

## 8.1.8 SetConfigMessage and Response

The following tables describe message body for the SetConfigMessage and its corresponding response.

### 8.1.8.1 SetConfigMessage

**Table 8.9 - Set Configuration Request Message**

| Field Names          | Length (char) | Range of Values | Comments                       |
|----------------------|---------------|-----------------|--------------------------------|
| Standard Header      | Variable      | <See Table 8.2> | Message Type Field = SET       |
| Field Delimiter      | 1             |                 | Pipe character (ASCII 124)     |
| Number of Parameters | Variable      | Numeric ( > 0 ) | Number of parameters modified. |
| Field Delimiter      | 1             |                 | Pipe character (ASCII 124)     |
| Parameter Value 1    | Variable      | <See Table 8.1> | Value of first parameter.      |
| Field Delimiter      | 1             |                 | Pipe character (ASCII 124)     |
| ...                  |               |                 |                                |
| Parameter Value n    | Variable      | <See Table 8.1> | Value of nth parameter.        |
| Field Delimiter      | 1             |                 | Pipe character (ASCII 124)     |
| Standard Trailer     | 3             | <See Table 8.4> |                                |

### 8.1.8.2 SetConfigMessage Response

**Table 8.10 - Set Configuration Response Message**

| Field Names                           | Length (char) | Range of Values  | Comments                          |
|---------------------------------------|---------------|------------------|-----------------------------------|
| Standard Response Header              | Variable      | <See Table 8.2>  | Message Type = SET-R              |
| Field Delimiter                       | 1             |                  | Pipe character (ASCII 124)        |
| Number of Parameters Successfully Set | Variable      | Numeric ( >= 0 ) | Number of parameters returned.    |
| Field Delimiter                       | 1             |                  | Pipe character (ASCII 124)        |
| Valid State                           | Variable      | TRUE or FALSE    | Whether or not the set succeeded. |
| Field Delimiter                       | 1             |                  | Pipe character (ASCII 124)        |
| Standard Trailer                      | 3             | <See Table 8.4>  |                                   |

### 8.1.9 Save/LoadConfigMessage and Response

The following tables describe the message body and response for both the Save and LoadConfigMessages.

#### 8.1.9.1 Save and LoadConfigMessage

| Field Names      | Length (char) | Range of Values                  | Comments  |
|------------------|---------------|----------------------------------|---|
| Standard Header  | Variable      | <See Table 8.2>                  | Message Type Field = SAVE or LOAD                     |
| Field Delimiter  | 1             |                                  | Pipe character (ASCII 124)                            |
| File Name        | Variable      | Standard File Naming Conventions | Name of file configuration is saved to or loaded from |
| Field Delimiter  | 1             |                                  | Pipe character (ASCII 124)                            |
| Standard Trailer | 3             | <See Table 8.4>                  |   |

#### 8.1.9.2 Save and LoadConfigResponse

| Field Names              | Length (char) | Range of Values | Comments                        |
|--------------------------|---------------|-----------------|---------------------------------|
| Standard Response Header | Variable      | <See Table 8.2> | Message Type = SAVE-R or LOAD-R |
| Field Delimiter          | 1             |                 | Pipe character (ASCII 124)      |

| Field Names                             | Length (char) | Range of Values  | Comments   |
|---|---------------|------------------|--|
| Parameters Successfully Saved or Loaded | Variable      | Numeric ( >= 0 ) | Number of parameters successfully saved to or loaded from file |
| Field Delimiter                         | 1             |                  | Pipe character (ASCII 124)                                     |
| Standard Trailer                        | 3             | <See Table 8.4>  |  |

## 8.1.10 GetConfigListMessage and Response

The following tables describe the message body and response for the GetConfigListMessage.

### 8.1.10.1 GetConfigListMessage

Table 8. 11 – GetConfigList Request Message

| Field Names      | Length (char) | Range of Values | Comments                          |
|------------------|---------------|-----------------|-----------------------------------|
| Standard Header  | Variable      | <See Table 8.2> | Message Type Field = SAVE or LOAD |
| Field Delimiter  | 1             |                 | Pipe character (ASCII 124)        |
| Standard Trailer | 3             | <See Table 8.4> |                                   |

### 8.1.10.2 GetConfigListMessage Response

Table 8. 12 – GetConfigListMessage Response

| Field Names                   | Length (char) | Range of Values  | Comments   |
|-------------------------------|---------------|------------------|--|
| Standard Header               | Variable      | <See Table 8.2>  | Message Type Field = DIR-R                                 |
| Field Delimiter               | 1             |                  | Pipe character (ASCII 124)                                 |
| Number of Configuration Names | Variable      | Numeric ( >= 0 ) | Number of configuration names available                    |
| Configuration Name 1          | Variable      | Alphanumeric     | Name of 1 <sup>st</sup> configuration available            |
| Field Delimiter               | 1             |                  | Pipe character (ASCII 124)                                 |
| ...                           |               |                  |  |
| Configuration Name n          | Variable      | Alphanumeric     | Name of <sup>n</sup> <sup>th</sup> configuration available |

| Field Names      | Length (char) | Range of Values | Comments                   |
|------------------|---------------|-----------------|----------------------------|
| Field Delimiter  | 1             |                 | Pipe character (ASCII 124) |
| Standard Trailer | 3             | <See Table 8.4> |                            |

## 8.1.11 DirectiveMessage and Response

The following tables describe the message body and response for the DirectiveMessage.

### 8.1.11.1 DirectiveMessage

Table 8. 13 - Directive Request Message

| Field Names          | Length (char) | Range of Values  | Comments  |
|----------------------|---------------|------------------|---|
| Standard Header      | Variable      | <See Table 8.2>  | Message Type Field = DIR  |
| Field Delimiter      | 1             |                  | Pipe character (ASCII 124)  |
| Directive Name       | Variable      | Alphanumeric     | Name of the directive to execute  |
| Field Delimiter      | 1             |                  | Pipe character (ASCII 124)  |
| Number of Parameters | Variable      | Numeric ( >= 0 ) | Number of parameters to be passed into directive                                      |
| Field Delimiter      | 1             |                  | Pipe character (ASCII 124)  |
| Parameter 1          | Variable      | <See Table 8.1>  | 1st parameter of directive.<br>Only if Number of Parameters field is > 0.             |
| Field Delimiter      | 1             |                  | Pipe character (ASCII 124)  |
| ...                  |               |                  |   |
| Parameter n          | Variable      | <See Table 8.1>  | nth parameter of directive.<br>Only if Directive Number of Parameters field is > n -1 |
| Field Delimiter      | 1             |                  | Pipe character (ASCII 124)  |
| Standard Trailer     | 3             | <See Table 8.4>  |   |

### 8.1.11.2 DirectiveMessage Response

| Field Names     | Length (char) | Range of Values | Comments                   |
|-----------------|---------------|-----------------|----------------------------|
| Standard Header | Variable      | <See Table 8.2> | Message Type Field = DIR-R |
| Field Delimiter | 1             |                 | Pipe character (ASCII 124) |

| Field Names             | Length (char) | Range of Values  | Comments   |
|-------------------------|---------------|------------------|--|
| Directive Name          | Variable      | Alphanumeric     | Name of the directive  |
| Field Delimiter         | 1             |                  | Pipe character (ASCII 124)   |
| Number of Return Values | Variable      | Numeric ( >= 0 ) | Number of returned values  |
| Field Delimiter         | 1             |                  | Pipe character (ASCII 124)   |
| Return Value 1          | Variable      | <See Table 8.1>  | 1 <sup>st</sup> return parameter.<br>Only if Number of Return Values field is > 0. |
| Field Delimiter         | 1             |                  | Pipe character (ASCII 124)   |
| ...                     |               |                  |  |
| Return Value n          | Variable      | <See Table 8.1>  | nth return parameter.<br>Only if Number of Return Values field is > n -1           |
| Field Delimiter         | 1             |                  | Pipe character (ASCII 124)   |
| Standard Trailer        | 3             | <See Table 8.4>  |  |

## 8.2 ASCII Examples

This section contains example ASCII messages.

### 8.2.1 ConnectMessage Example

Message:

```
|GEMS|01|000122|123| |11111111.222000000|FrameSync1|CON|CONTROL_AND_STATUS|END
```

Response:

```
|GEMS|01|000122|123|CS123|11111111.222000000|FrameSync1|CON-R|SUCCESSThe CON request was successful.|END
```

### 8.2.2 DisconnectMessage Example

Message:

```
|GEMS|01|000122|123|CS123|11111111.222000000|FrameSync1|DISC|NORMAL_TERMINATION|END
```

### 8.2.3 GetConfigMessage Example

Message:

```
|GEMS|01|000122|123|CS123|111111111.222000000|FrameSync1|GET|2|length_in_bits|sync_pattern|END
```

Response:

```
|GEMS|01|000122|123|CS123|111111111.222000000|FrameSync1|GET-R|SUCCESS|The GET request was successful.|2|length_in_bits:uint=2048| sync_pattern:hexvalue(22)=FAF320|END
```

### 8.2.4 SetConfigMessage Example

Message:

```
|GEMS|01|000122|123|CS123|111111111.222000000|FrameSync1|SET|2|length_in_bits:uint=2048| sync_pattern:hexvalue(22)|END
```

Response:

```
|GEMS|01|000122|123|CS123|111111111.222000000|FrameSync1|SET-R|SUCCESS| The SET request was successful.|2|TRUE|END
```

### 8.2.5 SaveConfigMessage Example

Message:

```
|GEMS|01|000122|123|CS123|111111111.222000000|FrameSync1|SAVE|Some_File_Name|END
```

Response:

```
|GEMS|01|000122|123|CS123|111111111.222000000|FrameSync1|SAVE-R|SUCCESS|The SAVE request was successful.|100|0|END
```

### 8.2.6 LoadConfigMessage Example

Message:

```
|GEMS|01|000122|123|CS123|111111111.222000000|FrameSync1|LOAD|Some_File_Name|END
```

Response:

```
|GEMS|01|000122|123|CS123|111111111.222000000|FrameSync1|LOAD-R|SUCCESS|The LOAD request was successful.|100|END
```

### 8.2.7 DirectiveMessage Example

Message:

```
|GEMS|01|000122|123|CS123|111111111.222000000|FrameSync1|DIR|sendVehicleCommand|1| command:hex_value=FF1234567890ABCDFE/63|END
```

Response:

|GEMS|01|000122|123|CS123|111111111.222000000|FrameSync1|DIR-R|SUCCESS|The DIR request was successful.|sendVehicleCommand|1|accepted:bool=true|END

### **8.3 TCP/IP Message Structure**

The GEMS-ASCII messages contain all of the information necessary for transport across both networks and serial data buses. The message are written directly to a socket or serial port. No additional header information is required.



