



Diagram Definition (DD)

Version 1.1
(with change bars)

OMG Document Number: ptc/2014-03-03
Normative reference: <http://www.omg.org/spec/DD/1.1>
Machine consumable files: <http://www.omg.org/spec/DD/20131001/>
Normative: <http://www.omg.org/spec/DD/20131001/DC.xmi>
 <http://www.omg.org/spec/DD/20131001/DI.xmi>
 <http://www.omg.org/spec/DD/20131001/DG.xmi>

Copyright © 2010-2011, Adaptive
Copyright © 2010-2011, Deere & Company
Copyright © 2010-2011, Fujitsu
Copyright © 2010-2014, International Business Machines
Copyright © 2010-2011, Model Driven Solutions
Copyright © 2010-2014, Object Management Group, Inc.
Copyright © 2010-2011, Sparx Systems
Copyright © 2010-2011, Trisotech

USE OF SPECIFICATION - TERMS, CONDITIONS & NOTICES

The material in this document details an Object Management Group specification in accordance with the terms, conditions and notices set forth below. This document does not represent a commitment to implement any portion of this specification in any company's products. The information contained in this document is subject to change without notice.

LICENSES

The companies listed above have granted to the Object Management Group, Inc. (OMG) a nonexclusive, royalty-free, paid up, worldwide license to copy and distribute this document and to modify this document and distribute copies of the modified version. Each of the copyright holders listed above has agreed that no person shall be deemed to have infringed the copyright in the included material of any such copyright holder by reason of having used the specification set forth herein or having conformed any computer software to the specification.

Subject to all of the terms and conditions below, the owners of the copyright in this specification hereby grant you a fully-paid up, non-exclusive, nontransferable, perpetual, worldwide license (without the right to sublicense), to use this specification to create and distribute software and special purpose specifications that are based upon this specification, and to use, copy, and distribute this specification as provided under the Copyright Act; provided that: (1) both the copyright notice identified above and this permission notice appear on any copies of this specification; (2) the use of the specifications is for informational purposes and will not be copied or posted on any network computer or broadcast in any media and will not be otherwise resold or transferred for commercial purposes; and (3) no modifications are made to this specification. This limited permission automatically terminates without notice if you breach any of these terms or conditions. Upon termination, you will destroy immediately any copies of the specifications in your possession or control.

PATENTS

The attention of adopters is directed to the possibility that compliance with or adoption of OMG specifications may require use of an invention covered by patent rights. OMG shall not be responsible for identifying patents for which a license may be required by any OMG specification, or for conducting legal inquiries into the legal validity or scope of those patents that are brought to its attention. OMG specifications are prospective and advisory only. Prospective users are responsible for protecting themselves against liability for infringement of patents.

GENERAL USE RESTRICTIONS

Any unauthorized use of this specification may violate copyright laws, trademark laws, and communications regulations and statutes. This document contains information which is protected by copyright. All Rights Reserved. No part of this work covered by copyright herein may be reproduced or used in any form or by any means--graphic, electronic, or mechanical, including photocopying, recording, taping, or information storage and retrieval systems--without permission of the copyright owner.

DISCLAIMER OF WARRANTY

WHILE THIS PUBLICATION IS BELIEVED TO BE ACCURATE, IT IS PROVIDED "AS IS" AND MAY CONTAIN ERRORS OR MISPRINTS. THE OBJECT MANAGEMENT GROUP AND THE COMPANIES LISTED ABOVE MAKE NO WARRANTY OF ANY KIND, EXPRESS OR IMPLIED, WITH REGARD TO THIS PUBLICATION, INCLUDING BUT NOT LIMITED TO ANY WARRANTY OF TITLE OR OWNERSHIP, IMPLIED WARRANTY OF MERCHANTABILITY OR WARRANTY OF FITNESS FOR A PARTICULAR PURPOSE OR USE. IN NO EVENT SHALL THE OBJECT MANAGEMENT GROUP OR ANY OF THE COMPANIES LISTED ABOVE BE LIABLE FOR ERRORS CONTAINED HEREIN OR FOR DIRECT, INDIRECT, INCIDENTAL, SPECIAL, CONSEQUENTIAL, RELIANCE OR COVER DAMAGES, INCLUDING LOSS OF PROFITS, REVENUE, DATA OR USE, INCURRED BY ANY USER OR ANY THIRD PARTY IN CONNECTION WITH THE FURNISHING, PERFORMANCE, OR USE OF THIS MATERIAL, EVEN IF ADVISED OF THE POSSIBILITY OF SUCH DAMAGES.

The entire risk as to the quality and performance of software developed using this specification is borne by you. This disclaimer of warranty constitutes an essential part of the license granted to you to use this specification.

RESTRICTED RIGHTS LEGEND

Use, duplication or disclosure by the U.S. Government is subject to the restrictions set forth in subparagraph (c) (1) (ii) of The Rights in Technical Data and Computer Software Clause at DFARS 252.227-7013 or in subparagraph (c)(1) and (2) of the Commercial Computer Software - Restricted Rights clauses at 48 C.F.R. 52.227-19 or as specified in 48 C.F.R. 227-7202-2 of the DoD F.A.R. Supplement and its successors, or as specified in 48 C.F.R. 12.212 of the Federal Acquisition Regulations and its successors, as applicable. The specification copyright owners are as indicated above and may be contacted through the Object Management Group, 140 Kendrick Street, Needham, MA 02494, U.S.A.

TRADEMARKS

MDA®, Model Driven Architecture®, UML®, UML Cube logo®, OMG Logo®, CORBA® and XMI® are registered trademarks of the Object Management Group, Inc., and Object Management Group™, OMG™, Unified Modeling Language™, Model Driven Architecture Logo™, Model Driven Architecture Diagram™, CORBA logos™, XMI Logo™, CWM™, CWM Logo™, IIOP™, IMM™, MOF™, OMG Interface Definition Language (IDL)™, and OMG SysML™ are trademarks of the Object Management Group. All other products or company names mentioned are used for identification purposes only, and may be trademarks of their respective owners.

COMPLIANCE

The copyright holders listed above acknowledge that the Object Management Group (acting itself or through its designees) is and shall at all times be the sole entity that may authorize developers, suppliers and sellers of computer software to use certification marks, trademarks or other special designations to indicate compliance with these materials.

Software developed under the terms of this license may claim compliance or conformance with this specification if and only if the software compliance is of a nature fully matching the applicable compliance points as stated in the specification. Software developed only partially matching the applicable compliance points may claim only that the software was based on this specification, but may not claim compliance or conformance with this specification. In the event that testing suites are implemented or approved by Object Management Group, Inc., software developed using this specification may claim compliance or conformance with the specification only if the software satisfactorily completes the testing suites.

OMG Formal document number: formal/2014-XX-XX

OMG's Issue Reporting Procedure

All OMG specifications are subject to continuous review and improvement. As part of this process we encourage readers to report any ambiguities, inconsistencies, or inaccuracies they may find by completing the Issue Reporting Form listed on the main web page *http://www.omg.org*, at this URL: http://www.omg.org/report_issue.htm.

Table of Contents

1	Scope	1
2	Conformance Criteria	1
3	References	1
3.1	Normative References	1
3.2	Informative References	1
4	Terms and Definitions	2
5	Symbols	2
6	Additional Information	2
6.1	How to Read this Specification	2
6.2	Changes or extensions to OMG specifications	2
6.3	Acknowledgements	2
7	Architecture	3
8	Diagram Common	7
8.1	Overview	7
8.1.1	Measurement Unit	7
8.1.2	Coordinate System	7
8.1.3	Z-Order	7
8.1.4	Rotation	8
8.2	Abstract Syntax	8
8.3	Classifier Descriptions	8
8.3.1	AlignmentKind[Enumeration]	8
8.3.2	Boolean[PrimitiveType]	9
8.3.3	Bounds[DataType]	9
8.3.4	Color[DataType]	10
8.3.5	Dimension[DataType]	10
8.3.6	Integer[PrimitiveType]	11
8.3.7	KnownColor[Enumeration]	11
8.3.8	Point[DataType]	12
8.3.9	Real[PrimitiveType]	12
8.3.10	String[PrimitiveType]	12
9	Diagram Interchange	15
9.1	Overview	15
9.2	Abstract Syntax	15

9.3 Classifier Descriptions	16
9.3.1 Diagram [Class]	16
9.3.2 DiagramElement [Abstract Class]	17
9.3.3 Edge [Abstract Class]	18
9.3.4 Shape [Abstract Class]	19
9.3.5 Style [Abstract Class]	19
10 Diagram Graphics	21
10.1 Overview	21
10.2 Abstract Syntax	21
10.3 Classifier Descriptions	25
10.3.1 Canvas [Class]	25
10.3.2 Circle [Class]	26
10.3.3 ClipPath [Class]	26
10.3.4 ClosePath [DataType]	27
10.3.5 CubicCurveTo [DataType]	27
10.3.6 Ellipse [Class]	28
10.3.7 EllipticalArcTo [DataType]	29
10.3.8 Fill [Abstract Class]	30
10.3.9 Gradient [Abstract Class]	31
10.3.10 GradientStop [DataType]	31
10.3.11 GraphicalElement [Abstract Class]	32
10.3.12 Group [Class]	33
10.3.13 Image [Class]	34
10.3.14 Line [Class]	34
10.3.15 LineTo [DataType]	35
10.3.16 LinearGradient [Class]	35
10.3.17 MarkedElement [Class]	36
10.3.18 Marker [Class]	37
10.3.19 Matrix [DataType]	38
10.3.20 MoveTo [DataType]	39
10.3.21 Path [Class]	39
10.3.22 PathCommand [Abstract DataType]	40
10.3.23 Pattern [Class]	40
10.3.24 Polygon [Class]	41
10.3.25 Polyline [Class]	41
10.3.26 QuadraticCurveTo [DataType]	42
10.3.27 RadialGradient [Class]	43
10.3.28 Rectangle [Class]	44
10.3.29 Rotate [DataType]	44
10.3.30 Scale [DataType]	45
10.3.31 Skew [DataType]	45
10.3.32 Style [Class]	46
10.3.33 Text [Class]	47
10.3.34 Transform [Abstract DataType]	48
10.3.35 Translate [DataType]	48
Annex A: UML Class Diagram Definition Example.	51

Preface

About the Object Management Group

Founded in 1989, the Object Management Group, Inc. (OMG) is an open membership, not-for-profit computer industry standards consortium that produces and maintains computer industry specifications for interoperable, portable, and reusable enterprise applications in distributed, heterogeneous environments. Membership includes Information Technology vendors, end users, government agencies, and academia.

OMG member companies write, adopt, and maintain its specifications following a mature, open process. OMG's specifications implement the Model Driven Architecture® (MDA®), maximizing ROI through a full-lifecycle approach to enterprise integration that covers multiple operating systems, programming languages, middleware and networking infrastructures, and software development environments. OMG's specifications include: UML® (Unified Modeling Language™); CORBA® (Common Object Request Broker Architecture); CWM™ (Common Warehouse Metamodel); and industry-specific standards for dozens of vertical markets.

More information on the OMG is available at <http://www.omg.org/>.

OMG Specifications

As noted, OMG specifications address middleware, modeling, and vertical domain frameworks. All OMG Specifications are available from this URL:

<http://www.omg.org/spec>

Specifications are organized by the following categories:

Business Modeling Specifications

Middleware Specifications

- CORBA/IIOP
- Data Distribution Services
- Specialized CORBA

IDL/Language Mapping Specifications

Modeling and Metadata Specifications

- UML, MOF, CWM, XMI
- UML Profile

Modernization Specifications

Platform Independent Model (PIM), Platform Specific Model (PSM), Interface Specifications

- CORBAServices
- CORBAFacilities

OMG Domain Specifications

CORBA Embedded Intelligence Specifications

CORBA Security Specifications

All of OMG's formal specifications may be downloaded without charge from our website. (Products implementing OMG specifications are available from individual suppliers.) Copies of specifications, available in PostScript and PDF format, may be obtained from the Specifications Catalog cited above or by contacting the Object Management Group, Inc. at:

OMG Headquarters
140 Kendrick Street
Building A, Suite 300
Needham, MA 02494
USA
Tel: +1-781-444-0404
Fax: +1-781-444-0320
Email: pubs@omg.org

Certain OMG specifications are also available as ISO standards. Please consult <http://www.iso.org>

Typographical Conventions

The type styles shown below are used in this document to distinguish programming statements from ordinary English. However, these conventions are not used in tables or section headings where no distinction is necessary.

Times/Times New Roman - 10 pt.: Standard body text

Helvetica/Arial - 10 pt. Bold: OMG Interface Definition Language (OMG IDL) and syntax elements.

Courier - 10 pt. Bold: Programming language elements.

Helvetica/Arial - 10 pt: Exceptions

Note – Terms that appear in *italics* are defined in the glossary. Italic text also represents the name of a document, specification, or other publication.

Issues

The reader is encouraged to report any technical or editing issues/problems with this specification to http://www.omg.org/report_issue.htm.

1 Scope

The Diagram Definition (DD) specification provides a basis for modeling and interchanging graphical notations, specifically node and arc style diagrams as found in UML, SysML, and BPMN, for example, where the notations are tied to abstract language syntaxes defined with MOF.

Note – The specification replaces OMG’s current Diagram Interchange (DI) specification (formal/2006-04-04).

2 Conformance Criteria

The DD specification provides a framework for other modeling language specifications to define their diagrams. Therefore, the DD specification does not have conformance criteria to vendors and tools directly, but rather to the modeling language specifications using it. DD enables: a) definition of language-specific diagram interchange metamodels as extensions of the DI package and b) mapping instances of these language-specific DI metamodels to graphics, as defined by the DG package. Modeling language specifications can conform to DD in two levels by supporting either (a) only, or (a) and (b), where (a) is called Diagram Information Interchange Conformance and (b) is called Diagram Graphics Conformance. Diagram Information Interchange Conformance enables the interchange of diagram information through import/export between tools of a particular modeling language. Diagram Graphics Conformance enables consistent rendering of this diagram information to graphics. DD does not have conformance criteria for the mapping language used in Diagram Graphics Conformance. DD does not restrict conformance criteria of modeling language standards using it.

3 References

3.1 Normative References

The following normative documents contain provisions which, through reference in this text, constitute provisions of this specification. For dated references, subsequent amendments to, or revisions of, any of these publications do not apply:

- MOF 2.0 Specification (<http://www.omg.org/spec/MOF/2.0/>)
- OCL 2.2 Specification (<http://www.omg.org/spec/OCL/2.2/>)

3.2 Informative References

The following informative documents are referenced throughout this text:

- QVT 1.1 Specification (<http://www.omg.org/spec/QVT/1.1/>)
- SVG 1.1 Specification (<http://www.w3.org/TR/SVG11/>)
- CSS 2.0 Specification (<http://www.w3.org/TR/CSS2/>)
- ODF 1.1 Specification (http://www.oasis-open.org/committees/tc_home.php?wg_abbrev=office)

4 Terms and Definitions

There are no specific terms and definitions associated with this specification.

5 Symbols

There are no specific symbols associated with this specification.

6 Additional Information

6.1 How to Read this Specification

The rest of this document contains the technical content of this specification. Clause 7 gives an overview of the DD architecture and describes the common assumptions made throughout the specification. Clause 8 discusses the details of the Diagram Common (DC) package. The Diagram Interchange (DI) package is described in Clause 9. Finally, Clause 10 covers the Diagram Graphics (DG) package. Although the clauses are organized in a logical manner and can be read sequentially, this is a reference specification and is intended to be read in a non-sequential manner. Consequently, extensive cross-references are provided to facilitate browsing and search.

6.2 Changes or extensions to OMG specifications

This specification replaces the following:

- Diagram Interchange v1.0 specification (formal/06-04-04)

6.3 Acknowledgements

The following companies submitted this specification:

- Adaptive
- Deere & Company
- Fujitsu
- International Business Machines
- Model Driven Solutions
- Sparx Systems

The following companies supported this specification:

- Trisotech
- U.S. National Institute of Standards and Technology

7 Architecture

The DD architecture distinguishes two kinds of graphical information, depending on whether language users have control over it. Graphics that users have control over, such as position of nodes and line routing points, are captured for interchange between tools. Graphics that users do not have control over, such as shape and line styles defined by language standards, are not interchanged, because they are the same in all diagrams conforming to the language. The DD architecture has two models to enable specification of these two kinds of graphical information, Diagram Interchange (DI) and Diagram Graphics (DG). Both models share common elements from a Diagram Common (DC) model. The DI and DG models are shown in Figure 7.1 by bold outlined boxes on the left and right, respectively.

The DD architecture expects language specifications to define mappings between interchanged and non-interchanged graphical information, but does not restrict how it is done. This is shown in Figure 7.1 by a shaded box labeled “CS Mapping Specification” in the middle section. The DD specification gives examples of mappings in QVT, but does not define or recommend any particular mapping language. The overall architecture resembles typical model-view-controllers, which separate visual rendering from underlying models, and provide a way to keep visuals and models consistent.

The first few parts of using the DD architecture are:

- An abstract language syntax is defined separately from DD by instantiating MOF (abstract syntaxes are sometimes called “metamodels”). This is shown in Figure 7.1 by a shaded box labeled “AS” at the far middle left (the “M” levels in the figure are described in the UML 2 Infrastructure - formal/2009-02-04).
- Language users model their applications by instantiating elements of abstract syntax, usually through tooling for the language. This is shown in Figure 7.1 by the dashed arrow on the far lower left from a box labeled “Model.”
- Users typically see graphical depictions of their models in tools. This is shown in Figure 7.1 by a box on the lower right labeled “Graphics.”

Users expect their graphics to appear again in other tools after models are interchanged. The DD architecture enables this in two parts, one for graphical information that is interchanged, and another for graphical information that is not. The interchanged information is captured in the next few steps:

- The non-normative aspects of graphics that a specification choose to give its users control over is captured for interchange, such as node position and line routing points (tools may optionally give their users control over more such non-normative aspects like color or fill). This is shown in Figure 7.1 by a box labeled “Diagram” on the lower left. This information is linked to user models (instances of abstract syntax), as shown by the arrow from the Diagram to the Model.
- User diagram interchange information is instantiated from a model defined along with the abstract syntax. This model is shown in Figure 7.1 by a shaded box labeled “AS DI” on the left. Elements in it are linked to elements of abstract syntax, specifying which diagram information to interchange for which model element, as shown by the arrow between AS DI and AS. AS DI models are typically defined by the same community that defines the abstract syntax, as part of the overall language specification.
- Elements of language-specific diagram interchange models (AS DI) specialize elements of the diagram interchange (DI), which is a model provided by this specification for typically needed diagram interchange information, such as node position and line routing points. This is shown in Figure 7.1 by the bold box labeled “DI” on the left, where specialization (using MOF generalization and property subsetting/redefinition where DI has the general elements, and AS DI has the specific elements) is shown with a hollow headed arrow. DI elements cannot be instantiated to capture

diagram interchange information by themselves; they are almost entirely abstract. This enables DI to capture common diagramming patterns abstractly while giving AS DI the choice to concretely specialize those patterns or not when defining its elements. This specification provides normative CMOF artifacts for DI.

The final part of using the DD architecture captures graphical information that is not interchanged:

- Language specifications specify mappings from their diagram interchange models (instances of AS DI) to instances of Diagram Graphics (DG), which is a model provided by this specification for typically needed graphical information, such as shape and line styles. This is shown in Figure 7.1 by the box labeled “DG” on the right, and by the box labeled “CS Mapping Specification” in the middle section. The arrow at the bottom of the middle section illustrates mappings being carried out according to the specification above it, producing a model of diagram graphics that can be rendered on displays. Languages specifying this mapping reduce ambiguity and nonuniformity in how their syntax appears visually. The DG model is not expected to be specialized, enabling implementations to render instances of DG elements for all applications of the DD architecture. This specification provides normative CMOF artifacts for DG.

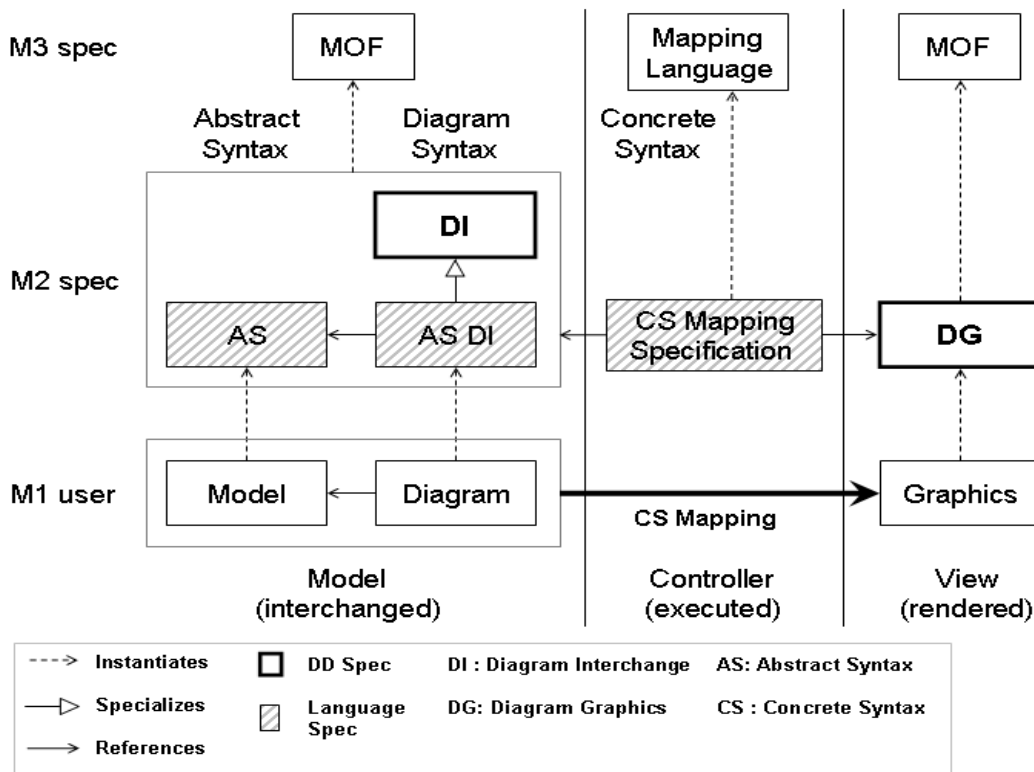

Figure 7.1 - Diagram Definition Architecture

An example of realizing the DD architecture for the UML language is shown in Figure 7.2. In this figure, the UML language specification would provide three normative artifacts at M2 (shown with shaded boxes): the abstract syntax model (UML), the UML diagram interchange model (UML DI), and the mapping specification between the UML DI and the graphics model (UML Mapping Specification). At M1, to the far left, the figure shows an instance of UML::Usecase as a model element. Next to it on the right, the figure shows an instance of UMLDI::UMLShape with a given bounds referencing the usecase element. This indicates that the usecase is depicted as a shape with the given bounds on the diagram. The shape also contains an instance of UMLDI::UMLLabel with a given bounds representing the bounds of the

textual label of the usecase on the diagram. To the far right of M1, the figure shows an instance of DG::Group containing instances of DG::Ellipse and DG::Text with property values derived from the UML element and its referencing UML DI elements. This derivation results from executing the mapping specification, in the middle, between UML DI and DG.

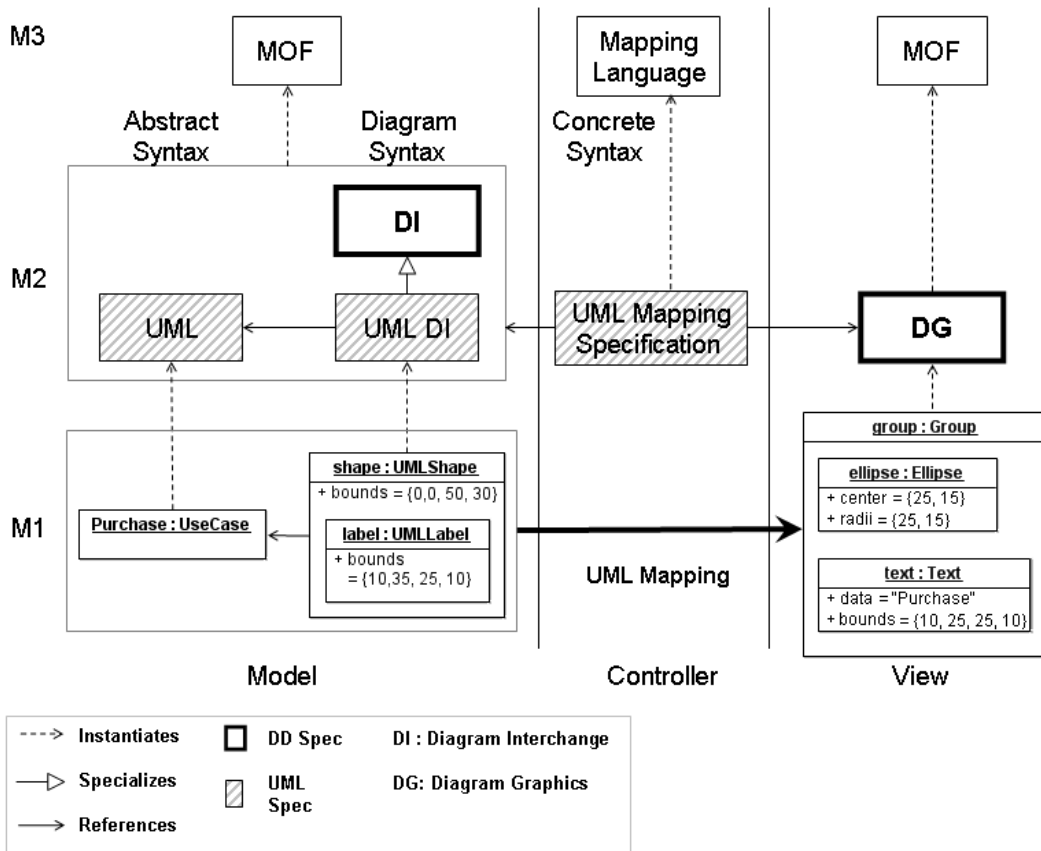

Figure 7.2 - Example of Diagram Definition Architecture For UML

The DD architecture is designed to enable language specifications to choose the level of detail and formality in diagram definition. Some areas of flexibility are:

- Mappings to Diagram Graphics: Language specifications might choose to follow the above architecture completely, including mappings from diagram interchange to graphics expressed in an executable mapping language. Or they might choose to describe this informally in natural language, or even more informally in tables of graphical symbols.
- Specialization of Diagram Interchange: Language specifications might choose to minimize redundancy of diagram elements and user models to reduce interchange file size. For example, a standard might choose to eliminate separate shape classes corresponding to abstract syntax elements, with all diagram properties provided in a single top level diagram element class, and all other information derived from referenced user model elements. Or standards might choose to decouple diagram elements from user models by duplicating some of all the user model information in diagram elements, enabling purely graphical tools to operate on interchanged information.
- Other areas: Language specifications can choose whether the same user model element is shown by multiple diagram elements, and how much formatting and styling is interchanged.

The DD architecture is also designed to avoid defining new languages where existing ones are available. In particular, rather than introducing a new model for specifying classification, specialization, and properties, DD reuses MOF. And rather than mandate a mapping language for transformation from diagram interchange to diagram graphics, DD leaves this to applications of the architecture, assuming compatibility with MOF.

8 Diagram Common

The Diagram Common (DC) package contains abstractions shared by the Diagram Interchange and the Diagram Graphics packages.

8.1 Overview

The Diagram Common (DC) package contains a number of common primitive types as well as structured data types that are used by the other DD packages, namely the Diagram Graphics(DI) package (Clause 9) and the Diagram Interchange(DG) package (Clause 10). The DC package itself does not depend on other packages.

The following sub clauses discuss common assumptions that are made by DC and the other DD packages.

8.1.1 Measurement Unit

All coordinates and lengths defined by the DD packages are assumed to be in user units. A user unit is a value in the user coordinate system, which initially (before any transformation is applied) aligns with the device's coordinate system (for example, a pixel grid of a display). A user unit, therefore, represents a logical rather than physical measurement unit. Since some applications might specify a physical dimension for a diagram as well (mainly for printing purposes), a mapping from a user unit to a physical unit can be specified as a diagram's resolution. (Inch is chosen in this specification to avoid variability but tools can easily convert from/to other preferred physical units.) Resolution specifies how many user units fit within one physical unit (for example, a resolution of 300 specifies that 300 user units fit within 1 inch on the device).

8.1.2 Coordinate System

This specification assumes a two-dimensional x-y coordinate system that has its origin at coordinate $x=0, y=0$. The x-axis is horizontal and its coordinate values increases to the right with negative coordinates allowed. Similarly, the y-axis is vertical and its coordinate values increases to the bottom with negative coordinates allowed.

Issue: 16909 – DiagramElement ownership

8.1.3 Rotation

Rotations specified throughout this specification are made in degrees and can be positive (clock-wise) or negative (counter-clock-wise).

8.2 Abstract Syntax

Issue: 17453 – Use MOF Primitive Types



Figure 8.1 Dependencies of the DC package

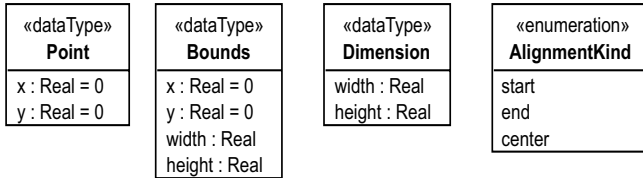

Figure 8.2 - The layout data types

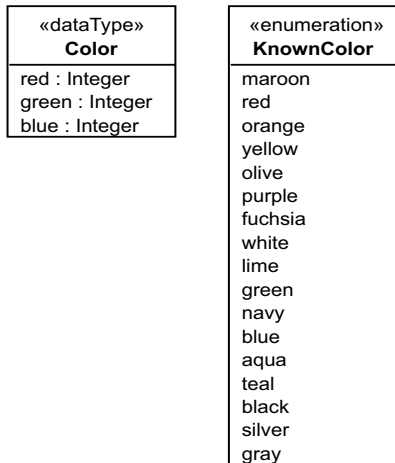

Figure 8.3 - The color data type

8.3 Classifier Descriptions

8.3.1 AlignmentKind [Enumeration]

AlignmentKind enumerates the possible options for alignment for layout purposes.

Description

AlignmentKind enumerates the possible kinds for alignment for layout purposes (e.g., for text alignment within a bounding box).

Diagrams

- Figure 8.2 (Layout Types)

Literals

- start - an alignment to the start of a given length.
- end - an alignment to the end of a given length
- center - an alignment to the center of a given length

8.3.2 Bounds [DataType]

Bounds specifies a rectangular area in some x-y coordinate system that is defined by a location (x and y) and a size (width and height).

Description

Bounds is used to specify a rectangular area in some x-y coordinate system. The area is specified with a (x, y) location, representing the distance of the area's top-left corner from the origin, and a size (width and height) along the x-y axes.

Diagrams

- Figure 8.2 (Layout Types)

Attributes

- x : Real [1] = 0 - a real number (≥ 0 or ≤ 0) that represents the x-coordinate of the bounds
- y : Real [1] = 0 - a real number (≥ 0 or ≤ 0) that represents the y-coordinate of the bounds
- width : Real [1] - a real number (≥ 0) that represents the width of the bounds
- height : Real [1] - a real number (≥ 0) that represents the height of the bounds

Constraints

- non_negative_size: the width and height of bounds cannot be negative
[OCL] width ≥ 0 and height ≥ 0

8.3.3 Color [DataType]

Color is a data type that represents a color value in the RGB format.

Description

Color is used as a type for attributes that represent color. The color value is encoded using the RGB format as three separate integers in the range (0...255) representing the red, green, and blue components of the color. For example the color yellow is (red=255, green=255, blue=0).

Diagrams

- Figure 8.3 (Color Type)

Attributes

- red : Integer [1] - the red component of the color in the range (0..255)
- green : Integer [1] - the red component of the color in the range (0..255)
- blue : Integer [1] - the red component of the color in the range (0..255)

Constraints

- valid_rgb: the red, green, and blue components of the color must be in the range (0..255).
[OCL] red >= 0 and red <=255 and green >= 0 and green <=255 and blue >= 0 and blue <=255

8.3.4 Dimension [DataType]

Dimension specifies two lengths (width and height) along the x and y axes in some x-y coordinate system.

Description

Dimension is used to specify two lengths, a width along the x-axis and a height along the y-axis, in a x-y coordinate system.

Diagrams

- Figure 8.2 (Layout Types)

Attributes

- width : Real [1] - a real number (>=0) that represents a length along the x-axis.
- height : Real [1] - a real number (>=0) that represents a length along the y-axis.

Constraints

- non_negative_dimension: the width and height of a dimension cannot be negative
[OCL] width >= 0 and height >=0

8.3.5 KnownColor [Enumeration]

KnownColor is an enumeration of 17 known colors.

Description

KnownColor enumerates 17 known colors, defined by the CSS specification, which are: aqua, black, blue, fuchsia, gray, green, lime, maroon, navy, olive, orange, purple, red, silver, teal, white, and yellow.

Diagrams

- Figure 8.3 (Color Type)

Literals

- maroon - a color with a value of #800000
- red - a color with a value of #FF0000

- orange - a color with a value of #FFA500
- yellow - a color with a value of #FFFF00
- olive - a color with a value of #808000
- purple - a color with a value of #800080
- fuchsia - a color with a value of #FF00FF
- white - a color with a value of #FFFFFF
- lime - a color with a value of #00FF00
- green - a color with a value of #008000
- navy - a color with a value of #000080
- blue - a color with a value of #0000FF
- aqua - a color with a value of #00FFFF
- teal - a color with a value of #008080
- black - a color with a value of #000000
- silver - a color with a value of #C0C0C0
- gray - a color with a value of #808080

8.3.6 Point [DataType]

A Point specifies a location in some x-y coordinate system.

Description

Point is used to specify a coordinate that is at a given distance (along the x and y axes) from the origin of some x-y coordinate system. The point (0, 0) is considered to be at the origin of that coordinate system. Coordinates increase towards the right of the x-axis and towards the bottom of the y-axis.

Diagrams

- Figure 8.2 (Layout Types)

Attributes

- x : Real [1] = 0 - a real number (≤ 0 or ≥ 0) that represents the x-coordinate of the point.
- y : Real [1] = 0 - a real number (≤ 0 or ≥ 0) that represents the y-coordinate of the point.

Issue: 17453 – Use MOF Primitive Types

9 Diagram Interchange

The Diagram Interchange (DI) package enables interchange of graphical information that language users have control over, such as position of nodes and line routing points. Language specifications specialize elements of DI to define diagram interchange elements for a language.

9.1 Overview

Issue: 16628 – DiagramElements cannot represent multiple model Elements

The Diagram Interchange (DI) package contains a number of types used in the definition of diagram interchange models. The package imports the Diagram Common package (Clause 8) and UML, as shown in Figure 9.1, that contains various relevant data types. The DI package contains many abstract types for extension and refinement by concrete types in domain-specific DI packages. DI is a framework meant for extension rather than a component ready to be used out of the box. It provides typically needed diagram interchange information for customized DI models in specific graphical domains.

9.2 Abstract Syntax

Issue: 16628 – DiagramElements cannot represent multiple model Elements

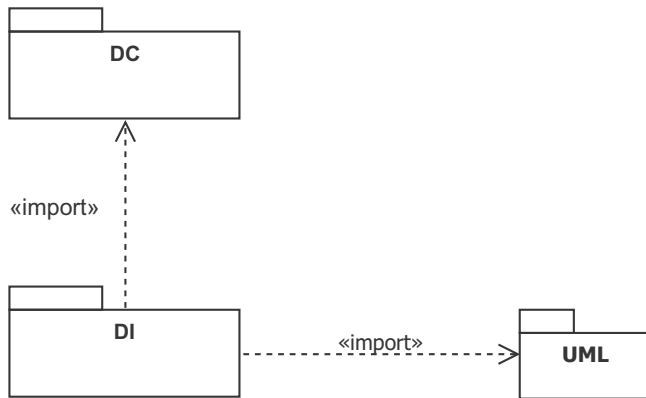

Figure 9.1 - Dependencies of the DI package

Issue: 16628 – DiagramElements cannot represent multiple model Elements

Issue: 16909 – DiagramElement ownership

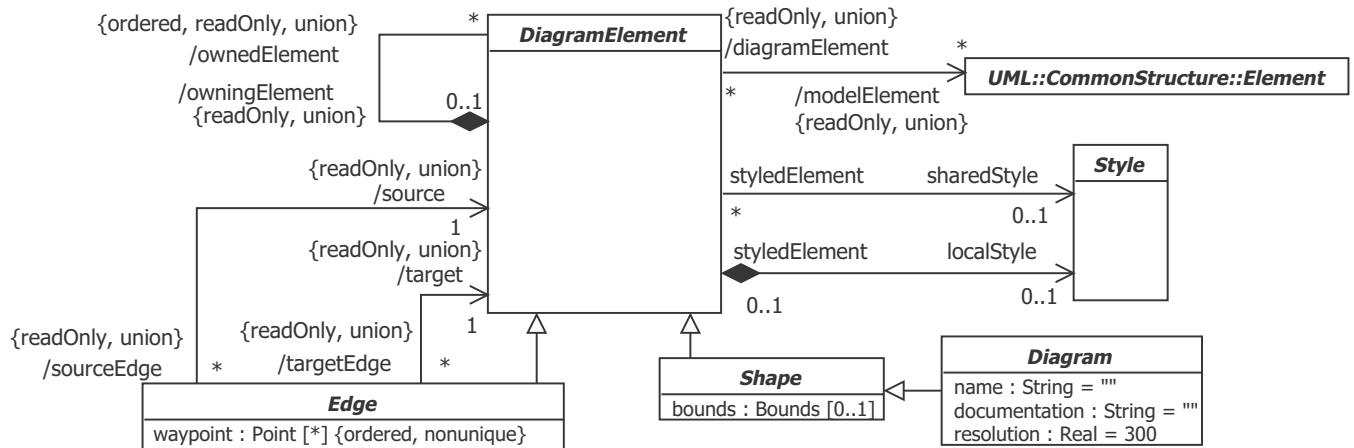

Figure 9.2 - Diagram Element

9.3 Classifier Descriptions

9.3.1 Diagram [Class]

Diagram is an abstract container of a graph of diagram elements. Diagrams are diagram elements with an origin point in the x-y coordinate system. Their elements are laid out relative to their origin point.

Description

A diagram does not need to be nested. It can be persisted in the same resource as the abstract syntax model or in a different resource. It can also be owned by elements of the abstract syntax model, or by no element at all (like being the root of the resource).

A diagram represents a two dimensional x-y coordinate system that is used to layout nested and inter-connected diagram elements. A diagram has an origin point (0, 0) on the x and y. The coordinate system of a diagram increases along the x-axis from left to right and along the y-axis from top to bottom. All the nested diagram elements are laid out relative to their nesting diagram's origin.

Issue: 16628 – DiagramElements cannot represent multiple model Elements

As a kind of diagram element, a diagram may reference model elements from an abstract syntax model, in which case the whole diagram is considered a depiction of those elements (e.g., an activity diagram is a depiction of a UML activity). Alternatively, a diagram without such a reference is simply a layout container for its diagram elements (e.g., a class diagram is a container for UML class shapes and edges).

A diagram can have a name and a documentation. This information is not shown as part of the rendering of the diagram itself but can be used in an application to label a diagram (e.g., “DI Package Diagram”) in a browser and show its intent (e.g., “A diagram that shows the classes of the DI package”).

A diagram also specifies a resolution expressed in units per inch. The resolution specifies the conversion ratio between the logical units used by the diagram and a unit of physical measurement (an inch in this case). For example, a resolution value of 300 specifies that every 300 logical unit of length map to an inch. The resolution value is mainly used when printing diagrams or when rendering diagrams on display in their physical size.

Styles contain combinations of style property values used by different elements across the diagram. This allows a large number of elements in a diagram to reference a small number of styles, which would dramatically reduce a diagram’s footprint.

Diagrams

- Figure 9.2 (DI Package)

Generalizations

- Shape [Abstract Class]

Attributes

- name : String [1] = “” - the name of the diagram.
- documentation : String [1] = “” - the documentation of the diagram.
- resolution : Real [1] = 300 - the resolution of the diagram expressed in user units per inch.

9.3.2 DiagramElement [Abstract Class]

DiagramElement is the abstract super type of all elements in diagrams, including diagrams themselves. When contained in a diagram, diagram elements are laid out relative to the diagram’s origin.

Description

Issue: 16628 – DiagramElements cannot represent multiple model Elements

A diagram element can be useful on its own (i.e., purely notational) or more commonly used as a depiction of other MOF-based elements from an abstract syntax model (like a UML model). In the latter case, the diagram element references the depicted model elements and defines notational properties for those elements. An example of a depicting diagram element is a Class shape on a UML diagram that specifies the bounds of the class, its colors, its compartments...etc. An example of a purely notational diagram element is a Note shape on a UML diagram that provides a textual description of part of the diagram. The diagram element’s reference to model elements is defined abstractly as derived union to allow language-specific extensions of DI to refine it further to suit their purposes (like specializing its type).

Issue: 16909 – DiagramElement ownership

A diagram element can own other diagram elements in a tree-like hierarchy. The collection of owned elements is defined abstractly as a derived union to allow language-specific extensions of DI to define the allowed topologies for their diagram elements (e.g., a UML class shape can own UML compartments). This collection is ordered, to specify z-order for owned elements. Diagram elements may overlap in some situations (their renderings may intersect), in which case it is important to determine which ones appear below or more hidden (have lower z-order) and which ones appear above or more visible (have higher z-order). Z-order of owned diagram elements is determined as follows:

- Owned diagram elements are higher in z-order than their owning diagram elements.
- Diagram elements that appear earlier in the ordered collection have higher z-order than those that appear later.

More specialized diagram element types define properties that characterize their nature. However, a subset of those properties is stylistic in nature and tends to have similar values across many diagram elements. Examples of such properties are fill properties, stroke properties, and font properties. To minimize the footprint of diagram interchange models, those stylistic properties are not defined on diagram elements directly but are rather defined on Style elements that can be owned and/or shared by diagram elements. Shared style elements are owned by other elements, which might be packaging elements in the language incorporating diagram interchange. Style property values are calculated based on a well-defined algorithm given in “Style [Abstract Class]” on page 20.

Diagrams

- Figure 9.2 (DI Package)

Specializations

- Edge [Abstract Class]
- Shape [Abstract Class]

Association Ends

Issue: 16628 – DiagramElements cannot represent multiple model Elements

Issue: 16909 – DiagramElement ownership

- `/modelElement` : Element [*] {readOnly, union} - a reference to a depicted model elements, which can be any MOF-based element.
- `/owningElement` : DiagramElement [0..1] {readOnly, union} - a reference to the diagram element that directly owns this diagram element.
- `♦/ownedElement` : DiagramElement [*] {readOnly, union, ordered} - an ordered collection of diagram elements that are directly owned by this diagram element.
- `♦ localStyle` : Style [0..1] - a reference to an optional locally-owned style for this diagram element.
- `sharedStyle` : Style [0..1] - a reference to an optional shared style element for this diagram element.

9.3.3 Edge [Abstract Class]

Edge is a diagram element that renders as a polyline, connecting a source diagram element to a target diagram element, and is positioned relative to the origin of the diagram.

Description

Edge represents a diagram element defined with a sequence of connected waypoints forming a polyline that connects two diagram elements: a source element and a target element (could be the same as the source as in self connection). The waypoints are positioned relative to the origin of the nesting diagram, specifying a route for the polyline on the diagram.

An edge can be purely notational, i.e., does not reference any model element. An example is the line attaching a comment to a UML element. On the other hand, an edge can be a depiction of a relational element from an abstract syntax model. Examples include UML generalization edge or a BPMN message flow edge. In that case, the edge's source and target reference diagram elements depicting the relationship's source and target elements (or its two related elements if the relationship is not directed) respectively. The edge's source and target references are defined abstractly as derived unions. In an extending language-specific DI metamodel, these references need to be refined. In case the source and target references can be derived unambiguously from the model element, the properties can be redefined with that derivation logic. Otherwise, the properties can be specialized with concrete settable properties.

Diagrams

- Figure 9.2 (DI Package)

Generalizations

- DiagramElement [Abstract Class]

Attributes

- waypoint : Point [*] {ordered, nonunique} - an optional list of points relative to the origin of the nesting diagram that specifies the connected line segments of the edge.

Association Ends

- /source : DiagramElement [1] {readOnly, union} - the edge's source diagram element, i.e., where the edge starts from.
- /target : DiagramElement [1] {readOnly, union} - the edge's target diagram element, i.e., where the edge ends at.

9.3.4 Shape [Abstract Class]

Shape is a diagram element with given bounds that is laid out relative to the origin of the diagram.

Description

Shape is an abstract class that is expected to be further sub classed in a language-specific DI metamodel.

A shape can be purely notational, i.e., does not reference any model element. Examples include a note shape on a UML class diagram with some text describing the diagram and an overlay shape with some semi-transparent fill enclosing a bunch of shapes on the diagram to make them stand out. On the other hand, a shape can be a depiction of a component (non-relational) element from an abstract syntax model. Examples include a UML class shape and a BPMN activity shape.

Diagrams

- Figure 9.2 (DI Package)

Generalizations

- DiagramElement [Abstract Class]

Specializations

- Diagram [Class]

Attributes

- bounds : Bounds [0..1] - the optional bounds of the shape relative to the origin of its nesting plane.

9.3.5 Style [Abstract Class]

Style contains formatting properties that affect the appearance or style of diagram elements, including diagram themselves.

Description

A Style is a set of properties (e.g., `fontName`, `fillColor` or `strokeWidth`) that affect the appearance or style of diagram elements rather than their intrinsic semantics. Style is defined as an abstract class without prescribing any style properties to leave it up to language-specific DI extensions to define concrete style classes with their own properties that are applicable to their diagram element types.

A style element can either be local to (owned by) a diagram element or shared between (referenced by) several diagram elements, in which case it is owned elsewhere (e.g., by packaging elements in the language incorporating diagram interchange). A value set to a local style property in a diagram element overrides one that is set to the same property on a shared style referenced by the same diagram element.

Style properties are typically defined as optional to allow the state of “unset” to be legal. This is needed to implement cascading style, where an unset style property in one diagram element gets its value from the closest diagram element in its owning element chain that has a value set for that property.

The above semantics effectively specify that a value for a style property is based on the following mechanisms (in order of precedence):

- if there is a cascading value set on a local style, use it.
- Otherwise, if there is a cascading value set on a shared style, use it.
- Otherwise, if a cascading value is available from a diagram element in the owning element chain, use it from the closest owning element.
- Otherwise, use the style property’s default value.

Diagrams

- Figure 9.2 on page 16 (DI Package)

10 Diagram Graphics

The Diagram Graphics (DG) package contains a model of graphical primitives that can be instantiated when mapping from a language abstract syntax models and diagram interchange (DI) models to visual presentations. The mapping effectively defines the concrete syntax of a language. This specification does not restrict how the mappings are done, or what languages are used to define them.

10.1 Overview

The Diagram Graphics (DG) package provides a technology and platform independent model of two-dimensional graphical information that can be instantiated in a mapping from abstract syntax models and diagram interchange (DI) models of a given modeling language, effectively defining the concrete graphical syntax of the language. This specification does not restrict how mappings are done or what mapping languages are used to define them (QVT is one such mapping language).

In addition to mapping information contained in the interchanged models (abstract syntax and DI models) that users have control over, the mapping can also specify the aspects of the concrete syntax that users do not have a control over, such as specific geometric shapes and line styles that are fixed (made normative) by language specifications. This information is not interchanged, because it is the same in all diagrams conforming to the language.

The design of the DG package borrows to a good degree from the Scalable Vector Graphics (SVG) specification and other relevant specifications. This is done to ease the mapping of DG to existing industry standard graphical packages. DG imports the Diagram Common package (Clause 8), as shown in Figure 10.1, that contains relevant data types used by DG.

10.2 Abstract Syntax

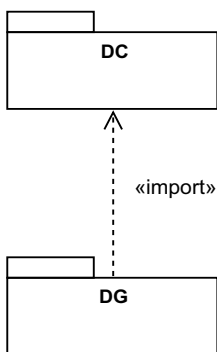

Figure 10.1 - Dependencies of the DG package

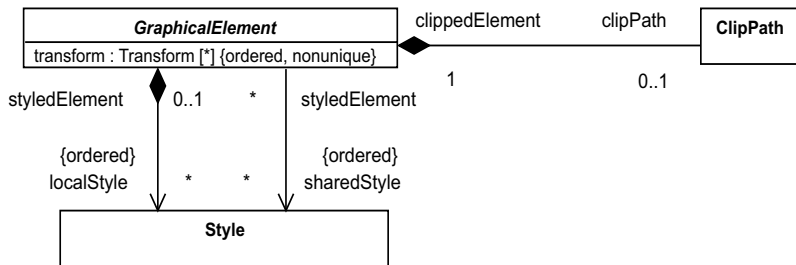

Figure 10.2 - Graphical Element

Issue: 18675 – MarkedElement should be abstract in provided CMOF files

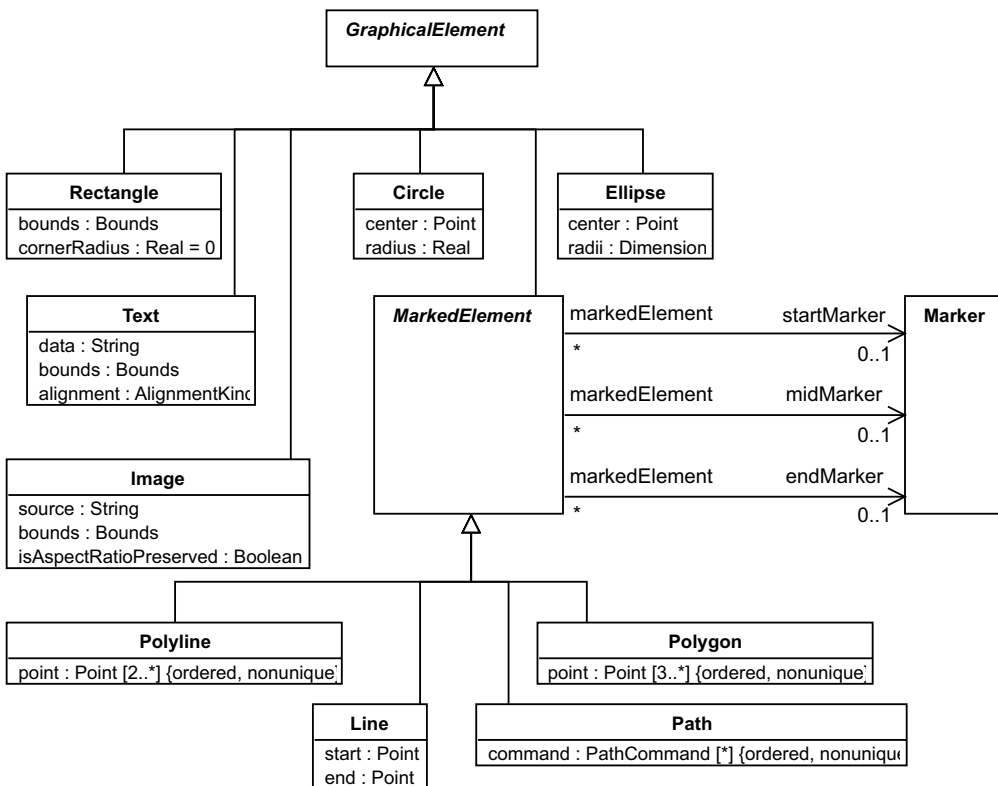

Figure 10.3 - Primitive Elements

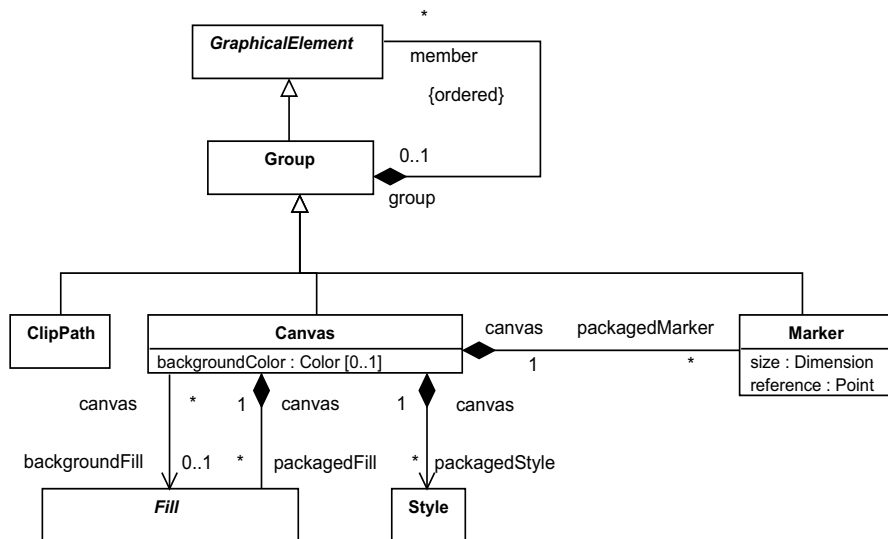

Figure 10.4 - Group Elements

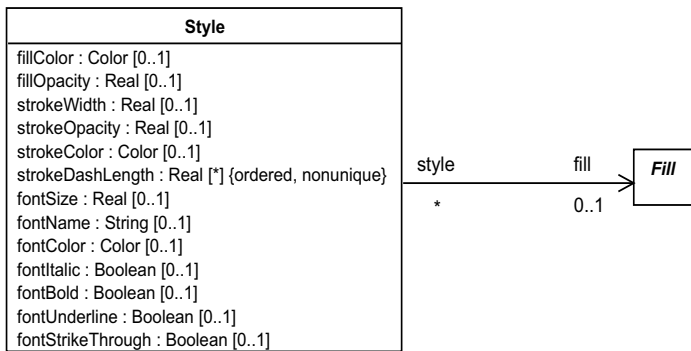

Figure 10.5 - Style

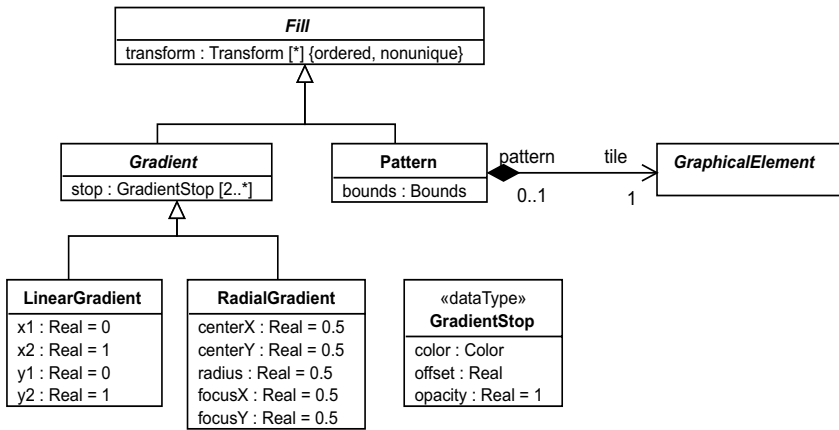

Figure 10.6 - Fills

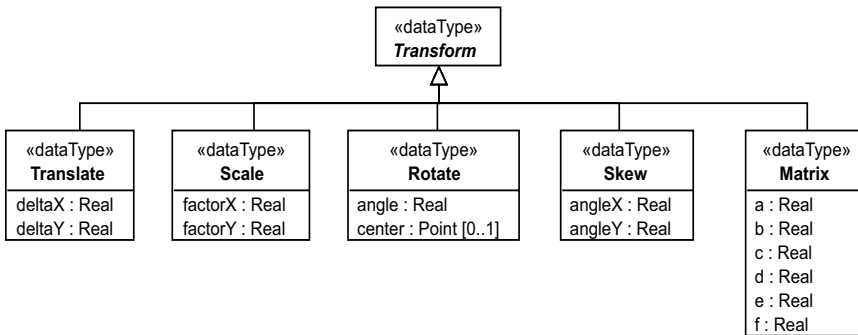

Figure 10.7 - Transforms

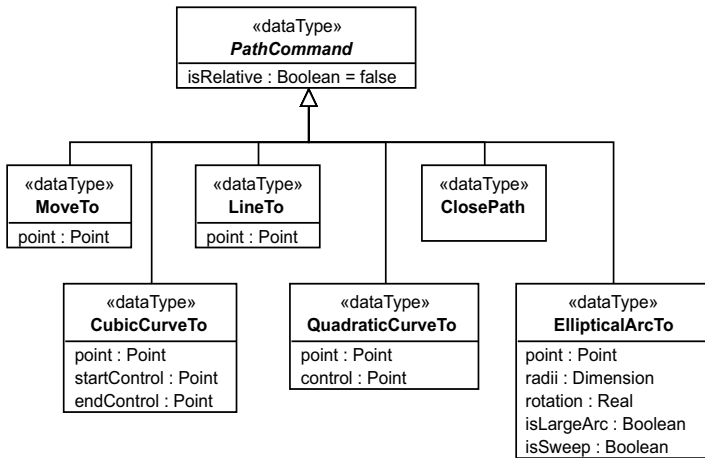

Figure 10.8 - Path Commands

10.3 Classifier Descriptions

10.3.1 Canvas [Class]

Canvas is a kind of group that represents the root of containment for all graphical elements that render one diagram.

Description

Canvas is a kind of group that is used as a root container of a hierarchy of graphical elements used to render the same diagram. A canvas has a two-dimensional x-y coordinate system with a (x=0, y=0) origin point and an infinite size. The coordinate system increases along the x-axis from left to right and along the y-axis from top to bottom, with negative coordinates allowed. The coordinates of graphical elements nested in the canvas member hierarchy are relative to the origin of the canvas. Unlike a group, a canvas has a visual manifestation in the form of a background that can be filled separately from its member elements.

Diagrams

- Figure 10.4 (Group Elements)

Generalizations

- Group [Class]

Attributes

- backgroundColor : Color [0..1] - a color that is used to paint the background of the canvas itself. A backgroundColor value is exclusive with a backgroundFill value. If both are specified, the backgroundFill value is used. If none is specified, no fill is applied (i.e., the canvas becomes see-through).

Association Ends

- backgroundFill : Fill [0..1] - a reference to a fill that is used to paint the background of the canvas itself. A backgroundFill value is exclusive with a backgroundColor value. If both are specified, the backgroundFill value is used. If none is specified, no fill is applied (i.e., the canvas becomes see-through).
- ♦ packagedFill : Fill [*] - a set of fills packaged by the canvas and referenced by graphical elements in the canvas.
- ♦ packagedMarker : Marker [*] - A set of markers packaged by the canvas and referenced by marked elements in the canvas.
- ♦ packagedStyle : Style [*] - a set of styles packaged by the canvas and referenced by graphical elements in the canvas as shared styles.

10.3.2 Circle [Class]

Circle is a graphical element that defines a circular shape with a given center point and a radius.

Description

Circle is a graphical element that renders as a circle shape with a given center point and a radius in the x-y coordinate system.

Diagrams

- Figure 10.3 (Primitive Elements)

Generalizations

- GraphicalElement [Abstract Class]

Attributes

- center : Point [1] - the center point of the circle in the x-y coordinate system.
- radius : Real [1] - a real number (≥ 0) that represents the radius of the circle.

Constraints

- non_negative_radius: the radius cannot be negative
[OCL] radius ≥ 0

10.3.3 ClipPath [Class]

ClipPath is a kind of group whose members collectively define a painting mask for its referencing graphical elements.

Description

ClipPath represents a special kind of group element that is owned by a graphical element to define its clipping mask (or stencil). A clip path does not render as a normal graphical element but is only used to specify the regions that can be painted in its owning element.

The raw geometry of each member element (exclusive of its style) of a clip path conceptually defines a 1-bit mask, which represents the silhouette of the graphics associated with that element. Anything outside the outline of the element is masked out. When the clip path contains multiple member elements, their silhouettes are logically OR'ed together to create a single silhouette, which is then used to restrict the region onto which paint can be applied. Thus, a point is inside a clip path if it is inside any of the member elements of the clip path.

The following are more rules that affect the calculation of the final clipping path of a graphical element:

- For a given graphical element, the final clipping path is defined by intersecting its owned clip path, if any, with any clip paths owned by any elements in its group chain.
- If a clip path owns itself another clip path element, the resulting clipping path is the intersection of the two.
- If any member element of the clip path owns another clip path, the given member is clipped by its own clip path first before OR'ing its silhouette with the silhouettes of the other members.

The coordinate system of the clip path is the same as the one used by its owner (e.g., if the coordinates of the owner is relative to the canvas, the coordinates of its clip path is also relative to the canvas). In addition, any transforms that are defined on the graphical element are also applied to the clip path.

Diagrams

- Figure 10.2 (Graphical Element)
- Figure 10.4 (Group Elements)

Generalizations

- Group [Class]

Association Ends

- `clippedElement` : `GraphicalElement` [1] - a reference to the owning element that is clipped by this clip path.

10.3.4 ClosePath [DataType]

`ClosePath` is a kind of path command that ends the current subpath and causes an automatic straight line to be drawn from the current point to the initial point of the current subpath.

Description

`ClosePath` is a kind of path command that ends the current subpath and causes an automatic straight line to be drawn from the current point to the initial point of the current subpath. If a `ClosePath` command is followed immediately by a `MoveTo` command, then the `MoveTo` identifies the start point of the next subpath. If a `ClosePath` is followed immediately by any other command, then the next subpath starts at the same initial point as the current subpath.

Diagrams

- Figure 10.8 (Path Commands)

Generalizations

- `PathCommand` [Abstract DataType]

10.3.5 CubicCurveTo [DataType]

CubicCurveTo is a kind of path command that draws a cubic bézier curve from the current point to a new point using a start and an end control points.

Description

CubicCurveTo is a kind of path command that draws a cubic bézier curve from the current point to a new point using two control points: startControl and endControl. Multiple CubicCurveTo commands may be specified in a row to draw a polybézier. At the end of the command, the provided point becomes the new current point in the coordinate system. Examples of cubic bézier curves are shown in Figure 10.9.

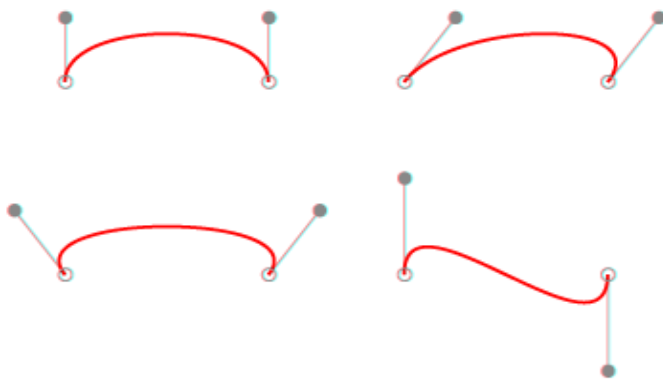

Figure 10.9 - Examples of cubic bézier curves

Diagrams

- Figure 10.8 (Path Commands)

Generalizations

- PathCommand [Abstract DataType]

Attributes

- point : Point [1] - a point to draw a cubic bézier curve to/from the current point in the coordinate system.
- startControl : Point [1] - the start control point of the cubic bézier curve.
- endControl : Point [1] - the end control point of the cubic bézier curve.

10.3.6 Ellipse [Class]

Ellipse is a graphical element that defines an elliptical shape with a given center point and two radii on the x and y axes.

Description

Ellipse is a graphical element that renders as an ellipse shape with a given center point and two radii in the x-y coordinate system.

Diagrams

- Figure 10.3 (Primitive Elements)

Generalizations

- GraphicalElement [Abstract Class]

Attributes

- center : Point [1] - the center point of the ellipse in the x-y coordinate system.
- radii : Dimension [1] - a dimension that specifies the two radii of the ellipse (a width along the x-axis and a height along the y-axis)

10.3.7 EllipticalArcTo [DataType]

EllipticalArcTo is a kind of path command that draws an elliptical arc from the current point to a new point in the coordinate system.

Description

EllipticalArcTo is a kind of path command that draws an elliptical arc from the current point to a new point in the coordinate system. The EllipticalArcTo command is also specified two radii, a rotation and two flags (isLargeArc flag and isSweep). The rotation is used to rotate the ellipse that the arc is created from. This rotation maintains (does not move) the start and end points, as shown in Figure 10.10.



Figure 10.10 - Elliptical arc rotation

The two flags control which part (sweep) of the ellipse is used to cut the arc, as shown in Figure 10.11. These are needed because there are four possible arcs, based on the arc sweep angle and direction, that can be specified between the same start and end points.

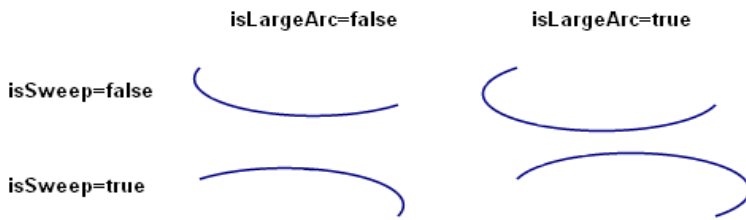

Figure 10.11 - Elliptical arc sweeps

Diagrams

- Figure 10.8 (Path Commands)

Generalizations

- PathCommand [Abstract DataType]

Attributes

- point : Point [1] - a point to draw an elliptical arc to/from the current point in the coordinate system.
- radii : Dimension [1] - the two radii of the ellipse from which the arc is created.
- rotation : Real [1] - a real number representing a rotation (in degrees) of the ellipse from which the arc is created.
- isLargeArc : Boolean [1] - whether the arc sweep is equal to or greater than 180 degrees (the large arc).
- isSweep : Boolean [1] - whether the arc is drawn in a positive-angle direction.

10.3.8 Fill [Abstract Class]

Fill is the abstract super class of all kinds of fills that are used to paint the interior of graphical elements.

Description

Fill defines a paint that can be used to fill enclosed areas of graphical elements. A fill is owned by a canvas and is referenced by graphical elements in the canvas. A fill can also be transformed (translated, scaled, rotated, or skewed) with a sequence of transforms (see “Translate [DataType]” on page 47 for more details).

Diagrams

- Figure 10.4 (Group Elements)
- Figure 10.5 (Style)
- Figure 10.6 (Fills)

Specializations

- Pattern [Class]
- Gradient [Abstract Class]

Attributes

- transform : Transform [*] {ordered, nonunique} - a list of zero or more transforms to apply to this fill.

Association Ends

- canvas : Canvas [1] - a reference to the canvas that owns this fill.

10.3.9 Gradient [Abstract Class]

Gradient is a kind of fill that paints a continuously smooth color transition along the gradient range from one color to the next.

Description

Gradient is the abstract super class of kinds of fill that paint a continuously smooth color transition from one color to another, possibly followed by additional transitions to other colors. The range of colors to use on a gradient is defined by GradientStop (see 10.3.11) that are nested by the gradient. Every stop defines a main color transition, its offset and opacity. The exact semantics of the stop offset is defined by the gradient sub classes.

Diagrams

- Figure 10.6 (Fills)

Generalizations

- Fill [Abstract Class]

Specializations

- RadialGradient [Class]
- LinearGradient [Class]

Attributes

- stop : GradientStop [2..*] - a list of two or more gradient stops defining the color transitions of the gradient.

10.3.10 GradientStop [DataType]

GradientStop defines a color transition along the distance from a gradient's start to its end offsets.

Description

GradientStop represents a color transition for a gradient. Two or more stops are owned by a gradient. Each gradient stop defines a color, an opacity and an offset. The offset is a ratio that indicates where the gradient stop is placed. For linear gradients, the offset represents a ratio along the gradient vector. For radial gradients, it represents a ratio from the focus point (0%) to the edge of the largest (outermost) circle (100%).

Diagrams

- Figure 10.6 (Fills)

Attributes

- color : Color [1] - the color to use at this gradient stop.
- offset : Real [1] - a real number (≥ 0 and ≤ 1) representing the offset of this gradient stop as a ratio of the distance between the start and end positions of the gradient.
- opacity : Real [1] = 1 - a real number (≥ 0 and ≤ 1) representing the opacity of the color at the stop. A value of 0 means totally transparent, while a value of 1 means totally opaque.

Constraints

- valid_offset: the offset must be between 0 and 1.
[OCL] offset ≥ 0 and offset ≤ 1
- valid_opacity: the opacity must be between 0 and 1.
[OCL] opacity ≥ 0 and opacity ≤ 1

10.3.11 GraphicalElement [Abstract Class]

GraphicalElement is the abstract superclass of all graphical elements that can be nested in a canvas.

Description

GraphicalElement represents a unit of graphical information that is used to build the concrete graphical syntax of modeling languages. It is the abstract super class of all graphical elements and can be nested by (a member of) a Group element and organized in a hierarchy rooted with a Canvas element (a special kind of Group).

A graphical element can reference local and/or shared styles that define how the element is styled (formatted). When a style property is not set by either local (higher precedence) or shared (lower precedence) styles, it gets its value from the closest group element that provides a value for this style property (see “Text [Class]” on page 46 for more details). If the same style property is set by multiple local styles or multiple shared styles, then the property on the style earlier in the ordering has higher precedence.

The geometry of a graphical element can optionally be transformed using a sequence of transforms (see “Translate [DataType]” on page 47). Those transforms apply on top of other transforms defined on elements in the group chain of the element. The result of applying those transforms, in sequence, defines the final state of geometry for a graphical element.

A graphical element can optionally own a clip path element to restrict its regular painting with a mask defined by the clip path. A clip path is a group of graphical elements, whose collective geometry define a mask to restrict the painting of graphical elements. Refer to “Transform [Abstract DataType]” on page 47 for more details.

Diagrams

- Figure 10.2 (Graphical Element)
- Figure 10.3 (Primitive Elements)
- Figure 10.4 (Group Elements)
- Figure 10.6 (Fills)

Specializations

Issue: 18675 – MarkedElement should be abstract in provided CMOF files

- MarkedElement [Abstract Class]
- Circle [Class]
- Ellipse [Class]
- Image [Class]
- Rectangle [Class]
- Group [Class]
- Text [Class]

Attributes

- transform : Transform [*] {ordered, nonunique} - a list of zero or more transforms to apply to this graphical element.

Association Ends

- group : Group [0..1] - the group element that owns this graphical element.
- ♦ localStyle : Style [*] {ordered} - a list of locally-owned styles for this graphical element.
- sharedStyle : Style [*] {ordered} - a list of shared styles for this graphical element.
- ♦ clipPath : ClipPath [0..1] - an optional reference to a clip path element that masks the painting of this graphical element.

10.3.12 Group [Class]

Group defines a group of graphical elements that can be styled, clipped, and/or transformed together.

Description

Issue: 18679 – Styling capabilities of Canvas ambiguous

Group is a graphical element that applies common styles, transforms, and/or clip paths to its member elements. Specialized groups can introduce visual representations, for example see “Canvas [Class]” on page 23, but Group does not define any itself. The (local or shared) styles defined on a group apply to its member elements, not to the group (see “Style [Class]” on page 44 for more details). Similarly, the transforms defined on a group element are applied to its member elements (see “Translate [DataType]” on page 47 for more details). Additionally, a clip path defined on a group element applies to its member elements (see “Transform [Abstract DataType]” on page 47 for more details).

Issue: 16909 – DiagramElement ownership

The collection of members is ordered, to specify z-order for owned elements. Graphical elements may overlap in some situations (their renderings may intersect), in which case it is important to determine which ones appear below or more hidden (have lower z-order) and which ones appear above or more visible (have higher z-order). Z-order of owned graphical elements is determined as follows:

- Owned graphical elements are higher in z-order than their owning groups.
- Graphical elements that appear earlier in the ordered collection have higher z-order than those that appear later.

Diagrams

- Figure 10.4 (Group Elements)

Generalizations

- GraphicalElement [Abstract Class]

Specializations

- ClipPath [Class]
- Marker [Class]
- Canvas [Class]

Association Ends

- ♦ member : GraphicalElement [*] {ordered} - the list of graphical elements that are members of (owned by) this group.

10.3.13 Image [Class]

Image is a graphical element that defines a shape that paints an image with a given URL within given bounds.

Description

Image is a graphical element that renders a referenced image file (with a given URL) within a given bounding box in the x-y coordinate system. Image can refer to a raster image file (e.g., a PNG or a JPEG file) or to an SVG file (i.e., one with MIME type of “image/svg+xml”). The original size of a raster image is defined by the image data, while the original size of a SVG image is given by the ‘viewBox’ attribute on the outermost SVG element.

When an image is rendered, the top-left of the image is aligned with the top-left of the bounding box. When the original size of the image matches the size of the bounding box, the image is rendered with that original size. When the two sizes are different, the image is scaled as large as possible to fit within the bounding box. The scale factors for the width and height depend on the value of the isAspectRatioPreserved flag. When the flag is set to true, the scale factors for both width and height of the image are the same. Otherwise, the scale factors may be calculated differently such that the bottom-right of the image exactly aligns with bottom-right of the bounding box. If the image’s original size cannot be retrieved (e.g., if the ‘viewBox’ attribute is not set in the SVG file), the isAspectRatioPreserved flag is assumed to be false.

Diagrams

- Figure 10.3 (Primitive Elements)

Generalizations

- GraphicalElement [Abstract Class]

Attributes

- source : String [1] - the URL of a referenced image file.

- `bounds` : `Bounds` [1] - the bounds within which the image is rendered.
- `isAspectRatioPreserved` : `Boolean` [1] - whether to preserve the aspect ratio of the image upon scaling, i.e. the same scale factor for width and height.

10.3.14 Line [Class]

Line is a marked element that defines a shape consisting of one straight line between two points.

Description

Line is a marked element that renders as a straight line between two points, a start and an end, in the x-y coordinate system.

Diagrams

- Figure 10.3 (Primitive Elements)

Generalizations

Issue: 18675 – MarkedElement should be abstract in provided CMOF files

- `MarkedElement` [Abstract Class]

Attributes

- `start` : `Point` [1] - the starting point of the line in the x-y coordinate system.
- `end` : `Point` [1] - the ending point of the line in the x-y coordinate system.

10.3.15 LineTo [DataType]

LineTo is a kind of path command that draws a straight line from the current point to a new point.

Description

LineTo is a kind of path command that draws a straight line from the current point to a new point. The effect is as if a pen was pressed and moved to a new location in a straight line. Multiple LineTo commands can be specified in a row to draw a polyline. At the end of the command, the provided point becomes the new current point in the coordinate system.

Diagrams

- Figure 10.8 (Path Commands)

Generalizations

- `PathCommand` [Abstract DataType]

Attributes

- `point` : `Point` [1] - a point to draw a straight line to/from the current point in the coordinate system.

10.3.16 LinearGradient [Class]

LinearGradient is a kind of gradient that fills a graphical element by smoothly changing color values along a vector.

Description

LinearGradient is a kind of gradient that fills a graphical element by smoothly changing color values between gradient stops along a vector. The vector is defined by start and end positions expressed as ratios ($x1$, $x2$) of the width of the element and start and end positions expressed as ratios ($y1$, $y2$) of the height of the element.

Linear gradients can be defined as horizontal, vertical, or angular gradients:

- Horizontal gradients are created when $y1$ and $y2$ are equal and $x1$ and $x2$ differ.
- Vertical gradients are created when $x1$ and $x2$ are equal and $y1$ and $y2$ differ.
- Angular gradients are created when $x1$ and $x2$ differ and $y1$ and $y2$ differ.

Diagrams

- Figure 10.6 (Fills)

Generalizations

- Gradient [Abstract Class]

Attributes

- $x1$: Real [1] = 0 - a real number (≥ 0 and ≤ 1) representing a ratio of the graphical element's width that is the x start point of the gradient.
- $x2$: Real [1] = 1 - a real number (≥ 0 and ≤ 1) representing a ratio of the graphical element's width that is the x end point of the gradient.
- $y1$: Real [1] = 0 - a real number (≥ 0 and ≤ 1) representing a ratio of the graphical element's height that is the y start point of the gradient.
- $y2$: Real [1] = 1 - a real number (≥ 0 and ≤ 1) representing a ratio of the graphical element's height that is the y end point of the gradient.

Constraints

- `valid_gradient_vector`: all the components of the gradient vector must be between 0 and 1.
[OCL] $x1 \geq 0$ and $x1 \leq 1$ and $x2 \geq 0$ and $x2 \leq 1$ and $y1 \geq 0$ and $y1 \leq 1$ and $y2 \geq 0$ and $y2 \leq 1$

Issue: 18675 – MarkedElement should be abstract in provided CMOF files

10.3.17 MarkedElement [Abstract Class]

MarkedElement is a graphic element that can be decorated at its vertices with markers (e.g., arrowheads).

Description

MarkedElement represents a graphical element that can optionally be decorated with markers (e.g., arrowheads) at its vertices (points of line intersection). It is an abstract super class of all graphical elements whose vertices are explicitly specified and ordered. A start marker decorates the first vertex, an end marker decorates the last vertex, and a mid marker decorates every other vertex in between. A marker has a higher z-order than its marked element.

Diagrams

- Figure 10.3 (Primitive Elements)

Generalizations

- GraphicalElement [Abstract Class]

Specializations

- Polyline [Class]
- Path [Class]
- Polygon [Class]
- Line [Class]

Association Ends

- startMarker : Marker [0..1] - an optional start marker that aligns with the first vertex of the marked element.
- endMarker : Marker [0..1] - an optional end marker that aligns with the last vertex of the marked element.
- midMarker : Marker [0..1] - an optional mid marker that aligns with all vertices of the marked element except the first and the last.

10.3.18 Marker [Class]

Marker is a kind of group that is used as a decoration (e.g., an arrowhead) for the vertices of a marked graphical element.

Description

Marker is a kind of group that decorates a given vertex (a point of line intersection) of a marked element. A marker has its own private coordinate system whose origin is at point $(x=0, y=0)$ and whose size is specified. The origin and the size define a clipping rectangle for the marker's member elements, which are laid out relative to the origin of the marker's coordinate system.

Additionally, a marker specifies a reference point within its bounds that is used to position the marker such that this point aligns exactly with the marked vertex. When the marker is positioned at a vertex, it also gets oriented (the axes of its coordinate system get rotated) to match the slope of the line at the vertex. For example, an arrow head marker can have a size of 10,10 (Figure 10.12 a) and a reference point of 10,5 (the small circle). When the marker is applied to the end vertex of a polyline (Figure 10.12 b), it gets aligned exactly with the end vertex and rotated to match the slope of the line at that vertex.

A marker does not render as a normal graphical element but is only used to decorate the vertices of its referencing marked elements. A marker is owned by the canvas and can be referenced by marked elements in three possible ways: as a start marker, an end marker, or a mid marker (see “Marker [Class]” on page 35 for more details). The styles of marked elements cascade to their referenced markers in each case. A marker can still define its own style overrides.

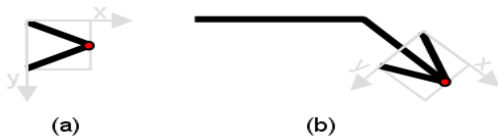

Figure 10.12 - Marker example: a) an arrowhead marker with its reference point in red b) the marker positioned at the end vertex of a polyline and rotated to match the rotation at that vertex

Diagrams

- Figure 10.3 (Primitive Elements)
- Figure 10.4 (Group Elements)

Generalizations

- Group [Class]

Attributes

- size : Dimension [1] - the size of the marker
- reference : Point [1] - a point within the bounds of the marker that aligns exactly with the marked element’s vertex.

Association Ends

- canvas : Canvas [1] - a reference to the canvas that owns this marker.

10.3.19 Matrix [DataType]

Matrix is a kind of transform that represents any transform operation with a 3x3 transformation matrix.

Description

Matrix is a kind of transform that represents any transform operation with a 3x3 transformation matrix of the form shown in Figure 10.13. Since only six values are used in this 3x3 matrix, a matrix is also expressed as a vector [a b c d e f].

$$\begin{bmatrix} a & c & e \\ b & d & f \\ 0 & 0 & 1 \end{bmatrix}$$

Figure 10.13 - Transform Matrix

Transformation matrix map coordinates and lengths from a new coordinate system into a previous coordinate system, as shown in Figure 10.14.

$$\begin{bmatrix} X_{\text{prevCoordSys}} \\ Y_{\text{prevCoordSys}} \\ 1 \end{bmatrix} = \begin{bmatrix} a & c & e \\ b & d & f \\ 0 & 0 & 1 \end{bmatrix} \cdot \begin{bmatrix} X_{\text{newCoordSys}} \\ Y_{\text{newCoordSys}} \\ 1 \end{bmatrix}$$

Figure 10.14 - Transform Matrix Multiplication

Diagrams

- Figure 10.7 (Transforms)

Generalizations

- Transform [Abstract DataType]

Attributes

- a : Real [1] - the a value of the transform matrix.
- b : Real [1] - the b value of the transform matrix.
- c : Real [1] - the c value of the transform matrix.
- d : Real [1] - the d value of the transform matrix.
- e : Real [1] - the e value of the transform matrix.
- f : Real [1] - the f value of the transform matrix.

10.3.20 MoveTo [DataType]

MoveTo is a kind of path command that establishes a new current point in the coordinate system.

Description

MoveTo is a kind of path command that establishes a new current point. The effect is as if a pen was lifted and moved to a new location. A MoveTo command is always the first command in a path (in which case the new point is considered absolute regardless of the value of the isRelative flag). Subsequent MoveTo commands (i.e., when it is not the first command) represent the start of new subpaths (e.g., a doughnut shape consists of two subpaths, one for the outer circle and one for the inner circle).

Diagrams

- Figure 10.8 (Path Commands)

Generalizations

- PathCommand [Abstract DataType]

Attributes

- point : Point [1] - a point to move to in the coordinate system.

10.3.21 Path [Class]

Path is a marked element that defines a custom shape whose geometry is specified with a sequence of path commands.

Description

Path is a marked element that renders as a custom shape whose geometry is specified with a sequence of path commands. A path command is an instruction to manipulate (move or press) a drawing pen on the canvas in a specific way. The sequence of pen instructions builds the outline of the custom shape and always starts with a MoveTo command to position the drawing pen at the start position. Multiple MoveTo commands may appear in the sequence effectively defining subpaths.

An example of a path element that draws a triangle is:

- MoveTo (50, 0) LineTo (0, 50)
- LineTo (100, 50)
- ClosePath

Diagrams

- Figure 10.3 (Primitive Elements)

Generalizations

Issue: 18675 – MarkedElement should be abstract in provided CMOF files

- MarkedElement [Abstract Class]

Attributes

- command : PathCommand [*] {ordered, nonunique} - a list of path commands that define the geometry of the custom shape.

10.3.22 PathCommand [Abstract DataType]

PathCommand is the abstract super type of all commands that participate in specifying a path element.

Description

PathCommand represents a command that participates in defining the geometry of a path element. It is the abstract super class of all path commands. The coordinates specified by a path command are either relative to the current point before the command or absolute (relative to the origin point of the coordinate system) based on the truth value of the isRelative flag.

Diagrams

- Figure 10.8 (Path Commands)

Specializations

- ClosePath [DataType]
- EllipticalArcTo [DataType]
- MoveTo [DataType]
- CubicCurveTo [DataType]
- QuadraticCurveTo [DataType]
- LineTo [DataType]

Attributes

- isRelative : Boolean [1] = false
whether the coordinates specified by the command are relative to the current point (when true) or to the origin point of the coordinate system (when false).

10.3.23 Pattern [Class]

Pattern is a kind of fill that paints a graphical element (a tile) repeatedly at fixed intervals in x and y axes to cover the areas to be filled.

Description

Pattern is a kind of fill that paints a graphical element (a tile) repeatedly inside a filled area at a fixed interval along the x and y axes. The interval is defined by the bounds of the pattern, which establishes its own private coordinate system for the pattern's tile to be relative to. The bounds of the pattern also define a rectangular clipping region for the tile restricting it from painting outside.

A pattern's tile does not render on its own as a normal graphical element but is only painted repeatedly within the pattern to fill enclosed areas of graphical elements. The styles of those graphical elements cascade to the pattern tiles in each case. A tile can still define its own style overrides.

Diagrams

- Figure 10.6 (Fills)

Generalizations

- Fill [Abstract Class]

Attributes

- bounds : Bounds [1] - the bounds of the pattern that define a private coordinate system for the pattern's tile.

Association Ends

- ♦ tile : GraphicalElement [1] - a reference to a graphical element, owned by the pattern, that works as a tile to be painted repeatedly at a fixed interval to fill a closed area.

10.3.24 Polygon [Class]

Polygon is a marked element that defines a closed shape consisting of a sequence of connected straight line segments.

Description

Polygon is a marked element that renders a closed shape consisting of a sequence of straight line segments defined by a list of three or more points in the x-y coordinate system. The sequence results in a closed shape as a last line is automatically defined from the last point to the first point.

Diagrams

- Figure 10.3 (Primitive Elements)

Generalizations

Issue: 18675 – MarkedElement should be abstract in provided CMOF files

- MarkedElement [Abstract Class]

Attributes

- point : Point [3..*] {ordered, nonunique} - a list of 3 or more points making up the polygon.

10.3.25 Polyline [Class]

Polyline is a marked element that defines a shape consisting of a sequence of connected straight line segments.

Description

Polyline is a marked element that renders a shape consisting of a sequence of straight line segments defined by a list of two or more points in the x-y coordinate system.

Diagrams

- Figure 10.3 (Primitive Elements)

Generalizations

Issue: 18675 – MarkedElement should be abstract in provided CMOF files

- MarkedElement [Abstract Class]

Attributes

- point : Point [2..*] {ordered, nonunique} - a list of 2 or more points making up the polyline.

10.3.26 QuadraticCurveTo [DataType]

QuadraticCurveTo is a kind of path command that draws a quadratic bézier curve from the current point to a new point using a single control point.

Description

QuadraticCurveTo is a kind of path command that draws a quadratic bézier curve from the current point to a new point using a single control point. Multiple QuadraticCurveTo commands may be specified in a row to draw a polybézier. At the end of the command, the provided point becomes the new current point in the coordinate system. An example of a quadratic bézier curve is shown in Figure 10.15.

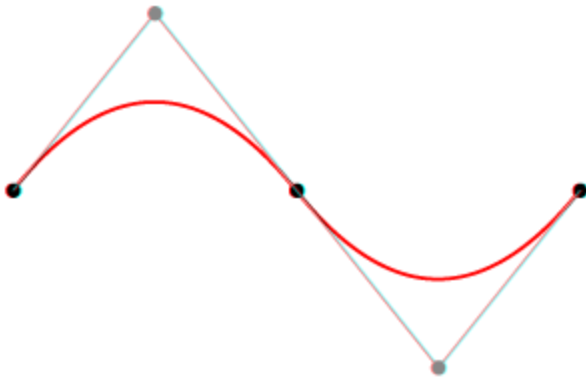

Figure 10.15 - Example of quadratic bézier curve

Diagrams

- Figure 10.8 (Path Commands)

Generalizations

- PathCommand [Abstract DataType]

Attributes

- point : Point [1] - a point to draw a quadratic bézier curve to/from the current point in the coordinate system.
- control : Point [1] - the control point of the quadratic bézier curve.

10.3.27 RadialGradient [Class]

RadialGradient is a kind of gradient that fills a graphical element by smoothly changing color values in a circle.

Description

RadialGradient is a kind of gradient that fills a graphical element by smoothly changing color values between gradient stops in a circle. The change occurs from a focus point in the circle (which does not have to be at the center) to its outside radius. The center point of the circle and its radius define the largest (outer most) circle for the gradient, while the focus point defines the smallest (inner most) circle.

The center point and focus point are expressed with a ratio, centerX, and focusX of the width of the graphical element and a ratio, centerY, and focusY of the height of the graphical element. The radius is expressed as a ratio of the size (width and height) of the graphical element.

Diagrams

- Figure 10.6 (Fills)

Generalizations

- Gradient [Abstract Class]

Attributes

- centerX : Real [1] = 0.5 - a real number (≥ 0 and ≤ 1) representing a ratio of the graphical element's width that is the x center point of the gradient.
- centerY : Real [1] = 0.5 - a real number (≥ 0 and ≤ 1) representing a ratio of the graphical element's width that is the y center point of the gradient.
- radius : Real [1] = 0.5 - a real number (≥ 0 and ≤ 1) representing a ratio of the graphical element's size that is the radius of the gradient.
- focusX : Real [1] = 0.5 - a real number (≥ 0 and ≤ 1) representing a ratio of the graphical element's width that is the x focus point of the gradient.
- focusY : Real [1] = 0.5 - a real number (≥ 0 and ≤ 1) representing a ratio of the graphical element's width that is the y focus point of the gradient.

Constraints

- valid_center_point: the center point coordinates must be between 0 and 1
[OCL] centerX ≥ 0 and centerX ≤ 1 and centerY ≥ 0 and centerY ≤ 1
- valid_focus_point: the focus point coordinates must be between 0 and 1
[OCL] focusX ≥ 0 and focusX ≤ 1 and focusY ≥ 0 and focusY ≤ 1
- valid_radius: the radius must be between 0 and 1
[OCL] radius ≥ 0 and radius ≤ 1

10.3.28 Rectangle [Class]

Rectangle is a graphical element that defines a rectangular shape with given bounds. A rectangle may be given rounded corners by setting its corner radius.

Description

Rectangle is a graphical element that renders as a rectangle shape with given bounds in the x-y coordinate system. A rectangle may have rounded corners by specifying a radius for its corners. A radius of 0 specifies a regular rectangle with sharp corners.

Diagrams

- Figure 10.3 (Primitive Elements)

Generalizations

- GraphicalElement [Abstract Class]

Attributes

- bounds : Bounds [1] - the bounds of the rectangle in the x-y coordinate system.
- cornerRadius : Real [1] = 0 - a radius for the rectangle's rounded corners. When the radius is 0, the rectangle is drawn

with sharp corners.

10.3.29 Rotate [DataType]

Rotate is a kind of transform that rotates a graphical element by a given angle about a given center point in the x-y coordinate system.

Description

Rotate is a kind of transform that rotates a graphical element by a given angle (in degrees) about a given center point in the x-y coordinate system. The center point is optional and when not specified, it is considered to be the origin (0,0) point of the x-y coordinate system. Rotate is equivalent to the Matrix transform $[\cos(\text{angle}) \sin(\text{angle}) -\sin(\text{angle}) \cos(\text{angle}) 0 0]$ around the origin (see “MoveTo [DataType]” on page 37).

Diagrams

- Figure 10.7 (Transforms)

Generalizations

- Transform [Abstract DataType]

Attributes

- angle : Real [1] - a real number representing the angle (in degrees) of rotation. Both positive (clock-wise) and negative (counter-clock-wise) values are allowed.
- center : Point [0..1] - a point in the x-y coordinate system about which the rotation is performed. If the point is not specified, it is assumed to be the origin of the x-y coordinate system.

10.3.30 Scale [DataType]

Scale is a kind of transform that scales (resizes) a graphical element by a given factor in the x-y coordinate system.

Description

Scale is a kind of transform that resizes a graphical element by a given scaling factor along the x and y axes. Scale is equivalent to the Matrix transform $[\text{factorX} 0 0 \text{factorY} 0 0]$ (see “MoveTo [DataType]” on page 37).

Diagrams

- Figure 10.7 (Transforms)

Generalizations

- Transform [Abstract DataType]

Attributes

- factorX : Real [1] - a real number (≥ 0) representing a scale factor along the x-axis.
- factorY : Real [1] - a real number (≥ 0) representing a scale factor along the y-axis.

Constraints

- non-negative-scale: scale factors cannot be negative.
[OCL] $\text{factorX} \geq 0$ and $\text{factorY} \geq 0$

10.3.31 Skew [DataType]

Skew is a kind of transform that skews (deforms) a graphical element by given angles in the x-y coordinate system.

Description

Skew is a kind of transform that skews a graphical element by two angles (in degrees) along the x axis and the y axis. Skew is equivalent to the Matrix transform $[1 \tan(\text{angleY}) \tan(\text{angleX}) 1 0 0]$ (see “MoveTo [DataType]” on page 37).

Diagrams

- Figure 10.7 (Transforms)

Generalizations

- Transform [Abstract DataType]

Attributes

- `angleX` : Real [1] - a real number representing the angle (in degrees) of skew along the x-axis. Both positive (clock-wise) and negative (counter-clock-wise) values are allowed.
- `angleY` : Real [1] - a real number representing the angle (in degrees) of skew along the y-axis. Both positive (clock-wise) and negative (counter-clock-wise) values are allowed.

10.3.32 Style [Class]

Style contains formatting properties that affect the appearance or style of graphical elements.

Description

Style represents a bag of properties (e.g., `fontName`, `fillColor`, or `strokeWidth`) that affect the appearance or style of graphical elements rather than their geometry. A style can either be local to (owned by) a graphical element or shared between (referenced by) several graphical elements (e.g., all UML dependency connectors have dashed lines), in which case it is packaged by the canvas. Shared styles help reduce the footprint of graphical models. A value set to a local style property overrides one that is set to the same property on a shared style referenced by the same graphical element.

Style properties are typically defined as optional to allow the state of “unset” to be legal. This is needed to implement cascading styles, where an unset style property in one graphical element gets its value from the closest graphical element in its group chain that has a value set for that property.

The above semantics effectively specify that a value for a style property is based on the following mechanisms (in order of precedence):

- If there is a cascading value set on a local style, use it. If the same value is set by multiple local styles, then use the value earlier in the style ordering.
- Otherwise, if there is cascading value set on a shared style, use it. If the same value is set by multiple shared styles, then use the value earlier in the style ordering.

- Otherwise, if a cascading value is available from a graphical element in the group chain, use it from the closest group.
- Otherwise, use the style property's default value.

Diagrams

- Figure 10.2 (Graphical Element)
- Figure 10.4 (Group Elements)
- Figure 10.5 (Style)

Attributes

- **fillColor** : Color [0..1] - a color that is used to paint the enclosed regions of graphical element. A fillColor value is exclusive with a fill value. If both are specified, the fill value is used. If none is specified, no fill is applied (i.e., the element becomes see-through).
- **fillOpacity** : Real [0..1] - a real number (≥ 0 and ≤ 1) representing the opacity of the fill or fillColor used to paint a graphical element. A value of 0 means totally transparent, while a value of 1 means totally opaque. The default is 1.
- **strokeWidth** : Real [0..1] - a real number (≥ 0) representing the width of the stroke used to paint the outline of a graphical element. A value of 0 specifies no stroke is painted. The default is 1.
- **strokeOpacity** : Real [0..1] - a real number (≥ 0 and ≤ 1) representing the opacity of the stroke used for a graphical element. A value of 0 means totally transparent, while a value of 1 means totally opaque. The default is 1.
- **strokeColor** : Color [0..1] - the color of the stroke used to paint the outline of a graphical element. The default is black (red=0, green=0, blue=0).
- **strokeDashLength** : Real [*] {ordered, nonunique} - a list of real numbers specifying a pattern of alternating dash and gap lengths used in stroking the outline of a graphical element with the first one specifying a dash length. The size of the list is expected to be even. If the list is empty, the stroke is drawn solid. The default is empty list.
- **fontSize** : Real [0..1] - a real number (≥ 0) representing the size (in unit of length) of the font used to render a text element. The default is 10.
- **fontName** : String [0..1] - the name of the font used to render a text element (e.g., "Times New Roman," "Arial," or "Helvetica"). The default is "Arial."
- **fontColor** : Color [0..1] - the color of the font used to render a text element. The default is black (red=0, green=0, blue=0).
- **fontItalic** : Boolean [0..1] - whether the font used to render a text element has an italic style. The default is false.
- **fontBold** : Boolean [0..1] - whether the font used to render a text element has a bold style. The default is false.
- **fontUnderline** : Boolean [0..1] - whether the font used to render a text element has an underline style. The default is false.
- **fontStrikeThrough** : Boolean [0..1] - whether the font used to render a text element has a strike-through style. The default is false.

Association Ends

- **fill** : Fill [0..1] - a reference to a fill that is used to paint the enclosed regions of a graphical element. A fill value is

exclusive with a fillColor value. If both are specified, the fill value is used. If none is specified, no fill is applied (i.e., the element becomes see-through).

Constraints

- valid_font_size: the font size is non-negative.
[OCL] `fontSize >= 0`
- valid_fill_opacity: the stroke width is non-negative.
[OCL] `fillOpacity >= 0 and fillOpacity <=1`
- valid_stroke_width: the stroke width is non-negative.
[OCL] `strokeWidth >= 0`
- valid_dash_length_size: the size of the stroke dash length list must be even.
[OCL] `strokeDashLength->size().mod(2) = 0`
- valid_stroke_opacity: the opacity of the fill is non-negative.
[OCL] `strokeOpacity >= 0 and strokeOpacity <=1`

10.3.33 Text [Class]

Text is a graphical element that defines a shape that renders a character string within a bounding box.

Description

Text is a graphical element that renders a given sequence of characters within a bounding box. This means the text could be wrapped into multiple lines (at the edges of the box) and/or, if there is no extra room in the box, the remaining text is summarized with ellipses (...) at the end.

The text lines are rendered along the width (x-axis) of the bounding box according to the chosen alignment option, as follows:

- Alignment::start: the text lines' start edges are aligned with the start edge of the bounding box.
- Alignment::end: the text lines' end edges are aligned with the end edge of the bounding box.
- Alignment::center: the text lines' centers are aligned with the center of the bounding box.

Diagrams

- Figure 10.3 (Primitive Elements)

Generalizations

- GraphicalElement [Abstract Class]

Attributes

- data : String [1] - the text as a string of characters.
- bounds : Bounds [1] - the bounds inside which the text is rendered (possibly wrapped into multiple lines).
- alignment : AlignmentKind [1] - the text alignment when wrapped into multiple lines.

10.3.34 Transform [Abstract DataType]

Transform defines an operation that changes the geometry of a graphical element in a specific way.

Description

Transform is an operation that changes the geometry of a graphical element in a specific way. When a transform is applied to a non-group element, it changes the coordinates and lengths defined on that element. When it is applied to a group element, the transform is applied to each member of the group.

Diagrams

- Figure 10.7 (Transforms)

Specializations

- Matrix [DataType]
- Rotate [DataType]
- Skew [DataType]
- Translate [DataType]
- Scale [DataType]

10.3.35 Translate [DataType]

Translate is a kind of transform that translates (moves) a graphical element by a given delta along the x-y coordinate system.

Description

Translate is a kind of transform that moves a graphical element by a given delta (deltaX, deltaY) along the x-y axes. Translate is equivalent to the Matrix transform $[1 \ 0 \ 0 \ 1 \ \text{deltaX} \ \text{deltaY}]$ (see “MoveTo [DataType]” on page 37).

Diagrams

- Figure 10.7 (Transforms)

Generalizations

- Transform [Abstract DataType]

Attributes

- `deltaX` : Real [1] - a real number representing a translate delta along the x-axis. Both positive and negative values are allowed.
- `deltaY` : Real [1] - a real number representing a translate delta along the y-axis. Both positive and negative values are allowed.

Annex A: UML Class Diagram Definition Example

(Informative)

This annex provides an example of using the DD specification to define a small subset of the UML class diagram. Sub clause A.1 gives the UML DI metamodel as an extension of the DI metamodel. Sub clause A.2 gives the mapping from this UML DI metamodel to the DG metamodel.

The UML class diagram is chosen due to its widespread use and familiarity. However, to control the scope, the example is limited to representative subset of class diagram elements consisting of three classifiers (Class, Interface, and DataType) and three relations (Association, Generalization, and InterfaceRealization). This subset exemplifies the notation of shapes (with labels, compartments, and alternative notation) and edges (with labels, markers, and line styles) of the class diagram.

Note – This example is adapted from the following paper:

Elaasar, M., and Labiche, Y., “Diagram Definition: a Case Study with the UML Class Diagram”, ACM/IEEE 14th International Conference on Model Driven Engineering Languages and Systems (MODELS), October 2011.

A.1 UML DI

Some design principles used in this example are:

- Avoid interchanging notational information that can be derived from the UML model to minimize redundancy between the DI and UML models.
- Interchange simple layout constraints (bounds for all shapes/labels and waypoints for all edges) and avoid constraints of more complex layout algorithms to make it easier for tools to map to/from their native layouts.
- Interchange the overlapping order of sibling diagram elements (which can happen when a diagram is crowded) by making all nested element collections ordered (a higher index implies a higher overlap order).
- Avoid interchanging purely stylistic properties (e.g., colors/fonts) that tools may give users control over since they may vary dramatically between tools. However, we made an exception to some font properties (e.g., name and size) that we suspected could affect layout.
- Keep the DI class hierarchy small, thus easier to maintain and evolve, by avoiding extensive sub-classing (resembling the UML class hierarchy). Instead, we allow DI classes to have a mixed bag of optional properties that apply in specific UML contexts only.

The UML DI metamodel (Figure A.1) extends the DI metamodel, where appropriate, using metamodel extension semantics (subclassing and property subsetting and redefinition). Specifically, the class *UMLDiagram* composes a collection of elements of type *UMLDiagramElement*. The latter optionally references an element from a UML model and can be styled with instances of class *UMLStyle*, which has two properties: *fontName* and *fontSize*.

Issue: 16628 – DiagramElements cannot represent multiple model Elements

Note – When DI is used for metamodels other than UML's, the *modelElement* property can be redefined even though the

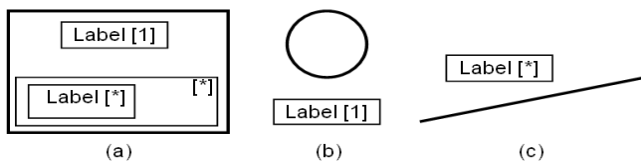

Figure A.2 - UML DI Notational Patterns

A.2 Mapping UML DI to DG using QVT Operational

Recall from Clause 7 that a modeling language can specify its concrete graphical syntax as a mapping from its DI metamodel, which references its abstract syntax metamodel, to the DG metamodel. The mapping can be expressed using any suitable mapping language. This example expresses the mapping using the QVT Operational (QVTO) transformation language (for brevity, only selected parts of the transformation are shown). QVTO is a standard language and has an available implementation (on Eclipse). This assumes reader's familiarity with QVTO, OCL, and the UML 2.x metamodel.

The UML class diagram's concrete syntax is defined with a QVTO transformation (Figure A.3) from the UML DI metamodel (Sub clause A.1) to the DG metamodel. The transformation starts by looking for all instances of *UMLDiagram* and initiating the mapping for them (lines 2-4). Mappings (like operations) are defined on UML DI classes and have DG classes as return types. For example, a mapping named *toGraphics* is defined on the class *UMLDI::UMLDiagram* and has *DG::Canvas* as a return type (line 5). This maps an instance of *UMLDiagram* to an instance of *Canvas*, and initializes the properties of the latter according to the body of the mapping. In this case, the body iterates on all the owned elements of the diagram, mapping each one in turn to graphics, and adding the resulting graphical elements as members of the canvas (line 6).

Furthermore, a *UMLShape* maps to a *Group* (lines 12-17) consisting of the following: a graphic for the model element (line 14), a graphic for the owned label (line 15) and a graphic for each owned compartment (line 16). These graphics are produced by other nested mappings (defined later). A similar mapping is defined for *UMLEdge* (lines 18-22). However, the mapping for *UMLCompartment* (lines 23-26) is different as the first member graphic is fixed as a *Rectangle* whose bounds are defined by the compartment. The mapping for *UMLLabel* (lines 27-40) is also different as it maps to a *Text* whose bounds are defined by the label and whose data value is defined based on the label's kind. For example, if the kind is *signature*, the value is defined by a query *getSignature* defined on *UML::NamedElement* (line 33-34). Also notice how the mapping inherits (line 28) another mapping (lines 8-11) that copies over the local and shared styles. Another local style is added (line 39) based on the label's model element (e.g., the *fontItalic* property is set to true for the *signature* label in the case of an abstract classifier).

Some of the queries used for the label mapping are shown in Figure A.4. The *getSignature* query (lines 1-3) returns the (simple or qualified) name of an element based on a flag. The query is overridden for different UML types to specify their unique signatures. For example, *UML::Interface* (lines 4-6) overrides it to prefix the name with the «Interface» keyword. *UML::Property* (lines 12-17) overrides it to return the full signature of a property in an attribute compartment (with type, multiplicity, etc.).

Figure A.5 shows mappings between UML classifiers and their corresponding graphical elements (e.g., box or ball notation). The first mapping (lines 1-3), defined on *UML::Element*, delegates to other mappings depending on the type of the element. Notice that both *UML::Class* (lines 4-6) and *UML::DataType* (lines 7-9) have one mapping each creating a rectangle, while *UML::Interface* has two mappings, one creating a *DG::Rectangle* (lines 10-13) and the other creating a *DG::Circle* (lines 14-20), based on the flag *showClassifierShape* (lines 11, 15) on *UMLShape*.

Figure A.6 shows mappings between UML relations and poly lines. The first mapping (lines 10-13), defined on *UML::Element*, delegates to other mappings depending on the type of the element. The mapping of relation *UML::InterfaceRealization* (lines 14-19) copies the edge's waypoints to the poly line's points (line 15). As the notation of this relation depends on whether the interface shape was shown as a box or a ball, this is checked first (line 16). If it is shown as a box, a shared style with a dash pattern (lines 1-2) and a closed arrow marker (lines 3-9) are used (lines 17-18).

```

01  transformation UMLDIToDG(in umldi : UMLDI, out DG);
02  main() {
03      umldi.objectsOfType(UMLDiagram)->map toGraphics();
04  }
05  mapping UMLDiagram::toGraphics() : Canvas {
06      member += self.ownedElement->map toGraphics();
07  }
08  mapping UMLDiagramElement::toGraphics() : Group {
09      localStyle := copyStyle(self.localStyle);
10      sharedStyle := copyStyle(self.sharedStyle);
11  }
12  mapping UMLShape::toGraphics() : Group
13      inherits UMLDiagramElement::toGraphics {
14      member += self.modelElement.map toGraphics(self);
15      member += self.ownedLabel.map toGraphics ();
16      member += self.ownedCompartment->map toGraphics ();
17  }
18  mapping UMLEdge::toGraphics() : Group
19      inherits UMLDiagramElement::toGraphics {
20      member += self.modelElement.map toGraphics(self);
21      member += self.ownedElement->map toGraphics ();
22  }
23  mapping UMLCompartment::toGraphics() : Group {
24      member += object Rectangle {bounds := self.bounds};
25      member += self.ownedElement->map toGraphics ();
26  }
27  mapping UMLLabel::toGraphics () : Text
28      inherits UMLDiagramElement::toGraphics {
29      var e := self.modelElement;
30      var q := self.showQualified;
31      bounds := self.bounds;
32      data := switch {
33          case (self.kind = LabelKind::signature)
34              e.oclassType(NamedElement).getSignature(q);
35          case (self.kind = LabelKind::role)
36              e.oclassType(Property).getRole();
37          ...
38      };
39      localStyle += e.map toStyle(self);
40  }

```

Figure A.3 - QVTO Mapping from UML D to DG

```

01 query NamedElement::getSignature(q : Boolean) : String {
02     return self.getName(q);
03 }
04 query Interface::getSignature(q : Boolean) : String {
05     return «Interface»\n" + self.getName(q);
06 }
07 query Property::getSignature(q : Boolean) : String {
08     var t := if self.type->notEmpty() then ":" +
09             self.type.getSignature(q) else "" endif;
10     return self.getRole()+ t + self.getAdornment();
11 }
12 query Property::getRole() : String {
13     var d := if self.isDerived then "/" else "" endif;
14     var v := if self.visibility = VisibilityKind::public
15             then "+" else ... endif;
16     return d + v + self.getName(false);
17 }
18 query NamedElement::getName(q : Boolean) : String {
19     return if q then self.qualifiedName
20             else self.name endif;
21 }
22 query Property::getAdornment() : String {
23     return "{" + ... + "}";
24 }

```

Figure A.4 - Queries used by the UML Label Mapping

```

01 mapping Element::toGraphics(s:UMLShape):GraphicalElement
02     disjuncts Interface::toRectangle, Interface::toCircle,
03             Class::toRectangle, DataType::toRectangle {}
04 mapping Class::toRectangle (s:UMLShape) : Rectangle {
05     bounds := s.bounds;
06 }
07 mapping DataType::toRectangle (s:UMLShape) : Rectangle {
08     bounds := s.bounds;
09 }
10 mapping Interface::toRectangle (s:UMLShape) : Rectangle
11     when { s.showClassifierShape=true } {
12     bounds := s.bounds;
13 }
14 mapping Interface::toCircle (s:UMLShape) : Circle
15     when { s.showClassifierShape=false } {
16     var b := s.bounds;
17     center := object Point{b.x+b.width/2;b.y+b.height/2};
18     radius := if b.width<b.height then b.width/2
19             else b.height/2 endif;
20 }

```

Figure A.5 - UML Classifier Mapping to Graphics

```

01  property interfaceRealStyle = object DG::Style {
02      strokeDashLength := Sequence {2, 2} };
03  property interfaceRealMarker = object Marker {
04      size := object Dimension {width := 10; height := 10};
05      reference := object Point {x := 10; y := 5};
06      member += object Polylygon {
07          point += object Point{ x:=0; y:=0 };
08          point += object Point{ x:=10; y:=5 };
09          point += object Point{ x:=0; y:=10 }; }; };
10  mapping Element::toGraphics(e:UMLEdge):GraphicalElement
11      disjuncts Association::toPolyline,
12          Generalization::toPolyline,
13          InterfaceRealization::toPolyline {}
14  mapping InterfaceRealization::toPolyline(e:UMLEdge):Polyline{
15      point := e.waypoint;
16      var s = e.target.showClassifierShape;
17      sharedStyle := if s then interfaceRealStyle endif;
18      endMarker := if s then interfaceRealMarker endif;
19  }

```

Figure A.6 - UML Relation Mapping to Graphics