



Common Object Request Broker Architecture (CORBA) Specification, Version 3.3

Part 2: CORBA Interoperability

OMG Document Number: formal/2012-03-03

Standard document URL: <http://www.omg.org/spec/CORBA/3.3/Interoperability/PDF>

Copyright © 1997-2001 Electronic Data Systems Corporation
Copyright © 1997-2001 Hewlett-Packard Company
Copyright © 1997-2001 IBM Corporation
Copyright © 1997-2001 ICON Computing
Copyright © 1997-2001 i-Logix
Copyright © 1997-2001 IntelliCorp
Copyright © 2007, IONA Technologies, PLC
Copyright © 1997-2001 Microsoft Corporation
Copyright © 2011-2012 Object Management Group
Copyright © 1997-2001 ObjecTime Limited
Copyright © 1997-2001 Oracle Corporation
Copyright © 1997-2001 Platinum Technology, Inc.
Copyright © 1997-2001 Ptech Inc.
Copyright © 1997-2001 Rational Software Corporation
Copyright © 1997-2001 Reich Technologies
Copyright © 2007-2012 Remedy IT
Copyright © 1997-2001 Softeam
Copyright © 1997-2001 Sterling Software
Copyright © 1997-2001 Taskon A/S
Copyright © 2008-2009, Telefónica Investigación y Desarrollo S.A.Unipersonal
Copyright © 1997-2001 Unisys Corporation

Use of Specification - Terms, Conditions & Notices

The material in this document details an Object Management Group specification in accordance with the terms, conditions and notices set forth below. This document does not represent a commitment to implement any portion of this International Standard in any company's products. The information contained in this document is subject to change without notice.

Licenses

The companies listed above have granted to the Object Management Group, Inc. (OMG) a nonexclusive, royalty-free, paid up, worldwide license to copy and distribute this document and to modify this document and distribute copies of the modified version. Each of the copyright holders listed above has agreed that no person shall be deemed to have infringed the copyright in the included material of any such copyright holder by reason of having used the specification set forth herein or having conformed any computer software to the specification.

Subject to all of the terms and conditions below, the owners of the copyright in this International Standard hereby grant you a fully-paid up, non-exclusive, nontransferable, perpetual, worldwide license (without the right to sublicense), to use this International Standard to create and distribute software and special purpose specifications that are based upon this International Standard, and to use, copy, and distribute this International Standard as provided under the Copyright Act; provided that: (1) both the copyright notice identified above and this permission notice appear on any copies of this International Standard; (2) the use of the specifications is for informational purposes and will not be copied or posted on any network computer or broadcast in any media and will not be otherwise resold or transferred for commercial purposes; and (3) no modifications are made to this International Standard. This limited permission automatically terminates without notice if you breach any of these terms or conditions. Upon termination, you will destroy immediately any copies of the specifications in your possession or control.

Patents

The attention of adopters is directed to the possibility that compliance with or adoption of OMG specifications may require use of an invention covered by patent rights. OMG shall not be responsible for identifying patents for which a license may be required by any OMG specification, or for conducting legal inquiries into the legal validity or scope of those patents that are brought to its attention. OMG specifications are prospective and advisory only. Prospective users are responsible for protecting themselves against liability for infringement of patents.

General Use Restrictions

Any unauthorized use of this International Standard may violate copyright laws, trademark laws, and communications regulations and statutes. This document contains information which is protected by copyright. All Rights Reserved. No part of this work covered by copyright herein may be reproduced or used in any form or by any means--graphic, electronic, or mechanical, including photocopying, recording, taping, or information storage and retrieval systems--without permission of the copyright owner.

Disclaimer Of Warranty

WHILE THIS PUBLICATION IS BELIEVED TO BE ACCURATE, IT IS PROVIDED "AS IS" AND MAY CONTAIN ERRORS OR MISPRINTS. THE OBJECT MANAGEMENT GROUP AND THE COMPANIES LISTED ABOVE MAKE NO WARRANTY OF ANY KIND, EXPRESS OR IMPLIED, WITH REGARD TO THIS PUBLICATION, INCLUDING BUT NOT LIMITED TO ANY WARRANTY OF TITLE OR OWNERSHIP, IMPLIED WARRANTY OF MERCHANTABILITY OR WARRANTY OF FITNESS FOR A PARTICULAR PURPOSE OR USE.

IN NO EVENT SHALL THE OBJECT MANAGEMENT GROUP OR ANY OF THE COMPANIES LISTED ABOVE BE LIABLE FOR ERRORS CONTAINED HEREIN OR FOR DIRECT, INDIRECT, INCIDENTAL, SPECIAL, CONSEQUENTIAL, RELIANCE OR COVER DAMAGES, INCLUDING LOSS OF PROFITS, REVENUE, DATA OR USE, INCURRED BY ANY USER OR ANY THIRD PARTY IN CONNECTION WITH THE FURNISHING, PERFORMANCE, OR USE OF THIS MATERIAL, EVEN IF ADVISED OF THE POSSIBILITY OF SUCH DAMAGES.

The entire risk as to the quality and performance of software developed using this International Standard is borne by you. This disclaimer of warranty constitutes an essential part of the license granted to you to use this International Standard.

Restricted Rights Legend

Use, duplication or disclosure by the U.S. Government is subject to the restrictions set forth in subparagraph (c) (1) (ii) of The Rights in Technical Data and Computer Software Clause at DFARS 252.227-7013 or in subparagraph (c)(1) and (2) of the Commercial Computer Software - Restricted Rights clauses at 48 C.F.R. 52.227-19 or as specified in 48 C.F.R. 227-7202-2 of the DoD F.A.R. Supplement and its successors, or as specified in 48 C.F.R. 12.212 of the Federal Acquisition Regulations and its successors, as applicable. The specification copyright owners are as indicated above and may be contacted through the Object Management Group, 140 Kendrick Street, Needham, MA 02494, U.S.A.

Trademarks

MDA®, Model Driven Architecture®, UML®, UML Cube logo®, OMG Logo®, CORBA® and XMI® are registered trademarks of the Object Management Group, Inc., and Object Management Group™, OMG™, Unified Modeling Language™, Model Driven Architecture Logo™, Model Driven Architecture Diagram™, CORBA logos™, XMI Logo™,

CWM™, CWM Logo™, IIOPT™, MOF™ and OMG Interface Definition Language (IDL)™, and Systems Modeling Language (SysML™) are trademarks of the Object Management Group. All other products or company names mentioned are used for identification purposes only, and may be trademarks of their respective owners.

Compliance

The copyright holders listed above acknowledge that the Object Management Group (acting itself or through its designees) is and shall at all times be the sole entity that may authorize developers, suppliers and sellers of computer software to use certification marks, trademarks or other special designations to indicate compliance with these materials.

Software developed under the terms of this license may claim compliance or conformance with this International Standard if and only if the software compliance is of a nature fully matching the applicable compliance points as stated in the specification. Software developed only partially matching the applicable compliance points may claim only that the software was based on this International Standard, but may not claim compliance or conformance with this International Standard. In the event that testing suites are implemented or approved by Object Management Group, Inc., software developed using this International Standard may claim compliance or conformance with the specification only if the software satisfactorily completes the testing suites.

OMG's Issue Reporting Procedure

All OMG specifications are subject to continuous review and improvement. As part of this process we encourage readers to report any ambiguities, inconsistencies, or inaccuracies they may find by completing the Issue Reporting Form listed on the main web page <http://www.omg.org>, under Documents, Report a Bug/Issue (<http://www.omg.org/technology/agreement.htm>).

Table of Contents

Preface	vii
1 Scope	1
2 Conformance and Compliance	1
2.1 Unreliable Multicast	2
2.2 GIOP Compression	2
3 Normative References	2
3.1 Identical Recommendations International Standards	2
3.2 Other Specifications	3
4 Terms and definitions	4
4.1 Recommendations International Standards	4
4.2 Terms Defined in this Standard	4
4.3 Keywords for Requirement statements	6
5 Symbols (and abbreviated terms)	6
6 Interoperability Overview	7
6.1 Elements of Interoperability	7
6.1.1 ORB Interoperability Architecture	7
6.1.2 Inter-ORB Bridge Support	7
6.1.3 General Inter-ORB Protocol (GIOP)	8
6.1.4 Internet Inter-ORB Protocol (IIOP) [®]	8
6.1.5 Environment-Specific Inter-ORB Protocols (ESIOPs)	9
6.2 Relationship to Previous Versions of CORBA	9
6.3 Examples of Interoperability Solutions	10
6.3.1 Example 1	10
6.3.2 Example 2	10
6.3.3 Example 3	10
6.3.4 Interoperability Compliance	10
6.4 Motivating Factors	13
6.4.1 ORB Implementation Diversity	13
6.4.2 ORB Boundaries	13
6.4.3 ORBs Vary in Scope, Distance, and Lifetime	13
6.5 Interoperability Design Goals	14
6.5.1 Non-Goals	14
7 ORB Interoperability Architecture	15
7.1 Overview	15
7.1.1 Domains	15

7.1.2 Bridging Domains	15
7.2 ORBs and ORB Services	16
7.2.1 The Nature of ORB Services	16
7.2.2 ORB Services and Object Requests	16
7.2.3 Selection of ORB Services	17
7.3 Domains	17
7.3.1 Definition of a Domain	18
7.3.2 Mapping Between Domains: Bridging	19
7.4 Interoperability Between ORBs	19
7.4.1 ORB Services and Domains	19
7.4.2 ORBs and Domains	20
7.4.3 Interoperability Approaches	20
7.4.4 Policy-Mediated Bridging	22
7.4.5 Configurations of Bridges in Networks	22
7.5 Object Addressing	23
7.5.1 Domain-relative Object Referencing	24
7.5.2 Handling of Referencing Between Domains	24
7.6 An Information Model for Object References	25
7.6.1 What Information Do Bridges Need?	25
7.6.2 Interoperable Object References: IORs	25
7.6.3 IOR Profiles	26
7.6.4 Standard IOR Profiles	28
7.6.5 IOR Components	29
7.6.6 Standard IOR Components	29
7.6.7 Profile and Component Composition in IORs	31
7.6.8 IOR Creation and Scope	32
7.6.9 Stringified Object References	32
7.6.10 Object URLs	33
7.7 Service Context	37
7.7.1 Standard Service Contexts	39
7.7.2 Service Context Processing Rules	40
7.8 Coder/Decoder Interfaces	40
7.8.1 Codec Interface	41
7.8.2 Codec Factory	42
7.9 Feature Support and GIOP Versions	43
7.10 Code Set Conversion	45
7.10.1 Character Processing Terminology	45
7.10.2 Code Set Conversion Framework	48
7.10.3 Mapping to Generic Character Environments	55
7.10.4 Example of Generic Environment Mapping	56
7.10.5 Relevant OSFM Registry Interfaces	57
8 Building Inter-ORB Bridges	63
8.1 Introduction	63
8.2 In-Line and Request-Level Bridging	63
8.2.1 In-line Bridging	64
8.2.2 Request-level Bridging	64
8.2.3 Collocated ORBs	65

8.3	Proxy Creation and Management	66
8.4	Interface-specific Bridges and Generic Bridges	66
8.5	Building Generic Request-Level Bridges	66
8.6	Bridging Non-Referencing Domains	67
8.7	Bootstrapping Bridges	68
9	General Inter-ORB Protocol	69
9.1	Goals of the General Inter-ORB Protocol	69
9.2	GIOP Overview	69
9.2.1	Common Data Representation (CDR)	70
9.2.2	GIOP Message Overview	70
9.2.3	GIOP Message Transfer	71
9.3	CDR Transfer Syntax	71
9.3.1	Primitive Types	72
9.3.2	OMG IDL Constructed Types	77
9.3.3	Encapsulation	79
9.3.4	Value Types	80
9.3.5	Pseudo-Object Types	87
9.3.6	Object References	93
9.3.7	Abstract Interfaces	93
9.4	GIOP Message Formats	93
9.4.1	GIOP Message Header	94
9.4.2	Request Message	96
9.4.3	Reply Message	99
9.4.4	CancelRequest Message	102
9.4.5	LocateRequest Message	103
9.4.6	LocateReply Message	104
9.4.7	CloseConnection Message	106
9.4.8	MessageError Message	106
9.4.9	Fragment Message	106
9.5	GIOP Message Transport	107
9.5.1	Connection Management	108
9.5.2	Message Ordering	109
9.6	Object Location	110
9.7	Internet Inter-ORB Protocol (IIOP)	111
9.7.1	TCP/IP Connection Usage	111
9.7.2	IIOP IOR Profiles	112
9.7.3	IIOP IOR Profile Components	114
9.8	Bi-Directional GIOP	115
9.8.1	Bi-directional IIOP	117
9.9	Bi-directional GIOP policy	118
9.10	OMG IDL	119
9.10.1	GIOP Module	119
9.10.2	IIOP Module	123
9.10.3	BiDirPolicy Module	124
10	Secure Interoperability	125
10.1	Overview	125

10.1.1 Assumptions	126
10.2 Protocol Message Definitions	127
10.2.1 The Security Attribute Service Context Element	127
10.2.2 SAS context_data Message Body Types	127
10.2.3 Authorization Token Format	131
10.2.4 Client Authentication Token Format	133
10.2.5 Identity Token Format	135
10.2.6 Principal Names and Distinguished Names	136
10.3 Security Attribute Service Protocol	137
10.3.1 Compound Mechanisms	137
10.3.2 Session Semantics	141
10.3.3 TSS State Machine	142
10.3.4 CSS State Machine	145
10.3.5 ContextError Values and Exceptions	148
10.4 Transport Security Mechanisms	149
10.4.1 Transport Layer Interoperability	149
10.4.2 Transport Mechanism Configuration	149
10.5 Interoperable Object References	150
10.5.1 Target Security Configuration	150
10.5.2 Client-side Mechanism Selection	158
10.5.3 Client-Side Requirements and Location Binding	160
10.5.4 Server Side Consideration	160
10.6 Conformance Levels	160
10.6.1 Conformance Level 0	160
10.6.2 Conformance Level 1	161
10.6.3 Conformance Level 2	162
10.6.4 Stateful Conformance	162
10.7 Sample Message Flows and Scenarios	162
10.7.1 Confidentiality, Trust in Server, and Trust in Client Established in the Connection	163
10.7.2 Confidentiality and Trust in Server Established in the Connection - Stateless Trust in Client Established in Service Context	165
10.7.3 Confidentiality, Trust in Server, and Trust in Client Established in the Connection Stateless Trust Association Established in Service Context	167
10.7.4 Confidentiality, Trust in Server, and Trust in Client Established in the Connection - Stateless Forward Trust Association Established in Service Context	170
10.8 References	171
10.9 IDL	172
10.9.1 Module GSSUP - Username/Password GSSAPI Token Formats	172
10.9.2 Module CSI - Common Secure Interoperability	173
10.9.3 Module CSIIOP - CSIV2 IOR Component Tag Definitions	177
11 Unreliable Multicast Inter-ORB Protocol	181
11.1 Introduction	181
11.1.1 Purpose	181
11.1.2 MIOP Packet	181
11.1.3 Packet Collection	181
11.1.4 PacketHeader	182
11.1.5 Joining an IP/Multicast Group	183
11.1.6 Quality Of Service	184

11.1.7 Delivery Requirements	184
11.2 MIOP Object Model	184
11.2.1 Definition	184
11.2.2 Unreliable IP/Multicast Profile Body (UIPMC_ProfileBody)	185
11.2.3 Group IOR	187
11.2.4 Extending PortableServer::POA to include Group Operations	189
11.2.5 MIOP Gateway	192
11.2.6 Multicast Group Manager	192
11.2.7 MIOP URL	208
11.3 Request Issues	209
11.3.1 GIOP Request Message Compatibility	209
11.3.2 MIOP Request Efficiency	209
11.3.3 Client Use Cases	210
11.3.4 Server Use Cases	211
11.4 Consolidated IDL	211
11.4.1 OMG IDL	211
12 ZIOP Protocol	219
12.1 ZIOP Messages	219
12.2 ZIOP Message use	220
12.3 ZIOP Compression Policies	221
12.3.1 CompressionEnablingPolicy interface	221
12.3.2 CompressorIdLevelListPolicy interface	221
12.3.3 CompressionLowValuePolicy interface	221
12.3.4 CompressionMinRatioPolicy interface	221
12.4 Propagation of ZIOP Compression Policies	221
12.5 Consolodated IDL	221
 Annex A - IDL Tags and Exceptions	 223

Preface

About the Object Management Group

OMG

Founded in 1989, the Object Management Group, Inc. (OMG) is an open membership, not-for-profit computer industry standards consortium that produces and maintains computer industry specifications for interoperable, portable and reusable enterprise applications in distributed, heterogeneous environments. Membership includes Information Technology vendors, end users, government agencies and academia.

OMG member companies write, adopt, and maintain its specifications following a mature, open process. OMG's specifications implement the Model Driven Architecture® (MDA®), maximizing ROI through a full-lifecycle approach to enterprise integration that covers multiple operating systems, programming languages, middleware and networking infrastructures, and software development environments. OMG's specifications include: UML® (Unified Modeling Language™); CORBA® (Common Object Request Broker Architecture); CWM™ (Common Warehouse Metamodel); and industry-specific standards for dozens of vertical markets.

More information on the OMG is available at <http://www.omg.org>

OMG Specifications

As noted, OMG specifications address middleware, modeling, and vertical domain frameworks. A catalog of all OMG Specifications is available from the OMG website at:

http://www.omg.org/technology/documents/spec_catalog.htm

Specifications within the Catalog are organized by the following categories:

OMG Modeling Specifications

- UML
- MOF
- XMI
- CWM
- Profile specifications.

OMG Middleware Specifications

- CORBA/IIOP
- IDL/Language Mappings
- Specialized CORBA specifications
- CORBA Component Model (CCM)

Platform Specific Model and Interface Specifications

- CORBA services
- CORBA facilities
- OMG Domain specifications
- OMG Embedded Intelligence specifications
- OMG Security specifications.

All of OMG's formal specifications may be downloaded without charge from our website. (Products implementing OMG specifications are available from individual suppliers.) Copies of specifications, available in PostScript and PDF format, may be obtained from the Specifications Catalog cited above or by contacting the Object Management Group, Inc. at:

OMG Headquarters
140 Kendrick Street
Building A, Suite 300
Needham, MA 02494
USA
Tel: +1-781-444-0404
Fax: +1-781-444-0320
Email: pubs@omg.org

Certain OMG specifications are also available as ISO standards. Please consult <http://www.iso.org>

Typographical Conventions

The type styles shown below are used in this document to distinguish programming statements from ordinary English. However, these conventions are not used in tables or section headings where no distinction is necessary.

Times/Times New Roman - 10 pt.: Standard body text

Helvetica/Arial - 10 pt. Bold: OMG Interface Definition Language (OMG IDL) and syntax elements.

Courier - 10 pt. Bold: Programming language elements.

Helvetica/Arial - 10 pt: Exceptions

Note – Terms that appear in *italics* are defined in the glossary. Italic text also represents the name of a document, specification, or other publication.

Issues

The reader is encouraged to report any technical or editing issues/problems with this specification to <http://www.omg.org/technology/agreement.htm>.

1 Scope

This document specifies a comprehensive, flexible approach to supporting networks of objects that are distributed across and managed by multiple, heterogeneous CORBA-compliant Object Request Brokers (ORBs). The approach to inter-ORB operation is universal, because elements can be combined in many ways to satisfy a very broad range of needs.

The standard covers the specification of:

- ORB interoperability architecture
- Inter-ORB bridge support
- The General Inter-ORB Protocol (GIOP) for object request broker (ORB) interoperability. GIOP can be mapped onto any connection-oriented transport protocol that meets a minimal set of assumptions defined by this standard.
- The Internet Inter-ORB Protocol (IIOP), a specific mapping of the GIOP which runs directly over connections that use the Internet Protocol and the Transmission Control Protocol (TCP/IP connections).
- The CORBA Security Attribute Service (SAS) protocol and its use within the CSIv2 architecture to address the requirements of CORBA security for interoperable authentication, delegation, and privileges.
- The Zipped Inter-ORB Protocol (ZIOP) which defines a compression mechanism for the CORBA GIOP protocol.

The standard provides a widely implemented and used particularization of ITU-T Rec. X.931 | ISO/IEC 14752. Open Distributed Processing - Protocol Support for Computational Interactions. It supports interoperability and location transparency in ODP systems.

2 Conformance and Compliance

An ORB is considered to be interoperability-compliant when it meets the following requirements:

- In the CORBA Core part of this specification, standard APIs are provided by an ORB to enable the construction of request-level inter-ORB bridges. APIs are defined by the Dynamic Invocation Interface, the Dynamic Skeleton Interface, and by the object identity operations described in the Interface Repository clause of this book.

An Internet Inter-ORB Protocol (IIOP) (explained in the Building Inter-ORB Bridges clause) defines a transfer syntax and message formats (described independently as the General Inter-ORB Protocol), and defines how to transfer messages via TCP/IP connections. The IIOP can be supported natively or via a halfbridge. Support for additional Environment Specific Inter-ORB Protocols (ESIOPs) and other proprietary protocols is optional in an interoperability-compliant system. However, any implementation that chooses to use the other protocols defined by the CORBA interoperability specifications must adhere to those specifications to be compliant with CORBA interoperability.

Figure 6.2 on page 12 shows examples of interoperable ORB domains that are CORBA-compliant. These compliance points support a range of interoperability solutions. For example, the standard APIs may be used to construct “half bridge” to the IIOP, relying on another “half bridge” to connect to another ORB. The standard APIs also support construction of “full bridges,” without using the Internet IOP to mediate between separated bridge components. ORBs may also use the Internet IOP internally. In addition, ORBs may use GIOP messages to communicate over other network protocol families (such as Novell or OSI), and provide transport-level bridges to the IIOP.

The GIOP is described separately from the IIOP to allow future specifications to treat it as an independent compliance point.

2.1 Unreliable Multicast

Summary of Optional Verses Mandatory Interfaces

An interface to an MIOP gateway should be considered an optional interface within the MIOP specification.

Proposed Compliance Points

The MIOP specification is a single, optional compliance point within the CORBA Core specification.

Changes to Other OMG Specifications

This specification contains an extension to the IOP module.

```
module IOP {  
    const ProfileId    TAG_UIPMC = 3;  
    const ComponentId TAG_GROUP = 39;  
    const ComponentId TAG_GROUP_IIOp = 40  
};
```

2.2 GIOP Compression

GIOP Compression is defined as an optional CORBA conformance point. In order to claim GIOP Compression compliance an ORB implementation must support the following conformance point:

- ZIOP - The ORB implements the ZIOP wire protocol and the ZIOP module policy interfaces for controlling it, with support for at least the zlib algorithm.

When an ORB claims GIOP compression compliance it optionally can claim the following GIOP compression compliance point:

- Pluggable compression - The ORB implements the Compression module interfaces, and the registered CompressorFactory instances are available for use by ZIOP.

3 Normative References

The following referenced documents are indispensable for the application of this document. For dated references, only the edition cited applies. For undated references, the latest edition of the referenced document (including any amendments) applies.

3.1 Identical Recommendations | International Standards

- ITU-T Recommendation X.902 (1995) | ISO/IEC 10746-2:1996, Open Distributed Processing - Reference Model: Foundations
- ITU-T Recommendation X.903 (1995) | ISO/IEC 10746-3:1996, Open Distributed Processing - Reference Model:

Architecture

- ITU-T Recommendation X.920 (1999) | ISO/IEC 10750:1999, Open Distributed Processing - Interface Definition Language
- ITU-T Recommendation X.931(2000) | ISO/IEC 14752:2000, Open Distributed Processing - Protocol Support for Computational Interactions
- ISO/IEC 8859-1: 1998, Information Technology - 8-bit single byte coded graphic character sets - Part 1: Latin alphabet No. 1
- ISO/IEC 10646-1:1993 Information Technology - Universal Multiple-Octect coded character set (UCS) - Part 1: Architecture and Basic Multilingual Plane
- ISO/IEC 10646-1:1993/Amd 1:1996 Transformation Format for 16 planes of group 00 (UTF - 16)
- ISO/IEC 10646-1: 1993/Amd 2:1996 UCS Transformation Format 8 (UTF - 8)
- ISO/IEC 19500-1: 200n Open Distributed Processing - CORBA Specification Part 1: CORBA Interfaces

3.2 Other Specifications

- STD 007 (also, RFC 793), Transmission Control Protocol, J. Postel, Internet Engineering Task Force, Sept. 1981
- STD 005 (also, RFC 791), Internet Protocol, J. Postel, Internet Engineering Task Force, Sept. 1981
- OSF Character and Code Set Registry, OSF DCE FRC 40.1 (Public Version), S. (Martin) O'Donnell, June 1994.
- RPC Runtime Support For I18N Characters - Functional Specification, OSF DCE SIG RFC 41.2, M. Romagna, R. Mackey, November 1994.
- [JAV2I] Object Management Group, "Java to IDL," available from <http://www.omg.org/spec/JAV2I/1.4>
- [CORBASEC] Object Management Group, "Security Service," available from http://www.omg.org/technology/documents/formal/security_service.htm
- [ASMOTS] Object Management Group, "Additional Structuring Mechanisms for the OTS," available from http://www.omg.org/technology/documents/formal/add_struct.htm
- [TRANS] Object Management Group, "Transaction Service," available from http://www.omg.org/technology/documents/formal/transaction_service.htm
- [FIREWALL] Object Management Group, "CORBA Firewall Traversal Specification," available from <http://www.omg.org/members/cgi-bin/doc?ptc/04-04-05.pdf>
- [SCCP] Object Management Group, "CORBA / TC Interworking and SCCP-Inter ORB Protocol (SCCP)." Available from <http://www.omg.org/spec/SCCP>
- [FTCORBA] Object Management Group, "Fault Tolerant Corba," clause 23 of CORBA 3.0.3, available from <http://www.omg.org/cgi-bin/doc?formal/2004-03-01>
- [RTCORBA] Object Management Group, "Real-Time CORBA, version 1.2," available from http://www.omg.org/technology/documents/formal/real-time_CORBA.htm
- [WATM] Object Management Group, "Wireless Access and Telecom Mobility in CORBA, Version 1.2," available from <http://www.omg.org/spec/WATM/1.2/>

- [DCOMI] Object Management Group, “Interoperability with non-CORBA Systems” clause 20 of CORBA 3.0.3, available from <http://www.omg.org/cgi-bin/doc?formal/2004-03-01>
- [TSAS] Object Management Group “Telecommunications Service Access and Subscription Specification,” available from <http://www.omg.org/spec/TSAS/1.0/>
- IETF RFC2119, “Key words for use in RFCs to Indicate Requirement Levels,” S. Bradner, March 1997 (<http://ietf.org/rfc/rfc2119>)

4 Terms and definitions

For the purposes of this document, the following terms and definitions apply.

4.1 Recommendations | International Standards

This Recommendation | International Standard makes use of the following terms defined in ITU-T Rec. X.902 | ISO/IEC 10746-2:

- behavior
- interface
- instance
- object
- service
- state
- transparency
- type

This Recommendation | International Standard makes use of the following terms defined in ITU-T Rec. X.903 | ISO/IEC 10746-3:

- operation
- stub

4.2 Terms Defined in this Standard

adapter	Same as object adapter.
attribute	An identifiable association between an object and a value. An attribute A is made visible to clients as a pair of operations: get_A and set_A. Readonly attributes only generate a get operation.
client	The code or process that invokes an operation on an object.
data type	A categorization of values operation arguments, typically covering both behavior and representation (i.e., the traditional no-OO programming language notion of type.)

domain	A concept important to interoperability, it is a distinct scope, within which common characteristics are exhibited, common rules observed, and over which a distribution transparency is preserved.
dynamic invocation	Constructing and issuing a request whose signature is possibly not known until run-time.
dynamic skeleton	An interface-independent kind of skeleton, used by servers to handle requests whose signatures are possibly not known until run-time.
implementation	A definition that provides the information needed to create an object and allow the object to participate in providing an appropriate set of services. An implementation typically includes a description of the data structure used to represent the core state associated with an object, as well as definitions of the methods that access that data structure. It will also typically include information about the intended interface of the object.

interface repository	A storage place for interface information.
ORB core	The ORB component which moves a request from a client to the appropriate adapter for the target object.
request	A message issued by a client to cause a service to be performed.
results	The information returned to the client, which may include values as well as status information indicating that exceptional conditions were raised in attempting to perform the requested service.
server	A process implementing one or more operations on one or more objects.
signature	Defines the parameters of a given operation including their number order, data types, and passing mode; the results if any; and the possible outcomes (normal vs. exceptional) that might occur.
skeleton	The object-interface-specific ORB component which assists an object adapter in passing requests to particular methods.
synchronous request	A request where the client pauses to wait for completion of the request. Contrast with deferred synchronous request and one-way request.
interface type	A type satisfied by any object that satisfies a particular interface.
interoperability	The ability for two or more ORBs to cooperate to deliver requests to the proper object. Interoperating ORBs appear to a client to be a single ORB.
language binding or mapping	The means and conventions by which a programmer writing in a specific programming language accesses ORB capabilities.
method	An implementation of an operation. Code that may be executed to perform a requested service. Methods associated with an object may be structured into one or more programs.
object adapter	The ORB component which provides object reference, activation, and state related services to an object implementation. There may be different adapters provided for different kinds of implementations.
object implementation	Same as implementation.
object reference	A value that unambiguously identifies an object. Object references are never reused to identify another object.

objref	An abbreviation for object reference
value	Any entity that may be a possible actual parameter in a request. Values that serve to identify objects are called object references.

4.3 Keywords for Requirement statements

The keywords “must,” “must not,” “shall,” “shall not,” “should,” “should not,” and “may” in this specification are to be interpreted as described in IETF RFC 2119.

5 Symbols (and abbreviated terms)

For the purposes of this standard, the following abbreviations apply:

ADT	Abstract Data Type
CSIv2	Common Secure Interoperability, version 2
CCCS	Client Conversion Code Sets
CCS	Conversion Code Sets
CDR	Common Data Representation
CMIR	Client Makes it Right
CNCS	Client Native Code Set
CORBA	Common Object Request Broker Architecture
DCE	Distributed Computing Environment
ESIOP	Environment Specific Inter-ORB Protocol
OMG	Object Management Group
GIOP	General Inter-ORB Protocol
IDL	Interface Definition Language
IIOp	Internet Inter-ORB Protocol
IOR	Interoperable Object Reference
ORB	Object Request Broker
SAS	Security Attribute Service
SCCS	Server Conversion Code Sets
SMIR	Server Makes It Right
SNCS	Server Native Code Set
TCS	Transmission Code Set
TCS-C	Char Transmission Code Set
TCS-W	Wechar Transmission Code Set
VSCID	Vender Service Context codeset ID

6 Interoperability Overview

ORB interoperability specifies a comprehensive, flexible approach to supporting networks of objects that are distributed across and managed by multiple, heterogeneous CORBA-compliant ORBs. The approach to “interORBability” is universal because its elements can be combined in many ways to satisfy a very broad range of needs.

6.1 Elements of Interoperability

The elements of interoperability are as follows:

- ORB interoperability architecture
- Inter-ORB bridge support
- General and Internet Inter-ORB Protocols (GIOPs and IIOPs)

In addition, the architecture accommodates Environment Specific Inter-ORB Protocols (ESIOPs) that are optimized for particular environments such as DCE.

6.1.1 ORB Interoperability Architecture

The ORB Interoperability Architecture provides a conceptual framework for defining the elements of interoperability and for identifying its compliance points. It also characterizes new mechanisms and specifies conventions necessary to achieve interoperability between independently produced ORBs.

Specifically, the architecture introduces the concepts of *immediate* and *mediated bridging* of ORB domains. The Internet Inter-ORB Protocol (IIOP) forms the common basis for broad-scope mediated bridging. The inter-ORB bridge support can be used to implement both immediate bridges and to build “half-bridges” to mediated bridge domains.

By use of bridging techniques, ORBs can interoperate without knowing any details of that ORB’s implementation, such as what particular IPC or protocols (such as ESIOPs) are used to implement the *CORBA* specification.

The IIOP may be used in bridging two or more ORBs by implementing “half bridges” that communicate using the IIOP. This approach works for both stand-alone ORBs, and networked ones that use an ESIOP.

The IIOP may also be used to implement an ORB’s internal messaging, if desired. Since ORBs are not required to use the IIOP internally, the goal of not requiring prior knowledge of each others’ implementation is fully satisfied.

6.1.2 Inter-ORB Bridge Support

The interoperability architecture clearly identifies the role of different kinds of domains for ORB-specific information. Such domains can include object reference domains, type domains, security domains (e.g., the scope of a *Principal* identifier), a transaction domain, and more.

Where two ORBs are in the same domain, they can communicate directly. In many cases, this is the preferable approach. This is not always true, however, since organizations often need to establish local control domains.

When information in an invocation must leave its domain, the invocation must traverse a bridge. The role of a bridge is to ensure that content and semantics are mapped from the form appropriate to one ORB to that of another, so that users of any given ORB only see their appropriate content and semantics.

The inter-ORB bridge support element specifies ORB APIs and conventions to enable the easy construction of interoperability bridges between ORB domains. Such bridge products could be developed by ORB vendors, Sieves, system integrators, or other third-parties.

Because the extensions required to support Inter-ORB Bridges are largely general in nature, do not impact other ORB operation, and can be used for many other purposes besides building bridges, they are appropriate for all ORBs to support. Other applications include debugging, interposing of objects, implementing objects with interpreters and scripting languages, and dynamically generating implementations.

The inter-ORB bridge support can also be used to provide interoperability with non-CORBA systems, such as Microsoft's Component Object Model (COM). The ease of doing this will depend on the extent to which those systems conform to the CORBA Object Model.

6.1.3 General Inter-ORB Protocol (GIOP)

The General Inter-ORB Protocol (GIOP) element specifies a standard transfer syntax (low-level data representation) and a set of message formats for communications between ORBs. The GIOP is specifically built for ORB to ORB interactions and is designed to work directly over any connection-oriented transport protocol that meets a minimal set of assumptions. It does not require or rely on the use of higher level RPC mechanisms. The protocol is simple, scalable, and relatively easy to implement. It is designed to allow portable implementations with small memory footprints and reasonable performance, with minimal dependencies on supporting software other than the underlying transport layer.

While versions of the GIOP running on different transports would not be directly interoperable, their commonality would allow easy and efficient bridging between such networking domains.

6.1.4 Internet Inter-ORB Protocol (IIOP)[®]

The Internet Inter-ORB Protocol (IIOP)[®] element specifies how GIOP messages are exchanged using TCP/IP connections. The IIOP specifies a standardized interoperability protocol for the Internet, providing “out of the box” interoperation with other compatible ORBs based on the most popular product- and vendor-neutral transport layer. It can also be used as the protocol between half-bridges (see below).

The protocol is designed to be suitable and appropriate for use by any ORB to interoperate in Internet Protocol domains unless an alternative protocol is necessitated by the specific design center or intended operating environment of the ORB. In that sense it represents the basic inter-ORB protocol for TCP/IP environments, a most pervasive transport layer.

The IIOP's relationship to the GIOP is similar to that of a specific language mapping to OMG IDL; the GIOP may be mapped onto a number of different transports, and specifies the protocol elements that are common to all such mappings. The GIOP by itself, however, does not provide complete interoperability, just as IDL cannot be used to build complete programs. The IIOP and other similar mappings to different transports, are concrete realizations of the abstract GIOP definitions, as shown in Figure 6.1 on page 9.

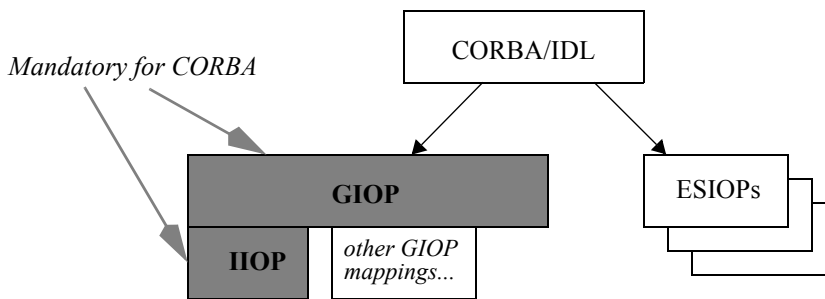

Figure 6.1 - Inter-ORB Protocol Relationships

6.1.5 Environment-Specific Inter-ORB Protocols (ESIOPs)

This specification also makes provision for an open-ended set of Environment-Specific Inter-ORB Protocols (ESIOPs). Such protocols would be used for “out of the box” interoperability at user sites where a particular networking or distributing computing infrastructure is already in general use.

Because of the opportunity to leverage and build on facilities provided by the specific environment, ESIOPs might support specialized capabilities such as those relating to security and administration.

While ESIOPs may be optimized for particular environments, all ESIOP specifications will be expected to conform to the general ORB interoperability architecture conventions to enable easy bridging. The inter-ORB bridge support enables bridges to be built between ORB domains that use the IOP and ORB domains that use a particular ESIOP.

6.2 Relationship to Previous Versions of CORBA

The ORB Interoperability Architecture builds on Common Object Request Broker Architecture by adding the notion of ORB Services and their domains. (ORB Services are described in “ORBs and ORB Services” on page 16). The architecture defines the problem of ORB interoperability in terms of bridging between those domains, and defines several ways in which those bridges can be constructed. The bridges can be internal (in-line) and external (request-level) to ORBs.

Issue 14392: change self reference to “this part of this International Standard”

APIs included in the interoperability specifications include compatible extensions to previous versions of *CORBA* to support request-level bridging:

- A Dynamic Skeleton Interface (DSI) is the basic support needed for building request-level bridges. It is the server-side analogue of the Dynamic Invocation Interface and in the same way it has general applicability beyond bridging. For information about the Dynamic Skeleton Interface, refer to the *Dynamic Skeleton Interface* clause.
- APIs for managing object references have been defined, building on the support identified for the Relationship Service. The APIs are defined in Object Reference Operations in the *ORB Interface* clause of Part 1 of this International Standard (ISO/IEC 19500-1). The Relationship Service is described in the *Relationship Service* specification; refer to *CosObjectIdentity Module* in that specification.

6.3 Examples of Interoperability Solutions

The elements of interoperability (Inter-ORB Bridges, General and Internet Inter-ORB Protocols, Environment-Specific Inter-ORB Protocols) can be combined in a variety of ways to satisfy particular product and customer needs. This sub clause provides some examples.

6.3.1 Example 1

ORB product A is designed to support objects distributed across a network and provide “out of the box” interoperability with compatible ORBs from other vendors. In addition it allows bridges to be built between it and other ORBs that use environment-specific or proprietary protocols. To accomplish this, ORB A uses the IIOP and provides inter-ORB bridge support.

6.3.2 Example 2

ORB product B is designed to provide highly optimized, very high-speed support for objects located on a single machine. For example, to support thousands of Fresco GUI objects operated on at near function-call speeds. In addition, some of the objects will need to be accessible from other machines and objects on other machines will need to be infrequently accessed. To accomplish this, ORB A provides a half-bridge to support the Internet IOP for communication with other “distributed” ORBs.

6.3.3 Example 3

ORB product C is optimized to work in a particular operating environment. It uses a particular environment-specific protocol based on distributed computing services that are commonly available at the target customer sites. In addition, ORB C is expected to interoperate with other arbitrary ORBs from other vendors. To accomplish this, ORB C provides inter-ORB bridge support and a companion half-bridge product (supplied by the ORB vendor or some third-party) provides the connection to other ORBs. The half-bridge uses the IIOP to enable interoperability with other compatible ORBs.

6.3.4 Interoperability Compliance

Issue 14393: change reference to part 1

An ORB is considered to be interoperability-compliant when it meets the following requirements:

- In the CORBA Core part of this specification, standard APIs are provided by an ORB to enable the construction of request-level inter-ORB bridges. APIs are defined by the Dynamic Invocation Interface, the Dynamic Skeleton Interface, and by the object identity operations described in the *Interface Repository* clause of Part 1 of this International Standard (ISO/IEC 19500-1).
- An Internet Inter-ORB Protocol (IIOP) (explained in the *Building Inter-ORB Bridges* clause) defines a transfer syntax and message formats (described independently as the General Inter-ORB Protocol), and defines how to transfer messages via TCP/IP connections. The IIOP can be supported natively or via a half-bridge.

Support for additional ESIOPs and other proprietary protocols is optional in an interoperability-compliant system. However, any implementation that chooses to use the other protocols defined by the CORBA interoperability specifications must adhere to those specifications to be compliant with CORBA interoperability.

Figure 6.2 on page 12 shows examples of interoperable ORB domains that are CORBA-compliant.

These compliance points support a range of interoperability solutions. For example, the standard APIs may be used to construct “half bridges” to the IIOP, relying on another “half bridge” to connect to another ORB. The standard APIs also support construction of “full bridges,” without using the Internet IOP to mediate between separated bridge components. ORBs may also use the Internet IOP internally. In addition, ORBs may use GIOP messages to communicate over other network protocol families (such as Novell or OSI), and provide transport-level bridges to the IIOP.

The GIOP is described separately from the IIOP to allow future specifications to treat it as an independent compliance point.

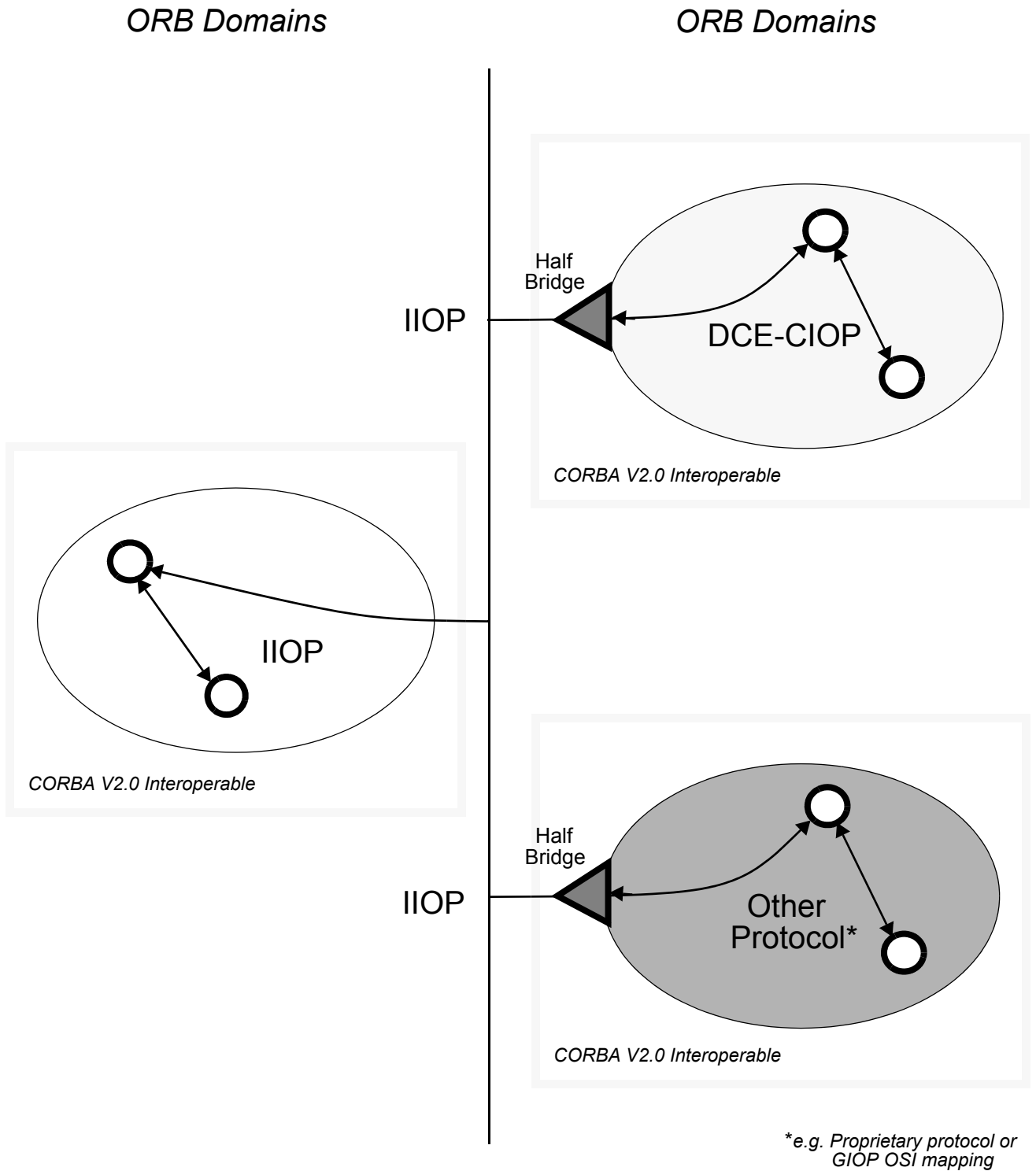

Figure 6.2 - Examples of CORBA Interoperability Compliance

6.4 Motivating Factors

This sub clause explains the factors that motivated the creation of interoperability specifications.

6.4.1 ORB Implementation Diversity

Today, there are many different ORB products that address a variety of user needs. A large diversity of implementation techniques is evident. For example, the time for a request ranges over at least 5 orders of magnitude, from a few microseconds to several seconds. The scope ranges from a single application to enterprise networks. Some ORBs have high levels of security, others are more open. Some ORBs are layered on a particular widely used protocol, others use highly optimized, proprietary protocols.

The market for object systems and applications that use them will grow as object systems are able to be applied to more kinds of computing. From application integration to process control, from loosely coupled operating systems to the information superhighway, CORBA-based object systems can be the common infrastructure.

6.4.2 ORB Boundaries

Even when it is not required by implementation differences, there are other reasons to partition an environment into different ORBs.

For security reasons, it may be important to know that it is not generally possible to access objects in one domain from another. For example, an “internet ORB” may make public information widely available, but a “company ORB” will want to restrict what information can get out. Even if they used the same ORB implementation, these two ORBs would be separate, so that the company could allow access to public objects from inside the company without allowing access to private objects from outside. Even though individual objects should protect themselves, prudent system administrators will want to avoid exposing sensitive objects to attacks from outside the company.

Supporting multiple ORBs also helps handle the difficult problem of testing and upgrading the object system. It would be unwise to test new infrastructure without limiting the set of objects that might be damaged by bugs, and it may be impractical to replace “the ORB” everywhere simultaneously. A new ORB might be tested and deployed in the same environment, interoperating with the existing ORB until either a complete switch is made or it incrementally displaces the existing one.

Management issues may also motivate partitioning an ORB. Just as networks are subdivided into domains to allow decentralized control of databases, configurations, resources, management of the state in an ORB (object reference location and translation information, interface repositories, per-object data) might also be done by creating sub-ORBs.

6.4.3 ORBs Vary in Scope, Distance, and Lifetime

Even in a single computing environment produced by a single vendor, there are reasons why some of the objects an application might use would be in one ORB, and others in another ORB. Some objects and services are accessed over long distances, with more global visibility, longer delays, and less reliable communication. Other objects are nearby, are not accessed from elsewhere, and provide higher quality service. By deciding which ORB to use, an implementor sets expectations for the clients of the objects.

One ORB might be used to retain links to information that is expected to accumulate over decades, such as library archives. Another ORB might be used to manage a distributed chess program in which the objects should all be destroyed when the game is over. Although while it is running, it makes sense for “chess ORB” objects to access the “archives ORB,” we would not expect the archives to try to keep a reference to the current board position.

6.5 Interoperability Design Goals

Because of the diversity in ORB implementations, multiple approaches to interoperability are required. Options identified in previous versions of *CORBA* include:

- *Protocol Translation*, where a gateway residing somewhere in the system maps requests from the format used by one ORB to that used by another.
- *Reference Embedding*, where invocation using a native object reference delegates to a special object whose job is to forward that invocation to another ORB.
- *Alternative ORBs*, where ORB implementations agree to coexist in the same address space so easily that a client or implementation can transparently use any of them, and pass object references created by one ORB to another ORB without losing functionality.

In general, there is no single protocol that can meet everyone's needs, and there is no single means to interoperate between two different protocols. There are many environments in which multiple protocols exist, and there are ways to bridge between environments that share no protocols.

This specification adopts a flexible architecture that allows a wide variety of ORB implementations to interoperate and that includes both bridging and common protocol elements.

The following goals guided the creation of interoperability specifications:

- The architecture and specifications should allow high-performance, small footprint, lightweight interoperability solutions.
- The design should scale, should not be unduly difficult to implement, and should not unnecessarily restrict implementation choices.
- Interoperability solutions should be able to work with any vendors' existing ORB implementations with respect to their CORBA-compliant core feature set; those implementations are diverse.
- All operations implied by the CORBA object model (i.e., the stringify and destringify operations defined on the **CORBA:ORB** pseudo-object and all the operations on **CORBA:Object**) as well as type management (e.g., narrowing, as needed by the C++ mapping) should be supported.

6.5.1 Non-Goals

The following were taken into account, but were not goals:

- Support for security
- Support for future ORB Services

7 ORB Interoperability Architecture

7.1 Overview

The original Interoperability RFP defines interoperability as the ability for a client on ORB A to invoke an OMG IDL-defined operation on an object on ORB B, where ORB A and ORB B are independently developed. It further identifies general requirements including in particular:

- Ability for two vendors' ORBs to interoperate without prior knowledge of each other's implementation.
- Support of all ORB functionality.
- Preservation of content and semantics of ORB-specific information across ORB boundaries (for example, security).

In effect, the requirement is for invocations between client and server objects to be independent of whether they are on the same or different ORBs, and not to mandate fundamental modifications to existing ORB products.

7.1.1 Domains

The CORBA Object Model identifies various distribution transparencies that must be supported within a single ORB environment, such as location transparency. Elements of ORB functionality often correspond directly to such transparencies. Interoperability can be viewed as extending transparencies to span multiple ORBs.

In this architecture a *domain* is a distinct scope, within which certain common characteristics are exhibited and common rules are observed over which a distribution transparency is preserved. Thus, interoperability is fundamentally involved with transparently crossing such domain boundaries.

Domains tend to be either administrative or technological in nature, and need not correspond to the boundaries of an ORB installation. Administrative domains include naming domains, trust groups, resource management domains, and other "run-time" characteristics of a system. Technology domains identify common protocols, syntaxes, and similar "build-time" characteristics. In many cases, the need for technology domains derives from basic requirements of administrative domains.

Within a single ORB, most domains are likely to have similar scope to that of the ORB itself: common object references, network addresses, security mechanisms, and more. However, it is possible for there to be multiple domains of the same type supported by a given ORB: internal representation on different machine types, or security domains. Conversely, a domain may span several ORBs: similar network addresses may be used by different ORBs, type identifiers may be shared.

7.1.2 Bridging Domains

The abstract architecture describes ORB interoperability in terms of the translation required when an object request traverses domain boundaries. Conceptually, a mapping or *bridging mechanism* resides at the boundary between the domains, transforming requests expressed in terms of one domain's model into the model of the destination domain.

The concrete architecture identifies two approaches to inter-ORB bridging:

- At application level, allowing flexibility and portability.
- At ORB level, built into the ORB itself.

7.2 ORBs and ORB Services

The ORB Core is that part of the ORB which provides the basic representation of objects and the communication of requests. The ORB Core therefore supports the minimum functionality to enable a client to invoke an operation on a server object, with (some of) the distribution transparencies required by *CORBA*.

An object request may have implicit attributes which affect the way in which it is communicated - though not the way in which a client makes the request. These attributes include security, transactional capabilities, recovery, and replication. These features are provided by “ORB Services,” which will in some ORBs be layered as internal services over the core, or in other cases be incorporated directly into an ORB’s core. It is an aim of this specification to allow for new ORB Services to be defined in the future, without the need to modify or enhance this architecture.

Within a single ORB, ORB services required to communicate a request will be implemented and (implicitly) invoked in a private manner. For interoperability between ORBs, the ORB services used in the ORBs, and the correspondence between them, must be identified.

7.2.1 The Nature of ORB Services

ORB Services are invoked implicitly in the course of application-level interactions. ORB Services range from fundamental mechanisms such as reference resolution and message encoding to advanced features such as support for security, transactions, or replication.

An ORB Service is often related to a particular transparency. For example, message encoding – the marshaling and unmarshaling of the components of a request into and out of message buffers – provides transparency of the representation of the request. Similarly, reference resolution supports location transparency. Some transparencies, such as security, are supported by a combination of ORB Services and Object Services while others, such as replication, may involve interactions between ORB Services themselves.

ORB Services differ from Object Services in that they are positioned below the application and are invoked transparently to the application code. However, many ORB Services include components that correspond to conventional Object Services in that they are invoked explicitly by the application.

Security is an example of service with both ORB Service and normal Object Service components, the ORB components being those associated with transparently authenticating messages and controlling access to objects while the necessary administration and management functions resemble conventional Object Services.

7.2.2 ORB Services and Object Requests

Interoperability between ORBs extends the scope of distribution transparencies and other request attributes to span multiple ORBs. This requires the establishment of relationships between supporting ORB Services in the different ORBs.

In order to discuss how the relationships between ORB Services are established, it is necessary to describe an abstract view of how an operation invocation is communicated from client to server object.

1. The client generates an operation request, using a reference to the server object, explicit parameters, and an implicit invocation context. This is processed by certain ORB Services on the client path.
2. On the server side, corresponding ORB Services process the incoming request, transforming it into a form directly suitable for invoking the operation on the server object.

3. The server object performs the requested operation.
4. Any result of the operation is returned to the client in a similar manner.

The correspondence between client-side and server-side ORB Services need not be one-to-one and in some circumstances may be far more complex. For example, if a client application requests an operation on a replicated server, there may be multiple server-side ORB service instances, possibly interacting with each other.

In other cases, such as security, client-side or server-side ORB Services may interact with Object Services such as authentication servers.

7.2.3 Selection of ORB Services

The ORB Services used are determined by:

- Static properties of both client and server objects; for example, whether a server is replicated.
- Dynamic attributes determined by a particular invocation context; for example, whether a request is transactional.
- Administrative policies (e.g., security).

Within a single ORB, private mechanisms (and optimizations) can be used to establish which ORB Services are required and how they are provided. Service selection might in general require negotiation to select protocols or protocol options. The same is true between different ORBs: it is necessary to agree which ORB Services are used, and how each transforms the request. Ultimately, these choices become manifest as one or more protocols between the ORBs or as transformations of requests.

In principle, agreement on the use of each ORB Service can be independent of the others and, in appropriately constructed ORBs, services could be layered in any order or in any grouping. This potentially allows applications to specify selective transparencies according to their requirements, although at this time CORBA provides no way to penetrate its transparencies.

A client ORB must be able to determine which ORB Services must be used in order to invoke operations on a server object. Correspondingly, where a client requires dynamic attributes to be associated with specific invocations, or administrative policies dictate, it must be possible to cause the appropriate ORB Services to be used on client and server sides of the invocation path. Where this is not possible - because, for example, one ORB does not support the full set of services required - either the interaction cannot proceed or it can only do so with reduced facilities or transparencies.

7.3 Domains

From a computational viewpoint, the OMG Object Model identifies various distribution transparencies which ensure that client and server objects are presented with a uniform view of a heterogeneous distributed system. From an engineering viewpoint, however, the system is not wholly uniform. There may be distinctions of location and possibly many others such as processor architecture, networking mechanisms and data representations. Even when a single ORB implementation is used throughout the system, local instances may represent distinct, possibly optimized scopes for some aspects of ORB functionality.

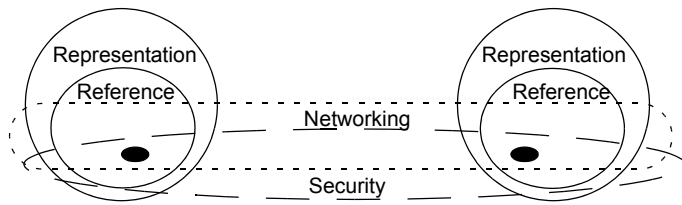

Figure 7.1 - Different Kinds of Domains can Coexist

Interoperability, by definition, introduces further distinctions, notably between the scopes associated with each ORB. To describe both the requirements for interoperability and some of the solutions, this architecture introduces the concept of *domains* to describe the scopes and their implications.

Informally, a domain is a set of objects sharing a common characteristic or abiding by common rules. It is a powerful modeling concept that can simplify the analysis and description of complex systems. There may be many types of domains (e.g., management domains, naming domains, language domains, and technology domains).

7.3.1 Definition of a Domain

Domains allow partitioning of systems into collections of components that have some characteristic in common. In this architecture a domain is a scope in which a collection of objects, said to be members of the domain, is associated with some common characteristic; any object for which the association does not exist, or is undefined, is not a member of the domain. A domain can be modeled as an object and may be itself a member of other domains.

It is the scopes themselves and the object associations or bindings defined within them which characterize a domain. This information is disjoint between domains. However, an object may be a member of several domains, of similar kinds as well as of different kinds, and so the sets of members of domains may overlap.

The concept of a domain boundary is defined as the limit of the scope in which a particular characteristic is valid or meaningful. When a characteristic in one domain is translated to an equivalent in another domain, it is convenient to consider it as traversing the boundary between the two domains.

Domains are generally either administrative or technological in nature. Examples of domains related to ORB interoperability issues are:

- Referencing domain – the scope of an object reference.
- Representation domain – the scope of a message transfer syntax and protocol.
- Network addressing domain – the scope of a network address.
- Network connectivity domain – the potential scope of a network message.
- Security domain – the extent of a particular security policy.
- Type domain – the scope of a particular type identifier.
- Transaction domain – the scope of a given transaction service.

Domains can be related in two ways: containment, where a domain is contained within another domain, and federation, where two domains are joined in a manner agreed to and set up by their administrators.

7.3.2 Mapping Between Domains: Bridging

Interoperability between domains is only possible if there is a well-defined mapping between the behaviors of the domains being joined. Conceptually, a mapping mechanism or bridge resides at the boundary between the domains, transforming requests expressed in terms of one domain's model into the model of the destination domain. Note that the use of the term "bridge" in this context is conceptual and refers only to the functionality that performs the required mappings between distinct domains. There are several implementation options for such bridges and these are discussed elsewhere.

For full interoperability, it is essential that all the concepts used in one domain are transformable into concepts in other domains with which interoperability is required, or that if the bridge mechanism filters such a concept out, nothing is lost as far as the supported objects are concerned. In other words, one domain may support a superior service to others, but such a superior functionality will not be available to an application system spanning those domains.

A special case of this requirement is that the object models of the two domains need to be compatible. This specification assumes that both domains are strictly compliant with the CORBA Object Model and the *CORBA* specifications. This includes the use of OMG IDL when defining interfaces, the use of the CORBA Core Interface Repository, and other modifications that were made to *CORBA*. Variances from this model could easily compromise some aspects of interoperability.

7.4 Interoperability Between ORBs

An ORB "provides the mechanisms by which objects transparently make and receive requests and responses. In so doing, the ORB provides interoperability between applications on different machines in heterogeneous distributed environments..." ORB interoperability extends this definition to cases in which client and server objects on different ORBs "transparently make and receive requests."

Note that a direct consequence of this transparency requirement is that bridging must be bidirectional: that is, it must work as effectively for object references passed as parameters as for the target of an object invocation. Were bridging unidirectional (e.g., if one ORB could only be a client to another), then transparency would not have been provided because object references passed as parameters would not work correctly: ones passed as "callback objects," for example, could not be used.

Without loss of generality, most of this specification focuses on bridging in only one direction. This is purely to simplify discussions, and does not imply that unidirectional connectivity satisfies basic interoperability requirements.

7.4.1 ORB Services and Domains

In this architecture, different aspects of ORB functionality - ORB Services - can be considered independently and associated with different domain types. The architecture does not, however, prescribe any particular decomposition of ORB functionality and interoperability into ORB Services and corresponding domain types. There is a range of possibilities for such a decomposition:

1. The simplest model, for interoperability, is to treat all objects supported by one ORB (or, alternatively, all ORBs of a given type) as comprising one domain. Interoperability between any pair of different domains (or domain types) is then achieved by a specific all-encompassing bridge between the domains. (This is all *CORBA* implies.)
2. More detailed decompositions would identify particular domain types - such as referencing, representation, security, and networking. A core set of domain types would be pre-determined and allowance made for additional domain types to be defined as future requirements dictate (e.g., for new ORB Services).

7.4.2 ORBs and Domains

In many respects, issues of interoperability between ORBs are similar to those which can arise with a single type of ORB (e.g., a product). For example:

- Two installations of the ORB may be installed in different security domains, with different Principal identifiers. Requests crossing those security domain boundaries will need to establish locally meaningful Principals for the caller identity, and for any Principals passed as parameters.
- Different installations might assign different type identifiers for equivalent types, and so requests crossing type domain boundaries would need to establish locally meaningful type identifiers (and perhaps more).

Conversely, not all of these problems need to appear when connecting two ORBs of a different type (e.g., two different products). Examples include:

- They could be administered to share user visible naming domains, so that naming domains do not need bridging.
- They might reuse the same networking infrastructure, so that messages could be sent without needing to bridge different connectivity domains.

Additional problems can arise with ORBs of different types. In particular, they may support different concepts or models, between which there are no direct or natural mappings. CORBA only specifies the application level view of object interactions, and requires that distribution transparencies conceal a whole range of lower level issues. It follows that within any particular ORB, the mechanisms for supporting transparencies are not visible at the application-level and are entirely a matter of implementation choice. So there is no guarantee that any two ORBs support similar internal models or that there is necessarily a straightforward mapping between those models.

These observations suggest that the concept of an ORB (instance) is too coarse or superficial to allow detailed analysis of interoperability issues between ORBs. Indeed, it becomes clear that an ORB instance is an elusive notion: it can perhaps best be characterized as the intersection or coincidence of ORB Service domains.

7.4.3 Interoperability Approaches

When an interaction takes place across a domain boundary, a mapping mechanism, or bridge, is required to transform relevant elements of the interaction as they traverse the boundary. There are essentially two approaches to achieving this: mediated bridging and immediate bridging. These approaches are described in the following sub clauses.

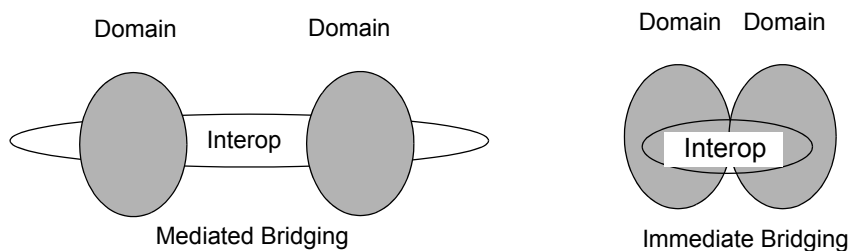

Figure 7.2 - Two bridging techniques, different uses of an intermediate form agreed on between the two domains.

7.4.3.1 Mediated Bridging

With mediated bridging, elements of the interaction relevant to the domain are transformed, at the boundary of each domain, between the internal form of that domain and an agreed, common form.

Observations on mediated bridging are as follows:

- The scope of agreement of a common form can range from a private agreement between two particular ORB/domain implementations to a universal standard.
- There can be more than one common form, each oriented or optimized for a different purpose.
- If there is more than one possible common form, then which is used can be static (e.g., administrative policy agreed between ORB vendors, or between system administrators) or dynamic (e.g., established separately for each object, or on each invocation).
- Engineering of this approach can range from in-line specifically compiled (compare to stubs) or generic library code (such as encryption routines), to intermediate bridges to the common form.

7.4.3.2 Immediate Bridging

With immediate bridging, elements of the interaction relevant to the domain are transformed, at the boundary of each domain, directly between the internal form of one domain and the internal form of the other.

Observations on immediate bridging are as follows:

- This approach has the potential to be optimal (in that the interaction is not mediated via a third party, and can be specifically engineered for each pair of domains) but sacrifices flexibility and generality of interoperability to achieve this.
- This approach is often applicable when crossing domain boundaries that are purely administrative (i.e., there is no change of technology). For example, when crossing security administration domains between similar ORBs, it is not necessary to use a common intermediate standard.

As a general observation, the two approaches can become almost indistinguishable when private mechanisms are used between ORB/domain implementations.

7.4.3.3 Location of Inter-Domain Functionality

Logically, an inter-domain bridge has components in both domains, whether the mediated or immediate bridging approach is used. However, domains can span ORB boundaries and ORBs can span machine and system boundaries; conversely, a machine may support, or a process may have access to more than one ORB (or domain of a given type). From an engineering viewpoint, this means that the components of an inter-domain bridge may be dispersed or co-located, with respect to ORBs or systems. It also means that the distinction between an ORB and a bridge can be a matter of perspective: there is a duality between viewing inter-system messaging as belonging to ORBs, or to bridges.

For example, if a single ORB encompasses two security domains, the inter-domain bridge could be implemented wholly within the ORB and thus be invisible as far as ORB interoperability is concerned. A similar situation arises when a bridge between two ORBs or domains is implemented wholly within a process or system that has access to both. In such cases, the engineering issues of inter-domain bridging are confined, possibly to a single system or process. If it were practical to implement all bridging in this way, then interactions between systems or processes would be solely within a single domain or ORB.

7.4.3.4 Bridging Level

As noted at the start of this sub clause, bridges may be implemented both internally to an ORB and as layers above it. These are called respectively “in-line” and “request-level” bridges.

Request-level bridges use the CORBA APIs, including the Dynamic Skeleton Interface, to receive and issue requests. However, there is an emerging class of “implicit context” which may be associated with some invocations, holding ORB Service information such as transaction and security context information, which is not at this time exposed through general purpose public APIs. (Those APIs expose only OMG IDL-defined operation parameters, not implicit ones.)

Rather, the precedent set with the Transaction Service is that special purpose APIs are defined to allow bridging of each kind of context. This means that request-level bridges must be built to specifically understand the implications of bridging such ORB Service domains, and to make the appropriate API calls.

7.4.4 Policy-Mediated Bridging

An assumption made through most of this specification is that the existence of domain boundaries should be transparent to requests: that the goal of interoperability is to hide such boundaries. However, if this were always the goal, then there would be no real need for those boundaries in the first place.

Realistically, administrative domain boundaries exist because they reflect ongoing differences in organizational policies or goals. Bridging the domains will in such cases require *policy mediation*. That is, inter-domain traffic will need to be constrained, controlled, or monitored; fully transparent bridging may be highly undesirable. Resource management policies may even need to be applied, restricting some kinds of traffic during certain periods.

Security policies are a particularly rich source of examples: a domain may need to audit external access, or to provide domain-based access control. Only a very few objects, types of objects, or classifications of data might be externally accessible through a “firewall.”

Such policy-mediated bridging requires a bridge that knows something about the traffic being bridged. It could in general be an application-specific policy, and many policy-mediated bridges could be parts of applications. Those might be organization-specific, off-the-shelf, or anywhere in between.

Request-level bridges, which use only public ORB APIs, easily support the addition of policy mediation components, without loss of access to any other system infrastructure that may be needed to identify or enforce the appropriate policies.

7.4.5 Configurations of Bridges in Networks

In the case of network-aware ORBs, we anticipate that some ORB protocols will be more frequently bridged to than others, and so will begin to serve the role of “backbone ORBs.” (This is a role that the IIOP is specifically expected to serve.) This use of “backbone topology” is true both on a large scale and a small scale. While a large scale public data network provider could define its own backbone ORB, on a smaller scale, any given institution will probably designate one commercially available ORB as its backbone.

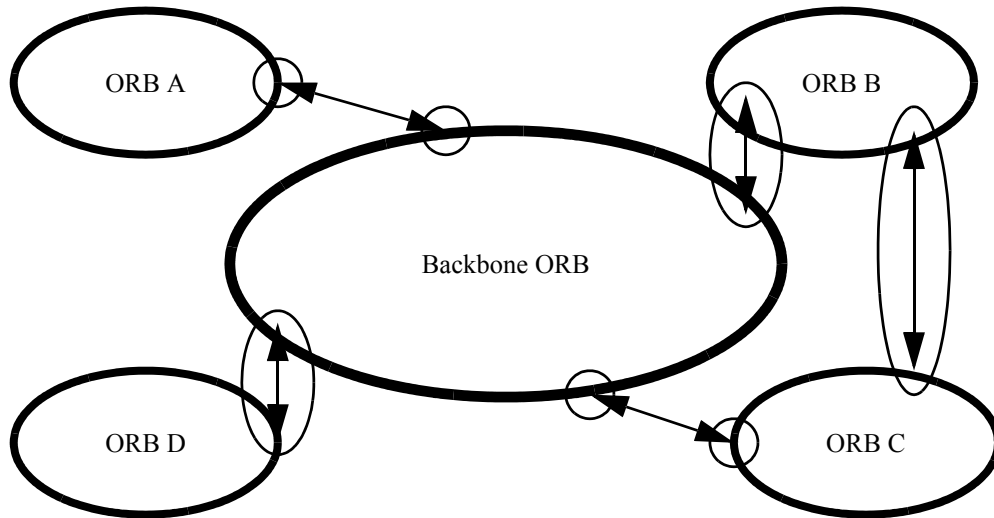

Figure 7.3 - An ORB chosen as a backbone will connect other ORBs through bridges, both full-bridges and half-bridges.

Adopting a backbone style architecture is a standard administrative technique for managing networks. It has the consequence of minimizing the number of bridges needed, while at the same time making the ORB topology match typical network organizations. (That is, it allows the number of bridges to be proportional to the number of protocols, rather than combinatorial.)

In large configurations, it will be common to notice that adding ORB bridges doesn't even add any new "hops" to network routes, because the bridges naturally fit in locations where connectivity was already indirect, and augment or supplant the existing network firewalls.

7.5 Object Addressing

Issue 14394: Change ambiguous reference to part 1 clause

The Object Model in "The Object Model" clause of Part 1 of this International Standard (ISO/IEC 19500-1) defines an object reference as an object name that reliably denotes a particular object. An object reference identifies the same object each time the reference is used in a request, and an object may be denoted by multiple, distinct references.

The fundamental ORB interoperability requirement is to allow clients to use such object names to invoke operations on objects in other ORBs. Clients do not need to distinguish between references to objects in a local ORB or in a remote one. Providing this transparency can be quite involved, and naming models are fundamental to it.

This sub clause discusses models for naming entities in multiple domains, and transformations of such names as they cross the domain boundaries. That is, it presents transformations of object reference information as it passes through networks of inter-ORB bridges. It uses the word "ORB" as synonymous with referencing domain; this is purely to simplify the discussion. In other contexts, "ORB" can usefully denote other kinds of domain.

7.5.1 Domain-relative Object Referencing

Since CORBA does not require ORBs to understand object references from other ORBs, when discussing object references from multiple ORBs one must always associate the object reference's domain (ORB) with the object reference. We use the notation $D0.R0$ to denote an object reference $R0$ from domain $D0$; this is itself an object reference. This is called "domain-relative" referencing (or addressing) and need not reflect the implementation of object references within any ORB.

At an implementation level, associating an object reference with an ORB is only important at an inter-ORB boundary; that is, inside a bridge. This is simple, since the bridge knows from which ORB each request (or response) came, including any object references embedded in it.

7.5.2 Handling of Referencing Between Domains

When a bridge hands an object reference to an ORB, it must do so in a form understood by that ORB: the object reference must be in the recipient ORB's native format. Also, in cases where that object originated from some other ORB, the bridge must associate each newly created "proxy" object reference with (what it sees as) the original object reference.

Several basic schemes to solve these two problems exist. These all have advantages in some circumstances; all can be used, and in arbitrary combination with each other, since CORBA object references are opaque to applications. The ramifications of each scheme merits attention, with respect to scaling and administration. The schemes include:

1. *Object Reference Translation Reference Embedding*: The bridge can store the original object reference itself, and pass an entirely different proxy reference into the new domain. The bridge must then manage state on behalf of each bridged object reference, map these references from one ORB's format to the other's, and vice versa.
2. *Reference Encapsulation*: The bridge can avoid holding any state at all by conceptually concatenating a domain identifier to the object name. Thus if a reference $D0.R$, originating in domain $D0$, traversed domains $D1...D4$ it could be identified in $D4$ as proxy reference $d3.d2.d1.d0.R$, where dn is the address of Dn relative to $Dn+1$.

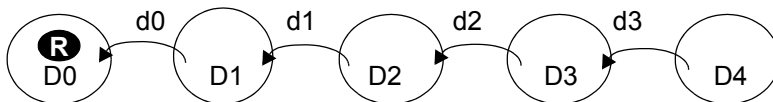

Figure 7.4 - Reference encapsulation adds domain information during bridging

3. *Domain Reference Translation*: Like object reference translation, this scheme holds some state in the bridge. However, it supports sharing that state between multiple object references by adding a domain-based route identifier to the proxy (which still holds the original reference, as in the reference encapsulation scheme). It achieves this by providing encoded domain route information each time a domain boundary is traversed; thus if a reference $D0.R$, originating in domain $D0$, traversed domains $D1...D4$ it would be identified in $D4$ as $(d3, x3).R$, and in $D2$ as $(d1, x1).R$, and so on, where dn is the address of Dn relative to $Dn+1$, and xn identifies the pair $(dn-1, xn-1)$.

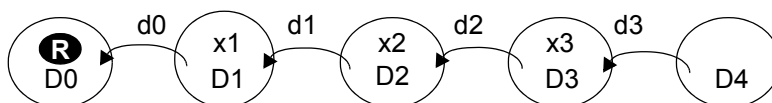

Figure 7.5 - Domain Reference Translation substitutes domain references during bridging

4. *Reference Canonicalization*: This scheme is like domain reference translation, except that the proxy uses a “well-known” (e.g., global) domain identifier rather than an encoded path. Thus a reference R , originating in domain $D0$ would be identified in other domains as $D0.R$.

Observations about these approaches to inter-domain reference handling are as follows:

- Naive application of reference encapsulation could lead to arbitrarily large references. A “topology service” could optimize cycles within any given encapsulated reference and eliminate the appearance of references to local objects as alien references.
- A topology service could also optimize the chains of routes used in the domain reference translation scheme. Since the links in such chains are re-used by any path traversing the same sequence of domains, such optimization has particularly high leverage.
- With the general purpose APIs defined in *CORBA*, object reference translation can be supported even by ORBs not specifically intended to support efficient bridging, but this approach involves the most state in intermediate bridges. As with reference encapsulation, a topology service could optimize individual object references. (APIs are defined by the Dynamic Skeleton Interface and Dynamic Invocation Interface.)
- The chain of addressing links established with both object and domain reference translation schemes must be represented as state within the network of bridges. There are issues associated with managing this state.
- Reference canonicalization can also be performed with managed hierarchical name spaces such as those now in use on the Internet and X.500 naming.

7.6 An Information Model for Object References

This sub clause provides a simple, powerful information model for the information found in an object reference. That model is intended to be used directly by developers of bridging technology, and is used in that role by the IIOP, described in the *General Inter-ORB Protocol* clause of this standard, *Object References*.

7.6.1 What Information Do Bridges Need?

The following potential information about object references has been identified as critical for use in bridging technologies:

- *Is it null?* Nulls only need to be transmitted and never support operation invocation.
- *What type is it?* Many ORBs require knowledge of an object’s type in order to efficiently preserve the integrity of their type systems.
- *What protocols are supported?* Some ORBs support objrefs that in effect live in multiple referencing domains, to allow clients the choice of the most efficient communications facilities available.
- *What ORB Services are available?* As noted in Selection of ORB Services on page 17, several different ORB Services might be involved in an invocation. Providing information about those services in a standardized way could in many cases reduce or eliminate negotiation overhead in selecting them.

7.6.2 Interoperable Object References: IORs

To provide the information above, an “Interoperable Object Reference,” (IOR) data structure has been provided. This data structure need not be used internally to any given ORB, and is not intended to be visible to application-level ORB programmers. It should be used only when crossing object reference domain boundaries, within bridges.

This data structure is designed to be efficient in typical single-protocol configurations, while not penalizing multiprotocol ones.

```
module IOP {                                     // IDL

    // Standard Protocol Profile tag values

    typedef unsigned long          ProfileId;

    typedef CORBA::OctetSeq ProfileData;
    struct TaggedProfile {
        ProfileId          tag;
        ProfileData        profile_data;
    };
    typedef sequence <TaggedProfile> TaggedProfileSeq ;

    // an Interoperable Object Reference is a sequence of
    // object-specific protocol profiles, plus a type ID.

    struct IOR {
        string              type_id;
        TaggedProfileSeq    profiles;
    };

    // Standard way of representing multicomponent profiles.
    // This would be encapsulated in a TaggedProfile.

    typedef unsigned long ComponentId;
    typedef CORBA::OctetSeq ComponentData;

    struct TaggedComponent {
        ComponentId          tag;
        ComponentData        component_data;
    };

    typedef sequence<TaggedComponent> TaggedComponentSeq;
    typedef sequence <TaggedComponent> MultipleComponentProfile;
    typedef CORBA::OctetSeq ObjectKey;
};
```

7.6.3 IOR Profiles

Object references have at least one *tagged profile*. Each profile supports one or more protocols and encapsulates all the basic information the protocols it supports need to identify an object. Any single profile holds enough information to drive a complete invocation using any of the protocols it supports; the content and structure of those profile entries are wholly specified by these protocols.

When a specific protocol is used to convey an object reference passed as a parameter in an IDL operation invocation (or reply), an IOR which reflects, in its contained profiles, the full protocol understanding of the operation client (or server in case of reply) may be sent. A receiving ORB which operates (based on topology and policy information available to it) on

profiles rather than the received IOR as a whole, to create a derived reference for use in its own domain of reference, is placing itself as a bridge between reference domains. Interoperability inhibiting situations can arise when an orb sends an IOR with multiple profiles (using one of its supported protocols) to a receiving orb, and that receiving orb later returns a derived reference to that object, which has had profiles or profile component data removed or transformed from the original IOR contents.

To assist in classifying behavior of ORBS in such bridging roles, two classes of IOR conformance may be associated with the conformance requirements for a given ORB interoperability protocol:

- Full IOR conformance requires that an orb which receives an IOR for an object passed to it through that ORB interoperability protocol, shall recover the original IOR, in its entirety, for passing as a reference to that object from that orb through that same protocol.
- Limited-Profile IOR conformance requires that an orb which receives an IOR passed to it through a given ORB interoperability protocol, shall recover all of the standard information contained in the IOR profile for that protocol, whenever passing a reference to that object, using that same protocol, to another ORB.

NOTE: Conformance to IIOP versions 1.0, 1.1, and 1.2 only requires support of limited-Profile IOR conformance, specifically for the IIOP IOR profile. However, due to interoperability problems induced by Limited-Profile IOR conformance, it is now deprecated by the CORBA 2.4 specification for an orb to not support Full IOR conformance. Some future IIOP versions could require Full IOR conformance.

An ORB may be unable to use any of the profiles provided in an IOR for various reasons which may be broadly categorized as transient ones like temporary network outage, and non-transient ones like unavailability of appropriate protocol software in the ORB. The decision about the category of outage that causes an ORB to be unable to use any profile from an IOR is left up to the ORB. At an appropriate point, when an ORB discovers that it is unable to use any profile in an IOR, depending on whether it considers the reason transient or non-transient, it should raise the standard system exception `TRANSIENT` with standard minor code 2, or `IMP_LIMIT` with the standard minor code 1.

Issue 14395: change “see section” to “see clause”

Each profile has a unique numeric tag, assigned by the OMG. The ones defined here are for the IIOP (see clause 9.7.3, IIOP IOR Profile Components, on page 114) and for use in “multiple component profiles.” Profile tags in the range **0x80000000** through **0xffffffff** are reserved for future use, and are not currently available for assignment.

Null object references are indicated by an empty set of profiles, and by a “Null” type ID (a string that contains only a single terminating character). Type IDs may only be “Null” in any message, requiring the client to use existing knowledge or to consult the object, to determine interface types supported. The type ID is a Repository ID identifying the interface type, and is provided to allow ORBs to preserve strong typing. This identifier is agreed on within the bridge and, for reasons outside the scope of this interoperability specification, needs to have a much broader scope to address various problems in system evolution and maintenance. Type IDs support detection of type equivalence, and in conjunction with an Interface Repository, allow processes to reason about the relationship of the type of the object referred to and any other type.

The type ID, if provided by the server, indicates the most derived type that the server wishes to publish, at the time the reference is generated. The object’s actual most derived type may later change to a more derived type. Therefore, the type ID in the IOR can only be interpreted by the client as a hint that the object supports at least the indicated interface. The client can succeed in narrowing the reference to the indicated interface, or to one of its base interfaces, based solely on the type ID in the IOR, but must not fail to narrow the reference without consulting the object via the “`_is_a`” or “`_get_interface`” pseudo-operations.

ORBs claiming to support the Full-IOR conformance are required to preserve all the semantic content of any IOR (including the ordering of each profile and its components), and may only apply transformations which preserve semantics (e.g., changing Byte order for encapsulation).

For example, consider an echo operation for object references:

```
interface Echoer {Object echo(in Object o);};
```

Assume that the method body implementing this “echo” operation simply returns its argument. When a client application invokes the echo operation and passes an arbitrary object reference, if both the client and server ORBs claim support to Full IOR conformance, the reference returned by the operation is guaranteed to have not been semantically altered by either client or server ORB. That is, all its profiles will remain intact and in the same order as they were present when the reference was sent. This requirement for ORBs which claim support for Full-IOR conformance, ensures that, for example, a client can safely store an object reference in a naming service and get that reference back again later without losing information inside the reference.

7.6.4 Standard IOR Profiles

```
module IOP {  
    const ProfileId TAG_INTERNET_IOP = 0;  
    const ProfileId TAG_MULTIPLE_COMPONENTS = 1;  
    const ProfileId TAG_SCCP_IOP = 2;  
    const ProfileId TAG_UIPMC = 3;  
};
```

7.6.4.1 The TAG_INTERNET_IOP Profile

The **TAG_INTERNET_IOP** tag identifies profiles that support the Internet Inter-ORB Protocol. The **ProfileBody** of this profile, described in detail in IOP IOR Profiles on page 112, contains a CDR encapsulation of a structure containing addressing and object identification information used by IOP. Version 1.1 of the **TAG_INTERNET_IOP** profile also includes a **sequence<TaggedComponent>** that can contain additional information supporting optional IOP features, ORB services such as security, and future protocol extensions.

Protocols other than IOP (such as ESIOPs and other GIOPs) can share profile information (such as object identity or security information) with IOP by encoding their additional profile information as components in the **TAG_INTERNET_IOP** profile. All **TAG_INTERNET_IOP** profiles support IOP, regardless of whether they also support additional protocols. Interoperable ORBs are not required to create or understand any other profile, nor are they required to create or understand any of the components defined for other protocols that might share the **TAG_INTERNET_IOP** profile with IOP.

The **profile_data** for the **TAG_INTERNET_IOP** profile is a CDR encapsulation of the **IOP::ProfileBody_1_1** type, described in IOP IOR Profiles on page 112.

7.6.4.2 The TAG_MULTIPLE_COMPONENTS Profile

The **TAG_MULTIPLE_COMPONENTS** tag indicates that the value encapsulated is of type **MultipleComponentProfile**. In this case, the profile consists of a list of protocol components, the use of which must be specified by the protocol using this profile. This profile may be used to carry IOR components, as specified in IOR Components on page 29.

The **profile_data** for the **TAG_MULTIPLE_COMPONENTS** profile is a CDR encapsulation of the **MultipleComponentProfile** type shown above.

7.6.4.3 The TAG_SCCP_IOP Profile

Issue 14399: fix references to OMG specs, and Remove redundant Annex A from this part

See the OMG specification [SCCP] and Annex A of Part 2 of this International Standard for additional information.

7.6.4.4 The TAG_UIPMC Profile

Issue 14397: fix self reference to this part

The **TAG_UIPMC** tag is used by MIOP. See clause 11 of this Part of this International standard and Annex A of Part 2 of this International Standard for additional information.

7.6.5 IOR Components

TaggedComponents contained in **TAG_INTERNET_IOP** and **TAG_MULTIPLE_COMPONENTS** profiles are identified by unique numeric tags using a namespace distinct from that is used for profile tags. Component tags are assigned by the OMG.

Specifications of components must include the following information:

- *Component ID*: The compound tag that is obtained from OMG.
- *Structure and encoding*: The syntax of the component data and the encoding rules. If the component value is encoded as a CDR encapsulation, the IDL type that is encapsulated and the GIOP version which is used for encoding the value, if different than GIOP 1.0, must be specified as part of the component definition.
- *Semantics*: How the component data is intended to be used.
- *Protocols*: The protocol for which the component is defined, and whether it is intended that the component be usable by other protocols.
- *At most once*: whether more than one instance of this component can be included in a profile.

Specifications of protocols must describe how the components affect the protocol. In addition, a protocol definition must specify, for each TaggedComponent, whether inclusion of the component in profiles supporting the protocol is required (MANDATORY PRESENCE) or not required (OPTIONAL PRESENCE). An ORB claiming to support Full-IOR conformance shall not drop optional components, once they have been added to a profile.

7.6.6 Standard IOR Components

Issue 14398: remove all DCE ESIOP tags and references

The following are standard IOR components that can be included in **TAG_INTERNET_IOP** and **TAG_MULTIPLE_COMPONENTS** profiles, and may apply to IIOP, other GIOPs, ESIOPs, or other protocols. An ORB must not drop these components from an existing IOR.

```
module IOP {
    const ComponentId TAG_ORB_TYPE = 0;
    const ComponentId TAG_CODE_SETS = 1;
    const ComponentId TAG_POLICIES = 2;
    const ComponentId TAG_ALTERNATE_IOP_ADDRESS = 3;
```

```

const ComponentId TAG_ASSOCIATION_OPTIONS = 13;
const ComponentId TAG_SEC_NAME = 14;
const ComponentId TAG_SPKM_1_SEC_MECH = 15;
const ComponentId TAG_SPKM_2_SEC_MECH = 16;
const ComponentId TAG_KerberosV5_SEC_MECH = 17;
const ComponentId TAG_CSI_ECMA_Secret_SEC_MECH = 18;
const ComponentId TAG_CSI_ECMA_Hybrid_SEC_MECH = 19;
const ComponentId TAG_SSL_SEC_TRANS = 20;
const ComponentId TAG_CSI_ECMA_Public_SEC_MECH = 21;
const ComponentId TAG_GENERIC_SEC_MECH = 22;
const ComponentId TAG_FIREWALL_TRANS = 23;
const ComponentId TAG_SCCP_CONTACT_INFO = 24;
const ComponentId TAG_JAVA_CODEBASE = 25;
const ComponentId TAG_TRANSACTION_POLICY = 26;
const ComponentId TAG_MESSAGE_ROUTERS = 30;
const ComponentId TAG_OTC_POLICY = 31;
const ComponentId TAG_INV_POLICY = 32;
const ComponentId TAG_CSI_SEC_MECH_LIST = 33;
const ComponentId TAG_NULL_TAG = 34;
const ComponentId TAG_SECIOP_SEC_TRANS = 35;
const ComponentId TAG_TLS_SEC_TRANS = 36;
const ComponentId TAG_ACTIVITY_POLICY = 37;
const ComponentId TAG_RMI_CUSTOM_MAX_STREAM_FORMAT = 38;
const ComponentId TAG_GROUP = 39;
const ComponentId TAG_GROUP_IOP = 40;
const ComponentId TAG_PASSTHRU_TRANS = 41;
const ComponentId TAG_FIREWALL_PATH = 42;
const ComponentId TAG_IOP_SEC_TRANS = 43;

const ComponentId TAG_INET_SEC_TRANS = 123;
};

```

7.6.6.1 TAG_ORB_TYPE Component

It is often useful in the real world to be able to identify the particular kind of ORB an object reference is coming from, to work around problems with that particular ORB, or exploit shared efficiencies.

The **TAG_ORB_TYPE** component has an associated value of type **unsigned long**, encoded as a CDR encapsulation, designating an ORB type ID allocated by the OMG for the ORB type of the originating ORB. Anyone may register any ORB types by submitting a short (one-paragraph) description of the ORB type to the OMG, and will receive a new ORB type ID in return. A list of ORB type descriptions and values will be made available on the OMG web server.

The **TAG_ORB_TYPE** component can appear at most once in any IOR profile. For profiles supporting IOP 1.1 or greater, it is optionally present.

7.6.6.2 TAG_ALTERNATE_IOP_ADDRESS Component

In cases where the same object key is used for more than one internet location, the following standard IOR Component is defined for support in IOP version 1.2.

The **TAG_ALTERNATE_IOP_ADDRESS** component has an associated value of type:

```

struct {
    string HostID,
    unsigned short Port
};

```

encoded as a CDR encapsulation.

Zero or more instances of the **TAG_ALTERNATE_IOP_ADDRESS** component type may be included in a version 1.2 **TAG_INTERNET_IOP** Profile. Each of these alternative addresses may be used by the client orb, in addition to the host and port address expressed in the body of the Profile. In cases where one or more **TAG_ALTERNATE_IOP_ADDRESS** components are present in a **TAG_INTERNET_IOP** Profile, no order of use is prescribed by Version 1.2 of IIOP.

7.6.6.3 Other Components

Issue 14399: change to use proper OMG spec references

The following standard components are specified in various OMG specifications:

- **TAG_CODE_SETS** - See CodeSet Component of IOR Multi-Component Profile in clause 7.10.2.4 of this part of this specification.
- **TAG_POLICIES** - See the “CORBA Messaging” clause of CORBA, v3.2 - Part 1.
- **TAG_SEC_NAME** - See the Mechanism Tags sub clause of [CORBASEC].
- **TAG_ASSOCIATION_OPTIONS** - See the Tag Association Options sub clause of [CORBASEC]
- **TAG_SSL_SEC_TRANS** - See the Mechanism Tags sub clause of [CORBASEC].
- **TAG_GENERIC_SEC_MECH** and all other tags with names in the form TAG_*_SEC_MECH - See the “Mechanism Tags” sub clause of [CORBASEC].
- **TAG_FIREWALL_SEC** - See [FIREWALL].
- **TAG_SCCP_CONTACT_INFO** - See [SCCP].
- **TAG_JAVA_CODEBASE** - See [JAV2I].
- **TAG_TRANSACTION_POLICY** - See [TRANS].
- **TAG_MESSAGE_ROUTERS** - See the “CORBA Messaging” clause of CORBA, v3.2 - Part 1.
- **TAG_OTS_POLICY** - See [TRANS].
- **TAG_INV_POLICY** - See [TRANS].
- **TAG_INET_SEC_TRANS** - See [CORBASEC].
- **TAG_CSI_SEC_MECH_LIST, TAG_NULL_TAG, TAG_SECIOP_SEC_TRANS, TAG_TLS_SEC_TRANS** - See the “Secure Interoperability” clause 10 (this part of the CORBA specification).
- **TAG_ACTIVITY_POLICY** - See [ASMOTS].
- **TAG_RMI_CUSTOM_MAX_STREAM_FORMAT** - See [JAV2I].
- **TAG_GROUP** and **TAG_GROUP_IOP** - See the “Unreliable Multicast Inter-ORB Protocol” clause 11 (this part of the CORBA specification).
- **TAG_IOP_SEC_TRANS** - See the “Secure Interoperability” clause 10 (this part of the CORBA specification).

7.6.7 Profile and Component Composition in IORs

The following rules augment the preceding discussion:

1. Profiles must be independent, complete, and self-contained. Their use shall not depend on information contained in another profile.
2. Any invocation uses information from exactly one profile.
3. Information used to drive multiple inter-ORB protocols may coexist within a single profile, possibly with some information (e.g., components) shared between the protocols, as specified by the specific protocols.
4. Unless otherwise specified in the definition of a particular profile, multiple profiles with the same profile tag may be included in an IOR.
5. Unless otherwise specified in the definition of a particular component, multiple components with the same component tag may be part of a given profile within an IOR.
6. A **TAG_MULTIPLE_COMPONENTS** profile may hold components shared between multiple protocols. Multiple such profiles may exist in an IOR.
7. The definition of each protocol using a **TAG_MULTIPLE_COMPONENTS** profile must specify which components it uses, and how it uses them.
8. Profile and component definitions can be either public or private. Public definitions are those whose tag and data format is specified in OMG documents. For private definitions, only the tag is registered with OMG.
9. Public component definitions shall state whether or not they are intended for use by protocols other than the one(s) for which they were originally defined, and dependencies on other components.

The OMG is responsible for allocating and registering protocol and component tags. Neither allocation nor registration indicates any “standard” status, only that the tag will not be confused with other tags. Requests to allocate tags should be sent to tag_request@omg.org.

7.6.8 IOR Creation and Scope

IORs are created from object references when required to cross some kind of referencing domain boundary. ORBs will implement object references in whatever form they find appropriate, including possibly using the IOR structure. Bridges will normally use IORs to mediate transfers where that standard is appropriate.

7.6.9 Stringified Object References

Object references can be “stringified” (turned into an external string form) by the **ORB::object_to_string** operation, and then “destringified” (turned back into a programming environment’s object reference representation) using the **ORB::string_to_object** operation.

There can be a variety of reasons why being able to parse this string form might *not* help make an invocation on the original object reference:

- Identifiers embedded in the string form can belong to a different domain than the ORB attempting to destringify the object reference.

If conversion fails, **string_to_object** raises a BAD_PARAM exception with one of following standard minor codes, as appropriate:

Minor Code	Description
7	string_to_object conversion failed due to bad scheme name
8	string_to_object conversion failed due to bad address
9	string_to_object conversion failed due to bad schema specific part
10	string_to_object conversion failed due to non-specific reason

7.6.10.1 corbaloc URL

The **corbaloc** URL scheme provides stringified object references that are more easily manipulated by users than **IOR** URLs. Currently, **corbaloc** URLs denote objects that can be contacted by IOP or **resolve_initial_references**. Other transport protocols can be explicitly specified when they become available. Examples of IOP and **resolve_initial_references** (**rir:**) based **corbaloc** URLs are:

```

corbaloc::555xyz.com/Prod/TradingService
corbaloc:iop:1.1@555xyz.com/Prod/TradingService
corbaloc::555xyz.com,:556xyz.com:80/Dev/NameService
corbaloc:rir:/TradingService
corbaloc:rir:/NameService
corbaloc:iop:192.168.14.25:555/NameService
corbaloc::[1080::8:800:200C:417A]:88/DefaultEventChannel

```

A **corbaloc** URL contains one or more:

- protocol identifiers
- protocol specific components such as address and protocol version information

When the **rir** protocol is used, no other protocols are allowed. After the addressing information, a **corbaloc** URL ends with a single object key. The full syntax is:

```

<corbaloc>           = "corbaloc:"<obj_addr_list>["/"<key_string>]
<obj_addr_list>     = [<obj_addr> ","]* <obj_addr>
<obj_addr>          = <prot_addr> | <future_prot_addr>
<prot_addr>         = <rir_prot_addr> | <iiop_prot_addr>

<rir_prot_addr>     = <rir_prot_token>":"
<rir_prot_token>    = "rir"

<iiop_prot_addr>    = <iiop_id><iiop_addr>
<iiop_id>           = ":" | <iiop_prot_token>":"
<iiop_prot_token>  = "iiop"
<iiop_addr>        = [<version> <host> [":" <port>]]
<host>             = DNS_style_host_name | ip_address
<host>             = DNS_style_host_name | IPv4_address
                   | "[" IPv6_address "]"
<version>          = <major> "." <minor> "@" | empty_string
<port>             = number

```

<major>	= number
<minor>	= number
<future_prot_addr>	= <future_prot_id><future_prot_addr>
<future_prot_id>	= <future_prot_token>”.”
<future_prot_token>	= possible examples: “atm” “dce”
<future_prot_addr>	= protocol specific address
<key_string>	= <string> empty_string

Where:

obj_addr_list: comma-separated list of protocol id, version, and address information. This list is used in an implementation-defined manner to address the object. An object may be contacted by any of the addresses and protocols.

NOTE: If the **rir** protocol is used, no other protocols are allowed.

obj_addr: A protocol identifier, version tag, and a protocol specific address. The comma ‘,’ and ‘/’ characters are specifically prohibited in this component of the URL.

rir_prot_addr: **resolve_initial_references** protocol identifier. This protocol does not have a version tag or address. See 7.6.10.2, ‘corbaloc:rir URL’.

iiop_prot_addr: **iiop** protocol identifier, version tag, and address containing a DNS-style host name or IP address. See corbaloc:iiop URL on page 36 for the iiop specific definitions.

future_prot_addr: a placeholder for future **corbaloc** protocols.

future_prot_id: token representing a protocol terminated with a “:”.

future_prot_token: token representing a protocol. Currently only “**iiop**” and “**rir**” are defined.

future_prot_addr: a protocol specific address and possibly protocol version information. An example of this for **iiop** is “1.1@555xyz.com.”

key_string: a stringified object key.

The **key_string** corresponds to the octet sequence in the **object_key** member of a **GIOP Request** or **LocateRequest** header as defined in 15.4 of CORBA 2.3. The **key_string** uses the escape conventions described in RFC 2396 to map away from octet values that cannot directly be part of a URL. US-ASCII alphanumeric characters are not escaped. Characters outside this range are escaped, except for the following:

```
“,” | “/” | “.” | “?” | “:” | “@” | “&” | “=” | “+” | “$” |
“ ” | “_” | “_” | “!” | “~” | “*” | “” | “(“ | “)”
```

The **key_string** is not NUL-terminated.

7.6.10.2 corbaloc:rir URL

The **corbaloc:rir** URL is defined to allow access to the ORB’s configured initial references through a URL. The protocol address syntax is:

<rir_prot_addr>	= <rir_prot_token>”.”
<rir_prot_token>	= “rir”

Where:

rir_prot_addr: **resolve_initial_references** protocol identifier. There is no version or address information when **rir** is used.

rir_prot_token: The token “**rir**” identifies this protocol.

For a **corbaloc:rir** URL, the **<key_string>** is used as the argument to **resolve_initial_references**. An empty **<key_string>** is interpreted as the default “**NameService**.”

The **rir** protocol cannot be used with any other protocol in a URL.

7.6.10.3 corbaloc:iiop URL

The **corbaloc:iiop** URL is defined for use in TCP/IP- and DNS-centric environments. The full protocol address syntax is:

<iiop_prot_addr>	= <iiop_id><iiop_addr>
<iiop_id>	= <iiop_default> <iiop_prot_token>”.”
<iiop_default>	= “.”
<iiop_prot_token>	= “iiop”
<iiop_addr>	= [<version> <host> [“:” <port>]]
<host>	= DNS_style_host_name IPv4_address “[IPv6_address]”
<version>	= <major> “.” <minor> “@” empty_string
<port>	= number
<major>	= number
<minor>	= number

Where:

iiop_prot_addr: iiop protocol identifier, version tag, and address containing a DNS-style host name or IP address.

iiop_id: tokens recognized to indicate an iiop protocol corbaloc.

iiop_default: default token indicating iiop protocol, “.”.

iiop_prot_token: iiop protocol token, “iiop.”

iiop_address: a single address.

host: DNS-style host name or IP address. If not present, the local host is assumed.

version: a major and minor version number, separated by ‘.’ and followed by ‘@’. If the version is absent, 1.0 is assumed.

IPv4_address: numeric IPv4 address (dotted decimal notation).

IPv6_address: numeric IPv6 address (colon separated hexadecimal or mixed hexadecimal/decimal notation as described in RFC 2373).

port: port number the agent is listening on (see below). Default is 2809.

7.6.10.4 corbaloc Server Implementation

The only requirements on an object advertised by a **corbaloc** URL are that there must be a software agent listening on the host and port specified by the URL. This agent must be capable of handling GIOP **Request** and **LocateRequest** messages targeted at the object key specified in the URL.

A normal CORBA server meets these criteria. It is also possible to implement lightweight object location forwarding agents that respond to GIOP **Request** messages with **Reply** messages with a **LOCATION_FORWARD** status, and respond to GIOP **LocateRequest** messages with **LocateReply** messages.

7.6.10.5 corbaname URL

The **corbaname** URL scheme is described in the Naming Service specification. It extends the capabilities of the **corbaloc** scheme to allow URLs to denote entries in a Naming Service. Resolving **corbaname** URLs does not require a Naming Service implementation in the ORB core. Some examples are:

corbaname::555objs.com#a/string/path/to/obj

This URL specifies that at host **555objs.com**, an object of type **NamingContext** (with an object key of **NameService**) can be found, or alternatively, that an agent is running at that location which will return a reference to a **NamingContext**. The (stringified) name **a/string/path/to/obj** is then used as the argument to a **resolve** operation on that **NamingContext**. The URL denotes the object reference that results from that lookup.

corbaname:rir:#a/local/obj

This URL specifies that the stringified name **a/local/obj** is to be resolved relative to the naming context returned by **resolve_initial_references("NameService")**.

7.6.10.6 Future corbaloc URL Protocols

This specification only defines use of **iiop** with **corbaloc**. New protocols can be added to **corbaloc** as required. Each new protocol must implement the **<future_prot_addr>** component of the URL and define described in **corbaloc** URL on page 34.

A possible example of a future **corbaloc** URL that incorporates an ATM address is:

corbaloc:iiop:xyz.com,atm:E.164:358.400.1234567/dev/test/objectX

7.6.10.7 Future URL Schemes

Several currently defined non-CORBA URL scheme names are reserved. Implementations may choose to provide these or other URL schemes to support additional ways of denoting objects with URLs.

Table 7.1 lists the required and some optional formats.

Table 7.1

Scheme	Description	Status
IOR:	Standard stringified IOR format	Required
corbaloc:	Simple object reference. rir: must be supported.	Required
corbaname:	CosName URL	Required

Table 7.1

Scheme	Description	Status
file://	Specifies a file containing a URL/IOR	Optional
ftp://	Specifies a file containing a URL/IOR that is accessible via ftp protocol.	Optional
http://	Specifies an HTTP URL that returns an object URL/IOR.	Optional

7.7 Service Context

Emerging specifications for Object Services occasionally require service-specific context information to be passed implicitly with requests and replies. The Interoperability specifications define a mechanism for identifying and passing this service-specific context information as “hidden” parameters. The specification makes the following assumptions:

- Object Service specifications that need additional context passed will completely specify that context as an OMG IDL data type.
- ORB APIs will be provided that will allow services to supply and consume context information at appropriate points in the process of sending and receiving requests and replies.
- It is an ORB’s responsibility to determine when to send service-specific context information, and what to do with such information in incoming messages. It may be possible, for example, for a server receiving a request to be unable to de-encapsulate and use a certain element of service-specific context, but nevertheless still be able to successfully reply to the message.

As shown in the following OMG IDL specification, the IOP module provides the mechanism for passing Object Service-specific information. It does not describe any service-specific information. It only describes a mechanism for transmitting it in the most general way possible. The mechanism is currently used by the DCE ESIOp and could also be used by the Internet Inter-ORB protocol (IIOP) General Inter-ORB Protocol (GIOP).

Each Object Service requiring implicit service-specific context to be passed through GIOP will be allocated a unique service context ID value by OMG. Service context ID values are of type **unsigned long**. Object service specifications are responsible for describing their context information as single OMG IDL data types, one data type associated with each service context ID.

The marshaling of Object Service data is described by the following OMG IDL:

```

module IOP {
    // IDL

    typedef unsigned long          ServiceId;
    typedef CORBA::OctetSeq ContextData;

    struct ServiceContext {
        ServiceId          context_id;
        ContextData       context_data;
    };
    typedef sequence <ServiceContext>ServiceContextList;
};

```

The context data for a particular service will be encoded as specified for its service-specific OMG IDL definition, and that encoded representation will be encapsulated in the **context_data** member of **IOP::ServiceContext** (see Encapsulation on page 79). The **context_id** member contains the service ID value identifying the service and data format. Context data is encapsulated in octet sequences to permit ORBs to handle context data without unmarshaling, and to handle unknown context data types.

During request and reply marshaling, ORBs will collect all service context data associated with the *Request* or *Reply* in a **ServiceContextList**, and include it in the generated messages. No ordering is specified for service context data within the list. The list is placed at the beginning of those messages to support security policies that may need to apply to the majority of the data in a request (including the message headers).

Each Object Service requiring implicit service-specific context to be passed through GIOP will be allocated a unique service context ID value by the OMG. Service context ID values are of type unsigned long. Object service specifications are responsible for describing their context information as single OMG IDL data types, one data type associated with each service context ID.

The high-order 24 bits of a service context ID contain a 24-bit vendor service context codeset ID (VSCID); the low-order 8 bits contain the rest of the service context ID. A vendor (or group of vendors) who wishes to define a specific set of service context IDs should obtain a unique VSCID from the OMG, and then define a specific set of service context IDs using the VSCID for the high-order bits.

The VSCIDs of zero to 15 inclusive (0x000000 to 0x00000f) are reserved for use for OMG-defined standard service context IDs (i.e., service context IDs in the range 0-4095 are reserved as OMG standard service contexts).

7.7.1 Standard Service Contexts

```

module IOP {
    const Serviced TransactionService = 0;
    const Serviced CodeSets = 1;
    const Serviced ChainBypassCheck = 2;
    const Serviced ChainBypassInfo = 3;
    const Serviced LogicalThreadId = 4;
    const Serviced BI_DIR_IOP = 5;
    const Serviced SendingContextRunTime = 6;
    const Serviced INVOCATION_POLICIES = 7;
    const Serviced FORWARDED_IDENTITY = 8;
    const Serviced UnknownExceptionInfo = 9;
    const Serviced RTCorbaPriority = 10;
    const Serviced RTCorbaPriorityRange = 11;
    const Serviced FT_GROUP_VERSION = 12;
    const Serviced FT_REQUEST = 13;
    const Serviced ExceptionDetailMessage = 14;
    const Serviced SecurityAttributeService = 15;
    const Serviced ActivityService = 16;
    const Serviced RMICustomMaxStreamFormat = 17;
    const Serviced ACCESS_SESSION_ID = 18;
    const Serviced SERVICE_SESSION_ID = 19;
    const Serviced FIREWALL_PATH = 20;
    const Serviced FIREWALL_PATH_RESP = 21;
};
// IDL

```

The standard **ServiceIds** currently defined are:

- **TransactionService** identifies a CDR encapsulation of the **CosTransactions::PropogationContext** defined in the Object Transaction Service specification [TRANS].
- **CodeSets** identifies a CDR encapsulation of the **CONV_FRAME::CodeSetContext** defined in GIOP Code Set Service Context on page 52.
- DCOM-CORBA Interworking uses three service contexts as defined in “DCOM-CORBA Interworking” in [DCOMI]. They are:
 - **ChainBypassCheck**, which carries a CDR encapsulation of the **struct CosBridging::ChainBypassCheck**. This is carried only in a **Request** message as described in [DCOMI].
 - **ChainBypassInfo**, which carries a CDR encapsulation of the **struct CosBridging::ChainBypassInfo**. This is carried only in a **Reply** message as described in [DCOMI].
 - **LogicalThreadId**, which carries a CDR encapsulation of the **struct CosBridging::LogicalThreadId** as described in [DCOMI].
- **BI_DIR_IOP** identifies a CDR encapsulation of the **IOP::BiDirIOPServiceContext** defined in the General Inter-ORB Protocol clause of this part of this InternationalStandard.
- **SendingContextRunTime** identifies a CDR encapsulation of the IOR of the **SendingContext::RunTime** object. See the Value Type Semantics clause (Part 1 of this International Standard).
- For information on **INVOCATION_POLICIES** refer to the CORBA Messaging clause (see Part 1 of this International Standard).
- For information on **FORWARDED_IDENTITY** refer to the Firewall Traversal specification ([FIREWALL]).
- **UnknownExceptionInfo** identifies a CDR encapsulation of a marshaled instance of a **java.lang.throwable** or one of its subclasses as described in the Java to IDL Mapping specification [JAVA2I].
- For information on **RTCorbaPriority** refer to the Real-time CORBA specification [RTCORBA].
- For information on **RTCorbaPriorityRange** refer to the Real-time CORBA specification [RTCORBA].
- **FT_GROUP_VERSION, FT_REQUEST** - refer to the Fault Tolerant CORBA [FTCORBA].
- **ExceptionDetailMessage** identifies a CDR encapsulation of a wstring, encoded using GIOP 1.2 with a TCS-W of UTF-16. This service context may be sent on Reply messages with a **reply_status** of **SYSTEM_EXCEPTION** or **USER_EXCEPTION**. The usage of this service context is defined by language mappings.
- **SecurityAttributeService** - refer to the Secure Interoperability clause (Part 2 of this International Standard).
- **ActivityService** - refer to the Additional Structuring Mechanisms for OTS specification [ASMOTS].
- **RMICustomMaxStreamFormat** - refer to the Java to IDL Language Mapping specification [JAVA2I].
- **ACCESS_SESSION_ID** and **SERVICE_SESSION_ID** - refer to the Telecommunication Service Access and Subscription Specification [TSAS}.
- **FIREWALL_PATH** and **FIREWALL_PATH_RESP** - refer to the Firewall Traversal specification ([FIREWALL]).

7.7.2 Service Context Processing Rules

Service context IDs are associated with a specific version of GIOP, but will always be allocated in the OMG service context range. This allows any ORB to recognize when it is receiving a standard service context, even if it has been defined in a version of GIOP that it does not support.

The following are the rules for processing a received service context:

- The service context is in the OMG defined range:
 - If it is valid for the supported GIOP version, then it must be processed correctly according to the rules associated with it for that GIOP version level.
 - If it is not valid for the GIOP version, then it may be ignored by the receiving ORB; however, it must be passed on through a bridge and must be made available to interceptors. No exception shall be raised.
- The service context is not in the OMG-defined range:
 - The receiving ORB may choose to ignore it, or process it if it “understands” it; however, the service context must be passed on through a bridge and must be made available to interceptors.

7.8 Coder/Decoder Interfaces

The formats of IOR components and service context data used by ORB services are often defined as CDR encapsulations encoding instances of IDL defined data types. The **Codec** provides a mechanism to transfer these components between their IDL data types and their CDR encapsulation representations.

A **Codec** is obtained from the **CodecFactory**. The **CodecFactory** is obtained through a call to **ORB::resolve_initial_references (“CodecFactory”)**.

7.8.1 Codec Interface

```
module IOP {
  local interface Codec {
    exception InvalidTypeForEncoding {};
    exception FormatMismatch {};
    exception TypeMismatch {};

    CORBA::OctetSeq encode (in any data)
      raises (InvalidTypeForEncoding);
    any decode (in CORBA::OctetSeq data)
      raises (FormatMismatch);
    CORBA::OctetSeq encode_value (in any data)
      raises (InvalidTypeForEncoding);
    any decode_value (
      in CORBA::OctetSeq data,
      in CORBA::TypeCode tc)
      raises (FormatMismatch, TypeMismatch);
  };
};
```

7.8.1.1 Exceptions

InvalidTypeForEncoding

This exception is raised by **encode** or **encode_value** when the type is invalid for the encoding. For example, this exception is raised if the encoding is **ENCODING_CDR_ENCAPS** version 1.0 and a type that does not exist in that version, such as **wstring**, is passed to the operation.

FormatMismatch

This exception is raised by **decode** or **decode_value** when the data in the octet sequence cannot be decoded into an **any**.

TypeMismatch

This exception is raised by **decode_value** when the given **TypeCode** does not match the given octet sequence.

7.8.1.2 Operations

encode

Convert the given **any** into an octet sequence based on the encoding format effective for this **Codec**. This operation may raise **InvalidTypeForEncoding**.

<i>Parameter:</i> data	The data, in the form of an any , to be encoded into an octet sequence.
<i>Return Value:</i>	An octet sequence containing the encoded any . This octet sequence contains both the TypeCode and the data of the type.

decode

Decode the given octet sequence into an **any** based on the encoding format effective for this **Codec**. This operation raises **FormatMismatch** if the octet sequence cannot be decoded into an **any**.

<i>Parameter:</i> data	The data, in the form of an octet sequence, to be decoded into an any .
<i>Return Value:</i>	An any containing the data from the decoded octet sequence.

encode_value

Convert the given **any** into an octet sequence based on the encoding format effective for this **Codec**. Only the data from the **any** is encoded, not the **TypeCode**. This operation may raise **InvalidTypeForEncoding**.

<i>Parameter:</i> data	The data, in the form of an any , to be encoded into an octet sequence.
<i>Return Value:</i>	An octet sequence containing the data from the encoded any .

decode_value

Decode the given octet sequence into an **any** based on the given **TypeCode** and the encoding format effective for this **Codec**. This operation raises **FormatMismatch** if the octet sequence cannot be decoded into an **any**.

<i>Parameters:</i>	
data	The data, in the form of an octet sequence, to be decoded into an any .
tc	The TypeCode to be used to decode the data.
<i>Return Value:</i>	An any containing the data from the decoded octet sequence.

7.8.2 Codec Factory

```
module IOP {
    typedef short EncodingFormat;
    const EncodingFormat ENCODING_CDR_ENCAPS = 0;

    struct Encoding {
        EncodingFormat format;
        octet major_version;
        octet minor_version;
    };

    local interface CodecFactory {
        exception UnknownEncoding {};
        Codec create_codec (in Encoding enc)
            raises (UnknownEncoding);
    };
};
```

7.8.2.1 Encoding Structure

The **Encoding** structure defines the encoding format of a **Codec**. It details the encoding format, such as CDR Encapsulation encoding, and the major and minor versions of that format. The encodings which shall be supported are:

- **ENCODING_CDR_ENCAPS**, version 1.0;
- **ENCODING_CDR_ENCAPS**, version 1.1;
- **ENCODING_CDR_ENCAPS**, version 1.2;
- **ENCODING_CDR_ENCAPS** for all future versions of GIOP as they arise.

Vendors are free to support additional encodings.

7.8.2.2 CodecFactory Interface

create_codec

Create a **Codec** of the given encoding.

This operation raises **UnknownEncoding** if this factory cannot create a **Codec** of the given encoding.

<i>Parameter:</i> enc	The Encoding for which to create a Codec .
<i>Return Value:</i>	A Codec obtained with the given encoding.

7.9 Feature Support and GIOP Versions

The association of service contexts with GIOP versions, (along with some other supported features tied to GIOP minor version), is shown in Table 7.2.

Table 7.2 Feature Support Tied to Minor GIOP Version Number

Feature	V1.0	V1.1	V1.2	V1.3	V1.4
TransactionService Service Context	yes	yes	yes	yes	yes
CodeSets Service Context		yes	yes	yes	yes
DCOM Bridging Service Contexts: ChainBypassCheck ChainBypassInfo LogicalThreadId			yes	yes	yes
Object by Value Service Context: SendingContextRunTime			yes	yes	yes
Bi-Directional IOP Service Context: BI_DIR_IOP			yes	yes	yes
Asynch Messaging Service Context: INVOCATION_POLICIES			optional [§]	yes	yes
Firewall Service Context: FORWARDED_IDENTITY			optional [§]	yes	yes

Table 7.2 Feature Support Tied to Minor GIOP Version Number (Continued)

Feature	V1.0	V1.1	V1.2	V1.3	V1.4
Java Language Throwable Service Context: UnknownExceptionInfo			yes	yes	yes
Realtime CORBA Service Contexts RTCorbaPriority RTCorbaPriorityRange			optional (Realtime CORBA only)	optional (Realtime CORBA only)	optional (Realtime CORBA only)
ExceptionDetailMessage Service Context			optional	yes	yes
FT_GROUP_VERSION			optional ^{\$\$}	yes	yes
FT_REQUEST			optional ^{\$\$}	yes	yes
SecurityAttributeService			optional ^{\$\$}	yes	yes
ActivityService			optional ^{\$\$}	yes	yes
IOR components in IIOP profile		yes	yes	yes	yes
TAG_ORB_TYPE		yes	yes	yes	yes
TAG_CODE_SETS		yes	yes	yes	yes
TAG_ALTERNATE_IIOP_ADDRESS			yes	yes	yes
TAG_ASSOCIATION_OPTION		yes	yes	yes	yes
TAG_SEC_NAME		yes	yes	yes	yes
TAG_SSL_SEC_TRANS		yes	yes	yes	yes
TAG_GENERIC_SEC_MECH		yes	yes	yes	yes
TAG_*_SEC_MECH		yes	yes	yes	yes
TAG_JAVA_CODEBASE			yes	yes	yes
TAG_FIREWALL_TRANS			optional ^{\$}	yes	yes
TAG_SCCP_CONTACT_INFO			optional ^{\$}	yes	yes
TAG_TRANSACTION_POLICY			optional ^{\$}	yes	yes
TAG_MESSAGE_ROUTERS			optional ^{\$}	yes	yes
TAG_OTS_POLICY			optional ^{\$}	yes	yes
TAG_INV_POLICY			optional ^{\$}	yes	yes
TAG_INET_SEC_TRANS			optional ^{\$}	yes	yes
Extended IDL data types		yes	yes	yes	yes
Bi-Directional GIOP Features			yes	yes	yes
Value types and Abstract Interfaces			yes	yes	yes
TAG_CSI_SEC_MECH_LIST			optional ^{\$\$}	yes	yes
TAG_NULL_TAG			optional ^{\$\$}	yes	yes

Table 7.2 Feature Support Tied to Minor GIOP Version Number (Continued)

Feature	V1.0	V1.1	V1.2	V1.3	V1.4
TAG_SECIOP_SEC_TRANS, TAG_IIOB_SEC_TRANS			optional ^{\$\$}	yes	yes
TAG_TLS_SEC_TRANS			optional ^{\$\$}	yes	yes
TAG_ACTIVITY_POLICY			optional ^{\$\$}	yes	yes
_component				yes	yes
tk_abstract_interface tk_local_interfacel			optional ^{\$\$}	yes	yes
tk_component tk_home tk_event				yes	yes
_repository_id					yes
IPV6 addresses in IOR					yes
TAG_GROUP, TAG_GROUP_IIOB and TAG_UIPMC + Group features					optional
RMICustomMaxStreamFormat TAG_RMI_CUSTOM_MAX_STREAM_FORMAT					optional

NOTE: ^{\$, \$\$}All features that have been added after CORBA 2.3 have been marked as optional in GIOP 1.2. These features cannot be compulsory in GIOP 1.2 since there is no way to incorporate them in deployed implementations of 1.2. However, in order to have the additional features of CORBA 2.4 work properly these optional features must be supported by the GIOP 1.2 implementation connecting CORBA 2.4^{\$} or later ORBs.

7.10 Code Set Conversion

7.10.1 Character Processing Terminology

This sub clause introduces a few terms and explains a few concepts to help understand the character processing portions of this clause.

7.10.1.1 Character Set

A finite set of different characters used for the representation, organization, or control of data. In this specification, the term “character set” is used without any relationship to code representation or associated encoding. Examples of character sets are the English alphabet, Kanji or sets of ideographic characters, corporate character sets (commonly used in Japan), and the characters needed to write certain European languages.

7.10.1.2 Coded Character Set, or Code Set

A set of unambiguous rules that establishes a character set and the one-to-one relationship between each character of the set and its bit representation or numeric value. In this specification, the term “code set” is used as an abbreviation for the term “coded character set.” Examples include ASCII, ISO 8859-1, JIS X0208, which includes Roman characters, Japanese hiragana, Greek characters, Japanese kanji, etc. and Unicode.

7.10.1.3 Code Set Classifications

Some language environments distinguish between byte-oriented and “wide characters.” The byte-oriented characters are encoded in one or more 8-bit bytes. A typical single-byte encoding is ASCII as used for western European languages like English. A typical multi-byte encoding that uses from one to three 8-bit bytes for each character is eucJP (Extended UNIX Code - Japan, packed format) as used for Japanese workstations.

Wide characters are a fixed 16 or 32 bits long, and are used for languages like Chinese, Japanese, etc., where the number of combinations offered by 8 bits is insufficient and a fixed-width encoding is needed. A typical example is Unicode (a “universal” character set defined by the Unicode Consortium, which uses an encoding scheme identical to ISO 10646 UCS-2, or 2-byte Universal Character Set encoding). An extended encoding scheme for Unicode characters is UTF-16 (UCS Transformation Format, 16-bit representations).

The C language has data types **char** for byte-oriented characters and **wchar_t** for wide characters. The language definition for C states that the sizes for these characters are implementation-dependent. Some environments do not distinguish between byte-oriented and wide characters (e.g., Ada and Smalltalk). Here again, the size of a character is implementation-dependent. The following table illustrates code set classifications as used in this document.

Table 7.3 - Code Set Classification

Orientation	Code Element Encoding	Code Set Examples	C Data Type
byte-oriented	single-byte	ASCII, ISO 8859-1 (Latin-1), EBCDIC, ...	char
	multi-byte	UTF-8, eucJP, Shift-JIS, JIS, Big5, ...	char[]
non-byte-oriented	fixed-length	ISO 10646 UCS-2 (Unicode), ISO 10646 UCS-4, UTF-16, ...	wchar_t

7.10.1.4 Narrow and Wide Characters

Some language environments distinguish between “narrow” and “wide” characters. Typically the narrow characters are considered to be 8-bit long and are used for western European languages like English, while the wide characters are 16-bit or 32-bit long and are used for languages like Chinese, Japanese, etc., where the number of combinations offered by 8 bits are insufficient. However, as noted above there are common encoding schemes in which Asian characters are encoded using multi-byte code sets and it is incorrect to assume that Asian characters are always encoded as “wide” characters.

Within this specification, the general terms “narrow character” and “wide character” are only used in discussing OMG IDL.

7.10.1.5 Char Data and Wchar Data

The phrase “**char** data” in this specification refers to data whose IDL types have been specified as **char** or **string**. Likewise “**wchar** data” refers to data whose IDL types have been specified as **wchar** or **wstring**.

7.10.1.6 Byte-Oriented Code Set

An encoding of characters where the numeric code corresponding to a character code element can occupy one or more bytes. A byte as used in this specification is synonymous with octet, which occupies 8 bits.

7.10.1.7 Multi-Byte Character Strings

A character string represented in a byte-oriented encoding where each character can occupy one or more bytes is called a multi-byte character string. Typically, wide characters are converted to this form from a (fixed-width) process code set before transmitting the characters outside the process (see below about process code sets). Care must be taken to correctly process the component bytes of a character’s multi-byte representation.

7.10.1.8 Non-Byte-Oriented Code Set

An encoding of characters where the numeric code corresponding to a character code element can occupy fixed 16 or 32 bits.

7.10.1.9 Char and Wchar Transmission Code Set (TCS-C and TCS-W)

These two terms refer to code sets that are used for transmission between ORBs after negotiation is completed. As the names imply, the first one is used for **char** data and the second one for **wchar** data. Each TCS can be byte-oriented or non-byte oriented.

7.10.1.10 Process Code Set and File Code Set

Processes generally represent international characters in an internal fixed-width format which allows for efficient representation and manipulation. This internal format is called a “process code set.” The process code set is irrelevant outside the process, and hence to the interoperation between CORBA clients and servers through their respective ORBs.

When a process needs to write international character information out to a file, or communicate with another process (possibly over a network), it typically uses a different encoding called a “file code set.” In this specification, unless otherwise indicated, all references to a program’s code set refer to the file code set, not the process code set. Even when a client and server are located physically on the same machine, it is possible for them to use different file code sets.

7.10.1.11 Native Code Set

A native code set is the code set that a client or a server uses to communicate with its ORB. There might be separate native code sets for **char** and **wchar** data.

7.10.1.12 Transmission Code Set

A transmission code set is the commonly agreed upon encoding used for character data transfer between a client’s ORB and a server’s ORB. There are two transmission code sets established per session between a client and its server, one for **char** data (TCS-C) and the other for **wchar** data (TCS-W). Figure 7.6 illustrates these relationships:

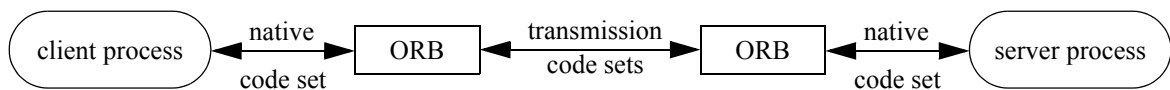

Figure 7.6 - Transmission Code Sets

The intent is for TCS-C to be byte-oriented and TCS-W to be non-byte-oriented. However, this specification does allow both types of characters to be transmitted using the same transmission code set. That is, the selection of a transmission code set is orthogonal to the wideness or narrowness of the characters, although a given code set may be better suited for either narrow or wide characters.

7.10.1.13 Conversion Code Set (CCS)

With respect to a particular ORB's native code set, the set of other or target code sets for which an ORB can convert all code points or character encodings between the native code set and that target code set. For each code set in this CCS, the ORB maintains appropriate translation or conversion procedures and advertises the ability to use that code set for transmitted data in addition to the native code set.

7.10.2 Code Set Conversion Framework

7.10.2.1 Requirements

The file code set that an application uses is often determined by the platform on which it runs. In Japan, for example, Japanese EUC is used on Unix systems, while Shift-JIS is used on PCs. Code set conversion is therefore required to enable interoperability across these platforms. This specification defines a framework for the automatic conversion of code sets in such situations. The requirements of this framework are:

1. Backward compatibility. In previous CORBA specifications, IDL type **char** was limited to ISO 8859-1. The conversion framework should be compatible with existing clients and servers that use ISO 8859-1 as the code set for **char**.
2. Automatic code set conversion. To facilitate development of CORBA clients and servers, the ORB should perform any necessary code set conversions automatically and efficiently. The IDL type **octet** can be used if necessary to prevent conversions.
3. Locale support. An internationalized application determines the code set in use by examining the LOCALE string (usually found in the LANG environment variable), which may be changed dynamically at run time by the user. Example LOCALE strings are fr_FR.ISO8859-1 (French, used in France with the ISO 8859-1 code set) and ja_JP.ujis (Japanese, used in Japan with the EUC code set and X11R5 conventions for LOCALE). The conversion framework should allow applications to use the LOCALE mechanism to indicate supported code sets, and thus select the correct code set from the registry.
4. CMIR and SMIR support. The conversion framework should be flexible enough to allow conversion to be performed either on the client or server side. For example, if a client is running in a memory-constrained environment, then it is desirable for code set converters to reside in the server and for a Server Makes It Right (SMIR) conversion method to be used. On the other hand, if many servers are executed on one server machine, then converters should be placed in each client to reduce the load on the server machine. In this case, the conversion method used is Client Makes It Right (CMIR).

7.10.2.2 Overview of the Conversion Framework

Both the client and server indicate a native code set indirectly by specifying a locale. The exact method for doing this is language-specific, such as the XPG4 C/C++ function **setlocale**. The client and server use their native code set to communicate with their ORB. (Note that these native code sets are in general different from process code sets and hence conversions may be required at the client and server ends.)

The conversion framework is illustrated in Figure 7.7. The server-side ORB stores a server's code set information in a component of the IOR multiple-component profile structure (see Interoperable Object References: IORs on page 25)¹. The code sets actually used for transmission are carried in the service context field of an IOP (Inter-ORB Protocol) request header (see Service Context on page 38 and GIOP Code Set Service Context on page 52). Recall that there are two code sets (TCS-C and TCS-W) negotiated for each session.

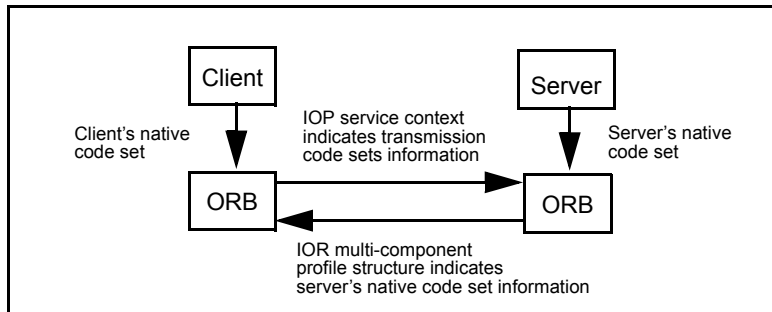

Figure 7.7 - Code Set Conversion Framework Overview

If the native code sets used by a client and server are the same, then no conversion is performed. If the native code sets are different and the client-side ORB has an appropriate converter, then the CMIR conversion method is used. In this case, the server's native code set is used as the transmission code set. If the native code sets are different and the client-side ORB does not have an appropriate converter but the server-side ORB does have one, then the SMIR conversion method is used. In this case, the client's native code set is used as the transmission code set.

The conversion framework allows clients and servers to specify a native **char** code set and a native **wchar** code set, which determine the local encodings of IDL types **char** and **wchar**, respectively. The conversion process outlined above is executed independently for the **char** code set and the **wchar** code set. In other words, the algorithm that is used to select a transmission code set is run twice, once for **char** data and once for **wchar** data.

The rationale for selecting two transmission code sets rather than one (which is typically inferred from the locale of a process) is to allow efficient data transmission without any conversions when the client and server have identical representations for **char** and/or **wchar** data. For example, when a Windows NT client talks to a Windows NT server and they both use Unicode for wide character data, it becomes possible to transmit wide character data from one to the other without any conversions. Of course, this becomes possible only for those wide character representations that are well-defined, not for any proprietary ones. If a single transmission code set was mandated, it might require unnecessary conversions. (For example, choosing Unicode as the transmission code set would force conversion of all byte-oriented character data to Unicode.)

7.10.2.3 ORB Databases and Code Set Converters

The conversion framework requires an ORB to be able to determine the native code set for a locale and to convert between code sets as necessary. While the details of exactly how these tasks are accomplished are implementation-dependent, the following databases and code set converters might be used:

1. Version 1.1 of the IIOP profile body can also be used to specify the server's code set information, as this version introduces an extra field that is a sequence of tagged components.

- Locale database. This database defines a native code set for a process. This code set could be byte-oriented or non-byte-oriented and could be changed programmatically while the process is running. However, for a given session between a client and a server, it is fixed once the code set information is negotiated at the session's setup time.
- Environment variables or configuration files. Since the locale database can only indicate one code set while the ORB needs to know two code sets, one for **char** data and one for **wchar** data, an implementation can use environment variables or configuration files to contain this information on native code sets.
- Converter database. This database defines, for each code set, the code sets to which it can be converted. From this database, a set of "conversion code sets" (CCS) can be determined for a client and server. For example, if a server's native code set is eucJP, and if the server-side ORB has eucJP-to-JIS and eucJP-to-SJIS bilateral converters, then the server's conversion code sets are JIS and SJIS.
- Code set converters. The ORB has converters which are registered in the converter database.

7.10.2.4 CodeSet Component of IOR Multi-Component Profile

The code set component of the IOR multi-component profile structure contains:

- server's native **char** code set and conversion code sets, and
- server's native **wchar** code set and conversion code sets.

Both **char** and **wchar** conversion code sets are listed in order of preference. The code set component is identified by the following tag:

```
const IOP::ComponentID TAG_CODE_SETS = 1;
```

This tag has been assigned by OMG (See Standard IOR Components on page 29). The following IDL structure defines the representation of code set information within the component:

```
module CONV_FRAME { // IDL
    typedef unsigned long CodeSetId;
    typedef sequence<CodeSetId> CodeSetIdSeq;
    struct CodeSetComponent {
        CodeSetId      native_code_set;
        CodeSetIdSeq   conversion_code_sets;
    };
    struct CodeSetComponentInfo {
        CodeSetComponent    ForCharData;
        CodeSetComponent    ForWcharData;
    };
};
```

Code sets are identified by a 32-bit integer id from the OSF Character and Code Set Registry (See Character and Code Set Registry on page 58 for further information). Data within the code set component is represented as a structure of type **CodeSetComponentInfo**, and is encoded as a CDR encapsulation. In other words, the **char** code set information comes first, then the **wchar** information, represented as structures of type **CodeSetComponent**.

A null value should be used in the **native_code_set** field if the server desires to indicate no native code set (possibly with the identification of suitable conversion code sets).

If the code set component is not present in a multi-component profile structure, then the default **char** code set is ISO 8859-1 for backward compatibility. However, there is no default **wchar** code set. If a server supports interfaces that use wide character data but does not specify the **wchar** code sets that it supports, client-side ORBs will raise exception **INV_OBJREF**, with standard minor code 1.

If a client application invokes an operation that results in an attempt by the client ORB to marshal **wchar** or **wstring** data for an in parameter (or to unmarshal **wchar** or **wstring** data for an in/out parameter, out parameter or the return value), and the associated Object Reference does not include a codeset component, then the client ORB shall raise the **INV_OBJREF** standard system exception with standard minor code 2 as a response to the operation invocation.

Non-presence of a codeset component in an IOR means that:

- The server and/or server-side ORB support only ISO 8859-1 for char/string, and
- the server and/or server-side ORB don't support wchar/wstring.

Thus if client tries to send **wchar** or **wstring** data on an **any** type, and there is no codeset component in target server's IOR, the client-side ORB can raise an exception **BAD_PARAM**, with standard minor code set to 42.

7.10.2.5 GIOP Code Set Service Context

The code set GIOP service context contains:

- **char** transmission code set, and
- **wchar** transmission code set

in the form of a code set service. This service is identified by:

```
const IOP::ServiceID CodeSets = 1;
```

The following IDL structure defines the representation of code set service information:

```
module CONV_FRAME {                                     // IDL
    typedef unsigned long CodeSetId;
    struct CodeSetContext {
        CodeSetId      char_data;
        CodeSetId      wchar_data;
    };
};
```

For GIOP versions 1.1, 1.2 and 1.3, Code sets are identified by a 32-bit integer id from the OSF Character and Code Set Registry (See Character and Code Set Registry on page 58 for further information).

For GIOP versions greater than 1.3, Code sets are identified by a 32 bit integer id, from either the OSF Character and Code set registry (See Character and Code Set Registry on page 58 for further information) or the IANA Character Set registry (current version at <http://www.iana.org/assignments/character-sets>).

The OSF Registry and the IANA Registry have non-overlapping ranges, so there is no need for mapping values from one codeset registry to the other.

NOTE: A server's **char** and **wchar** Code set components are usually different, but under some special circumstances they can be the same. That is, one could use the same code set for both **char** data and **wchar** data. Likewise the **CodesetIds** in the service context don't have to be different.

7.10.2.6 Code Set Negotiation

The client-side ORB determines a server's native and conversion code sets from the code set component in an IOR multi-component profile structure, and it determines a client's native and conversion code sets from the locale setting (and/or environment variables/configuration files) and the converters that are available on the client. From this information, the client-side ORB chooses **char** and **wchar** transmission code sets (TCS-C and TCS-W). For both requests and replies, the **char** TCS-C determines the encoding of **char** and **string** data, and the **wchar** TCS-W determines the encoding of **wchar** and **wstring** data.

Code set negotiation is not performed on a per-request basis, but only when a client initially connects to a server. All text data communicated on a connection are encoded as defined by the TCSs selected when the connection is established.

A codeset service context must be sent by the client (i.e., codeset negotiation must be completed) over a specific transport connection, before the client or the server may send international character values (i.e., char or string values with non Latin-1 encodings, or Wchar or Wstring values) in messages on that transport connection.

If used, the codeset service context shall be sent before, or included with, the first request message sent on that transport connection.

A request sent by the client before sending a codeset service context or not containing a service context itself, implies the client is using the default codesets on that connection (i.e., Latin-1 for string, and no ability to send Wstring on any message over that connection).

Some existing Standard Service contexts have defined their encapsulated data content including International Character information, and have also specified that the codeset used is that which is negotiated using codeset negotiation. Such service contexts may not be sent until after the Codeset Service context is sent (i.e., in the GIOP message, the codeset service context must precede any service context which depends on it being present.). Such Service Contexts that exist today are grandfathered in. Barring that exception, since all encapsulation definitions need to specify the Codeset used for their encodings, it is an error for a Service Context to depend on information that is not contained within the encapsulation to determine the codeset used within it.

Figure 7.8 illustrates there are two channels for character data flowing between the client and the server. The first, TCS-C, is used for **char** data and the second, TCS-W, is used for **wchar** data. Also note that two native code sets, one for each type of data, could be used by the client and server to talk to their respective ORBs (as noted earlier, the selection of the particular native code set used at any particular point is done via **setlocale** or some other implementation-dependent method).

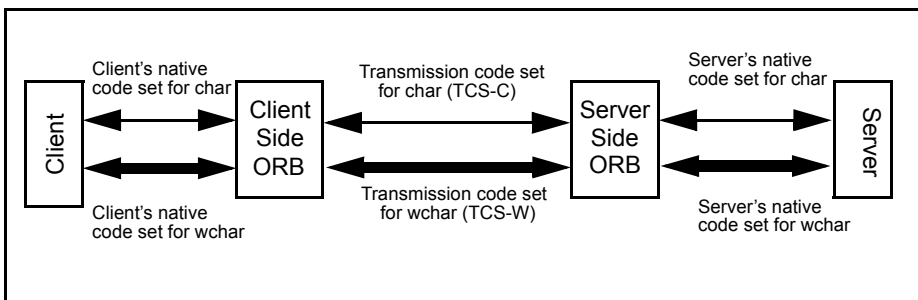

Figure 7.8 - Transmission Code Set Use

Let us look at an example. Assume that the code set information for a client and server is as shown in the table below. (Note that this example concerns only **char** code sets and is applicable only for data described as **chars** in the IDL.)

	Client	Server
Native code set:	SJIS	eucJP
Conversion code sets:	eucJP, JIS	SJIS, JIS

The client-side ORB first compares the native code sets of the client and server. If they are identical, then the transmission and native code sets are the same and no conversion is required. In this example, they are different, so code set conversion is necessary. Next, the client-side ORB checks to see if the server's native code set, eucJP, is one of the conversion code sets supported by the client. It is, so eucJP is selected as the transmission code set, with the client (i.e., its ORB) performing conversion to and from its native code set, SJIS, to eucJP. Note that the client may first have to convert all its data described as **chars** (and possibly **wchar_ts**) from process codes to SJIS first.

Now let us look at the general algorithm for determining a transmission code set and where conversions are performed. First, we introduce the following abbreviations:

- CNCS - Client Native Code Set;
- CCCS - Client Conversion Code Sets;
- SNCS - Server Native Code Set;
- SCCS - Server Conversion Code Sets; and
- TCS - Transmission Code Set.

The algorithm is as follows:

```

if (CNCS==SNCS)
    TCS = CNCS;           // no conversion required
else {
    if (elementOf(SNCS,CCCS))
        TCS = SNCS; // client converts to server's native code set
    else if (elementOf(CNCS,SCCS))
        TCS = CNCS; // server converts from client's native code set
    else if (intersection(CCCS,SCCS) != emptySet) {
        TCS = oneOf(intersection(CCCS,SCCS));
        // client chooses TCS, from intersection(CCCS,SCCS), that is
        // most preferable to server;
        // client converts from CNCS to TCS and server
        // from TCS to SNCS
    else if (compatible(CNCS,SNCS))
        TCS = fallbackCS; // fallbacks are UTF-8 (for char data) and
        // UTF-16 (for wchar data)
    else
        raise CODESET_INCOMPATIBLE exception;
}

```

The algorithm first checks to see if the client and server native code sets are the same. If they are, then the native code set is used for transmission and no conversion is required. If the native code sets are not the same, then the conversion code sets are examined to see if

1. the client can convert from its native code set to the server's native code set,
2. the server can convert from the client's native code set to its native code set, or
3. transmission through an intermediate conversion code set is possible.

If the third option is selected and there is more than one possible intermediate conversion code set (i.e., the intersection of CCCS and SCCS contains more than one code set), then the one most preferable to the server is selected.¹

If none of these conversions is possible, then the fallback code set (UTF-8 for **char** data and UTF-16 for **wchar** data—see below) is used. However, before selecting the fallback code set, a compatibility test is performed. This test looks at the character sets encoded by the client and server native code sets. If they are different (e.g., Korean and French), then meaningful communication between the client and server is not possible and a `CODESET_INCOMPATIBLE` exception with standard minor code 1 is raised. This test is similar to the DCE compatibility test and is intended to catch those cases where conversion from the client native code set to the fallback, and the fallback to the server native code set would result in massive data loss. (See clause 7.10.5, Relevant OSFM Registry Interfaces, on page 58 for the relevant OSF registry interfaces that could be used for determining compatibility.) If either the CNCS or SNCS is from the IANA Character Set registry, then the codesets are automatically assumed to be compatible and the fallback codeset is used.

A `DATA_CONVERSION` exception is raised when a client or server attempts to transmit a character that does not map into the negotiated transmission code set. For example, not all characters in Taiwan Chinese map into Unicode. When an attempt is made to transmit one of these characters via Unicode, an ORB is required to raise a `DATA_CONVERSION` exception, with standard minor code 1.

In summary, the fallback code set is UTF-8 for **char** data (identified in the Registry as 0x05010001, “X/Open UTF-8; UCS Transformation Format 8 (UTF-8)”), and UTF-16 for **wchar** data (identified in the Registry as 0x00010109, “ISO/IEC 10646-1:1993; UTF-16, UCS Transformation Format 16-bit form”). As mentioned above the fallback code set is meaningful only when the client and server character sets are compatible, and the fallback code set is distinguished from a default code set used for backward compatibility.

If a server's native **char** code set is not specified in the IOR multi-component profile, then it is considered to be ISO 8859-1 for backward compatibility. However, a server that supports interfaces that use wide character data is required to specify its native **wchar** code set; if one is not specified, then the client-side ORB raises exception `INV_OBJREF`, with standard minor code set to 1.

Similarly, if no **char** transmission code set is specified in the code set service context, then the **char** transmission code set is considered to be ISO 8859-1 for backward compatibility. If a client transmits wide character data and does not specify its **wchar** transmission code set in the service context, then the server-side ORB raises exception `BAD_PARAM`, with standard minor code set to 23.

If the client delivers a codeset via a `CodeSetContext` that the server does not support as a transmission codeset then the server returns a `CODESET_INCOMPATIBLE` exception with the standard minor code 2.

If the client (or the server if Bi-Directional GIOP is in use) sends multiple codeset service contexts on the same connection, with different parameter values, then the behavior is undefined. The receiver of a codeset service context with different values from those received on the same connection and processed previously may return a `MARSHAL` system exception with the standard minor code 9.

1. Recall that server conversion code sets are listed in order of preference.

To guarantee “out-of-the-box” interoperability, clients and servers must be able to convert between their native **char** code set and UTF-8 and their native **wchar** code set (if specified) and Unicode. Note that this does not require that all server native code sets be mappable to Unicode, but only those that are exported as native in the IOR. The server may have other native code sets that aren’t mappable to Unicode and those can be exported as SCCSs (but not SNCSSs). This is done to guarantee out-of-the-box interoperability and to reduce the number of code set converters that a CORBA-compliant ORB must provide.

ORB implementations are strongly encouraged to use widely-used code sets for each regional market. For example, in the Japanese marketplace, all ORB implementations should support Japanese EUC, JIS, and Shift JIS to be compatible with existing business practices.

7.10.3 Mapping to Generic Character Environments

Certain language environments do not distinguish between byte-oriented and wide characters. In such environments both **char** and **wchar** are mapped to the same “generic” character representation of the language. **String** and **wstring** are likewise mapped to generic strings in such environments. Examples of language environments that provide generic character support are Smalltalk and Ada.

Even while using languages that do distinguish between wide and byte-oriented characters (e.g., C and C++), it is possible to mimic some generic behavior by the use of suitable macros and support libraries. For example, developers of Windows NT and Windows 95 applications can write portable code between NT (which uses Unicode strings) and Windows 95 (which uses byte-oriented character strings) by using a set of macros for declaring and manipulating characters and character strings.

Another way to achieve generic manipulation of characters and strings is by treating them as abstract data types (ADTs). For example, if strings were treated as abstract data types and the programmers are required to create, destroy, and manipulate strings only through the operations in the ADT interface, then it becomes possible to write code that is representation-independent. This approach has an advantage over the macro-based approach in that it provides portability between byte-oriented and wide character environments even without recompilation (at runtime the string function calls are bound to the appropriate byte-oriented/wide library). Another way of looking at it is that the macro-based genericity gives compile-time flexibility, while ADT-based genericity gives runtime flexibility.

Yet another way to achieve generic manipulation of character data is through the ANSI C++ Strings library defined as a template that can be parameterized by **char**, **wchar_t**, or other integer types.

Given that there can be several ways of treating characters and character strings in a generic way, this standard cannot, and therefore does not, specify the mapping of **char**, **wchar**, **string**, and **wstring** to all of them. It only specifies the following normative requirements that are applicable to generic character environments:

- **wchar** must be mapped to the generic character type in a generic character environment.
- **wstring** must be mapped to a string of such generic characters in a generic character environment.
- The language binding files (i.e., stubs) generated for these generic environments must ensure that the generic type representation is converted to the appropriate code sets (i.e., CNCS on the client side and SNCSS on the server side) before character data is given to the ORB runtime for transmission.

7.10.3.1 Describing Generic Interfaces

To describe generic interfaces in IDL we recommend using **wchar** and **wstring**. These can be mapped to generic character types in environments where they do exist and to wide characters where they do not. Either way interoperation between generic and non-generic character type environments is achieved because of the code set conversion framework.

7.10.3.2 Interoperation

Let us consider an example to see how a generic environment can interoperate with a non-generic environment. Let us say there is an IDL interface with both **char** and **wchar** parameters on the operations, and let us say the client of the interface is in a generic environment while the server is in a non-generic environment (for example the client is written in Smalltalk and the server is written in C++).

Assume that the server's (byte-oriented) native **char** code set (SNCS) is eucJP and the client's native **char** code set (CNCS) is SJIS. Further assume that the code set negotiation led to the decision to use eucJP as the **char** TCS-C and Unicode as the **wchar** TCS-W.

As per the above normative requirements for mapping to a generic environment, the client's Smalltalk stubs are responsible for converting all **char** data (however they are represented inside Smalltalk) to SJIS and all **wchar** data to the client's **wchar** code set before passing the data to the client-side ORB. Note that this conversion could be an identity mapping if the internal representation of narrow and wide characters is the same as that of the native code set(s). The client-side ORB now converts all **char** data from SJIS to eucJP and all **wchar** data from the client's **wchar** code set to Unicode, and then transmits to the server side.

The server side ORB and stubs convert the eucJP data and Unicode data into C++'s internal representation for **chars** and **wchars** as dictated by the IDL operation signatures. Notice that when the data arrives at the server side it does not look any different from data arriving from a non-generic environment (e.g., that is just like the server itself). In other words, the mappings to generic character environments do not affect the code set conversion framework.

7.10.4 Example of Generic Environment Mapping

This sub clause shows how **char**, **wchar**, **string**, and **wstring** can be mapped to the generic C/C++ macros of the Windows environment. This is merely to illustrate one possibility. This sub clause is not normative and is applicable only in generic environments. See Mapping to Generic Character Environments on page 56.

7.10.4.1 Generic Mappings

Char and **string** are mapped to C/C++ **char** and **char*** as per the standard C/C++ mappings. **wchar** is mapped to the **TCHAR** macro which expands to either **char** or **wchar_t** depending on whether **_UNICODE** is defined. **wstring** is mapped to pointers to **TCHAR** as well as to the string class **CORBA::Wstring_var**. Literal strings in IDL are mapped to the **_TEXT** macro as in **_TEXT(<literal>)**.

7.10.4.2 Interoperation and Generic Mappings

We now illustrate how the interoperation works with the above generic mapping. Consider an IDL interface operation with a **wstring** parameter, a client for the operation which is compiled and run on a Windows 95 machine, and a server for the operation which is compiled and run on a Windows NT machine. Assume that the locale (and/or the environment variables for CNCS for **wchar** representation) on the Windows 95 client indicates the client's native code set to be SJIS, and that the corresponding server's native code set is Unicode. The code set negotiation in this case will probably choose Unicode as the TCS-W.

Both the client and server sides will be compiled with **_UNICODE** defined. The IDL type **wstring** will be represented as a string of **wchar_t** on the client. However, since the client's locale or environment indicates that the CNCS for wide characters is SJIS, the client side ORB will get the **wstring** parameter encoded as a SJIS multi-byte string (since that is the client's native code set), which it will then convert to Unicode before transmitting to the server. On the server side the ORB has no conversions to do since the TCS-W matches the server's native code set for wide characters.

We therefore notice that the code set conversion framework handles the necessary translations between byte-oriented and wide forms.

7.10.5 Relevant OSFM Registry Interfaces

7.10.5.1 Character and Code Set Registry

The OSF character and code set registry is defined in *OSF Character and Code Set Registry* (see References in the Preface) and current registry contents may be obtained directly from the Open Software Foundation (obtain via anonymous ftp to [ftp.opengroup.org/pub/code_set_registry](ftp://ftp.opengroup.org/pub/code_set_registry)). This registry contains two parts: character sets and code sets. For each listed code set, the set of character sets encoded by this code set is shown.

Each 32-bit code set value consists of a high-order 16-bit organization number and a 16-bit identification of the code set within that organization. As the numbering of organizations starts with 0x0001, a code set null value (0x00000000) may be used to indicate an unknown code set.

When associating character sets and code sets, OSF uses the concept of “fuzzy equality,” meaning that a code set is shown as encoding a particular character set if the code set can encode “most” of the characters.

“Compatibility” is determined with respect to two code sets by examining their entries in the registry, paying special attention to the character sets encoded by each code set. For each of the two code sets, an attempt is made to see if there is at least one (fuzzy-defined) character set in common, and if such a character set is found, then the assumption is made that these code sets are “compatible.” Obviously, applications that exploit parts of a character set not properly encoded in this scheme will suffer information loss when communicating with another application in this “fuzzy” scheme.

The ORB is responsible for accessing the OSF registry and determining “compatibility” based on the information returned.

OSF members and other organizations can request additions to both the character set and code set registries by email to cs-registry@opengroup.org; in particular, one range of the code set registry (0xf5000000 through 0xffffffff) is reserved for organizations to use in identifying sets that are not registered with the OSF (although such use would not facilitate interoperability without registration).

7.10.5.2 Access Routines

The following routines are for accessing the OSF character and code set registry. These routines map a code set string name to code set id and vice versa. They also help in determining character set compatibility. These routine interfaces, their semantics and their actual implementation are not normative (i.e., ORB vendors do not have to bundle the OSF registry implementation with their products for compliance).

The following routines are adopted from *RPC Runtime Support For I18N Characters - Functional Specification* (see References in the Preface).

7.10.5.2.1 dce_cs_loc_to_rgy

Maps a local system-specific string name for a code set to a numeric code set value specified in the code set registry.

Synopsis

```
void dce_cs_loc_to_rgy(  
idl_char *local_code_set_name,  
unsigned32 *rgy_code_set_value,  
unsigned16 *rgy_char_sets_number,  
unsigned16 **rgy_char_sets_value,  
error_status_t *status);
```

<i>Parameters - Input</i>	
local_code_set_name	A string that specifies the name that the local host's locale environment uses to refer to the code set. The string is a maximum of 32 bytes: 31 data bytes plus a terminating NULL character.
<i>Parameters - Output</i>	
rgy_code_set_value 0	The registered integer value that uniquely identifies the code set specified by local_code_set_name.
rgy_char_sets_number	The number of character sets that the specified code set encodes. Specifying NULL prevents this routine from returning this parameter.
rgy_char_sets_value	A pointer to an array of registered integer values that uniquely identify the character set(s) that the specified code set encodes. Specifying NULL prevents this routine from returning this parameter. The routine dynamically allocates this value.
status	Returns the status code from this routine. This status code indicates whether the routine completed successfully or, if not, why not. The possible status codes and their meanings are as follows: <ul style="list-style-type: none">• dce_cs_c_ok – Code set registry access operation succeeded.• dce_cs_c_cannot_allocate_memory – Cannot allocate memory for code set info.• dce_cs_c_unknown – No code set value was not found in the registry which corresponds to the code set name specified.• dce_cs_c_notfound – No local code set name was found in the registry which corresponds to the name specified.

Description

The dce_cs_loc_to_rgy() routine maps operating system-specific names for character/code set encodings to their unique identifiers in the code set registry.

The dce_cs_loc_to_rgy() routine takes as input a string that holds the host-specific "local name" of a code set and returns the corresponding integer value that uniquely identifies that code set, as registered in the host's code set registry. If the integer value does not exist in the registry, the routine returns the status dce_cs_c_unknown.

The routine also returns the number of character sets that the code set encodes and the registered integer values that uniquely identify those character sets. Specifying NULL in the rgy_char_sets_number and rgy_char_sets_value[] parameters prevents the routine from performing the additional search for these values. Applications that want only to

obtain a code set value from the code set registry can specify NULL for these parameters in order to improve the routine's performance. If the value is returned from the routine, application developers should free the array after it is used, since the array is dynamically allocated.

7.10.5.2.2 dce_cs_rgy_to_loc

Maps a numeric code set value contained in the code set registry to the local system-specific name for a code set.

Synopsis

```
void dce_cs_rgy_to_loc(
    unsigned32 *rgy_code_set_value,
    idl_char **local_code_set_name,
    unsigned16 *rgy_char_sets_number,
    unsigned16 **rgy_char_sets_value,
    error_status_t *status);
```

<i>Parameters - Input</i>	
rgy_code_set_value	The registered hexadecimal value that uniquely identifies the code set.
<i>Parameters - Output</i>	
local_code_set_name	A string that specifies the name that the local host's locale environment uses to refer to the code set. The string is a maximum of 32 bytes: 31 data bytes and a terminating NULL character.
rgy_char_sets_number	The number of character sets that the specified code set encodes. Specifying NULL in this parameter prevents the routine from returning this value.
rgy_char_sets_value	A pointer to an array of registered integer values that uniquely identify the character set(s) that the specified code set encodes. Specifying NULL in this parameter prevents the routine from returning this value. The routine dynamically allocates this value.
status	Returns the status code from this routine. This status code indicates whether the routine completed successfully or, if not, why not. The possible status codes and their meanings are as follows: <ul style="list-style-type: none"> • dce_cs_c_ok – Code set registry access operation succeeded. • dce_cs_c_cannot_allocate_memory – Cannot allocate memory for code set info. • dce_cs_c_unknown – The requested code set value was not found in the code set registry. • dce_cs_c_notfound – No local code set name was found in the registry that corresponds to the specific code set registry ID value. This implies that the code set is not supported in the local system environment.

Description

The `dce_cs_rgy_to_loc()` routine maps a unique identifier for a code set in the code set registry to the operating system-specific string name for the code set, if it exists in the code set registry.

The `dce_cs_rgy_to_loc()` routine takes as input a registered integer value of a code set and returns a string that holds the operating system-specific, or local name, of the code set.

If the code set identifier does not exist in the registry, the routine returns the status `dce_cs_c_unknown` and returns an undefined string.

The routine also returns the number of character sets that the code set encodes and the registered integer values that uniquely identify those character sets. Specifying `NULL` in the `rgy_char_sets_number` and `rgy_char_sets_value[]` parameters prevents the routine from performing the additional search for these values. Applications that want only to obtain a local code set name from the code set registry can specify `NULL` for these parameters in order to improve the routine's performance. If the value is returned from the routine, application developers should free the `rgy_char_sets_value` array after it is used.

7.10.5.2.3 `rpc_cs_char_set_compat_check`

Evaluates character set compatibility between a client and a server.

Synopsis

```
void rpc_cs_char_set_compat_check(  
    unsigned32 client_rgy_code_set_value,  
    unsigned32 server_rgy_code_set_value,  
    error_status_t *status);
```

<i>Parameters - Input</i>	
client_rgy_code_set_value	The registered hexadecimal value that uniquely identifies the code set that the client is using as its local code set.
server_rgy_code_set_value	The registered hexadecimal value that uniquely identifies the code set that the server is using as its local code set.
<i>Parameters - Output</i>	
status	Returns the status code from this routine. This status code indicates whether the routine completed successfully or, if not, why not. The possible status codes and their meanings are as follows: <ul style="list-style-type: none">• <code>rpc_s_ok</code> – Successful status.• <code>rpc_s_ss_no_compat_charsets</code> – No compatible code set found. The client and server do not have a common encoding that both could recognize and convert.• The routine can also return status codes from the <code>dce_cs_rgy_to_loc()</code> routine.

Description

The `rpc_cs_char_set_compat_check()` routine provides a method for determining character set compatibility between a client and a server; if the server's character set is incompatible with that of the client, then connecting to that server is most likely not acceptable, since massive data loss would result from such a connection.

The routine takes the registered integer values that represent the code sets that the client and server are currently using and calls the code set registry to obtain the registered values that represent the character set(s) that the specified code sets support. If both client and server support just one character set, the routine compares client and server registered character set values to determine whether or not the sets are compatible. If they are not, the routine returns the status message `rpc_s_ss_no_compat_charsets`.

If the client and server support multiple character sets, the routine determines whether at least two of the sets are compatible. If two or more sets match, the routine considers the character sets compatible, and returns a success status code to the caller.

7.10.5.2.4 `rpc_rgy_get_max_bytes`

Gets the maximum number of bytes that a code set uses to encode one character from the code set registry on a host.

Synopsis

```
void rpc_rgy_get_max_bytes(  
    unsigned32 rgy_code_set_value,  
    unsigned16 *rgy_max_bytes,  
    error_status_t *status);
```

<i>Parameters - Input</i>	
rgy_code_set_value	The registered hexadecimal value that uniquely identifies the code set.
<i>Parameters - Output</i>	
rgy_max_bytes	The registered decimal value that indicates the number of bytes this code set uses to encode one character.
status	Returns the status code from this routine. This status code indicates whether the routine completed successfully or, if not, why not. The possible status codes and their meanings are as follows: <ul style="list-style-type: none">• <code>rpc_s_ok</code> – Operation succeeded.• <code>dce_cs_c_cannot_allocate_memory</code> – Cannot allocate memory for code set info.• <code>dce_cs_c_unknown</code> – No code set value was not found in the registry that corresponds to the code set value specified.• <code>dce_cs_c_notfound</code> – No local code set name was found in the registry that corresponds to the value specified.

Description

The `rpc_rgy_get_max_bytes()` routine reads the code set registry on the local host. It takes the specified registered code set value, uses it as an index into the registry, and returns the decimal value that indicates the number of bytes that the code set uses to encode one character.

This information can be used for buffer sizing as part of the procedure to determine whether additional storage needs to be allocated for conversion between local and network code sets.

8 Building Inter-ORB Bridges

8.1 Introduction

This clause provides an implementation-oriented conceptual framework for the construction of bridges to provide interoperability between ORBs. It focuses on the layered *request level bridges* that the CORBA Core specifications facilitate, although ORBs may always be internally modified to support bridges.

Key features of the specifications for inter-ORB bridges are as follows:

- Enables requests from one ORB to be translated to requests on another.
- Provides support for managing tables keyed by object references.

The OMG IDL specification for interoperable object references, which are important to inter-ORB bridging, is shown in Interoperable Object References: IORs on page 25.

8.2 In-Line and Request-Level Bridging

Bridging of an invocation between a client in one domain and a server object in another domain can be mediated through a standardized mechanism, or done immediately using non-standard ones.

The question of how this bridging is constructed is broadly independent of whether the bridging uses a standardized mechanism. There are two possible options for where the bridge components are located:

1. Code inside the ORB may perform the necessary translation or mappings; this is termed *in-line bridging*.
2. Application style code outside the ORB can perform the translation or mappings; this is termed *request-level bridging*.

Request-level bridges that mediate through a common protocol (using networking, shared memory, or some other IPC provided by the host operating system) between distinct execution environments will involve components, one in each ORB, known as “half bridges.”

When that mediation is purely internal to one execution environment, using a shared programming environment’s binary interfaces to CORBA- and OMG-IDL-defined data types, this is known as a “full bridge.”¹ From outside the execution environment this will appear identical to some kinds of in-line bridging, since only that environment knows the construction techniques used. However, full bridges more easily support portable policy mediation components, because of their use of only standard CORBA programming interfaces.

Network protocols may be used immediately “in-line,” or to mediate between request-level half bridges. The General Inter-ORB Protocol can be used in either manner. In addition, this specification provides for Environment Specific Inter-ORB Protocols (ESIOP), allowing for alternative mediation mechanisms.

1. Special initialization supporting object referencing domains (e.g., two protocols) to be exposed to application programmers to support construction of this style bridge.

Note that mediated, request-level half-bridges can be built by anyone who has access to an ORB, without needing information about the internal construction of that ORB. Immediate-mode request-level half-bridges (i.e., ones using non-standard mediation mechanisms) can be built similarly without needing information about ORB internals. Only in-line bridges (using either standard or non-standard mediation mechanisms) need potentially proprietary information about ORB internals.

8.2.1 In-line Bridging

In-line bridging is in general the most direct method of bridging between ORBs. It is structurally similar to the engineering commonly used to bridge between systems within a single ORB (e.g., mediating using some common inter-process communications scheme, such as a network protocol). This means that implementing in-line bridges involves as fundamental a set of changes to an ORB as adding a new inter-process communications scheme. (Some ORBs may be designed to facilitate such modifications, though.)

In this approach, the required bridging functionality can be provided by a combination of software components at various levels:

- As additional or alternative services provided by the underlying ORBs
- As additional or alternative stub and skeleton code.

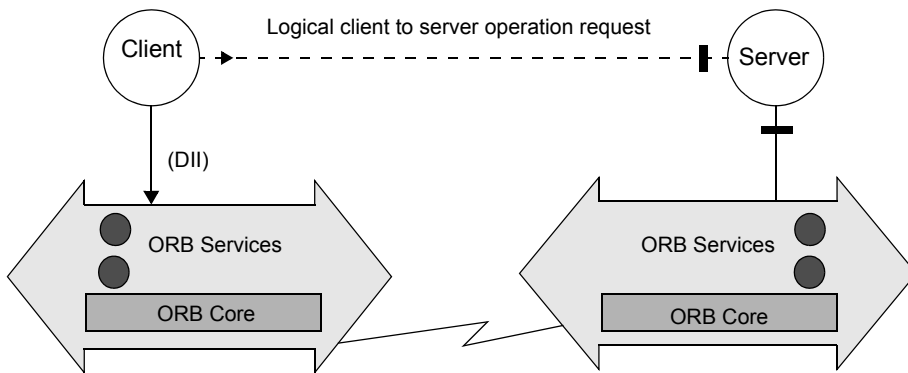

Figure 8.1 - In-Line bridges are built using *ORB internal APIs*

8.2.2 Request-level Bridging

The general principle of request-level bridging is as follows:

1. The original request is passed to a proxy object in the client ORB.
2. The proxy object translates the request contents (including the target object reference) to a form that will be understood by the server ORB.
3. The proxy invokes the required operation on the apparent server object.
4. Any operation result is passed back to the client via a complementary route.

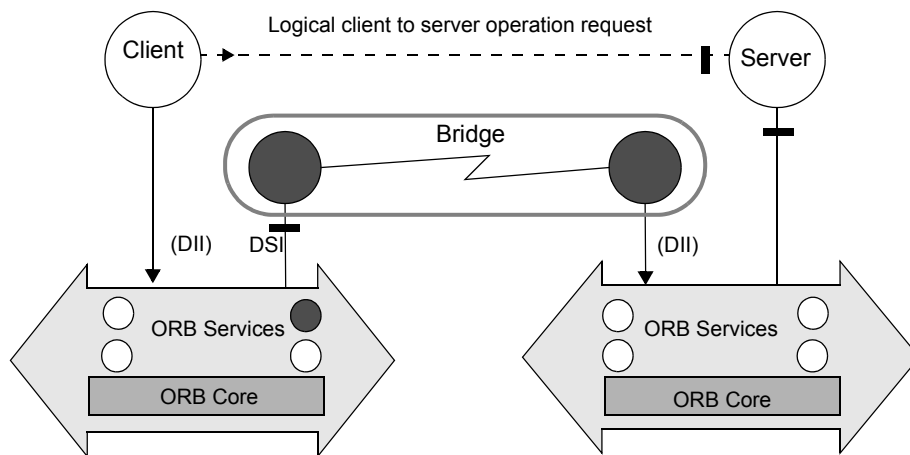

Figure 8.2 - Request-Level bridges are built using *public ORB APIs*

The request translation involves performing object reference mapping for all object references involved in the request (the target, explicit parameters, and perhaps implicit ones such as transaction context). As elaborated later, this translation may also involve mappings for other domains: the security domain of **CORBA::Principal** parameters, type identifiers, and so on.

It is a language mapping requirement of the CORBA Core specification that all dynamic typing APIs (e.g., **Any**, **NamedValue**) support such manipulation of parameters even when the bridge was not created with compile-time knowledge of the data types involved.

8.2.3 Collocated ORBs

In the case of immediate bridging (i.e., not via a standardized, external protocol) the means of communication between the client-side bridge component and that on the server-side is an entirely private matter. One possible engineering technique optimizes this communication by coalescing the two components into the same system or even the same address space. In the latter case, accommodations must be made by both ORBs to allow them to share the same execution environment.

Similar observations apply to request-level bridges, which in the case of collocated ORBs use a common binary interface to all OMG IDL-defined data as their mediating data format.

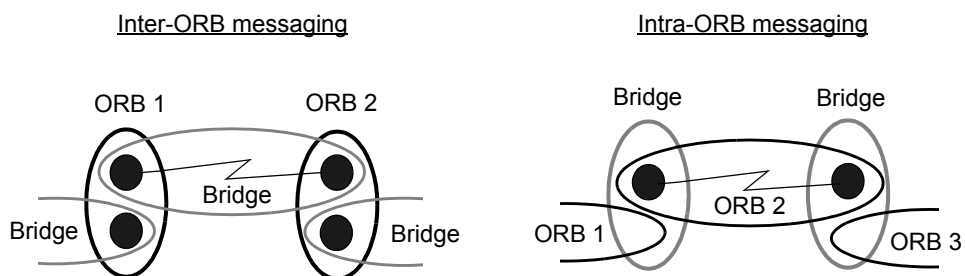

Figure 8.3 - When the two ORBs are collocated in a bridge execution environment, network communications will be purely intra-ORB. If the ORBs are not collocated, such communications must go between ORBs.

An advantage of using bridges spanning collocated ORBs is that all external messaging can be arranged to be intra-ORB, using whatever message-passing mechanisms each ORB uses to achieve distribution within a single ORB, multiple machine system. That is, for bridges between networked ORBs such a bridge would add only a single “hop,” a cost analogous to normal routing.

8.3 Proxy Creation and Management

Bridges need to support arbitrary numbers of proxy objects, because of the (bidirectional) object reference mappings required. The key schemes for creating and managing proxies are *reference translation* and *reference encapsulation*, as discussed in Handling of Referencing Between Domains on page 24.

- Reference translation approaches are possible with CORBA V2.0 Core APIs. Proxies themselves can be created as normal objects using the Basic Object Adapter (BOA) and the Dynamic Skeleton Interface (DSI).
- Reference Encapsulation is not supported by the BOA, since it would call for knowledge of more than one ORB. Some ORBs could provide other object adapters that support such encapsulation.

Note that from the perspective of clients, they only deal with local objects; clients do not need to distinguish between proxies and other objects. Accordingly, all CORBA operations supported by the local ORB are also supported through a bridge. The ORB used by the client might, however, be able to recognize that encapsulation is in use, depending on how the ORB is implemented.

Also, note that the **CORBA::InterfaceDef** used when creating proxies (e.g., the one passed to **CORBA::BOA::create**) could be either a proxy to one in the target ORB, or could be an equivalent local one. When the domains being bridged include a type domain, then the **InterfaceDef** objects cannot be proxies since type descriptions will not have the same information. When bridging CORBA-compliant ORBs, type domains by definition do not need to be bridged.

8.4 Interface-specific Bridges and Generic Bridges

Request-level bridges may be:

- *Interface-specific*: they support predetermined IDL interfaces only, and are built using IDL-compiler generated stub and skeleton interfaces.
- *Generic*: capable of bridging requests to server objects of arbitrary IDL interfaces, using the interface repository and other dynamic invocation support (DII and DSI).

Interface-specific bridges may be more efficient in some cases (a generic bridge could conceivably create the same stubs and skeletons using the interface repository), but the requirement for prior compilation means that this approach offers less flexibility than using generic bridges.

8.5 Building Generic Request-Level Bridges

The CORBA Core specifications define the following interfaces. These interfaces are of particular significance when building a generic request-level bridge:

- **Dynamic Invocation Interface (DII)** lets the bridge make arbitrary invocations on object references whose types may not have been known when the bridge was developed or deployed.
- **Dynamic Skeleton Interface (DSI)** lets the bridge handle invocations on proxy object references that it implements, even when their types may not have been known when the bridge was developed or deployed.
- **Interface Repositories** are consulted by the bridge to acquire the information used to drive DII and DSI, such as the type codes for operation parameters, return values, and exceptions.

- **Object Adapters** (such as the Basic Object Adapter) are used to create proxy object references both when bootstrapping the bridge and when mapping object references, which are dynamically passed from one ORB to the other.
- **CORBA Object References** support operations to fully describe their interfaces and to create tables mapping object references to their proxies (and vice versa).

Interface repositories accessed on either side of a half bridge need not have the same information, though of course the information associated with any given repository ID (e.g., an interface type ID, exception ID) or operation ID must be the same.

Using these interfaces and an interface to some common transport mechanism such as TCP, portable request-level half bridges connected to an ORB can:

- Use DSI to translate all CORBA invocations on proxy objects to the form used by some mediating protocol such as IIOP (see the *General Inter-ORB Protocol* clause in this standard).
- Translate requests made using such a mediating protocol into DII requests on objects in the ORB.

As noted in In-Line and Request-Level Bridging on page 63, translating requests and responses (including exceptional responses) involves mapping object references (and other explicit and implicit parameter data) from the form used by the ORB to the form used by the mediating protocol, and vice versa. Explicit parameters, which are defined by an operation's OMG-IDL definition, are presented through DII or DSI and are listed in the Interface Repository entry for any particular operation.

Operations on object references such as **hash()** and **is_equivalent()** may be used to maintain tables that support such mappings. When such a mapping does not exist, an object adapter is used to create ORB-specific proxy object references, and bridge-internal interfaces are used to create the analogous data structure for the mediating protocol.

8.6 Bridging Non-Referencing Domains

In the simplest form of request-level bridging, the bridge operates only on IDL-defined data, and bridges only object reference domains. In this case, a proxy object in the client ORB acts as a representative of the target object and is, in almost any practical sense, indistinguishable from the target server object - indeed, even the client ORB will not be aware of the distinction.

However, as alluded to above, there may be multiple domains that need simultaneous bridging. The transformation and encapsulation schemes described above may not apply in the same way to Principal or type identifiers. Request-level bridges may need to translate such identifiers, in addition to object references, as they are passed as explicit operation parameters.

Moreover, there is an emerging class of "implicit context" information that ORBs may need to convey with any particular request, such as transaction and security context information. Such parameters are not defined as part of an operation's OMG-IDL signature, hence are "implicit" in the invocation context. Bridging the domains of such implicit parameters could involve additional kinds of work, needing to mediate more policies than bridging the object reference, Principal, and type domains directly addressed by CORBA.

CORBA does not yet have a generic way (including support for both static and dynamic invocations) to expose such implicit context information.

8.7 Bootstrapping Bridges

A particularly useful policy for setting up bridges is to create a pair of proxies for two Naming Service naming contexts (one in each ORB) and then install those proxies as naming contexts in the other ORB's naming service. (The Naming Service is described in the Naming Service specification.) This will allow clients in either ORB to transparently perform naming context lookup operations on the other ORB, retrieving (proxy) object references for other objects in that ORB. In this way, users can access facilities that have been selectively exported from another ORB, through a naming context, with no administrative action beyond exporting those initial contexts. (See the *ORB Interface* clause in CORBA, Part 1 for additional information.)

This same approach may be taken with other discovery services, such as a trading service or any kind of object that could provide object references as operation results (and in "out" parameters). While bridges can be established that only pass a predefined set of object references, this kind of minimal connectivity policy is not always desirable.

9 General Inter-ORB Protocol

This clause specifies a General Inter-ORB Protocol (GIOP) for ORB interoperability, which can be mapped onto any connection-oriented transport protocol that meets a minimal set of assumptions. This clause also defines a specific mapping of the GIOP, which runs directly over TCP/IP connections, called the Internet Inter-ORB Protocol (IIOP). The IIOP must be supported by conforming networked ORB products regardless of other aspects of their implementation. Such support does not require using it internally; conforming ORBs may also provide bridges to this protocol.

9.1 Goals of the General Inter-ORB Protocol

The GIOP and IIOP support protocol-level ORB interoperability in a general, low-cost manner. The following objectives were pursued vigorously in the GIOP design:

- **Widest possible availability** - The GIOP and IIOP are based on the most widely-used and flexible communications transport mechanism available (TCP/IP), and defines the minimum additional protocol layers necessary to transfer CORBA requests between ORBs.
- **Simplicity** - The GIOP is intended to be as simple as possible, while meeting other design goals. Simplicity is deemed the best approach to ensure a variety of independent, compatible implementations.
- **Scalability** - The GIOP/IIOP protocol should support ORBs, and networks of bridged ORBs, to the size of today's Internet, and beyond.
- **Low cost** - Adding support for GIOP/IIOP to an existing or new ORB design should require small engineering investment. Moreover, the run-time costs required to support IIOP in deployed ORBs should be minimal.
- **Generality** - While the IIOP is initially defined for TCP/IP, GIOP message formats are designed to be used with any transport layer that meets a minimal set of assumptions; specifically, the GIOP is designed to be implemented on other connection-oriented transport protocols.
- **Architectural neutrality** - The GIOP specification makes minimal assumptions about the architecture of agents that will support it. The GIOP specification treats ORBs as opaque entities with unknown architectures.

The approach a particular ORB takes to providing support for the GIOP/IIOP is undefined. For example, an ORB could choose to use the IIOP as its internal protocol, it could choose to externalize IIOP as much as possible by implementing it in a half-bridge, or it could choose a strategy between these two extremes. All that is required of a conforming ORB is that some entity or entities in, or associated with, the ORB be able to send and receive IIOP messages.

9.2 GIOP Overview

The GIOP specification consists of the following elements:

- *The Common Data Representation (CDR) definition.* CDR is a transfer syntax mapping OMG IDL data types into a bicanonical low-level representation for “on-the-wire” transfer between ORBs and Inter-ORB bridges (agents).
- *GIOP Message Formats.* GIOP messages are exchanged between agents to facilitate object requests, locate object implementations, and manage communication channels.

- *GIOP Transport Assumptions.* The GIOP specification describes general assumptions made concerning any network transport layer that may be used to transfer GIOP messages. The specification also describes how connections may be managed, and constraints on GIOP message ordering.

The IOP specification adds the following element to the GIOP specification:

- *Internet IOP Message Transport.* The IOP specification describes how agents open TCP/IP connections and use them to transfer GIOP messages.

The IOP is not a separate specification; it is a specialization, or mapping, of the GIOP to a specific transport (TCP/IP). The GIOP specification (without the transport-specific IOP element) may be considered as a separate conformance point for future mappings to other transport layers.

The complete OMG IDL specifications for the GIOP and IOP are shown in OMG IDL on page 119. Fragments of the specification are used throughout this document as necessary.

9.2.1 Common Data Representation (CDR)

CDR is a transfer syntax, mapping from data types defined in OMG IDL to a bicononical, low-level representation for transfer between agents. CDR has the following features:

- *Variable byte ordering* - Machines with a common byte order may exchange messages without byte swapping. When communicating machines have different byte order, the message originator determines the message byte order, and the receiver is responsible for swapping bytes to match its native ordering. Each GIOP message (and CDR encapsulation) contains a flag that indicates the appropriate byte order.
- *Aligned primitive types* - Primitive OMG IDL data types are aligned on their natural boundaries within GIOP messages, permitting data to be handled efficiently by architectures that enforce data alignment in memory.
- *Complete OMG IDL Mapping* - CDR describes representations for all OMG IDL data types, including transferable pseudo-objects such as TypeCodes. Where necessary, CDR defines representations for data types whose representations are undefined or implementation-dependent in the CORBA Core specifications.

9.2.2 GIOP Message Overview

The GIOP specifies formats for messages that are exchanged between inter-operating ORBs. GIOP message formats have the following features:

- *Few, simple messages* - With only seven message formats, the GIOP supports full CORBA functionality between ORBs, with extended capabilities supporting object location services, dynamic migration, and efficient management of communication resources. GIOP semantics require no format or binding negotiations. In most cases, clients can send requests to objects immediately upon opening a connection.
- *Dynamic object location* - Many ORBs' architectures allow an object implementation to be activated at different locations during its lifetime, and may allow objects to migrate dynamically. GIOP messages provide support for object location and migration, without requiring ORBs to implement such mechanisms when unnecessary or inappropriate to an ORB's architecture.
- *Full CORBA support* - GIOP messages directly support all functions and behaviors required by CORBA, including exception reporting, passing operation context, and remote object reference operations (such as **CORBA::Object::get_interface**).

GIOP also supports passing service-specific context, such as the transaction context defined by the Transaction Service (the Transaction Service is described in *CORBA services: Common Object Service Specifications*). This mechanism is designed to support any service that requires service related context to be implicitly passed with requests.

9.2.3 GIOP Message Transfer

The GIOP specification is designed to operate over any connection-oriented transport protocol that meets a minimal set of assumptions (described in GIOP Message Transport on page 107). GIOP uses underlying transport connections in the following ways:

- **Asymmetrical connection usage** - The GIOP defines two distinct roles with respect to connections, client, and server. The client side of a connection originates the connection, and sends object requests over the connection. In GIOP versions 1.0 and 1.1, the server side receives requests and sends replies. The server side of a connection may not send object requests. This restriction, which was included to make GIOP 1.0 and 1.1 much simpler and avoid certain race conditions, has been relaxed for GIOP version 1.2 and later, as specified in the BiDirectional GIOP specification, see Bi-Directional GIOP on page 115.
- **Request multiplexing** - If desirable, multiple clients within an ORB may share a connection to send requests to a particular ORB or server. Each request uniquely identifies its target object. Multiple independent requests for different objects, or a single object, may be sent on the same connection.
- **Overlapping requests** - In general, GIOP message ordering constraints are minimal. GIOP is designed to allow overlapping asynchronous requests; it does not dictate the relative ordering of requests or replies. Unique request/reply identifiers provide proper correlation of related messages. Implementations are free to impose any internal message ordering constraints required by their ORB architectures.
- **Connection management** - GIOP defines messages for request cancellation and orderly connection shutdown. These features allow ORBs to reclaim and reuse idle connection resources.
- **GIOP versions for requests and replies** - The GIOP version of the message carrying a response to a request shall be the same as the GIOP version of the message carrying the request. This rule does not apply when the server is responding with a MessageError because it does not support the GIOP minor version in the request.

9.3 CDR Transfer Syntax

The Common Data Representation (CDR) transfer syntax is the format in which the GIOP represents OMG IDL data types in an octet stream.

An octet stream is an abstract notion that typically corresponds to a memory buffer that is to be sent to another process or machine over some IPC mechanism or network transport. For the purposes of this discussion, an octet stream is an arbitrarily long (but finite) sequence of eight-bit values (octets) with a well-defined beginning. The octets in the stream are numbered from 0 to $n-1$, where n is the size of the stream. The numeric position of an octet in the stream is called its *index*. Octet indices are used to calculate alignment boundaries, as described in Alignment on page 72.

GIOP defines two distinct kinds of octet streams:

- **Message** - an octet stream constituting the basic unit of information exchange in GIOP, described in detail in GIOP Message Formats on page 93.
- **Encapsulation** - an octet stream into which OMG IDL data structures may be marshaled independently, apart from any particular message context, described in detail in Encapsulation on page 79.

9.3.1 Primitive Types

Primitive data types are specified for both big-endian and little-endian orderings. The message formats (see GIOP Message Formats on page 93) include tags in message headers that indicate the byte ordering in the message. Encapsulations include an initial flag that indicates the byte ordering within the encapsulation, described in Encapsulation on page 79. The byte ordering of any encapsulation may be different from the message or encapsulation within which it is nested. It is the responsibility of the message recipient to translate byte ordering if necessary. Primitive data types are encoded in multiples of octets. An **octet** is an 8-bit value.

9.3.1.1 Alignment

In order to allow primitive data to be moved into and out of octet streams with instructions specifically designed for those primitive data types, in CDR all primitive data types must be aligned on their natural boundaries (i.e., the alignment boundary of a primitive datum is equal to the size of the datum in **octets**). Any primitive of size n octets must start at an octet stream index that is a multiple of n . In CDR, n is one of 1, 2, 4, or 8.

Where necessary, an alignment gap precedes the representation of a primitive datum. The value of **octets** in alignment gaps is undefined. A gap must be the minimum size necessary to align the following primitive. Table 9.1 gives alignment boundaries for CDR/OMG-IDL primitive types.

Table 9.1

TYPE	OCTET ALIGNMENT
char	1
wchar	1, 2 or 4 for GIOP 1.1 1 for GIOP 1.2 and later
octet	1
short	2
unsigned short	2
long	4
unsigned long	4
long long	8
unsigned long long	8
float	4
double	8
long double	8
boolean	1
enum	4

Alignment is defined above as being relative to the beginning of an octet stream. The first octet of the stream is octet index zero (0); any data type may be stored starting at this index. Such octet streams begin at the start of a GIOP message header (see GIOP Message Header on page 94) and at the beginning of an encapsulation, even if the encapsulation itself is nested in another encapsulation. (See Encapsulation on page 79).

9.3.1.2 Integer Data Types

Figure 9.1 on page 73 illustrates the representations for OMG IDL integer data types, including the following data types:

- short
- unsigned short
- long
- unsigned long
- long long
- unsigned long long

The figure illustrates bit ordering and size. Signed types (**short**, **long**, and **long long**) are represented as two's complement numbers; unsigned versions of these types are represented as unsigned binary numbers.

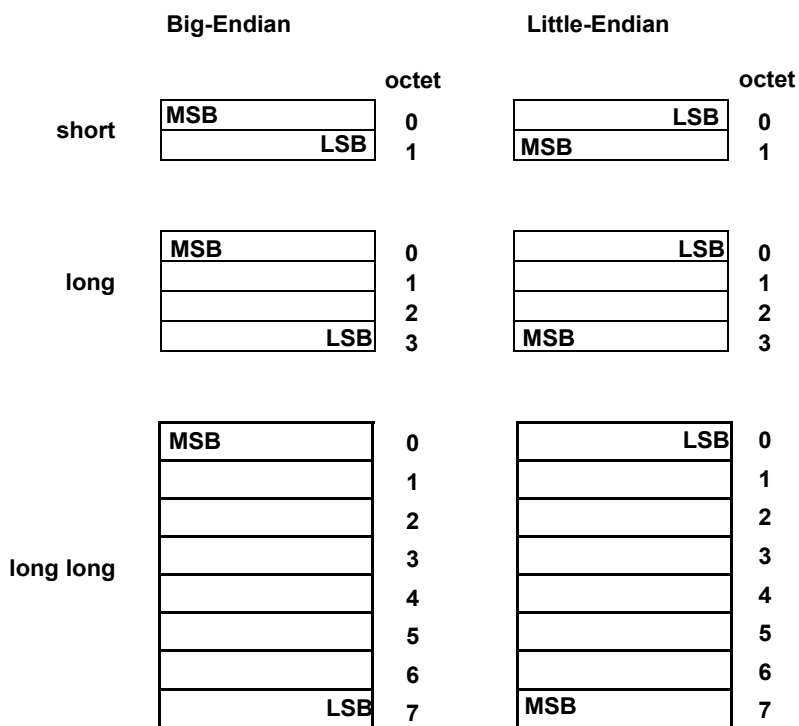

Figure 9.1 - Sizes and bit ordering in big-endian and little-endian encodings of OMG IDL integer data types, both signed and unsigned.

9.3.1.3 Floating Point Data Types

Figure 9.2 on page 75 illustrates the representation of floating point numbers. These exactly follow the IEEE standard formats for floating point numbers¹, selected parts of which are abstracted here for explanatory purposes. The diagram shows three different components for floating points numbers, the sign bit (s), the exponent (e), and the fractional part (f) of the mantissa. The sign bit has values of 0 or 1, representing positive and negative numbers, respectively.

For single-precision float values the exponent is 8 bits long, comprising e1 and e2 in the figure, where the 7 bits in e1 are most significant. The exponent is represented as excess 127. The fractional mantissa (f1 - f3) is a 23-bit value f where $1.0 \leq f < 2.0$, f1 being most significant and f3 being least significant. The value of a normalized number is described by:

$$-1^{sign} \times 2^{(exponent - 127)} \times (1 + fraction)$$

For double-precision values the exponent is 11 bits long, comprising e1 and e2 in the figure, where the 7 bits in e1 are most significant. The exponent is represented as excess 1023. The fractional mantissa (f1 - f7) is a 52-bit value m where $1.0 \leq m < 2.0$, f1 being most significant and f7 being least significant. The value of a normalized number is described by:

$$-1^{sign} \times 2^{(exponent - 1023)} \times (1 + fraction)$$

For double-extended floating-point values the exponent is 15 bits long, comprising e1 and e2 in the figure, where the 7 bits in e1 are the most significant. The fractional mantissa (f1 through f14) is 112 bits long, with f1 being the most significant. The value of a **long double** is determined by:

$$-1^{sign} \times 2^{(exponent - 16383)} \times (1 + fraction)$$

1. "IEEE Standard for Binary Floating-Point Arithmetic," ANSI/IEEE Standard 754-1985, Institute of Electrical and Electronics Engineers, August 1985.

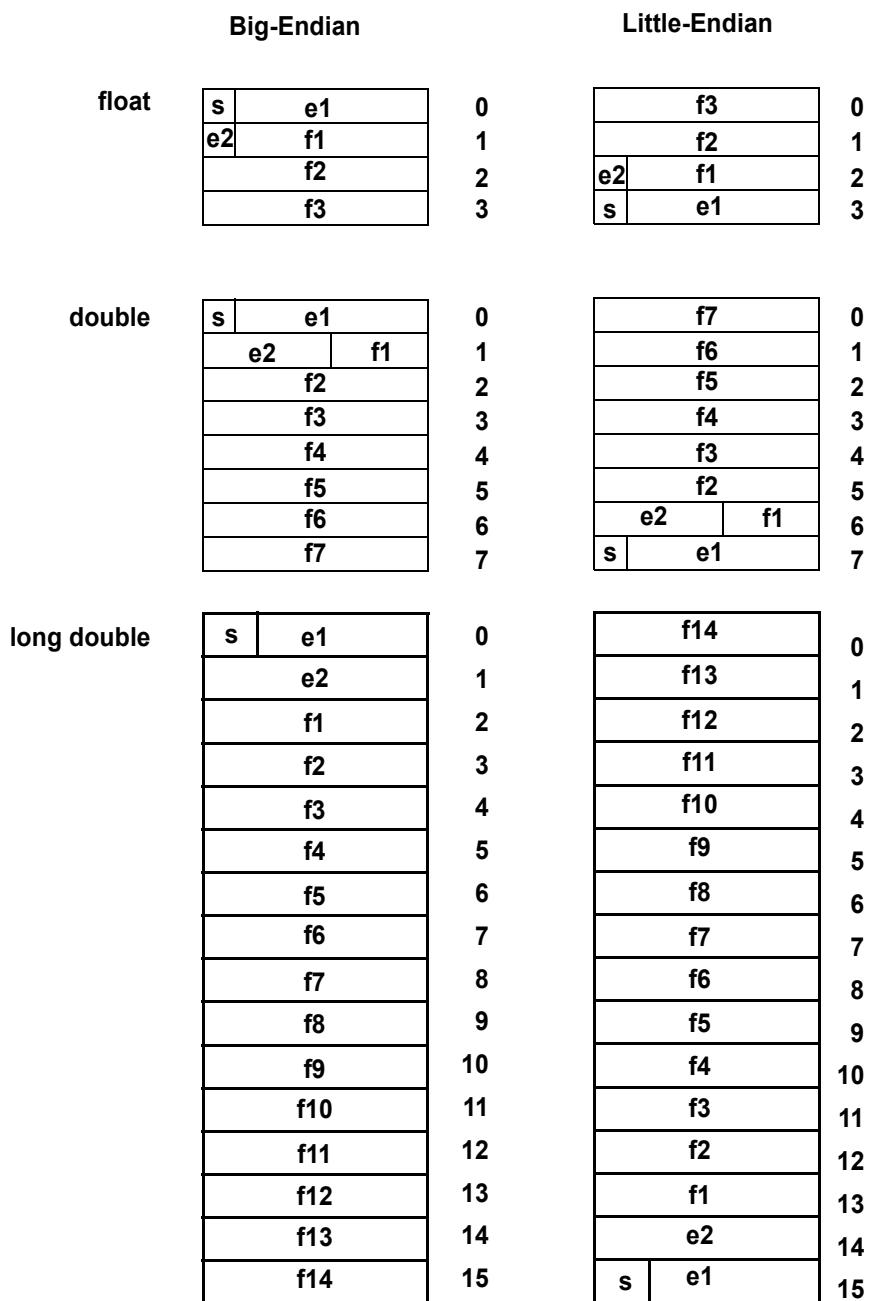

Figure 9.2 - Sizes and bit ordering in big-endian and little-endian representations of OMG IDL single, double precision, and double extended floating point numbers.

9.3.1.4 Octet

Octets are uninterpreted 8-bit values whose contents are guaranteed not to undergo any conversion during transmission. For the purposes of describing possible **octet** values in this specification, octets may be considered as unsigned 8-bit integer values.

9.3.1.5 Boolean

Boolean values are encoded as single octets, where **TRUE** is the value 1, and **FALSE** as 0.

9.3.1.6 Character Types

An IDL character is represented as a single octet; the code set used for transmission of character data (e.g., TCS-C) between a particular client and server ORBs is determined via the process described in Code Set Conversion on page 46. In the case of multi-byte encodings of characters, a single instance of the **char** type may hold only one octet of any multi-byte character encoding.

NOTE: Full representation of multi-byte characters will require the use of an array of IDL **char** variables.

For GIOP version 1.1, the transfer syntax for an IDL wide character depends on whether the transmission code set (TCS-W, which is determined via the process described in Code Set Conversion on page 46) is byte-oriented or non-byte-oriented:

- Byte-oriented (e.g., SJIS). Each wide character is represented as one or more octets, as defined by the selected TCS-W.
- Non-byte-oriented (e.g., Unicode UTF-16). Each wide character is represented as one or more codepoints. A codepoint is the same as “Coded-Character data element,” or “CC data element” in ISO terminology. Each codepoint is encoded using a fixed number of bits as determined by the selected TCS-W. The OSF Character and Code Set Registry may be examined using the interfaces in Relevant OSFM Registry Interfaces on page 58 to determine the maximum length (max_bytes) of any character codepoint.

For GIOP version 1.2, and later **wchar** is encoded as an unsigned binary octet value, followed by the elements of the octet sequence representing the encoded value of the **wchar**. The initial octet contains a count of the number of elements in the sequence, and the elements of the sequence of octets represent the **wchar**, using the negotiated wide character encoding.

NOTE: The GIOP 1.2 and later encoding of **wchar** is similar to the encoding of an octet sequence, except for its use of a single octet to encode the value of the length.

For GIOP versions prior to 1.2 and later, interoperability for **wchar** is limited to the use of two- octet fixed-length encoding.

Wchar values in encapsulations are assumed to be encoded using GIOP version 1.2 and later CDR.

If UTF-16 is selected as the TCS-W, the CDR encoding purposes can be big endian or little endian, but defaults to big endian. By placing a BOM (byte order marker) at the front of the **wstring** or **wchar** encoding, it can be sent either big-endian or little-endian. In particular, the CDR rules for endian-ness of UTF-16 encoded **wstring** or **wchar** values are as follows:

- If the first two bytes (after the length indication) are FE FF, it’s big-endian.
- If the first two bytes (after the length indication) are FF FE, it’s little-endian.
- If the first two bytes (after the length indication) are neither, it’s big-endian.

If an ORB decides to use BOM to indicate endianness, it shall add the BOM to the beginning of **wchar** or **wstring** values when encoding the value, since it is not present in **wchar** or **wstring** values passed by the user.

If a BOM is present at the beginning of a **wchar** or **wstring** received in a GIOP message, the ORB shall remove the BOM before passing the value to the user.

If a client orb erroneously sends **wchar** or **wstring** data in a GIOP 1.0 message, the server shall generate a **MARSHAL** standard system exception, with standard minor code 5.

If a server erroneously sends **wchar** data in a GIOP 1.0 response, the client ORB shall raise a **MARSHAL** exception to the client application with standard minor code 6.

For GIOP 1.1, 1.2, and 1.3, UCS-2 and UCS-4 should be encoded using the endianness of the GIOP message, for backward compatibility.

For GIOP 1.4, the byte order rules for UCS-2 and UCS-4 are the same as for UTF-16.

UTF-16LE and UTF-16BE, from IANA codeset registry, have their own endianness definition. Thus these should be encoded using the endianness specified by their endianness definition.

9.3.2 OMG IDL Constructed Types

Constructed types are built from OMG IDL's data types using facilities defined by the OMG IDL language.

9.3.2.1 Alignment

Constructed types have no alignment restrictions beyond those of their primitive components. The alignment of those primitive types is not intended to support use of marshaling buffers as equivalent to the implementation of constructed data types within any particular language environment. GIOP assumes that agents will usually construct structured data types by copying primitive data between the marshaled buffer and the appropriate in-memory data structure layout for the language mapping implementation involved.

9.3.2.2 Struct

The components of a structure are encoded in the order of their declaration in the structure. Each component is encoded as defined for its data type.

9.3.2.3 Union

Unions are encoded as the discriminant tag of the type specified in the union declaration, followed by the representation of any selected member, encoded as its type indicates.

9.3.2.4 Array

Arrays are encoded as the array elements in sequence. As the array length is fixed, no length values are encoded. Each element is encoded as defined for the type of the array. In multidimensional arrays, the elements are ordered so the index of the first dimension varies most slowly, and the index of the last dimension varies most quickly.

9.3.2.5 Sequence

Sequences are encoded as an unsigned long value, followed by the elements of the sequence. The initial unsigned long contains the number of elements in the sequence. The elements of the sequence are encoded as specified for their type.

9.3.2.6 Enum

Enum values are encoded as unsigned longs. The numeric values associated with enum identifiers are determined by the order in which the identifiers appear in the enum declaration. The first enum identifier has the numeric value zero (0). Successive enum identifiers take ascending numeric values, in order of declaration from left to right.

9.3.2.7 Strings and Wide Strings

A string is encoded as an **unsigned long** indicating the length of the string in octets, followed by the string value in single- or multi-byte form represented as a sequence of octets. The string contents include a single terminating null character. The string length includes the null character, so an empty string has the length of the encoding of the null character in the transmission character set.

For GIOP version 1.1, 1.2, and 1.3, when encoding a string, always encode the length as the total number of bytes used by the encoding string, regardless of whether the encoding is byte-oriented or not.

For GIOP version 1.1, a wide string is encoded as an **unsigned long** indicating the length of the string in octets or unsigned integers (determined by the transfer syntax for wchar) followed by the individual wide characters. The string contents include a single terminating null character. The string length includes the null character. The terminating null character for a wstring is also a wide character.

For GIOP version 1.2 and 1.3, when encoding a **wstring**, always encode the length as the total number of octets used by the encoded value, regardless of whether the encoding is byte-oriented or not. For GIOP version 1.2 and 1.3 a **wstring** is not terminated by a null character. In particular, in GIOP version 1.2 and 1.3 a length of 0 is legal for **wstring**.

NOTE: For GIOP versions prior to 1.2 and 1.3, interoperability for **wstring** is limited to the use of two-octet fixed-length encoding.

Wstring values in encapsulations are assumed to be encoded using GIOP version 1.2 and 1.3 CDR.

9.3.2.8 Fixed-Point Decimal Type

The IDL **fixed** type has no alignment restrictions, and is represented as shown in Figure 9.4. Each **octet** contains (up to) two decimal digits. If the **fixed** type has an odd number of decimal digits, then the representation begins with the first (most significant) digit — d0 in the figure. Otherwise, this first half-octet is all zero, and the first digit is in the second half-octet — d1 in the figure. The sign configuration, in the last half-octet of the representation, is 0xD for negative numbers and 0xC for positive and zero values.

The number of digits present must equal the number of significant digits specified in the IDL definition for the fixed type being marshaled, with the exception of the inclusion of a leading 0x0 half octet when there are an even number of significant digits.

Decimal digits are encoded as hexadecimal values in each half-octet as follows:

Decimal Digit	Half-Octet Value
0	0x0
1	0x1
2	0x2
...	...
9	0x9

Figure 9.3 - Decimal Digit Encoding for Fixed Type

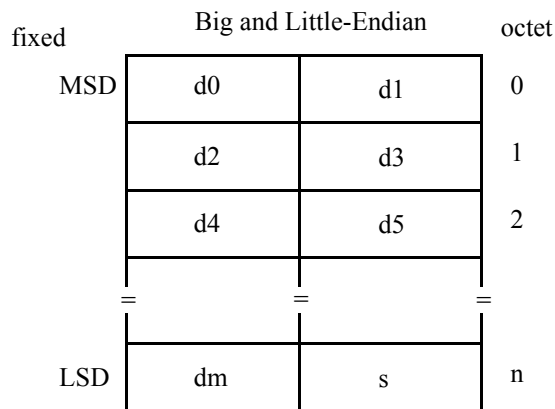

Figure 9.4 - IDL Fixed Type Representation

9.3.3 Encapsulation

Encapsulations are octet streams into which OMG IDL data structures may be marshaled independently, apart from any particular message context. Once a data structure has been encapsulated, the **octet** stream can be represented as the OMG IDL opaque data type **sequence<octet>**, which can be marshaled subsequently into a message or another encapsulation. Encapsulations allow complex constants (such as TypeCodes) to be pre-marshaled; they also allow certain message components to be handled without requiring full unmarshaling. Whenever encapsulations are used in CDR or the GIOP, they are clearly noted.

The GIOP and IIOP explicitly use encapsulations in three places: *TypeCodes* (see TypeCode on page 87), the IIOP protocol profile inside an IOR (see Object References on page 93), and in service-specific context (see Service Context on page 38). In addition, some ORBs may choose to use an encapsulation to hold the **object_key** (see IIOP IOR Profiles on page 112), or in other places that a **sequence<octet>** data type is in use.

When encapsulating OMG IDL data types, the first octet in the stream (index 0) contains a boolean value indicating the byte ordering of the encapsulated data. If the value is **FALSE** (0), the encapsulated data is encoded in big-endian order; if **TRUE** (1), the data is encoded in little-endian order, exactly like the byte order flag in GIOP message headers (see GIOP Message Header on page 94). This value is not part of the data being encapsulated, but is part of the octet stream holding the encapsulation. Following the byte order flag, the data to be encapsulated is marshaled into the buffer as defined by CDR encoding rules. Marshaled data are aligned relative to the beginning of the octet stream (the first octet of which is occupied by the byte order flag).

When the encapsulation is encoded as type **sequence<octet>** for subsequent marshaling, an unsigned long value containing the sequence length is prefixed to the octet stream, as prescribed for sequences (see Sequence on page 77). The length value is not part of the encapsulation's octet stream, and does not affect alignment of data within the encapsulation.

Note that this guarantees a four-octet alignment of the start of all encapsulated data within GIOP messages and nested encapsulations.²

Whenever the use of an encapsulation is specified, the GIOP version to use for encoding the encapsulation, if different than GIOP version 1.0, shall be explicitly defined (i.e., the default is GIOP 1.0).

If a parameter with IDL char or string type is defined to be carried in an encapsulation using GIOP version greater than 1.0, the transmission Code Set for characters (TCS-C), to be used when encoding the encapsulation, shall also be explicitly defined.

If a parameter with IDL wchar or wstring type is defined to be carried in an encapsulation using GIOP version greater than 1.0, the transmission Code Set for wide characters (TCS-W), to be used when encoding the encapsulation shall also be explicitly defined.

9.3.4 Value Types

Value types are built from OMG IDL's value type definitions. Their representation and encoding is defined in this sub clause.

Value types may be used to transmit and encode complex state. The general approach is to support the transmission of the data (state) and type information encoded as **RepositoryIDs**.

The loading (and possible transmission) of code is outside of the scope of the GIOP definition, but enough information is carried to support it, via the CodeBase object.

The format makes a provision for the support of custom marshaling (i.e., the encoding and transmission of state using application-defined code). Consistency between custom encoders and decoders is not ensured by the protocol.

The encoding supports all of the features of value types as well as supporting the "chunking" of value types. It does so in a compact way.

At a high level the format can be described as the linearization of a graph. The graph is the depth-first exploration of the transitive closure that starts at the top-level value object and follows its "reference to value objects" fields (an ordinary remote reference is just written as an IOR). It is a recursive encoding similar to the one used for **TypeCodes**. An indirection is used to point to a value that has already been encoded.

The data members are written beginning with the highest possible base type to the most derived type in the order of their declaration.

9.3.4.1 Partial Type Information and Versioning

The format provides support for partial type information and versioning issues in the receiving context. However the encoding has been designed so that this information is only required when "advanced features" such as truncation are used.

The presence (or absence) of type information and codebase URL information is indicated by flags within the <value_tag>, which is a **long** in the range between **0x7fffff00** and **0x7fffffff** inclusive. The last octet of this tag is interpreted as follows:

- The least significant bit (<value_tag> & **0x00000001**) is the value **1** if a <codebase_URL> is present. If this bit is **0**, no <codebase_URL> follows in the encoding. The <codebase_URL> is a blank-separated list of one or more URLs.

-
2. Accordingly, in cases where encapsulated data holds data with natural alignment of greater than four octets, some processors may need to copy the octet data before removing it from the encapsulation. For example, an appropriate way to deal with long long discriminator type in an encapsulation for a union TypeCode is to encode the body of the encapsulation as if it was aligned at the 8 byte boundary, and then copy the encoded value into the encapsulation. This may result in long long data values inside the encapsulation being aligned on only a 4 byte boundary when viewed from outside the encapsulation.

- The second and third least significant bits (<value_tag> & **0x00000006**) are:
 - the value **0** if no type information is present in the encoding. This indicates the actual parameter is the same type as the formal argument.
 - the value **2** if only a single repository id is present in the encoding, which indicates the most derived type of the actual parameter (which may be either the same type as the formal argument or one of its derived types).
 - the value **6** if the partial type information list of repository ids is present in the encoding as a list of repository ids.

When a list of **RepositoryIDs** is present, the encoding is a **long** specifying the number of **RepositoryIDs**, followed by the **RepositoryIDs**. The first **RepositoryID** is the id for the most derived type of the value. If this type has any base types, the sending context is responsible for listing the **RepositoryIDs** for all the base types to which it is safe to truncate the value passed. These truncatable base types are listed in order, going up the derivation hierarchy. The sending context may choose to (but need not) terminate the list at any point after it has sent a **RepositoryID** for a type well known to the receiving context. A well known type is any of the following:

- A type that is a formal parameter, result of the method call, or exception, for which this GIOP message is being marshaled.
- A base type of a well known type.
- A member type of a well known type.
- An element type of a well known type.

For value types that have an RMI: **RepositoryId**, ORBs must include at least the most derived **RepositoryId**, in the value type encoding.

For value types marshaled as abstract interfaces (see Abstract Interfaces on page 93), **RepositoryId** information must be included in the value type encoding.

If the receiving context needs more typing information than is contained in a GIOP message that contains a codebase URL information, it can go back to the sending context and perform a lookup based on that **RepositoryID** to retrieve more typing information (e.g., the type graph).

CORBA **RepositoryIDs** may contain standard version identification (major and minor version numbers or a hash code information). The ORB run time may use this information to check whether the version of the value being transmitted is compatible with the version expected. In the event of a version mismatch, the ORB may apply product-specific truncation/conversion rules (with the help of a local interface repository or the **SendingContext::RunTime** service). For example, the Java serialization model of truncation/conversion across versions can be supported. See the JDK 1.1 documentation for a detailed specification of this model.

9.3.4.2 Example

The following examples demonstrate legal combinations of truncatability, actual parameter types and GIOP encodings. This is not intended to be an exhaustive list of legal possibilities.

The following example uses valuetypes **animal** and **horse**, where **horse** is derived from **animal**. The actual parameters passed to the specified operations are **an_animal** of runtime type **animal** and **a_horse** of runtime type **horse**.

The following combinations of truncatability, actual parameter types and GIOP encodings are legal.

1. If there is a single operation:

op1(in animal a);

a). If the type **horse** cannot be truncated to **animal** (i.e., **horse** is declared):

valuetype horse: animal ...

then the encoding is as shown below:

Actual Invocation	Legal Encoding
op1(a_horse)	2 horse
	6 1 horse

Note that if the type horse is not available to the receiver, then the receiver throws a demarshaling exception.

b). If the type **horse** can be truncated to **animal** (i.e., **horse** is declared):

valuetype horse: truncatable animal ...

then the encoding is as shown below

Actual Invocation	Legal Encoding
op1(a_horse)	6 2 horse animal

Note that if the type horse is not available to the receiver, then the receiver tries to truncate to animal.

c). Regardless of the truncation relationships, when the exact type of the formal argument is sent, then the encoding is as shown below:

Actual Invocation	Legal Encoding
op1(an_animal)	0
	2 animal
	6 1 animal

2. Given the additional operation:

op2(in horse h);

(i.e., the sender knows that both types **horse** and **animal** and their derivation relationship are known to the receiver)

a). If the type horse cannot be truncated to animal (i.e., horse is declared):

valuetype horse: animal ...

then the encoding is as shown below:

Actual Invocation	Legal Encoding
op2(a_horse)	2 horse
	6 1 horse

Note that the demarshaling exception of case 1 will not occur, since horse is available to the receiver.

b). If the type horse can be truncated to animal (i.e., horse is declared):

valuetype horse: truncatable animal ...

then the encoding is as shown below:

Actual Invocation	Legal Encoding
op2 (a_horse)	2 horse
	6 1 horse
	6 2 horse animal

Note that truncation will not occur, since horse is available to the receiver.

9.3.4.3 Scope of the Indirections

The special value **0xffffffff** introduces an indirection (i.e., it directs the decoder to go somewhere else in the marshaling buffer to find what it is looking for). This can be codebase URL information that has already been encoded, a **RepositoryID** that has already been encoded, a list of repository IDs that has already been encoded, or another value object that is shared in a graph. **0xffffffff** is always followed by a **long** indicating where to go in the buffer. A repositoryID or URL, which is the target of an indirection used for encoding a valuetype must have been introduced as the type or codebase information for a valuetype.

It is not permissible for a repositoryID marshaled for some purpose other than as the type information of a valuetype to use indirection to reference a previously marshaled value. The encoding used to indicate an indirection is the same as that used for recursive **TypeCodes** (i.e., a **0xffffffff** indirection marker followed by a **long** offset (in units of **octets**) from the beginning of the long offset). As an example, this means that an offset of negative four (-4) is illegal, because it is self-indirecting to its indirection marker. Indirections may refer to any preceding location in the GIOP message, including previous fragments if fragmentation is used. This includes any previously marshaled parameters. Non-negative offsets are reserved for future use. Indirections may not cross encapsulation boundaries.

Fragmentation support in GIOP versions 1.1, 1.2, and 1.3 introduces the possibility of a header for a **FragmentMessage** being marshaled between the target of an indirection and the start of the encapsulation containing the indirection. The octets occupied by any such headers are not included in the calculation of the offset value.

9.3.4.4 Null Values

All value types have a distinguished “null.” All null values are encoded by the <null_tag> (0x0). The CDR encoding of null values includes no type information.

9.3.4.5 Other Encoding Information

A “new” value is coded as a value header followed by the value’s state. The header contains a tag and codebase URL information if appropriate, followed by the **RepositoryID** and an octet flag of bits. Because the same **RepositoryID** (and codebase URL information) could be repeated many times in a single request when sending a complex graph, they are encoded as a regular string the first time they appear, and use an indirection for later occurrences.

9.3.4.6 Fragmentation

It is anticipated that value types may be rather large, particularly when a graph is being transmitted. Hence the encoding supports the breaking up of the serialization into an arbitrary number of chunks in order to facilitate incremental processing.

Values with **truncatable** base types need a length indication in case the receiver needs to truncate them to a base type. Value types that are custom marshaled also need a length indication so that the ORB run time can know exactly where they end in the stream without relying on user-defined code. This allows the ORB to maintain consistency and ensure the integrity of the GIOP stream when the user-written custom marshaling and demarshaling does not marshal the entire value state. For simplicity of encoding, we use a length indication for all values whether or not they have a truncatable base type or use custom marshaling.

If limited space is available for marshaling, it may be necessary for the ORB to send the contents of a marshaling buffer containing a partially marshaled value as a GIOP fragment. At that point in the marshaling, the length of the entire value being marshaled may not be known. Calculating this length may require processing as costly as marshaling the entire value. It is therefore desirable to allow the value to be encoded as multiple chunks, each with its own length. This allows the portion of a value that occupies a marshaling buffer to be sent as a chunk of known length with no need for additional length calculation processing.

The data may be split into multiple chunks at arbitrary points except within primitive CDR types, arrays of primitive types, strings, and wstrings, or between the tag and offset of indirections. It is never necessary to end a chunk within one of these types as the length of these types is known before starting to marshal them so they can be added to the length of the currently open chunk. It is the responsibility of the CDR stream to hide the chunking from the marshaling code.

The presence (or absence) of chunking is indicated by flags within the `<value_tag>`. The fourth least significant bit (`<value_tag> & 0x00000008`) is the value 1 if a chunked encoding is used for the value's state. The chunked encoding is required for custom marshaling and truncation. If this bit is 0, the state is encoded as `<octets>`.

Each chunk is preceded by a positive long, which specifies the number of octets in the chunk.

A chunked value is terminated by an end tag that is a non-positive long so the start of the next value can be differentiated from the start of another chunk. In the case of values that contain other values (e.g., a linked list) the "nested" value is started without there being an end tag. The absolute value of an end tag (when it finally appears) indicates the nesting level of the value being terminated. A single end tag can be used to terminate multiple nested values. The detailed rules are as follows:

- End tags, chunk size tags, and value tags are encoded using non-overlapping ranges so that the unmarshaling code can tell after reading each chunk whether:
 - another chunk follows (positive tag).
 - one or multiple value types are ending at a given point in the stream (negative tag).
 - a nested value follows (special large positive tag).
- The end tag is a negative long whose value is the negation of the absolute nesting depth of the value type ending at this point in the CDR stream. Any value types that have not already been ended and whose nesting depth is greater than the depth indicated by the end tag are also implicitly ended. The end tag value **0** is reserved for future use (e.g., supporting a nesting depth of more than **2³¹**). The outermost value type will always be terminated by an end tag with a value of **-1**. Enclosing non-chunked valuetypes are not considered when determining the nesting depth.

The following example describes how end tags may be used. Consider a valuetype declaration that contains two member values:

```
// IDL
    valuetype simpleNode{ ... };
    valuetype node truncatable simpleNode {
    public node node1;
    public node node2;
};
```

When an instance of type ‘**node**’ is passed as a parameter of type ‘**simpleNode**’ a chunked encoding is used. In all cases, the outermost value is terminated with an end tag with a value of **-1**. The nested value ‘**node1**’ is terminated with an end tag with a value of **-2** since only the second-level value ‘**node1**’ ends at that point. Since the nested value ‘**node2**’ coterminates with the outermost value, either of the following end tag layouts is legal:

- A single end tag with a value of **-1** marks the termination of the outermost value, implying the termination of the nested value, ‘**node2**’ as well. This is the most compact marshaling.
- An end tag with a value of **-2** marks the termination of the nested value, ‘**node2**.’ This is then followed by an end tag with a value of **-1** to mark the termination of the outermost value.

Because data members are encoded in their declaration order, declaring a value type data member of a value type last is likely to result in more compact encoding on the wire because it maximizes the number of values ending at the same place and so allows a single end tag to be used for multiple values. The canonical example for that is a linked list.

- For the purposes of chunking, values encoded as indirections or null are treated as non-value data.
- Chunks are never nested. When a value is nested within another value, the outer value’s chunk ends at the place in the stream where the inner value starts. If the outer value has non-value data to be marshaled following the inner value, the end tag for the inner value is followed by a continuation chunk for the remainder of the outer value.
- Regardless of the above rules, any value nested within a chunked value is always chunked. Furthermore, any such nested value that is truncatable must encode its type information as a list of **RepositoryIDs** (see Section 9.3.4.1, Partial Type Information and Versioning, on page 80).
- The scope of an encoded valuetype is a complete GIOP message or an encapsulation. Starting a new encapsulation starts a new scope. Ending an encapsulation ends the current scope and restores the previous scope. Starting a new scope starts a new count of end tag nesting (initially 0), chunking status (initially false) and chunk position (initially 0).
- Chunks in the same scope are never nested. When a value is nested within another value, the outer value's chunk ends at the place in the stream where the inner value starts. If the outer value has non-value data to be marshaled following the inner value, the end tag for the inner value is followed by a continuation chunk for the remainder of the outer value.
- Regardless of the above rules, any value nested within a chunked value in the same scope is always chunked. Furthermore, any such nested value that is truncatable must encode its type information as a list of RepositoryIDs (see Partial Type Information and Versioning on page 80).

Truncating a value type in the receiving context may require keeping track of unused nested values (only during unmarshaling) in case further indirection tags point back to them. These values can be held in their “raw” GIOP form, as fully unmarshaled value objects, or in any other product-specific form.

Value types that are custom marshaled are encoded as chunks in order to let the ORB run-time know exactly where they end in the stream without relying on user-defined code.

9.3.4.7 Notation

The on-the-wire format is described by a BNF grammar with conventions similar to the ones used to define IDL syntax. *The terminals of the grammar are to be interpreted differently.* We are describing a protocol format. Although the terminals have the same names as IDL tokens they represent either:

- constant tags, or
- the GIOP CDR encoding of the corresponding IDL construct.

For example, **long** is a shorthand for the GIOP encoding of the IDL **long** data type -with all the GIOP alignment rules. Similarly **struct** is a shorthand for the GIOP CDR encoding of a **struct**.

A **(type) constant** means that an instance of the given type having the given value is encoded according to the rules for that type. So that **(long) 0** means that a CDR encoding for a long having the value **0** appears at that location.

9.3.4.8 The Format

- (1) `<value> ::= <value_tag> [<codebase_URL>]
 [<type_info>] <state>
 | <value_ref>`
- (2) `<value_ref> ::= <indirection_tag> <indirection> | <null_tag>`
- (3) `<value_tag> ::= long // 0x7fffff00 <= value_tag <= 0x7fffff`
- (4) `<type_info> ::= <rep_ids> | <repository_id>`
- (5) `<state> ::= <octets> | <value_data>* [<end_tag>]`
- (6) `<value_data> ::= <value_chunk> | <value>`
- (7) `<rep_ids> ::= long <repository_id>+
 | <indirection_tag> <indirection>`
- (8) `<repository_id> ::= string | <indirection_tag> <indirection>`
- (9) `<value_chunk> ::= <chunk_size_tag> <octets>`
- (10) `<null_tag> ::= (long) 0`
- (11) `<indirection_tag> ::= (long) 0xffffffff`
- (12) `<codebase_URL> ::= string | <indirection_tag> <indirection>`
- (13) `<chunk_size_tag> ::= long
 // 0 < chunk_size_tag < 231-256 (0x7fffff00)`
- (14) `<end_tag> ::= long // -231 < end_tag < 0`
- (15) `<indirection> ::= long // -231 < indirection < 0`
- (16) `<octets> ::= octet | octet <octets>`

The concatenated octets of consecutive value chunks within a value encode state members for the value according to the following grammar:

- (1) `<state members> ::= <state_member>
 | <state_member> <state members>`
- (2) `<state_member> ::= <value_ref>
 // All legal IDL types should be here
 | octet
 | boolean
 | char
 | short`

	unsigned short
	long
	unsigned long
	float
	wchar
	wstring
	string
	struct
	union
	sequence
	array
	Object
	any
	long long
	unsigned long long
	double
	long double
	fixed

9.3.5 Pseudo-Object Types

CORBA defines some kinds of entities that are neither primitive types (integral or floating point) nor constructed ones.

9.3.5.1 TypeCode

In general, **TypeCodes** are encoded as the **TCKind** enum value, potentially followed by values that represent the **TypeCode** parameters. Unfortunately, **TypeCodes** cannot be expressed simply in OMG IDL, since their definitions are recursive. The basic **TypeCode** representations are given in Table 9.2 on page 88. The *integer value* column of this table gives the **TCKind** enum value corresponding to the given **TypeCode**, and lists the parameters associated with such a **TypeCode**. The rest of this sub clause presents the details of the encoding.

Basic TypeCode Encoding Framework

The encoding of a **TypeCode** is the **TCKind** enum value (encoded, like all **enum** values, using four octets), followed by zero or more parameter values. The encodings of the parameter lists fall into three general categories, and differ in order to conserve space and to support efficient traversal of the binary representation:

- Typecodes with an *empty parameter list* are encoded simply as the corresponding **TCKind** enum value.
- Typecodes with *simple parameter lists* are encoded as the **TCKind** enum value followed by the parameter value(s), encoded as indicated in Table 9.2. A “simple” parameter list has a fixed number of fixed length entries, or a single parameter that has its length encoded first.
- All other typecodes have *complex parameter lists*, which are encoded as the **TCKind** enum value followed by a CDR encapsulation octet sequence (see Encapsulation on page 79) containing the encapsulated, marshaled parameters. The order of these parameters is shown in the fourth column of Table 9.2.

The third column of Table 9.2 shows whether each parameter list is *empty*, *simple*, or *complex*. Also, note that an internal indirection facility is needed to represent some kinds of typecodes; this is explained in Indirection: Recursive and Repeated TypeCodes on page 91. This indirection does not need to be exposed to application programmers.

TypeCode Parameter Notation

TypeCode parameters are specified in the fourth column of Table 9.2 on page 88. The ordering and meaning of parameters is a superset of those given in the *ORB Interface* clause, CORBA, Part 1 specification. More information is needed by CDR's representation in order to provide the full semantics of **TypeCodes** as shown by the API.

- Each parameter is written in the form *type (name)*, where *type* describes the parameter's type, and *name* describes the parameter's meaning.
- The encoding of some parameter lists (specifically, **tk_struct**, **tk_union**, **tk_enum**, and **tk_except**) contain a counted sequence of tuples.

Such counted tuple sequences are written in the form *count {parameters}*, where *count* is the number of tuples in the encoded form, and the *parameters* enclosed in braces are available in each tuple instance. First the *count*, which is an unsigned long, and then each *parameter* in each tuple (using the noted type), is encoded in the CDR representation of the typecode. Each tuple is encoded, first parameter followed by second, before the next tuple is encoded (first, then second, etc.).

Note that the tuples identifying **struct**, union, **exception**, and **enum** members must be in the order defined in the OMG IDL definition text. Also, that the types of discriminant values in encoded **tk_union TypeCodes** are established by the second encoded parameter (*discriminant type*), and cannot be specified except with reference to a specific OMG IDL definition.³

Table 9.2

TCKind	Integer Value	Type	Parameters
tk_null	0	empty	– none –
tk_void	1	empty	– none –
tk_short	2	empty	– none –
tk_long	3	empty	– none –
tk_ushort	4	empty	– none –
tk_ulong	5	empty	– none –
tk_float	6	empty	– none –
tk_double	7	empty	– none –
tk_boolean	8	empty	– none –
tk_char	9	empty	– none –
tk_octet	10	empty	– none –
tk_any	11	empty	– none –
tk_TypeCode	12	empty	– none –
tk_Principal	13	empty	– none –
tk_objref	14	complex	string (repository ID), string(name)

Table 9.2

TCKind	Integer Value	Type	Parameters
tk_struct	15	complex	string (repository ID), string (name), ulong (count) {string (member name), TypeCode (member type)}
tk_union	16	complex	string (repository ID), string(name), TypeCode (discriminant type), long (default used), ulong (count) <i>{discriminant type^a (label value),</i> string (member name), TypeCode (member type)}
tk_enum	17	complex	string (repository ID), string (name), ulong (count) {string (member name)}
tk_string	18	simple	ulong (max length ^b)
tk_sequence	19	complex	TypeCode (element type), ulong (max length ^c)
tk_array	20	complex	TypeCode (element type), ulong (length)
tk_alias	21	complex	string (repository ID), string (name), TypeCode
tk_except	22	complex	string (repository ID), string (name), ulong (count) {string (member name), TypeCode (member type)}
tk_longlong	23	empty	– none –
tk_ulonglong	24	empty	– none –
tk_longdouble	25	empty	– none –
tk_wchar	26	empty	– none –

-
3. This means that, for example, two OMG IDL unions that are textually equivalent, except that one uses a “char” discriminant, and the other uses a “long” one, would have different size encoded TypeCodes.

Table 9.2

TCKind	Integer Value	Type	Parameters
tk_wstring	27	simple	ulong(max length or zero if unbounded)
tk_fixed	28	simple	ushort(digits), short(scale)
tk_value	29	complex	string (repository ID), string (name, may be empty), short(ValueModifier), TypeCode(of concrete base) ^d , ulong (count), {string (member name), TypeCode (member type), short(Visibility)}
tk_value_box	30	complex	string (repository ID), string(name), TypeCode
tk_native	31	complex	string (repository ID), string(name)
tk_abstract_interface	32	complex	string(RepositoryId), string(name)
tk_local_interface	33	complex	string(RepositoryId), string(name)
tk_component	34	complex	string (repository ID), string(name)
tk_home	35	complex	string (repository ID), string(name)
tk_event	36	complex	string (repository ID), string (name, may be empty), short(ValueModifier), TypeCode(of concrete base) ^e , ulong (count), {string (member name), TypeCode (member type), short(Visibility)}
– none –	0xffffffff	simple	long (indirection ^f)

- a. The type of union label values is determined by the second parameter, discriminant type.
- b. For unbounded strings, this value is zero.
- c. For unbounded sequences, this value is zero.
- d. Should be **tk_null** if there is no concrete base.
- e. Should be tk_null if there is no concrete base.
- f. See Indirection: Recursive and Repeated TypeCodes on page 91.

9.3.5.1.1 Encoded Identifiers and Names

The Repository ID parameters in **tk_objref**, **tk_struct**, **tk_union**, **tk_enum**, **tk_alias**, **tk_except**, **tk_native**, **tk_value**, **tk_value_box**, and **tk_abstract_interface** TypeCodes are Interface Repository **RepositoryId** values, whose format is described in the specification of the Interface Repository.

For GIOP 1.2 onwards, repositoryID values are required to be sent, if known by the ORB⁴. For GIOP 1.2 and 1.3 an empty repositoryID string is only allowed if a repositoryID value is not available to the ORB sending the type code.

For GIOP 1.0 and 1.1, **RepositoryId** values are required for **tk_objref** and **tk_except** TypeCodes; for **tk_struct**, **tk_union**, **tk_enum**, and **tk_alias** TypeCodes **RepositoryIds** are optional and encoded as empty strings if omitted.

The **name** parameters in **tk_objref**, **tk_struct**, **tk_union**, **tk_enum**, **tk_alias**, **tk_value**, **tk_value_box**, **tk_abstract_interface**, **tk_native** and **tk_except** TypeCodes and the **member name** parameters in **tk_struct**, **tk_union**, **tk_enum**, **tk_value**, and **tk_except** TypeCodes are not specified by (or significant in) GIOP. Agents should not make assumptions about type equivalence based on these name values; only the structural information (including **RepositoryId** values, if provided) is significant. If provided, the strings should be the simple, unscoped names supplied in the OMG IDL definition text. If omitted, they are encoded as empty strings.

When a reference to a base **Object** is encoded, there are two allowed encodings for the Repository ID: either “IDL:omg.org/CORBA/Object:1.0” or “” may be used.

Encoding the tk_union Default Case

In **tk_union TypeCodes**, the **long default used** value is used to indicate which tuple in the sequence describes the union’s **default** case. If this value is less than zero, then the union contains no default case. Otherwise, the value contains the zero-based index of the default case in the sequence of tuples describing union members.

The discriminant value used in the actual typecode parameter associated with the default member position in the list, may be any valid value of the discriminant type, and has no semantic significance (i.e., it should be ignored and is only included for syntactic completeness of union type code marshaling).

TypeCodes for Multi-Dimensional Arrays

The **tk_array TypeCode** only describes a single dimension of any array. **TypeCodes** for multi-dimensional arrays are constructed by nesting **tk_array TypeCodes** within other **tk_array TypeCodes**, one per array dimension. The outermost (or top-level) **tk_array TypeCode** describes the leftmost array index of the array as defined in IDL; the innermost nested **tk_array TypeCode** describes the rightmost index.

Indirection: Recursive and Repeated TypeCodes

The typecode representation of OMG IDL data types that can indirectly contain instances of themselves (e.g., **struct foo {sequence <foo> bar;}**) must also contain an indirection. Such an indirection is also useful to reduce the size of encodings; for example, unions with many cases sharing the same value.

CDR provides a constrained indirection to resolve this problem:

- The indirection applies only to TypeCodes nested within some “top-level” TypeCode. Indirected TypeCodes are not “freestanding,” but only exist inside some other encoded TypeCode.
- For GIOP 1.2 and below, the indirection applies only to TypeCodes nested within some “top-level” TypeCode. Indirected TypeCodes are not “freestanding,” but only exist inside some other encoded TypeCode.
- For GIOP 1.3 and above, the indirection applies only to TypeCodes nested within some “top-level” TypeCode, or from

4. A type code passed via a GIOP 1.2 connection shall contain non-empty repositoryID strings, unless a repositoryID value is not available to the sending ORB for a specific type code. This situation can arise, for example, if an ORB receives a type code containing empty repository IDs via a GIOP 1.0 or 1.1 connection and passes that type code on via a GIOP 1.2 connection).

one top-level TypeCode to another. Indirected TypeCodes nested within a top-level TypeCode can only reference TypeCodes that are part of the same top-level TypeCode, including the top-level TypeCode itself. Indirected top-level TypeCodes can reference other top-level TypeCodes but cannot reference TypeCodes nested within some other top-level TypeCode.

- Only the second (and subsequent) references to a **TypeCode** in that scope may use the indirection facility. The first reference to that **TypeCode** must be encoded using the normal rules. In the case of a recursive **TypeCode**, this means that the first instance will not have been fully encoded before a second one must be completely encoded.

The indirection is a numeric octet offset within the scope of the “top-level” **TypeCode** and points to the **TCKind** value for the typecode. (Note that the byte order of the **TCKind** value can be determined by its encoded value.) This indirection may well cross encapsulation boundaries, but this is not problematic because of the first constraint identified above. Because of the second constraint, the value of the offset will always be negative.

Fragmentation support in GIOP versions 1.1, 1.2, and 1.3 introduces the possibility of a header for a **FragmentMessage** being marshaled between the target of an indirection and the start of the encapsulation containing the indirection. The octets occupied by any such headers are not included in the calculation of the offset value.

The encoding of such an indirection is as a **TypeCode** with a “**TCKind** value” that has the special value $2^{32}-1$ (**0xffffffff**, all ones). Such typecodes have a single (simple) parameter, which is the **long** offset (in units of octets) from the simple parameter. (This means that an offset of negative four (-4) is illegal because it will be self-indirecting.)

9.3.5.2 Any

Any values are encoded as a **TypeCode** (encoded as described above) followed by the encoded value. For **Any** values containing a **tk_null** or **tk_void TypeCode**, the encoded value shall have zero length (i.e., shall be absent).

9.3.5.3 Principal

Principal pseudo objects are encoded as **sequence<octet>**. In the absence of a Security service specification, **Principal** values have no standard format or interpretation, beyond serving to identify callers (and potential callers). This specification does not prescribe any usage of **Principal** values.

By representing **Principal** values as **sequence<octet>**, GIOP guarantees that ORBs may use domain-specific principal identification schemes; such values undergo no translation or interpretation during transmission. This allows bridges to translate or interpret these identifiers as needed when forwarding requests between different security domains.

9.3.5.4 Context

Context pseudo objects are encoded as **sequence<string>**. The strings occur in pairs. The first string in each pair is the context property name, and the second string in each pair is the associated value. If an operation has an IDL context sub clause but the client does not supply any properties matching the context sub clause at run time, an empty sequence is marshaled.

9.3.5.5 Exception

Exceptions are encoded as a string followed by exception members, if any. The string contains the RepositoryId for the exception, as defined in the *Interface Repository* clause of CORBA (Part 1). Exception members (if any) are encoded in the same manner as a struct.

If an ORB receives a non-standard system exception that it does not support, or a user exception that is not defined as part of the operation’s definition, the exception shall be mapped to UNKNOWN, with standard minor code set to 2 for a system exception, or set to 1 for a user exception.

9.3.6 Object References

Object references are encoded in OMG IDL (as described in Object Addressing on page 23). IOR profiles contain transport-specific addressing information, so there is no general-purpose IOR profile format defined for GIOP. Instead, this specification describes the general information model for GIOP profiles and provides a specific format for the IIOP (see IIOP IOR Profiles on page 112).

In general, GIOP profiles include at least these three elements:

1. The version number of the transport-specific protocol specification that the server supports.
2. The address of an endpoint for the transport protocol being used.
3. An opaque datum (an **object_key**, in the form of an octet sequence) used exclusively by the agent at the specified endpoint address to identify the object.

9.3.7 Abstract Interfaces

Abstract interfaces are encoded as a union with a **boolean** discriminator. The **union** has an *object reference* (see Object References on page 93) if the discriminator is **TRUE**, and a *value type* (see Value Types on page 80) if the discriminator is **FALSE**. The encoding of value types marshaled as abstract interfaces always includes **RepositoryId** information. If there is no indication whether a nil abstract interface represents a nil object reference or a null valuetype, it shall be encoded as a null valuetype.

9.4 GIOP Message Formats

GIOP has restriction on client and server roles with respect to initiating and receiving messages. For the purpose of GIOP versions 1.0 and 1.1, a client is the agent that opens a connection (see more details in Connection Management on page 108) and originates requests. Likewise, for GIOP versions 1.0 and 1.1, a server is an agent that accepts connections and receives requests. When Bidirectional GIOP is in use for GIOP protocol version 1.2 and 1.3, either side may originate messages, as specified in Bi-Directional GIOP on page 115.

GIOP message types are summarized in Table 9.3, which lists the message type names, whether the message is originated by client, server, or both, and the value used to identify the message type in GIOP message headers.

Table 9.3

Message Type	Originator	Value	GIOP Versions
Request	Client	0	1.0, 1.1, 1.2, 1.3
Request	Both	0	1.2 with BiDir GIOP in use, 1.3 with BiDir GIOP in use
Reply	Server	1	1.0, 1.1, 1.2, 1.3
Reply	Both	1	1.2 with BiDir GIOP in use, 1.3 with BiDir GIOP in use
CancelRequest	Client	2	1.0, 1.1, 1.2, 1.3

Table 9.3

Message Type	Originator	Value	GIOP Versions
CancelRequest	Both	2	1.2 with BiDir GIOP in use, 1.3 with BiDir GIOP in use
LocateRequest	Client	3	1.0, 1.1, 1.2, 1.3
LocateRequest	Both	3	1.2 with BiDir GIOP in use, 1.3 with BiDir GIOP in use
LocateReply	Server	4	1.0, 1.1, 1.2, 1.3
LocateReply	Both	4	1.2 with BiDir GIOP in use, 1.3 with BiDir GIOP in use
CloseConnection	Server	5	1.0, 1.1, 1.2, 1.3
CloseConnection	Both	5	1.2, 1.3
MessageError	Both	6	1.0, 1.1, 1.2, 1.3
Fragment	Both	7	1.1, 1.2, 1.3

9.4.1 GIOP Message Header

All GIOP messages begin with the following header, defined in OMG IDL:

```

module GIOP { // IDL extended for version 1.1, 1.2, and 1.3
    struct Version {
        octet    major;
        octet    minor;
    };

    #if MAX_GIOP_VERSION_NUMBER == 0
        // GIOP 1.0
        enum MsgType_1_0 { // Renamed from MsgType
            Request, Reply, CancelRequest,
            LocateRequest, LocateReply,
            CloseConnection, MessageError
        };

    #else
        // GIOP 1.1
        enum MsgType_1_1 {
            Request, Reply, CancelRequest,
            LocateRequest, LocateReply,
            CloseConnection, MessageError,
            Fragment // GIOP 1.1 addition
        };
    #endif // MAX_GIOP_VERSION_NUMBER

```

```

// GIOP 1.0
typedef char Magicn[4]
struct MessageHeader_1_0 { // Renamed from MessageHeader
    Magicn          magic;
    Version         GIOP_version;
    boolean         byte_order;
    octet           message_type;
    unsigned long   message_size;
};

// GIOP 1.1
struct MessageHeader_1_1 {
    Magicn          magic;
    Version         GIOP_version;
    octet           flags;           // GIOP 1.1 change
    octet           message_type;
    unsigned long   message_size;
};

// GIOP 1.2, 1.3
typedef MessageHeader_1_1 MessageHeader_1_2;
typedef MessageHeader_1_1 MessageHeader_1_3;
};

```

The message header clearly identifies GIOP messages and their byte-ordering. The header is independent of byte ordering except for the field encoding message size.

- **magic** identifies GIOP messages. The value of this member is always the four (upper case) characters “GIOP,” encoded in ISO Latin-1 (8859.1).
- **GIOP_version** contains the version number of the GIOP protocol being used in the message. The version number applies to the transport-independent elements of this specification (i.e., the CDR and message formats) that constitute the GIOP. This is not equivalent to the IIOP version number (as described in Object References on page 93) though it has the same structure. The major GIOP version number of this specification is one (1); the minor versions are zero (0), one (1), and two (2).

A server implementation supporting a minor GIOP protocol version 1.n (with $n > 0$ and $n < 3$), must also be able to process GIOP messages having minor protocol version 1.m, with m less than n. A GIOP server, which receives a request having a greater minor version number than it supports, should respond with an error message having the highest minor version number that that server supports, and then close the connection.

A client should not send a GIOP message having a higher minor version number than that published by the server in the tag Internet IIOP Profile body of an IOR.

- **byte_order** (in GIOP 1.0 only) indicates the byte ordering used in subsequent elements of the message (including **message_size**). A value of **FALSE** (0) indicates big-endian byte ordering, and **TRUE** (1) indicates little-endian byte ordering.
- **flags** (in GIOP 1.1, 1.2, and 1.3) is an 8-bit octet. The least significant bit indicates the byte ordering used in subsequent elements of the message (including **message_size**). A value of **FALSE** (0) indicates big-endian byte ordering, and **TRUE** (1) indicates little-endian byte ordering. The byte order for fragment messages must match the byte order of the initial message that the fragment extends.

The second least significant bit indicates whether or not more fragments follow. A value of **FALSE** (0) indicates this message is the last fragment, and **TRUE** (1) indicates more fragments follow this message.

The most significant 6 bits are reserved. These 6 bits must have value 0 for GIOP version 1.1, 1.2, and 1.3.

- **message_type** indicates the type of the message, according to Table 9.3; these correspond to enum values of type **MsgType**.
- **message_size** contains the number of octets in the message following the message header, encoded using the byte order specified in the byte order bit (the least significant bit) in the **flags** field (or using the **byte_order** field in GIOP 1.0). It refers to the size of the message body, not including the 12-byte message header. This count includes any alignment gaps and must match the size of the actual request parameters (plus any final padding bytes that may follow the parameters to have a fragment message terminate on an 8-byte boundary).

A **MARSHAL** exception with minor code 9 indicates that fewer bytes were present in a message than indicated by the count. (This condition can arise if the sender sends a message in fragments, and the receiver detects that the final fragment was received but contained insufficient data for all parameters to be unmarshaled.)

A **MARSHAL** exception with minor code 8 indicates that more bytes were present in a message than indicated by the count. Depending on the ORB implementation, this condition may be reported for the current message or the next message that is processed (when the receiver detects that the previous message is not immediately followed by the GIOP magic number).

The use of a message size of 0 with a **Request**, **LocateRequest**, **Reply**, or **LocateReply** message is reserved for future use.

For GIOP version 1.2, and 1.3, if the second least significant bit of **Flags** is 1, the sum of the **message_size** value and 12 must be evenly divisible by 8.

Messages with different GIOP minor versions may be mixed on the same underlying transport connection.

9.4.2 Request Message

Request messages encode CORBA object invocations, including attribute accessor operations, and **CORBA::Object** operations **get_interface**, **repository_id**, and **get_implementation**. Requests flow from client to server.

Request messages have three elements, encoded in this order:

- A GIOP message header
- A Request Header
- The Request Body

9.4.2.1 Request Header

The request header is specified as follows:

```

module GIOP { // IDL extended for version 1.1, 1.2, and 1.3

// GIOP 1.0
struct RequestHeader_1_0 { // Renamed from RequestHeader
    IOP::ServiceContextList    service_context;
    unsigned long               request_id;
    boolean                     response_expected;
    IOP::ObjectKey              object_key;
    string                      operation;
    CORBA::OctetSeq             requesting_principal;
};

typedef octet RequestReserved[3];
struct RequestHeader_1_1 {
    IOP::ServiceContextList    service_context;
    unsigned long               request_id;
    boolean                     response_expected;
    RequestReserved            reserved; // Added in GIOP 1.1
    IOP::ObjectKey              object_key;
    string                      operation;
    CORBA::OctetSeq             requesting_principal;
};

// GIOP 1.2, 1.3
typedef short                   AddressingDisposition;
const short                    KeyAddr = 0;
const short                    ProfileAddr = 1;
const short                    ReferenceAddr = 2;

struct IORAddressingInfo {
    unsigned long               selected_profile_index;
    IOP::IOR                    ior;
};

union TargetAddress switch (AddressingDisposition) {
    case KeyAddr:                IOP::ObjectKey object_key;
    case ProfileAddr:            IOP::TaggedProfile profile;
    case ReferenceAddr:          IORAddressingInfo ior;
};

struct RequestHeader_1_2 {
    unsigned long               request_id;
    octet                       response_flags;
    RequestReserved            reserved; // Added in GIOP 1.1
    TargetAddress               target;
    string                      operation;
    IOP::ServiceContextList    service_context;
    // requesting_principal not in GIOP 1.2 and 1.3
};
typedef RequestHeader_1_2 RequestHeader_1_3;
};

```

The members have the following definitions:

- **request_id** is used to associate reply messages with request messages (including **LocateRequest** messages). The client (requester) is responsible for generating values so that ambiguity is eliminated; specifically, a client must not re-use **request_id** values during a connection if:

(a) the previous request containing that ID is still pending, or

(b) if the previous request containing that ID was canceled and no reply was received. (See the semantics of the **CancelRequest** Message on page 102).

- **response_flags** is set to 0x0 for a **SyncScope** of **NONE** and **WITH_TRANSPORT**. The flag is set to 0x1 for a **SyncScope** of **WITH_SERVER**. A non exception reply to a request message containing a **response_flags** value of 0x1 should contain an empty body, i.e., the equivalent of a void operation with no out/inout parameters. The flag is set to 0x3 for a **SyncScope** of **WITH_TARGET**. These values ensure interworking compatibility between this and previous versions of **GIOP**.

For **GIOP 1.0** and **1.1** a **response_expected** value of **TRUE** is treated like a **response_flags** value of \x03, and a **response_expected** value of **FALSE** is treated like a **response_flags** value of \x00.

- **reserved** is always set to **0** in **GIOP 1.1**. These three octets are reserved for future use.
- For **GIOP 1.0** and **1.1**, **object_key** identifies the object that is the target of the invocation. It is the **object_key** field from the transport-specific **GIOP** profile (e.g., from the encapsulated **IOP** profile of the **IOR** for the target object). This value is only meaningful to the server and is not interpreted or modified by the client.
- For **GIOP 1.2**, **1.3**, **target** identifies the object that is the target of the invocation. The possible values of the union are:
 - **KeyAddr** is the **object_key** field from the transport-specific **GIOP** profile (e.g., from the encapsulated **IOP** profile of the **IOR** for the target object). This value is only meaningful to the server and is not interpreted or modified by the client.
 - **ProfileAddr** is the transport-specific **GIOP** profile selected for the target's **IOR** by the client **ORB**.
 - **IORAddressingInfo** is the full **IOR** of the target object. The **selected_profile_index** indicates the transport-specific **GIOP** profile that was selected by the client **ORB**. The first profile has an index of zero.
- **operation** is the **IDL** identifier naming, within the context of the interface (not a fully qualified scoped name), the operation being invoked. In the case of attribute accessors, the names are **_get_<attribute>** and **_set_<attribute>**. The case of the operation or attribute name must match the case of the operation name specified in the **OMG IDL** source for the interface being used.

In the case of **CORBA::Object** operations that are defined in the *ORB Interface* clause, **CORBA**, Part 1 and that correspond to **GIOP** request messages, the operation names are **_interface**, **_is_a**, **_non_existent**, **_domain_managers**, **_component**, and **_repository_id**.

NOTE: The name **_get_domain_managers** is not used, to avoid conflict with a get operation invoked on a user defined attribute with name **domain_managers**.

For **GIOP 1.2** and later versions, only the operation name **_non_existent** shall be used.

The correct operation name to use for **GIOP 1.0** and **1.1** is **_non_existent**. Due to a typographical error in **CORBA 2.0**, **2.1**, and **2.2**, some legacy implementations of **GIOP 1.0** and **1.1** respond to the operation name **_not_existent**. For maximum interoperability with such legacy implementations, new implementations of **GIOP 1.0** and **1.1** may wish to respond to both operation names, **_non_existent** and **_not_existent**.

- **service_context** contains ORB service data being passed from the client to the server, encoded as described in Service Context on page 38.
- **requesting_principal** contains a value identifying the requesting principal. It is provided to support the **BOA::get_principal** operation. The usage of the **requesting_principal** field is deprecated for GIOP versions 1.0 and 1.1. The field is not present in the request header for GIOP version 1.2 and 1.3.

There is no padding after the request header when an unfragmented request message body is empty.

9.4.2.2 Request Body

In GIOP versions 1.0 and 1.1, request bodies are marshaled into the CDR encapsulation of the containing Message immediately following the Request Header. In GIOP version 1.2 and 1.3, the Request Body is always aligned on an 8-octet boundary. The fact that GIOP specifies the maximum alignment for any primitive type is 8 guarantees that the Request Body will not require remarshaling if the Message or Request header are modified. The data for the request body includes the following items encoded in this order:

- All **in** and **inout** parameters, in the order in which they are specified in the operation's OMG IDL definition, from left to right.
- An optional **Context** pseudo object, encoded as described in Context on page 92. This item is included only if the operation's OMG IDL definition includes a context expression, and only includes context members as defined in that expression.

For example, the request body for the following OMG IDL operation:

```
double example (in short m, out string str, inout long p);
```

would be equivalent to this structure:

```
struct example_body {
    short m; // leftmost in or inout parameter
    long p; // ... to the rightmost
};
```

9.4.3 Reply Message

Reply messages are sent in response to **Request** messages if and only if the response expected flag in the request is set to **TRUE**. Replies include inout and out parameters, operation results, and may include exception values. In addition, Reply messages may provide object location information. In GIOP versions 1.0 and 1.1, replies flow only from server to client.

Reply messages have three elements, encoded in this order:

- A GIOP message header
- A ReplyHeader structure
- The reply body

9.4.3.1 Reply Header

The reply header is defined as follows:

```

module GIOP {                                     // IDL extended for 1.2 and 1.3

#if MAX_GIOP_MINOR_VERSION < 2

    // GIOP 1.0 and 1.1
    enum ReplyStatusType_1_0 { // Renamed from ReplyStatusType
        NO_EXCEPTION,
        USER_EXCEPTION,
        SYSTEM_EXCEPTION,
        LOCATION_FORWARD
    };

    // GIOP 1.0
    struct ReplyHeader_1_0 { // Renamed from ReplyHeader
        IOP::ServiceContextList    service_context;
        unsigned long               request_id;
        ReplyStatusType_1_0        reply_status;
    };

    // GIOP 1.1
    typedef ReplyHeader_1_0 ReplyHeader_1_1;
    // Same Header contents for 1.0 and 1.1

#endif // MAX_GIOP_VERSION_NUMBER

#if MAX_GIOP_MINOR_VERSION >= 2

    // GIOP 1.2, 1.3
    enum ReplyStatusType_1_2 {
        NO_EXCEPTION,
        USER_EXCEPTION,
        SYSTEM_EXCEPTION,
        LOCATION_FORWARD,
        LOCATION_FORWARD_PERM, // new value for 1.2
        NEEDS_ADDRESSING_MODE // new value for 1.2
    };

    struct ReplyHeader_1_2 {
        unsigned long               request_id;
        ReplyStatusType_1_2        reply_status;
        IOP::ServiceContextList    service_context;
    };
    typedef ReplyHeader_1_2 ReplyHeader_1_3;
#endif // MAX_GIOP_VERSION_NUMBER

};

```

The members have the following definitions:

- **request_id** is used to associate replies with requests. It contains the same **request_id** value as the corresponding request.

- **reply_status** indicates the completion status of the associated request, and also determines part of the reply body contents. If no exception occurred and the operation completed successfully, the value is `NO_EXCEPTION` and the body contains return values. Otherwise the body
 - contains an exception, or
 - directs the client to reissue the request to an object at some other location, or
 - directs the client to supply more addressing information.
- **service_context** contains ORB service data being passed from the server to the client, encoded as described in GIOP Message Transfer on page 71.

There is no padding after the reply header when an unfragmented reply message body is empty.

9.4.3.2 Reply Body

In GIOP version 1.0 and 1.1, reply bodies are marshaled into the CDR encapsulation of the containing Message immediately following the Reply Header. In GIOP version 1.2 and 1.3, the Reply Body is always aligned on an 8-octet boundary. The fact that GIOP specifies the maximum alignment for any primitive type is 8 guarantees that the ReplyBody will not require remarshaling if the Message or the Reply Header are modified. The data for the reply body is determined by the value of **reply_status**. There are the following types of reply body:

- If the **reply_status** value is `NO_EXCEPTION`, the body is encoded as if it were a structure holding first any operation return value, then any **inout** and **out** parameters in the order in which they appear in the operation’s OMG IDL definition, from left to right. (That structure could be empty.)
- If the **reply_status** value is `USER_EXCEPTION` or `SYSTEM_EXCEPTION`, then the body contains the exception that was raised by the operation, encoded as described in Exception on page 92. (Only the user-defined exceptions listed in the operation’s OMG IDL definition may be raised.)

When a GIOP Reply message contains a **reply_status** value of `SYSTEM_EXCEPTION`, the body of the Reply message conforms to the following structure:

```

module GIOP { // IDL
  struct SystemExceptionReplyBody {
    string          exception_id;
    unsigned long  minor_code_value;
    unsigned long  completion_status;
  };
};

```

The high-order 20 bits of **minor_code_value** contain a 20-bit “Vendor Minor Codeset ID” (**VMCID**); the low-order 12 bits contain a minor code. A vendor (or group of vendors) wishing to define a specific set of system exception minor codes should obtain a unique **VMCID** from the OMG, and then use those 4096 minor codes as they see fit; for example, defining up to 4096 minor codes for each system exception. Any vendor may use the special **VMCID** of zero (0) without previous reservation, but minor code assignments in this codeset may conflict with other vendor’s assignments, and use of the zero **VMCID** is officially deprecated.

NOTE: OMG standard minor codes are identified with the 20 bit **VMCID** `\x4f4d0`. This appears as the characters ‘O’ followed by the character ‘M’ on the wire, which is defined as a 32-bit constant called **OMGVMCID** `\x4f4d0000` (see the *ORB Interface* clause, CORBA, Part 1) so that allocated minor code numbers can be or-ed with it to obtain the **minor_code_value**.

- If the **reply_status** value is **LOCATION_FORWARD**, then the body contains an object reference (IOR) encoded as described in Object References on page 93. The client ORB is responsible for re-sending the original request to that (different) object. This resending is transparent to the client program making the request.
- The usage of the **reply_status** value **LOCATION_FORWARD_PERM** behaves like the usage of **LOCATION_FORWARD**, but when used by a server it also provides an indication to the client that it may replace the old IOR with the new IOR. Both the old IOR and the new IOR are valid, but the new IOR is preferred for future use.
- If the **reply_status** value is **NEEDS_ADDRESSING_MODE**, then the body contains a **GIOP::AddressingDisposition**. The client ORB is responsible for re-sending the original request using the requested addressing mode. The resending is transparent to the client program making the request.

NOTE: Usage of **LOCATATION_FORWARD_PERM** is now deprecated, due to problems it causes with the semantics of the **Object::hash()** operation. **LOCATATION_FORWARD_PERM** features could be removed from some future GIOP versions if solutions to these problems are not provided.

For example, the reply body for a successful response (the value of **reply_status** is **NO_EXCEPTION**) to the *Request* example shown on page 99 would be equivalent to the following structure:

```
struct example_reply {
    double    return_value;    // return value
    string    str;
    long      p;               // ... to the rightmost
};
```

Note that the **object_key** field in any specific GIOP profile is server-relative, not absolute. Specifically, when a new object reference is received in a **LOCATION_FORWARD Reply** or in a **LocateReply** message, the **object_key** field embedded in the new object reference's GIOP profile may not have the same value as the **object_key** in the GIOP profile of the original object reference. For details on location forwarding, see Object Location on page 110.

9.4.4 CancelRequest Message

CancelRequest messages may be sent, in GIOP versions 1.0 and 1.1, only from clients to servers. **CancelRequest** messages notify a server that the client is no longer expecting a reply for a specified pending **Request** or **LocateRequest** message.

CancelRequest messages have two elements, encoded in this order:

- A GIOP message header
- A **CancelRequestHeader**

9.4.4.1 Cancel Request Header

The cancel request header is defined as follows:

```
module GIOP {
    // IDL
    struct CancelRequestHeader {
        unsigned long    request_id;
    };
};
```

The **request_id** member identifies the **Request** or **LocateRequest** message to which the cancel applies. This value is the same as the **request_id** value specified in the original **Request** or **LocateRequest** message.

When a client issues a cancel request message, it serves in an advisory capacity only. The server is not required to acknowledge the cancellation, and may subsequently send the corresponding reply. The client should have no expectation about whether a reply (including an exceptional one) arrives.

9.4.5 LocateRequest Message

LocateRequest messages may be sent from a client to a server to determine the following regarding a specified object reference:

- whether the current server is capable of directly receiving requests for the object reference, and if not,
- to what address requests for the object reference should be sent.

Note that this information is also provided through the **Request** message, but that some clients might prefer not to support retransmission of potentially large messages that might be implied by a **LOCATION_FORWARD** status in a **Reply** message. That is, client use of this represents a potential optimization.

LocateRequest messages have two elements, encoded in this order:

- A GIOP message header
- A **LocateRequestHeader**

9.4.5.1 LocateRequest Header

The **LocateRequest** header is defined as follows:

```
module GIOP {                                // IDL extended for version 1.2 and 1.3

// GIOP 1.0
    struct LocateRequestHeader_1_0 {
        // Renamed LocationRequestHeader
        unsigned long    request_id;
        IOP::ObjectKey   object_key;
    };

// GIOP 1.1
    typedef LocateRequestHeader_1_0 LocateRequestHeader_1_1;
    // Same Header contents for 1.0 and 1.1

// GIOP 1.2, 1.3
    struct LocateRequestHeader_1_2 {
        unsigned long    request_id;
        TargetAddress     target;
    };
    typedef LocateRequestHeader_1_2 LocateRequestHeader_1_3;
};
```

The members are defined as follows:

- **request_id** is used to associate **LocateReply** messages with **LocateRequest** ones. The client (requester) is responsible for generating values; see Request Message on page 96 for the applicable rules.
- For GIOP 1.0 and 1.1, **object_key** identifies the object being located. In an IOP context, this value is obtained from the **object_key** field from the encapsulated **IOP::ProfileBody** in the IOP profile of the IOR for the target object. When GIOP is mapped to other transports, their IOR profiles must also contain an appropriate corresponding value. This value is only meaningful to the server and is not interpreted or modified by the client.
- For GIOP 1.2, 1.3, target identifies the object being located. The possible values of this union are:
 - **KeyAddr** is the **object_key** field from the transport-specific GIOP profile (e.g., from the encapsulated IOP profile of the IOR for the target object). This value is only meaningful to the server and is not interpreted or modified by the client.
 - **ProfileAddr** is the transport-specific GIOP profile selected for the target's IOR by the client ORB.
 - **IORAddressingInfo** is the full IOR of the target object. The **selected_profile_index** indicates the transport-specific GIOP profile that was selected by the client ORB.

See Object Location on page 110 for details on the use of **LocateRequest**.

9.4.6 LocateReply Message

LocateReply messages are sent from servers to clients in response to **LocateRequest** messages. In GIOP versions 1.0 and 1.1 the **LocateReply** message is only sent from the server to the client.

A **LocateReply** message has three elements, encoded in this order:

1. A GIOP message header
2. A **LocateReplyHeader**
3. The locate reply body

9.4.6.1 Locate Reply Header

The locate reply header is defined as follows:

```

module GIOP {
    // IDL extended for GIOP 1.2 and 1.3
    #if MAX_GIOP_MINOR_VERSION < 2
        // GIOP 1.0 and 1.1
        enum LocateStatusType_1_0 { // Renamed from LocateStatusType
            UNKNOWN_OBJECT,
            OBJECT_HERE,
            OBJECT_FORWARD
        };

        // GIOP 1.0
        struct LocateReplyHeader_1_0 { // Renamed from LocateReplyHeader
            unsigned long request_id;
            LocateStatusType_1_0 locate_status;
        };
    #endif
}

```

```

// GIOP 1.1
typedef LocateReplyHeader_1_0 LocateReplyHeader_1_1;
// same Header contents for 1.0 and 1.1

#else
// GIOP 1.2, 1.3
enum LocateStatusType_1_2 {
    UNKNOWN_OBJECT,
    OBJECT_HERE,
    OBJECT_FORWARD,
    OBJECT_FORWARD_PERM,           // new value for GIOP 1.2
    LOC_SYSTEM_EXCEPTION,         // new value for GIOP 1.2
    LOC_NEEDS_ADDRESSING_MODE     // new value for GIOP 1.2
};

struct LocateReplyHeader_1_2 {
    unsigned long    request_id;
    LocateStatusType_1_2 locate_status;
};
typedef LocateReplyHeader_1_2 LocateReplyHeader_1_3;
#endif // MAX_GIOP_VERSION_NUMBER
};

```

The members have the following definitions:

- **request_id** - is used to associate replies with requests. This member contains the same **request_id** value as the corresponding **LocateRequest** message.
- **locate_status** - the value of this member is used to determine whether a **LocateReply** body exists. Values are:
 - **UNKNOWN_OBJECT** - the object specified in the corresponding **LocateRequest** message is unknown to the server; no body exists.
 - **OBJECT_HERE** - this server (the originator of the **LocateReply** message) can directly receive requests for the specified object; no body exists.
 - **OBJECT_FORWARD** and **OBJECT_FORWARD_PERM** - a **LocateReply** body exists.
 - **LOC_SYSTEM_EXCEPTION** - a **LocateReply** body exists.
 - **LOC_NEEDS_ADDRESSING_MODE** - a **LocateReply** body exists.

9.4.6.2 LocateReply Body

The body is empty, except for the following cases:

- If the **LocateStatus** value is **OBJECT_FORWARD** or **OBJECT_FORWARD_PERM**, the body contains an object reference (IOR) that may be used as the target for requests to the object specified in the **LocateRequest** message. The usage of **OBJECT_FORWARD_PERM** behaves like the usage of **OBJECT_FORWARD**, but when used by the server it also provides an indication to the client that it may replace the old IOR with the new IOR. When using **OBJECT_FORWARD_PERM**, both the old IOR and the new IOR are valid, but the new IOR is preferred for future use.
- If the **LocateStatus** value is **LOC_SYSTEM_EXCEPTION**, the body contains a marshaled **GIOP::SystemExceptionReplyBody**.

- If the **LocateStatus** value is **LOC_NEEDS_ADDRESSING_MODE**, then the body contains a **GIOP::AddressingDisposition**. The client ORB is responsible for re-sending the **LocateRequest** using the requested addressing mode.

NOTE: Usage of **OBJECT_FORWARD_PERM** is now deprecated, due to problems it causes with the semantics of the **Object::hash** operation. **OBJECT_FORWARD_PERM** features could be removed from some future GIOP versions if solutions to these problems are not provided.

LocateReply bodies are marshaled immediately following the **LocateReply** header.

9.4.6.3 Handling ForwardRequest Exception from ServantLocator

If the **ServantLocator** in a POA raises a **ForwardRequest** exception the ORB shall send a **LocateReply** message to the client with **locate_status** set to **OBJECT_FORWARD**, and with the body containing the object reference from the **ForwardRequest** exception's **forward_reference** field.

9.4.7 CloseConnection Message

CloseConnection messages are sent only by servers in GIOP protocol versions 1.0 and 1.1. They inform clients that the server intends to close the connection and must not be expected to provide further responses. Moreover, clients know that any requests for which they are awaiting replies will never be processed, and may safely be reissued (on another connection). In GIOP version 1.2 or later both sides of the connection may send the **CloseConnection** message.

The **CloseConnection** message consists only of the GIOP message header, identifying the message type.

For details on the usage of **CloseConnection** messages, see Connection Management on page 108.

9.4.8 MessageError Message

The **MessageError** message is sent in response to any GIOP message whose version number or message type is unknown to the recipient or any message received whose header is not properly formed (e.g., has the wrong magic value). Error handling is context-specific.

The **MessageError** message consists only of the GIOP message header, identifying the message type.

9.4.9 Fragment Message

This message is added in GIOP 1.1.

The **Fragment** message is sent following a previous request or response message that has the more fragments bit set to **TRUE** in the **flags** field.

All of the GIOP messages begin with a GIOP header. One of the fields of this header is the **message_size** field, a 32-bit unsigned number giving the number of bytes in the message following the header. Unfortunately, when actually constructing a GIOP **Request** or **Reply** message, it is sometimes impractical or undesirable to ascertain the total size of the message at the stage of message construction where the message header has to be written. GIOP 1.1 provides an alternative indication of the size of the message, for use in those cases.

In GIOP 1.1, a **Request** or **Reply** message can be broken into multiple fragments. In GIOP 1.2 and later, a **Request**, **Reply**, **LocateRequest**, or **LocateReply** message can be broken into multiple fragments. The first fragment is a regular message (e.g., **Request** or **Reply**) with the **more** fragments bit in the **flags** field set to **TRUE**. This initial fragment can be followed by one or more messages using the fragment messages. The last fragment shall have the **more** fragment bit in the flag field set to **FALSE**.

A **CancelRequest** message may be sent by the client before the final fragment of the message being sent. In this case, the server should assume no more fragments will follow.

NOTE: A GIOP client that fragments the header of a **Request** message before sending the request ID may not send a **CancelRequest** message pertaining to that request ID and may not send another **Request** message until after the request ID is sent.

A primitive data type of 8 bytes or smaller should never be broken across two fragments.

In GIOP 1.1, the data in a fragment is marshaled with alignment relative to its position in the fragment, not relative to its position in the whole unfragmented message.

For GIOP version 1.2 and later, the total length (including the message header) of a fragment other than the final fragment of a fragmented message are required to be a multiple of 8 bytes in length, allowing bridges to defragment and/or refragment messages without having to remarshal the encoded data to insert or remove padding.

For GIOP version 1.2 and later, a fragment header is included in the message, immediately after the GIOP message header and before the fragment data. The request ID, in the fragment header, has the same value as that used in the original message associated with the fragment.

The byte order and GIOP protocol version of a fragment shall be the same as that of the message it continues.

module GIOP {**//IDL extension for GIOP 1.2 and later**

```
    struct FragmentHeader_1_2 {
        unsigned long request_id;
    };
    typedef FragmentHeader_1_2 FragmentHeader_1_3;
};
```

9.5 GIOP Message Transport

The GIOP is designed to be implementable on a wide range of transport protocols. The GIOP definition makes the following assumptions regarding transport behavior:

- The transport is connection-oriented. GIOP uses connections to define the scope and extent of request IDs.
- The transport is reliable. Specifically, the transport guarantees that bytes are delivered in the order they are sent, at most once, and that some positive acknowledgment of delivery is available.
- The transport can be viewed as a byte stream. No arbitrary message size limitations, fragmentation, or alignments are enforced.
- The transport provides some reasonable notification of disorderly connection loss. If the peer process aborts, the peer host crashes, or network connectivity is lost, a connection owner should receive some notification of this condition.

- The transport's model for initiating connections can be mapped onto the general connection model of TCP/IP. Specifically, an agent (described herein as a server) publishes a known network address in an IOR, which is used by the client when initiating a connection.

The server does not actively initiate connections, but is prepared to accept requests to connect (i.e., it *listens* for connections in TCP/IP terms). Another agent that knows the address (called a client) can attempt to initiate connections by sending *connect* requests to the address. The listening server may *accept* the request, forming a new, unique connection with the client, or it may *reject* the request (e.g., due to lack of resources). Once a connection is open, either side may *close* the connection. (See Connection Management on page 108 for semantic issues related to connection closure.) A candidate transport might not directly support this specific connection model; it is only necessary that the transport's model can be mapped onto this view.

9.5.1 Connection Management

For the purposes of this discussion, the roles client and server are defined as follows:

- A client initiates the connection, presumably using addressing information found in an object reference (IOR) for an object to which it intends to send requests.
- A server accepts connections, but does not initiate them.

These terms only denote roles with respect to a connection. They do not have any implications for ORB or application architectures.

In GIOP protocol versions 1.0 and 1.1, connections are not symmetrical. Only clients can send **Request**, **LocateRequest**, and **CancelRequest** messages over a connection, in GIOP 1.0 and 1.1. In all GIOP versions, a server can send **Reply**, **LocateReply**, and **CloseConnection** messages over a connection; however, in GIOP 1.2 and later the client can send them as well. Either client or server can send **MessageError** messages, in GIOP 1.0 and 1.1.

If multiple GIOP versions are used on an underlying transport connection, the highest GIOP version used on the connection can be used for handling the close. A **CloseConnection** message sent using any GIOP version applies to all GIOP versions used on the connection (i.e., the underlying transport connection is closed for all GIOP versions). In particular, if GIOP version 1.2 or higher has been used on the connection, the client can send the **CloseConnection** message by using the highest GIOP version in use.

Only GIOP messages are sent over GIOP connections.

Request IDs must unambiguously associate replies with requests within the scope and lifetime of a connection. Request IDs may be re-used if there is no possibility that the previous request using the ID may still have a pending reply. Note that cancellation does not guarantee no reply will be sent. It is the responsibility of the client to generate and assign request IDs. Request IDs must be unique among both **Request** and **LocateRequest** messages.

9.5.1.1 Connection Closure

Connections can be closed in two ways: orderly shutdown, or abortive disconnect.

For GIOP versions 1.0, and 1.1:

- Orderly shutdown is initiated by servers sending a **CloseConnection** message, or by clients just closing down a connection.
- Orderly shutdown may be initiated by the client at any time.

- A server may not initiate shutdown if it has begun processing any requests for which it has not either received a **CancelRequest** or sent a corresponding reply.
- If a client detects connection closure without receiving a **CloseConnection** message, it must assume an abortive disconnect has occurred, and treat the condition as an error.

For GIOP Version 1.2 and later:

- Orderly shutdown is initiated by either the originating client ORB (connection initiator) or by the server ORB (connection responder) sending a **CloseConnection** message
- If the ORB sending the **CloseConnection** is a server, or bidirectional GIOP is in use, the sending ORB must not currently be processing any Requests from the other side.
- The ORB that sends the **CloseConnection** must not send any messages after the **CloseConnection**.
- If either ORB detects connection closure without receiving a **CloseConnection** message, it must assume an abortive disconnect has occurred, and treat the condition as an error.
- If bidirectional GIOP is in use, the conditions of Bi-Directional GIOP on page 115 apply.

For all uses of **CloseConnection** (for GIOP versions 1.0, 1.1, 1.2, and later):

- If there are any pending non-oneway requests, which were initiated on a connection by the ORB shutting down that connection, the connection-peer ORB should consider them as canceled.
- If an ORB receives a **CloseConnection** message from its connection-peer ORB, it should assume that any outstanding messages (i.e., without replies) were received after the connection-peer ORB sent the **CloseConnection** message, were not processed, and may be safely re-sent on a new connection.
- After issuing a **CloseConnection** message, the issuing ORB may close the connection. Some transport protocols (not including TCP) do not provide an “orderly disconnect” capability, guaranteeing reliable delivery of the last message sent. When GIOP is used with such protocols, an additional handshake needs to be provided as part of the mapping to that protocol’s connection mechanisms, to guarantee that both ends of the connection understand the disposition of any outstanding GIOP requests.

9.5.1.2 Multiplexing Connections

A client, if it chooses, may send requests to multiple target objects over the same connection, provided that the connection’s server side is capable of responding to requests for the objects. It is the responsibility of the client to optimize resource usage by reusing connections, if it wishes. If not, the client may open a new connection for each active object supported by the server, although this behavior should be avoided.

9.5.2 Message Ordering

Only the client (connection originator) may send **Request**, **LocateRequest**, and **CancelRequest** messages, if Bi-Directional GIOP is not in use.

Clients may have multiple pending requests. A client need not wait for a reply from a previous request before sending another request.

Servers may reply to pending requests in any order. **Reply** messages are not required to be in the same order as the corresponding **Requests**.

The ordering restrictions regarding connection closure mentioned in Connection Management, above, are also noted here. Servers may only issue **CloseConnection** messages when **Reply** messages have been sent in response to all received **Request** messages that require replies.

9.6 Object Location

The GIOP is defined to support object migration and location services without dictating the existence of specific ORB architectures or features. The protocol features are based on the following observations.

A given transport address does not necessarily correspond to any specific ORB architectural component (such as an *object adapter*, *object server process*, *Inter-ORB bridge*, and so forth). It merely implies the existence of some agent with which a connection may be opened, and to which requests may be sent.

The “agent” (owner of the server side of a connection) may have one of the following roles with respect to a particular object reference:

- The agent may be able to accept object requests directly for the object and return replies. The agent may or may not own the actual object implementation; it may be an Inter-ORB bridge that transforms the request and passes it on to another process or ORB. From GIOP’s perspective, it is only important that requests can be sent directly to the agent.
- The agent may not be able to accept direct requests for any objects, but acts instead as a location service. Any **Request** messages sent to the agent would result in either exceptions or replies with **LOCATION_FORWARD** status, providing new addresses to which requests may be sent. Such agents would also respond to **LocateRequest** messages with appropriate **LocateReply** messages.
- The agent may directly respond to some requests (for certain objects) and provide forwarding locations for other objects.
- The agent may directly respond to requests for a particular object at one point in time, and provide a forwarding location at a later time (perhaps during the same connection).

Agents are not required to implement location forwarding mechanisms. An agent can be implemented with the policy that a connection either supports direct access to an object, or returns exceptions. Such an ORB (or inter-ORB bridge) always returns **LocateReply** messages with either **OBJECT_HERE** or **UNKNOWN_OBJECT** status, and never **OBJECT_FORWARD** status.

Clients must, however, be able to accept and process **Reply** messages with **LOCATION_FORWARD** status, since any ORB may choose to implement a location service. Whether a client chooses to send **LocateRequest** messages is at the discretion of the client. For example, if the client routinely expected to see **LOCATION_FORWARD** replies when using the address in an object reference, it might always send **LocateRequest** messages to objects for which it has no recorded forwarding address. If a client sends **LocateRequest** messages, it should be prepared to accept **LocateReply** messages.

A client shall not make any assumptions about the longevity of object addresses returned by **LOCATION_FORWARD (OBJECT_FORWARD)** mechanisms. Once a connection based on location-forwarding information is closed, a client can attempt to reuse the forwarding information it has, but, if that fails, it shall restart the location process using the original address specified in the initial object reference.

For GIOP version 1.2 and later, the usage of **LOCATION_FORWARD_PERM (OBJECT_FORWARD_PERM)** behaves like the usage of **LOCATION_FORWARD (OBJECT_FORWARD)**, but when used by the server it also provides an indication to the client that it may replace the old IOR with the new IOR. When using **LOCATION_FORWARD_PERM (OBJECT_FORWARD_PERM)**, both the old IOR and the new **IOR** are valid, but the new IOR is preferred for future use.

NOTE: Usage of **LOCATION_FORWARD_PERM** and **OBJECT_FORWARD_PERM** is now deprecated, due to problems it causes with the semantics of the **Object::hash** operation. **LOCATION_FORWARD_PERM** and **OBJECT_FORWARD_PERM** features could be removed from some future GIOP versions if solutions to these problems are not provided.

Even after performing successful invocations using an address, a client should be prepared to be forwarded. The only object address that a client should expect to continue working reliably is the one in the initial object reference. If an invocation using that address returns **UNKNOWN_OBJECT**, the object should be deemed non-existent.

In general, the implementation of location forwarding mechanisms is at the discretion of ORBs, available to be used for optimization and to support flexible object location and migration behaviors.

9.7 Internet Inter-ORB Protocol (IIOP)

The baseline transport specified for GIOP is TCP/IP⁵. Specific APIs for libraries supporting TCP/IP may vary, so this discussion is limited to an abstract view of TCP/IP and management of its connections. The mapping of GIOP message transfer to TCP/IP connections is called the Internet Inter-ORB Protocol (IIOP).

IIOP 1.0 is based on GIOP 1.0.

IIOP 1.1 can be based on either GIOP 1.0 or 1.1. An IIOP 1.1 client must support GIOP 1.1, and may also support GIOP 1.0. An IIOP 1.1 server must support processing both GIOP 1.0 and GIOP 1.1 messages.

IIOP 1.2 can be based on any of the GIOP minor versions 1.0, 1.1, or 1.2. An IIOP 1.2 client must support GIOP 1.2, and may also support lesser GIOP minor versions. An IIOP 1.2 server must also support processing messages with all lesser GIOP versions.

IIOP 1.3 can be based on any of the GIOP minor versions 1.0, 1.1, 1.2, or 1.3. An IIOP 1.3 client must support GIOP 1.3, and may also support lesser GIOP minor versions. An IIOP 1.3 server must also support processing messages with all lesser GIOP versions.

IIOP 1.4 can be based on any of the GIOP minor versions 1.0, 1.1, 1.2, 1.3, or 1.4. An IIOP 1.4 client must support GIOP 1.4, and may also support lesser GIOP minor versions. An IIOP 1.4 server must also support processing messages with all lesser GIOP versions.

Conformance to IIOP versions 1.1, 1.2, 1.3, and 1.4 requires support of Limited-Profile IOR conformance (see Interoperable Object References: IORs on page 25), specifically for the IIOP IOR Profile. As of CORBA 2.4, this limited IOR conformance is deprecated, and ORBs implementing IIOP are strongly recommended to support Full IOR conformance. Some future IIOP versions could require support of Full IOR conformance.

9.7.1 TCP/IP Connection Usage

Agents that are capable of accepting object requests or providing locations for objects (i.e., servers) publish TCP/IP addresses in IORs, as described in IIOP IOR Profiles on page 112. A TCP/IP address consists of an IP host address, typically represented by a host name, and a TCP port number. Servers must listen for connection requests.

A client needing an object's services must initiate a connection with the address specified in the IOR, with a connect request.

5. Postel, J., "Transmission Control Protocol – DARPA Internet Program Protocol Specification," RFC-793, Information Sciences Institute, September 1981

The listening server may accept or reject the connection. In general, servers should accept connection requests if possible, but ORBs are free to establish any desired policy for connection acceptance (e.g., to enforce fairness or optimize resource usage).

Once a connection is accepted, the client may send **Request**, **LocateRequest**, or **CancelRequest** messages by writing to the TCP/IP socket it owns for the connection. The server may send **Reply**, **LocateReply**, and **CloseConnection** messages by writing to its TCP/IP connection. In GIOP 1.2, and later, the client may send the **CloseConnection** message, and if BiDirectional GIOP is in use, the client may also send **Reply and LocateReply messages**.

After receiving a **CloseConnection** message, an ORB must close the TCP/IP connection. After sending a **CloseConnection**, an ORB may close the TCP/IP connection immediately, or may delay closing the connection until it receives an indication that the other side has closed the connection. For maximum interoperability with ORBs using TCP implementations that do not properly implement orderly shutdown, an ORB may wish to only shutdown the sending side of the connection, and then read any incoming data until it receives an indication that the other side has also shutdown, at which point the TCP connection can be closed completely.

Given TCP/IP's flow control mechanism, it is possible to create deadlock situations between clients and servers if both sides of a connection send large amounts of data on a connection (or two different connections between the same processes) and do not read incoming data. Both processes may block on write operations, and never resume. It is the responsibility of both clients and servers to avoid creating deadlock by reading incoming messages and avoiding blocking when writing messages, by providing separate threads for reading and writing, or any other workable approach. ORBs are free to adopt any desired implementation strategy, but should provide robust behavior.

9.7.2 IIOP IOR Profiles

IIOP profiles, identifying individual objects accessible through the Internet Inter-ORB Protocol, have the following form:

```
module IIOP { // IDL extended for version 1.1, 1.2, and later
    struct Version {
        octet    major;
        octet    minor;
    };

    struct ProfileBody_1_0 { // renamed from ProfileBody
        Version    iiop_version;
        string     host;
        unsigned short port;
        IOP::ObjectKey object_key;
    };

    struct ProfileBody_1_1 { // also used for 1.2 and later
        Version    iiop_version;
        string     host;
        unsigned short port;
        IOP::ObjectKey object_key;
    };
};
```

```

// Added in 1.1 unchanged for 1.2 and later
IOP::TaggedComponentSeq components;
};
};

```

IOP Profile version number:

- Indicates the IOP protocol version.
- Major number can stay the same if the new changes are backward compatible.
- Clients with lower minor version can attempt to invoke objects with higher minor version number by using only the information defined in the lower minor version protocol (ignore the extra information).

Profiles supporting only IOP version 1.0 use the **ProfileBody_1_0** structure, while those supporting IOP version 1.1 or 1.2 or later use the **ProfileBody_1_1** structure. An instance of one of these structure types is marshaled into an encapsulation octet stream. This encapsulation (a **sequence <octet>**) becomes the **profile_data** member of the **IOP::TaggedProfile** structure representing the IOP profile in an IOR, and the tag has the value **TAG_INTERNET_IOP** (as defined earlier).

The version number published in the Tag Internet IOP Profile body signals the highest GIOP minor version number that the server supports at the time of publication of the IOR.

If the major revision number is 1, and the minor revision number is greater than 0, then the length of the encapsulated profile may exceed the total size of components defined in this specification for profiles with minor revision number 0. ORBs that support only revision 1.0 IOP profiles must ignore any data in the profile that occurs after the **object_key**. If the revision of the profile is 1.0, there shall be no extra data in the profile (i.e., the length of the encapsulated profile must agree with the total size of components defined for version 1.0).

For Version 1.2 and later of IOP, no order of use is prescribed in the case where more than one TAG Internet IOP Profile is present in an IOR.

The members of **IOP::ProfileBody_1_0** and **IOP::ProfileBody_1_1** are defined as follows:

- **iiop_version** describes the version of IOP that the agent at the specified address is prepared to receive. When an agent generates IOP profiles specifying a particular version, it must be able to accept messages complying with the specified version or any previous minor version (i.e., any smaller version number). The major version number of this specification is 1; the minor versions defined to date are 0, 1, and 2. Compliant ORBs must generate version 1.1 profiles, and must accept any profile with a major version of 1, regardless of the minor version number. If the minor version number is 0, the encapsulation is fully described by the **ProfileBody_1_0** structure. If the minor version number is 1 or 2, the encapsulation is fully described by the **ProfileBody_1_1** structure. If the minor version number is greater than 2, then the length of the encapsulated profile may exceed the total size of components defined in this specification for profiles with minor version number 1 or 2. ORBs that support only version 1.1 or 1.2 IOP profiles must ignore, but preserve, any data in the profile that occurs after the **components** member, for IOP profiles with minor version greater than 1.2.

NOTE: As of version 1.2 of GIOP and IOP and minor versions beyond, the minor version in the **TAG_INTERNET_IOP** profile signals the highest minor revision of GIOP supported by the server at the time of publication of the IOR.

- **host** identifies the Internet host to which GIOP messages for the specified object may be sent. In order to promote a very large (Internet-wide) scope for the object reference, this will typically be the fully qualified domain name of the host, rather than an unqualified (or partially qualified) name. However, per Internet standards, the host string may also contain a host address expressed in standard “dotted decimal” form (e.g., “192.231.79.52”).

- **port** contains the TCP/IP port number (at the specified host) where the target agent is listening for connection requests. The agent must be ready to process IOP messages on connections accepted at this port.
- **object_key** is an opaque value supplied by the agent producing the IOR. This value will be used in request messages to identify the object to which the request is directed. An agent that generates an object key value must be able to map the value unambiguously onto the corresponding object when routing requests internally.
- **components** is a sequence of **TaggedComponent**, which contains additional information that may be used in making invocations on the object described by this profile. **TaggedComponents** that apply to IOP 1.2 are described below in IOP IOR Profile Components on page 114. Other components may be included to support enhanced versions of IOP, to support ORB services such as security, and to support other GIOPs, ESIOPs, and proprietary protocols. If an implementation puts a non-standard component in an IOR, it cannot be assured that any or all non-standard components will remain in the IOR.

The relationship between the IOP protocol version and component support conformance requirements is as follows:

- Each IOP version specifies a set of standard components and the conformance rules for that version. These rules specify which components are mandatory and which are optional. A conformant implementation has to conform to these rules, and is not required to conform to more than these rules.
- New components can be added, but they do not become part of the versions conformance rules.
- When there is a need to specify conformance rules that include the new components, there will be a need to create a new IOP version.

Note that host addresses are restricted in this version of IOP to be Class A, B, or C Internet addresses. That is, Class D (multi-cast) addresses are not allowed. Such addresses are reserved for use in future versions of IOP.

Agents may freely choose TCP port numbers for communication; IOP supports multiple agents per host.

9.7.3 IOP IOR Profile Components

The following components are part of IOP 1.1, 1.2, and later conformance. All these components are optional.

- **TAG_ORB_TYPE**
- **TAG_CODE_SETS**
- **TAG_SEC_NAME**
- **TAG_ASSOCIATION_OPTIONS**
- **TAG_GENERIC_SEC_MECH**
- **TAG_SSL_SEC_TRANS**
- **TAG_SPKM_1_SEC_MECH**
- **TAG_SPKM_2_SEC_MECH**
- **TAG_KerberosV5_SEC_MECH**
- **TAG_CSI_ECMA_Secret_SEC_MECH**
- **TAG_CSI_ECMA_Hybrid_SEC_MECH**
- **TAG_SSL_SEC_TRANS**
- **TAG_CSI_ECMA_Public_SEC_MECH**

- TAG_FIREWALL_TRANS
- TAG_JAVA_CODEBASE
- TAG_TRANSACTION_POLICY
- TAG_MESSAGE_ROUTERS
- TAG_INET_SEC_TRANS

The following components are part of IIOP 1.2, and later conformance. All these components are optional.

- TAG_ALTERNATE_IIOB_ADDRESS
- TAG_POLICIES
- TAG_DCE_STRING_BINDING
- TAG_DCE_BINDING_NAME
- TAG_DCE_NO_PIPES
- TAG_DCE_MECH
- TAG_COMPLETE_OBJECT_KEY
- TAG_ENDPOINT_ID_POSITION
- TAG_LOCATION_POLICY
- TAG_OTS_POLICY
- TAG_INV_POLICY
- TAG_CSI_SEC_MECH_LIST
- TAG_NULL_TAG
- TAG_SECIOP_SEC_TRANS
- TAG_TLS_SEC_TRANS
- TAG_ACTIVITY_POLICY

9.8 Bi-Directional GIOP

The specification of GIOP connection management, in GIOP minor versions 1.0 and 1.1, states that connections are not symmetrical. For example, only clients that initialize connections can send requests, and only servers that accept connections can receive them.

This GIOP 1.0 and 1.1 restriction gives rise to significant difficulties when operating across firewalls. It is common for firewalls not to allow incoming connections, except to certain well-known and carefully configured hosts, such as dedicated HTTP or FTP servers. For most CORBA-over-the-internet applications it is not practicable to require that all potential client firewalls install GIOP proxies to allow incoming connections, or that any entities receiving callbacks will require prior configuration of the firewall proxy.

An applet, for example, downloaded to a host inside such a firewall will be restricted in that it cannot receive requests from outside the firewall on any object it creates, as no host outside the firewall will be able to connect to the applet through the client's firewall, even though the applet in question would typically only expect callbacks from the server it initially registered with.

In order to circumvent this unnecessary restriction, GIOP minor protocol version 1.2 or later specifies that the asymmetry stipulation above be relaxed in cases where the client and the server agree on it. In these cases, the client (the applet in the above case) would still initiate the connection to the server, but any requests from the server on any objects.

The client creates an object for exporting to a server, and arranges that the server receive an IOR for the object. The most common use case would be for the client to pass the IOR as a parameter in a GIOP request, but other mechanisms are possible, such as the use of a Name Service. If the client ORB policy permits bi-directional use of a connection, a Request message should contain an **IOP::ServiceContext** structure in its Request header, which indicates that this GIOP connection is bi-directional. The service context may provide additional information that the server may need to invoke the callback object. To determine whether an ORB may support bi-directional GIOP new policies has been defined (Bi-directional GIOP policy on page 118).

Each mapping of GIOP to a particular transport should define a transport-specific bi-directional service context, and have an **IOP::Serviceld** allocated by the OMG. It is recommended that names for this service context follows the pattern *BiDir<protocolname>*, where <protocol name> identifies a mapping of GIOP to a transport protocol (e.g., for IIOP the name is **BiDirIIOP**). The service context for bi-directional IIOP is defined in Bi-directional IIOP on page 117.

The server receives the Request, which contains a bi-directional **IOP::ServiceContext**. If the server supports bi-directional connections for that protocol, it may now send invocations along the same connection to any object that supports the particular protocol and matches the particular location information found in the bi-directional service context. If the server does not support bi-directional connections for that protocol, the service context can be ignored.

The data encapsulated in the **BiDirIIOPServiceContext** structure (see below), which is identified by the **Serviceld BI_DIR_IIOP** as defined in Service Context on page 38, allows the ORB to determine whether it needs to open a new connection in order to invoke on an object. If a host and port pair in a *listen_point* list matches a host and port of an object to which it does not yet have a connection (a callback object newly received, for instance), rather than open a new connection, the server may re-use any of the connections on which the *listen_point* data was received.

A server talking to a client on a bi-directional GIOP connection can use any message type traditionally used by clients only, so it can use **Request**, **LocateRequest**, **CancelRequest**, **MessageError**, and **Fragment** (for a **Request** or **LocateRequest**). Similarly the client can use message types traditionally used only by servers: **Reply**, **LocateReply**, **MessageError**, **CloseConnection**, and **Fragment** (for a **Reply** or **LocateReply**).

CloseConnection messages are a special case however. Either ORB may send a **CloseConnection** message, but the conditions in Connection Management on page 108 apply.

Bi-directional GIOP connections modify the behavior of Request IDs. In the GIOP specification, Connection Management on page 108, it is noted that “Request IDs must unambiguously associate replies with requests within the scope and lifetime of a connection.” This property of unambiguous association of requests and replies must be preserved while permitting each end to generate Request Ids for new requests independently. To ensure this, on a connection that is used bi-directionally in GIOP 1.2, and later, the connection originator shall assign only even valued Request IDs and the other side of the connection shall assign only odd valued Request IDs. This requirement applies to the full lifetime of the connection, even before a **BiDirIIOPServiceContext** is transmitted. A connection on which this regime of Request ID assignment is not used, shall never be used to transmit bi-directional GIOP 1.2, or later messages.

It should be noted that a single-threaded ORB needs to perform event checking on the connection, in case a **Request** from the other endpoint arrives in the window between it sending its own **Request** and receiving the corresponding reply; otherwise a client and server could send **Requests** simultaneously, resulting in deadlock. If the client cannot support event checking, it must not indicate that bi-directionality is supported. If the server cannot support event checking, it must not make callbacks along the same connection even if the connection indicates it is supported.

A server making a callback to a client cannot specify its own bi-directional service context – only the client can announce the connection’s bi-directionality.

An important security issue should be observed in the use of bi-directional GIOP. In the absence of other security mechanisms, a malicious client may claim that its connection is Bi-Directional for use with any host and port it chooses. In particular it may specify the host and port of security sensitive objects not even resident on its host. All the client has to do is pass the host and port in the listen data service context and the server may then invoke a masquerading object instead. In general, and in the absence of other security mechanisms, a server that has accepted an incoming connection has no way to discover the identity or verify the integrity of the client that initiated the connection. If the server has doubts in the integrity of the client, it is recommended that bi-directional GIOP is not used.

9.8.1 Bi-directional IIOp

The **IOP::ServiceContext** used to support bi-directional IIOp contains a **BiDirIIOpServiceContext** structure as defined below:

```
// IDL
module IIOp {

    struct ListenPoint {
        string host;
        unsigned short port;
    };

    typedef sequence<ListenPoint> ListenPointList;

    struct BiDirIIOpServiceContext {
        ListenPointList listen_points;
    };
};
```

The data encapsulated in the **BiDirIIOpServiceContext** structure, which is identified by the ServiceId **BI_DIR_IIOp** as defined in Service Context on page 38, allows the ORB, which intends to open a new connection in order to invoke on an object, to look up its list of active client-initiated connections and examine the structures associated with them, if any. If a **host** and **port** pair in a **listen_points** list matches a host and port, which the ORB intends to open a connection to, rather than open a new connection to that **listen_point**, the server may re-use any of the connections that were initiated by the client on which the listen point data was received.

The **host** element of the structure should contain whatever values the client may use in the IORs it creates. The rules for **host** and **port** are identical to the rules for the IIOp IOR **ProfileBody_1_1 host** and **port** elements; see IIOp IOR Profiles on page 112. Note that if the server wishes to make a callback connection to the client in the standard way, it must use the values from the client object's IOR, not the values from this **BiDirIIOpServiceContext** structure; these values are only to be used for bi-directional GIOP support.

The **BI_DIR_IIOp** service context may be sent by a client at any point in a connection's lifetime. The **listen_points** specified therein must supplement any **listen_points** already sent on the connection, rather than replacing the existing points.

If a client supports a secure connection mechanism, such as SECIOP or IOP/SSL, and sends a **BI_DIR_IOP** service context over an insecure connection, the **host** and **port** endpoints listed in the **BI_DIR_IOP** should not contain the details of the secure connection mechanism if insecure callbacks to the client's secure objects would be a violation of the client's security policy.

It is the ORB's responsibility to ensure that an IOR contains an appropriate address.

9.8.1.1 IOP/SSL considerations

Bi-directional IOP can operate over IOP/SSL without defining any additions to the IOP/SSL or the bi-directional GIOP mechanisms. However, if the client wants to authenticate the server when the client receives a callback this cannot be done unless the client has already authenticated the server. This has to be performed during the initial SSL handshake. It is not possible to do this at any point after the initial handshake without establishing a new SSL connection (which defeats the purpose of the bi-directional connections).

9.9 Bi-directional GIOP policy

In GIOP protocol versions 1.0 and 1.1, there are strict rules on which side of a connection can issue what type of messages (for example version 1.0 and 1.1 clients can not issue GIOP reply messages). However, as documented above, it is sensible to relax this restriction if the ORB supports this functionality and policies dictate that bi-directional connection are allowed. To indicate a bi-directional policy, the following is defined.

// Self contained module for Bi-directional GIOP policy

```
module BiDirPolicy {  
  
    typedef unsigned short BidirectionalPolicyValue;  
    const BidirectionalPolicyValue NORMAL = 0;  
    const BidirectionalPolicyValue BOTH = 1;  
  
    const CORBA::PolicyType BIDIRECTIONAL_POLICY_TYPE = 37;  
  
    interface BidirectionalPolicy : CORBA::Policy {  
        readonly attribute BidirectionalPolicyValue value;  
    };  
};
```

A **BidirectionalPolicyValue** of **NORMAL** states that the usual GIOP restrictions of who can send what GIOP messages apply (i.e., bi-directional connections are not allowed). A value of **BOTH** indicates that there is a relaxation in what party can issue what GIOP messages (i.e., bi-directional connections are supported). The default value of a **BidirectionalPolicy** is **NORMAL**.

In the absence of a **BidirectionalPolicy** being passed in the **PortableServer::POA::create_POA** operation, a **POA** will assume a policy value of **NORMAL**.

A client and a server **ORB** must each have a **BidirectionalPolicy** with a value of **BOTH** for bi-directional communication to take place.

To create a **BidirectionalPolicy**, the **ORB::create_policy** operation is used.

9.10 OMG IDL

This sub clause contains the OMG IDL for the GIOP and IOP modules.

9.10.1 GIOP Module

```
module GIOP {    // IDL extended for version 1.1, 1.2, and later

    struct Version {
        octet    major;
        octet    minor;
    };

    #if MAX_GIOP_MINOR_VERSION == 0
        // GIOP 1.0
        enum MsgType_1_0{ // rename from MsgType
            Request, Reply,    CancelRequest,
            LocateRequest,    LocateReply,
            CloseConnection, MessageError
        };

    #else
        // GIOP 1.1
        enum MsgType_1_1{
            Request,    Reply,    CancelRequest,
            LocateRequest,    LocateReply,
            CloseConnection, MessageError,
            Fragment    // GIOP 1.1 addition
        };
    #endif // MAX_GIOP_MINOR_VERSION

    // GIOP 1.0

    typedef char Magicn[4]
    struct MessageHeader_1_0 { // Renamed from MessageHeader
        Magicn    magic;
        Version    GIOP_version;
        boolean    byte_order;
        octet    message_type;
        unsigned long    message_size;
    };

    // GIOP 1.1
    struct MessageHeader_1_1 {
        Magicn    magic;
        Version    GIOP_version;
        octet    flags; // GIOP 1.1 change
        octet    message_type;
        unsigned long    message_size;
    };
};
```



```

// GIOP 1.2 and later
typedef MessageHeader_1_1 MessageHeader_1_2;
typedef MessageHeader_1_1 MessageHeader_1_3;

// GIOP 1.0

struct RequestHeader_1_0 {
    IOP::ServiceContextList service_context;
    unsigned long request_id;
    boolean response_expected;
    IOP::ObjectKey object_key;
    string operation;
    CORBA::OctetSeq requesting_principal;
};

// GIOP 1.1
typedef octet RequestReserved[3];
struct RequestHeader_1_1 {
    IOP::ServiceContextList service_context;
    unsigned long request_id;
    boolean response_expected;
    RequestReserved reserved; // Added in GIOP 1.1
    IOP::ObjectKey object_key;
    string operation;
    CORBA::OctetSeq requesting_principal;
};

// GIOP 1.2, and later
typedef short AddressingDisposition;
const short KeyAddr = 0;
const short ProfileAddr = 1;
const short ReferenceAddr = 2;

struct IORAddressingInfo {
    unsigned long selected_profile_index;
    IOP::IOR ior;
};

union TargetAddress switch (AddressingDisposition) {
    case KeyAddr: IOP::ObjectKey object_key;
    case ProfileAddr: IOP::TaggedProfile profile;
    case ReferenceAddr: IORAddressingInfo ior;
};

struct RequestHeader_1_2 {
    unsigned long request_id;

    octet response_flags;
    RequestReserved reserved; // Added in GIOP 1.1
    TargetAddress target;
    string operation;
};

```

```

        // requesting_principal not in GIOP 1.2 and later
        IOP::ServiceContextList service_context; // 1.2 change
    };

#if MAX_GIOP_MINOR_VERSION < 2

    // GIOP 1.0 and 1.1
    enum ReplyStatusType_1_0 { // Renamed from ReplyStatusType
        NO_EXCEPTION,
        USER_EXCEPTION,
        SYSTEM_EXCEPTION,
        LOCATION_FORWARD
    };

    // GIOP 1.0
    struct ReplyHeader_1_0 { // Renamed from ReplyHeader
        IOP::ServiceContextList service_context;
        unsigned long request_id;
        ReplyStatusType_1_0 reply_status;
    };

    // GIOP 1.1
    typedef ReplyHeader_1_0 ReplyHeader_1_1;
    // Same Header contents for 1.0 and 1.1

#endif // MAX_GIOP_VERSION_NUMBER

#if MAX_GIOP_MINOR_VERSION >= 2

    // GIOP 1.2, and later
    enum ReplyStatusType_1_2 {
        NO_EXCEPTION,
        USER_EXCEPTION,
        SYSTEM_EXCEPTION,
        LOCATION_FORWARD,
        LOCATION_FORWARD_PERM, // new value for 1.2
        NEEDS_ADDRESSING_MODE // new value for 1.2
    };

    struct ReplyHeader_1_2 {
        unsigned long request_id;
        ReplyStatusType_1_2 reply_status;
        IOP::ServiceContextList service_context; // 1.2 change
    };
    typedef ReplyHeader_1_2 ReplyHeader_1_3;

#endif // MAX_GIOP_VERSION_NUMBER

    struct SystemExceptionReplyBody {
        string exception_id;
        unsigned long minor_code_value;
    };

```

```

    unsigned long        completion_status;
};

struct CancelRequestHeader {
    unsigned long        request_id;
};

// GIOP 1.0
struct LocateRequestHeader_1_0 {
    // Renamed LocationRequestHeader
    unsigned long        request_id;
    IOP::ObjectKey      object_key;
};

// GIOP 1.1
typedef LocateRequestHeader_1_0 LocateRequestHeader_1_1;
// Same Header contents for 1.0 and 1.1

// GIOP 1.2 and later
struct LocateRequestHeader_1_2 {
    unsigned long        request_id;
    TargetAddress        target;
};
typedef LocateRequestHeader_1_2 LocateRequestHeader_1_3;

#if MAX_GIOP_MINOR_VERSION < 2

// GIOP 1.0 and 1.1
enum LocateStatusType_1_0 { // Renamed from LocateStatusType
    UNKNOWN_OBJECT,
    OBJECT_HERE,
    OBJECT_FORWARD
};

// GIOP 1.0
struct LocateReplyHeader_1_0 {
    // Renamed from LocateReplyHeader
    unsigned long        request_id;
    LocateStatusType_1_0 locate_status;
};

// GIOP 1.1
typedef LocateReplyHeader_1_0 LocateReplyHeader_1_1;
// same Header contents for 1.0 and 1.1

#else
// GIOP 1.2, and later
enum LocateStatusType_1_2 {
    UNKNOWN_OBJECT,
    OBJECT_HERE,
    OBJECT_FORWARD,
};

```

```

        OBJECT_FORWARD_PERM,           // new value for GIOP 1.2
        LOC_SYSTEM_EXCEPTION,         // new value for GIOP 1.2
        LOC_NEEDS_ADDRESSING_MODE    // new value for GIOP 1.2
    };

    struct LocateReplyHeader_1_2 {
        unsigned long    request_id;
        LocateStatusType_1_2    locate_status;
    };
    typedef LocateReplyHeader_1_2 LocateReplyHeader_1_3;

#endif // MAX_GIOP_VERSION_NUMBER

// GIOP 1.2, and later
struct FragmentHeader_1_2 {
    unsigned long    request_id;
};
typedef FragmentHeader_1_2 FragmentHeader_1_3;
};

```

9.10.2 IIOP Module

```

module IIOP { // IDL extended for version 1.1, 1.2, and later
    struct Version {
        octet    major;
        octet    minor;
    };

    struct ProfileBody_1_0 { // renamed from ProfileBody
        Version    iiop_version;
        string    host;
        unsigned short    port;
        IOP::ObjectKey    object_key;
    };

    struct ProfileBody_1_1 { // also used for 1.2, and later
        Version    iiop_version;
        string    host;
        unsigned short    port;
        IOP::ObjectKey    object_key;

        // Added in 1.1 unchanged for 1.2, and later
        IOP::TaggedComponentSeq components;
    };

    struct ListenPoint {
        string host;
        unsigned short port;
    };
};

```

```

typedef sequence<ListenPoint> ListenPointList;

struct BiDirIIOServiceContext { // BI_DIR_IIO Service Context
    ListenPointList listen_points;
};
};

```

9.10.3 BiDirPolicy Module

```

// Self contained module for Bi-directional GIOP policy

module BiDirPolicy {

    typedef unsigned short BidirectionalPolicyValue;
    const BidirectionalPolicyValue NORMAL = 0;
    const BidirectionalPolicyValue BOTH = 1;

    const CORBA::PolicyType BIDIRECTIONAL_POLICY_TYPE = 37;

    interface BidirectionalPolicy : CORBA::Policy {
        readonly attribute BidirectionalPolicyValue value;
    };
};

```

10 Secure Interoperability

This clause defines the CORBA Security Attribute Service (SAS) protocol and its use within the CSIV2 architecture to address the requirements of CORBA security for interoperable authentication, delegation, and privileges.

10.1 Overview

The SAS protocol is designed to exchange its protocol elements in the service context of GIOP request and reply messages that are communicated over a connection-based transport. The protocol is intended to be used in environments where transport layer security, such as that available via SSL/TLS or SECIOP, is used to provide message protection (that is, integrity and or confidentiality) and server-to-client authentication. The protocol provides client authentication, delegation, and privilege functionality that may be applied to overcome corresponding deficiencies in an underlying transport.¹ The SAS protocol facilitates interoperability by serving as the higher-level protocol under which secure transports may be unified.

The SAS protocol is divided into two layers:

- The authentication layer is used to perform client authentication where sufficient authentication could not be accomplished in the transport.
- The attribute layer may be used by a client to push (that is, deliver) security attributes (identity and privilege) to a target where they may be applied in access control decisions.

The attribute layer also provides a means for a client to assert identity attributes that differ from the client's authentication identity (as established in the transport and/or SAS authentication layers). This identity assertion capability is the foundation of a general-purpose impersonation mechanism that makes it possible for an intermediate to act on behalf of some identity other than itself. An intermediate's authority to act on behalf of another identity may be based on trust by the target in the intermediate, or on trust by the target in a privilege authority that endorses the intermediate to act as proxy for the asserted identity. Identity assertion may be used by an intermediate to assume the identity of its callers in its calls.

The SAS protocol is modeled after the Generic Security Service API (GSSAPI) token exchange paradigm. A client initiates a context exchange by including a protocol element in the service context of its request that instructs the target to initiate a security context. The target either rejects or accepts the context.² When a target rejects a context, the target will reject the request and return an exception that contains a SAS protocol element that identifies the reason the context was rejected. When a target accepts a context, the reply to the request will carry a SAS protocol element that indicates that the context was accepted.

The SAS protocol element sent to initiate a security context carries layer-specific security tokens as necessary to establish the SAS authentication-layer and attribute-layer functionality corresponding to the context. Standard token formats are employed to represent the layer-specific authentication and attribute tokens. If the context includes SAS authentication-layer functionality, the protocol element will contain a mechanism-specific GSSAPI initial context token that authenticates the client to the target. If the context includes attribute-layer privilege attributes (and possibly proxy

1. For example, the SSL/TLS protocol does not enforce client authentication. Moreover, in a given environment, certificate-based client authentication may not be feasible because clients often do not have a certificate.

2. In the GSSAPI protocol, a target can challenge a client for additional context-establishment information. This is not true of the SAS context protocol, which assumes that at most one message in each direction may be used to establish a context.

endorsements), they will be contained in an attribute certificate signed by a privilege authority and corresponding to the subject of the invocation. If the context includes an attribute-layer identity assertion, the asserted identity will be represented in a standard name form corresponding to the technology domain of the asserted identity.

The SAS protocol supports the establishment of both transient and reusable security contexts. Transient contexts, also known as stateless contexts, exist only for the duration of the GIOP request that was used to establish the context. Reusable contexts, also known as stateful contexts, endure until they are discarded, and can be referenced for use with subsequent requests. The SAS protocol includes a simple negotiation protocol that defines a least-common-denominator form of interoperability between implementations that support only transient contexts and those that support both transient and reusable forms.

10.1.1 Assumptions

The SAS protocol was designed under the following assumptions:

- Secure interoperability is predicated on the use of a common transport-layer security mechanism, such as that provided by SSL/TLS.³
- The transport layer provides message protection as necessary to protect GIOP input and output request arguments.
- The transport layer provides target-to-client authentication as necessary to identify the target for the purpose of ensuring that the target is the intended target.
- Transport-layer security can ensure that the client does not have to issue a preliminary request to establish a confidential association with the intended target.⁴
- To support clients that cannot authenticate using transport-layer security mechanisms, the SAS protocol shall provide for client authentication above the transport layer.
- To support the formation of security contexts using GIOP service context, the SAS protocol shall require at most one message in each direction to establish a security context.
- The protocol shall support security contexts that exist only for the duration of a single request/reply pair.
- The protocol shall support security contexts that can be reused for multiple request/reply pairs.
- Targets cannot rely on clients to manage the lifecycle of reusable security contexts accepted by the target.
- Clients that reuse security contexts shall be capable of processing replies that indicate that the context has been discarded by the target.

3. Transport security mechanisms include unprotected transports within trusted environments.

4. This assumption does not preclude the use of such mechanisms, but rather sustains the use of this protocol in environments where such mechanisms are not considered favorably.

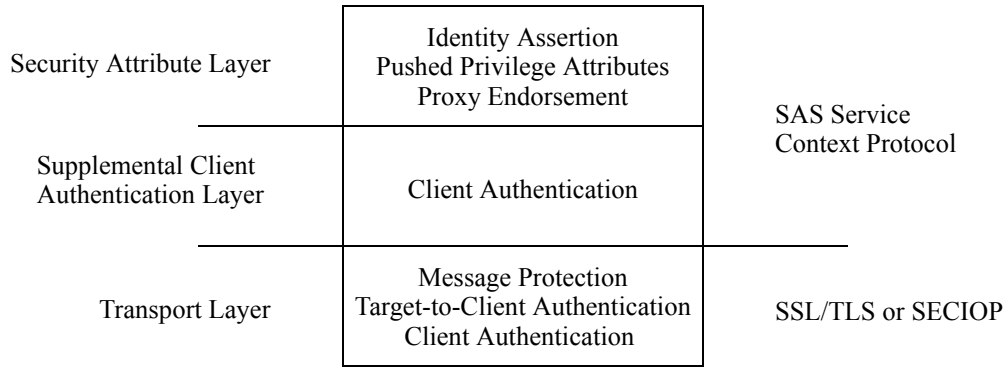

Figure 10.1 - CSIv2 Security Architecture

10.2 Protocol Message Definitions

10.2.1 The Security Attribute Service Context Element

This specification defines a new GIOP service context element type, the security attribute service (SAS) element. The SAS context element may be used to associate any or all of the following contexts with GIOP request and reply messages:

- Identity context, to be accepted based on trust
- Authorization context, including authorization-based delegation context
- Client authentication context

A new **context_id** has been defined for the SAS element.

```
const ServiceId SecurityAttributeService = 15;
```

The **context_data** of a SAS element is an encapsulation octet stream containing a SAS message body marshaled according to the CDR encoding rules. The formats of the SAS message bodies are defined in the next sub clause.

```
struct ServiceContext {
    ServiceId context_id;
    sequence <octet> context_data;
};
```

At most one instance of this new service context element may be included in a GIOP request or reply.

10.2.2 SAS context_data Message Body Types

Four message types comprise the security attribute service context management protocol. Each security attribute service context element shall contain a message body that carries one of the following message body types:

- **EstablishContext**
Sent by a client security service (CSS) to establish a security attribute service context.
- **ContextError**
Sent by a target security service (TSS) to indicate errors that were encountered in context creation, in the message protocol, or in use of a context.
- **CompleteEstablishContext**
Sent by a target security service (TSS) to indicate the outcome of a successful request to establish a security attribute service context.
- **MessageInContext**
Sent by a client security service (CSS) to associate request messages with an existing stateful security attribute service context. This message may also be used to indicate that the context should be discarded after processing the request. Stateful contexts, also known as reusable contexts, endure until they are discarded, and can be referenced for use with subsequent requests.

A client security service (CSS) is the security service associated with the ORB that is used by the client to invoke the target object. A target security service (TSS) is the security service associated with the ORB that hosts the target object.

10.2.2.1 EstablishContext Message Format

An **EstablishContext** message is sent by a CSS to establish a SAS context with a TSS. The SAS context and the context identifier allocated by the CSS to refer to it are scoped to the transport layer connection or association over which the CSS and TSS are communicating. When an association is dismantled, all SAS contexts scoped to the connection shall be invalidated and may be discarded. The **EstablishContext** message contains the following fields:

- **client_context_id**
The CSS allocated identifier for the security attribute service context. A stateless CSS shall set the **client_context_id** to 0, indicating to the TSS that it is stateless. A stateful CSS may allocate a nonzero **client_context_id**. See Stateful/Reusable Contexts on page 141 for a definition of the rules governing the use and allocation of context identifiers.
- **authorization_token**
May be used by a CSS to “push” privilege information to a TSS. A CSS may use this token to send proxy privileges to a TSS as a means to enable the target to issue calls as the client.
- **identity_token**
Carries a representation of the invocation identity for the call (that is, the identity under which the call is to be authorized). The **identity_token** carries a representation of the invocation identity in one of the following forms:
 - A typed mechanism-specific representation of a principal name.
 - A chain of identity certificates representing the subject and a chain of verifying authorities.
 - A distinguished name.
 - The anonymous principal identity (a type, not a name).

An **identity_token** is used to assert a caller identity when that identity differs from the identity proven by authentication in the authentication layer(s). If the caller identity is intended to be the same as that established in the authentication layer(s), then it does not need to be asserted in an **identity_token**.
- **client_authentication_token**
Carries a mechanism-specific GSS initial context token that authenticates the client to the TSS. It contains a mechanism type identifier and the mechanism-specific evidence (that is, the authenticator) required by the TSS to authenticate the client.

When an initial context token contains private credentials, such as a password, this message may be safely sent only after a confidential connection with a trusted TSS has been established. The determination of when it is safe to send a client authentication token in an **EstablishContext** message shall be considered in the context of the CORBA location-binding paradigm for persistent objects (where an invocation may be “location forwarded” by a location daemon to the target object). This issue is considered in Client-Side Requirements and Location Binding on page 160.

When a TSS is unable to validate a security attribute service context, the TSS shall not dispatch on the target object method invocation. The TSS shall reply with a **ContextError** message that carries major and minor codes indicating the reason for the failure.

If an **EstablishContext** message contains an identity token, then it is the responsibility of the TSS to extract a principal identity from the identity token and determine if the identity established in the authentication layer(s) is trusted to assert the extracted identity. If so, the asserted identity is used as the caller identity in the target’s authorization determination.

The processing of a request to establish a context that arrives on a one-way call shall be the same as an ordinary call, except that the TSS will not send an indication of the success (**CompleteEstablishContext**) or failure (**ContextError**) of the context validation.

10.2.2.2 ContextError Message Format

A **ContextError** message is sent by a TSS in response to an **EstablishContext** or **MessageInContext** message to indicate to the client that the TSS detected an error. CSS State Machine on page 145 defines the circumstances under which a TSS returns specific error values and exceptions. The **ContextError** message contains the following fields:

- **client_context_id**
The value of the **client_context_id** that identifies the CSS context in the **EstablishContext** or **MessageInContext** message in response to which the **ContextError** is being returned.
- **major_status**
The reason the TSS rejected the context.
- **minor_status**
A more specific error code that further defines the reason for rejection in the context of the major status.
- **error_token**
A GSS mechanism-specific error token. When an **EstablishContext** message is rejected because it contains a **client_authentication_token** (a GSS initial context token) that is invalidated by the TSS, then depending on the mechanism, the TSS may return a CDR encapsulation of a mechanism-specific GSS error token in this field. Not all GSS mechanisms produce error tokens in response to initial context token validation failures.

In all circumstances where a TSS returns a **ContextError**, the GIOP request that carried the rejected SAS context shall not be dispatched by the target ORB.

10.2.2.3 CompleteEstablishContext Message Format

A **CompleteEstablishContext** message is sent by a TSS in response to an **EstablishContext** message to indicate that the context was established. The **CompleteEstablishContext** message contains the following fields:

- **client_context_id**
The CSS allocated identifier for the security attribute context. It is returned by the target so that a stateful CSS can link this message to the **EstablishContext** request. A TSS shall always return the value of the **client_context_id** it received in the **EstablishContext** message.

- **context_stateful**

The value returned by the TSS to indicate whether or not the established context is stateful, and thus reusable. A stateless TSS shall always return false. A stateful TSS shall return true if the established context is reusable. Otherwise a stateful TSS shall return false.

- **final_context_token**

The GSS mechanism-specific final context token that is returned by a TSS if the client requests mutual authentication. When a TSS accepts an EstablishContext message containing an initial context token that requires mutual authentication, the TSS shall return a mechanism-specific final context token. Not all GSS mechanisms support mutual authentication, and thus not all responses to initial context tokens may include final (or output) context tokens.⁵

When a **CompleteEstablishContext** message contains a **final_context_token**, the token shall be applied (with **GSS_Init_sec_context**) to the client-side GSS state machine.

Two or more stateful SAS contexts are equivalent if they are established over the same transport layer connection or association, have the same non-zero **client_context_id** and have byte-equivalent identity, authorization, and authentication tokens.

A multithreaded CSS may issue multiple concurrent requests to establish (that is, with an **EstablishContext** message) an equivalent stateful SAS context.

A TSS shall not create a duplicate stateful SAS context in response to a request to establish a context that is equivalent to an existing context.

A TSS shall return an exception containing a **ContextError** service context element if it receives a stateful **EstablishContext** message with a **client_context_id** that matches that of an existing context (established over the same transport layer connection or association) and for which any of the security tokens arriving in the message are not byte-equivalent to those recorded in the existing context. The request shall also be rejected. The exception and error values to be returned are defined in CSS State Machine on page 145.

Table 10.1- CompleteEstablishContext Message Semantics

client_context_id in EstablishContext Message	client_context_id in CompleteEstablishContext Message	context_stateful in CompleteEstablishContext Message	Semantic
0	0	False	Client requested stateless context.
N != 0	N	False	TSS is stateless or TSS did not choose to remember context. In either case, if the client attempts to reuse the context (via MessageInContext) it should expect to receive an error.
		True	Stateful TSS accepted reusable context.

5. SAS layer authentication capabilities are designed to authenticate client to server where such authentication did not occur in the transport. The SAS protocol is predicated on server-to-client authentication having occurred in the transport layer, and in advance of the request. Server-to-client authentication in service context (which requires that the target return a **final_context_token**) is not the typical use model for SAS layer authentication capabilities.

10.2.2.4 MessageInContext Message Format

A **MessageInContext** message is used by a CSS that wishes to reuse an existing context with a request. A CSS may also use this message to release context that it has established with a stateful TSS. The **MessageInContext** message contains the following fields:

- **client_context_id**
The nonzero context identifier allocated by the client in the **EstablishContext** message used to create the context.
- **discard_context**
A boolean value that indicates whether the CSS wishes the TSS to discard the context after it processes the request. A value of true indicates that the CSS wishes the context to be discarded, a value of false, indicates that it does not. The purpose of the **discard_context** field is to allow a CSS to help a TSS manage the cleanup of reusable contexts.⁶

Any request message may be used to carry a **MessageInContext** message to a target. A TSS that receives a **MessageInContext** message shall complete the processing of the request before it discards the context (if **discard_context** is set to true).

A TSS may receive a **MessageInContext** message that refers to a context that does not exist at the TSS. This can occur either because the context never existed at the TSS or because it has been discarded by the TSS. In either case, the TSS shall return an exception containing a **ContextError** service context element with major and minor error codes indicating that the referenced context does not exist. The exception and error values to be returned are defined in CSS State Machine on page 145.

The processing of a **MessageInContext** message that arrives on a one-way call shall be the same as for an ordinary call, except that the TSS will not return a **ContextError** when the referenced context does not exist.

10.2.3 Authorization Token Format

The **authorization_token** field of the **EstablishContext** message of the Security Attribute Service context element is used to carry a sequence (0 or more) of typed representations of authorization data. The **AuthorizationElementType** defines the contents and encoding of the contents of the **the_element** field.

The high order 20-bits of each **AuthorizationElementType** constant shall contain the Vendor Minor Codeset ID (VMCID) of the organization that defined the element type. The low order 12 bits shall contain the organization-scoped element type identifier. The high-order 20 bits of all element types defined by the OMG shall contain the VMCID allocated to the OMG (that is, 0x4F4D0).

Organizations must register their VMCIDs with the OMG before using them to define an **AuthorizationElementType**.

```
typedef unsigned long AuthorizationElementType;
```

```
typedef sequence <octet> AuthorizationElementContents;
```

```
struct AuthorizationElement {  
    AuthorizationElementType    the_type;  
    AuthorizationElementContents the_element;
```

6. Stateful clients are under no obligation to manage TSS state, so their use of this message for that purpose is discretionary.

```
};  
typedef sequence <AuthorizationElement> AuthorizationToken;
```

```
const AuthorizationElementType X509AttributeCertChain = OMGVMCID | 1;
```

This specification has defined one element encoding type, an X509AttributeCertChain. For this type, the field **the_element** contains an octet stream containing an ASN.1 type composed of an X.509 **AttributeCertificate** and a sequence of 0 or more X.509 Certificates. The corresponding ASN.1 definition appears below:

```
VerifyingCertChain ::= SEQUENCE OF Certificate
```

```
AttributeCertChain ::= SEQUENCE {  
    attributeCert AttributeCertificate,  
    certificateChain VerifyingCertChain,  
}
```

The chain of identity certificates may be provided to certify the attribute certificate. Each certificate in the chain shall directly certify the one preceding it. The first certificate in the chain shall certify the attribute certificate. The ASN.1 representation of Certificate shall be as defined in [IETF RFC 2459]. The ASN.1 representation of **AttributeCertificate** shall be as defined in [IETF ID PKIXAC].

10.2.3.1 Extensions of the IETF AC Profile for CSiv2

The **extensions** field of the X.509 Attribute Certificates (AC) provides for the association of additional attributes with the holder or subject of the AC.

Each extension includes an **extnID** (an object identifier), an **extnValue** (an octet string), and a **critical** field (a boolean). The **extnID** identifies the extension, and the **extnValue** contains the value of the instance of the identified extension. The **critical** field indicates whether a certificate-using system shall reject the certificate if it does not recognize the extension. If the **critical** field is set to TRUE and the extension is not recognized (by its **extnID**), then the certificate shall be rejected. A non-critical extension that is not recognized may be ignored.

```
Extensions ::= SEQUENCE SIZE (1..MAX) OF Extension
```

```
Extension ::= SEQUENCE {  
    extnID OBJECT IDENTIFIER,  
    critical BOOLEAN DEFAULT FALSE,  
    extnValue OCTET STRING  
}
```

[IETF ID PKIXAC] defines a profile for ACs that defines a collection of extensions that may be used in ACs that conform to the profile. An AC that includes any subset of these extensions conforms to the profile. An AC that includes any other critical extension does not conform to the profile. An AC that includes any other non-critical extension conforms to the profile.

The CSiv2 AC profile adds the Proxy Info extension to the collection of extensions defined by the IETF profile. This critical extension may be used to define who may act as proxy for the AC subject. Refer to [IETF ID PKIXAC] for the details of the format and semantics of the Proxy Info extension.

A TSS shall reject a security context that contains an authorization element of type **X509AttributeCertChain** that contains critical extensions or attributes not recognized by the TSS. In this case, the TSS shall return a **ContextError** service context element containing major and minor error codes indicating the evidence is invalid (that is, “Invalid evidence”) as defined in ContextError Values and Exceptions on page 148.

10.2.4 Client Authentication Token Format

A CSIV2 client authentication token is a mechanism-specific GSS initial context token. It contains a mechanism type identifier (an object identifier) and the mechanism-specific evidence (that is, the authenticator) required to authenticate the client.

The following ASN.1 basic token definition describes the format of all GSSAPI initial context tokens. The definition of the inner context tokens is mechanism-specific.

-- basic Token Format

```
[APPLICATION 0] IMPLICIT SEQUENCE {  
  thisMech MechType  
    -- MechType is an Object Identifier  
  innerContextToken ANY DEFINED BY thisMech  
    -- contents mechanism specific  
};
```

The client authentication token has been designed to accommodate the initial context token corresponding to any GSSAPI mechanism. Implementations are free to employ GSSAPI mechanisms other than those required for conformance to CSIV2, such as Kerberos.

The format of the mechanism OID in GSS initial context tokens is defined in [IETF RFC 2743] 3.1, “Mechanism-Independent Token Format,” pp. 81-82.

10.2.4.1 Username Password GSS Mechanism (GSSUP)

This specification defines a GSSAPI mechanism to support the delivery of authentication secrets above the transport such that they may be applied by a TSS to authenticate clients at shared secret authentication systems.

The GSSUP mechanism assumes that transport layer security, such as that provided by SSL/TLS, will be used to achieve confidentiality and trust in server, such that the contents of the initial context token do not have to be protected against exposures that occur as the result of networking.

The object identifier allocated for the GSSUP mechanism is defined as follows:

```
{ iso-itu-t (2) international-organization (23) omg (130) security (1) authentication (1)  
  gssup-mechanism (1) }
```

10.2.4.1.1 GSSUP Initial Context Token

For the GSSUP mechanism, only an inner context token corresponding to the initial context token is defined.

The format of a GSSUP initial context token shall be as defined in [IETF RFC 2743] 3.1, “Mechanism-Independent Token Format,” pp. 81-82. This GSSToken shall contain an ASN.1 tag followed by a token length, an authentication mechanism identifier, and a CDR encapsulation containing a GSSUP inner context token as defined by the type **GSSUP::InitialContextToken** in Module GSSUP - Username/Password GSSAPI Token Formats on page 172 (and repeated below).

```
// GSSUP::InitialContextToken
```

```
struct InitialContextToken {  
    CSI::UTF8String username;  
    CSI::UTF8String password;  
    CSI::GSS_NT_ExportedName target_name;  
};
```

The **target_name** field of the **GSSUP::InitialContextToken** contains the name of the authentication domain in which the client is authenticating. This field aids the TSS in processing the authentication should the TSS support several authentication domains. A CSS shall fill the **target_name** field of the **GSSUP::InitialContextToken** with the contents of the **target_name** field of the **CSIIOP::AS_ContextSec** structure of the chosen CSI mechanism.

The format of the name passed in the **username** field depends on the authentication domain. If the mechanism identifier of the target domain is GSSUP, then the format of the username shall be a Scoped-Username (with **name_value**) as defined in Scoped-Username GSS Name Form on page 136.

10.2.4.1.2 GSSUP Mechanism-Specific Error Token

The GSSUP mechanism-specific error token contains a GSSUP fatal error code.

```
typedef unsigned long ErrorCode;
```

```
// GSSUP Mechanism-Specific Error Token
```

```
struct ErrorToken {  
    ErrorCode error_code;  
};
```

The following fatal error codes are defined by the GSSUP mechanism:

```
// The context validator has chosen not to reveal the GSSUP  
// specific cause of the failure.  
const ErrorCode GSS_UP_S_G_UNSPECIFIED = 1;
```

```
// The user identified in the username field of the  
// GSSUP::InitialContextToken is unknown to the target.  
const ErrorCode GSS_UP_S_G_NOUSER = 2;
```

```
// The password supplied in the GSSUP::InitialContextToken was  
// incorrect.  
const ErrorCode GSS_UP_S_G_BAD_PASSWORD = 3;
```

```
// The target_name supplied in the GSSUP::InitialContextToken does  
// not match a target_name in a mechanism definition of the target.  
const ErrorCode GSS_UP_S_G_BAD_TARGET = 4;
```

A TSS is under no obligation to return a GSSUP error token; however, returning this token may facilitate the transition of the client-side GSS state machine through error processing. Accordingly, a TSS may indicate that SAS context validation failed in GSSUP client authentication by returning a GSSUP error token in a SAS **ContextError** message. In this case, a TSS that chooses not to reveal specific information as to the cause of the failed GSSUP authentication shall return a status value of **GSS_UP_S_G_UNSPECIFIED**.

10.2.5 Identity Token Format

An identity token is used in an **EstablishContext** message to carry a “spoken for” or asserted identity. The following table lists the five identity token types and defines the type of identity value that may be carried by each of the token types.

In addition to the identity token types described in the following table, the **IdentityTokenType** as defined in Module CSI - Common Secure Interoperability on page 173 provides for the definition of additional CSIv2 identity token types through the default selector of the **IdentityToken** union type. Additional standard identity token types shall only be defined by the OMG. All **IdentityTokenType** constants shall be a power of 2.

Table 10.2 - Identity Token Types

IdentityTokenType (Union Discriminator)	Meaning
ITTAbsent	Identity token is absent; the message conveys no representation of identity assertion.
ITTAnonymous	Identity token is being used to assert a valueless representation of an unauthenticated caller.
ITTPrincipalName	Identity token contains an octet stream containing a GSS mechanism-independent exported name object as defined in [IETF RFC 2743].
ITTDistinguishedName	Identity token contains an octet stream containing an ASN.1 encoding of an X.501 distinguished name.
ITTX509CertChain	Identity token contains an octet stream containing an ASN.1 encoding of a chain of X.509 identity certificates.

Identity tokens of type **ITTX509CertChain** contain an ASN.1 encoding of a sequence of 1 or more X.509 certificates. The asserted identity may be extracted as a distinguished name from the subject field of the first certificate. Subsequent certificates shall directly certify the certificate they follow. The ASN.1 encoding of identity tokens of this type is defined as follows:

CertificateChain ::= SEQUENCE SIZE (1..MAX) OF Certificate

Interpretation of identity tokens that carry a GSS mechanism-independent exported name object (that is, an identity token type of **ITTPrincipalName**) is dependent on support for GSS mechanism-specific name manipulation functionality.

When a TSS rejects a request because it carries an identity token constructed using an identity type or naming mechanism that is not supported by the target, the TSS shall return a **ContextError** service context element containing major and minor status codes indicating the mechanism was invalid.

Asserting entities may choose to overcome limitations in a target’s supported mechanisms by mapping GSS mechanism-specific identities to distinguished names or certificates. The specifics of such mapping mechanisms are outside the scope of this specification.

10.2.5.1 GSS Exported Name Object Form for GSSUP Mechanism

The mechanism OID within the exported name object shall be that of the GSSUP mechanism.

{ iso-itu-t (2) international-organization (23) omg (130) security (1) authentication (1) gssup-mechanism (1) }

The name component within the exported name object shall be a contiguous string conforming to the syntax of the scoped-username GSS name form. The encoding of GSS mechanism-independent exported name objects is defined in [IETF RFC 2743].

10.2.5.2 Scoped-Username GSS Name Form

The scoped-username GSS name form is defined as follows, where **name_value** and **name_scope** contain a sequence of 1 or more UTF8 encoded characters.

scoped-username ::= name_value | name_value@name_scope | @name_scope

The '@' character shall be used to delimit **name_value** from **name_scope**. All non-delimiter instances of '@' and all non-quoting instances of '\' shall be quoted with an immediately-preceding '\'. Except for these cases, the quoting character, '\', shall not be emitted within a scoped-username.

The Object Identifier corresponding to the GSS scoped-username name form is:

{ iso-itu-t (2) international-organization (23) omg (130) security (1) naming (2) scoped-username(1) }

The identity token for **ITTPPrincipalName**, **ITTDistinguishedName**, **ITTX509CertChain** should contain their respective ASN.1 encodings of the name directly. However, the token may contain a CDR encapsulation of the octet stream that contains the ASN.1 encoding of the name. The TSS shall distinguish the difference by the first octet of the field. The values of 0x00 or 0x01 shall indicate that the field contains a CDR encapsulation. Any other value indicates the field for these identity token types contains the ASN.1 encoded value. For instance, the ASN.1 encoding for **ITTPPrincipalName** starts with 0x04, and **ITTDistinguishedName** and **ITTX509CertChain** each start with 0x30. The TSS shall accept both the CDR encapsulation form and the direct ASN.1 encoding for these identity token types.

10.2.6 Principal Names and Distinguished Names

Principal names are carried in **EstablishContext** messages of the SAS protocol, where they may appear in the **identity_token** (the **ITTPPrincipalName** discriminated type of an **IdentityTokenType**) or in the **client_authentication_token**, which is a GSS initial context token.

Principal names are also present in the compound mechanisms defined within a **TAG_CSI_SEC_MECH_LIST** tagged component within IORs. The **target_name** field of the **AS_ContextSec** structure may contain a sequence of principal names corresponding to the authentication identities of the target (see struct **AS_ContextSec** on page 155). A principal name may be used as one variant of the **ServiceSpecificName** form used to identify one of the **privilege_authorities** within the **SAS_ContextSec** structure of a compound mechanism definition within a target IOR (see struct **SAS_ContextSec** on page 156).

The principal names appearing in initial context tokens are in mechanism-specific; that is, internal form, and may be converted to GSS mechanism-independent exported name object format; that is, an external form by calling a mechanism-specific implementation of **GSS_Export_name**. The inverse translation is performed by a mechanism-specific implementation of **GSS_Import_name**. A mechanism-specific implementation of **GSS_Display_name** allows its caller to convert an internal name representation into a printable form with an associated mechanism type identifier.⁷

7. As defined in IETF RFC 2743 on page 172, "Generic Security Service Application Program Interface Version 2, Update 1", J. Linn, January 2000.

The principal names in identity tokens — those in the **target_name** field of **AS_ContextSec** structures and those in the **privilege_authorities** field of **SAS_ContextSec** structures — are in external form (**GSS_NT_ExportedName**), and may be converted to internal form by calling the appropriate mechanism-specific **GSS_import_name** function.

Distinguished names may appear within an identity token, either as an asserted identity or indirectly as the subject distinguished name within an asserted X.509 Identity Certificate. Distinguished names may also be derived from the underlying transport authentication layer if client authentication is done using SSL certificates. Distinguished names may also be used as a form of GeneralName in the GeneralNames variant of the ServiceSpecificName type. The **ServiceSpecificName** type is used to identify **privilege_authorities** within the **SAS_ContextSec** structure of a compound mechanism definition within a target IOR.

10.3 Security Attribute Service Protocol

10.3.1 Compound Mechanisms

The SAS protocol combines common authorization (security attribute) functionality with client authentication functionality and is intended to be used in conjunction with a transport-layer security mechanism, so that there may be as many as three protocol layers of security functionality. This sub clause describes the semantics of the compound security mechanisms that may be realized using this interoperability architecture.

The three protocol layers build on top of each other. The transport layer is at the bottom. The client authentication functionality of the SAS protocol provides a way to layer additional client authentication functionality above the transport layer. The common authorization functionality provides a way to layer security attribute functionality above the authentication layers. Any or all of the layers may be absent.

A target describes in its IORs the CSI compound security mechanisms it supports. Each mechanism defines a combination of layer-specific security functionality supported by the target, as defined in TAG_CSI_SEC_MECH_LIST on page 154.

The mechanisms a client uses to interact with a target shall be compatible with the target's capabilities and sufficient to satisfy its requirements.

10.3.1.1 Context Validation

A target indicates its requirements for client authentication in its IORs. The layers at which a CSS authenticates to a TSS shall satisfy the requirements established by the target (see the description in Target Security Configuration on page 150). When a CSS attempts to authenticate with a TSS using the client authentication functionality of the SAS context layer protocol (by including a **client_authentication_token** in an **EstablishContext** message), the authentication context established in the TSS will reflect the result of the service context authentication (after having satisfied the target's requirement for transport level authentication, if any).

If the service context authentication fails, the following shall happen:

- The request shall be rejected, whether or not authentication is required by the target.
- An exception containing a **ContextError** service context element shall be returned to the CSS. The **ContextError** service context element shall contain major and minor status codes indicating that client authentication failed.

If the request does not include a **client_authentication_token**, the client authentication identity is derived from the transport layer.

When a request includes an identity token, the TSS shall determine if the identity established as the client authentication identity is trusted to assert the identity represented in the identity token.

A TSS that does not support authorization-token-based delegation (see Conformance Levels on page 160) shall evaluate trust by applying the client authentication identity and the asserted identity to trust rules stored at the target. We call the evaluation of trust based on rules of the target a backward trust evaluation.

When a TSS that supports authorization-token-based delegation receives a request that includes both an identity token and an authorization token with embedded proxy attributes, the TSS shall evaluate trust by determining whether the proxy attributes were established (that is, signed) by a privilege authority acceptable to the target and whether the client authentication identity is included in the identities named in the proxy attributes. We call the evaluation of trust based on rules provided by the caller a forward trust evaluation. A TSS shall not accept requests that failed a forward trust evaluation based on a backward trust evaluation.

A TSS shall determine that a trusted identity established in the authentication layer(s) is trusted to assert exactly the same identity (in terms of identifier value and identification mechanism) in an identity token.

In either case of forward or backward trust evaluation, if trust is established, the context is considered correctly formed. Otherwise, the TSS shall reject the request by returning an exception containing a **ContextError** service context element. The **ContextError** element shall contain major and minor status codes indicating that the evidence was invalid.

If a request includes an authorization token but does not include an identity token, the TSS shall ensure that the access identity named in the authorization token is the same as the client authentication identity. If the request includes an identity token, the TSS shall ensure that the access identity is the same as the identity in the identity token. A TSS that supports authorization-token-based privilege attributes shall reject any request that does not satisfy this constraint and return an exception containing a **ContextError** service context element. The **ContextError** element shall contain major and minor status codes indicating that the evidence was invalid.

When a request includes an authorization token, it is the responsibility of the TSS to determine if the target trusts the authorities that signed the privileges in the token. A TSS that supports authorization-token-based privilege attributes shall reject any request with an authorization token that contains privilege information signed by an authority that is not trusted by the target. In this case, the TSS shall return an exception containing a **ContextError** service context element. The **ContextError** element shall contain major and minor status codes indicating that the evidence was invalid.

10.3.1.2 Legend for Request Principal Interpretations

This sub clause serves as a key to the invocation scenarios represented in Table 10.3 on page 139, Table 10.4 on page 140, and Table 10.5 on page 141. The three tables describe the interpretation of security context information arriving at a target object from a calling object, object 2, that may have been called by another object, object 1. The authentication identity of object 2, as seen by the target object, may have been established in the transport layer, or the SAS context layer, or both. If the authentication identity was established at the transport layer it is referred to as P2^A. If the authentication identity was established at the SAS context layer, it is referred to as P2^B. The authentication identity seen by object 2 when it is called by another object (that is, object 1) is referred to as P1, the authentication identity of object 1. No distinction is made between the transport and SAS layer authentication identities of object 1 as seen by object 2. Object 1 may also call object 2 anonymously.

P1 is also used to represent a non-anonymous identity that may be asserted by object 2 when it calls the target object. When object 2 calls the target object, it may include an asserted identity in the form of an identity token in its SAS layer context. The asserted identity may be the anonymous identity or, a non-anonymous identity (represented by P1). When object 2 asserts an identity to the target object, it may (or may not) establish proof of its own identity by authenticating at either or both of the transport (P2^A), or SAS (P2^B) layers. When the target object receives a request made with an asserted identity, the target object will determine if it trusts the client authentication identity (that of object 2, or P2) acting as proxy for the asserted identity (that of object 1, or P1).

When object 2 asserts a non-anonymous identity to the target object, it may include with its request a SAS layer authorization token containing PACs. Each PAC may include an attribute that assigns proxy to a collection of identities that are endorsed by the authority that created the PAC to assert the identity to which the privileges in the PAC apply. When the target object receives a request made with an asserted identity and an authorization token containing proxy rules, the target object will use the proxy rules to determine if it may trust the client authentication identity (P2^A or P2^B) as proxy for the asserted identity(P1).

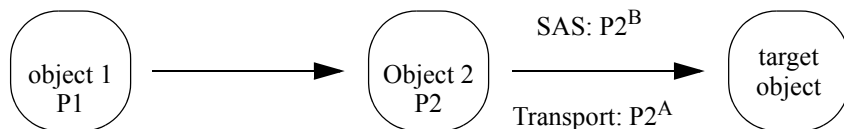

Figure 10.2 - Invocation Scenarios

10.3.1.3 Anonymous Identity Assertion

The anonymous identity is used to represent an unauthenticated entity. To assert an anonymous caller identity, a CSS (perhaps acting as an intermediate) shall include a SAS context element containing an **EstablishContext** message with an **identity_token** containing the anonymous **IdentityTokenType** in its request.

10.3.1.4 Presumed Trust

Presumed trust is a special case of the evaluation of identity assertions by a TSS. In presumed trust, a TSS accepts identity assertions based on the fact of their occurrence and without consideration of the authentication identity of the asserting entity. The presumption is that communications are constrained such that only trusted entities are capable of asserting an identity to the TSS.

10.3.1.5 Failed Trust Evaluations

Table 10.3 shows the circumstances under which the interpretation of caller credentials by a TSS results in a failed trust evaluation. None of these circumstances correspond to presumed trust, where trust evaluations are not performed (and therefore cannot fail).

Table 10.3 - Conditions under which Trust Evaluation Fails

Transport Client Principal	SAS Client Authentication Principal	SAS Identity Token Identity	Does Target Trust P2, or Is P2 Named as Proxy in Authorization Elements?
None	None	P1	Not Applicable
None	P2 ^B	P1	No (with respect to P2 ^B)
P2 ^A	None	P1	No (with respect to P2 ^A)
P2 ^A	P2 ^B	P1	No (with respect to P2 ^B)

A failed trust evaluation shall result in the request being rejected with an indication that client authentication failed.

10.3.1.6 Request Principal Interpretations

The entries in Table 10.4 describe the interpretation of client credentials by a TSS after an incoming call has satisfied the target's security requirements and has been validated by the TSS.

Table 10.4 - TSS Interpretation of Client Credentials After Validation

Transport Client Principal	SAS Client Authentication Principal	SAS Identity Token Identity	Client Principal is Trusted	Invocation Principal	Scenario
None	None	Absent	Not applicable	Anonymous	Unauthenticated
None	P2 ^B	Absent	Not applicable	P2	Client authentication
P2 ^A	None	Absent	Not applicable	P2	Client authentication
P2 ^A	P2 ^B (by rule 1 ^a)	Absent	Not applicable	P2 ^B	Client authentication
None	None	P1	Yes if rule 2 ^b	P1	identity assertion
None	P2 ^B	P1	Yes if rule 2 or rule 3 ^c	P1	identity assertion
P2 ^A	None	P1	Yes if rule 2 or rule 3	P1	identity assertion
P2 ^A	P2 ^B (by rule 1)	P1	Yes if rule 2 or rule 3	P1	identity assertion
None	None	Anonymous	Yes if rule 4 ^d	Anonymous	assertion of anonymous
None	P2 ^B	Anonymous	Yes if rule 4	Anonymous	assertion of anonymous
P2 ^A	None	Anonymous	Yes if rule 4	Anonymous	assertion of anonymous
P2 ^A	P2 ^B (by rule 1)	Anonymous	Yes if rule 4	Anonymous	assertion of anonymous
none	No SAS Message		Not Applicable	Anonymous	Unauthenticated
P2	No SAS Message		Not Applicable	P2	Client authentication

- a. Rule 1: TSS trusts P2^A to use authenticator for P2^B is implied by P2^B having been authenticated.
- b. Rule 2: TSS presumes trust in transport to accept None, P2^A, or P2^B speaking for P1.
- c. Rule 3: TSS trusts P2^A, or P2^B to speak for P1.
- d. Rule 4: TSS trusts None, P2^A, or P2^B to speak for Anonymous. A TSS shall support the configuration of rule 4, such that Anonymous identity assertions are accepted independent of authentication of the asserter.

The entries in Table 10.5 describe additional TSS interpretation rules to support delegation. These rules have been separated from those in Table 10.4 on page 140, because they describe functionality required of implementations that conform to a higher level of secure interoperability as defined in Conformance Level 2 on page 162. The entries in Table 10.5 correspond to invocations that carry an identity token and an authorization token with embedded delegation token (that is, a proxy endorsement attribute) in an EstablishContext service context element. Invocations that do not carry all of these tokens are represented in Table 10.4.

An authorization token may contain authorization elements that contain proxy statements, which endorse principals to proxy for other entities. Table 10.5 describes delegation scenarios in which endorsements from the issuer of the authorization element authorize the authenticated identity, which is P2^A or P2^B, to proxy for the asserted identity. In this table, the column "Proxies Named in Authorization Element" defines the identities who are endorsed by the authorization element to proxy for P1, the asserted identity and the subject of the authorization element. The value "Any" indicates that

the authorization element contains a blanket endorsement, such that as far as its issuer is concerned, any identity may proxy for P1. The outcomes described in Table 10.5 assume that the TSS trusts the issuer of the authorization element to endorse principals to proxy for others.

Table 10.5 - Additional TSS Rules to Support Delegation

Transport Client Principal	SAS Client Authentication Principal	SAS Identity Token Identity	Proxies Named in Authorization Element	Invocation Principal	Scenario
None	P2 ^B	P1	Any	P1	Delegation
P2 ^A	None	P1	Any	P1	Delegation
P2 ^A	P2 ^B	P1	Any	P1	Delegation
None	P2 ^B	P1	Restricted to set including P2 ^B	P1	Restricted delegation
P2 ^A	None	P1	Restricted to set including P2 ^A	P1	Restricted delegation
P2 ^A	P2 ^B	P1	Restricted to set including P2 ^B	P1	Restricted delegation

10.3.2 Session Semantics

This sub clause describes the negotiation of security contexts between a CSS and a TSS. A TSS is said to be stateless if it does not operate in the mode of accepting reusable (that is, stateful) security contexts. A TSS that accepts reusable security contexts is said to be stateful. A CSS is said to be stateless if it operates in the mode of establishing transient, non-reusable (that is, stateless) security contexts. A CSS that issues requests to establish reusable security contexts is said to be stateful.

10.3.2.1 Negotiation of Statefulness

A client initiates a stateless interaction by specifying a **client_context_id** of 0. A client issues a request to establish a stateful context by including a nonzero **client_context_id** in an **EstablishContext** message.

When a stateless TSS receives a request to establish a stateful session, the TSS shall attempt to validate the security tokens bound to the request. If the validation fails, an exception containing an appropriate **ContextError** service context element shall be returned to the client. If the validation succeeds, the TSS shall negotiate to stateless by responding with a **CompleteEstablishContext** message with **context_stateful** set to false.

A client that initiates a stateful interaction shall be capable of accepting that the target negotiated the context to stateless.

10.3.2.2 Stateful/Reusable Contexts

Each transport layer session defines a context identifier number *scope*. The CSS selects context identifiers for use within a scope.

A CSS may use the **EstablishContext** message to issue multiple concurrent requests to establish a stateful security context within a scope.

To avoid duplicate sessions, when the stateful **EstablishContext** requests sent within a scope carry equivalent security contexts, the CSS shall assign to them the same nonzero **client_context_id**.

Within a scope, a TSS shall reject any request to establish a stateful context that carries a different security context from an established context with the same **client_context_id**. In this case, an exception containing a **ContextError** service context element shall be returned to the caller.

Two security contexts are equivalent if all of the authentication, identity, and authorization tokens match both in existence and in value. Token values shall be evaluated for equivalence by comparing the corresponding byte sequences used to carry the tokens in **EstablishContext** messages.

When a target that supports stateful contexts receives a request to establish a stateful context, the TSS shall attempt to validate the security tokens in the **EstablishContext** element. If the validation succeeds, the request shall be accepted, and the reply (if there is one) shall carry a **CompleteEstablishContext** element that indicates (that is, **context_stateful** = true) that the context is available at the TSS for the caller's reuse. If the validation fails, an exception containing an appropriate **ContextError** service context element shall be returned to the caller.

A TSS that accepts stateful contexts shall bear the responsibility for managing the lifecycle of these sessions. Clients that reuse stateful contexts shall be capable of processing replies that indicate that an established stateful context has been unilaterally discarded by the TSS.

A TSS shall not establish a stateful context in response to a request to establish a stateless context (that is, one with a **client_context_id** of zero).

A TSS that supports stateful contexts may negotiate a request to establish a stateful context to a stateless context in order to preserve resources. It may do so only if it does not already have an established matching stateful context.

Conversely, a stateful TSS that has negotiated a request to stateless may respond statefully to a subsequent context with the same (non-zero) **client_context_id**.

10.3.2.2.1 Relationship to Transport-Layer

A SAS context shall not persist beyond the lifetime of the transport-layer secure association over which it was established.

Stateful SAS contexts are not compatible with transports that do not make the relationship between the connection and the association transparent.

10.3.3 TSS State Machine

The TSS state machine is defined in the state diagram, Figure 10.3 on page 143 and in the TSS state table, Table 10.6 on page 144. Each TSS call thread shall operate independently with respect to this state machine. Where necessary, thread synchronization at shared state shall be handled in the actions called by this state machine.

An ORB must not invoke the TSS state machine if the target object does not exist at the ORB. The TSS state machine has no capacity to reject or forward⁸ a request because the target object does not exist, and must rely on the ORB to only invoke the TSS when the target object exists at the ORB.

In response to a one-way call, a TSS shall not perform any of the send actions described by the state machine.

The shaded rows in Table 10.6 on page 144 indicate transitions and states that do not exist in a stateless implementation of the SAS protocol.

The state names, function names, and function signatures that appear in the state diagram and the state table are not prescriptive.

8. A TSS uses the **LOCATION_FORWARD** status to return an IOR containing up-to-date security mechanism configuration for an existing object.

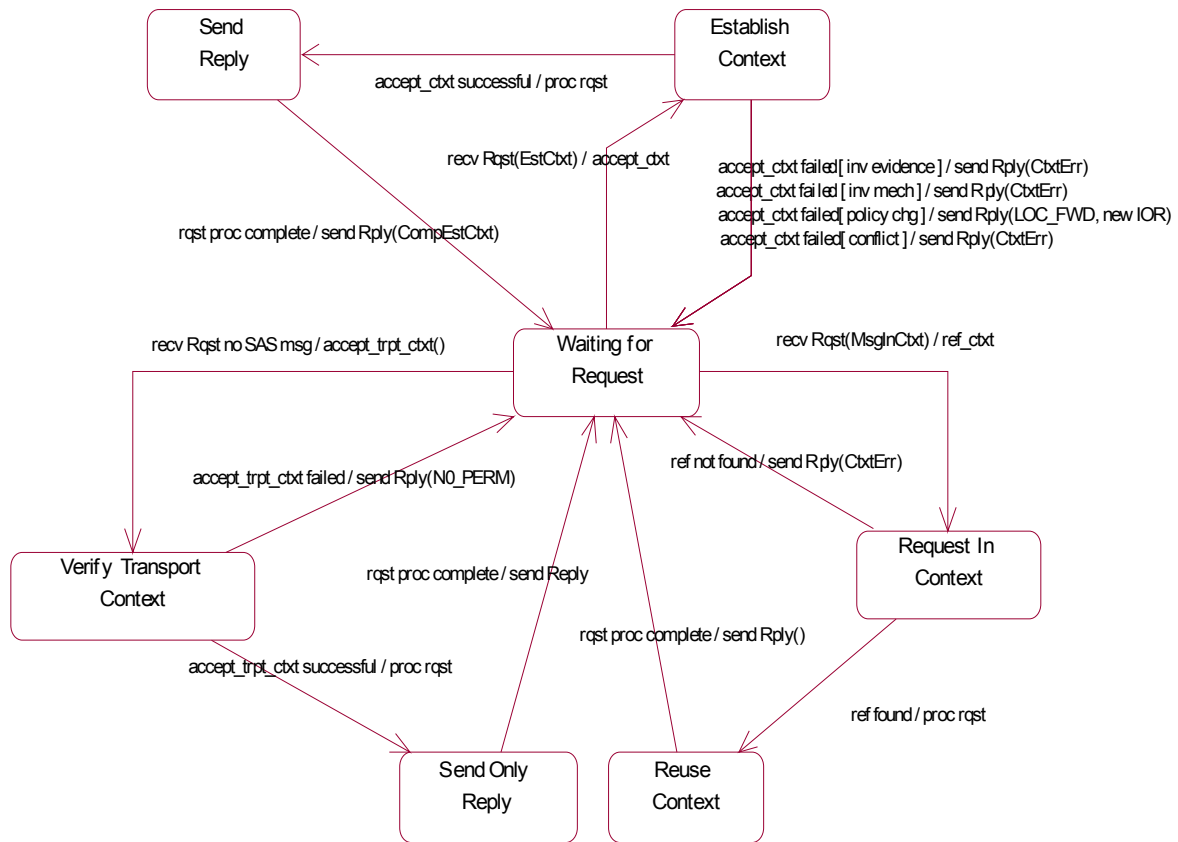

Figure 10.3 - TSS State Machine

Table 10.6 -TSS State Table

	State	Event	Action	New State
1	Waiting for Request	receive request without SAS message	accept_transport_context()	Verify Transport Context
		receive Request + EstablishContext {client_context_id = N, tokens}	accept_context(tokens, N, Out stateful)	Establish Context
		receive Request + MessageInContext {client_context_id = N, discard_context = D}	reference_context(N)	Request In Context
2	Verify Transport Context	accept_transport_context() returned success	process request	Send Only Reply
		accept_transport_context() returned failure	send exception (NO_PERMISSION)	Waiting for Request
3	Send Only Reply	request processing completed	send Reply	Waiting for Request
4	Send Reply	request processing completed	send Reply + CompleteEstablishContext { N, stateful}	Waiting For Request
5	Establish Context	accept_context (tokens, N, Out stateful) returned success	process request	Send Reply
		accept_context (tokens, N, Out stateful) returned failure (invalid evidence)	send exception + ContextError (invalid evidence)	Waiting for Request
		accept_context (tokens, N, Out stateful) returned failure (invalid mechanism)	send exception + ContextError (invalid mechanism)	Waiting for Request
		accept_context (tokens, N, Out stateful) returned failure (policy change)	send Reply + LOCATION_FORWARD status + updated IOR	Waiting for Request
		accept_context (tokens, N, Out stateful) returned failure (conflicting evidence)	send exception + ContextError (conflicting evidence)	Waiting for Request
6	Request in Context	reference_context(N) returned reference	process request	Reuse Context
		reference_context(N) returned empty reference	send exception + ContextError (context does not exist)	Waiting for Request
7	Reuse Context	request processing completed	send Reply if (D) discard_context(N)	Waiting for Request

10.3.3.1 TSS State Machine Actions

This sub clause defines the intended semantics of the actions appearing in the TSS state machine. As noted above, the function names and function signatures are not prescriptive.

- **accept_context** (tokens, N, Out stateful)
 This action validates the security context captured in the tokens including ensuring that they are compatible with the mechanisms supported by the target object. If a context is not validated, **accept_context** returns error codes that describe the reason the context was rejected.

When called by a stateless TSS, **accept_context** always returns false in the output argument “**stateful.**”
 When called by a stateful TSS, **accept_context** may (depending on the effective policy of the target object) attempt to record state corresponding to the context. If state for the identified context already exists and the

received tokens are not equivalent to those captured in the existing context, **accept_context** shall reject the context. If the context state either already existed, or was recorded, **accept_context** returns true in the output argument “**stateful**.” An implementation of **accept_context** shall implement the error semantics defined in the following table.

Table 10.7- Accept Context Error Semantics

Semantic	Returned Error Code
Tokens match mechanism definition of target object but could not be validated.	Invalid evidence
Context has non-zero client_context_id that matches that of an exiting context but tokens are not equivalent to those used to establish the existing context.	Conflicting evidence
The mechanism configuration of the target object has changed and request indicates that CSS is not aware of the current mechanism configuration.	Policy change
The mechanism configuration of the target object has not changed, and request is not consistent with target mechanism configuration.	Invalid mechanism

When **accept_context** returns any of **Invalid evidence**, **Conflicting evidence**, or **Invalid mechanism** the TSS shall reject the request and send a **NO_PERMISSION** exception containing a **ContextError** service context element with error codes as defined in Table 10.9 on page 149. When **accept_context** returns **Policy change**, the TSS action shall reject the request and return a reply with status **LOCATION_FORWARD** and containing a new IOR for the target object that contains an up-to-date representation of the target’s security mechanism configuration.

- **accept_transport_context()**
This action validates that a request that arrives without a SAS protocol message; that is, **EstablishContext** or **MessageInContext** satisfies the CSIV2 security requirements of the target object. This routine returns true if the transport layer security context (including none) over which the request was delivered satisfies the security requirements of the target object. Otherwise, **accept_transport_context** returns false. When **accept_transport_context** returns false, the TSS shall reject the request and send a **NO_PERMISSION** exception.
- **reference_context (N)**
If there is an existing context with **client_context_id = N**, **reference_context** returns a reference to it. Otherwise, **reference_context** returns an empty reference.
- **discard_context (N)**
If context **N** exists and it is not needed to complete the processing of another thread, **discard_context** causes the context to be deleted.

10.3.4 CSS State Machine

A proposed implementation of the CSS state machine is defined in the state diagram, Figure 10.4 on page 146, and in the CSS state table, Table 10.8 on page 147. Each CSS call thread shall operate independently with respect to this state machine. Where necessary, thread synchronization at shared state shall be handled in the actions called by this state machine.

When a CSS processes a one-way call, it returns to the caller and sets its next state to done, as no response will be sent by the TSS. The shaded rows in the state table indicate transitions and states that need not exist in a stateless CSS client side implementation.

The state names, function names, and function signatures that appear in the state diagram and state table are not prescriptive.

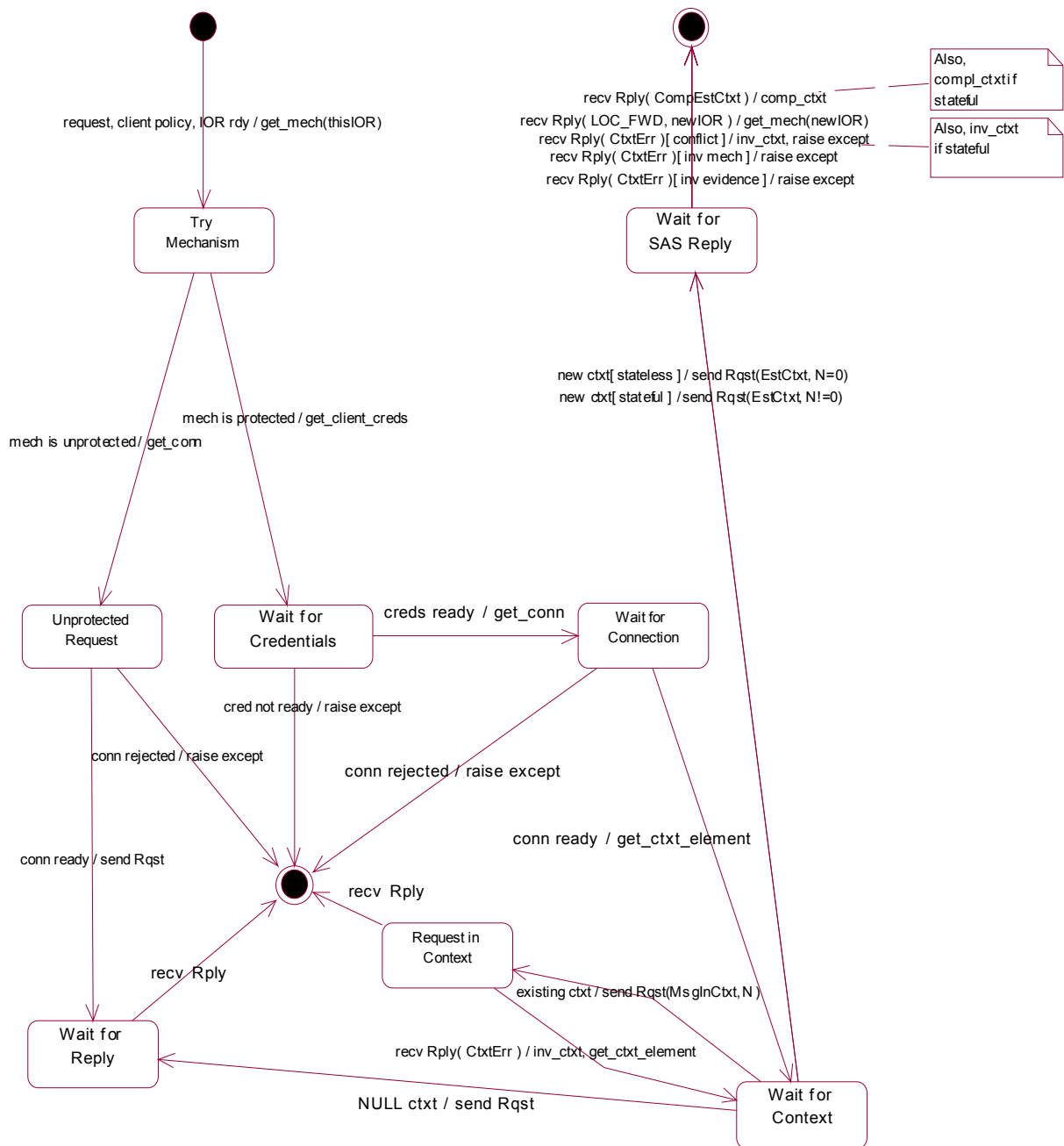

Figure 10.4 - CSS State Machine

Table 10.8 - CSS State Table

	State	Event	Action	New State
1	start	Request + client policy + IOR ready to send	get_mechanism (policy, thisIOR, Out mech)	Try Mechanism
2	Try Mechanism	the selected mechanism is unprotected	get_connection (mech, Out c)	Unprotected Request
		the selected mechanism is protected	get_client_creds (policy, mech, Out creds)	Wait for Credentials
3	Unprotected Request	connection ready	send request	Wait for Reply
		connection rejected	raise exception and return to caller ^a	done
4	Wait for Reply	receive reply	return to caller	done
5	Wait for Credentials	client credentials ready	get_connection (policy, mech, creds, Out c)	Wait for Connection
		necessary credentials not obtained	raise exception and return to caller ^b	done
6	Wait for Connection	connection ready	get_context_element (c, policy, creds, mech, Out element)	Wait for Context
		connection rejected	raise exception and return to caller ^c	done
7	Wait for Context	get_context_element returned EstablishContext {N = 0, tokens}	send Request + EstablishContext {client_context_id = N = 0, tokens}	Wait for SAS Reply
		get_context_element returned EstablishContext {N != 0, tokens}	send Request + EstablishContext {client_context_id = N != 0, tokens}	Wait for SAS Reply
		get_context_element returned NULL	send request	Wait for Reply
		get_context_element returned MessageInContext {N != 0, D}	send Request + MessageInContext {client_context_id = N != 0, D}	Request In Context
8	Wait for SAS Reply	receive exception + ContextError (invalid evidence)	raise exception and return to caller ^d	done
		receive exception + ContextError (invalid mechanism)	raise exception and return to caller	done
		receive exception + ContextError (conflicting evidence)	invalidate_context (c, N)	done
			raise exception and return to caller	
		receive Reply + LOCATION_FORWARD status + updated IOR	return to caller	done
receive Reply + CompleteEstablishContext {N, context_stateful}	complete_context (c, N, context_stateful)	done		
	return to caller			
9	Request in Context	receive exception + ContextError (context does not exist)	invalidate_context (c, N) get_context_element (c, policy, creds, mech, Out element)	Wait for Context
		receive Reply	return to caller	done

- a. A CSS may do next mechanism processing, in which case it might call get_next_mechanism(policy,thisIOR) and transition to state Try Mechanism.
- b. Same note as 1.
- c. Same note as 1.
- d. A CSS may re-collect authentication evidence and try again, in which case it might call get_client_creds(policy, mech, Out creds) and transition to state Wait for Credentials.

10.3.4.1 CSS State Machine Actions

This sub clause defines the intended semantics of the actions appearing in the CSS state machine. As noted above the function names and function signatures are not prescriptive. The descriptions appearing in the following sub clauses are provided to facilitate understanding of the proposed implementation of the CSS state machine.

- **get_mechanism** (policy, IOR, Out mech)
Select from the **IOR** a **mechanism** definition that satisfies the client policy.
- **get_client_creds** (policy, mech, Out creds)
Get the client **credentials** as necessary to satisfy the client **policy** and the target policy in the **mechanism**.
- **get_connection** (mech, Out c)
Open a connection based on the port information in the **mechanism** argument.
- **get_connection** (policy, mech, creds, Out c)
Open a secure connection based on the client **policy**, the target policy in the **mechanism** argument, and using the client credentials in the **creds** argument.
- **get_context_element** (c, policy, creds, mech, Out element)
In the scope of connection **c**, use the client **creds** to create a SAS protocol context element that satisfies the client **policy** and the target policy in the **mechanism**. If the CSS supports reusable contexts, and the client policy is to establish a reusable context, the CSS allocates a **client_context_id**, and initializes a context element in the context table of the connection. A NULL context element may be returned by **get_context_element** when the target mechanism definition either does not support or require SAS layer security functionality, and the client establishes a policy not to use such functionality unless required to do so.
- **invalidate_context** (c, N)
Mark context **N** in connection scope **c** as invalid such that no more requests may (re)use it.
- **complete_context** (c, N, context_stateful)
This action applies the contents of a returned **CompleteEstablishContext** message to context **N**, in connection scope **c**, to change its state to completed. In a stateful CSS, **get_context_element** will not return a **MessageInContext** element until **complete_context** is called with **context_stateful** true.

10.3.5 ContextError Values and Exceptions

Table 10.9 defines the circumstances under which error values and exceptions shall be returned by a TSS. The state and event columns contain states and events appearing in Table 10.6.

Table 10.9- ContextError Codes and Exceptions

State	Event	Semantic	Major	Minor	Exception
Establish Context	accept_context returned failure	Invalid evidence	1	1	NO_PERMISSION
		Invalid mechanism	2	1	NO_PERMISSION
		Conflicting evidence	3	1	NO_PERMISSION
Request In Context	reference_context (N) returned false	No Context	4	1	NO_PERMISSION

10.4 Transport Security Mechanisms

10.4.1 Transport Layer Interoperability

The secure interoperability architecture that is defined by this specification partitions secure interoperability into three layers: the transport layer, authentication above the transport layer, and the secure attribute layer. This specification defines secure interoperability that uses transport-layer security for message protection and authentication of the target to the client.

10.4.2 Transport Mechanism Configuration

The configuration of transport-layer security mechanisms is specified in IORs. Support for CSI is indicated within an IOR profile by the presence of at most one **TAG_CSI_SEC_MECH_LIST** tagged component that defines the mechanism configuration pertaining to the profile. This component contains a list of one or more **CompoundSecMech** structures, each of which defines the layer-specific security mechanisms that comprise a compound mechanism that is supported by the target. This specification does not define support for CSI mechanisms in multiple-component IOR profiles.

Each **CompoundSecMech** structure contains a **transport_mech** field that defines the transport-layer security mechanism of the compound mechanism. A compound mechanism that does not implement security functionality at the transport layer shall contain the **TAG_NULL_TAG** component in its **transport_mech** field. Otherwise, the **transport_mech** field shall contain a tagged component that defines a transport protocol and its configuration. **TAG_TLS_SEC_TRANS** on page 152 and **TAG_SECIOF_SEC_TRANS** on page 154 define valid transport-layer components that can be used in the **transport_mech** field.

10.4.2.1 Recommended SSL/TLS Ciphersuites

This specification recommends that implementations support the following ciphersuites in addition to the mandatory ciphersuites identified in [IETF RFC 2246]. Of these additional ciphersuites, those which use weak encryption keys are only recommended for use in environments where strong encryption of SAS protocol elements (including GSSUP authenticators) and request arguments is not required. Some of the recommended ciphersuites are known to be encumbered by licensing constraints.

- TLS_RSA_WITH_RC4_128_MD5
- SSL_RSA_WITH_RC4_128_MD5
- TLS_DHE_DSS_WITH_DES_CBC_SHA
- SSL_DHE_DSS_WITH_DES_CBC_SHA
- TLS_RSA_EXPORT_WITH_RC4_40_MD5

- SSL_RSA_EXPORT_WITH_RC4_40_MD5
- TLS_DHE_DSS_EXPORT_WITH_DES40_CBC_SHA
- SSL_DHE_DSS_EXPORT_WITH_DES40_CBC_SHA

10.5 Interoperable Object References

10.5.1 Target Security Configuration

A target that supports unprotected IIOP invocations shall specify in the corresponding **TAG_INTERNET_IOP** profile a nonzero port number at which the target will accept unprotected invocations.⁹ A target that supports only protected IIOP invocations shall specify a port number of 0 (zero) in the corresponding **TAG_INTERNET_IOP** profile. A target may support both protected and unprotected IIOP invocations at the same port, but it is not required to do so.

```

struct IOR {
  string type_id;
  sequence <TaggedProfile> profiles = {
    ProfileId tag = TAG_INTERNET_IOP;
    struct ProfileBody_1_1 profile_data = {
      Version iiop_version;
      string host;
      unsigned short port;
      sequence <octet> object_key;
      sequence <IOP::TaggedComponent> components;
    };
  };
};

```

A target that supports protected invocations shall describe in a **CompoundSecMech** structure the characteristics of each of the alternative compound security mechanisms that it supports. The **CompoundSecMech** structure shall be included in a list of such structures in the body of a **TAG_CSI_SEC_MECH_LIST** tagged component.

```

sequence <IOP::TaggedComponent> components = {
  IOP::TaggedComponent {
    ComponentId tag = TAG_CSI_SEC_MECH_LIST;
    sequence <octet> component_data = {
      CSIOP::CompoundSecMechList = {
        boolean stateful;
        CompoundSecMechanisms mechanism_list = {
          CompoundSecMech;
        };
      };
    };
  };
};

```

9. The OMG has registered port numbers for IIOP (683) and IIOP/SSL (684) with IANA. Although the existence of these reservations does not prescribe their use, it may be useful to recognize these port numbers as defaults for the corresponding protocols.

The order of occurrence of the alternative compound mechanism definitions in a **TAG_CSI_SEC_MECH_LIST** component indicates the target's mechanism preference. The target prefers mechanism definitions occurring earlier in the list. An IOR profile shall contain at most one **TAG_CSI_SEC_MECH_LIST** tagged component. An IOR profile that contains multiple **TAG_CSI_SEC_MECH_LIST** tagged components is malformed and should be rejected by a client implementation.

10.5.1.1 AssociationOptions Type

The **AssociationOptions** type is an unsigned short bit mask containing the logical OR of the configured options. The properties of security mechanisms are defined in an IOR in terms of the association options supported and required by the target. A CSS shall be able to interpret the association options defined in Table 10.10.

Table 10.10 - Association Options

Association Option	target_supports	target_requires
Integrity	Target supports integrity protected messages	Target requires integrity protected messages .
Confidentiality	Target supports privacy protected messages	Target requires privacy protected messages.
EstablishTrustInTarget	Target can authenticate to a client	Not applicable. This bit should never be set, and should be ignored by CSS.
EstablishTrustInClient	Target can authenticate a client	Target requires client authentication.
IdentityAssertion	Target accepts asserted caller identities based on trust in the authentication identity of the asserting entity. Target can evaluate trust based on trust rules of the target. If DelegationByClient is set, target can also evaluate trust when provided with a delegation token (that is, a proxy attribute contained in an authorization token). ^a	Not applicable. This bit should never be set, and should be ignored by CSS.
DelegationByClient	When it occurs in conjunction with support for IdentityAssertion, this bit indicates that target can evaluate trust in an asserting entity based on a delegation token. ^b	Target requires that CSS provide a delegation token that endorses the target as proxy for the client. ^c

- a. A target policy that accepts only identity assertions based on forward trust cannot be communicated in an IOR (although it can be enforced).
- b. If an incoming request includes an identity token and a delegation token, the request shall be rejected if the delegation token does not endorse the asserting entity (see Section 10.3.1.1, Context Validation, on page 137)
- c. A target with DelegationByClient set in **target_requires** shall also have this bit set in **target_supports**. As noted in the table, this has an impact on the target's identity assertion policy (if any).

The representation of supported options is used by a client to determine if a mechanism is capable of supporting the client's security requirements. The supported association options shall be a superset of those required by the target.

When the **IdentityAssertion** bit is set in **target_supports**, it indicates that the target accepts asserted caller identities based on trust in the authentication identity of the asserting entity. When the **DelegationByClient** bit is not set, the target will evaluate trust based on rules of the target (that is, a backward trust evaluation). When the **IdentityAssertion** and **DelegationByClient** bits are set, they indicate that the target is also capable of evaluating trust in an asserting entity based on trust rules delivered in an authorization token (that is, a forward trust evaluation). A target that can perform a forward trust evaluation does so when trust rules are delivered in an authorization token. Otherwise a backward trust evaluation is performed.

When the **DelegationByClient** bit is set in **target_requires**, it indicates that the target requires a delegation token to complete the processing of a request. Such circumstances will occur when a target, acting as an intermediate, attempts to issue a request as its caller and sanctioned by the delegation token delivered by its caller.

The rules for interpreting asserted identities in the presence or absence of a delegation token (that is, a proxy attribute contained in an authorization token) are as defined in Context Validation on page 137.

The security mechanism configuration in an IOR being used by a CSS may (as the result of target policy administration) no longer represent the actual security mechanism configuration of the target object.

10.5.1.1.1 Alternative Transport Association Options

Implementations that choose to employ the service context protocol defined in this specification to achieve interoperability over an alternative secure transport (one other than SSL/TLS) may also be required to support the message protection options defined in Table 10.11.

Table 10.11 - Alternative Transport Association Options

Association Option	target_supports	target_requires
DetectReplay	Target can detect replay of requests (and request fragments).	Target requires security associations to detect replay.
DetectMisordering	Target can detect sequence errors of request (and request fragments).	Target requires security associations to detect message sequence errors.

10.5.1.2 Transport Address

The TransportAddress structure indicates an INTERNET address where the TSS is listening for connection requests.

```
struct TransportAddress {
    string host_name;
    unsigned short port;
};
```

```
typedef sequence <TransportAddress> TransportAddressList;
```

The **host_name** field identifies the Internet host to which connection requests will be made. The **host_name** field shall not contain an empty string. The **host_name** field shall contain a host name or an IP address in standard numerical address (e.g., dotted-decimal) form.

The **port** field contains the TCP/IP port number (at the specified host) where the TSS is listening for connection requests. The port number shall not be zero.

10.5.1.3 TAG_TLS_SEC_TRANS

An instance of the **TAG_TLS_SEC_TRANS** component may occur in the **transport_mech** field within a **CompoundSecMech** structure in a **TAG_CSI_SEC_MECH_LIST** component.

When an instance of the **TAG_TLS_SEC_TRANS** component occurs in the **transport_mech** field of the **CompoundSecMech** structure, it defines the sequence of transport addresses at which the target will be listening for SSL/TLS protected invocations. The supported (**target_supports**) and required (**target_requires**) association options defined in the component shall define the transport level security characteristics of the target at the given addresses.

```
const IOP::ComponentId TAG_TLS_SEC_TRANS = 36;
```

```
struct TLS_SEC_TRANS {
    AssociationOptions target_supports;
    AssociationOptions target_requires;
    TransportAddressList addresses;
};
```

The **addresses** field provides a shorthand for defining multiple security mechanisms that differ only in their transport addresses. The **addresses** field shall contain at least one address.

Table 10.12, Table 10.13, Table 10.14, and Table 10.15 describe the association option semantics relating to the **TAG_TLS_SEC_TRANS** tagged component that shall be interpreted by a CSS and enforced by a TSS. The **IdentityAssertion** and **DelegationByClient** association options shall not occur in an instance of this component.

Table 10.12 - Integrity Semantics

Integrity	Semantic
Not supported	None of the ciphersuites supported by the target designate a MAC algorithm.
Supported	Target supports one or more ciphersuites that designate a MAC algorithm.
Required	All the ciphersuites supported by the target designate a MAC algorithm.

Table 10.13 - Confidentiality Semantics

Confidentiality	Semantic
Not supported	None of the ciphersuites supported by the target designate a bulk encryption algorithm ^a .
Supported	Target supports one or more ciphersuites that designate a bulk encryption algorithm.
Required	All the ciphersuites supported by the target designate a bulk encryption algorithm.

a. Bulk encryption algorithms include both block and stream ciphers.

Table 10.14 - EstablishTrustInTarget Semantics

EstablishTrustInTarget	Semantic
Not supported	None of the ciphersuites supported by the target designate a key exchange algorithm that will authenticate the target to the client.
Supported	Target supports one or more ciphersuites that designate a key exchange algorithm that will authenticate the target to the client.
Required	Not applicable. This bit should never be set, and should be ignored by CSS.

Table 10.15 - EstablishTrustInClient Semantics

EstablishTrustInClient	Semantic
Not supported	Target does not support client authentication during the handshake. Moreover, target provides no opportunity for client to authenticate in the handshake (that is, target does not send certificate request message).
Supported	Target provides client with an opportunity to authenticate in handshake. Target will accept connection if client does not authenticate.
Required	Target accepts connections only from clients who successfully authenticate in the handshake.

10.5.1.4 TAG_SECIOP_SEC_TRANS

A tagged component with the **TAG_SECIOP_SEC_TRANS** tag is a valid component for the **transport_mech** field of the **CompoundSecMech** structure. The presence of this component indicates the generic use of the SECIOP protocol as a secure transport underneath the CSI mechanisms. A component tagged with this value shall contain the CDR encoding of the **SECIOP_SEC_TRANS** structure.

The **SECIOP_SEC_TRANS** structure defines the transport addresses for SECIOP messages, the association options pertaining to the particular GSS mechanism being supported, the GSS mechanism identifier, and the target's GSS exported name.

```
const IOP::ComponentId TAG_SECIOP_SEC_TRANS = 35;
```

```
struct SECIOP_SEC_TRANS {
    AssociationOptions target_supports;
    AssociationOptions target_requires;
    CSI::OID mech_oid;
    CSI::GSS_NT_ExportedName target_name;
    TransportAddressList addresses;
};
```

The **addresses** field provides a shorthand for defining multiple security mechanisms that differ only in their transport addresses. The **addresses** field shall contain at least one address.

Table 10.12, Table 10.13, Table 10.14, and Table 10.15 also describe the association option semantics relating to the **TAG_SECIOP_SEC_TRANS** tagged component that shall be interpreted by a CSS and enforced by a TSS.

10.5.1.5 TAG_CSI_SEC_MECH_LIST

This new tagged component, **TAG_CSI_SEC_MECH_LIST**, is used to describe support in the target for a sequence of one or more compound security mechanisms represented in the **mechanism_list** field of a **CompoundSecMechList** structure. The mechanism descriptions in the **mechanism_list** occur in decreasing order of target preference.

```
const IOP::ComponentId TAG_CSI_SEC_MECH_LIST = 33;
```

```
struct CompoundSecMech {
    AssociationOptions target_requires;
    IOP::TaggedComponent transport_mech;
    AS_ContextSec as_context_mech;
    SAS_ContextSec sas_context_mech;
};
```

```
typedef sequence <CompoundSecMech> CompoundSecMechanisms;
```

```
struct CompoundSecMechList {
    boolean stateful;
    CompoundSecMechanisms mechanism_list;
};
```

The **CompoundSecMech** structure is used to describe support in the target for a compound security mechanism that may include security functionality that is realized in the transport and/or security functionality realized above the transport in service context. Where a compound security mechanism implements security functionality in the transport

layer, the transport functionality shall be represented in a transport-specific component (for example, **TAG_TLS_SEC_TRANS**) contained in the **transport_mech** field of the **CompoundSecMech** structure. Where a compound security mechanism implements client authentication functionality in service context, the mechanism shall be represented in an **AS_ContextSec** structure contained in the **as_context_mech** field of the **CompoundSecMech** structure. Where a compound security mechanism supports identity assertion or supports authorization attributes delivered in service context, the mechanism shall be represented in a **SAS_ContextSec** structure contained in the **sas_context_mech** field of the **CompoundSecMech** structure.

At least one of the **transport_mech**, **as_context_mech**, or **sas_context_mech** fields shall be configured. The **TAG_NULL_TAG** component shall be used in the **transport_mech** field to indicate that a mechanism does not implement security functionality at the transport layer. A value of “no bits set” in the **target_supports** field of either the **as_context_mech** or **sas_context_mech** fields shall be used to indicate that the mechanism does not implement security functionality at the corresponding layer.

The **target_requires** field of the **CompoundSecMech** structure is used to designate a required outcome that shall be satisfied by one or more supporting (but not requiring) layers. The **target_requires** field also represents all the options required independently by the various layers as defined within the mechanism.

Each compound mechanism defines a combination of layer-specific functionality that is supported by the target. A target’s mechanism configuration is the sum of the combinations defined in the individual mechanisms.

A value of TRUE in the **stateful** field of the **CompoundSecMechList** structure indicates that the target supports the establishment of stateful or reusable SAS contexts. This field is provided to assist clients in their selection of a target that supports stateful contexts. It is also provided to sustain implementations that serialize stateful context establishment on the client side as a means to conserve precious server-side authentication capacity.¹⁰

A TSS shall set the **stateful** bit to FALSE in the **CompoundSecMechList** structure of IORs corresponding to target objects at which it will not accept reusable security contexts.

10.5.1.5.1 struct AS_ContextSec

The **AS_ContextSec** structure is used in the **as_context_mech** field within a **CompoundSecMech** structure in a **TAG_CSI_SEC_MECH_LIST** component to describe the client authentication functionality that the target expects to be layered above the transport in service context by means of the **client_authentication_token** of the **EstablishContext** element of the SAS protocol.

```
struct AS_ContextSec{
    AssociationOptions target_supports;
    AssociationOptions target_requires;
    CSI::OID client_authentication_mech;
    CSI::GSS_NT_ExportedName target_name;
};
```

A value of “no bits set” in the **target_supports** field indicates that the mechanism does not implement client authentication functionality above the transport in service context. In this case, the values present in any of the other fields in this structure are irrelevant.

10. This serialization is only done when an attempt is being made to establish a stateful context.

If the **target_supports** field indicates that the mechanism supports client authentication in service context, then the **client_authentication_mech** field shall contain a GSS OID that identifies the GSS mechanism that the compound mechanism supports for client authentication above the transport.

The target uses the **target_name** field to make its security name and or authentication domain available to clients. This information may be required by the client to obtain or construct (depending on the mechanism) a suitable initial context token.

Table 10.16 describes the association options that are supported by conforming implementations.

Table 10.16 - EstablishTrustInClient Semantics

	EstablishTrustInClient	Semantic
1	Not supported	Target does not support client authentication in service context (at this compound mechanism).
2	Supported	Target supports client authentication in service context. If a CSS does not send an initial context token (in an EstablishContext service context element), then the caller identity is obtained from the transport.
3	Required	Target requires client authentication in service context. The CSS may have also authenticated in the transport, but the caller identity is obtained from the service context layer.

When a compound mechanism that implements client authentication functionality above the transport also contains a transport mechanism (in the **transport_mech** field), any required association options configured in the transport component shall be interpreted as a prerequisite to satisfying the requirements of the client authentication mechanism.

struct SAS_ContextSec

The **SAS_ContextSec** structure is used in the **sas_context_mech** field within a **CompoundSecMech** structure in a **TAG_CSI_SEC_MECH_LIST** component to describe the security functionality that the target expects to be layered above the transport in service context by means of the **identity_token** and **authorization_token** of the **EstablishContext** element of the SAS service context protocol. The security functionality represented by this structure is configured as association options in the **target_supports** and **target_requires** fields.

// The high order 20-bits of each ServiceConfigurationSyntax constant shall contain the Vendor Minor Codeset ID (VMCID) of the organization that defined the syntax. The low order 12 bits shall contain the organization-scoped syntax identifier. The high-order 20 bits of all syntaxes defined by the OMG shall contain the VMCID allocated to the OMG (that is, 0x4F4D0).

```
typedef unsigned long ServiceConfigurationSyntax;
```

```
const ServiceConfigurationSyntax SCS_GeneralNames = CSI::OMGVMCID | 0;
const ServiceConfigurationSyntax SCS_GSSExportedName = CSI::OMGVMCID | 1;
```

```
typedef sequence <octet> ServiceSpecificName;
```

// The name field of the ServiceConfiguration structure identifies a privilege authority in the format identified in the syntax field. If the syntax is SCS_GeneralNames, the name field contains an ASN.1 (BER) SEQUENCE[1..MAX] OF GeneralName, as defined by the type GeneralNames in [IETF RFC 2459]. If the syntax is SCS_GSSExportedName, the name field contains a GSS exported name encoded according to the rules in [IETF RFC 2743] 3.2, "Mechanism-Independent Exported Name Object Format," p. 84.

```

struct ServiceConfiguration {
    ServiceConfigurationSyntax syntax;
    ServiceSpecificName name;
};

typedef sequence <ServiceConfiguration> ServiceConfigurationList;

struct SAS_ContextSec{
    AssociationOptions target_supports;
    AssociationOptions target_requires;
    ServiceConfigurationList privilege_authorities;
    CSI::OIDList supported_naming_mechanisms;
    CSI::IdentityTokenType supported_identity_types;
};

```

The **privilege_authorities** field contains a sequence of zero or more **ServiceConfiguration** elements. A non-empty sequence indicates that the target supports the CSS delivery of an **AuthorizationToken**, which is delivered in the **EstablishContext** message. A CSS shall not be required to look beyond the first element of this sequence unless required by the first element.

The **syntax** field within the **ServiceConfiguration** element identifies the format used to represent the authority. Two alternative formats are currently defined: an ASN.1 encoding of the **GeneralNames** (as defined in [IETF RFC 2459]) which identify a privilege authority, or a GSS exported name (as defined in [IETF RFC 2743] 3.2) encoding of the name of a privilege authority.

The high order 20-bits of each **ServiceConfigurationSyntax** constant shall contain the Vendor Minor Codeset ID (VMCID) of the organization that defined the **syntax**. The low order 12 bits shall contain the organization-scoped syntax identifier. The high-order 20 bits of all syntaxes defined by the OMG shall contain the VMCID allocated to the OMG (that is, 0x4F4D0).

Organizations must register their VMCIDs with the OMG before using them to define a **ServiceConfigurationSyntax**.

The **supported_naming_mechanisms** field contains a list of GSS mechanism OIDs. A TSS shall set the value of this field to contain the GSS mechanism OIDs for which the target supports identity assertions using an identity token of type **ITTPPrincipalName**. The Identity token types are defined in Identity Token Format on page 135.

The value of the **supported_identity_types** field shall be the bitmapped representation of the set of identity token types supported by the target. A target always supports ITTAbsent.

The value in **supported_identity_types** shall be non-zero if and only if the **IdentityAssertion** bit is non-zero in target_supports. The bit corresponding to the **ITTPPrincipalName** identity token type shall be non-zero in **supported_identity_types** if and only if the value in **supported_naming_mechanisms** contains at least one element.

Table 10.17 describes the combinations of association options that are supported by conforming implementations. Each combination in the table describes the attribute layer functionality of a target that may be defined in a mechanism definition. A target that defines multiple mechanisms may support multiple combinations.

A compound mechanism definition with the **DelegationByClient** bit set shall include the name of at least one authority in the **privilege_authorities** field.

When a compound mechanism configuration that defines SAS attribute layer functionality also defines client authentication layer or transport layer functionality, any required association options configured in these other layers shall be interpreted as a prerequisite to satisfying the requirements of the functionality defined in the attribute layer

Table 10.17 - Attribute Layer Association Option Combinations

	DelegationByClient	IdentityAssertion	Semantic
1	Not supported	Not supported	Target does not support identity assertion (that is, identity tokens in the EstablishContext message of the SAS protocol). The caller identity will be obtained from the authentication layer(s).
2	Not supported	Supported	Target evaluates asserted caller identities based on trust rules of the target. In the absence of an asserted identity, the caller identity will be obtained from the authentication layer(s).
3	Supported	Not supported	Target accepts delegation tokens that indicate who has been endorsed to assert an identity. Target does not accept asserted caller identities. The caller identity will be obtained from the authentication layer(s).
4	Supported	Supported	Target accepts delegation tokens that indicate who has been endorsed to assert an identity. Target evaluates asserted caller identities based on trust rules of the target or based on endorsements in a delegation token. In the absence of an asserted identity, the caller identity will be obtained from the authentication layer(s).
5	Required	Not supported	Same as 3, with the addition that target requires a delegation token that endorses the target as proxy for the calle.
6	Required	Supported	Same as 4, with the addition that target requires a delegation token that endorses the target as proxy for the caller.

10.5.1.6 TAG_NULL_TAG

This new tagged component is used in the **transport_mech** field of a **CompoundSecMech** structure to indicate that the compound mechanism does not implement security functionality at the transport layer.

```
// The body of the TAG_NULL_TAG component is a sequence of octets of
// length 0.
const IOP::ComponentId TAG_NULL_TAG = 34;
```

10.5.2 Client-side Mechanism Selection

A client should evaluate the compound security mechanism definitions contained within the **CompoundSecMechList** in the **TAG_CSI_SEC_MECH_LIST** component in an IOR to select a mechanism that supports the options required by the client.

The options supported by a compound mechanism are the union (the logical OR) of the options supported by the **transport_mech**, **as_context_mech**, and **sas_context_mech** fields of the **CompoundSecMech** structure.

The following table defines the semantics defined by the union of association options in compound mechanism definitions. Association options for server to client authentication and message protection add additional semantics that are not represented in the table.

Table 10.18- Interpretation of Compound Mechanism Association Options

	Semantic	EstablishTrustInClient		IdentityAssertion	DelegationByClient	
		Supported	Required	Supported	Supported	Required
1	No client identification.				Don't care ^b	
2	Presumed trust.			X		
3	Authentication optional.	X			Don't care	
4	Authentication optional, assertion supported.	X		X		
5	Authentication Required.	X	X		Don't care	
6	Authentication Required, assertion supported.	X	X	X		
7	Presumed trust including support for provided target restrictions.			X	X	
8	Authentication optional, assertion supported including forward trust rules.	X		X	X	
9	Authentication required, assertion supported including forward trust rules.	X	X	X	X	
10	Presumed Trust including support for provided target restrictions, delegation token required which implies assertion required ^a .			X	X	X
11	Authentication optional, assertion supported including forward trust rules, delegation token required which implies either client authentication or assertion required.	X		X	X	X
12	Authentication required, delegation token required.	X	X		X	X
13	Authentication required, assertion supported including forward trust rules, delegation token required.	X	X	X	X	X

- a. If a delegation token is required, a non-anonymous client identity shall be established so that it can be endorsed by the delegation token. This same rule applies to row 11, and explains why there is no row that supports client authentication and requires a delegation token.
- b. If DelegationByClient is supported, a delegation token may be provided, but it is not required to process the request

10.5.3 Client-Side Requirements and Location Binding

The primary assumption of this interoperability protocol is that transport layer security can ensure that it is not necessary to issue a preliminary request to establish a confidential association with the intended target.

In order to sustain this assumption, trust in target and a confidential transport shall be established prior to issuing any call that may contain arguments (including object keys) or service context elements that the client considers confidential. A CSS acting on behalf of a client may trust a target to locate an object (process a locate request) without having to trust the target with confidential arguments (other than object keys) or service context elements. For example, a CSS may have established a confidential connection to an address it learned from an IOR, and may then determine if the client trusts the target with its request arguments and any associated service context elements. If the client does not trust the target with its request, the CSS may send a locate request.¹¹ If the locate reply contains a new address, the CSS may establish a new confidential connection, evaluate the level of trust the client has in the new target, and determine whether it can issue the client's request to the target. If in response to the request, the CSS receives a location forward, it will establish another confidential connection with the new address and repeat its trust determination.

Compound security mechanisms appearing in IORs leading to a location daemon should not require clients to authenticate using the username/password mechanism if doing so would cause an overly trusting caller to share its password with an untrusted location daemon.

The way in which a location daemon derives an IOR for a target object is not prescribed by this specification.

10.5.3.1 Comments on Establishing Trust in Client

A client that does not have the artifacts necessary to provide evidence of its authenticity over at least one of the transports supported by it and its target should search the IOR for a security mechanism definition that does not require client authentication to occur in a transport mechanism.

10.5.4 Server Side Consideration

If the target requires client authentication, and the transport does not provide that authentication, then the target should always respond with OBJECT_HERE to **LocateRequest** messages and defer the real forwarding response until it receives a GIOP Request message.

10.6 Conformance Levels

10.6.1 Conformance Level 0

Level 0 defines the base level of secure interoperability that all implementations are required to support. Level 0 requires support for SSL/TLS protected connections. Level 0 implementations are also required to support username/password client authentication and identity assertion by using the service context protocol defined in this specification.

10.6.1.1 Transport-Layer Requirements

Implementations shall support the Security Attribute Service (SAS) protocol within the service context lists of GIOP request and reply messages exchanged over SSL 3.0 and TLS 1.0 protected connections.

11. CSS can use the Object::validate_connection operation to get the ORB to issue a locate request.

Implementations shall also support the SAS protocol within the service context lists of GIOP request and reply messages over unprotected transports defined within IIOP.¹²

10.6.1.1.1 Required Ciphersuites

Conforming implementations are required to support both SSL 3.0 and TLS 1.0 and the mandatory TLS 1.0 ciphersuites identified in [IETF RFC 2246]. Conforming implementations are also required to support the SSL 3.0 ciphersuites corresponding to the mandatory TLS 1.0 ciphersuites.

An additional set of recommended ciphersuites is identified in Recommended SSL/TLS Ciphersuites on page 149.

10.6.1.2 Service Context Protocol Requirements

All implementations shall support the Security Attribute Service (SAS) context element protocol in the manner described in the following sub clauses.

10.6.1.2.1 Stateless Mode

All implementations shall support the stateless CSS and stateless TSS modes of operation as defined in Session Semantics on page 141, and in the protocol message definitions appearing in SAS context_data Message Body Types on page 127.

10.6.1.2.2 Client Authentication Tokens and Mechanisms

All implementations shall support the username password (GSSUP) mechanism for client authentication as defined in Username Password GSS Mechanism (GSSUP) on page 133.

10.6.1.2.3 Identity Tokens and Identity Assertion

All implementations shall support the identity assertion functionality defined in Context Validation on page 137 and the identity token formats and functionality defined in Identity Token Format on page 135.

All implementations shall support GSSUP mechanism specific identity tokens of type **ITTPPrincipalName**.

10.6.1.2.4 Authorization Tokens (not required)

At this level of conformance, implementations are not required to be capable of including an authorization token in the SAS protocol elements they send or of interpreting such tokens if they are included in received SAS protocol elements.

The format of authorization tokens is defined in Authorization Token Format on page 131.

10.6.1.3 Interoperable Object References (IORs)

The security mechanism configuration of CSIv2 target objects, shall be as defined in Target Security Configuration on page 150, with the exception that Level 0 implementations are not required to support the **DelegationByClient** functionality described in AssociationOptions Type on page 151.

10.6.2 Conformance Level 1

Level 1 adds the following additional requirements to those of Level 0.

12. SAS protocol elements should only be sent over unprotected transports within trusted environments.

10.6.2.1 Authorization Tokens

Level 1 implementations shall support the push model for privilege attributes.

Level 1 requires that a CSS provide clients with an ability to include an authorization token, as defined in Authorization Token Format on page 131, in SAS EstablishContext protocol messages.

Level 1 requires that a TSS be capable of evaluating its support for a received authorization token according to the rules defined in Extensions of the IETF AC Profile for CSIV2 on page 132.

A Level 1 TSS shall recognize the standard attributes and extensions defined in the attribute certificate profile defined in [IETF ID PKIXAC].

Level 1 requires that a target object that supports pushed privilege attributes include in its IORs the names of the privilege authorities trusted by the target object (as defined in struct SAS_ContextSec on page 156).

10.6.3 Conformance Level 2

Level 2 adds to Level 1 the following additional requirements.

10.6.3.1 Authorization-Token-Based Delegation

Level 2 adds to Level 1 a requirement that implementations support the authorization-token-based delegation mechanism implemented by the SAS protocol.

A Level 2 TSS shall be capable of evaluating proxy rules arriving in an authorization token to determine whether an asserting entity has been endorsed (by the authority which vouched for the privilege attributes in the authorization token) to assert the identity to which the privilege attributes pertain. The semantics of the relationship between the identity token and authorization token shall be as defined in Context Validation on page 137.

A Level 2 TSS shall recognize the Extensions of the IETF AC Profile for CSIV2 on page 132” (that is, the Proxy Info extension) as defined on that page.

Level 2 requires that a target object that accepts identity assertions based on endorsements in authorization tokens represent this support in its IORs as defined in Table 10.17.

Level 2 requires that a target object that requires an endorsement to act as proxy for its callers represent this requirement in its IORs as defined in Table 10.17.

10.6.4 Stateful Conformance

Implementations are differentiated not only by the conformance levels described in the preceding sub clauses but also by whether or not they support stateful security contexts.

For an implementation to claim stateful conformance, it shall implement the stateless and stateful functionality as defined in Session Semantics on page 141 and in SAS context_data Message Body Types on page 127.

10.7 Sample Message Flows and Scenarios

This sub clause contains sequence diagrams and sample IORs for a set of scenarios selected to illustrate the interoperability protocols defined in this specification. The sample IORs are expressed in pseudocode.

10.7.1 Confidentiality, Trust in Server, and Trust in Client Established in the Connection

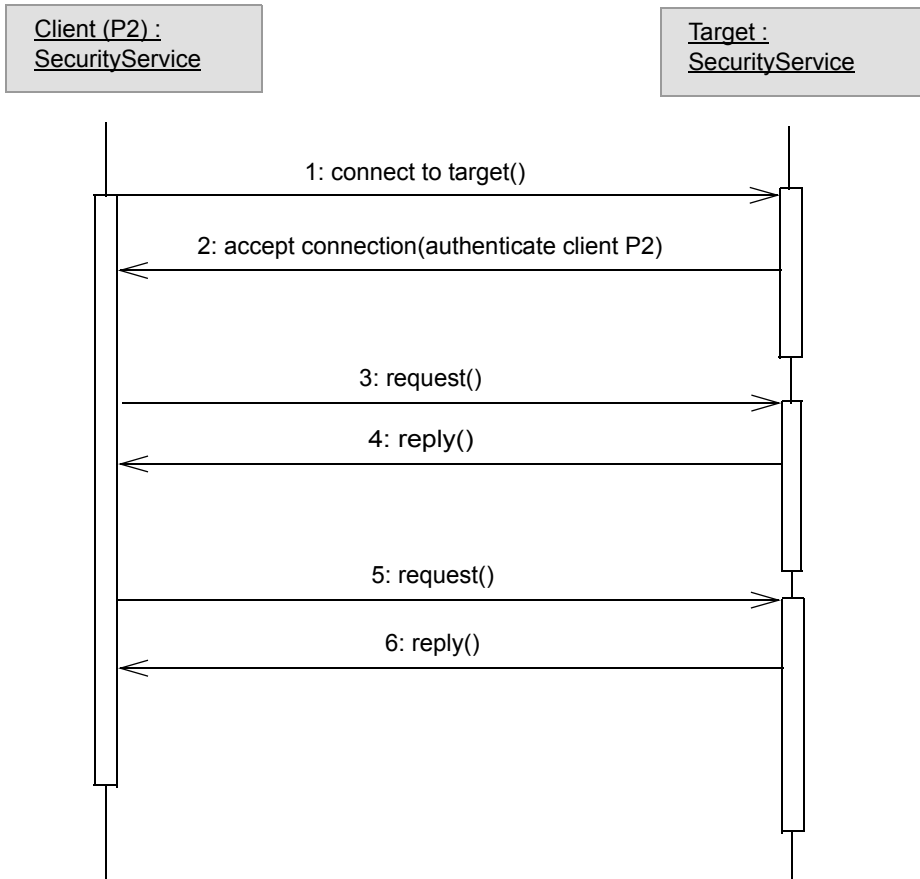

1. Initiate SSL/TLS connection to TSS.
2. SSL/TLS connection and ciphersuite negotiation accepted by both CSS and TSS. CSS evaluates its trust in target authentication identity and decides to continue. Client (P2) authenticates to TSS in the handshake.
3. Send request (with no security service context element).
4. Receive reply (with no security service context element).
5. Same as 3.
6. Same as 4.

10.7.1.1 Sample IOR Configuration

The following sample IOR was designed to address the related scenario.

```
CompoundSecMechList{
    stateful = FALSE;
    mechanism_list = {
```

```

CompoundSecMec {
  target_requires = {Integrity, Confidentiality, EstablishTrustInClient};
  transport_mech = TAG_TLS_SEC_TRANS {
    target_supports = {Integrity, Confidentiality, EstablishTrustInClient,
                      EstablishTrustInTarget};
    target_requires = {Integrity, Confidentiality, EstablishTrustInClient};
    addresses = {
      TransportAddress {
        host_name = x;
        port = y;
      };
    };
  };
  as_context_mech = {
    target_supports = {};
    ...
  };
  sas_context_mech = {
    target_supports = {};
    ...
  };
};
};
};

```

Note that based on the ciphersuites listed in Required Ciphersuites on page 161 and the rules for target_supports and target_requires appearing in the tables in TAG_TLS_SEC_TRANS on page 152, all target IORs should include {Integrity, Confidentiality, EstablishTrustInTarget} in **target_supports** and at least {Integrity, Confidentiality} in **target_requires**. This statement applies to all the sample IORs corresponding to all the scenarios described in this sub clause.

10.7.2 Confidentiality and Trust in Server Established in the Connection - Stateless Trust in Client Established in Service Context

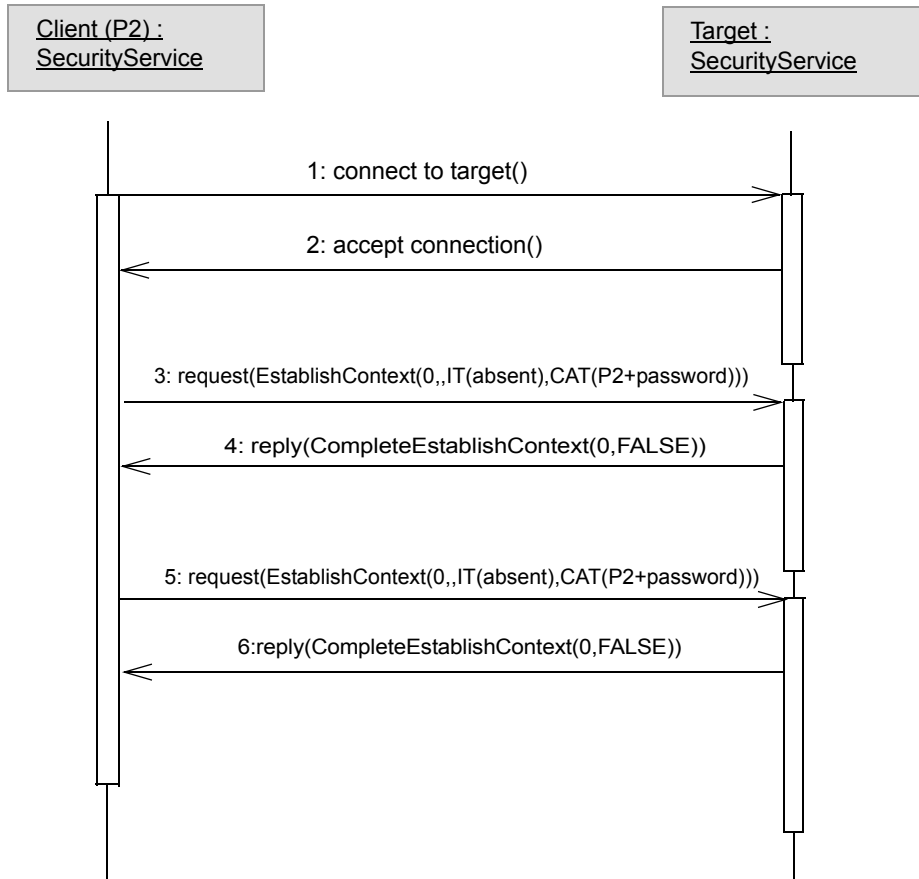

1. Initiate SSL/TLS connection to TSS.
2. SSL/TLS connection and ciphersuite negotiation accepted by both CSS and TSS. CSS evaluates its trust in target authentication identity and decides to continue.
3. Send request (with stateless security service context element containing a **client_authentication_token**).
4. Receive reply with **CompleteEstablishContext** service context element indicating context (and request) was accepted.
5. Same as 3.
6. Same as 4.

10.7.2.1 Sample IOR Configuration

The following sample IOR was designed to address the related scenario.

```

CompoundSecMechList{
  stateful = FALSE;
  mechanism_list = {
    CompoundSecMec {
      target_requires = {Integrity, Confidentiality, EstablishTrustInClient};
      transport_mech = TAG_TLS_SEC_TRANS {
        target_supports = {Integrity, Confidentiality, EstablishTrustInClient,
          EstablishTrustInTarget};
        target_requires = {Integrity, Confidentiality};
        addresses = {
          TransportAddress {
            host_name = x;
            port = y;
          };
        };
      };
      as_context_mech = {
        target_supports = {EstablishTrustInClient};
        target_requires = {EstablishTrustInClient};
        client_authentication_mech = GSSUPMechOID;
        target_name = (GSSUPMechOID + name_scope);
      };
      sas_context_mech = {
        target_supports = {};
      };
      ...
    };
  };
};

```

10.7.3 Confidentiality, Trust in Server, and Trust in Client Established in the Connection Stateless Trust Association Established in Service Context

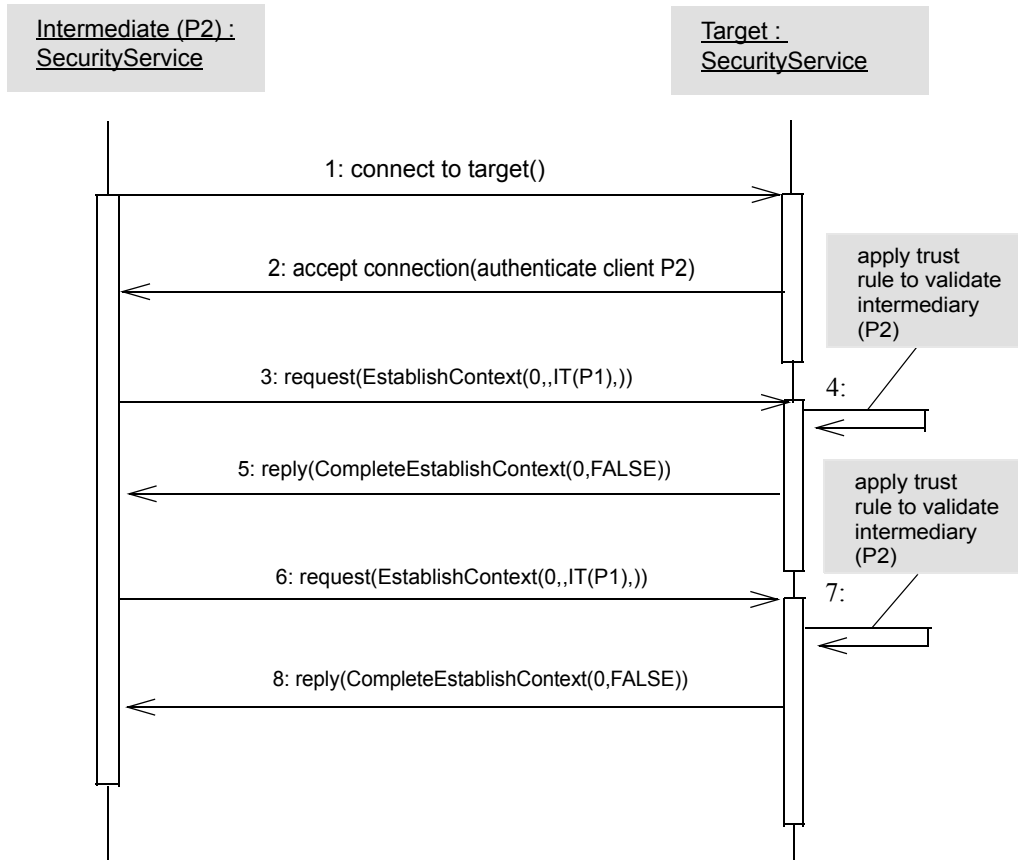

1. Initiate SSL/TLS connection to TSS.
2. SSL/TLS connection and ciphersuite negotiation accepted by both CSS and TSS. CSS evaluates its trust in target authentication identity and decides to continue. Client (P2) authenticates to TSS in the handshake.
3. Send request (with stateless security service context element containing spoken for identity (P1) in **identity_token**).
4. TSS validates that target trusts P2 to speak for P1.
5. Receive reply with **CompleteEstablishContext** service context element indicating context (and request) was accepted.
6. Same as 3.
7. Same as 4.
8. Same as 5.

10.7.3.1 Sample IOR Configuration

The following sample IOR was designed to address the related scenario.

```
CompoundSecMechList {
  stateful = FALSE;
  mechanism_list = {
    CompoundSecMech {
      target_requires = {Integrity, Confidentiality, EstablishTrustInClient};
      transport_mech = TAG_TLS_SEC_TRANS {
        target_supports = {Integrity, Confidentiality, EstablishTrustInClient,
          EstablishTrustInTarget};
        target_requires = {Integrity, Confidentiality, EstablishTrustInClient};
        addresses = {
          TransportAddress {
            host_name = x;
            port = y;
          };
        };
      };
      as_context_mech = {
        target_supports = {};
        ...
      };
      sas_context_mech = {
        target_supports = {IdentityAssertion};
        target_requires = {};
        privilege_authorities = {};
        supported_naming_mechanisms = {GSSUPMechOID};
        supported_identity_types = {ITTPPrincipalName};
      };
    };
  };
};
```

10.7.3.2 Validating the Trusted Server

If trust is not presumed, then the TSS shall evaluate the trustworthiness of the speaking for identity (i.e., the client identity established in the authentication layer(s) - P2 in the preceding example) in order to determine if it is authorized to speak for the spoken for identity (i.e., the non-anonymous identity represented as P1 in the identity token in the preceding example).

10.7.3.3 Presuming the Security of the Connection

There are variants of this scenario where either no security is established in the connection, or the connection is used to establish confidentiality only, and/or trust in the target only. These cases all fall under what is referred to as a presumed trust association. Where the security of the connection and the party using it is presumed, the TSS will not validate the trustworthiness of the speaking-for identity.

```
CompoundSecMechList {
  stateful = FALSE;
  mechanism_list = {
```

```

CompoundSecMec {
  target_requires = {Integrity, Confidentiality};
  transport_mech = TAG_TLS_SEC_TRANS {
    target_supports = {Integrity, Confidentiality, EstablishTrustInTarget};
    target_requires = {Integrity, Confidentiality};
    addresses = {
      TransportAddress {
        host_name = x;
        port = y;
      };
    };
  };
  as_context_mech = {
    target_supports = {};
    ...
  };
  sas_context_mech = {
    target_supports = {IdentityAssertion};
    target_requires = {};
    privilege_authorities = {};
    supported_naming_mechanisms = {GSSUPMechOID};
    supported_identity_types = {ITTPrincipalName};
  };
};
};
};

```

10.7.4 Confidentiality, Trust in Server, and Trust in Client Established in the Connection - Stateless Forward Trust Association Established in Service Context

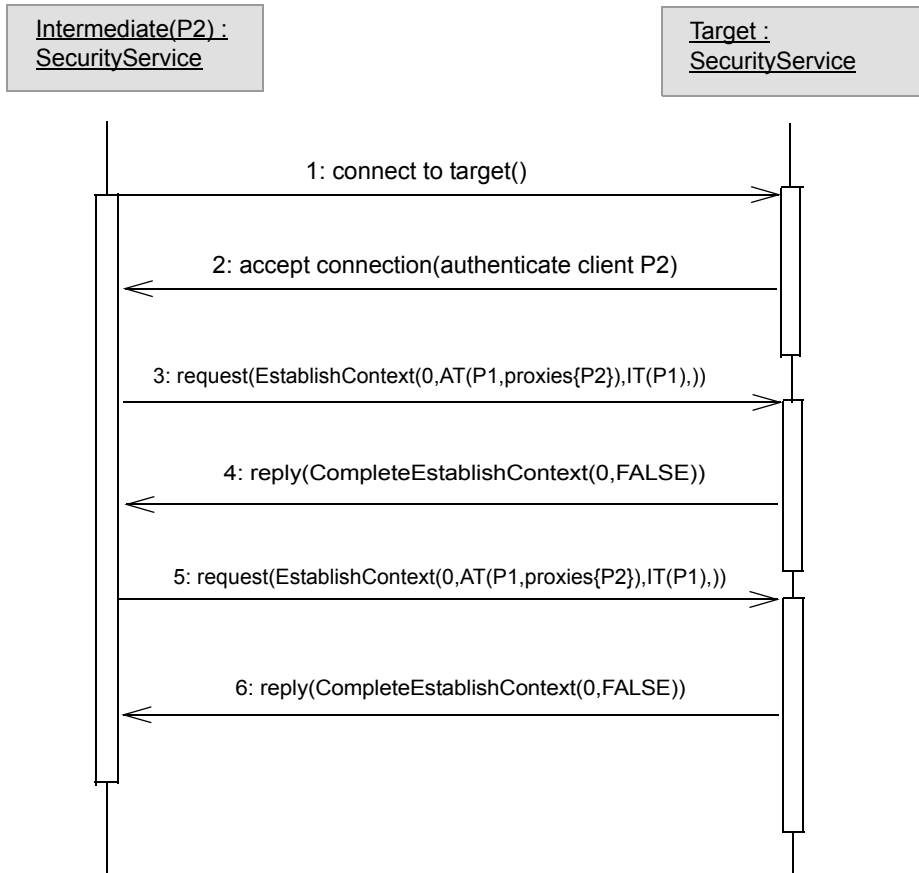

1. Initiate SSL/TLS connection to TSS.
2. SSL/TLS connection and ciphersuite negotiation accepted by both CSS and TSS. CSS evaluates its trust in target authentication identity and decides to continue. Intermediate (P2) authenticates to TSS in the handshake.
3. Send request with stateless security service context element containing spoken for identity (P1) in **identity_token**, and trust rule from P1 in **authorization_token** delegating proxy to P2.
4. Receive reply with **CompleteEstablishContext** service context element indicating context (and request) was accepted.
5. Same as 3.
6. Same as 4.

10.7.4.1 Sample IOR Configuration

The following sample IOR was designed to address the related scenario.

```

CompoundSecMechList {
  stateful = FALSE;
  mechanism_list = {
    CompoundSecMec {
      target_requires = {Integrity, Confidentiality, EstablishTrustInClient};
      transport_mech = TAG_TLS_SEC_TRANS {
        target_supports = {Integrity, Confidentiality, EstablishTrustInClient,
          EstablishTrustInTarget};
        target_requires = {Integrity, Confidentiality, EstablishTrustInClient};
        addresses = {
          TransportAddress {
            host_name = x;
            port = y;
          };
        };
      };
    };
    as_context_mech = {
      target_supports = {};
      ...
    };
    sas_context_mech = {
      target_supports = {IdentityAssertion, DelegationByClient};
      target_requires = {};
      privilege_authorities = {
        ServiceConfigurationSyntax {
          syntax = s;
          name = n;
        };
      };
      supported_naming_mechanisms = {GSSUPMechOID};
      supported_identity_types = {ITTPrincipalName};
    };
  };
};

```

10.8 References

CORBASEC

CORBA Security Service, Revision 1.2, <http://www.omg.org/docs/ptc/98-01-02>

CORBA Security Service, Revision 1.5, <http://www.omg.org/docs/ptc/98-12-03>

CORBA Security Service, Revision 1.7, <http://www.omg.org/docs/ptc/99-12-03>

IETF ID PKIXAC

An Internet Attribute Certificate Profile for Authorization, <draft-ietf-pkix-ac509prof-05.txt>, S. Farrell, Baltimore Technologies, R. Housley, SPYRUS, August 2000.

IETF RFC 2246

The TLS Protocol Version 1.0, T. Dierks, C. Allen, January 1999.

IETF RFC 2459

Internet X.509 Public Key Infrastructure Certificate and CRL Profile, R Housley, W. Ford, W. Polk, and D. Solo, January 1999.

IETF RFC 2743

Generic Security Service Application Program Interface Version 2, Update 1, J. Linn, January 2000.

X.501-93

ITU-T Recommendation X.501: Information Technology - Open Systems Interconnection - The Directory: Models, 1993.

10.9 IDL

10.9.1 Module GSSUP - Username/Password GSSAPI Token Formats

```
#ifndef _GSSUP_IDL_
#define _GSSUP_IDL_

import ::CSI;

module GSSUP {
    typeprefix GSSUP "omg.org";

    // The GSS Object Identifier allocated for the
    // username/password mechanism is defined below.
    //
    // { iso-itu-t (2) international-organization (23) omg (130)
    //     security (1) authentication (1) gssup-mechanism (1) }

    const CSI::StringOID GSSUPMechOID = "oid:2.23.130.1.1.1";

    // The following structure defines the inner contents of the
    // username password initial context token. This structure is
    // CDR encapsulated and appended at the end of the
    // username/password GSS (initial context) Token.

    struct InitialContextToken {
        CSI::UTF8String username;
        CSI::UTF8String password;
        CSI::GSS_NT_ExportedName target_name;
    };
    typedef unsigned long ErrorCode;

    // GSSUP Mechanism-Specific Error Token
```

```

struct ErrorToken {
    ErrorCode error_code;
};
// The context validator has chosen not to reveal the GSSUP
// specific cause of the failure.
const ErrorCode GSS_UP_S_G_UNSPECIFIED = 1;

// The user identified in the username field of the
// GSSUP::InitialContextToken is unknown to the target.
const ErrorCode GSS_UP_S_G_NOUSER = 2;

// The password supplied in the GSSUP::InitialContextToken was
// incorrect.
const ErrorCode GSS_UP_S_G_BAD_PASSWORD = 3;

// The target_name supplied in the GSSUP::InitialContextToken does
// not match a target_name in a mechanism definition of the target.
const ErrorCode GSS_UP_S_G_BAD_TARGET = 4;

}; // GSSUP

#endif

```

10.9.2 Module CSI - Common Secure Interoperability

```

#ifndef _CSI_IDL_
#define _CSI_IDL_

module CSI {
    typeprefix CSI "omg.org";

    // The OMG VMCID; same value as CORBA::OMGVMCID. Do not change ever.

    const unsigned long OMGVMCID = 0x4F4D0;

    // An X509CertificateChain contains an ASN.1 BER encoded SEQUENCE
    // [1..MAX] OF X.509 certificates in a sequence of octets. The
    // subject's certificate shall come first in the list. Each following
    // certificate shall directly certify the one preceding it. The ASN.1
    // representation of Certificate is as defined in [IETF RFC 2459].

    typedef sequence <octet> X509CertificateChain;

    // an X.501 type name or Distinguished Name in a sequence of
    // octets containing the ASN.1 encoding.

    typedef sequence <octet> X501DistinguishedName;

    // UTF-8 Encoding of String

```

```

typedef sequence <octet> UTF8String;

// ASN.1 Encoding of an OBJECT IDENTIFIER

typedef sequence <octet> OID;

typedef sequence <OID> OIDList;

// A sequence of octets containing a GSSToken. Initial context tokens are
// ASN.1 encoded as defined in [IETF RFC 2743] 3.1,
// "Mechanism-Independent token Format", pp. 81-82. Initial context tokens
// contain an ASN.1 tag followed by a token length, a mechanism identifier,
// and a mechanism-specific token (i.e. a GSSUP::InitialContextToken). The
// encoding of all other GSS tokens (e.g. error tokens and final context
// tokens) is mechanism dependent.

typedef sequence <octet> GSSToken;

// An encoding of a GSS Mechanism-Independent Exported Name Object as
// defined in [IETF RFC 2743] 3.2, "GSS Mechanism-Independent
// Exported Name Object Format," p. 84.
typedef sequence <octet> GSS_NT_ExportedName;
typedef sequence <GSS_NT_ExportedName> GSS_NT_ExportedNameList;

// The MessageType enumeration defines the complete set of service context
// message types used by the CSI context management protocols, including
// those message types pertaining only to the stateful application of the
// protocols (to insure proper alignment of the identifiers between
// stateless and stateful implementations). Specifically, the
// MTMessageInContext is not sent by stateless clients (although it may
// be received by stateless targets).

typedef short MessageType;

const MessageType MTEstablishContext = 0;
const MessageType MTCompleteEstablishContext = 1;
const MessageType MTContextError = 4;
const MessageType MTMessageInContext = 5;

// The ContextId type is used carry session identifiers. A stateless
// application of the service context protocol is indicated by a session
// identifier value of 0.

typedef unsigned long long ContextId;

// The AuthorizationElementType defines the contents and encoding of
// the _element field of the AuthorizationElement.

// The high order 20-bits of each AuthorizationElementType constant
// shall contain the Vendor Minor Codeset ID (VMCID) of the
// organization that defined the element type. The low order 12 bits

```

```
// shall contain the organization-scoped element type identifier. The
// high-order 20 bits of all element types defined by the OMG shall
// contain the VMCID allocated to the OMG (that is, 0x4F4D0).
```

```
typedef unsigned long AuthorizationElementType;
```

```
// An AuthorizationElementType of X509AttributeCertChain indicates that
// the _element field of the AuthorizationElement contains an ASN.1 BER
// SEQUENCE composed of an (X.509) AttributeCertificate followed by a
// SEQUENCE OF (X.509) Certificate.
// The chain of identity certificates is provided
// to certify the attribute certificate. Each certificate in the chain
// shall directly certify the one preceding it. The first certificate
// in the chain shall certify the attribute certificate. The ASN.1
// representation of (X.509) Certificate is as defined in [IETF RFC 2459].
// The ASN.1 representation of (X.509) AttributeCertificate is as defined
// in [IETF ID PKIXAC].
```

```
const AuthorizationElementType X509AttributeCertChain = OMGVMCID | 1;
```

```
typedef sequence <octet> AuthorizationElementContents;
```

```
// The AuthorizationElement contains one element of an authorization token.
// Each element of an authorization token is logically a PAC.
```

```
struct AuthorizationElement {
    AuthorizationElementType the_type;
    AuthorizationElementContents the_element;
};
```

```
// The AuthorizationToken is made up of a sequence of
// AuthorizationElements
```

```
typedef sequence <AuthorizationElement> AuthorizationToken;
```

```
typedef unsigned long IdentityTokenType;
```

```
// Additional standard identity token types shall only be defined by the
// OMG. All IdentityTokenType constants shall be a power of 2.
```

```
const IdentityTokenType ITTAbsent = 0;
const IdentityTokenType ITTAnonymous = 1;
const IdentityTokenType ITTPrincipalName = 2;
const IdentityTokenType ITTX509CertChain = 4;
const IdentityTokenType ITTDistinguishedName = 8;
typedef sequence <octet> IdentityExtension;
```

```
union IdentityToken switch ( IdentityTokenType ) {
    case ITTAbsent: boolean absent;
    case ITTAnonymous: boolean anonymous;
    case ITTPrincipalName: GSS_NT_ExportedName principal_name;
```



```

    case ITTX509CertChain: X509CertificateChain certificate_chain;
    case ITTDistinguishedName: X501DistinguishedName dn;
    default: IdentityExtension id;
};

struct EstablishContext {
    ContextId client_context_id;
    AuthorizationToken authorization_token;
    IdentityToken identity_token;
    GSSToken client_authentication_token;
};

struct CompleteEstablishContext {
    ContextId client_context_id;
    boolean context_stateful;
    GSSToken final_context_token;
};

struct ContextError {
    ContextId client_context_id;
    long major_status;
    long minor_status;
    GSSToken error_token;
};

// Not sent by stateless clients. If received by a stateless server, a
// ContextError message should be returned, indicating the session does
// not exist.

struct MessageInContext {
    ContextId client_context_id;
    boolean discard_context;
};

union SASContextBody switch ( MsgType ) {
    case MTEstablishContext: EstablishContext establish_msg;
    case MTCompleteEstablishContext: CompleteEstablishContext complete_msg;
    case MTContextError: ContextError error_msg;
    case MTMessageInContext: MessageInContext in_context_msg;
};

// The following type represents the string representation of an ASN.1
// OBJECT IDENTIFIER (OID). OIDs are represented by the string "oid:"
// followed by the integer base 10 representation of the OID separated
// by dots. For example, the OID corresponding to the OMG is represented
// as: "oid:2.23.130"

typedef string StringOID;

// The GSS Object Identifier for the KRB5 mechanism is:
// { iso(1) member-body(2) United States(840) mit(113554) infosys(1)

```

```

// gssapi(2) krb5(2) }

const StringOID KRB5MechOID = "oid:1.2.840.113554.1.2.2";

// The GSS Object Identifier for name objects of the Mechanism-independent
// Exported Name Object type is:
// { iso(1) org(3) dod(6) internet(1) security(5) nametypes(6)
// gss-api-exported-name(4) }

const StringOID GSS_NT_Export_Name_OID = "oid:1.3.6.1.5.6.4";

// The GSS Object Identifier for the scoped-username name form is:
// { iso-itu-t (2) international-organization (23) omg (130) security (1)
// naming (2) scoped-username(1) }

const StringOID GSS_NT_Scoped_Username_OID = "oid:2.23.130.1.2.1";

}; // CSI
#endif

```

10.9.3 Module CSIIOP - CSIV2 IOR Component Tag Definitions

```

#ifndef _CSIIOP_IDL_
#define _CSIIOP_IDL_

import ::IOP;
import ::CSI;

module CSIIOP {
    typeprefix CIOP "omg.org";
    // Association options
    typedef unsigned short AssociationOptions;
    const AssociationOptions NoProtection = 1;
    const AssociationOptions Integrity = 2;
    const AssociationOptions Confidentiality = 4;
    const AssociationOptions DetectReplay = 8;
    const AssociationOptions DetectMisordering = 16;
    const AssociationOptions EstablishTrustInTarget = 32;
    const AssociationOptions EstablishTrustInClient = 64;
    const AssociationOptions NoDelegation = 128;
    const AssociationOptions SimpleDelegation = 256;
    const AssociationOptions CompositeDelegation = 512;
    const AssociationOptions IdentityAssertion = 1024;
    const AssociationOptions DelegationByClient = 2048;

    // The high order 20-bits of each ServiceConfigurationSyntax constant
    // shall contain the Vendor Minor Codeset ID (VMCID) of the
    // organization that defined the syntax. The low order 12 bits shall
    // contain the organization-scoped syntax identifier. The high-order 20
    // bits of all syntaxes defined by the OMG shall contain the VMCID

```

```

// allocated to the OMG (that is, 0x4F4D0).

typedef unsigned long ServiceConfigurationSyntax;

const ServiceConfigurationSyntax SCS_GeneralNames = CSI::OMGVMCID | 0;
const ServiceConfigurationSyntax SCS_GSSExportedName = CSI::OMGVMCID | 1;

typedef sequence <octet> ServiceSpecificName;

// The name field of the ServiceConfiguration structure identifies a
// privilege authority in the format identified in the syntax field. If the
// syntax is SCS_GeneralNames, the name field contains an ASN.1 (BER)
// SEQUENCE [1..MAX] OF GeneralName, as defined by the type GeneralNames in
// [IETF RFC 2459]. If the syntax is SCS_GSSExportedName, the name field
// contains a GSS exported name encoded according to the rules in
// [IETF RFC 2743] 3.2, "Mechanism-Independent Exported Name
// Object Format," p. 84.

struct ServiceConfiguration {
    ServiceConfigurationSyntax syntax;
    ServiceSpecificName name;
};

typedef sequence <ServiceConfiguration> ServiceConfigurationList;

// The body of the TAG_NULL_TAG component is a sequence of octets of
// length 0.

// type used to define AS layer functionality within a compound mechanism
// definition

struct AS_ContextSec {
    AssociationOptions target_supports;
    AssociationOptions target_requires;
    CSI::OID client_authentication_mech;
    CSI::GSS_NT_ExportedName target_name;
};

// type used to define SAS layer functionality within a compound mechanism
// definition

struct SAS_ContextSec {
    AssociationOptions target_supports;
    AssociationOptions target_requires;
    ServiceConfigurationList privilege_authorities;
    CSI::OIDList supported_naming_mechanisms;
    CSI::IdentityTokenType supported_identity_types;
};

// type used in the body of a TAG_CSI_SEC_MECH_LIST component to
// describe a compound mechanism

```

```

struct CompoundSecMech {
    AssociationOptions target_requires;
    IOP::TaggedComponent transport_mech;
    AS_ContextSec as_context_mech;
    SAS_ContextSec sas_context_mech;
};

typedef sequence <CompoundSecMech> CompoundSecMechanisms;

// type corresponding to the body of a TAG_CSI_SEC_MECH_LIST
// component

struct CompoundSecMechList {
    boolean stateful;
    CompoundSecMechanisms mechanism_list;
};

struct TransportAddress {
    string host_name;
    unsigned short port;
};

typedef sequence <TransportAddress> TransportAddressList;

// Tagged component for configuring SECIOP as a CSiv2 transport mechanism

const IOP::ComponentId TAG_SECIOP_SEC_TRANS = 35;

struct SECIOP_SEC_TRANS {
    AssociationOptions target_supports;
    AssociationOptions target_requires;
    CSI::OID mech_oid;
    CSI::GSS_NT_ExportedName target_name;
    TransportAddressList addresses;
};

// tagged component for configuring TLS/SSL as a CSiv2 transport mechanism
const IOP::ComponentId TAG_TLS_SEC_TRANS = 36;
struct TLS_SEC_TRANS {
    AssociationOptions target_supports;
    AssociationOptions target_requires;
    TransportAddressList addresses;
};

}; //CSIOP

#endif

```

11 Unreliable Multicast Inter-ORB Protocol

11.1 Introduction

11.1.1 Purpose

The purpose of MIOP (Unreliable Multicast Inter-ORB Protocol) is to provide a common mechanism to deliver GIOP request and fragment messages via multicast. The default transport specified for MIOP is IP Multicast¹ through UDP/IP² which will provide the ability to perform connectionless multicast. This requires that IDL operations will have one-way semantics.

The initial version of MIOP will be designated 1.0. This version scheme will be independent of the GIOP version.

MIOP will not be dependent upon data that is contained in the GIOP header, request header, or fragment header; MIOP does not read or interpret GIOP messages. This will provide the capability for MIOP to be used for future and existing protocols as defined in by the OMG.

This specification mandates that implementers of this technology shall reuse the CDR marshaling.

The following sub clauses describe the wire protocol and send/receive semantics of MIOP.

11.1.2 MIOP Packet

An MIOP Packet is defined as the MIOP PacketHeader information, which is defined below, as well as the raw GIOP data (body) contained in the rest of the MIOP Packet. An MIOP Packet will be sent and later reassembled on the receiving side. MIOP Packets are the atomic pieces that comprise a Packet Collection that is discussed below.

11.1.3 Packet Collection

A Packet Collection is comprised of one or more MIOP Packets and is defined as complete, packaged, GIOP request/fragment message. Only GIOP request messages and associated request message fragments are allowed in an MIOP Packet in a Packet Collection.

The total data contained in a GIOP message (header, request/fragment header and body), determines the total number of MIOP Packets that need to be sent and subsequently reassembled by the receiver.

The number of packets that comprise a Packet Collection are dependent on the maximum size of the frame buffer supported by the hardware. Typically Ethernet supports 1518 bytes per frame, although UDP will allow up to 65536 bytes per frame if the physical layer can support it. If the Packet Collection cannot fit in the hardware specified frame size, the MIOP protocol requires that the GIOP message be broken up into packets that comprise a Packet Collection.

The MIOP sender will label the packet data so that the receiving MIOP layer can determine the number of packets in the MIOP message, as well as the position of each packet as a part of the Packet Collection (e.g., packet 3 of 20). In addition, the sender provides a unique signature for each Packet Collection to ensure that the receiver can properly reassemble the packets (i.e., make sure that 3 of 20 is not some other message's 3 of 20).

1. Deering, S. "Host Extensions for IP Multicasting" RFC 1112 Network Working Group, Stanford University August 1989
2. Postel, J. "User Datagram Protocol" RFC-768 Information Sciences Institute, August 28, 1980

11.1.4 PacketHeader

The PacketHeader is the MIOP data structure that represents the state information for a single packet within the Packet Collection in MIOP. This data structure is used to send and receive packetized GIOP messages in the form of MIOP Packet Collections. This data structure precedes any associated GIOP data which has been packetized. All MIOP packets in a Packet Collection must start with a PacketHeader.

Therefore it is required that:

- MIOP senders insert a PacketHeader in front of each packet of GIOP request/fragment data;
- MIOP receivers read and strip off MIOP PacketHeaders and concatenate all the GIOP related data from the packets of a message before posting the GIOP request to the ORB; and
- the GIOP data in the MIOP Packet body must start on a eight byte boundary following the **Uniqueld** field.

The following IDL defines the fields of the Packet Header. The text following the IDL will describe the field in detail.

```
module MIOP
{
  typedef sequence <octet, 252> Uniqueld;

  struct PacketHeader_1_0
  {
    char          magic[4];          // 4bytes
    octet        hdr_version;       // 1 byte
    octet        flags;             // 1 byte
    unsigned short packet_length;   // 2 bytes
    unsigned long packet_number;    // 4 bytes
    unsigned long number_of_packets; // 4bytes, sub-total 16 bytes
    Uniqueld     id;                // body data must begin on a
                                   // 8 byte boundary
  };
};
```

11.1.4.1 struct PacketHeader

The PacketHeader is a variable length data structure that provides the capability for packet reassembly on the receivers side. The sending side is responsible for properly filling in the values before it is sent.

11.1.4.1.1 Magic

The magic field is a four byte character array which will always be the literal value 'MIOP.' This field will provide a mechanism for determining if a multicast message is a CORBA MIOP message or some other unrelated datagram.

11.1.4.1.2 Header Version

This field is a 1 byte value that contains the major and minor versions of MIOP. The high-order four bits of the octet will be the major version and the low-order four bits are the minor version (e.g., decimal 16 will equal version 1.0).

11.1.4.1.3 Flags

The Flags field is a single octet that provides the value of the sending endian, and a stop message bit as well as unused, additional bits for future use.

The 1.0 version of MIOP specifies that the lowest order bit of the octet will contain the endian flag. The value zero for the endian flag indicates big-endian byte ordering and the value one indicates little-endian byte ordering.

The second lowest order bit will designate the stop message flag. This bit contains a value of one for the last packet sent in a Packet Collection; otherwise it must be zero.

The values of the six reserved bits must be set to zero for MIOP 1.0.

11.1.4.1.4 Packet Length

This field is mandatory and is used to define the actual number of bytes delivered with an MIOP Packet in a Packet Collection. This value must be the same for all MIOP Packets with the exception of the last packet which may contain a value which is less than the length specified in the other packets in the Packet Collection. This value is constrained by the physical layer of the underlying transport. For instance, UDP allows as much as 65K or as little as 512 bytes for the size of a single UDP packet.

The value specified in this field will not take into account the length of the header.

11.1.4.1.5 Packet Number

This field is mandatory and is an unsigned long value that states the current packet number that is being delivered (e.g., packet 3 of 20 in the Packet Collection). The number of the first packet must be zero and the number of the last packet must be n-1.

11.1.4.1.6 Number of Packets

This field is optional but can be used in conjunction with the first instance of an MIOP Packet in the Packet Collection, Packet Length field, to perform optimizations for allocating the receive message buffer used in packet reassembly. The number-of-packets field is an unsigned long value that states the total number of packets that are to be delivered³. In the event that this field is not used it must be set to the value zero.

11.1.4.1.7 Uniqueld

This variable length data structure provides the unique signature required for packet reassembly on the receiving side. This field *must* be identical for all packets associated with a Packet Collection. The data structure for this field is a bounded sequence of octets not to exceed 252 bytes of octet data⁴. The data contained in the body of the packet following the octet portion of the sequence must start on an eight byte boundary to maintain the integrity of the GIOP data in the packet. Implementations must provide as a default, uniqueness appropriate for the internet as a whole (e.g., GUID format of COM).

11.1.5 Joining an IP/Multicast Group

IP/Multicast only requires receivers to explicitly join an IP/Multicast group before they receive their first MIOP packet.

3. Based on a UDP packet of 512, and the maximum number of packets (4,294,967,296) packets, the maximum message size would be approximately 2GB. This size would include the IP header, UDP header, MIOP PacketHeader(s), and all other related data.

4. The unique id should be kept as small as possible for those applications that broadcast small GIOP messages.

11.1.6 Quality Of Service

11.1.6.1 Time-To-Live

When the implementation is using IP/Multicast, the socket option `IP_MULTICAST_TTL`, provides the capability for a UDP/IP datagram to be sent over more than one subnet. This value could be assigned statically or dynamically. This specification does not address how an application would set TTL.

11.1.6.2 Incomplete Receipt of a Packet Collection

In the event that an MIOP packet is received out of order in the context of its Packet Collection, the protocol should wait for the missing packets until the last packet is received. If the missing packets are not received by the time of the receipt of the last packet, the Packet Collection is in error and should be dropped.

The receiver should provide a mechanism to time out incomplete Packet Collections in the event that a partial collection has been received but no further packets are incoming. This will keep the protocol from expending resources and waiting indefinitely.

11.1.7 Delivery Requirements

The MIOP protocol requires that a single GIOP request message, including any fragment, must be sent as a single MIOP message. This does not imply that the entire GIOP request must be encoded before it is delivered to the MIOP layer. The MIOP protocol must be notified that the last portion of the GIOP message is being sent. This notification must also occur for non-fragmented GIOP requests. Upon receipt of the last portion or the whole GIOP message, MIOP will generate packets from the GIOP data and set the stop bit in the Packet Header flags for the last MIOP packet it creates. All MIOP packets associated with a GIOP request, including the fragments will have the same data image expressed in their UniqueId field of their Packet Header in a given Packet Collection.

11.2 MIOP Object Model

11.2.1 Definition

The current CORBA object model specifies that a single object reference will map to a single object implementation via an object key. The invocation semantics are both two-way and one-way with reliability requirements for the delivery and ordering of messages.

The specification for the MIOP object model does not specify an object key but a group identifier that can be associated to multiple **PortableServer::ObjectId** values which in turn can be used to activate implementation objects. The delivery semantics of CORBA messages over MIOP are one-way with no reliability of message receipt. There are no requirements for MIOP to be reliable so therefore no group membership is needed. It is entirely possible to have an application sending CORBA messages via MIOP with no receiving applications present (e.g., the unpopular radio station that no one listens to but broadcasts none-the-less).

An on-going theme in the MIOP object model is the behavior of object groups. An object group in MIOP consists of group identification information as well as network communication information. Object group technology is necessary for implementing the MIOP object model. Therefore, the role of object groups will be covered during the discussion of the following document sub clauses.

The object model for MIOP will consist of the following topics:

- MIOP Unreliable IP/Multicast Profile Body,
- Group IOR,
- Portable Group Adapter (PGA),
- Gateway, and the
- Multicast Group Manager (MGM).

11.2.2 Unreliable IP/Multicast Profile Body (UIPMC_ProfileBody)

The **UIPMC_ProfileBody** contains all the information required to make an invocation on a servant object using IP/Multicast as a transport mechanism. The profile differs from the IIOP profile in that:

- the object key field is omitted; and
- the field expressing a host name is replaced by a multiple character field that will express a valid IPv4/IPv6 multicast address, or an alias name to a multicast address.

The absence of the object key in the UIPMC profile is due to the fact that an MIOP request will typically be delivered to multiple servants that are associated with an object group and are housed in applications built using different vendor's ORBs. This of course is different than the classical IIOP scenario in which an object key provides a mapping to a single servant.

The definition of the UIPMC profile is defined below.

```

module MIOP
{
    ...
    typedef GIOP::Version Version;
    typedef string Address;
    struct UIPMC_ProfileBody
    {
        Version          miop_version;
        Address         the_address;
        short          the_port;
        sequence<IOP::TaggedComponents> components;
    };
};

```

11.2.2.1 Version

The version field contains the major and minor version of the data structure. The version nomenclature will start at 1.0. This version field should be considered separate from the version of the MIOP PacketHeader.

11.2.2.2 Address

The Address field specifies either

- a class D address for IPv4 (e.g., 225.1.1.1);
- an IPv6 address (e.g., FF01:0:0:0:0:0:1 - all nodes address); or
- an alias to a multicast address.

11.2.2.3 Port

This field is an unsigned short value that contains the port value associated with the Address field.

11.2.2.4 Group Components

This field will contain any additional component profiles. It has the same semantics as in an IIOP ProfileBody. At least one of these components must contain a group component and additionally a component specifying an IIOP profile to be used for two-way operations and operations supporting the **CORBA::Object** OMA. The concepts of the components are discussed below.

```
module IOP {  
  
    const ProfileId    TAG_UIPMC      = 3;  
    const ComponentId TAG_GROUP      = 39;  
    const ComponentId TAG_GROUP_IIO = 40;  
};  
  
module PortableGroup {  
  
    typedef GIOP::Version Version;  
  
    struct GroupInfo { // tag = TAG_GROUP;  
        Version component_version;  
        GroupDomainId group_domain_id;  
        ObjectGroupId object_group_id;  
        ObjectGroupRefVersion object_group_ref_version;  
    };  
    typedef sequence <octet> GroupIIOPProfile;  
};
```

Object Groups can have lifetimes that persist after senders and receivers are no longer invoking on the destination endpoints of the object group. In fact, object groups can exist with no associated, participating sender or receiver objects. They should therefore be created to be unique to avoid ambiguity.

11.2.2.4.1 GroupInfo

The fields associated with this tagged component are used to provide unique information to describe a group.

Version

The current version of the tagged component.

GroupDomainId

A simple string that applies scope to the **ObjectGroupId**. This was changed from the **FT::FTDomainId**.

ObjectGroupId

A 64 bit identifier that uniquely defines the group.

ObjectGroupRefVersion

This field is optional and will be set to zero for MIOP when it is not being used. An implementation may set the value if multiple versions of an object group reference exist.

11.2.2.4.2 GroupIIOPProfile

This data field will contain the profile data for an IIOP tagged profile. This IIOP profile will be used to support the OMA of **CORBA::Object**. This component is not required to complete the UIPMC profile.

11.2.3 Group IOR

A Group IOR will serve the purpose of providing the client with the means to invoke directly to

- an IIOP gateway application in the event that the client is not multicast capable (via a standard IIOP profile); or
- MIOP aware servant objects that support the same interface and belong to the same multicast group (via a multicast profile; for example, **UIPMC_ProfileBody**).

The creator of the IOR, (typically the MGM but not necessarily), creates the number of profiles in the IOR based on the requirements of the object group participants. This suggests that one or both profiles could be present in the Group IOR. MIOP aware clients will directly target the UIPMC profile contained in the Group IOR. This would allow them to directly use the multicast capability as opposed to using a gateway. All the profiles are essentially optional but one of course must be present. The figure below details the contents of the Group IOR.

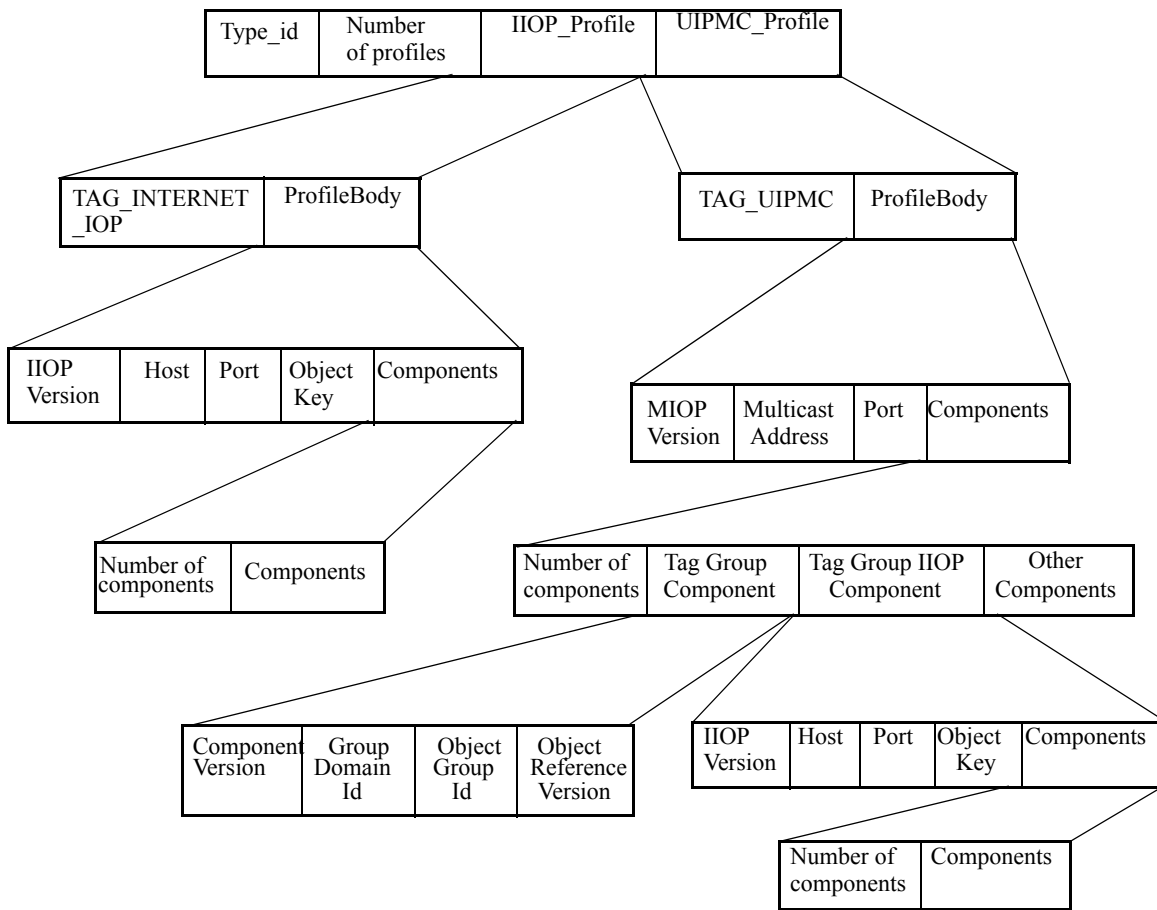

Figure 11.1 - An example of the Group Interoperable Object Reference used for Unreliable Multicast.

11.2.3.1 Gateway Profile

The profile for the gateway is a standard IIOProfile_Profile. The gateway itself could be multicast aware, or like the CORBA EventService, simply multiplex requests to the servant objects via a conventional IIOProfile_Profile mechanism. Therefore no restrictions should be placed on servants that would not allow both standard GIOP over IIOProfile_Profile requests and MIOProfile_Profile requests to target the same servant object.

If the gateway supports GIOP version 1.2, the creator of the Group IOR should place the UIPMC Profile⁵ information in the profile field of the union field for **GIOP::TargetAddress**.

If the gateway supports GIOP version 1.0 or 1.1, the creator of the Group IOR should place the UIPMC Profile information in the object key field. This data will appear as an encapsulation preceded by the literal characters ‘MIOProfile_Profile.’

Providing the entire profile as part of the request header allows the gateway to use the destination endpoints for forwarding the request to its intended destinations via multicast.

5. It is assumed that other profiles created for MIOProfile_Profile will be handled in a similar fashion.

11.2.3.2 UIPMC Profile

The UIPMC profile would directly support MIOP operations. This could be the only profile associated with an IOR for those situations where there are no gateway applications available. In addition, the creator of the group IOR can specify an IIOP profile to be placed as a tagged component of the UIPMC profile to support the OMA of **CORBA::Object**. The UIPMC profile differs from an IIOP profile in that the object key field is not present. The identify of the group is defined by the **PortableGroup::GroupInfo** data supplied in the components.

11.2.3.3 Unreliable Multicast Object Groups

Object groups represent a collection of participating objects, both invoking and receiving CORBA operations on common object group information, that take their identity from the information associated with the group definition. Typically this group information is stored in the Multicast Group Manager (MGM) when such an application is present. Often, though not in this specification, an object group's information will define a group's object membership; this specification ignores membership. It is assumed that future reliable multicast oriented specifications will address group membership.

For the scope of this specification, an object group will provide some unique identification of itself (id, name, type version) as well as the ability to disclose its destination endpoints.

11.2.4 Extending PortableServer::POA to include Group Operations

This sub clause discusses how to extend the current model for the PortableServer::POA to take into account servant groups. Several operations will be added to the interface GOA (Group Object Adapter) in the PortableGroup module to extend the POA and provide object group functionality.

The UIPMC profile for the Group IOR does not define a universal object key; object keys are opaque structures that are vendor defined. In addition, an object key as defined in IIOP, is intended to specify a single object as opposed to an object group. The intent of this specification was to not change the semantics of object keys or define a common object key format; neither of which would be hardily welcomed by the vendor community. Instead, the ORB implementation for the Group Object Adapter should use the **PortableGroup::GroupInfo** in the UIPMC profile components field and an associated **PortableServer::Objectld** to correctly dispatch the MIOP operation to the correct objects⁶.

The operations discussed below provide a mechanism to map a well known multicast group reference associated with an object group to a standard **PortableServer::Objectld**. This removes the need of having a common object key format. This also provides a mechanism to allow servant objects residing in different vendor's ORB applications to all receive the same messages. This of course is dependent on:

1. The servants using the same group reference containing the definition for the same object group.
2. The destination endpoints in the group reference being used for receiving requests.
3. The interface that the request is being invoked upon is identical, or derived from the parent interface by inheritance, to the one contained in the object group's definition.

There should be no restrictions on different object groups sharing the same destination endpoints.

6. The plural is used here to address multiple objects all associated with the same object group within a single process space. This requirement is necessary to address location transparency. Multiple collocated objects that have associated themselves with the same object group, which are invoked upon locally, will need to receive the request.

11.2.4.1 New Operations

```
module PortableGroup {  
  
    exception NotAGroupObject {};  
    typedef sequence <PortableServer::ObjectId> IDs;  
  
    interface GOA : PortableServer::POA {  
        ...  
        PortableServer::ObjectId  
        create_id_for_reference(in Object the_ref)  
        raises (NotAGroupObject);  
  
        IDs  
        reference_to_ids (in Object the_ref)  
        raises (NotAGroupObject);  
  
        void  
        associate_reference_with_id  
        (in Object ref, in PortableServer::ObjectId oid)  
        raises(NotAGroupObject);  
  
        void  
        disassociate_reference_with_id  
        (in Object ref, in PortableServer::ObjectId oid)  
        raises(NotAGroupObject);  
  
    }; // end interface GOA  
  
}; // end module PortableGroup
```

11.2.4.1.1 Group Object Adapter Operations

create_id_for_reference

The operation **create_id_for_reference()** takes as an argument a widened Group IOR and generates a unique **PortableServer::ObjectId** for that reference. This identifier returned by this routine is of the type **PortableServer::ObjectId**. This identifier is later associated with a servant via the standard API in the POA; that is, **activate_object_with_id()**.

```
PortableServer::ObjectId  
create_id_for_reference(in Object the_ref)  
raises (NotAGroupObject);
```

<i>Parameter:</i> the_ref	A reference for the object group.
<i>Return Value:</i>	A unique ObjectId.
<i>Raises:</i> NotAGroupObject	Raised if the object reference is not a group reference.

reference_to_ids

The operation **reference_to_ids()** takes as an argument a widened Group IOR and returns a sequence of object identifiers that are currently associated with the Group IOR.

IDs

```
reference_to_ids (in Object group_ref)  
raises (NotAGroupObject);
```

<i>Parameter:</i> the_ref	A reference for the object group.
<i>Return Value:</i>	A sequence of servant object identifiers that are currently associated with the group.
<i>Raises:</i> NotAGroupObject	Raised if the object reference is not a group reference

associate_reference_with_id

The operation takes a previously generated ObjectId and associates it with a group reference. Servants activated using this ObjectId will be candidates for receiving MIOP requests via the group information provided in the IOR. The operation silently ignores repeat/duplicate associations of a POA/ObjectId pair with the provided object reference.

void

```
associate_reference_with_id  
(in Object ref, in PortableServer::ObjectId oid)  
raises(NotAGroupObject);
```

<i>Parameters:</i>	
ref	A reference for the object group.
oid	A system or user generated ObjectId.
<i>Return Value:</i>	None
<i>Raises:</i> NotAGroupObject	Raised if the object reference is not a group reference

disassociate_reference_with_id

The operation takes a previously generated ObjectId and removes the association it had with a group reference. Servants activated using this ObjectId will no longer receive MIOP requests via the group information provided in the IOR. The operation silently ignores disassociations that no longer or never existed.

void

```
disassociate_reference_with_id  
(in Object ref, in PortableServer::ObjectId oid)  
raises(NotAGroupObject);
```

<i>Parameters:</i>	
ref	A reference for the object group.
oid	A system or user generated ObjectId.
<i>Return Value:</i>	None
<i>Raises:</i> NotAGroupObject	Raised if the object reference is not a group reference

11.2.4.2 Invocation Scenarios

The routines listed above do not have the capability to modify or destroy an ObjectId that is generated by the POA or by the application programmer. They simply associate an ID to a reference either implicitly or explicitly. Therefore a call to **create_id_for_reference()** or **associate_id_with_reference()** followed by a call to **disassociate_id_with_reference()** does nothing to the existence of the ObjectId and allows that same ObjectId to be reused again in a call to **associate_id_with_reference()**.

11.2.5 MIOP Gateway

A gateway may be used to provide access to all MIOP aware servants that are in the object group. Prior to the creation of the group IOR, the creator can specify the use of a gateway and creator of the group IOR can insert the IOP profile of the gateway in the Group IOR.

An MIOP unaware client ORB uses the IOP profile from the group IOR and establishes a connection to the gateway. The gateway in turn uses the destination endpoints specified by the UIPMC profile (placed in the object key pre GIOP 1.2, and in the TargetAddress profile field in GIOP 1.2) to forward GIOP request messages to the members of the object group. The gateway could use MIOP multicast or an IOP mechanism similar to the CORBA EventService.

An MIOP client application using a gateway would be MIOP unaware. Like any normal IOP sending application, it simply makes requests without regard to the UIPMC profile in the IOR.

11.2.6 Multicast Group Manager

The Multicast Group Manager serves the purpose creating and managing multicast object groups as well as managing multicast transport resources. Creation of the multicast group can result in the assignment of multicast destination endpoints on which senders multicast their messages and receivers accept them. Once an object group is created, the group reference can be stored in the Naming Service to be retrieved by applications interested in participating in the object group.

When the MGM is instructed to create a multicast object group, it may perform one of the following criteria:

- Just create the group with no destination endpoints;
- Create the group and automatically allocate the endpoints; or
- Create the group and supply its own preferred destination endpoints.

When the endpoints of the multicast transport are specified, the MGM can create a completed group reference and publish the reference to the world. The newly created/updated group reference would contain any specific IOP profiles to the gateway, as well as the UIPMC profile. Once a client application gets a group reference, it can then start multicasting to

servant objects who are listening on those same destination endpoints. A receiving application would acquire a published IOR and associate this reference with an ObjectId and then activate a servant object with that id allowing the dispatching of request to the participating servant objects.

A single MIOP multicast address may be associated with more than one object group. This allows a process to listen to messages for more than one group on a single multicast address.

Objects that are recipients of multicasts have interfaces defined in IDL like any other objects. However, because multicast is unidirectional, the only operations that can be invoked on an interface are operations that have a void return type, in parameters only, and do not raise exceptions. These restrictions create a problem because all IDL interfaces inherit from **CORBA::Object** which contains operations that do not meet these restrictions. For example, **is_a()** and **non_existent()** are operations that have a return value.

Therefore the group IOR created by the MGM must be able to:

- Provide a common factory to manage object groups; and
- Provide the capability to be able to support the OMA of **CORBA::Object**.

The MGM's role in implementing the OMA will be discussed at the end of this sub clause on the MGM. The following sub clauses will discuss the IDL that comprises the MGM.

Since the implementation of the MGM is optional, an orb vendor should use the corbaloc mechanism to create a group reference with a UIPMC profile if the MGM is not available. Once this reference is properly created, it needs to be published in a conventional application determined place (e.g., file, CORBA Naming Service, etc.) so that participating applications can acquire the reference to send and receive multicast requests.

11.2.6.1 module PortableGroup

This sub clause presents the IDL for the module PortableGroup. The module will be used for other specifications outside this specification that deal with Object Groups. The IDL from the discussion of the PGA above is not included in the full IDL definition of PortableGroup pending its full acceptance. The full IDL for module will be presented at the end of this specification.

11.2.6.1.1 Common Types

module PortableGroup {

// Specification for Interoperable Object Group References

typedef string GroupDomainId;

typedef unsigned long long ObjectGroupId;

typedef unsigned long ObjectGroupRefVersion;

typedef GIOP::Version Version;

struct GroupInfo { // tag = TAG_GROUP;

Version component_version;

GroupDomainId group_domain_id;

ObjectGroupId object_group_id;

ObjectGroupRefVersion object_group_ref_version;

};

typedef sequence <octet> GroupIOPProfile

```

// Specification of Common Types and Exceptions
// for GroupManagement
interface GenericFactory;

typedef CORBA::RepositoryId Typeld;
typedef Object ObjectGroup;
typedef CosNaming::Name Name;
typedef any Value;

struct Property {
    Name nam;
    Value val;
};

typedef sequence<Property> Properties;
typedef Name Location;
typedef sequence<Location> Locations;
typedef Properties Criteria;

struct FactoryInfo {
    GenericFactory the_factory;
    Location the_location;
    Criteria the_criteria;
};

typedef sequence<FactoryInfo> FactoryInfos;
typedef long MembershipStyleValue;

const MembershipStyleValue MEMB_APP_CTRL = 0;
const MembershipStyleValue MEMB_INF_CTRL = 1;

typedef unsigned short InitialNumberReplicasValue;
typedef unsigned short MinimumNumberReplicasValue;

exception InterfaceNotFound {};
exception ObjectGroupNotFound {};
exception MemberNotFound {};
exception ObjectNotFound {};
exception MemberAlreadyPresent {};
exception BadReplicationStyle {};
exception ObjectNotCreated {};
exception ObjectNotAdded {};
exception UnsupportedProperty {
    Name nam;
};

exception InvalidProperty {
    Name nam;
    Value val;
};

```

```

exception NoFactory {
    Location the_location;
    TypeId type_id;
};

exception InvalidCriteria {
    Criteria invalid_criteria;
};

exception CannotMeetCriteria {
    Criteria unmet_criteria;
};

```

11.2.6.2 Identifiers for PortableGroup

The identifiers listed below are identical to those defined in fault tolerant CORBA.

GroupDomainId

The name of the Group Domain. This name provides additional scoping with a group identifier.

ObjectGroupId

Unique Id for the Object Group.

ObjectGroupRefVersion

The current version of the reference. It should start at version 1.0.

GroupInfo

The unique information used object group identification as well as being used for object dispatching in the Portable Group Adapter.

GroupIOPProfile

This is additional component information that is defined as an IOP profile. This profile is used to support the implicit two-way operations associated with **CORBA::Object**.

TypeId

Repository Id of the Group Object's supported interface.

ObjectGroup

A collection of information used to define how one contacts a group of related group participants. It is uniquely identified by the information in the **GroupInfo** and the destination endpoints used to contact the servants in the group.

Name

The name of a property - may be hierarchical.

Value

The value of a property - may be any valid IDL type.

Property

A **Name/Value** pair.

Properties

A sequence of **Property**.

Location

This type is not used in MIOP for unreliable multicast.

Locations

This type is not used for MIOP for unreliable multicast.

Criteria

An IDL rename of the type **Properties**.

FactoryInfo

This type is not used for MIOP for unreliable multicast.

FactoryInfos

This type is not used for MIOP for unreliable multicast.

MembershipStyleValue

This type is not used for MIOP for unreliable multicast.

11.2.6.3 Exceptions for PortableGroup

The behavior of the exceptions is the same as in the CORBA Fault Tolerant specification except where differences are noted.

InterfaceNotFound

The exception is not used by the MGM.

ObjectGroupNotFound

The object group cannot be found by the MGM based on the identifier that was provided.

MemberNotFound

The exception is not used by the MGM.

ObjectNotFound

The exception is raised if no group reference is associated with the object group.

MemberAlreadyPresent

The exception is not used by the MGM.

BadReplicationStyle

The exception is not used by the MGM.

ObjectNotCreated

The **GenericFactory** did not create the object.

ObjectNotAdded

The exception is not used by the MGM.

UnsupportedProperty

The property is not recognized or unsupported.

InvalidProperty

The property was either repeated or is in conflict with an existing property.

NoFactory

The factory cannot create an object with the id provided.

InvalidCriteria

The criteria provided was not understood by the factory.

CannotMeetCriteria

The criteria was understood but the factory is unable to support the criteria.

11.2.6.4 interface PropertyManager

// Specification of PropertyManager Interface

```
interface PropertyManager {  
  
    void set_default_properties  
        (in Properties props)  
        raises (InvalidProperty, UnsupportedProperty);  
  
    Properties get_default_properties();  
  
    void remove_default_properties  
        (in Properties props)  
        raises (InvalidProperty, UnsupportedProperty);  
}
```

```

void set_type_properties
    (in TypedId type_id, in Properties overrides)
    raises (InvalidProperty, UnsupportedProperty);

Properties get_type_properties(in TypedId type_id);

void remove_type_properties
    (in TypedId type_id, in Properties props)
    raises (InvalidProperty, UnsupportedProperty);

void set_properties_dynamically
    (in ObjectGroup object_group, in Properties overrides)
    raises
        (ObjectGroupNotFound,
         InvalidProperty,
         UnsupportedProperty);

Properties get_properties
    (in ObjectGroup object_group)
    raises(ObjectGroupNotFound);

}; // endPropertyManager

```

This interface was taken from the CORBA Fault Tolerant specification. It has been modified to be general to object groups

11.2.6.4.1 Operations for PropertyManager

set_default_properties

The method sets all the default properties in the object group domain for all object groups. The default property values are determined by the implementation.

```

void set_default_properties
    (in Properties props)
    raises (InvalidProperty, UnsupportedProperty);

```

<i>Parameter:</i> props	A sequence of properties that are to applied to all object groups within a object group domain.
<i>Return Value:</i>	None
<i>Raises:</i>	
InvalidProperty	If one or more of the properties in the sequence is not valid
UnsupportedProperty	If one or more of the properties in the sequence is not supported.

get_default_properties

This method returns the default properties for the object groups within the object group domain.

Properties `get_default_properties()`;

<i>Parameter:</i>	None
<i>Return Value:</i>	The default properties that have been set for the object groups.
<i>Raises:</i>	None

`remove_default_properties`

This method removes the given default properties.

**void `remove_default_properties`(in Properties props)
raises (InvalidProperty, UnsupportedProperty);**

<i>Parameter:</i> props	The properties to be removed.
<i>Return Value:</i>	None
<i>Raises:</i>	
InvalidProperty	If one or more of the properties in the sequence is not valid.
UnsupportedProperty	If one or more of the properties in the sequence is not supported.

`set_type_properties`

This method sets the properties that override the default properties of the object groups, with the given type identifier, that are created in the future.

**void `set_type_properties`
(in TypeId type_id, in Properties overrides)
raises (InvalidProperty, UnsupportedProperty);**

<i>Parameter:</i>	
type_id	The repository id for which the properties, that are to override the existing properties, are set.
overrides	The overriding properties.
<i>Return Value:</i>	None
<i>Raises:</i>	
InvalidProperty	If one or more of the properties in the sequence is not valid.
UnsupportedProperty	If one or more of the properties in the sequence is not supported.

`get_type_properties`

This method returns the properties of the object groups, with the given type identifier, that are created in the future. These properties include the properties determined by `set_type_properties()`, as well as the default properties that are not overridden by `set_type_properties()`.

Properties get_type_properties(in Typed type_id);

<i>Parameter:</i> type_id	The repository id for which the properties, that are to override the existing properties, are set.
<i>Return Value:</i>	The overriding properties for the given type identifier.
<i>Raises:</i>	None

remove_type_properties

This method removes the given properties, with the given type identifier.

void remove_type_properties
(in Typed type_id, in Properties props)
raises (InvalidProperty, UnsupportedProperty);

<i>Parameter:</i>	
type_id	The repository id for which the given properties are to be removed.
props	The properties to be removed.
<i>Return Value:</i>	None
<i>Raises:</i>	
InvalidProperty	If one or more of the properties in the sequence is not valid.
UnsupportedProperty	If one or more of the properties in the sequence is not supported.

set_properties_dynamically

This method sets the properties for the object group with the given reference dynamically while the application executes. The properties given as a parameter override the properties for the object when it was created which, in turn, override the properties for the given type which, in turn, override the default properties.

void set_properties_dynamically
(in ObjectGroup object_group, in Properties overrides)
raises(ObjectGroupNotFound, InvalidProperty, UnsupportedProperty);

<i>Parameter:</i>	
object_group	The reference of the object group for which the overriding properties are set.
overrides	The overriding properties.
<i>Raises:</i>	
ObjectGroupNotFound	If object group specified cannot be found.
InvalidProperty	If one or more of the properties in the sequence is not valid.
UnsupportedProperty	If one or more of the properties in the sequence is not supported.

get_properties

This method returns the current properties of the given object group. These properties include those that are set dynamically, those that are set when the object group was created but are not overridden by **set_properties_dynamically()**, those that are set as properties of a type but are not overridden by **create_object()** and **set_properties_dyamically()**, and those that are set as defaults but are not overridden by **set_type_properties()**, **create_object()**, and **set_properties_dyamically()**.

Properties **get_properties**(in **ObjectGroup** **object_group**)
raises(**ObjectGroupNotFound**);

<i>Parameter:</i> object_group	The reference of the object group for which the properties are to be returned.
<i>Return Value:</i>	The set of current properties for the object group with the given reference.
<i>Raises:</i> ObjectGroupNotFound	If the object group is not found.

11.2.6.5 interface ObjectGroupManager

// Specification of ObjectGroupManager Interface

interface **ObjectGroupManager** {

ObjectGroup **create_member**
(in **ObjectGroup** **object_group**,
in **Location** **the_location**,
in **TypeId** **type_id**,
in **Criteria** **the_criteria**)
raises
(**ObjectGroupNotFound**,
MemberAlreadyPresent,
NoFactory,
ObjectNotCreated,
InvalidCriteria,
CannotMeetCriteria);

ObjectGroup **add_member**
(in **ObjectGroup** **object_group**,
in **Location** **the_location**,
in **Object** **member**)
raises
(**ObjectGroupNotFound**,
CORBA::INV_OBJREF,
MemberAlreadyPresent,
ObjectNotAdded);

ObjectGroup **remove_member**
(in **ObjectGroup** **object_group**,
in **Location** **the_location**)
raises
(**ObjectGroupNotFound**, **MemberNotFound**);

```

Locations locations_of_members
    (in ObjectGroup object_group) raises(ObjectGroupNotFound);

ObjectGroupId get_object_group_id
    (in ObjectGroup object_group) raises(ObjectGroupNotFound);

ObjectGroup get_object_group_ref
    (in ObjectGroup object_group) raises(ObjectGroupNotFound);

Object get_member_ref
    (in ObjectGroup object_group,
     in Location loc)
    raises(ObjectGroupNotFound, MemberNotFound);

}; // end ObjectGroupManager

```

This interface is largely unused by the MGM with the exception of two methods which will be discussed below. The MGM will use this interface to obtain the current reference and identifier of an object group. The routines that are not discussed in the table below all return the exception CORBA::NO_IMPLEMENT. The behavior of the operations in this interface is the same as in the CORBA Fault Tolerant specification except where differences are noted.

11.2.6.5.1 Operations for ObjectGroupManager

get_object_group_id

The method takes an object group reference as a parameter and returns the identifier of the object group.

```

ObjectGroupId get_object_group_id
    (in ObjectGroup object_group) raises (ObjectGroupNotFound);

```

<i>Parameter:</i> object_group	A reference for the object group.
<i>Return Value:</i>	The identifier of the object group.
<i>Raises:</i> ObjectGroupNotFound	Raised if the object group is not found by the MGM.

get_object_group_ref

The method takes an object group reference as a parameter and returns the current reference of the object group. Any address changes or new allocations can be found by updating this reference.

```

ObjectGroupId get_object_group_ref
    (in ObjectGroup object_group) raises (ObjectGroupNotFound);

```

<i>Parameter:</i> object_group	A reference for the object group.
<i>Return Value:</i>	The identifier of the object group.
<i>Raises:</i> ObjectGroupNotFound	Raised if the object group is not found by the MGM.

11.2.6.6 interface GenericFactory

// Specification of GenericFactory Interface

```
interface GenericFactory {
    typedef any FactoryCreationId;

    Object create_object
        (in TypedId type_id,
         in Criteria the_criteria,
         out FactoryCreationId factory_creation_id)
    raises
        (NoFactory,
         ObjectNotCreated,
         InvalidCriteria,
         InvalidProperty,
         CannotMeetCriteria);

    void delete_object
        (in FactoryCreationId factory_creation_id)
        raises (ObjectNotFound);
}; // end GenericFactory
```

This interface provides a generic create and destroy functionality for object groups. The call to **create_object()** will return a type Any that contains a **PortableGroup::ObjectGroupId**. The call to **destroy_object()** will remove the object group and the group reference from the factory. The behavior of the operations in this interface are the same as in the CORBA Fault Tolerant specification except where differences are noted.

11.2.6.6.1 Operations for GenericFactory

create_object

This routine creates a group reference from the type id and criteria list specified. It returns a group object identifier and a group object reference.

```
Object create_object
    (in TypedId type_id,
     in Criteria the_criteria,
     out FactoryCreationId factory_creation_id)
raises
    (NoFactory,
     ObjectNotCreated,
     InvalidCriteria,
     InvalidProperty,
     CannotMeetCriteria
    );
```

<i>Parameters:</i>	
object_group	A reference for the object group.
type_id	The repository id of the object to be created.
the_criteria	Additional information that is evaluated before the object is created. MIOP can use these to set the types and numbers of profiles in the Group IOR.
factory_creation_id	Unique value assigned by the factory and later used for deletion.
<i>Return Value:</i>	The group object created by the factory.
<i>Raises:</i>	
NoFactory	The object cannot be created.
ObjectNotCreated	The object cannot be created.
InvalidCriteria	The criteria is not understood.
InvalidProperty	Invalid property was passed in the criteria.
CannotMeetCriteria	The application understands the criteria but is unable to process it.

delete_object

This method deletes an object group, and all its available information, based on the type id specified.

void delete_object

(in FactoryCreationId factory_creation_id) raises (ObjectNotFound);

<i>Parameter:</i> factory_creation_id	An identifier that was previously provided by a create call.
<i>Return Value:</i>	None
<i>Raises:</i> ObjectNotFound	Raised if the object reference is not found by the MGM.

11.2.6.7 module MGM

module MGM {

// Property values

```
typedef long GroupCreationMode
const GroupCreationMode CREATE_ADDRESS_DEFERED = 0;
const GroupCreationMode CREATE_ADDRESS_GENERATED = 1;
const GroupCreationMode CREATE_ADDRESS_SUPPLIED = 2;
```

```
interface ObjectGroupFactory :
    PortableGroup::GenericFactory,
    PortableGroup::PropertyManager,
    PortableGroup::ObjectGroupManager {}
```

};

This module will encapsulate the specific properties of the MGM as well as the interface for **ObjectGroupFactory**.

11.2.6.8 MGM Properties

The following sub clauses document the policies in the MGM. It is assumed that the implementers may add to the list of properties based on their specific protocol and application needs. The only protocol currently supported is IP/Multicast.

11.2.6.8.1 GroupCreationMode

<i>Name:</i>	org.omg.mgm.GroupCreationMode
<i>Value:</i>	CREATE_ADDRESS_DEFERED
	CREATE_ADDRESS_GENERATED
	CREATE_ADDRESS_SUPPLIED

The creation mode **CREATE_ADDRESS_DEFERED** will direct the creation of an object group without any multicast destination endpoints. The inclusion of properties that involve destination endpoints will cause the exception **CannotMeetCriteria** to be raised.

The creation mode **CREATE_ADDRESS_GENERATED** will direct the creation of an object group with MGM selected multicast destination endpoints. The inclusion of properties that involve destination endpoints will cause the exception **CannotMeetCriteria** to be raised.

The creation mode **CREATE_ADDRESS_SUPPLIED** will direct the creation of an object group with those destination endpoints which are specified in another property. The exclusion of properties that contain destination endpoints will cause the exception **CannotMeetCriteria** to be raised.

These properties can only be set at group creation time.

11.2.6.8.2 CreateSpecifyGateway

<i>Name:</i>	org.omg.mgm.CreateSpecifyGateway
<i>Value:</i>	The CORBA::Object of the gateway.

This property will register the MIOP gateway in the object group. This property can be set anytime.

11.2.6.8.3 SupportImplicitOperations

<i>Name:</i>	org.omg.mgm.SupportImplicitOperations
<i>Value:</i>	CORBA::Object

This property will allow the MGM to create an IOR with a profile that supports the OMA of the object group. The IOR value could be one of the following:

- An object not associated with an MIOP gateway (application defined);
- an MIOP gateway; or
- the MGM.

If the value of the IOR is null, the MGM will assume it will be supporting the OMA. This property can be set anytime.

11.2.6.8.4 CreateIncludeGateway

<i>Name:</i>	org.omg.mgm.CreateIncludeGateway
<i>Value:</i>	CORBA::Boolean

If the value of the property is set to TRUE, the profile of the gateway is included in the group IOR. If the value of the property is set to FALSE, the profile of the gateway is excluded in the group IOR. This property can be set anytime.

11.2.6.8.5 ProtocolEndpointsIPPort

<i>Name:</i>	org.omg.mgm.ProtocolEndpointsIPPort
<i>Value:</i>	An unsigned short value designating a unique port.

This property can be set anytime.

11.2.6.8.6 ProtocolEndpointsIPAddress

<i>Name:</i>	org.omg.mgm.ProtocolEndpointsIPv4Address
<i>Value:</i>	A string designating an IPv4 or IPv6 multicast address.

This property can be set anytime.

11.2.6.8.7 GroupDomainId

<i>Name:</i>	org.omg.mgm.GroupDomainId
<i>Value:</i>	string

This value is used to scope the group identifier. If this property is not specified, the group domain identifier will default to "DefaultGroupDomain." This property can only be set once during the life of the object group. If an attempt is made to set this value after the default has been changed, the exception `PortableGroup::InvalidProperty` will be raised.

11.2.6.9 interface ObjectGroupFactory

This interface provides the capability to manage objects groups. It directly inherits the **ObjectGroupManager**, **PropertyManager**, and the **GenericFactory** interfaces. It completely reuses the specifications for its inherited interfaces.

11.2.6.10 Interoperable Object Group Reference Operations

To avoid breaking the CORBA object model, it is recommended that each group IOR's UIPMC profile contain the **PortableGroup::GroupIOPProfile** tagged component which will profile the capability to invoke two-way CORBA::Object implicit operations. The methods for addressing these operations are discussed in the following sub clauses.

is_a

This operation is unchanged. If the interface is understood by the client ORB, the call will return `true`. If the UIPMC profile was created without the **PortableGroup::GroupIOPProfile** component, the client ORB should try to resolve the interface internally and only return `false` if it cannot resolve the interface name internally. Otherwise it will use the IOP profile in the **PortableGroup::GroupIOPProfile** to try to resolve the call.

non_existent

For a group IOR, this operation always returns the value **true**.

validate_connection

For a group IOR, this operation always replies with **true** if the current policies are correct.

get_domain_managers

Similar considerations as for **is_a** here.

get_interface

Same considerations as for **is_a** and **get_domain_managers**.

is_nil

This operation would return **false** if at least one profile is present, otherwise it returns **true** if no profiles are present.

is_equivalent

Cases:

- If both references are non-group references the behavior is unchanged.
- If one reference is a group reference and the other is not a group reference, then the references are not equivalent.
- The number of profiles must be equal. If both references are group references, then the field of the group components are compared and must be identical for all profiles that contain them.

hash

Follows the semantics of **is_equivalent**.

create_request

Unchanged.

get_policy

Unchanged.

set_policy_overrides

Unchanged.

Other Two Way Calls

If the group IOR contains only the UIPMC profile, the client ORB may use the tagged component **PortableGroup::GroupIOPProfile**, if it exists, to process two-way calls on an interface that supports both two-way and one-ways calls.

If the group IOR contains both an IIOP gateway profile and the UIPMC profile, the sending ORB can choose to use the gateway IIOP profile even if it is MIOP aware. An MIOP unaware client would always use the IIOP gateway profile even in the existence of the UIPMC profile.

11.2.7 MIOP URL

This sub clause provides a corbaloc URL definition of an MIOP profile. The following defines the syntax:

```
<corbaloc> = "corbaloc:"<obj_addr_list>["/"<key_string>]
<obj_addr_list> = [<obj_addr> ","]* <obj_addr>
<obj_addr> = <prot_addr>
<prot_addr> = <iiop_prot_addr> | <miop_prot_addr>
<miop_prot_addr> = <miop_prot_token><miop_addr>
<miop_prot_token> = "miop"
<iiop_prot_token> = "iiop"
<miop_addr> = <version><group_addr>[;<group_iiop>]
<version> = <major> "." <minor> "@" | empty_string
<group_addr> = <group_id>"/"<ip_multicast_addr>
<group_iiop> = <iiop_prot_token>":"<version> <hostname>":"\
    <port> "/" <objecy_key>
<ip_multicast_addr> = <classD_IP_address> | <IPv6_address> ":" <port>
<classD_IP_address> = "224.0.0.0" - "239.255.255.255"
<port> = number (default to be defined)
<group_id> = <group component version>"-<group_domain_id>"-
    <object_group_id>["-"<object group reference version>]
<group component version> = <major> "." <minor>
<group_domain_id> = string
<object_group_id> = unsigned long long
<object group reference version> = unsigned long
<major> = number (default 1)
<minor> = number (default 0)
```

It would be written as follows below. The example URL does not use the Object Reference Version as defined in the **PortableGroup::GroupInfo**. Therefore this value must be 0 in the constructed profile. Not that both the multicast address and the group information are required. This example also supplies a **PortableGroup::GroupIOPProfile** tagged component.

```
corbaloc:miop:1.0@1.0-MyLittleDomin-1/225.1.1.8:5000;
    iiop:1.1@oma_host:1234/object_key,\
    iiop:1.2@gateway_host:1234/object_key
```

11.3 Request Issues

11.3.1 GIOP Request Message Compatibility

Client ORBs will fall into two categories when invoking operations via MIOP:

1. MIOP aware clients; and
2. MIOP unaware clients.

If the client is MIOP aware, it will use the UIPMC profile even if the IOP gateway profile is present. In addition, the MIOP aware client may make use of the **PortableGroup::GroupIOPProfile** tagged component to resolve **CORBA::Object** implicit operations and other interface specific two-way operations.

The MIOP unaware client will always use the gateway IOP profile and ignore the UIPMC profile. All calls (one-way, two-way including implicit operations) will be sent to the gateway application.

11.3.1.1 GIOP 1.2 Request Message

All requests involving MIOP operations will send the UIPMC profile along with the request. This will be placed in the **target** field of the GIOP 1.2 request header. This profile will be used by the object adapter to dispatch the request to the appropriate objects that support the interface within the confines of their object adapter. Some client ORBs may decide to set the destination endpoints to null or zero value since they are not required for message dispatching.

11.3.1.2 Object Key Support in Pre-GIOP 1.2

In order to achieve inter-ORB interoperability for MIOP, the notion of an object key had to be abandoned unless one was willing to define a common object key format for MIOP. For GIOP version 1.2, the **target** field can contain either an IOR, an object key or a tagged profile making it possible for the UIPMC profile can be sent along with the request. To insure consistency, the ORB must always send the UIPMC profile for GIOP version 1.2.

GIOP versions 1.0 and 1.1 do not have the flexibility of the **target** field in their request header. Support for these protocols must be negotiated through their **object_key** field. The encoding for pre-GIOP 1.2 versions shall be required to mark the first four octets of the sequence with 'MIOP.' ORB vendors on the receiving side that do not recognize the object key format will have to check the beginning of the sequence for the presence of the literal value 'MIOP.' The remainder of the sequence will contain the UIPMC profile as an encapsulation. This data can then be used by the object adapter to correctly dispatch the request after it is extracted from the **object_key** field.

11.3.2 MIOP Request Efficiency

There are two efficiency related scenarios for invoking requests via a UIPMC profile. Since the semantics of these requests are one-way with no remote status or exceptions, there is no way to detect the failure of a request message.

In one scenario there could be a registered object group with no members. Although this is not desirable, it is perfectly legal in MIOP since the notion of group membership is not enforced or discussed. The client in this case would be broadcasting messages to no recipients. There is nothing specified in this specification keep this from occurring. It will be the responsibility of the participating applications to make sure that group resources are cleaned up by one of the participants and that listening applications exist and are cooperating with the broadcasters.

A different scenario involves a client invoking requests on a non-existent object group or one that has been destroyed by a participating application. This scenario is detectable if the MGM is present. It is therefore advisable that the requesting objects periodically poll the MGM for the presence of the object group via two of the **CORBA::Object** implicit operations **is_a()** and **non_existent()**. These operations will return the values **false** and **true** respectively in the event that the object group no longer exists. Another alternative would be to invoke **MGM::ObjectGroupFactory::get_object_group_ref()**, which would raise an exception in the event that the object group had been deleted or could not be found.

11.3.3 Client Use Cases

The following sub clauses address specific scenarios that clients would potentially use to initiate their communication with a multicast object group.

11.3.3.1 Using the MGM

11.3.3.1.1 Creating/Finding an Object Group

The application responsible for creating object groups obtains the IOR of the **MGM::ObjectGroupManager**. The application responsible for creating object groups invokes **create_object()** and specifies a list of properties to create an object group. The IOR that is returned to the client potentially contains an IOP profile for the MIOP gateway and a UIPMC profile for multicast object group. This IOR is made available to participating group applications via some applications determined mechanism such as the Naming Service.

11.3.3.2 No MGM is Present

The application responsible for creating object groups creates an object group reference via the corbaloc scheme. The application is responsible to make sure that the **TAG_GROUP** information in the profile's component field is unique. This IOR is made available to participating group applications via some applications determined mechanism such as the Naming Service.

11.3.3.3 Gateway Application is Used

The presence of a gateway is usually an indication that the sender or some subset of senders are not MIOP aware. MIOP unaware sending applications simply invoke on the gateway reference as they would any IOP IOR and ignore the UIPMC profile.

11.3.3.4 Sender is MIOP Aware

The sending application potentially acquires a group reference with all possible profiles:

- a UIPMC profile with a **PortableGroup::GroupInfo** and a **PortableGroup::GroupIOPProfile** component; and
- an IOP profile of the gateway.

The client will choose the UIPMC profile and send its MIOP request via this profile.

11.3.3.5 Sender is MIOP Unaware

The sending application potentially acquires a group reference with all possible profiles:

- a UIPMC profile with a **PortableGroup::GroupInfo** and a **PortableGroup::GroupIOPProfile** component; and
- an IOP profile of the gateway.

The client will always choose the IOP gateway profile and send its request via this profile and ignore the UIPMC profile.

11.3.4 Server Use Cases

The following sub clauses address specific scenarios that server ORBs would potentially use to initiate their communication with a multicast object group.

11.3.4.1 Using an Object Group

1. The receiving ORB acquires a group IOR from the Naming Service.
2. The server ORB associates the group reference with a **PortableServer::ObjectIid** to provide a mechanism for dispatching requests to this servant object or collection of servant objects.
3. The server ORB will have to use the destination endpoints in the UIPMC profile to read messages from sending applications. This can be done ahead of time if the endpoints are well known or dynamically from the acquired group reference.

11.3.4.2 Gateway Application is Used

Since the gateway is acting as an advocate of the sending applications, there is no effect on the server applications. They would behave as defined in the previous sub clause.

11.3.4.3 Narrowing to a PortableGroup::GOA

Server applications that will be using the PortableGroup::GOA must first resolve initial references to the root POA and then attempt to narrow to a the appropriate type.

```
CORBA::Object_var temp =  
    orb->resolve_initial_references("RootPOA");
```

```
PortableGroup::GOA_var the_goa_poa =  
    PortableGroup::GOA::_narrow(temp);
```

11.4 Consolidated IDL

11.4.1 OMG IDL

```
#ifndef _MIOP_IDL_  
#define _MIOP_IDL_  
#ifndef _PRE_3_0_COMPILER_  
#pragma prefix "omg.org"  
#include <IOP.idl>  
#include <GIOP.idl>  
#else  
import ::IOP;  
import ::GIOP;  
#endif // _PRE_3_0_COMPILER_  
module MIOP  
{  
#ifndef _PRE_3_0_COMPILER_  
    typeprefix MIOP "omg.org";  
#endif // _PRE_3_0_COMPILER_  
    typedef sequence <octet, 252> Uniquelid;
```

```

struct PacketHeader_1_0
{
    char            magic[4];
    octet          hdr_version;
    octet          flags;
    unsigned short packet_length;
    unsigned long  packet_number;
    unsigned long  number_of_packets;
    UniqueId      Id;
};

typedef GIOP::Version Version;

typedef string Address;

struct UIPMC_ProfileBody
{
    Version        miop_version;
    Address        the_address;
    short          the_port;
    sequence<IOP::TaggedComponents> components;
};
};
#endif

#ifndef _PortableGroup_IDL_
#define _PortableGroup_IDL_

#ifndef _PRE_3_0_COMPILER_
#pragma prefix "omg.org"
#include <PortableServer.idl> // CORBA 3.0, Chapter 11
#include <CosNaming.idl> // 98-10-19.idl
#include <IOP.idl> // from 98-03-01.idl
#include "GIOP.idl" // from 98-03-01.idl
#include <orb.idl>
#else
import ::IOP;
import ::GIOP;
import ::CORBA;
import ::PortableServer::POA;
#endif // _PRE_3_0_COMPILER_
module PortableGroup {
#ifndef _PRE_3_0_COMPILER_
    typeprefix PortableGroup "omg.org";
#endif // _PRE_3_0_COMPILER_
    // Specification for Interoperable Object Group References
    typedef GIOP::Version Version;
    typedef string GroupDomainId;
    typedef unsigned long long ObjectGroupId;
    typedef unsigned long ObjectGroupRefVersion;

```

```

struct TagGroupTaggedComponent { // tag = TAG_GROUP;
    GIOP::Version group_version;
    GroupDomainId group_domain_id;
    ObjectGroupId object_group_id;
    ObjectGroupRefVersion object_group_ref_version;
};

typedef sequence <octet> GroupIIOPProfile; // tag = TAG_GROUP_IIOP

// Specification of Common Types and Exceptions
// for GroupManagement
interface GenericFactory;
typedef CORBA::RepositoryId TypedId;
typedef Object ObjectGroup;
typedef CosNaming::Name Name;
typedef any Value;

struct Property {
    Name nam;
    Value val;
};

typedef sequence<Property> Properties;
typedef Name Location;
typedef sequence<Location> Locations;
typedef Properties Criteria;

struct FactoryInfo {
    GenericFactory the_factory;
    Location the_location;
    Criteria the_criteria;
};

typedef sequence<FactoryInfo> FactoryInfos;
typedef long MembershipStyleValue;

const MembershipStyleValue MEMB_APP_CTRL = 0;
const MembershipStyleValue MEMB_INF_CTRL = 1;

typedef unsigned short InitialNumberReplicasValue;
typedef unsigned short MinimumNumberReplicasValue;

exception InterfaceNotFound {};
exception ObjectGroupNotFound {};
exception MemberNotFound {};
exception ObjectNotFound {};
exception MemberAlreadyPresent {};
exception BadReplicationStyle {};
exception ObjectNotCreated {};
exception ObjectNotAdded {};
exception UnsupportedProperty {

```

```

    Name nam;
};

exception InvalidProperty {
    Name nam;
    Value val;
};

exception NoFactory {
    Location the_location;
    Typeld type_id;
};

exception InvalidCriteria {
    Criteria invalid_criteria;
};
exception CannotMeetCriteria {
    Criteria unmet_criteria;
};

// Specification of PropertyManager Interface
interface PropertyManager {

    void set_default_properties
        (in Properties props)
        raises (InvalidProperty, UnsupportedProperty);

    Properties get_default_properties();

    void remove_default_properties
        (in Properties props)
        raises (InvalidProperty, UnsupportedProperty);

    void set_type_properties
        (in Typeld type_id, in Properties overrides)
        raises (InvalidProperty, UnsupportedProperty);

    Properties get_type_properties(in Typeld type_id);

    void remove_type_properties
        (in Typeld type_id, in Properties props)
        raises (InvalidProperty, UnsupportedProperty);

    void set_properties_dynamically
        (in ObjectGroup object_group, in Properties overrides)
        raises
            (ObjectGroupNotFound,
             InvalidProperty,
             UnsupportedProperty);

    Properties get_properties

```

```

        (in ObjectGroup object_group)
          raises(ObjectGroupNotFound);

}; // endPropertyManager

// Specification of ObjectGroupManager Interface
interface ObjectGroupManager {

  ObjectGroup create_member
    (in ObjectGroup object_group,
     in Location the_location,
     in TypedId type_id,
     in Criteria the_criteria)
    raises
      (ObjectGroupNotFound,
       MemberAlreadyPresent,
       NoFactory,
       ObjectNotCreated,
       InvalidCriteria,
       CannotMeetCriteria);

  ObjectGroup add_member
    (in ObjectGroup object_group,
     in Location the_location,
     in Object member)
    raises
      (ObjectGroupNotFound,
       CORBA::INV_OBJREF,
       MemberAlreadyPresent,
       ObjectNotAdded);

  ObjectGroup remove_member
    (in ObjectGroup object_group,
     in Location the_location)
    raises
      (ObjectGroupNotFound, MemberNotFound);

  Locations locations_of_members
    (in ObjectGroup object_group) raises(ObjectGroupNotFound);

  ObjectGroupId get_object_group_id
    (in ObjectGroup object_group) raises(ObjectGroupNotFound);

  ObjectGroup get_object_group_ref
    (in ObjectGroup object_group) raises(ObjectGroupNotFound);

  Object get_member_ref
    (in ObjectGroup object_group,
     in Location loc)
    raises(ObjectGroupNotFound, MemberNotFound);
}; // end ObjectGroupManager

```



```

// Specification of GenericFactory Interface
interface GenericFactory {
    typedef any FactoryCreationId;

    Object create_object
        (in TypedId type_id,
         in Criteria the_criteria,
         out FactoryCreationId factory_creation_id)
    raises
        (NoFactory,
         ObjectNotCreated,
         InvalidCriteria,
         InvalidProperty,
         CannotMeetCriteria);

    void delete_object
        (in FactoryCreationId factory_creation_id)
        raises (ObjectNotFound);
}; // end GenericFactory

exception NotAGroupObject {};
typedef sequence <ObjectId> IDs;

interface GOA : PortableServer::POA
    ...
PortableServer::ObjectId
    create_id_for_reference(in Object the_ref)
    raises (NotAGroupObject);

IDs
    reference_to_ids (in Object the_ref)
    raises (NotAGroupObject);

void
    associate_reference_with_id
        (in Object ref, in PortableServer::ObjectId oid)
    raises(NotAGroupObject);

void
    disassociate_reference_with_id
        (in Object ref, in PortableServer::ObjectId oid)
    raises(NotAGroupObject);

}; // end interface GOA

}; // end PortableGroup
#endif // for #ifndef _PortableGroup_IDL_

#ifndef _MGM_IDL_
#define _MGM_IDL_

```

```

#ifndef _PRE_3_0_COMPILER_
#pragma prefix "omg.org"
#include "PortableGroup.idl"
#else
import ::PortableGroup;
#endif // _PRE_3_0_COMPILER_
module MGM {
#ifndef _PRE_3_0_COMPILER_
    typeprefix MIOP "omg.org";
#endif // _PRE_3_0_COMPILER_
    // Property values

    typedef long GroupCreationMode
    const GroupCreationMode CREATE_ADDRESS_DEFERED = 0;
    const GroupCreationMode CREATE_ADDRESS_GENERATED = 1;
    const GroupCreationMode CREATE_ADDRESS_SUPPLIED = 2;

    interface ObjectGroupFactory :
        PortableGroup::GenericFactory,
        PortableGroup::PropertyManager,
        PortableGroup::ObjectGroupManager {}
};
#endif // _MGM_idl

```

12 ZIOP Protocol

The ZIOP protocol applies compression to GIOP, it is the same as GIOP Compression. ZIOP is the way to introduce compression between CORBA parties with the aim to reduce the amount of data to be transmitted on the wire. In a CORBA communication that uses ZIOP protocol, the GIOP message is compressed using a specific compression algorithm. For this purpose a compressed message is defined as ZIOP message.

The compression features will be provided to ZIOP protocol by some entities. The Compressor will be in charge of basic compression and decompression operations. The CompressorFactory will create Compressors and then CompressorFactory will be registered by the CompressionManager interface.

ORB vendors may deliver ZIOP through pluggable compressors or support a standard and well known compression algorithm.

12.1 ZIOP Messages

A ZIOP message is a GIOP message that has ZIOP as first four magical bytes instead of the regular GIOP magical bytes. GIOP compression can be applied to send or receive GIOP 1.2 and higher messages and includes fragmented messages.

```
// PIDL: ZIOP body in ZIOP Message
module ZIOP {
    struct CompressionData {
        Compression::CompressorId compressor;
        unsigned long original_length;
        Compression::Buffer data;
    };
};
```

A ZIOP message defines how the application data of the GIOP Messages is compressed: when the magic bytes are ZIOP then the data after the GIOP MessageHeader is replaced by the CompressionData structure, which contains the following items encoded in this order:

1. `compressor`: contains the identifier that indicates the compressor used for the current ZIOP message.
2. `original_length`: contains an unsigned long value that represents the GIOP body length of the current GIOP message without applying any compression.
3. `data`: is an octet sequence that contains the compressed message.

The length in the GIOP Header is updated to reflect the new message length, the other fields are unchanged as it is described below.

To allow interoperability between a ZIOP and a non ZIOP party the client that supports ZIOP will send only ZIOP messages to servers that have been declared to accept ZIOP messages.

At message level, the sequence of message exchange is as follows:

1. When client and server ORB support a compatible compression algorithm, and if the message fulfills the compression policies (for example message size threshold), the message is compressed and the four magic start bytes are changed to ZIOP. The length field in the GIOP MessageHeader is updated, all other fields are unchanged.

2. The server ORB reads the ZIOP header. It then takes the CompressionData struct and uncompresses the data. The other fields of the header and the uncompressed data can then be used as a regular GIOP message.
3. In the server side, if the GIOPReply message fulfills the compression policies, a compressor object is retrieved and server ORB will generate a compressed GIOP Reply and will send it to client where the magic bytes in the header are set to ZIOP.
4. The client ORB side will read the ZIOP magic bytes message and then will continue reading the compressed GIOP Reply and decompressing the GIOPBody.

Both client and server only send ZIOP messages when it knows that the remote ORB supports ZIOP and it has a compatible compressor implementation, as is described in the following section.

12.2 ZIOP Message use

Client and server ORBs interchange available compression details through a set of new ZIOP CORBA Policies. These policies must be propagated as standard CORBA Policies in a ServiceContext into a GIOP Request and GIOP Reply messages. They may also be propagated into an IOR by using the Messaging propagation of QoS. Policies which values are transferred to the remote ORB are called ‘client-exposed’ policies. The Messaging propagation mechanism is described in detail in section 17.3 of the CORBA 3.3 specification (Part 1 Interfaces: formal/2011-11--1).

ORB server side applications may set available compression algorithms via appointing ZIOP Policies list to the POA that will create object references that embed these policies into the IOR component. The client side ORB could send ZIOP messages defining similar Policies using PolicyContext interfaces, at ORB, thread or reference level.

As previously described servers and clients must agree on which compression algorithm will be used. To allow this, each party must know if the other party supports ZIOP and its preferences about compression before sending to it a ZIOP message.

The server must register the CORBA object in a POA that was created with ZIOP Policies. These ZIOP Policies will be transmitted as part of the IOR through the Messaging QoS Profile Component. The client may indicate through 'set_policies_overrides' over the remote CORBA object reference the ZIOP Policies which it has as preferences.

The client-side ORB will decide the compatible ZIOP Policies list which the ORB must use to send a GIOPRequest to the server. For this, the client-side ORB will extract the compression server preferences (ZIOP Policies) from a TaggedComponent of an IOR if it is present. The client will select a compression algorithm and send the application data compressed to the server. The client-side ORB will also create a Policy list with its compression policies and send them in the Request as a Messaging ServiceContext.

The server-side ORB will reply to the request taking into account the ZIOP Policies that it found in the ServiceContext of the ZIOP messaging and compare it with the ZIOP Policies of the POA object.

If the server does not allow receipt of compressed GIOP Requests, then the client-side ORB should not send any GIOP compressed messages. Instead, the client-side ORB will only send the ZIOP Policies values that the client supports in Messaging ServiceContext. In a similar way a server may not respond to a client with a compressed GIOP Reply if the client does not support GIOP compression.

In this way, a client and server may decide independently if compression could be used or not. There is no necessity to exchange CORBA messages between client and server to obtain the best set of ZIOP Policies to be applied in communication to get the optimal performance.

12.3 ZIOP Compression Policies

This module ZIOP provides all necessary elements to allow interchange of compressed GIOP messages between client and servers using mechanisms defined in Compression module. If a specific policy is not supplied, then an ORB default is used. The following interfaces are the ZIOP policies.

12.3.1 CompressionEnablingPolicy interface

This interface represents the ZIOP policy CompressionEnablingPolicy that has a boolean attribute indicating if compression is enabled or not by the tier. Only when this policy has been set to true ZIOP may be used by the ORB. This policy is client-exposed and both client and server must have set this policy to TRUE in order to enable ZIOP.

12.3.2 CompressorIdLevelListPolicy interface

This interface represents the ZIOP policy CompressorIdLevelListPolicy. It has a list of CompressorId/CompressionLevel attributes indicating the compression algorithms with their respective levels that may be used. The CompressorIdLevelListPolicy contains a sequence of structures and this sequence is ordered by preference priority. This policy is client-exposed, the client/server will take its own sequence and search for the first CompressorId that is also supported by the other tier. For this Compressor then the lowest CompressionLevel is selected.

12.3.3 CompressionLowValuePolicy interface

This interface represents the ZIOP policy CompressionLowValuePolicy. It has an unsigned long attribute indicating the minimum size of application data that has to be sent before the ORB will consider this as a ZIOP message. This policy is not client exposed.

12.3.4 CompressionMinRatioPolicy interface

This interface represents the ZIOP policy CompressionMinRatioPolicy. It has a float attribute indicating the minimum compression ratio that must be obtained at compression time to send with a compressed GIOP message. This policy tries to prevent the sending of compressed messages with few improvements about the original size in order to not overload the server with a useless decompression process. The ratio must be obtained with the following formula: $\text{compressed_length} / \text{original_length}$. This policy is not client exposed.

12.4 Propagation of ZIOP Compression Policies

ZIOP Compression policies are transferred using the Messaging QoS Profile Component that is defined in section 17.3 of the CORBA 3.3 specification (Part 1 Interfaces: formal/2012-01-01). That section also describes the concept of client-exposed policies.

12.5 Consolidated IDL

```
#pragma prefix "omg.org"
module ZIOP {
    struct CompressedData {
        Compression::CompressorId compressorid;
        unsigned long original_length;
    };
};
```

```

    Compression::Buffer data;
};

typedef boolean CompressionEnablingPolicyValue;

const CORBA::PolicyType COMPRESSION_ENABLING_POLICY_ID = 64;

local interface CompressionEnablingPolicy: CORBA::Policy
{
    readonly attribute CompressionEnablingPolicyValue compression_enabled;
};

const CORBA::PolicyType COMPRESSOR_ID_LEVEL_LIST_POLICY_ID = 65;

local interface CompressionIdLevelListPolicy: CORBA::Policy
{
    readonly attribute Compression::CompressorIdLevelList compressor_ids;
};

typedef unsigned long CompressionLowValuePolicyValue;

const CORBA::PolicyType COMPRESSION_LOW_VALUE_POLICY_ID = 66;

local interface CompressionLowValuePolicy: CORBA::Policy
{
    readonly attribute CompressionLowValuePolicyValue low_value;
};

const CORBA::PolicyType COMPRESSION_MIN_RATIO_POLICY_ID = 67;

local interface CompressionMinRatioPolicy: CORBA::Policy
{
    readonly attribute Compression::CompressionRatio ratio;
};
};

```

Annex A

IDL Tags and Exceptions

(normative)

This annex lists the standardized profile, service, component, policy tags and exception codes described in the CORBA documentation. Implementor-defined tags can also be registered in this manual. Requests to register tags with the OMG should be sent to tag_request@omg.org.

A.1 Profile ID Tags

Tag Name	Tag Value	Described in
ProfileId	TAG_INTERNET_IOP = 0	<i>Part 2 of this International Standard - Orb Interoperability Architecture Clause</i>
ProfileId	TAG_MULTIPLE_COMPONENTS = 1	<i>Part 2 of this International Standard - Orb Interoperability Architecture Clause</i>
ProfileId	TAG_SCCP_IOP = 2	CORBA/TC Interworking specification
ProfileId	TAG_UIPMC = 3	<i>Part 2 of this International Standard - Unreliable Multicast clause</i>
ProfileId	TAG_MOBILE_TERMINAL_IOP = 4	Telecom Wireless specification

A.2 Service ID Tags

Tag Name	Tag Value	Described in
ServiceId	TransactionService = 0	Object Transaction Service specification
ServiceId	CodeSets = 1	<i>Part 2 of this International Standard - ORB Interoperability Architecture</i> clause.
ServiceId	ChainBypassCheck = 2	<i>Interoperability with non-CORBA Systems</i> clause: see <i>Part 2 of this International Standard</i>
ServiceId	ChainBypassInfo = 3	<i>Interoperability with non-CORBA Systems</i> clause: see <i>Part 2 of this International Standard</i> .
ServiceId	LogicalThreadId = 4	<i>Interoperability with non-CORBA Systems</i> clause: see <i>Part 2 of this International Standard</i>
ServiceId	BI_DIR_IIOB = 5	<i>Part 2 of this International Standard - General Inter-ORB Protocol</i> clause.
ServiceId	SendingContextRunTime = 6	<i>This Part of this International Standard - Value Type Semantics</i> clause.
ServiceId	INVOCATION_POLICIES = 7	<i>This Part of this International Standard - CORBA Messaging</i> clause.
ServiceId	FORWARDED_IDENTITY = 8	Firewall Traversal specification (ptc/04-03-01)
ServiceId	UnknownExceptionInfo = 9	Java to IDL Language Mapping specification:
ServiceId	RTCORBAPriority = 10	Real-Time CORBA specification: see
ServiceId	RTCORBAPriorityRange = 11	Real-Time CORBA specification: see
ServiceId	FT_GROUP_VERSION = 12	<i>Fault Tolerant CORBA</i> clause: see CORBA, v3.0.3.
ServiceId	FT_REQUEST= 13	<i>Fault Tolerant CORBA</i> clause: see CORBA, v3.0.3.
ServiceId	ExceptionDetailMessage = 14	<i>Part 2 of this International Standard - ORB Interoperability Architecture</i> clause.
ServiceId	SecurityAttributeService = 15	<i>Part 2 of this International Standard - Secure Interoperability</i> clause.
ServiceId	ActivityService = 16	Additional Structuring Mechanisms for the OTS.
ServiceId	RMICustomMaxStreamFormat = 17	Java to IDL Language Mapping specification.
ServiceId	ACCESS_SESSION_ID = 18	Telecom Service Access Subscription (TSAS) specification.
ServiceId	SERVICE_SESSION_ID = 19	Telecom Service Access Subscription (TSAS) specification.
ServiceId	FIREWALL_PATH = 20	Firewall Traversal specification (ptc/04-03-01)
ServiceId	FIREWALL_PATH_RESP = 21	Firewall Traversal specification (ptc/04-03-01)

A.3 Component ID Tags

Tag Name	Tag Value	Described in
ComponentId	TAG_ORB_TYPE = 0	<i>CORBA 3.1, Part 2 - ORB Interoperability Architecture</i> clause.
ComponentId	TAG_CODE_SETS = 1	<i>CORBA 3.1, Part 2 - ORB Interoperability Architecture</i> clause.
ComponentId	TAG_POLICIES = 2	<i>CORBA 3.1, Part 1 - CORBA Messaging</i> clause.
ComponentId	TAG_ALTERNATE_IOP_ADDRESS = 3	<i>CORBA 3.1, Part 2 - General Inter-ORB Protocol</i> clause.
ComponentId	TAG_COMPLETE_OBJECT_KEY = 5	<i>The DCE ESIOIP</i> clause: see CORBA, v3.0.3.
ComponentId	TAG_ENDPOINT_ID_POSITION = 6	<i>The DCE ESIOIP</i> clause: see CORBA, v3.0.3.
ComponentId	TAG_LOCATION_POLICY = 12	<i>The DCE ESIOIP</i> clause: see CORBA, v3.0.3.
ComponentId	TAG_ASSOCIATION_OPTIONS = 13	Security Service specification.
ComponentId	TAG_SEC_NAME = 14	
ComponentId	TAG_SPKM_1_SEC_MECH = 15	
ComponentId	TAG_SPKM_2_SEC_MECH = 16	
ComponentId	TAG_KerberosV5_SEC_MECH = 17	
ComponentId	TAG_CSI_ECMA_Secret_SEC_MECH = 18	
ComponentId	TAG_CSI_ECMA_Hybrid_SEC_MECH = 19	
ComponentId	TAG_SSL_SEC_TRANS = 20	
ComponentId	TAG_CSI_ECMA_Public_SEC_MECH = 21	
ComponentId	TAG_GENERIC_SEC_MECH = 22	
ComponentId	TAG_FIREWALL_TRANS = 23	Firewall Traversal specification (ptc/04-03-01)
ComponentId	TAG_SCCP_CONTACT_INFO = 24	CORBA/TC Interworking and SCCP Inter-ORB Protocol specification.
ComponentId	TAG_JAVA_CODEBASE = 25	Java to IDL Language Mapping specification.
ComponentId	TAG_TRANSACTION_POLICY = 26	Object Transaction Service specification.
ComponentId	TAG_FT_GROUP = 27	<i>Fault Tolerant CORBA</i> clause: see CORBA, v3.0.3.
ComponentId	TAG_FT_PRIMARY = 28	<i>Fault Tolerant CORBA</i> clause: see CORBA, v3.0.3.
ComponentId	TAG_FT_HEARTBEAT_ENABLED = 29	<i>Fault Tolerant CORBA</i> clause: see CORBA, v3.0.3.
ComponentId	TAG_MESSAGE_ROUTERS = 30	<i>This Part of this International Standard - CORBA Messaging</i> clause.
ComponentId	TAG_OTS_POLICY = 31	Object Transaction Service specification.
ComponentId	TAG_INV_POLICY = 32	Object Transaction Service specification.
ComponentId	TAG_CSI_SEC_MECH_LIST = 33	<i>Part 2 of this International Standard - Secure Interoperability</i> clause
ComponentId	TAG_NULL_TAG = 34	<i>Part 2 of this International Standard - Secure Interoperability</i> clause

Tag Name	Tag Value	Described in
ComponentId	TAG_SECIOP_SEC_TRANS = 35	<i>Part 2 of this International Standard - Secure Interoperability clause</i>
ComponentId	TAG_TLS_SEC_TRANS = 36	<i>Part 2 of this International Standard - Secure Interoperability clause</i>
ComponentId	TAG_ACTIVITY_POLICY = 37	Additional Structuring Mechanisms for the OTS.
ComponentId	TAG_RMI_CUSTOM_MAX_STREAM_FORMAT = 38	Java to IDL Language Mapping specification.
ComponentId	TAG_GROUP = 39	<i>Part 2 of this International Standard - Unreliable Multicast clause</i>
ComponentId	TAG_GROUP_IIOB = 40	<i>Part 2 of this International Standard - Unreliable Multicast clause</i>
ComponentId	TAG_PASSTHRU_TRANS = 41	Firewall Traversal (ptc/04-03-01)
ComponentId	TAG_FIREWALL_PATH = 42	Firewall Traversal (ptc/04-03-01)
ComponentId	TAG_IIOB_SEC_TRANS = 43	Firewall Traversal (ptc/04-03-01)
ComponentId	TAG_HOME_LOCATION_INFO = 44	Telecom Wireless specification.
ComponentId	TAG_DCE_STRING_BINDING = 100	<i>The DCE ESIOP clause: see Part 2 of this International Standard</i>
ComponentId	TAG_DCE_BINDING_NAME = 101	<i>The DCE ESIOP clause: see Part 2 of this International Standard.</i>
ComponentId	TAG_DCE_NO_PIPES = 102	<i>The DCE ESIOP clause: see Part 2 of this International Standard</i>
ComponentId	TAG_DCE_SEC_MECH = 103	Security Service specification.
ComponentId	TAG_INET_SEC_TRANS = 123	Security Service specification.

A.4 Policy Type Tags

The table below lists the standard policy types that are defined by various parts of CORBA and CORBA Services in this version of CORBA/IIOP.

Issue 16922 ZIOP has to be part of the core CORBA specification

Policy Type	Policy Interface	Defined in	Uses create _policy
SecClientInvocationAccess = 1	SecurityAdmin::AccessPolicy	Security Service specification.	N
SecTargetInvocationAccess = 2	SecurityAdmin::AccessPolicy		N
SecApplicationAccess = 3	SecurityAdmin::AccessPolicy		N
SecClientInvocationAudit = 4	SecurityAdmin::AuditPolicy		N
SecTargetInvocationAudit = 5	SecurityAdmin::AuditPolicy		N
SecApplicationAudit = 6	SecurityAdmin::AuditPolicy		N
SecDelegation = 7	SecurityAdmin::Delegation Policy		N
SecClientSecureInvocation = 8	SecurityAdmin::SecureInvocationPolicy		N
SecTargetSecureInvocation = 9	SecurityAdmin::SecureInvocationPolicy		N
SecNonRepudiation = 10	NRService::NRPPolicy		N
SecConstruction = 11	CORBA::SecConstruction	<i>CORBA 3.1, Part 1 - ORB Interface</i> clause	N
SecMechanismPolicy = 12	SecurityLevel2::MechanismPolicy	Security Service specification.	Y
SecInvocationCredentialsPolicy = 13	SecurityLevel2::InvocationCredentials Policy		Y
SecFeaturesPolicy = 14	SecurityLevel2::FeaturesPolicy		Y
SecQOPPolicy = 15	SecurityLevel2::QOPPolicy		Y
THREAD_POLICY_ID = 16	PortableServer::ThreadPolicy	<i>CORBA 3.1, Part 1 - Portable Object Adapter</i> clause	Y
LIFESPAN_POLICY_ID = 17	PortableServer::LifespanPolicy		Y
ID_UNIQUENESS_POLICY_ID = 18	PortableServer::IdUniquenessPolicy		Y
ID_ASSIGNMENT_POLICY_ID = 19	PortableServer::IdAssignmentPolicy		Y
IMPLICIT_ACTIVATION_POLICY_ID = 20	PortableServer::ImplicitActivationPolicy		Y
SERVENT_RETENTION_POLICY_ID = 21	PortableServer::ServentRetentionPolicy		Y
REQUEST_PROCESSING_POLICY_ID = 22	PortableServer::RequestProcessingPolicy		Y

Policy Type	Policy Interface	Defined in	Uses create_policy
REBIND_POLICY_TYPE = 23	Messaging::RebindPolicy	<i>CORBA 3.1, Part 1 - CORBA Messaging</i> clause	Y
SYNC_SCOPE_POLICY_TYPE = 24	Messaging::SyncScopePolicy		Y
REQUEST_PRIORITY_POLICY_TYPE = 25	Messaging::RequestPriorityPolicy		Y
REPLY_PRIORITY_POLICY_TYPE = 26	Messaging::ReplyPriorityPolicy		Y
REQUEST_START_TIME_POLICY_TYPE = 27	Messaging::RequestStartTimePolicy		Y
REQUEST_END_TIME_POLICY_TYPE = 28	Messaging::RequestEndTimePolicy		Y
REPLY_START_TIME_POLICY_TYPE = 29	Messaging::ReplyStartTimePolicy		Y
REPLY_END_TIME_POLICY_TYPE = 30	Messaging::ReplyEndTimePolicy		Y
RELATIVE_REQ_TIMEOUT_POLICY_TYPE = 31	Messaging::RelativeRequestTimeoutPolicy		Y
RELATIVE_RT_TIMEOUT_POLICY_TYPE = 32	Messaging::RelativeRoundtripTimeoutPolicy		Y
ROUTING_POLICY_TYPE = 33	Messaging::RoutingPolicy		Y
MAX_HOPS_POLICY_TYPE = 34	Messaging::MaxHopsPolicy		Y
QUEUE_ORDER_POLICY_TYPE = 35	Messaging::QueueOrderPolicy		Y
FIREWALL_POLICY_TYPE = 36	Firewall::FirewallPolicy	Firewall Traversal specification: (ptc/04-03-01)	Y
BIDIRECTIONAL_POLICY_TYPE = 37	BiDirPolicy::BidirectionalPolicy	<i>Part 2 of this International Standard - General Inter-ORB Protocol</i> clause	Y
SecDelegationDirectivePolicy = 38	SecurityLevel2::DelegationDirectivePolicy	Security Service specification.	Y
SecEstablishTrustPolicy = 39	SecurityLevel2::EstablishTrustPolicy		Y
PRIORITY_MODEL_POLICY_TYPE = 40	RTCORBA::PriorityModelPolicy	Real-Time CORBA specification.	Y
THREADPOOL_POLICY_TYPE = 41	RTCORBA::ThreadpoolPolicy		Y
SERVER_PROTOCOL_POLICY_TYPE = 42	RTCORBA::ServerProtocolPolicy		Y
CLIENT_PROTOCOL_POLICY_TYPE = 43	RTCORBA::ClientProtocolPolicy		Y
PRIVATE_CONNECTION_POLICY_TYPE = 44	RTCORBA::PrivateConnectionpolicy		Y
PRIORITY_BANDED_CONNECTION_POLICY_TYPE = 45	RTCORBA::PriorityBandedConnectionPolicy		Y
TransactionPolicyType = 46	CosTransactions::TransactionPolicy	Object Transaction Service specification.	Y
REQUEST_DURATION_POLICY_TYPE = 47		<i>Fault Tolerant CORBA</i> : see CORBA, v3.0.3.	

Policy Type	Policy Interface	Defined in	Uses create_policy
HEARTBEAT_POLICY_TYPE = 48		<i>Fault Tolerant CORBA</i> : see CORBA, v3.0.3.	
HEARTBEAT_ENABLED_POLICY_TYPE = 49			
IMMEDIATE_SUSPEND_POLICY_TYPE = 50	valuetype MessageRouting::ImmediateSuspend	<i>CORBA 3.1, Part 1 - CORBA Messaging</i> clause	N
UNLIMITED_PING_POLICY_TYPE = 51	valuetype MessageRouting::UnlimitedPing		N
LIMITED_PING_POLICY_TYPE = 52	valuetype MessageRouting::LimitedPing		N
DECAY_POLICY_TYPE = 53	valuetype MessageRouting::DecayPolicy		N
RESUME_POLICY_TYPE = 54	valuetype MessageRouting::ResumePolicy		N
INVOCATION_POLICY_TYPE = 55	CosTransactions::InvocationPolicy	Object Transaction Service specification.	Y
OTS_POLICY_TYPE = 56	CosTransactions::OTSPolicy		Y
NON_TX_TARGET_POLICY_TYPE = 57	CosTransactions::NonTxTargetPolicy		Y
ActivityPolicyType = 58	CORBA::PolicyType	Additional Structuring Mechanisms for the OTS.	Y
OSA_MANAGER_POLICY = 59		Security Domain Membership (orbos/01-06-01)	
ODM_MANAGER_POLICY = 60			
PATH_SELECTION_POLICY_TYPE = 61		Firewall Traversal specification (ptc/04-03-01)	
PATH_INSERTION_POLICY_TYPE = 62			
PROCESSING_MODE_POLICY_TYPE = 63		<i>CORBA 3.1, Part 1 - Portable Interceptor</i> clause	
COMPRESSION_ENABLING_POLICY_ID = 64	CompressionEnablingPolicy	ZIOP	Y
COMPRESSOR_ID_LEVEL_LIST_POLICY_ID = 65	CompressionIdLevelListPolicy		Y
COMPRESSION_LOW_VALUE_POLICY_ID = 66	CompressionLowValuePolicy		Y
COMPRESSION_MIN_RATIO_POLICY_ID = 67	CompressionMinRatioPolicy		Y

A.5 Exception Codes

If an exception that is to be raised for an error condition does not explicitly specify a specific standard minor code for that error condition, implementations can either use a minor code of zero, or use a vendor-specific minor code to convey more detail about the error.

The following table specifies standard minor exception codes that have been assigned for the standard system exceptions. The actual value that is to be found in the **minor** field of the **ex_body** structure is obtained by or-ing the values in this table with the **OMGVMCID** constant. For example “Missing local value implementation” for the exception **NO_IMPLEMENT** would be denoted by the **minor** value **0x4f4d0001**.

SYSTEM EXCEPTION	MINOR CODE	EXPLANATION
ACTIVITY_COMPLETED	1	Activity context completed through timeout, or in some way other than requested.
ACTIVITY_REQUIRED	1	Calling thread lacks required activity context.
BAD_CONTEXT	1	IDL context not found.
	2	No matching IDL context property.

SYSTEM EXCEPTION	MINOR CODE	EXPLANATION
BAD_INV_ORDER	1	Dependency exists in IFR preventing destruction of this object.
	2	Attempt to destroy indestructible objects in IFR.
	3	Operation would deadlock.
	4	ORB has shutdown
	5	Attempt to invoke send or invoke operation of the same Request object more than once.
	6	Attempt to set a servant manager after one has already been set.
	7	ServerRequest::arguments called more than once or after a call to ServerRequest:: set_exception .
	8	ServerRequest::ctx called more than once or before ServerRequest::arguments or after ServerRequest::ctx , ServerRequest::set_result or ServerRequest::set_exception .
	9	ServerRequest::set_result called more than once or before ServerRequest::arguments or after ServerRequest::set_result or ServerRequest::set_exception .
	10	Attempt to send a DII request after it was sent previously.
	11	Attempt to poll a DII request or to retrieve its result before the request was sent.
	12	Attempt to poll a DII request or to retrieve its result after the result was retrieved previously.
	13	Attempt to poll a synchronous DII request or to retrieve results from a synchronous DII request.
	14	Invalid portable interceptor call.
	15	Service context add failed in portable interceptor because a service context with the given id already exists.
	16	Registration of PolicyFactory failed because a factory already exists for the given PolicyType .

SYSTEM EXCEPTION	MINOR CODE	EXPLANATION
	17	POA cannot create POAs while undergoing destruction
	18	Attempt to reassign priority.
	19	An OTS/XA integration xa_start call returned XAER_OUTSIDE .
	20	An OTS/XA integration xa_ call returned XAER_PROTO .
	21	Transaction context of request and client threads do not match in interceptor.
	22	Poller has not returned any response yet.
	23	Registration of TaggedProfileFactory failed because a factory already exists for the given id.
	24	Registration of TaggedComponentFactory failed because a factory already exists for the given id.
	25	Iteration has no more elements.
	26	Invocation of this operation not allowed in post_init .
BAD_OPERATION	1	ServantManager returned wrong servant type.
	2	Operation or attribute not known to target object

SYSTEM EXCEPTION	MINOR CODE	EXPLANATION
BAD_PARAM	1	Failure to register, unregister, or lookup value factory.
	2	RID already defined in IFR.
	3	Name already used in the context in IFR.
	4	Target is not a valid container.
	5	Name clash in inherited context.
	6	Incorrect type for abstract interface.
	7	string_to_object conversion failed due to bad scheme name.
	8	string_to_object conversion failed due to bad address.
	9	string_to_object conversion failed due to bad bad schema specific part.
	10	string_to_object conversion failed due to non specific reason.
	11	Attempt to derive abstract interface from non-abstract base interface in the Interface Repository.
	12	Attempt to let a ValueDef support more than one non-abstract interface in the Interface Repository.
	13	Attempt to use an incomplete TypeCode as a parameter.
	14	Invalid object id passed to POA::create_reference_by_id .
	15	Bad name argument in TypeCode operation.
	16	Bad RepositoryId argument in TypeCode operation.
	17	Invalid member name in TypeCode operation.
	18	Duplicate label value in create_union_tc .
	19	Incompatible TypeCode of label and discriminator in create_union_tc .
	20	Supplied discriminator type illegitimate in create_union_tc .
	21	Any passed to ServerRequest::set_exception does not contain an exception.
	22	Unlisted user exception passed to ServerRequest::set_exception .
	23	wchar transmission code set not in service context.
	24	Service context is not in OMG-defined range.
	25	Enum value out of range.
	26	Invalid service context Id in portable interceptor.
	27	Attempt to call register_initial_reference with a null Object .
	28	Invalid component Id in portable interceptor.
	29	Invalid profile Id in portable interceptor.

SYSTEM EXCEPTION	MINOR CODE	EXPLANATION
	30	Two or more Policy objects with the same PolicyType value supplied to Object::set_policy_overrides or PolicyManager::set_policy_overrides .
	31	Attempt to define a oneway operation with non-void result, out or inout parameters or user exceptions.
	32	DII asked to create request for an implicit operation.
	33	An OTS/XA integration xa_ call returned XAER_INVAL .
	34	Union branch modifier called with bad case label discriminator.
	35	Illegal IDL context property name.
	36	Illegal IDL property search string.
	37	Illegal IDL context name.
	38	Non-empty IDL context.
	39	Unsupported RMI/IDL custom value type stream format.
	40	ORB output stream does not support ValueOutputStream interface.
	41	ORB input stream does not support ValueInputStream interface.
	42	Character support limited to ISO 8859-1 for this object reference.
	43	Attempt to add a Pollable to a second PollableSet.
BAD_TYPECODE	1	Attempt to marshal incomplete TypeCode .
	2	Member type code illegitimate in TypeCode operation.
	3	Illegal parameter type.
CODESET_INCOMPATIBLE	1	Codeset negotiation failed.
	2	Codeset delivered in CodeSetContext is not supported by server as transmission codeset.
DATA_CONVERSION	1	Character does not map to negotiated transmission code set.
	2	Failure of PriorityMapping object.
IMP_LIMIT	1	Unable to use any profile in IOR.
INITIALIZE	1	Priority range too restricted for ORB.
INTERNAL	1	An OTS/XA integration xa_ call returned XAER_RMERR .
	2	An OTS/XA integration xa_ call returned XAER_RMFAIL .
INTF_REPOS	1	Interface Repository not available
	2	No entry for requested interface in Interface Repository
INVALID_ACTIVITY	1	Transaction or Activity resumed in wrong context, or invocation incompatible with Activity's current state.
INV_OBJREF	1	wchar Code Set support not specified.
	2	Codeset component required for type using wchar or wstring data

SYSTEM EXCEPTION	MINOR CODE	EXPLANATION
INV_POLICY	1	Unable to reconcile IOR specified policy with effective policy override.
	2	Invalid PolicyType .
	3	No PolicyFactory has been registered for the given PolicyType .
MARSHAL	1	Unable to locate value factory.
	2	ServerRequest::set_result called before ServerRequest::ctx when the operation IDL contains a context clause.
	3	NVList passed to ServerRequest::arguments does not describe all parameters passed by client.
	4	Attempt to marshal Local object.
	5	wchar or wstring data erroneously sent by client over GIOP 1.0 connection
	6	wchar or wstring data erroneously returned by server over GIOP 1.0 connection.
	7	Unsupported RMI/IDL custom value type stream format.
NO_IMPLEMENT	1	Missing local value implementation.
	2	Incompatible value implementation version.
	3	Unable to use any profile in IOR.
	4	Attempt to use DII on Local object.
	5	Biomolecular Sequence Analysis iterator cannot be reset.
	6	Biomolecular Sequence Analysis metadata is not available as XML.
	7	Genomic Maps iterator cannot be rest.
	8	Operation not implemented in local object.
NO_RESOURCES	1	Portable Interceptor operation not supported in this binding.
	2	No connection for request's priority.
NO_RESPONSE	1	Reply is not available immediately in a non-blocking call.
OBJ_ADAPTER	1	System exception in AdapterActivator::unknown_adapter .
	2	Incorrect servant type returned by servant manager.
	3	No default servant available [POA policy].
	4	No servant manager available [POA Policy].
	5	Violation of POA policy by ServantActivator::incarnate .
	6	Exception in PortableInterceptor::IORInterceptor.components_established .
	7	Null servant returned by servant manager

SYSTEM EXCEPTION	MINOR CODE	EXPLANATION
OBJECT_NOT_EXIST	1	Attempt to pass an unactivated (unregistered) value as an object reference.
	2	Failed to create or locate Object Adapter.
	3	Biomolecular Sequence Analysis Service is no longer available.
	4	Object Adapter inactive.
	5	This Poller has already delivered a reply to some client.
TIMEOUT	1	Reply is not available in the Poller by the timeout set for it.
	2	End time specified in RequestEndTimePolicy or RelativeRequestTimeoutPolicy has expired.
	3	End time specified in ReplyEndTimePolicy or RelativeReplyTimeoutPolicy has expired.
TRANSACTION_ROLLEDBACK	1	An OTS/XA integration xa_ call returned XAER_RB .
	2	An OTS/XA integration xa_ call returned XAER_NOTA .
	3	OTS/XA integration end was called with success set to TRUE while transaction rollback was deferred.
	4	Deferred transaction rolled back.
TRANSIENT	1	Request discarded because of resource exhaustion in POA , or because POA is in discarding state.
	2	No usable profile in IOR.
	3	Request cancelled.
	4	POA destroyed.
UNKNOWN	1	Unlisted user exception received by client.
	2	Non-standard System Exception not supported.
	3	An unknown user exception received by a portable interceptor.

A.6 Identity Tokens

The following identity tokens are defined in the Security Context clause (*Part 2 of this International Standard*) and the Firewall Traversal specification (ptc/04-03-01). These tokens must be powers of two.

- ITTAbsent = 0;
- ITTAnonymous = 1;
- ITTPrincipalName = 2;
- ITTX509CertChain = 4;
- ITTDistinguishedName = 8;
- ITTCompoundToken = 16;