Common Object Request Broker Architecture: Core Specification



This is the common core of the CORBA specification. Optional parts of CORBA, such as mappings to particular programming languages, Real-time CORBA extensions, and the minimum CORBA profile for embedded systems are documented in the other specifications that together comprise the complete CORBA specification. Please visit the CORBA download page at http://www.omg.org/technology/documents/corba_spec_catalog.htm to find the complete CORBA specification set.

November 2002
Version 3.0 - Editorial edit to cover
formal/02-11-03



An Adopted Specification of the Object Management Group, Inc.

Copyright © 1998, 1999, Alcatel
Copyright © 1997, 1998, 1999 BEA Systems, Inc.
Copyright © 1995, 1996 BNR Europe Ltd.
Copyright © 1998, Borland International
Copyright © 1998, Cooperative Research Centre for Distributed Systems Technology (DSTC Pty Ltd)
Copyright © 2001, Concept Five Technologies
Copyright © 1991, 1992, 1995, 1996, Digital Equipment Corporation
Copyright © 2001, Eternal Systems, Inc.
Copyright © 1995, 1996, 1998, Expersoft Corporation
Copyright © 1996, 1997 FUJITSU LIMITED
Copyright © 1996, Genesis Development Corporation
Copyright © 1989- 2001, Hewlett-Packard Company
Copyright © 2001, HighComm
Copyright © 1998, 1999, Highlander Communications, L.C.
Copyright © 1991, 1992, 1995, 1996 HyperDesk Corporation
Copyright © 1998, 1999, Inprise Corporation
Copyright © 1996 - 2001, International Business Machines Corporation
Copyright © 1995, 1996 ICL, plc
Copyright © 1998 - 2001, Inprise Corporation
Copyright © 1998, International Computers, Ltd.
Copyright © 1995 - 2001, IONA Technologies, Ltd.
Copyright © 1998 - 2001, Lockheed Martin Federal Systems, Inc.
Copyright © 1998, 1999, 2001, Lucent Technologies, Inc.
Copyright © 1996, 1997 Micro Focus Limited
Copyright © 1991, 1992, 1995, 1996 NCR Corporation
Copyright © 1998, NEC Corporation
Copyright © 1998, Netscape Communications Corporation
Copyright © 1998, 1999, Nortel Networks
Copyright © 1998, 1999, Northern Telecom Corporation
Copyright © 1995, 1996, 1998, Novell USG
Copyright © 1991, 1992, 1995, 1996 by Object Design, Inc.
Copyright © 1991- 2001 Object Management Group, Inc.
Copyright © 1998, 1999, 2001, Objective Interface Systems, Inc.
Copyright © 1998, 1999, Object-Oriented Concepts, Inc.
Copyright © 1998, 2001, Oracle Corporation
Copyright © 1998, PeerLogic, Inc.
Copyright © 1996, Siemens Nixdorf Informationssysteme AG
Copyright © 1991 - 2001, Sun Microsystems, Inc.
Copyright © 1995, 1996, SunSoft, Inc.
Copyright © 1996, Sybase, Inc.
Copyright © 1998, Telefónica Investigación y Desarrollo S.A. Unipersonal
Copyright © 1998, TIBCO, Inc.
Copyright © 1998, 1999, Tri-Pacific Software, Inc.
Copyright © 1996, Visual Edge Software, Ltd.

USE OF SPECIFICATION - TERMS, CONDITIONS & NOTICES

The material in this document details an Object Management Group specification in accordance with the terms, conditions and notices set forth below. This document does not represent a commitment to implement any portion of this specification in any company's products. The information contained in this document is subject to change without notice.

LICENSES

The companies listed above have granted to the Object Management Group, Inc. (OMG) a nonexclusive, royalty-free, paid up, worldwide license to copy and distribute this document and to modify this document and distribute copies of the modified version. Each of the copyright holders listed above has agreed that no person shall be deemed to have infringed the copyright in the included material of any such copyright holder by reason of having used the specification set forth herein or having conformed any computer software to the specification.

Subject to all of the terms and conditions below, the owners of the copyright in this specification hereby grant you a fully-paid up, non-exclusive, nontransferable, perpetual, worldwide license (without the right to sublicense), to use this specification to create and distribute software and special purpose specifications that are based upon this specification, and to use, copy, and distribute this specification as provided under the Copyright Act; provided that: (1) both the copyright notice identified above and this permission notice appear on any copies of this specification; (2) the use of the specifications is for informational purposes and will not be copied or posted on any network computer or broadcast in any media and will not be otherwise resold or transferred for commercial purposes; and (3) no modifications are made to this specification. This limited permission automatically terminates without notice if you breach any of these terms or conditions. Upon termination, you will destroy immediately any copies of the specifications in your possession or control.

PATENTS

The attention of adopters is directed to the possibility that compliance with or adoption of OMG specifications may require use of an invention covered by patent rights. OMG shall not be responsible for identifying patents for which a license may be required by any OMG specification, or for conducting legal inquiries into the legal validity or scope of those patents that are brought to its attention. OMG specifications are prospective and advisory only. Prospective users are responsible for protecting themselves against liability for infringement of patents.

GENERAL USE RESTRICTIONS

Any unauthorized use of this specification may violate copyright laws, trademark laws, and communications regulations and statutes. This document contains information which is protected by copyright. All Rights Reserved. No part of this work covered by copyright herein may be reproduced or used in any form or by any means--graphic, electronic, or mechanical, including photocopying, recording, taping, or information storage and retrieval systems--without permission of the copyright owner.

DISCLAIMER OF WARRANTY

WHILE THIS PUBLICATION IS BELIEVED TO BE ACCURATE, IT IS PROVIDED "AS IS" AND MAY CONTAIN ERRORS OR MISPRINTS. THE OBJECT MANAGEMENT GROUP AND THE COMPANIES LISTED ABOVE MAKE NO WARRANTY OF ANY KIND, EXPRESS OR IMPLIED, WITH REGARD TO THIS PUBLICATION, INCLUDING BUT NOT LIMITED TO ANY WARRANTY OF TITLE OR OWNERSHIP, IMPLIED WARRANTY OF MERCHANTABILITY OR WARRANTY OF FITNESS FOR A PARTICULAR PURPOSE OR USE. IN NO EVENT SHALL THE OBJECT MANAGEMENT GROUP OR ANY OF THE COMPANIES LISTED ABOVE BE LIABLE FOR ERRORS CONTAINED HEREIN OR FOR DIRECT, INDIRECT, INCIDENTAL, SPECIAL, CONSEQUENTIAL, RELIANCE OR COVER DAMAGES, INCLUDING LOSS OF PROFITS, REVENUE, DATA OR USE, INCURRED BY ANY USER OR ANY THIRD PARTY IN CONNECTION WITH THE FURNISHING, PERFORMANCE, OR USE OF THIS MATERIAL, EVEN IF ADVISED OF THE POSSIBILITY OF SUCH DAMAGES.

The entire risk as to the quality and performance of software developed using this specification is borne by you. This disclaimer of warranty constitutes an essential part of the license granted to you to use this specification.

RESTRICTED RIGHTS LEGEND

Use, duplication or disclosure by the U.S. Government is subject to the restrictions set forth in subparagraph (c) (1) (ii) of The Rights in Technical Data and Computer Software Clause at DFARS 252.227-7013 or in subparagraph (c)(1) and (2) of the Commercial Computer Software - Restricted Rights clauses at 48 C.F.R. 52.227-19 or as specified in 48 C.F.R. 227-7202-2 of the DoD F.A.R. Supplement and its successors, or as specified in 48 C.F.R. 12.212 of the Federal Acquisition Regulations and its successors, as applicable. The specification copyright owners are as indicated above and may be contacted through the Object Management Group, 250 First Avenue, Needham, MA 02494, U.S.A.

TRADEMARKS

The OMG Object Management Group Logo®, CORBA®, CORBA Academy®, The Information Brokerage®, XMI® and IIOP® are registered trademarks of the Object Management Group. OMG™, Object Management Group™, CORBA logos™, OMG Interface Definition Language (IDL)™, The Architecture of Choice for a Changing World™, CORBA services™, CORBA facilities™, CORBA med™, CORBA net™, Integrate 2002™, Middleware That's Everywhere™, UML™, Unified Modeling Language™, The UML Cube logo™, MOF™, CWM™, The CWM Logo™, Model Driven Architecture™, Model Driven Architecture Logos™, MDA™, OMG Model Driven Architecture™, OMG MDA™ and the XMI Logo™ are trademarks of the Object Management Group. All other products or company names mentioned are used for identification purposes only, and may be trademarks of their respective owners.

COMPLIANCE

The copyright holders listed above acknowledge that the Object Management Group (acting itself or through its designees) is and shall at all times be the sole entity that may authorize developers, suppliers and sellers of computer software to use certification marks, trademarks or other special designations to indicate compliance with these materials.

Software developed under the terms of this license may claim compliance or conformance with this specification if and only if the software compliance is of a nature fully matching the applicable compliance points as stated in the specification. Software developed only partially matching the applicable compliance points may claim only that the software was based on this specification, but may not claim compliance or conformance with this specification. In the event that testing suites are implemented or approved by Object Management Group, Inc., software developed using this specification may claim compliance or conformance with the specification only if the software satisfactorily completes the testing suites.

ISSUE REPORTING

All OMG specifications are subject to continuous review and improvement. As part of this process we encourage readers to report any ambiguities, inconsistencies, or inaccuracies they may find by completing the Issue Reporting Form listed on the main web page <http://www.omg.org>, under Documents & Specifications, Report a Bug/Issue.

Contents

Preface	xxiii
1. The Object Model	1-1
1.1 Overview	1-1
1.2 Object Semantics	1-2
1.2.1 Objects	1-2
1.2.2 Requests	1-3
1.2.3 Object Creation and Destruction	1-4
1.2.4 Types	1-4
1.2.5 Interfaces	1-6
1.2.6 Value Types	1-6
1.2.7 Abstract Interfaces	1-7
1.2.8 Operations	1-7
1.2.9 Attributes	1-9
1.3 Object Implementation	1-9
1.3.1 The Execution Model: Performing Services	1-9
1.3.2 The Construction Model	1-10
2. CORBA Overview	2-1
2.1 Structure of an Object Request Broker	2-1
2.1.1 Object Request Broker	2-6
2.1.2 Clients	2-7
2.1.3 Object Implementations	2-7
2.1.4 Object References	2-8
2.1.5 OMG Interface Definition Language	2-8
2.1.6 Mapping of OMG IDL to Programming Languages	2-8
2.1.7 Client Stubs	2-9
2.1.8 Dynamic Invocation Interface	2-9
2.1.9 Implementation Skeleton	2-9
2.1.10 Dynamic Skeleton Interface	2-10

2.1.11	Object Adapters	2-10
2.1.12	ORB Interface	2-10
2.1.13	Interface Repository	2-11
2.1.14	Implementation Repository	2-11
2.2	Example ORBs	2-11
2.2.1	Client- and Implementation-resident ORB	2-11
2.2.2	Server-based ORB	2-12
2.2.3	System-based ORB	2-12
2.2.4	Library-based ORB	2-12
2.3	Structure of a Client	2-12
2.4	Structure of an Object Implementation.	2-13
2.5	Structure of an Object Adapter.	2-15
2.6	CORBA Required Object Adapter.	2-17
2.6.1	Portable Object Adapter	2-17
2.7	The Integration of Foreign Object Systems	2-17
3.	OMG IDL Syntax and Semantics	3-1
3.1	Overview	3-2
3.2	Lexical Conventions.	3-3
3.2.1	Tokens	3-6
3.2.2	Comments	3-6
3.2.3	Identifiers.	3-6
3.2.4	Keywords.	3-8
3.2.5	Literals.	3-8
3.3	Preprocessing	3-11
3.4	OMG IDL Grammar.	3-12
3.5	OMG IDL Specification	3-18
3.6	Import Declaration	3-19
3.7	Module Declaration	3-20
3.8	Interface Declaration	3-21
3.8.1	Interface Header	3-21
3.8.2	Interface Inheritance Specification	3-21
3.8.3	Interface Body	3-22
3.8.4	Forward Declaration	3-22
3.8.5	Interface Inheritance	3-23
3.8.6	Abstract Interface	3-26
3.8.7	Local Interface.	3-26
3.9	Value Declaration	3-27
3.9.1	Regular Value Type	3-27
3.9.2	Boxed Value Type	3-29
3.9.3	Abstract Value Type.	3-30
3.9.4	Value Forward Declaration	3-30
3.9.5	Valuetype Inheritance	3-31

3.10	Constant Declaration	3-32
	3.10.1 Syntax	3-32
	3.10.2 Semantics	3-33
3.11	Type Declaration	3-36
	3.11.1 Basic Types	3-37
	3.11.2 Constructed Types	3-39
	3.11.3 Template Types	3-44
	3.11.4 Complex Declarator	3-46
	3.11.5 Native Types	3-46
	3.11.6 Deprecated Anonymous Types	3-47
3.12	Exception Declaration	3-49
3.13	Operation Declaration	3-50
	3.13.1 Operation Attribute	3-51
	3.13.2 Parameter Declarations	3-51
	3.13.3 Raises Expressions	3-52
	3.13.4 Context Expressions	3-53
3.14	Attribute Declaration	3-53
3.15	Repository Identity Related Declarations	3-54
	3.15.1 Repository Identity Declaration	3-54
	3.15.2 Repository Identifier Prefix Declaration	3-56
3.16	Event Declaration	3-56
	3.16.1 Regular Event Type	3-56
	3.16.2 Abstract Event Type	3-57
	3.16.3 Event Forward Declaration	3-57
	3.16.4 Eventtype Inheritance	3-57
3.17	Component Declaration	3-58
	3.17.1 Component	3-58
	3.17.2 Component Header	3-59
	3.17.3 Component Body	3-60
	3.17.4 Event Sources—publishers and emitters	3-61
	3.17.5 Event Sinks	3-62
	3.17.6 Basic and Extended Components	3-63
3.18	Home Declaration	3-63
	3.18.1 Home	3-63
	3.18.2 Home Header	3-64
	3.18.3 Home Body	3-64
3.19	CORBA Module	3-66
3.20	Names and Scoping	3-67
	3.20.1 Qualified Names	3-67
	3.20.2 Scoping Rules and Name Resolution	3-69
	3.20.3 Special Scoping Rules for Type Names	3-72
4.	ORB Interface	4-1
	4.1 Overview	4-1

Contents

4.2	The ORB Operations	4-2
4.2.1	ORB Identity	4-8
4.2.2	Converting Object References to Strings	4-8
4.2.3	Getting Service Information	4-9
4.2.4	Creating a New Context	4-9
4.2.5	Thread-Related Operations	4-9
4.3	Object Reference Operations	4-12
4.3.1	Determining the Object Interface	4-14
4.3.2	Duplicating and Releasing Copies of Object References	4-14
4.3.3	Nil Object References	4-15
4.3.4	Equivalence Checking Operation	4-15
4.3.5	Probing for Object Non-Existence	4-16
4.3.6	Object Reference Identity	4-16
4.3.7	Type Coercion Considerations	4-18
4.3.8	Getting Policy Associated with the Object	4-18
4.3.9	Overriding Associated Policies on an Object Reference	4-20
4.3.10	Validating Connection	4-21
4.3.11	Getting the Domain Managers Associated with the Object	4-21
4.3.12	Getting Component Associated with the Object	4-22
4.3.13	LocalObject Operations	4-22
4.4	ValueBase Operations	4-23
4.5	ORB and OA Initialization and Initial References	4-24
4.5.1	ORB Initialization	4-24
4.5.2	Obtaining Initial Object References	4-27
4.5.3	Configuring Initial Service References	4-29
4.6	Context Object	4-32
4.6.1	Introduction	4-32
4.6.2	Context Object Operations	4-32
4.7	Current Object	4-36
4.8	Policy Object	4-37
4.8.1	Definition of Policy Object	4-37
4.8.2	Creation of Policy Objects	4-38
4.8.3	Usages of Policy Objects	4-40
4.8.4	Policy Associated with the Execution Environment	4-40
4.8.5	Specification of New Policy Objects	4-41
4.8.6	Standard Policies	4-43
4.9	Management of Policies	4-43
4.9.1	Client Side Policy Management	4-43
4.9.2	Server Side Policy Management	4-44
4.9.3	Policy Management Interfaces	4-44
4.10	Management of Policy Domains	4-46

4.10.1	Basic Concepts	4-46
4.10.2	Domain Management Operations	4-49
4.11	TypeCodes	4-52
4.11.1	The TypeCode Interface	4-52
4.11.2	TypeCode Constants	4-57
4.11.3	Creating TypeCodes	4-58
4.12	Exceptions	4-62
4.12.1	Definition of Terms	4-62
4.12.2	System Exceptions	4-63
4.12.3	Standard System Exception Definitions	4-65
4.12.4	Standard Minor Exception Codes	4-72
5.	Value Type Semantics	5-1
5.1	Overview	5-1
5.2	Architecture	5-2
5.2.1	Abstract Values	5-3
5.2.2	Operations	5-3
5.2.3	Value Type vs. Interfaces	5-4
5.2.4	Parameter Passing	5-4
5.2.5	Substitutability Issues	5-5
5.2.6	Widening/Narrowing	5-6
5.2.7	Value Base Type	5-6
5.2.8	Life Cycle issues	5-7
5.2.9	
	Security Considerations	5-7
5.3	Standard Value Box Definitions	5-9
5.4	Language Mappings	5-9
5.4.1	General Requirements	5-9
5.4.2	Language Specific Marshaling	5-9
5.4.3	Language Specific Value Factory Requirements ...	5-9
5.4.4	Value Method Implementation	5-10
5.5	Custom Marshaling	5-10
5.5.1	Implementation of Custom Marshaling	5-11
5.5.2	Marshaling Streams	5-11
5.6	Access to the Sending Context Run Time	5-18
6.	Abstract Interface Semantics	6-1
6.1	Overview	6-1
6.2	Semantics of Abstract Interfaces	6-1
6.3	Usage Guidelines	6-3
6.4	Example	6-3
6.5	Security Considerations	6-4
6.5.1	Passing Values to Trusted Domains	6-4

Contents

7.	Dynamic Invocation Interface	7-1
7.1	Overview	7-1
7.1.1	Common Data Structures.	7-2
7.1.2	Memory Usage	7-4
7.1.3	Return Status and Exceptions	7-4
7.2	Request Operations	7-4
7.2.1	create_request	7-5
7.2.2	add_arg	7-7
7.2.3	invoke	7-8
7.2.4	delete	7-8
7.2.5	send	7-8
7.2.6	poll_response.	7-9
7.2.7	get_response	7-9
7.2.8	sendp	7-10
7.2.9	prepare.	7-10
7.2.10	sendc	7-10
7.3	ORB Operations	7-11
7.3.1	send_multiple_requests	7-11
7.3.2	get_next_response and poll_next_response	7-11
7.4	Polling	7-12
7.4.1	Abstract Valuetype Pollable	7-14
7.4.2	Abstract Valuetype DIIPollable	7-14
7.4.3	interface PollableSet	7-14
7.5	List Operations	7-16
7.5.1	create_list	7-17
7.5.2	add_item	7-17
7.5.3	free.	7-18
7.5.4	free_memory	7-18
7.5.5	get_count.	7-18
7.5.6	create_operation_list	7-18
8.	Dynamic Skeleton Interface	8-1
8.1	Introduction	8-1
8.2	Overview	8-2
8.3	ServerRequestPseudo-Object	8-3
8.3.1	ExplicitRequest State: ServerRequestPseudo-Object.	8-3
8.4	DSI: Language Mapping	8-4
8.4.1	ServerRequest's Handling of Operation Parameters	8-4
8.4.2	Registering Dynamic Implementation Routines	8-5
9.	Dynamic Management of Any Values	9-1
9.1	Overview	9-1
9.2	DynAny API.	9-3

9.2.1	Creating a DynAny Object	9-9
9.2.2	The DynAny Interface	9-11
9.2.3	The DynFixed Interface	9-16
9.2.4	The DynEnum Interface	9-17
9.2.5	The DynStruct Interface	9-17
9.2.6	The DynUnion Interface	9-19
9.2.7	The DynSequence Interface	9-22
9.2.8	The DynArray Interface	9-23
9.2.9	The DynValueCommon Interface	9-24
9.2.10	The DynValue Interface	9-24
9.2.11	The DynValueBox Interface	9-25
9.3	Usage in C++ Language	9-26
9.3.1	Dynamic Creation of CORBA::Any Values	9-26
9.3.2	Dynamic Interpretation of CORBA::Any Values	9-27
10.	The Interface Repository	10-1
10.1	Overview	10-1
10.2	Scope of an Interface Repository	10-2
10.3	Implementation Dependencies	10-4
10.3.1	Managing Interface Repositories	10-4
10.4	Basics	10-5
10.4.1	Names and Identifiers	10-6
10.4.2	Types and TypeCodes	10-6
10.4.3	Interface Repository Objects	10-6
10.4.4	Structure and Navigation of the Interface Repository	10-8
10.5	Interface Repository Interfaces	10-11
10.5.1	Supporting Type Definitions	10-12
10.5.2	IObject	10-13
10.5.3	Contained	10-14
10.5.4	Container	10-16
10.5.5	IDLType	10-22
10.5.6	Repository	10-22
10.5.7	ModuleDef	10-24
10.5.8	ConstantDef	10-25
10.5.9	TypedefDef	10-26
10.5.10	StructDef	10-26
10.5.11	UnionDef	10-27
10.5.12	EnumDef	10-28
10.5.13	AliasDef	10-28
10.5.14	PrimitiveDef	10-29
10.5.15	StringDef	10-29
10.5.16	WstringDef	10-30
10.5.17	FixedDef	10-30
10.5.18	SequenceDef	10-30

10.5.19	ArrayDef	10-31
10.5.20	ExceptionDef	10-32
10.5.21	AttributeDef	10-32
10.5.22	ExtAttributeDef	10-33
10.5.23	OperationDef	10-34
10.5.24	InterfaceDef	10-36
10.5.25	ExtInterfaceDef	10-38
10.5.26	AbstractInterfaceDef	10-39
10.5.27	ExtAbstractInterfaceDef	10-41
10.5.28	LocalInterfaceDef	10-41
10.5.29	ExtLocalInterfaceDef	10-43
10.5.30	ValueMemberDef	10-43
10.5.31	ValueDef	10-44
10.5.32	ExtValueDef	10-48
10.5.33	ValueBoxDef	10-49
10.5.34	NativeDef	10-50
10.6	Component Interface Repository Interfaces	10-50
10.6.1	ComponentIR::Container	10-50
10.6.2	ComponentIR::Repository	10-52
10.6.3	ComponentIR::ProvidesDef	10-53
10.6.4	ComponentIR::UsesDef	10-53
10.6.5	ComponentIR::EventDef	10-54
10.6.6	ComponentIR::EventPortDef	10-55
10.6.7	ComponentIR::EmitsDef	10-56
10.6.8	ComponentIR::PublishesDef	10-56
10.6.9	ComponentIR::ConsumesDef	10-57
10.6.10	ComponentIR::ComponentDef	10-57
10.6.11	ComponentIR::FactoryDef	10-60
10.6.12	ComponentIR::FinderDef	10-61
10.6.13	ComponentIR::HomeDef	10-62
10.7	RepositoryIds	10-64
10.7.1	OMG IDL Format	10-65
10.7.2	RMI Hashed Format	10-65
10.7.3	DCE UUID Format	10-67
10.7.4	LOCAL Format	10-67
10.7.5	Pragma Directives for RepositoryId	10-67
10.7.6	For More Information	10-73
10.7.7	RepositoryIDs for OMG-Specified Types	10-73
10.7.8	Uniqueness Constraints on Repository IDs	10-73
10.8	OMG IDL for Interface Repository	10-75
11.	The Portable Object Adapter	11-1
11.1	Overview	11-1
11.2	Abstract Model Description	11-2
11.2.1	Model Components	11-2
11.2.2	Model Architecture	11-4

	11.2.3 POA Creation	11-6
	11.2.4 Reference Creation	11-7
	11.2.5 Object Activation States	11-8
	11.2.6 Request Processing	11-9
	11.2.7 Implicit Activation.	11-10
	11.2.8 Multi-threading	11-11
	11.2.9 Dynamic Skeleton Interface.	11-13
	11.2.10 Location Transparency.	11-14
11.3	Interfaces	11-14
	11.3.1 The Servant IDL Type	11-15
	11.3.2 POAManager Interface	11-15
	11.3.3 POAManagerFactory Interface	11-21
	11.3.4 AdapterActivator Interface	11-22
	11.3.5 ServantManager Interface	11-24
	11.3.6 ServantActivator Interface	11-25
	11.3.7 ServantLocator Interface	11-27
	11.3.8 POA Policy Objects.	11-30
	11.3.9 POA Interface	11-34
	11.3.10 Current Operations.	11-45
11.4	IDL for PortableServer Module	11-46
11.5	UML Description of PortableServer.	11-52
11.6	Usage Scenarios	11-54
	11.6.1 Getting the Root POA	11-54
	11.6.2 Creating a POA	11-55
	11.6.3 Explicit Activation with POA-assigned Object Ids	11-55
	11.6.4 Explicit Activation with User-assigned Object Ids	11-56
	11.6.5 Creating References before Activation	11-57
	11.6.6 Servant Manager Definition and Creation	11-57
	11.6.7 Object Activation on Demand	11-59
	11.6.8 Persistent Objects with POA-assigned Ids.	11-60
	11.6.9 Multiple Object Ids Mapping to a Single Servant	11-61
	11.6.10 One Servant for All Objects.	11-61
	11.6.11 Single Servant, Many Objects and Types, Using DSI.	11-64
12.	Interoperability Overview	12-1
	12.1 Elements of Interoperability	12-1
	12.1.1 ORB Interoperability Architecture	12-2
	12.1.2 Inter-ORB Bridge Support.	12-2
	12.1.3 General Inter-ORB Protocol (GIOP)	12-3
	12.1.4 Internet Inter-ORB Protocol (IIOP)®	12-3
	12.1.5 Environment-Specific Inter-ORB Protocols (ESIOPs)	12-4
12.2	Relationship to Previous Versions of CORBA	12-4
12.3	Examples of Interoperability Solutions	12-5

12.3.1	Example 1	12-5
12.3.2	Example 2	12-5
12.3.3	Example 3	12-5
12.3.4	Interoperability Compliance	12-5
12.4	Motivating Factors	12-8
12.4.1	ORB Implementation Diversity	12-8
12.4.2	ORB Boundaries	12-8
12.4.3	ORBs Vary in Scope, Distance, and Lifetime	12-9
12.5	Interoperability Design Goals.	12-9
12.5.1	Non-Goals	12-10
13.	ORB Interoperability Architecture	13-1
13.1	Overview	13-1
13.1.1	Domains	13-2
13.1.2	Bridging Domains	13-2
13.2	ORBs and ORB Services	13-3
13.2.1	The Nature of ORB Services	13-3
13.2.2	ORB Services and Object Requests	13-3
13.2.3	Selection of ORB Services	13-4
13.3	Domains	13-5
13.3.1	Definition of a Domain	13-5
13.3.2	Mapping Between Domains: Bridging.	13-6
13.4	Interoperability Between ORBs	13-7
13.4.1	ORB Services and Domains	13-7
13.4.2	ORBs and Domains	13-7
13.4.3	Interoperability Approaches	13-8
13.4.4	Policy-Mediated Bridging	13-10
13.4.5	Configurations of Bridges in Networks	13-11
13.5	Object Addressing	13-11
13.5.1	Domain-relative Object Referencing	13-12
13.5.2	Handling of Referencing Between Domains	13-12
13.6	An Information Model for Object References	13-14
13.6.1	What Information Do Bridges Need?	13-14
13.6.2	Interoperable Object References: IORs	13-14
13.6.3	IOR Profiles.	13-15
13.6.4	Standard IOR Profiles	13-17
13.6.5	IOR Components	13-18
13.6.6	Standard IOR Components	13-19
13.6.7	Profile and Component Composition in IORs	13-22
13.6.8	IOR Creation and Scope	13-22
13.6.9	Stringified Object References	13-22
13.6.10	Object URLs	13-24
13.7	Service Context	13-28
13.7.1	Standard Service Contexts.	13-30

13.7.2	Service Context Processing Rules	13-31
13.8	Coder/Decoder Interfaces	13-32
13.8.1	Codec Interface	13-32
13.8.2	Codec Factory	13-34
13.9	Feature Support and GIOP Versions	13-35
13.10	Code Set Conversion	13-37
13.10.1	Character Processing Terminology	13-37
13.10.2	Code Set Conversion Framework	13-40
13.10.3	Mapping to Generic Character Environments	13-48
13.10.4	Example of Generic Environment Mapping	13-49
13.10.5	Relevant OSFM Registry Interfaces	13-50
14.	Building Inter-ORB Bridges	14-1
14.1	Introduction	14-1
14.2	In-Line and Request-Level Bridging	14-2
14.2.1	In-line Bridging	14-3
14.2.2	Request-level Bridging	14-3
14.2.3	Collocated ORBs	14-4
14.3	Proxy Creation and Management	14-5
14.4	Interface-specific Bridges and Generic Bridges	14-6
14.5	Building Generic Request-Level Bridges	14-6
14.6	Bridging Non-Referencing Domains	14-7
14.7	Bootstrapping Bridges	14-7
15.	General Inter-ORB Protocol	15-1
15.1	Goals of the General Inter-ORB Protocol	15-2
15.2	GIOP Overview	15-2
15.2.1	Common Data Representation (CDR)	15-3
15.2.2	GIOP Message Overview	15-3
15.2.3	GIOP Message Transfer	15-4
15.3	CDR Transfer Syntax	15-4
15.3.1	Primitive Types	15-5
15.3.2	OMG IDL Constructed Types	15-11
15.3.3	Encapsulation	15-14
15.3.4	Value Types	15-15
15.3.5	Pseudo-Object Types	15-23
15.3.6	Object References	15-30
15.3.7	Abstract Interfaces	15-30
15.4	GIOP Message Formats	15-31
15.4.1	GIOP Message Header	15-31
15.4.2	Request Message	15-34
15.4.3	Reply Message	15-37
15.4.4	CancelRequest Message	15-41

Contents

15.4.5	LocateRequest Message	15-41
15.4.6	LocateReply Message	15-43
15.4.7	CloseConnection Message	15-45
15.4.8	MessageError Message	15-45
15.4.9	Fragment Message	15-45
15.5	GIOP Message Transport	15-47
15.5.1	Connection Management	15-47
15.5.2	Message Ordering	15-49
15.6	Object Location	15-50
15.7	Internet Inter-ORB Protocol (IIOP)	15-51
15.7.1	TCP/IP Connection Usage	15-52
15.7.2	IIOP IOR Profiles	15-52
15.7.3	IIOP IOR Profile Components	15-55
15.8	Bi-Directional GIOP	15-56
15.8.1	Bi-Directional IIOP	15-58
15.9	Bi-directional GIOP policy	15-60
15.10	OMG IDL	15-60
15.10.1	GIOP Module	15-60
15.10.2	IIOP Module	15-64
15.10.3	BiDirPolicy Module	15-65
16.	The DCE ESIOP	16-1
16.1	Goals of the DCE Common Inter-ORB Protocol	16-1
16.2	DCE Common Inter-ORB Protocol Overview	16-2
16.2.1	DCE-CIOP RPC	16-2
16.2.2	DCE-CIOP Data Representation	16-3
16.2.3	DCE-CIOP Messages	16-4
16.2.4	Interoperable Object Reference (IOR)	16-5
16.3	DCE-CIOP Message Transport	16-5
16.3.1	Pipe-based Interface	16-6
16.3.2	Array-based Interface	16-8
16.4	DCE-CIOP Message Formats	16-11
16.4.1	DCE_CIOP Invoke Request Message	16-11
16.4.2	DCE-CIOP Invoke Response Message	16-12
16.4.3	DCE-CIOP Locate Request Message	16-14
16.4.4	DCE-CIOP Locate Response Message	16-15
16.5	DCE-CIOP Object References	16-16
16.5.1	DCE-CIOP String Binding Component	16-17
16.5.2	DCE-CIOP Binding Name Component	16-18
16.5.3	DCE-CIOP No Pipes Component	16-19
16.5.4	Complete Object Key Component	16-19
16.5.5	Endpoint ID Position Component	16-20
16.5.6	Location Policy Component	16-20
16.6	DCE-CIOP Object Location	16-21

16.6.1	Location Mechanism Overview	16-22
16.6.2	Activation	16-23
16.6.3	Basic Location Algorithm	16-23
16.6.4	Use of the Location Policy and the Endpoint ID	16-24
16.7	OMG IDL for the DCE CIOP Module	16-25
16.8	References for this Chapter	16-26
17.	Interworking Architecture	17-1
17.1	Purpose of the Interworking Architecture	17-2
17.1.1	Comparing COM Objects to CORBA Objects	17-2
17.2	Interworking Object Model	17-3
17.2.1	Relationship to CORBA Object Model	17-3
17.2.2	Relationship to the OLE/COM Model	17-4
17.2.3	Basic Description of the Interworking Model	17-4
17.3	Interworking Mapping Issues	17-8
17.4	Interface Mapping	17-8
17.4.1	CORBA/COM	17-9
17.4.2	CORBA/Automation	17-9
17.4.3	COM/CORBA	17-10
17.4.4	Automation/CORBA	17-10
17.5	Interface Composition Mappings	17-11
17.5.1	CORBA/COM	17-11
17.5.2	Detailed Mapping Rules	17-13
17.5.3	Example of Applying Ordering Rules	17-14
17.5.4	Mapping Interface Identity	17-16
17.6	Object Identity, Binding, and Life Cycle	17-18
17.6.1	Object Identity Issues	17-19
17.6.2	Binding and Life Cycle	17-20
17.7	Interworking Interfaces	17-23
17.7.1	SimpleFactory Interface	17-23
17.7.2	IMonikerProvider Interface and Moniker Use	17-23
17.7.3	ICORBAFactory Interface	17-24
17.7.4	IForeignObject Interface	17-26
17.7.5	ICORBAObject Interface	17-27
17.7.6	ICORBAObject2	17-28
17.7.7	IORBObject Interface	17-28
17.7.8	Naming Conventions for View Components	17-30
17.8	Distribution	17-32
17.8.1	Bridge Locality	17-32
17.8.2	Distribution Architecture	17-33
17.9	Interworking Targets	17-34
17.10	Compliance to COM/CORBA Interworking	17-34
17.10.1	Products Subject to Compliance	17-34
17.10.2	Compliance Points	17-36

18.	Mapping: COM and CORBA	18-1
18.1	Data Type Mapping	18-1
18.2	CORBA to COM Data Type Mapping	18-2
18.2.1	Mapping for Basic Data Types	18-2
18.2.2	Mapping for Constants	18-2
18.2.3	Mapping for Enumerators	18-3
18.2.4	Mapping for String Types	18-4
18.2.5	Mapping for Struct Types	18-5
18.2.6	Mapping for Union Types	18-6
18.2.7	Mapping for Sequence Types	18-8
18.2.8	Mapping for Array Types	18-9
18.2.9	Mapping for the any Type	18-9
18.2.10	Interface Mapping	18-11
18.2.11	Inheritance Mapping	18-26
18.2.12	Mapping for Pseudo-Objects	18-29
18.2.13	Interface Repository Mapping	18-32
18.3	COM to CORBA Data Type Mapping	18-33
18.3.1	Mapping for Basic Data Types	18-33
18.3.2	Mapping for Constants	18-34
18.3.3	Mapping for Enumerators	18-34
18.3.4	Mapping for String Types	18-35
18.3.5	Mapping for Structure Types	18-37
18.3.6	Mapping for Union Types	18-38
18.3.7	Mapping for Array Types	18-40
18.3.8	Mapping for VARIANT	18-41
18.3.9	Mapping for Pointers	18-43
18.3.10	Interface Mapping	18-44
18.3.11	Mapping for Read-Only Attributes	18-49
18.3.12	Mapping for Read-Write Attributes	18-49
19.	Mapping: Automation and CORBA	19-1
19.1	Mapping CORBA Objects to Automation	19-2
19.1.1	Architectural Overview	19-2
19.1.2	Main Features of the Mapping	19-3
19.2	Mapping for Interfaces	19-3
19.2.1	Mapping for Attributes and Operations	19-4
19.2.2	Mapping for OMG IDL Single Inheritance	19-5
19.2.3	Mapping of OMG IDL Multiple Inheritance	19-6
19.3	Mapping for Basic Data Types	19-9
19.3.1	Basic Automation Types	19-9
19.3.2	Special Cases of Basic Data Type Mapping	19-10
19.3.3	Mapping for Strings	19-11
19.4	IDL to ODL Mapping	19-12
19.4.1	A Complete IDL to ODL Mapping for the Basic Data Types	19-12

19.5	Mapping for Object References	19-15
19.5.1	Type Mapping	19-15
19.5.2	Object Reference Parameters and IForeignObject	19-16
19.6	Mapping for Enumerated Types	19-17
19.7	Mapping for Arrays and Sequences	19-18
19.8	Mapping for CORBA Complex Types	19-19
19.8.1	Mapping for Structure Types	19-20
19.8.2	Mapping for Union Types	19-21
19.8.3	Mapping for TypeCodes	19-22
19.8.4	Mapping for anys	19-24
19.8.5	Mapping for Typedefs	19-25
19.8.6	Mapping for Constants	19-25
19.8.7	Getting Initial CORBA Object References	19-26
19.8.8	Creating Initial in Parameters for Complex Types	19-27
19.8.9	Mapping CORBA Exceptions to Automation Exceptions	19-30
19.8.10	Conventions for Naming Components of the Automation View 19-36	
19.8.11	Naming Conventions for Pseudo-Structs, Pseudo-Unions, and Pseudo-Exceptions	19-36
19.8.12	Automation View Interface as a Dispatch Interface (Nondual)	19-36
19.8.13	Aggregation of Automation Views	19-38
19.8.14	DII and DSI	19-38
19.9	Mapping Automation Objects as CORBA Objects	19-38
19.9.1	Architectural Overview	19-38
19.9.2	Main Features of the Mapping	19-39
19.9.3	Getting Initial Object References	19-40
19.9.4	Mapping for Interfaces	19-40
19.9.5	Mapping for Inheritance	19-40
19.9.6	Mapping for ODL Properties and Methods	19-41
19.9.7	Mapping for Automation Basic Data Types	19-42
19.9.8	Conversion Errors	19-43
19.9.9	Special Cases of Data Type Conversion	19-43
19.9.10	A Complete OMG IDL to ODL Mapping for the Basic Data Types	19-44
19.9.11	Mapping for Object References	19-46
19.9.12	Mapping for Enumerated Types	19-47
19.9.13	Mapping for SafeArrays	19-48
19.9.14	Mapping for Typedefs	19-48
19.9.15	Mapping for VARIANTS	19-48
19.9.16	Mapping Automation Exceptions to CORBA	19-49
19.10	Older Automation Controllers	19-49
19.10.1	Mapping for OMG IDL Arrays and Sequences to Collections	19-49

19.11	Example Mappings	19-51
19.11.1	Mapping the OMG Naming Service to Automation	19-51
19.11.2	Mapping a COM Service to OMG IDL	19-51
19.11.3	Mapping an OMG Object Service to Automation	19-55
20.	Interoperability with non-CORBA Systems	20-1
20.1	Introduction	20-1
20.1.1	COM/CORBA Part A	20-2
20.2	Conformance Issues	20-2
20.2.1	Performance Issues	20-3
20.2.2	Scalability Issues	20-3
20.2.3	CORBA Clients for DCOM Servers	20-3
20.3	Locality of the Bridge	20-4
20.4	Extent Definition	20-5
20.4.1	Marshaling Constraints	20-6
20.4.2	Marshaling Key	20-6
20.4.3	Extent Format	20-7
20.5	Request/Reply Extent Semantics	20-8
20.6	Consistency	20-9
20.6.1	IValueObject	20-10
20.6.2	ISynchronize and DISynchronize	20-11
20.7	DCOM Value Objects	20-11
20.7.1	Passing Automation Compound Types as DCOM Value Objects	20-11
20.7.2	Passing CORBA-Defined Pseudo-Objects as DCOM Value Objects	20-12
20.7.3	IForeignObject	20-12
20.7.4	DIForeignComplexType	20-12
20.7.5	DIForeignException	20-12
20.7.6	DISystemException	20-12
20.7.7	DICORBAUserException	20-13
20.7.8	DICORBAStruct	20-13
20.7.9	DICORBAUnion	20-13
20.7.10	DICORBATypeCode and ICORBATypeCode	20-13
20.7.11	DICORBAAny	20-14
20.7.12	ICORBAAny	20-15
20.7.13	User Exceptions In COM	20-15
20.8	Chain Avoidance	20-16
20.8.1	CORBA Chain Avoidance	20-16
20.8.2	COM Chain Avoidance	20-17
20.9	Chain Bypass	20-19
20.9.1	CORBA Chain Bypass	20-19
20.9.2	COM Chain Bypass	20-20

20.10 Thread Identification	20-21
21. Portable Interceptors	21-1
21.1 Introduction	21-1
21.1.1 Object Creation	21-2
21.1.2 Client Sends Request	21-3
21.1.3 Server Receives Request	21-4
21.1.4 Server Sends Reply	21-4
21.1.5 Client Receives Reply	21-5
21.2 Interceptor Interface	21-5
21.3 Request Interceptors	21-6
21.3.1 Design Principles	21-6
21.3.2 General Flow Rules	21-7
21.3.3 The Flow Stack Visual Model	21-8
21.3.4 The Request Interceptor Points	21-8
21.3.5 Client-Side Interceptor	21-9
21.3.6 Client-Side Interception Points	21-9
21.3.7 Client-Side Interception Point Flow	21-11
21.3.8 Server-Side Interceptor	21-14
21.3.9 Server-Side Interception Points	21-14
21.3.10 Server-Side Interception Point Flow	21-17
21.3.11 Request Information	21-20
21.3.12 RequestInfo Interface	21-21
21.3.13 ClientRequestInfo Interface	21-25
21.3.14 ServerRequestInfo Interface	21-29
21.3.15 ForwardRequest Exception	21-33
21.4 Portable Interceptor Current	21-33
21.4.1 Overview	21-33
21.4.2 Obtaining the Portable Interceptor Current	21-34
21.4.3 Portable Interceptor Current Interface	21-34
21.4.4 Use of Portable Interceptor Current	21-35
21.5 IOR Interceptor	21-40
21.5.1 Overview	21-40
21.5.2 An Abstract Model for Object Adapters	21-40
21.5.3 Object Reference Template	21-43
21.5.4 IORInterceptor Interface	21-45
21.5.5 IORInfo Interface	21-46
21.6 PolicyFactory	21-50
21.6.1 PolicyFactory Interface	21-50
21.7 Registering Interceptors	21-50
21.7.1 ORBInitializer Interface	21-51
21.7.2 ORBInitInfo Interface	21-51
21.7.3 register_orb_initializer Operation	21-55
21.7.4 Notes about Registering Interceptors	21-57
21.8 Dynamic Initial References	21-57

Contents

21.8.1	register_initial_reference	21-57
21.9	Module Dynamic	21-58
21.9.1	NVList PIDL Represented by ParameterList IDL	21-58
21.9.2	ContextList PIDL Represented by ContextList IDL	21-58
21.9.3	ExceptionList PIDL Represented by ExceptionList IDL	21-58
21.9.4	Context PIDL Represented by RequestContext IDL	21-59
21.10	Consolidated IDL	21-59
21.10.1	Dynamic	21-59
21.10.2	Portions of IOP Relevant to Portable Interceptor	21-59
21.10.3	PortableInterceptor	21-60
22.	CORBA Messaging	22-1
22.1	Section I - Introduction	22-2
22.2	Messaging Quality of Service	22-2
22.2.1	Rebind Support	22-5
22.2.2	Synchronization Scope	22-6
22.2.3	Request and Reply Priority	22-7
22.2.4	Request and Reply Timeout	22-8
22.2.5	Routing	22-10
22.2.6	Queue Ordering	22-11
22.3	Propagation of Messaging QoS	22-12
22.3.1	Structures	22-12
22.3.2	Messaging QoS Profile Component	22-13
22.3.3	Messaging QoS Service Context	22-13
22.4	Section II - Introduction	22-13
22.5	Running Example	22-15
22.6	Async Operation Mapping	22-16
22.6.1	Callback Model Signatures (sendc)	22-16
22.6.2	Polling Model Signatures (sendp)	22-18
22.7	Exception Delivery in the Callback Model	22-20
22.7.1	Messaging::ExceptionHandler valuetype	22-20
22.8	Type-Specific ReplyHandler Mapping	22-21
22.8.1	ReplyHandler Operations for NO_EXCEPTION Replies	22-22
22.8.2	ReplyHandler Operations for Exceptional Replies	22-23
22.8.3	Example	22-23
22.9	Generic Poller Value	22-24
22.9.1	operation_target	22-25
22.9.2	operation_name	22-25
22.9.3	associated_handler	22-25
22.9.4	is_from_poller	22-25

22.10	Type-Specific Poller Mapping	22-26
	22.10.1 Basic Type-Specific Poller	22-26
	22.10.2 Persistent Type-Specific Poller	22-28
	22.10.3 Example	22-29
22.11	Example Programmer Usage	22-30
	22.11.1 Example Programmer Usage (Examples Mapped to C++)	22-30
	22.11.2 Client-Side C++ Example for the Asynchronous Method Signatures	22-30
	22.11.3 Client-Side C++ Example of the Callback Model	22-31
	22.11.4 Client-Side C++ Example of the Polling Model	22-38
	22.11.5 Server Side	22-44
22.12	Section III - Introduction	22-45
22.13	Routing Object References	22-46
22.14	Message Routing	22-46
	22.14.1 Structures	22-48
	22.14.2 Interfaces	22-50
	22.14.3 Routing Protocol	22-52
22.15	Router Administration	22-59
	22.15.1 Constants	22-62
	22.15.2 Exceptions	22-63
	22.15.3 Valuetypes	22-63
	22.15.4 Interfaces	22-64
22.16	CORBA Messaging IDL	22-65
	22.16.1 Messaging Module	22-65
	22.16.2 MessageRouting Module	22-68
Appendix A	Overall Design Rationale	22-72
Appendix B	Conformance and Compatibility Issues	22-84
23.	Fault Tolerant CORBA	23-1
23.1	Fault Tolerant CORBA	23-1
	23.1.1 Fault Tolerance for Diverse Applications	23-1
	23.1.2 Objectives	23-2
	23.1.3 Basic Concepts	23-3
	23.1.4 Architectural Overview	23-4
	23.1.5 Requirements	23-8
	23.1.6 Limitations	23-11
23.2	Basic Fault Tolerance Mechanisms	23-12
	23.2.1 Overview	23-12
	23.2.2 Interoperable Object Group References	23-13
	23.2.3 Interoperable Object Group Reference Operations	23-16
	23.2.4 Modes of Profile Addressing	23-18
	23.2.5 Accessing Server Object Groups	23-19

Contents

23.2.6	Extensions to CORBA Failover Semantics	23-21
23.2.7	Most Recent Object Group Reference	23-22
23.2.8	Transparent Reinvocation	23-23
23.2.9	Transport Heartbeats	23-27
23.3	Replication Management	23-31
23.3.1	Overview	23-31
23.3.2	Fault Tolerance Properties	23-32
23.3.3	FaultMonitoringIntervalAndTimeout.	23-37
23.3.4	CheckpointInterval	23-37
23.3.5	Common Types	23-38
23.3.6	Replication Manager	23-44
23.3.7	PropertyManager	23-45
23.3.8	ObjectGroupManager	23-49
23.3.9	GenericFactory	23-56
23.3.10	Obtaining the Reference for the Replication Manager	23-61
23.3.11	Use Cases	23-61
23.4	Fault Management	23-66
23.4.1	Overview	23-66
23.4.2	Architecture.	23-67
23.4.3	Connecting Fault Detectors to Applications	23-70
23.4.4	Pull-Based Monitoring	23-71
23.4.5	Fault Event Types	23-72
23.4.6	Fault Notifier	23-73
23.4.7	Use Cases	23-79
23.5	Logging & Recovery Management.	23-81
23.5.1	Overview	23-81
23.5.2	Logging Mechanism	23-81
23.5.3	Recovery Mechanism	23-82
23.5.4	Checkpointable and Updateable Interfaces	23-84
23.5.5	Use Case	23-87
23.6	Consolidated IDL	23-88
23.6.1	OMG IDL	23-88
Appendix A	Glossary	23-96
Appendix B	Compliance.	23-105
24.	Secure Interoperability.	24-1
24.1	Overview	24-1
24.1.1	Assumptions	24-3
24.2	Protocol Message Definitions.	24-4
24.2.1	The Security Attribute Service Context Element	24-4
24.2.2	SAS context_data Message Body Types	24-5
24.2.3	Authorization Token Format	24-10
24.2.4	Client Authentication Token Format	24-11
24.2.5	Identity Token Format	24-14

24.2.6	Principal Names and Distinguished Names	24-15
24.3	Security Attribute Service Protocol	24-16
24.3.1	Compound Mechanisms	24-16
24.3.2	Session Semantics	24-21
24.3.3	TSS State Machine	24-23
24.3.4	CSS State Machine	24-27
24.3.5	ContextError Values and Exceptions	24-30
24.4	Transport Security Mechanisms	24-31
24.4.1	Transport Layer Interoperability	24-31
24.4.2	Transport Mechanism Configuration	24-31
24.5	Interoperable Object References	24-32
24.5.1	Target Security Configuration	24-32
24.5.2	Client-side Mechanism Selection	24-43
24.5.3	Client-Side Requirements and Location Binding.	24-44
24.6	Conformance Levels.	24-45
24.6.1	Conformance Level 0.	24-45
24.6.2	Conformance Level 1.	24-47
24.6.3	Conformance Level 2.	24-47
24.6.4	Stateful Conformance	24-48
24.7	Sample Message Flows and Scenarios	24-48
24.7.1	Confidentiality, Trust in Server, and Trust in Client Established in the Connection	24-49
24.7.2	Confidentiality and Trust in Server Established in the Connection - Stateless Trust in Client Established in Service Context	24-51
24.7.3	Confidentiality, Trust in Server, and Trust in Client Established in the Connection - Stateless Trust Association Established in Service Context	24-53
24.7.4	Confidentiality, Trust in Server, and Trust in Client Established in the Connection - Stateless Forward Trust Association Established in Service Context.	24-56
24.8	References for this Chapter	24-57
24.9	IDL.	24-58
24.9.1	Module GSSUP - Username/Password GSSAPI Token Formats.	24-58
24.9.2	Module CSI - Common Secure Interoperability	24-59
24.9.3	Module CSIIOP - CSIV2 IOR Component Tag Definitions	24-63
Appendix A - OMG IDL Tags		A-1
Glossary.		1

Contents

Preface

About This Document

Under the terms of the collaboration between OMG and The Open Group, this document is a candidate for adoption by The Open Group, as an Open Group Technical Standard. The collaboration between OMG and The Open Group ensures joint review and cohesive support for emerging object-based specifications.

Object Management Group

The Object Management Group, Inc. (OMG) is an international organization supported by over 600 members, including information system vendors, software developers and users. Founded in 1989, the OMG promotes the theory and practice of object-oriented technology in software development. The organization's charter includes the establishment of industry guidelines and object management specifications to provide a common framework for application development. Primary goals are the reusability, portability, and interoperability of object-based software in distributed, heterogeneous environments. Conformance to these specifications will make it possible to develop a heterogeneous applications environment across all major hardware platforms and operating systems.

OMG's objectives are to foster the growth of object technology and influence its direction by establishing the Object Management Architecture (OMA). The OMA provides the conceptual infrastructure upon which all OMG specifications are based. More information is available at <http://www.omg.org/>.

The Open Group

The Open Group, a vendor and technology-neutral consortium, is committed to delivering greater business efficiency by bringing together buyers and suppliers of information technology to lower the time, cost, and risks associated with integrating new technology across the enterprise.

The mission of The Open Group is to drive the creation of boundaryless information flow achieved by:

- Working with customers to capture, understand and address current and emerging requirements, establish policies, and share best practices;
- Working with suppliers, consortia and standards bodies to develop consensus and facilitate interoperability, to evolve and integrate specifications and open source technologies;
- Offering a comprehensive set of services to enhance the operational efficiency of consortia; and
- Developing and operating the industry's premier certification service and encouraging procurement of certified products.

The Open Group has over 15 years experience in developing and operating certification programs and has extensive experience developing and facilitating industry adoption of test suites used to validate conformance to an open standard or specification. The Open Group portfolio of test suites includes tests for CORBA, the Single UNIX Specification, CDE, Motif, Linux, LDAP, POSIX.1, POSIX.2, POSIX Realtime, Sockets, UNIX, XPG4, XNFS, XTI, and X11. The Open Group test tools are essential for proper development and maintenance of standards-based products, ensuring conformance of products to industry-standard APIs, applications portability, and interoperability. In-depth testing identifies defects at the earliest possible point in the development cycle, saving costs in development and quality assurance.

More information is available at <http://www.opengroup.org/> .

Intended Audience

The architecture and specifications described in this manual are aimed at software designers and developers who want to produce applications that comply with OMG standards for the Object Request Broker (ORB). The benefit of compliance is, in general, to be able to produce interoperable applications that are based on distributed, interoperating objects. As defined by the Object Management Group (OMG) in the *Object Management Architecture Guide*, the ORB provides the mechanisms by which objects transparently make requests and receive responses. Hence, the ORB provides interoperability between applications on different machines in heterogeneous distributed environments and seamlessly interconnects multiple object systems.

Context of CORBA

The key to understanding the structure of the CORBA architecture is the Reference Model, which consists of the following components:

- **Object Request Broker**, which enables objects to transparently make and receive requests and responses in a distributed environment. It is the foundation for building applications from distributed objects and for interoperability between applications in hetero- and homogeneous environments. The architecture and specifications of the Object Request Broker are described in this manual.

-
- **Object Services**, a collection of services (interfaces and objects) that support basic functions for using and implementing objects. Services are necessary to construct any distributed application and are always independent of application domains. For example, the Life Cycle Service defines conventions for creating, deleting, copying, and moving objects; it does not dictate how the objects are implemented in an application. Specifications for Object Services are contained in *CORBAservices: Common Object Services Specification*.
 - **Common Facilities**, a collection of services that many applications may share, but which are not as fundamental as the Object Services. For instance, a system management or electronic mail facility could be classified as a common facility. Information about Common Facilities will be contained in *CORBAfacilities: Common Facilities Architecture*.
 - **Application Objects**, which are products of a single vendor or in-house development group that controls their interfaces. Application Objects correspond to the traditional notion of applications, so they are not standardized by OMG. Instead, Application Objects constitute the uppermost layer of the Reference Model.

The Object Request Broker, then, is the core of the Reference Model. It is like a telephone exchange, providing the basic mechanism for making and receiving calls. Combined with the Object Services, it ensures meaningful communication between CORBA-compliant applications.

Associated Documents

The CORBA documentation set includes the following books:

- *Object Management Architecture Guide* defines the OMG's technical objectives and terminology and describes the conceptual models upon which OMG standards are based. It also provides information about the policies and procedures of OMG, such as how standards are proposed, evaluated, and accepted.
- *CORBA: Common Object Request Broker Architecture and Specification* contains the architecture and specifications for the Object Request Broker.
- *CORBAservices: Common Object Services Specification* contains specifications for the Object Services.
- *CORBAfacilities: Common Facilities Architecture* contains the architecture for Common Facilities.

OMG collects information for each book in the documentation set by issuing Requests for Information, Requests for Proposals, and Requests for Comment and, with its membership, evaluating the responses. Specifications are adopted as standards only when representatives of the OMG membership accept them as such by vote.

OMG formal documents are available from our web site in PostScript and PDF format. To obtain print-on-demand books in the documentation set or other OMG publications, contact the Object Management Group, Inc. at:

OMG Headquarters
250 First Avenue, Suite 201
Needham, MA 02494
USA
Tel: +1-781-444-0404
Fax: +1-781-444-0320
pubs@omg.org
<http://www.omg.org>

Definition of CORBA Compliance

The minimum required for a CORBA-compliant system is adherence to the specifications in CORBA Core and one mapping. Each additional language mapping is a separate, optional compliance point. Optional means users aren't required to implement these points if they are unnecessary at their site, but if implemented, they must adhere to the *CORBA* specifications to be called CORBA-compliant. For instance, if a vendor supports C++, their ORB must comply with the OMG IDL to C++ binding specified in the *C++ Language Mapping Specification*.

Interoperability and Interworking are separate compliance points. For detailed information about Interworking compliance, refer to "Compliance to COM/CORBA Interworking" on page 17-34.

As described in the *OMA Guide*, the OMG's Core Object Model consists of a core and components. Likewise, the body of *CORBA* specifications is divided into core and component-like specifications. The structure of this manual reflects that division.

The *CORBA* core specifications are categorized as follows:

CORBA Core, as specified in Chapters 1-11

CORBA Interoperability, as specified in Chapters 12-16

CORBA Interworking, as specified in Chapters 17-21

CORBA Quality of Service, as specified in Chapters 22-24

Note – The CORBA Language Mappings have been separated from the CORBA Core and each language mapping is its own separate book. Refer to the Specifications Catalog for this information.

Structure of This Manual

This manual is divided into the categories of Core, Interoperability, and Interworking. These divisions reflect the compliance points of CORBA. In addition to this preface, *CORBA: Common Object Request Broker Architecture and Specification* contains the following chapters:

Core

Chapter 1 - The Object Model describes the computation model that underlies the CORBA architecture.

Chapter 2 - CORBA Overview contains the overall structure of the ORB architecture and includes information about CORBA interfaces and implementations.

Chapter 3 - OMG IDL Syntax and Semantics details the OMG interface definition language (OMG IDL), which is the language used to describe the interfaces that client objects call and object implementations provide.

Chapter 4 - ORB Interface defines the interface to the ORB functions that do not depend on object adapters: these operations are the same for all ORBs and object implementations.

Chapter 5 - Value Type Semantics describes the semantics of passing an object by value, which is similar to that of standard programming languages.

Chapter 6 - Abstract Interface Semantics explains an IDL abstract interface, which provides the capability to defer the determination of whether an object is passed by reference or by value until runtime.

Chapter 7 - The Dynamic Invocation Interface details the DII, the client's side of the interface that allows dynamic creation and invocation of request to objects.

Chapter 8 -- The Dynamic Skeleton Interface describes the DSI, the server's-side interface that can deliver requests from an ORB to an object implementation that does not have compile-time knowledge of the type of the object it is implementing. DSI is the server's analogue of the client's Dynamic Invocation Interface (DII).

Chapter 9 - Dynamic Management of Any Values details the interface for the Dynamic Any type. This interface allows statically-typed programming languages such as C and Java to create or receive values of type Any without compile-time knowledge that the typer contained in the Any.

Chapter 10 - Interface Repository explains the component of the ORB that manages and provides access to a collection of object definitions.

Chapter 11 - Portable Object Adapter defines a group of IDL interfaces than an implementation uses to access ORB functions.

Interoperability

Chapter 12 - Interoperability Overview describes the interoperability architecture and introduces the subjects pertaining to interoperability: inter-ORB bridges; general and Internet inter-ORB protocols (GIOP and IIOP); and environment-specific, inter-ORB protocols (ESIOPs).

Chapter 13 - ORB Interoperability Architecture introduces the framework of ORB interoperability, including information about domains; approaches to inter-ORB bridges; what it means to be compliant with ORB interoperability; and ORB Services and Requests.

Chapter 14 - Building Inter-ORB Bridges explains how to build bridges for an implementation of interoperating ORBs.

Chapter 15 - General Inter-ORB Protocol describes the general inter-ORB protocol (GIOP) and includes information about the GIOP's goals, syntax, format, transport, and object location. This chapter also includes information about the Internet inter-ORB protocol (IIOP).

Chapter 16 - DCE ESIOP - Environment-Specific Inter-ORB Protocol (ESIOP) details a protocol for the OSF DCE environment. The protocol is called the DCE Environment Inter-ORB Protocol (DCE ESIOP).

Interworking

Chapter 17 - Interworking Architecture describes the architecture for communication between two object management systems: Microsoft's COM (including OLE) and the OMG's CORBA.

Chapter 18 - Mapping: COM and CORBA explains the data type and interface mapping between COM and CORBA. The mappings are described in the context of both Win16 and Win32 COM.

Chapter 19 - Mapping: OLE Automation and CORBA details the two-way mapping between OLE Automation (in ODL) and CORBA (in OMG IDL).

Note: Chapter 19 also includes an appendix describing solutions that vendors might implement to support existing and older OLE Automation controllers and an appendix that provides an example of how the Naming Service could be mapped to an OLE Automation interface according to the Interworking specification.

Chapter 20 - Interoperability with non-CORBA Systems describes the effective access to CORBA servers through DCOM and the reverse.

Chapter 21 - Portable Interceptors defines ORB operations that allow services such as security to be inserted in the invocation path.

Quality of Service (QoS)

Chapter 22 - CORBA Messaging includes three general topics: Quality of Service, Asynchronous Method Invocations (to include Time-Independent or “Persistent” Requests), and the specification of interoperable Routing interfaces to support the transport of requests asynchronously from the handling of their replies.

Chapter 23 - Fault Tolerant CORBA describes Fault Tolerant systems, basic fault tolerance mechanisms, replication management, and logging and recovery management.

Chapter 24 - Common Secure Interoperability defines the CORBA Security Attribute Service (SAS) protocol and its use within the CSIv2 architecture to address the requirements of CORBA security for interoperable authentication, delegation, and privileges.

Typographical Conventions

The type styles shown below are used in this document to distinguish programming statements from ordinary English. However, these conventions are not used in tables or section headings where no distinction is necessary.

Helvetica bold - OMG Interface Definition Language (OMG IDL) and syntax elements.

Courier bold - Programming language elements.

Helvetica - Exceptions

Terms that appear in *italics* are defined in the glossary. Italic text also represents the name of a document, specification, or other publication.

Acknowledgements

The following companies submitted and/or supported parts of the specifications that were approved by the Object Management Group to become *CORBA*:

- Adiron, LLC
- Alcatel
- BEA Systems, Inc.
- BNR Europe Ltd.
- Borland International, Inc.
- Compaq Computer Corporation
- Concept Five Technologies
- Cooperative Research Centre for Distributed Systems Technology (DSTC)
- Defense Information Systems Agency
- Digital Equipment Corporation
- Ericsson
- Eternal Systems, Inc.

-
- Expersoft Corporation
 - France Telecom
 - FUJITSU LIMITED
 - Genesis Development Corporation
 - Gensym Corporation
 - Hewlett-Packard Company
 - HighComm
 - Highlander Communications, L.C.
 - Humboldt-University
 - HyperDesk Corporation
 - ICL, Plc.
 - Inprise Corporation
 - International Business Machines Corporation
 - International Computers, Inc.
 - IONA Technologies, Plc.
 - Lockheed Martin Federal Systems, Inc.
 - Lucent Technologies, Inc.
 - Micro Focus Limited
 - MITRE Corporation
 - Motorola, Inc.
 - NCR Corporation
 - NEC Corporation
 - Netscape Communications Corporation
 - Nortel Networks
 - Northern Telecom Corporation
 - Novell, Inc.
 - Object Design, Inc.
 - Objective Interface Systems, Inc.
 - Object-Oriented Concepts, Inc.
 - OC Systems, Inc.
 - Open Group - Open Software Foundation
 - Oracle Corporation
 - PeerLogic, Inc.
 - Persistence Software, Inc.
 - Promia, Inc.
 - Siemens Nixdorf Informationssysteme AG
 - SPAWAR Systems Center
 - Sun Microsystems, Inc.
 - SunSoft, Inc.
 - Sybase, Inc.
 - Telefónica Investigación y Desarrollo S.A. Unipersonal
 - TIBCO, Inc.

-
- Tivoli Systems, Inc.
 - Tri-Pacific Software, Inc.
 - University of California, Santa Barbara
 - University of Rhode Island
 - Visual Edge Software, Ltd.
 - Washington University

In addition to the preceding contributors, the OMG would like to acknowledge Mark Linton at Silicon Graphics and Doug Lea at the State University of New York at Oswego for their work on the C++ mapping.

References

IDL Type Extensions RFP, March 1995. OMG TC Document 95-1-35.

The Common Object Request Broker: Architecture and Specification, Revision 2.2, February 1998.

CORBA services: Common Object Services Specification, Revised Edition, OMG TC Document 95-3-31.

COBOL Language Mapping RFP, December 1995. OMG TC document 95-12-10.

COBOL 85 ANSI X3.23-1985 / ISO 1989-1985.

IEEE Standard for Binary Floating-Point Arithmetic, ANIS/IEEE Std 754-1985.

XDR: External Data Representation Standard, RFC1832, R. Srinivasan, Sun Microsystems, August 1995.

OSF Character and Code Set Registry, OSF DCE SIG RFC 40.1 (Public Version), S. (Martin) O'Donnell, June 1994.

RPC Runtime Support For I18N Characters — Functional Specification, OSF DCE SIG RFC 41.2, M. Romagna, R. Mackey, November 1994.

X/Open System Interface Definitions, Issue 4 Version 2, 1995.

The Object Model

1

This chapter describes the concrete object model that underlies the CORBA architecture. The model is derived from the abstract Core Object Model defined by the Object Management Group in the *Object Management Architecture Guide*. (Information about the *OMA Guide* and other books in the CORBA documentation set is provided in this document's preface.)

Contents

This chapter contains the following sections.

Section Title	Page
"Overview"	1-1
"Object Semantics"	1-2
"Object Implementation"	1-9

1.1 Overview

The object model provides an organized presentation of object concepts and terminology. It defines a partial model for computation that embodies the key characteristics of objects as realized by the submitted technologies. The OMG object model is *abstract* in that it is not directly realized by any particular technology. The model described here is a *concrete* object model. A concrete object model may differ from the abstract object model in several ways:

- It may *elaborate* the abstract object model by making it more specific, for example, by defining the form of request parameters or the language used to specify types.
- It may *populate* the model by introducing specific instances of entities defined by the model, for example, specific objects, specific operations, or specific types.

- It may *restrict* the model by eliminating entities or placing additional restrictions on their use.

An object system is a collection of objects that isolates the requestors of services (clients) from the providers of services by a well-defined encapsulating interface. In particular, clients are isolated from the implementations of services as data representations and executable code.

The object model first describes concepts that are meaningful to clients, including such concepts as object creation and identity, requests and operations, types and signatures. It then describes concepts related to object implementations, including such concepts as methods, execution engines, and activation.

The object model is most specific and prescriptive in defining concepts meaningful to clients. The discussion of object implementation is more suggestive, with the intent of allowing maximal freedom for different object technologies to provide different ways of implementing objects.

There are some other characteristics of object systems that are outside the scope of the object model. Some of these concepts are aspects of application architecture, some are associated with specific domains to which object technology is applied. Such concepts are more properly dealt with in an architectural reference model. Examples of excluded concepts are compound objects, links, copying of objects, change management, and transactions. Also outside the scope of the object model are the details of control structure: the object model does not say whether clients and/or servers are single-threaded or multi-threaded, and does not specify how event loops are programmed nor how threads are created, destroyed, or synchronized.

This object model is an example of a *classical object model*, where a client sends a message to an object. Conceptually, the object interprets the message to decide what service to perform. In the classical model, a message identifies an object and zero or more actual parameters. As in most classical object models, a distinguished first parameter is required, which identifies the operation to be performed; the interpretation of the message by the object involves selecting a method based on the specified operation. Operationally, of course, method selection could be performed either by the object or the ORB.

1.2 Object Semantics

An object system provides services to clients. A *client* of a service is any entity capable of requesting the service.

This section defines the concepts associated with object semantics, that is, the concepts relevant to clients.

1.2.1 Objects

An object system includes entities known as objects. An *object* is an identifiable, encapsulated entity that provides one or more services that can be requested by a client.

1.2.2 Requests

Clients request services by issuing requests.

The term *request* is broadly used to refer to the entire sequence of causally related events that transpires between a client initiating it and the last event causally associated with that initiation. For example:

- the client receives the final response associated with that *request* from the server,
- the server carries out the associated operation in case of a oneway request, or
- the sequence of events associated with the *request* terminates in a failure of some sort. The initiation of a Request is an event.

The information associated with a request consists of an operation, a target object, zero or more (actual) parameters, and an optional request context.

A *request form* is a description or pattern that can be evaluated or performed multiple times to cause the issuing of requests. As described in the OMG IDL Syntax and Semantics chapter, request forms are defined by particular language bindings. An alternative request form consists of calls to the dynamic invocation interface to create an invocation structure, add arguments to the invocation structure, and to issue the invocation (refer to the *Dynamic Invocation Interface* chapter for descriptions of these request forms).

A *value* is anything that may be a legitimate (actual) parameter in a request. More particularly, a value is an instance of an OMG IDL data type. There are non-object values, as well as values that reference objects.

An *object reference* is a value that reliably denotes a particular object. Specifically, an object reference will identify the same object each time the reference is used in a request (subject to certain pragmatic limits of space and time). An object may be denoted by multiple, distinct object references.

A request may have parameters that are used to pass data to the target object; it may also have a request context that provides additional information about the request. A request context is a mapping from strings to strings.

A request causes a service to be performed on behalf of the client. One possible outcome of performing a service is returning to the client the results, if any, defined for the request.

If an abnormal condition occurs during the performance of a request, an exception is returned. The exception may carry additional return parameters particular to that exception.

The request parameters are identified by position. A parameter may be an input parameter, an output parameter, or an input-output parameter. A request may also return a single *return result value*, as well as the results stored into the output and input-output parameters.

The following semantics hold for all requests:

- Any aliasing of parameter values is neither guaranteed removed nor guaranteed to be preserved.

- The order in which aliased output parameters are written is not guaranteed.
- The return result and the values stored into the output and input-output parameters are undefined if an exception is returned.

For descriptions of the values and exceptions that are permitted, see Section 1.2.4, “Types,” on page 1-4 and Section 1.2.8.3, “Exceptions,” on page 1-8.

1.2.3 Object Creation and Destruction

Objects can be created and destroyed. From a client’s point of view, there is no special mechanism for creating or destroying an object. Objects are created and destroyed as an outcome of issuing requests. The outcome of object creation is revealed to the client in the form of an object reference that denotes the new object.

1.2.4 Types

A *type* is an identifiable entity with an associated predicate (a single-argument mathematical function with a boolean result) defined over entities. An entity *satisfies* a type if the predicate is true for that entity. An entity that satisfies a type is called a *member of the type*.

Types are used in signatures to restrict a possible parameter or to characterize a possible result.

The *extension of a type* is the set of entities that satisfy the type at any particular time.

An *object type* is a type whose members are object references. In other words, an object type is satisfied only by object references.

Constraints on the data types in this model are shown in this section.

1.2.4.1 Basic types

- 16-bit, 32-bit, and 64-bit signed and unsigned 2’s complement integers.
- Single-precision (32-bit), double-precision (64-bit), and double-extended (a mantissa of at least 64 bits, a sign bit and an exponent of at least 15 bits) IEEE floating point numbers.
- Fixed-point decimal numbers of up to 31 significant digits.
- Characters, as defined in ISO Latin-1 (8859.1) and other single- or multi-byte character sets.
- A boolean type taking the values TRUE and FALSE.
- An 8-bit opaque detectable, guaranteed to *not* undergo any conversion during transfer between systems.
- Enumerated types consisting of ordered sequences of identifiers.

- A string type, which consists of a variable-length array of characters; the length of the string is a non-negative integer, and is available at run-time. The length may have a maximum bound defined.
- A wide character string type, which consist of a variable-length array of (fixed width) wide characters; the length of the wide string is a non-negative integer, and is available at run-time. The length may have a maximum bound defined.
- A container type “any,” which can represent any possible basic or constructed type.
- Wide characters that may represent characters from any wide character set.
- Wide character strings, which consist of a length, available at runtime, and a variable-length array of (fixed width) wide characters.

1.2.4.2 *Constructed types*

- A record type (called struct), which consists of an ordered set of (name,value) pairs.
- A discriminated union type, which consists of a discriminator (whose exact value is always available) followed by an instance of a type appropriate to the discriminator value.
- A sequence type, which consists of a variable-length array of a single type; the length of the sequence is available at run-time.
- An array type, which consists of a fixed-shape multidimensional array of a single type.
- An interface type, which specifies the set of operations that an instance of that type must support.
- A value type, which specifies state as well as a set of operations that an instance of that type must support.

Entities in a request are restricted to values that satisfy these type constraints. The legal entities are shown in . No particular representation for entities is defined.

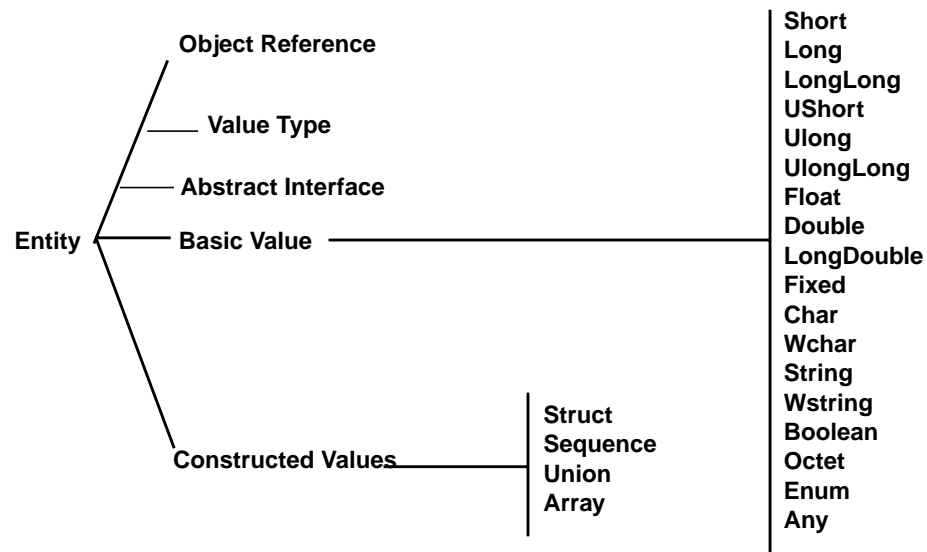

Figure 1-1 Legal Values

1.2.5 Interfaces

An *interface* is a description of a set of possible operations that a client may request of an object, through that interface. It provides a syntactic description of how a service provided by an object supporting this interface, is accessed via this set of operations. An object *satisfies* an interface if it provides its service through the operations of the interface according to the specification of the operations (see Section 1.2.8, “Operations,” on page 1-7).

The *interface type* for a given interface is an object type, such that an object reference will satisfy the type, if and only if the referent object also satisfies the interface.

Interfaces are specified in OMG IDL. Interface inheritance provides the composition mechanism for permitting an object to support multiple interfaces. The *principal interface* is simply the most-specific interface that the object supports, and consists of all operations in the transitive closure of the interface inheritance graph.

Interfaces satisfy the Liskov substitution principle. If interface A is derived from interface B, then a reference to an object that supports interface A can be used where the formal type of a parameter is declared to be B.

1.2.6 Value Types

A *value type* is an entity, which shares many of the characteristics of interfaces and structs. It is a description of both a set of operations that a client may request and of state that is accessible to a client. Instances of a value type are always local concrete implementations in some programming language.

A value type, in addition to the operations and state defined for itself, may also inherit from other value types, and through multiple inheritance support other interfaces.

Value types are specified in OMG IDL.

An *abstract value types* describes a value type that is a “pure” bundle of operations with no state.

1.2.7 Abstract Interfaces

An *abstract interface* is an entity, which may at runtime represent either a regular interface (see Section 1.2.5, “Interfaces,” on page 1-6) or a value type (see Section 1.2.6, “Value Types,” on page 1-6). Like an abstract value type, it is a pure bundle of operations with no state. Unlike an abstract value type, it does not imply pass-by-value semantics, and unlike a regular interface type, it does not imply pass-by-reference semantics. Instead, the entity’s runtime type determines which of these semantics are used.

1.2.8 Operations

An *operation* is an identifiable entity that denotes the indivisible primitive of service provision that can be requested. The act of requesting an operation is referred to as *invoking the operation*. An operation is identified by an *operation identifier*.

An operation has a *signature* that describes the legitimate values of request parameters and returned results. In particular, a *signature* consists of:

- A specification of the parameters required in requests for that operation.
- A specification of the result of the operation.
- An identification of the user exceptions that may be raised by an invocation of the operation.
- A specification of additional contextual information that may affect the invocation.
- An indication of the execution semantics the client should expect from an invocation of the operation.

Operations are (potentially) *generic*, meaning that a single operation can be uniformly invoked on objects with different implementations, possibly resulting in observably different behavior. Genericity is achieved in this model via interface inheritance in IDL and the total decoupling of implementation from interface specification.

The general form for an operation signature is:

**[oneway] <op_type_spec> <identifier> (param1, ..., paramL)
[raises(except1,...,exceptN)] [context(name1, ..., nameM)]**

where:

- The optional **oneway** keyword indicates that best-effort semantics are expected of requests for this operation; the default semantics are exactly-once if the operation successfully returns results or at-most-once if an exception is returned.

- The **<op_type_spec>** is the type of the return result.
- The **<identifier>** provides a name for the operation in the interface.
- The operation parameters needed for the operation; they are flagged with the modifiers **in**, **out**, or **inout** to indicate the direction in which the information flows (with respect to the object performing the request).
- The optional **raises** expression indicates which user-defined exceptions can be signaled to terminate an invocation of this operation; if such an expression is not provided, no user-defined exceptions will be signaled.
- The optional **context** expression indicates which request context information will be available to the object implementation; no other contextual information is required to be transported with the request.

1.2.8.1 Parameters

A parameter is characterized by its mode and its type. The *mode* indicates whether the value should be passed from client to server (**in**), from server to client (**out**), or both (**inout**). The parameter's type constrains the possible value, which may be passed in the directions dictated by the mode.

1.2.8.2 Return Result

The return result is a distinguished **out** parameter.

1.2.8.3 Exceptions

An *exception* is an indication that an operation request was not performed successfully. An exception may be accompanied by additional, exception-specific information.

The additional, exception-specific information is a specialized form of record. As a record, it may consist of any of the types described in Section 1.2.4, "Types," on page 1-4.

All signatures implicitly include the system exceptions; the standard system exceptions are described in Section 4.12.2, "System Exceptions," on page 4-63.

1.2.8.4 Contexts

A *request context* provides additional, operation-specific information that may affect the performance of a request.

1.2.8.5 Execution Semantics

Two styles of execution semantics are defined by the object model:

- At-most-once: if an operation request returns successfully, it was performed exactly once; if it returns an exception indication, it was performed at-most-once.

- Best-effort: a best-effort operation is a request-only operation (i.e., it cannot return any results and the requester never synchronizes with the completion, if any, of the request).

The execution semantics to be expected is associated with an operation. This prevents a client and object implementation from assuming different execution semantics.

Note that a client is able to invoke an at-most-once operation in a synchronous or deferred-synchronous manner.

1.2.9 Attributes

An interface may have attributes. An attribute is logically equivalent to declaring a pair of accessor functions: one to retrieve the value of the attribute and one to set the value of the attribute.

An attribute may be read-only, in which case only the retrieval accessor function is defined.

1.3 Object Implementation

This section defines the concepts associated with object implementation (i.e., the concepts relevant to realizing the behavior of objects in a computational system).

The implementation of an object system carries out the computational activities needed to effect the behavior of requested services. These activities may include computing the results of the request and updating the system state. In the process, additional requests may be issued.

The implementation model consists of two parts: the execution model and the construction model. The execution model describes how services are performed. The construction model describes how services are defined.

1.3.1 The Execution Model: Performing Services

A requested service is performed in a computational system by executing code that operates upon some data. The data represents a component of the state of the computational system. The code performs the requested service, which may change the state of the system.

Code that is executed to perform a service is called a *method*. A method is an immutable description of a computation that can be interpreted by an execution engine. A method has an immutable attribute called a *method format* that defines the set of execution engines that can interpret the method. An *execution engine* is an abstract machine (not a program) that can interpret methods of certain formats, causing the described computations to be performed. An execution engine defines a dynamic context for the execution of a method. The execution of a method is called a *method activation*.

When a client issues a request, a method of the target object is called. The input parameters passed by the requestor are passed to the method and the output and input-output parameters and return result value (or exception and its parameters) are passed back to the requestor.

Performing a requested service causes a method to execute that may operate upon an object's persistent state. If the persistent form of the method or state is not accessible to the execution engine, it may be necessary to first copy the method or state into an execution context. This process is called *activation*; the reverse process is called *deactivation*.

1.3.2 The Construction Model

A computational object system must provide mechanisms for realizing behavior of requests. These mechanisms include definitions of object state, definitions of methods, and definitions of how the object infrastructure is to select the methods to execute and to select the relevant portions of object state to be made accessible to the methods. Mechanisms must also be provided to describe the concrete actions associated with object creation, such as association of the new object with appropriate methods.

An *object implementation*—or *implementation*, for short—is a definition that provides the information needed to create an object and to allow the object to participate in providing an appropriate set of services. An implementation typically includes, among other things, definitions of the methods that operate upon the state of an object. It also typically includes information about the intended types of the object.

The Common Object Request Broker Architecture (CORBA) is structured to allow integration of a wide variety of object systems. The motivation for some of the features may not be apparent at first, but as we discuss the range of implementations, policies, optimizations, and usages we expect to encompass, the value of the flexibility becomes more clear.

Contents

This chapter contains the following sections.

Section Title	Page
“Structure of an Object Request Broker”	2-1
“Example ORBs”	2-11
“Structure of a Client”	2-12
“Structure of an Object Implementation”	2-13
“Structure of an Object Adapter”	2-15
“CORBA Required Object Adapter”	2-17
“The Integration of Foreign Object Systems”	2-17

2.1 Structure of an Object Request Broker

Figure 2-1 shows a request being sent by a client to an object implementation. The Client is the entity that wishes to perform an operation on the object and the Object Implementation is the code and data that actually implements the object.

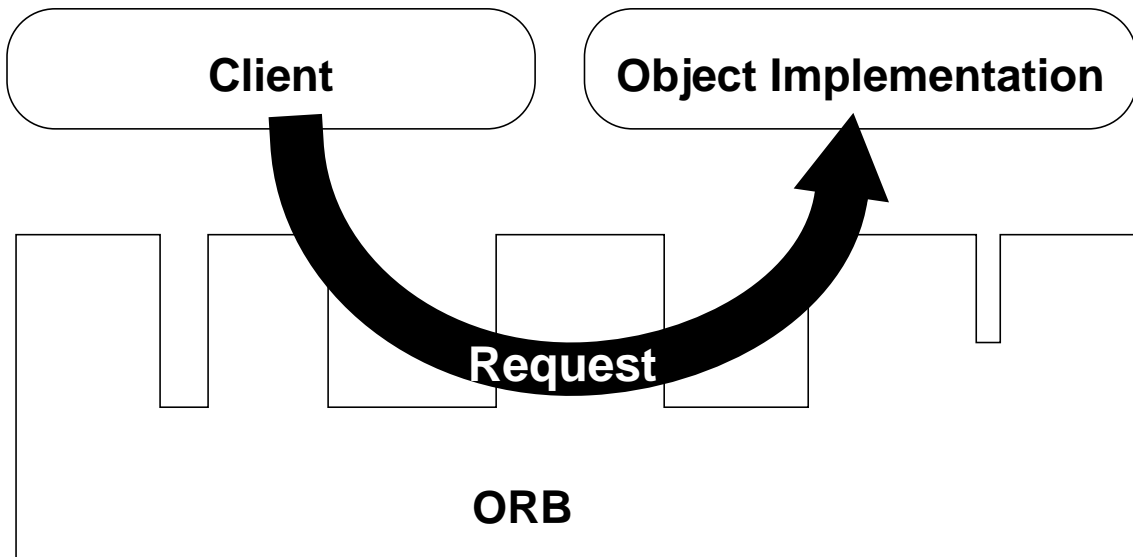

Figure 2-1 A Request Being Sent Through the Object Request Broker

The ORB is responsible for all of the mechanisms required to find the object implementation for the request, to prepare the object implementation to receive the request, and to communicate the data making up the request. The interface the client sees is completely independent of where the object is located, what programming language it is implemented in, or any other aspect that is not reflected in the object's interface.

Figure 2-2 on page 2-3 shows the structure of an individual Object Request Broker (ORB). The interfaces to the ORB are shown by striped boxes, and the arrows indicate whether the ORB is called or performs an up-call across the interface.

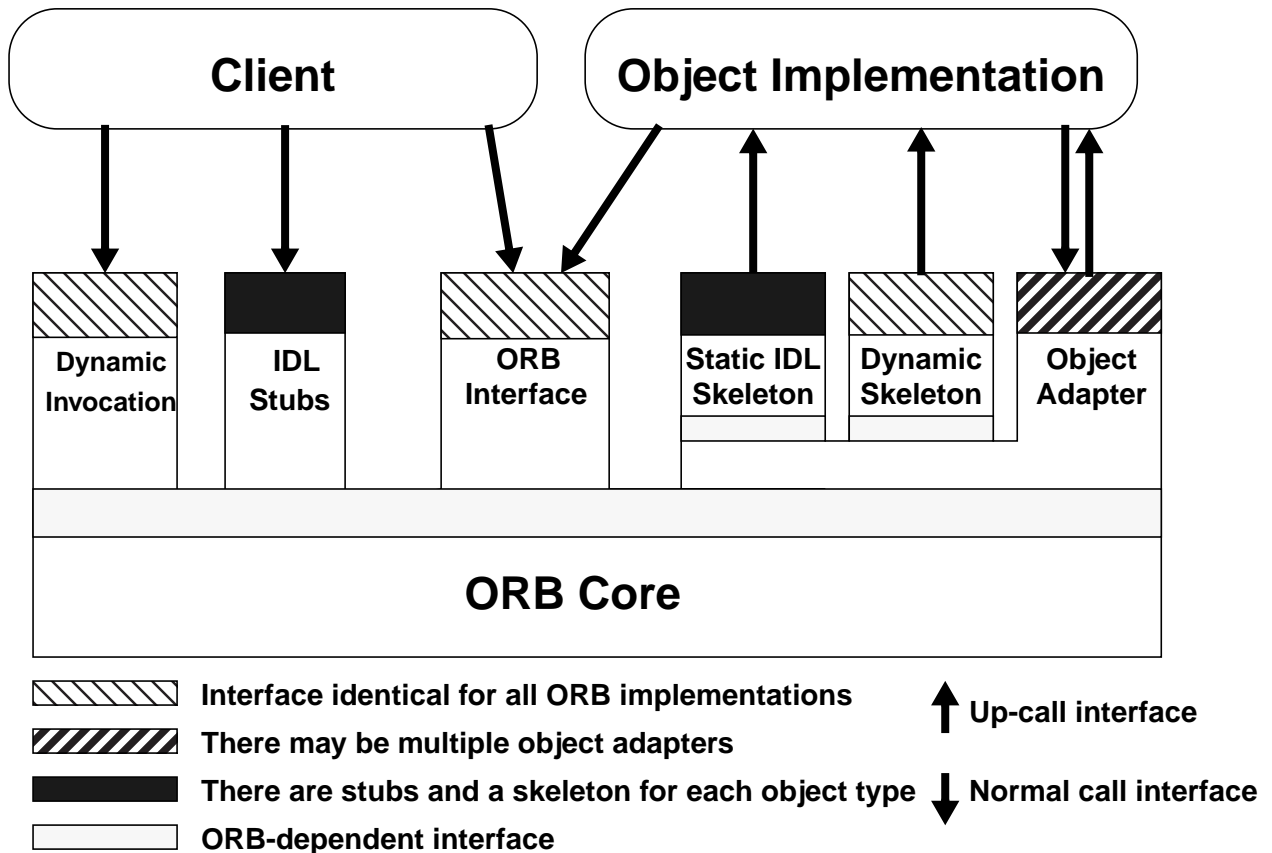

Figure 2-2 The Structure of Object Request Interfaces

To make a request, the Client can use the Dynamic Invocation interface (the same interface independent of the target object's interface) or an OMG IDL stub (the specific stub depending on the interface of the target object). The Client can also directly interact with the ORB for some functions.

The Object Implementation receives a request as an up-call either through the OMG IDL generated skeleton or through a dynamic skeleton. The Object Implementation may call the Object Adapter and the ORB while processing a request or at other times.

Definitions of the interfaces to objects can be defined in two ways. Interfaces can be defined statically in an interface definition language, called the OMG Interface Definition Language (OMG IDL). This language defines the types of objects according to the operations that may be performed on them and the parameters to those operations. Alternatively, or in addition, interfaces can be added to an Interface Repository service; this service represents the components of an interface as objects, permitting run-time access to these components. In any ORB implementation, the Interface Definition Language (which may be extended beyond its definition in this document) and the Interface Repository have equivalent expressive power.

The client performs a request by having access to an Object Reference for an object and knowing the type of the object and the desired operation to be performed. The client initiates the request by calling stub routines that are specific to the object or by constructing the request dynamically (see Figure 2-3).

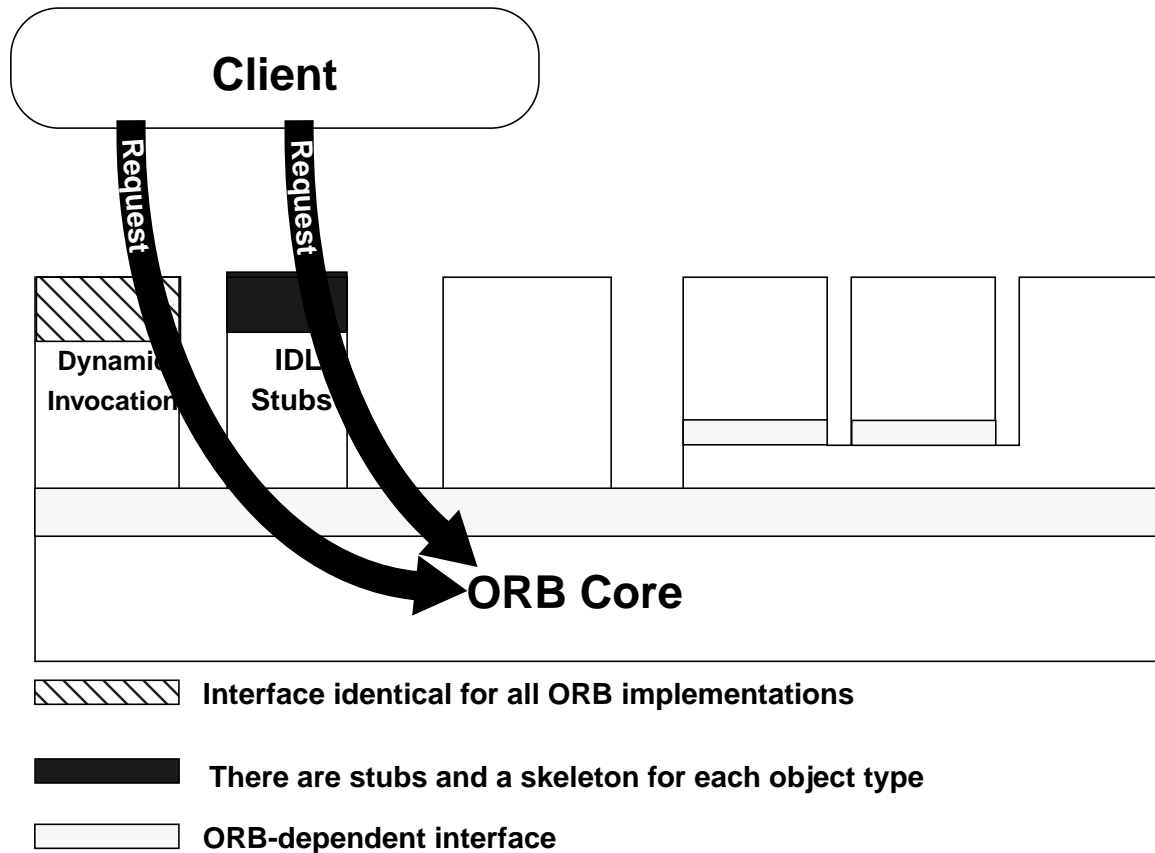

Figure 2-3 A Client Using the Stub or Dynamic Invocation Interface

The dynamic and stub interface for invoking a request satisfy the same request semantics, and the receiver of the message cannot tell how the request was invoked.

The ORB locates the appropriate implementation code, transmits parameters, and transfers control to the Object Implementation through an IDL skeleton or a dynamic skeleton (see Figure 2-4 on page 2-5). Skeletons are specific to the interface and the object adapter. In performing the request, the object implementation may obtain some services from the ORB through the Object Adapter. When the request is complete, control and output values are returned to the client.

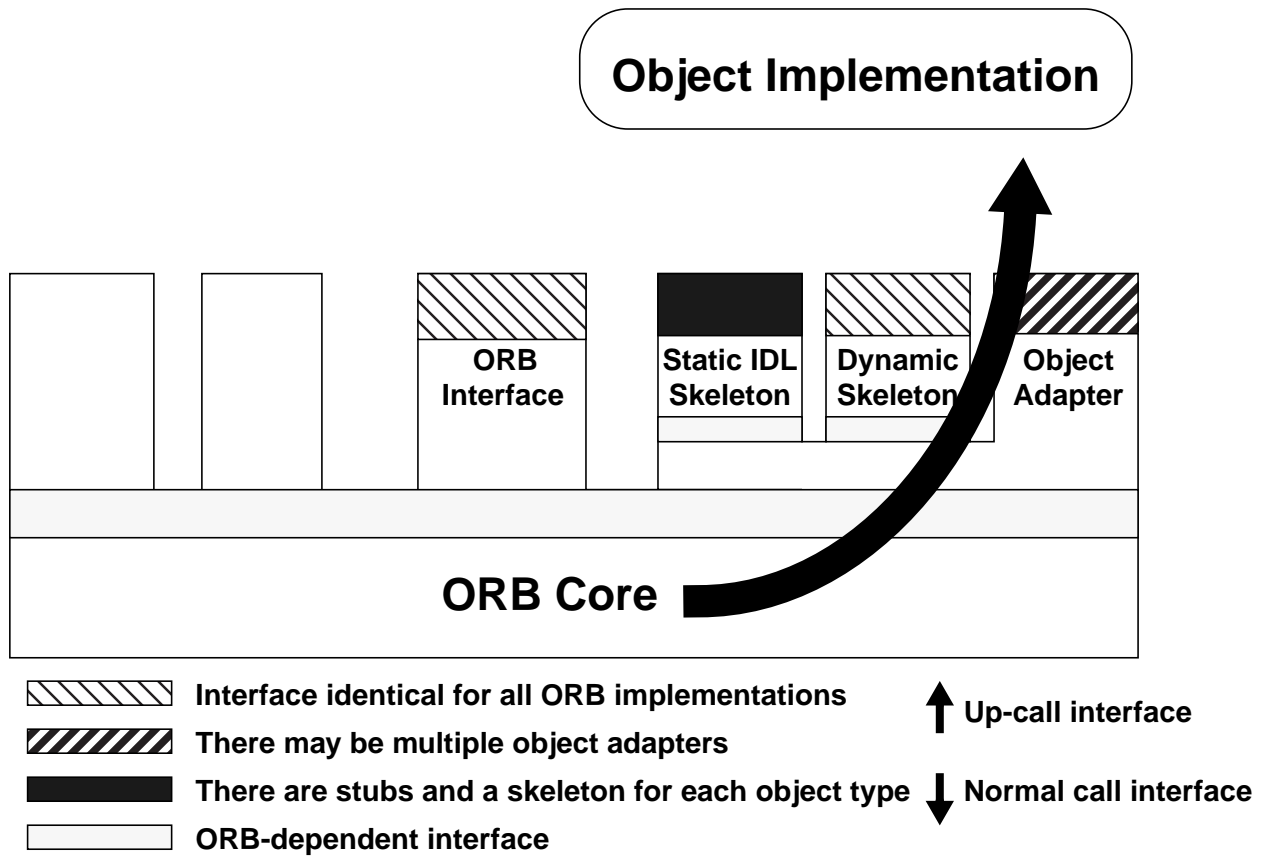

Figure 2-4 An Object Implementation Receiving a Request

The Object Implementation may choose which Object Adapter to use. This decision is based on what kind of services the Object Implementation requires.

Figure 2-5 on page 2-6 shows how interface and implementation information is made available to clients and object implementations. The interface is defined in OMG IDL and/or in the Interface Repository; the definition is used to generate the client Stubs and the object implementation Skeletons.

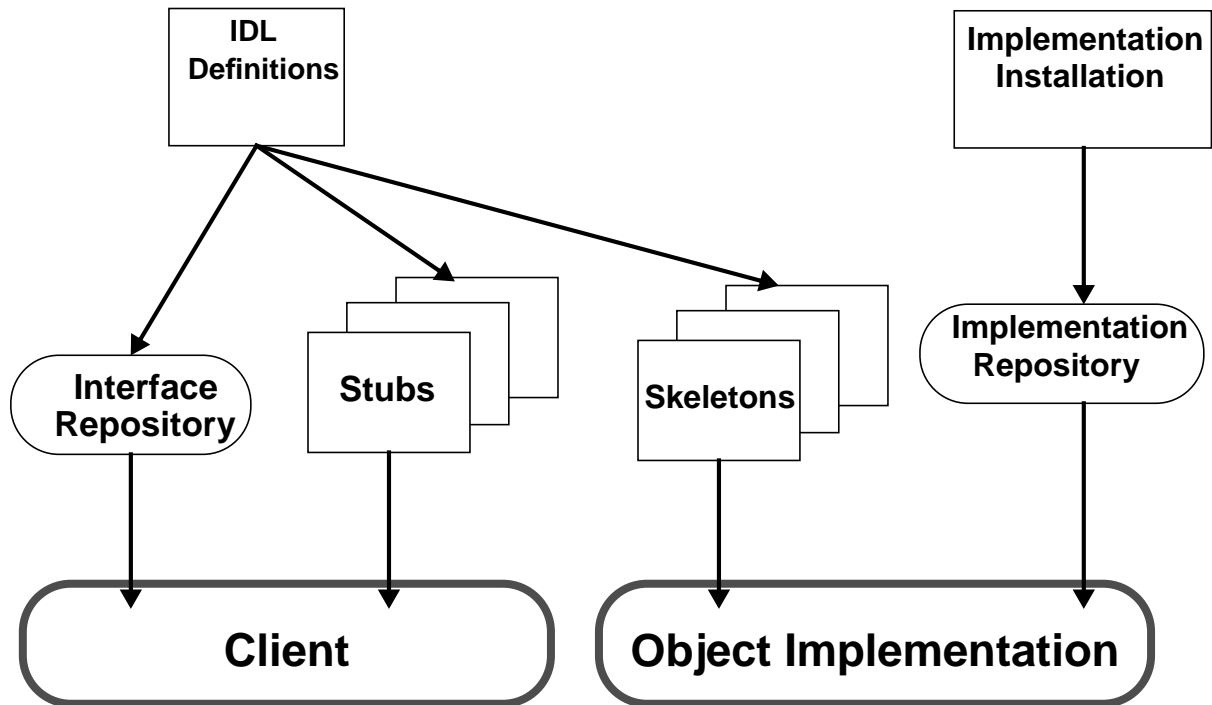

Figure 2-5 Interface and Implementation Repositories

The object implementation information is provided at installation time and is stored in the Implementation Repository for use during request delivery.

2.1.1 Object Request Broker

In the architecture, the ORB is not required to be implemented as a single component, but rather it is defined by its interfaces. Any ORB implementation that provides the appropriate interface is acceptable. The interface is organized into three categories:

1. Operations that are the same for all ORB implementations.
2. Operations that are specific to particular types of objects.
3. Operations that are specific to particular styles of object implementations.

Different ORBs may make quite different implementation choices, and, together with the IDL compilers, repositories, and various Object Adapters, provide a set of services to clients and implementations of objects that have different properties and qualities.

There may be multiple ORB implementations (also described as multiple ORBs), which have different representations for object references and different means of performing invocations. It may be possible for a client to simultaneously have access to

two object references managed by different ORB implementations. When two ORBs are intended to work together, those ORBs must be able to distinguish their object references. It is not the responsibility of the client to do so.

The ORB Core is that part of the ORB that provides the basic representation of objects and communication of requests. CORBA is designed to support different object mechanisms, and it does so by structuring the ORB with components above the ORB Core, which provide interfaces that can mask the differences between ORB Cores.

2.1.2 Clients

A client of an object has access to an object reference for the object, and invokes operations on the object. A client knows only the logical structure of the object according to its interface and experiences the behavior of the object through invocations. Although we will generally consider a client to be a program or process initiating requests on an object, it is important to recognize that something is a client relative to a particular object. For example, the implementation of one object may be a client of other objects.

Clients generally see objects and ORB interfaces through the perspective of a language mapping, bringing the ORB right up to the programmer's level. Clients are maximally portable and should be able to work without source changes on any ORB that supports the desired language mapping with any object instance that implements the desired interface. Clients have no knowledge of the implementation of the object, which object adapter is used by the implementation, or which ORB is used to access it.

2.1.3 Object Implementations

An object implementation provides the semantics of the object, usually by defining data for the object instance and code for the object's methods. Often the implementation will use other objects or additional software to implement the behavior of the object. In some cases, the primary function of the object is to have side-effects on other things that are not objects.

A variety of object implementations can be supported, including separate servers, libraries, a program per method, an encapsulated application, an object-oriented database, etc. Through the use of additional object adapters, it is possible to support virtually any style of object implementation.

Generally, object implementations do not depend on the ORB or how the client invokes the object. Object implementations may select interfaces to ORB-dependent services by the choice of Object Adapter.

2.1.4 Object References

An Object Reference is the information needed to specify an object within an ORB. Both clients and object implementations have an opaque notion of object references according to the language mapping, and thus are insulated from the actual representation of them. Two ORB implementations may differ in their choice of Object Reference representations.

The representation of an object reference handed to a client is only valid for the lifetime of that client.

All ORBs must provide the same language mapping to an object reference (usually referred to as an Object) for a particular programming language. This permits a program written in a particular language to access object references independent of the particular ORB. The language mapping may also provide additional ways to access object references in a typed way for the convenience of the programmer.

There is a distinguished object reference, guaranteed to be different from all object references, that denotes no object.

2.1.5 OMG Interface Definition Language

The OMG Interface Definition Language (OMG IDL) defines the types of objects by specifying their interfaces. An interface consists of a set of named operations and the parameters to those operations. Note that although IDL provides the conceptual framework for describing the objects manipulated by the ORB, it is not necessary for there to be IDL source code available for the ORB to work. As long as the equivalent information is available in the form of stub routines or a run-time interface repository, a particular ORB may be able to function correctly.

IDL is the means by which a particular object implementation tells its potential clients what operations are available and how they should be invoked. From the IDL definitions, it is possible to map CORBA objects into particular programming languages or object systems.

2.1.6 Mapping of OMG IDL to Programming Languages

Different object-oriented or non-object-oriented programming languages may prefer to access CORBA objects in different ways. For object-oriented languages, it may be desirable to see CORBA objects as programming language objects. Even for non-object-oriented languages, it is a good idea to hide the exact ORB representation of the object reference, method names, etc. A particular mapping of OMG IDL to a programming language should be the same for all ORB implementations. Language mapping includes definition of the language-specific data types and procedure interfaces to access objects through the ORB. It includes the structure of the client stub interface (not required for object-oriented languages), the dynamic invocation interface, the implementation skeleton, the object adapters, and the direct ORB interface.

A language mapping also defines the interaction between object invocations and the threads of control in the client or implementation. The most common mappings provide synchronous calls, in that the routine returns when the object operation completes. Additional mappings may be provided to allow a call to be initiated and control returned to the program. In such cases, additional language-specific routines must be provided to synchronize the program's threads of control with the object invocation.

2.1.7 Client Stubs

Generally, the client stubs will present access to the OMG IDL-defined operations on an object in a way that is easy for programmers to predict once they are familiar with OMG IDL and the language mapping for the particular programming language. The stubs make calls on the rest of the ORB using interfaces that are private to, and presumably optimized for, the particular ORB Core. If more than one ORB is available, there may be different stubs corresponding to the different ORBs. In this case, it is necessary for the ORB and language mapping to cooperate to associate the correct stubs with the particular object reference.

2.1.8 Dynamic Invocation Interface

An interface is also available that allows the dynamic construction of object invocations, that is, rather than calling a stub routine that is specific to a particular operation on a particular object, a client may specify the object to be invoked, the operation to be performed, and the set of parameters for the operation through a call or sequence of calls. The client code must supply information about the operation to be performed and the types of the parameters being passed (perhaps obtaining it from an Interface Repository or other run-time source). The nature of the dynamic invocation interface may vary substantially from one programming language mapping to another.

2.1.9 Implementation Skeleton

For a particular language mapping, and possibly depending on the object adapter, there will be an interface to the methods that implement each type of object. The interface will generally be an up-call interface, in that the object implementation writes routines that conform to the interface and the ORB calls them through the skeleton.

The existence of a skeleton does not imply the existence of a corresponding client stub (clients can also make requests via the dynamic invocation interface).

It is possible to write an object adapter that does not use skeletons to invoke implementation methods. For example, it may be possible to create implementations dynamically for languages such as Smalltalk.

2.1.10 Dynamic Skeleton Interface

An interface is available, which allows dynamic handling of object invocations. That is, rather than being accessed through a skeleton that is specific to a particular operation, an object's implementation is reached through an interface that provides access to the operation name and parameters in a manner analogous to the client side's Dynamic Invocation Interface. Purely static knowledge of those parameters may be used, or dynamic knowledge (perhaps determined through an Interface Repository) may be also used, to determine the parameters.

The implementation code must provide descriptions of all the operation parameters to the ORB, and the ORB provides the values of any input parameters for use in performing the operation. The implementation code provides the values of any output parameters, or an exception, to the ORB after performing the operation. The nature of the dynamic skeleton interface may vary substantially from one programming language mapping or object adapter to another, but will typically be an up-call interface.

Dynamic skeletons may be invoked both through client stubs and through the dynamic invocation interface; either style of client request construction interface provides identical results.

2.1.11 Object Adapters

An object adapter is the primary way that an object implementation accesses services provided by the ORB. There are expected to be a few object adapters that will be widely available, with interfaces that are appropriate for specific kinds of objects. Services provided by the ORB through an Object Adapter often include: generation and interpretation of object references, method invocation, security of interactions, object and implementation activation and deactivation, mapping object references to implementations, and registration of implementations.

The wide range of object granularities, lifetimes, policies, implementation styles, and other properties make it difficult for the ORB Core to provide a single interface that is convenient and efficient for all objects. Thus, through Object Adapters, it is possible for the ORB to target particular groups of object implementations that have similar requirements with interfaces tailored to them.

2.1.12 ORB Interface

The ORB Interface is the interface that goes directly to the ORB, which is the same for all ORBs and does not depend on the object's interface or object adapter. Because most of the functionality of the ORB is provided through the object adapter, stubs, skeleton, or dynamic invocation, there are only a few operations that are common across all objects. These operations are useful to both clients and implementations of objects.

2.1.13 *Interface Repository*

The Interface Repository is a service that provides persistent objects that represent the IDL information in a form available at run-time. The Interface Repository information may be used by the ORB to perform requests. Moreover, using the information in the Interface Repository, it is possible for a program to encounter an object whose interface was not known when the program was compiled, yet, be able to determine what operations are valid on the object and make an invocation on it.

In addition to its role in the functioning of the ORB, the Interface Repository is a common place to store additional information associated with interfaces to ORB objects. For example, debugging information, libraries of stubs or skeletons, routines that can format or browse particular kinds of objects might be associated with the Interface Repository.

2.1.14 *Implementation Repository*

The Implementation Repository contains information that allows the ORB to locate and activate implementations of objects. Although most of the information in the Implementation Repository is specific to an ORB or operating environment, the Implementation Repository is the conventional place for recording such information. Ordinarily, installation of implementations and control of policies related to the activation and execution of object implementations is done through operations on the Implementation Repository.

In addition to its role in the functioning of the ORB, the Implementation Repository is a common place to store additional information associated with implementations of ORB objects. For example, debugging information, administrative control, resource allocation, security, etc., might be associated with the Implementation Repository.

2.2 *Example ORBs*

There are a wide variety of ORB implementations possible within the Common ORB Architecture. This section will illustrate some of the different options. Note that a particular ORB might support multiple options and protocols for communication.

2.2.1 *Client- and Implementation-resident ORB*

If there is a suitable communication mechanism present, an ORB can be implemented in routines resident in the clients and implementations. The stubs in the client either use a location-transparent IPC mechanism or directly access a location service to establish communication with the implementations. Code linked with the implementation is responsible for setting up appropriate databases for use by clients.

2.2.2 *Server-based ORB*

To centralize the management of the ORB, all clients and implementations can communicate with one or more servers whose job it is to route requests from clients to implementations. The ORB could be a normal program as far as the underlying operating system is concerned, and normal IPC could be used to communicate with the ORB.

2.2.3 *System-based ORB*

To enhance security, robustness, and performance, the ORB could be provided as a basic service of the underlying operating system. Object references could be made unforgeable, reducing the expense of authentication on each request. Because the operating system could know the location and structure of clients and implementations, it would be possible for a variety of optimizations to be implemented, for example, avoiding marshalling when both are on the same machine.

2.2.4 *Library-based ORB*

For objects that are light-weight and whose implementations can be shared, the implementation might actually be in a library. In this case, the stubs could be the actual methods. This assumes that it is possible for a client program to get access to the data for the objects and that the implementation trusts the client not to damage the data.

2.3 *Structure of a Client*

A client of an object has an object reference that refers to that object. An object reference is a token that may be invoked or passed as a parameter to an invocation on a different object. Invocation of an object involves specifying the object to be invoked, the operation to be performed, and parameters to be given to the operation or returned from it.

The ORB manages the control transfer and data transfer to the object implementation and back to the client. In the event that the ORB cannot complete the invocation, an exception response is provided. Ordinarily, a client calls a routine in its program that performs the invocation and returns when the operation is complete.

Clients access object-type-specific stubs as library routines in their program (see Figure 2-6 on page 2-13). The client program thus sees routines callable in the normal way in its programming language. All implementations will provide a language-specific data type to use to refer to objects, often an opaque pointer. The client then passes that object reference to the stub routines to initiate an invocation. The stubs

have access to the object reference representation and interact with the ORB to perform the invocation. (See the C Language Mapping specification for additional, general information on language mapping of object references.)

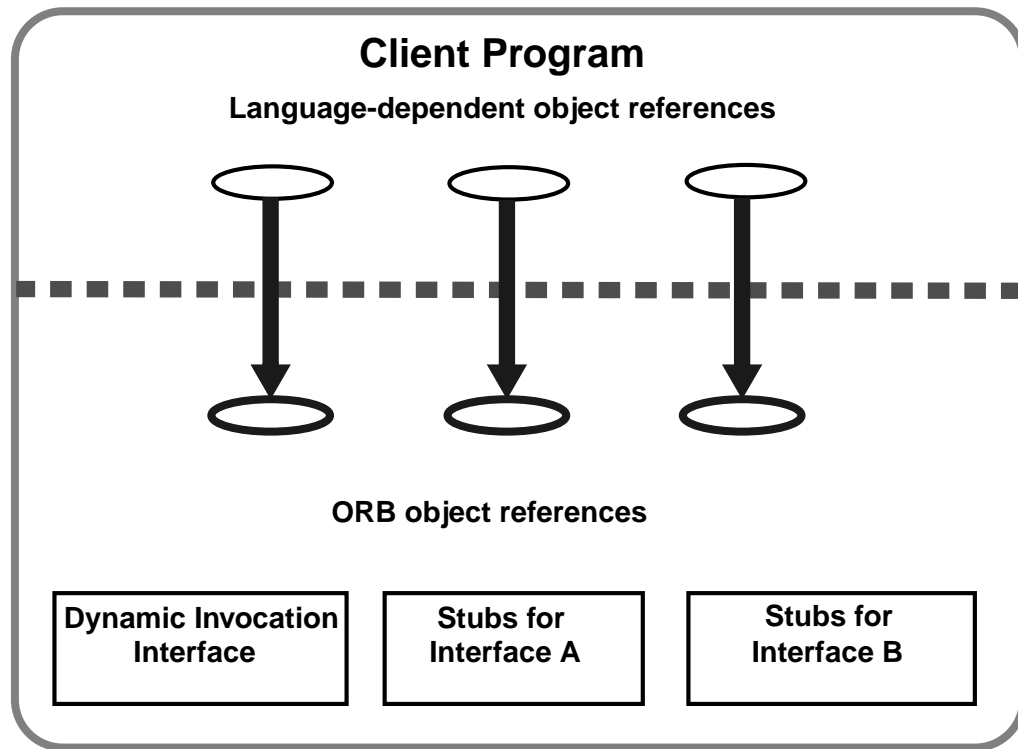

Figure 2-6 The Structure of a Typical Client

An alternative set of library code is available to perform invocations on objects, for example when the object was not defined at compile time. In that case, the client program provides additional information to name the type of the object and the method being invoked, and performs a sequence of calls to specify the parameters and initiate the invocation.

Clients most commonly obtain object references by receiving them as output parameters from invocations on other objects for which they have references. When a client is also an implementation, it receives object references as input parameters on invocations to objects it implements. An object reference can also be converted to a string that can be stored in files or preserved or communicated by different means and subsequently turned back into an object reference by the ORB that produced the string.

2.4 Structure of an Object Implementation

An object implementation provides the actual state and behavior of an object. The object implementation can be structured in a variety of ways. Besides defining the methods for the operations themselves, an implementation will usually define

procedures for activating and deactivating objects and will use other objects or non-object facilities to make the object state persistent, to control access to the object, as well as to implement the methods.

The object implementation (see Figure 2-7) interacts with the ORB in a variety of ways to establish its identity, to create new objects, and to obtain ORB-dependent services. It primarily does this via access to an Object Adapter, which provides an interface to ORB services that is convenient for a particular style of object implementation.

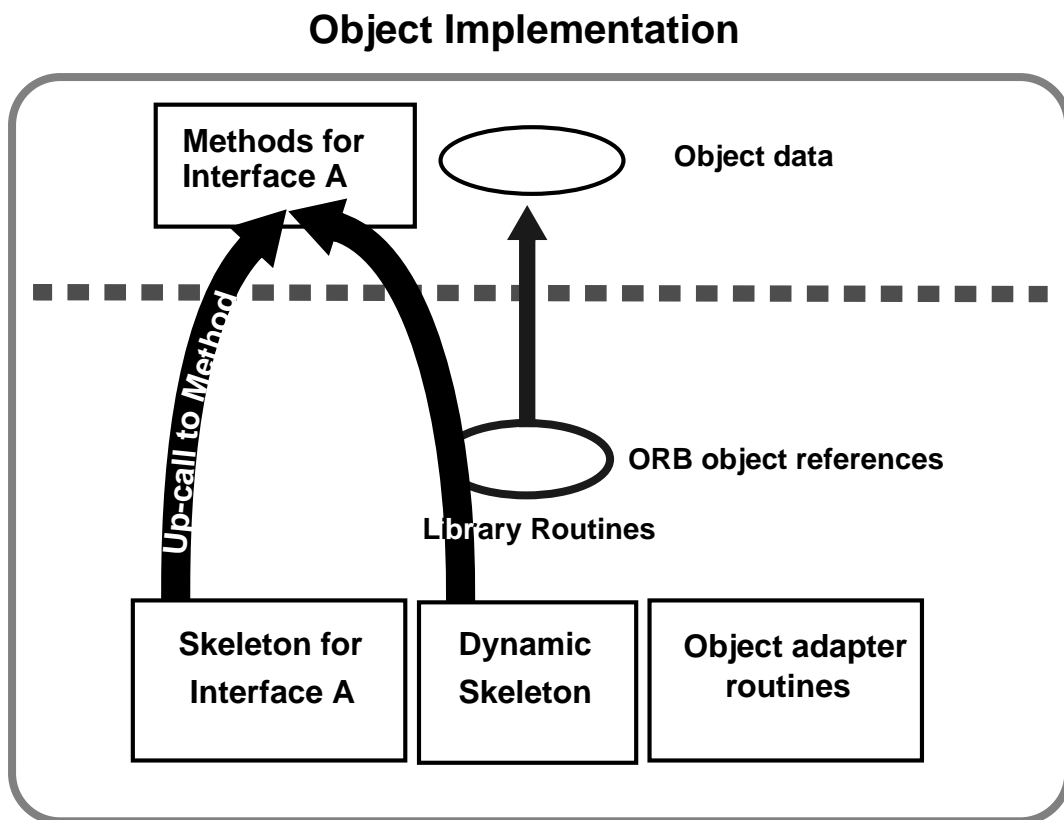

Figure 2-7 The Structure of a Typical Object Implementation

Because of the range of possible object implementations, it is difficult to be definitive about how an object implementation is structured. See the chapters on the Portable Object Adapter.

When an invocation occurs, the ORB Core, object adapter, and skeleton arrange that a call is made to the appropriate method of the implementation. A parameter to that method specifies the object being invoked, which the method can use to locate the data for the object. Additional parameters are supplied according to the skeleton definition. When the method is complete, it returns, causing output parameters or exception results to be transmitted back to the client.

When a new object is created, the ORB may be notified so that it knows where to find the implementation for that object. Usually, the implementation also registers itself as implementing objects of a particular interface, and specifies how to start up the implementation if it is not already running.

Most object implementations provide their behavior using facilities in addition to the ORB and object adapter. For example, although the Portable Object Adapter provides some persistent data associated with an object (its OID or Object ID), that relatively small amount of data is typically used as an identifier for the actual object data stored in a storage service of the object implementation's choosing. With this structure, it is not only possible for different object implementations to use the same storage service, it is also possible for objects to choose the service that is most appropriate for them.

2.5 *Structure of an Object Adapter*

An object adapter (see Figure 2-8 on page 2-16) is the primary means for an object implementation to access ORB services such as object reference generation. An object adapter exports a public interface to the object implementation, and a private interface to the skeleton. It is built on a private ORB-dependent interface.

Object adapters are responsible for the following functions:

- Generation and interpretation of object references
- Method invocation
- Security of interactions
- Object and implementation activation and deactivation
- Mapping object references to the corresponding object implementations
- Registration of implementations

These functions are performed using the ORB Core and any additional components necessary. Often, an object adapter will maintain its own state to accomplish its tasks. It may be possible for a particular object adapter to delegate one or more of its responsibilities to the Core upon which it is constructed.

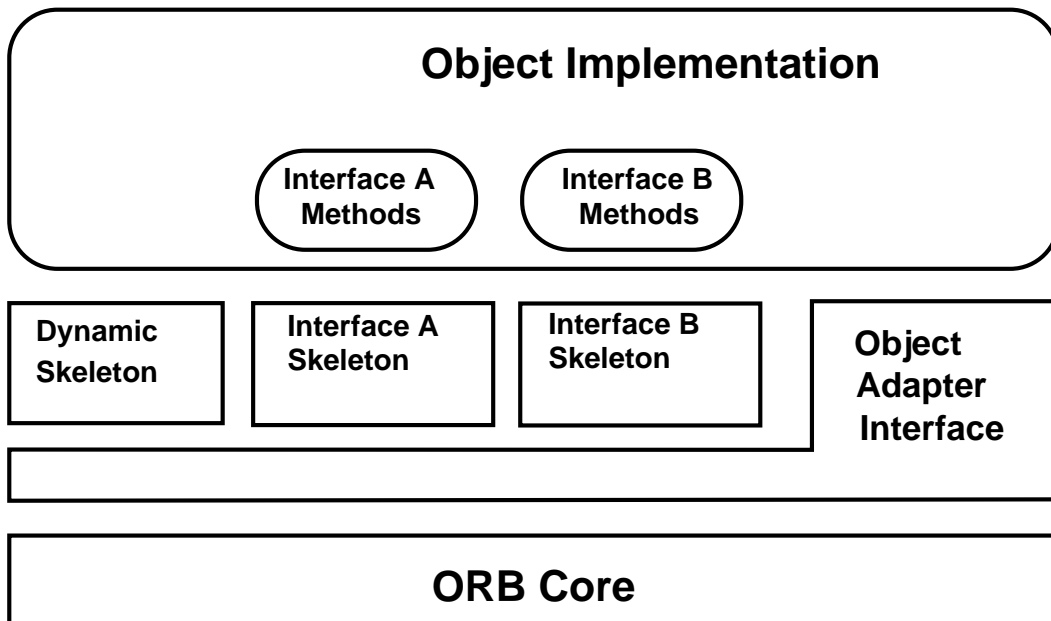

Figure 2-8 The Structure of a Typical Object Adapter

As shown in Figure 2-8, the Object Adapter is implicitly involved in invocation of the methods, although the direct interface is through the skeletons. For example, the Object Adapter may be involved in activating the implementation or authenticating the request.

The Object Adapter defines most of the services from the ORB that the Object Implementation can depend on. Different ORBs will provide different levels of service and different operating environments may provide some properties implicitly and require others to be added by the Object Adapter. For example, it is common for Object Implementations to want to store certain values in the object reference for easy identification of the object on an invocation. If the Object Adapter allows the implementation to specify such values when a new object is created, it may be able to store them in the object reference for those ORBs that permit it. If the ORB Core does not provide this feature, the Object Adapter would record the value in its own storage and provide it to the implementation on an invocation. With Object Adapters, it is possible for an Object Implementation to have access to a service whether or not it is implemented in the ORB Core—if the ORB Core provides it, the adapter simply provides an interface to it; if not, the adapter must implement it on top of the ORB Core. Every instance of a particular adapter must provide the same interface and service for all the ORBs it is implemented on.

It is also not necessary for all Object Adapters to provide the same interface or functionality. Some Object Implementations have special requirements. For example, an object-oriented database system may wish to implicitly register its many thousands of objects without doing individual calls to the Object Adapter. In such a case, it would

be impractical and unnecessary for the object adapter to maintain any per-object state. By using an object adapter interface that is tuned towards such object implementations, it is possible to take advantage of particular ORB Core details to provide the most effective access to the ORB.

2.6 *CORBA Required Object Adapter*

There are a variety of possible object adapters; however, since the object adapter interface is something that object implementations depend on, it is desirable that there be as few as practical. Most object adapters are designed to cover a range of object implementations, so only when an implementation requires radically different services or interfaces should a new object adapter be considered. In this section, we briefly describe the object adapter defined in this specification.

2.6.1 *Portable Object Adapter*

This specification defines a Portable Object Adapter that can be used for most ORB objects with conventional implementations. (See the *Portable Object Adapter* chapter for more information.) The intent of the POA, as its name suggests, is to provide an Object Adapter that can be used with multiple ORBs with a minimum of rewriting needed to deal with different vendors' implementations.

This specification allows several ways of using servers but it does not deal with the administrative issues of starting server programs. Once started, however, there can be a servant started and ended for a single method call, a separate servant for each object, or a shared servant for all instances of the object type. It allows for groups of objects to be associated by means of being registered with different instances of the POA object and allows implementations to specify their own activation techniques. If the implementation is not active when an invocation is performed, the POA will start one. The POA is specified in IDL, so its mapping to languages is largely automatic, following the language mapping rules. (The primary task left for a language mapping is the definition of the Servant type.)

2.7 *The Integration of Foreign Object Systems*

The Common ORB Architecture is designed to allow interoperation with a wide range of object systems (see Figure 2-9 on page 2-18). Because there are many existing object systems, a common desire will be to allow the objects in those systems to be accessible via the ORB. For those object systems that are ORBs themselves, they may be connected to other ORBs through the mechanisms described throughout this manual.

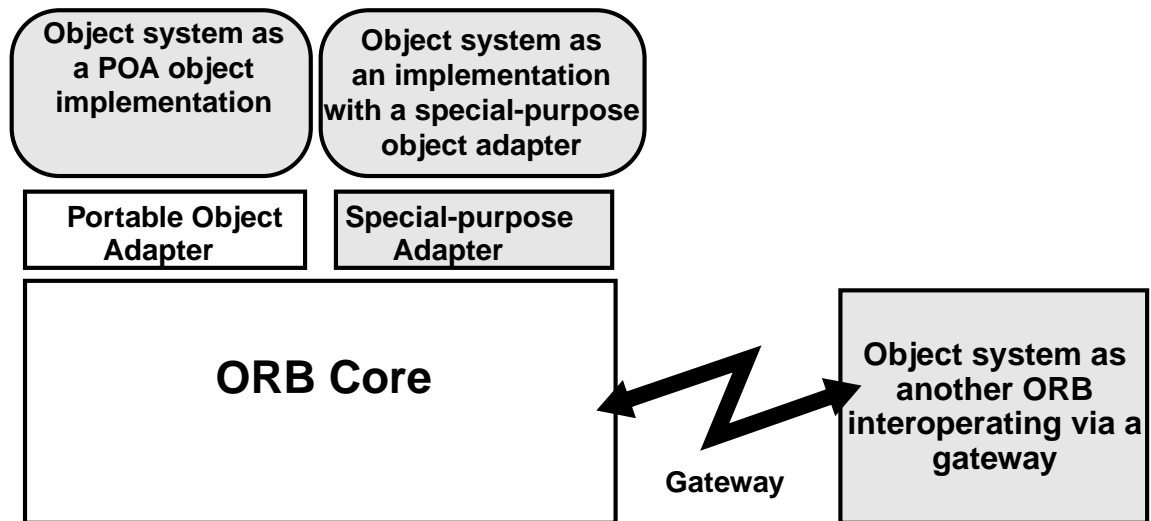

Figure 2-9 Different Ways to Integrate Foreign Object Systems

For object systems that simply want to map their objects into ORB objects and receive invocations through the ORB, one approach is to have those object systems appear to be implementations of the corresponding ORB objects. The object system would register its objects with the ORB and handle incoming requests, and could act like a client and perform outgoing requests.

In some cases, it will be impractical for another object system to act like a POA object implementation. An object adapter could be designed for objects that are created in conjunction with the ORB and that are primarily invoked through the ORB. Another object system may wish to create objects without consulting the ORB, and might expect most invocations to occur within itself rather than through the ORB. In such a case, a more appropriate object adapter might allow objects to be implicitly registered when they are passed through the ORB.

This chapter describes OMG Interface Definition Language (IDL) semantics and gives the syntax for OMG IDL grammatical constructs.

Contents

This chapter contains the following sections.

Section Title	Page
“Overview”	3-2
“Lexical Conventions”	3-3
“Preprocessing”	3-11
“OMG IDL Grammar”	3-12
“OMG IDL Specification”	3-18
“Module Declaration”	3-20
“Interface Declaration”	3-20
“Value Declaration”	3-27
“Constant Declaration”	3-32
“Type Declaration”	3-36
“Exception Declaration”	3-49
“Operation Declaration”	3-50
“Attribute Declaration”	3-53
“Repository Identity Related Declarations”	3-55
“Event Declaration”	3-57

Section Title	Page
“Component Declaration”	3-58
“Home Declaration”	3-63
“CORBA Module”	3-66
“Names and Scoping”	3-67

3.1 Overview

The OMG Interface Definition Language (IDL) is the language used to describe the interfaces that client objects call and object implementations provide. An interface definition written in OMG IDL completely defines the interface and fully specifies each operation’s parameters. An OMG IDL interface provides the information needed to develop clients that use the interface’s operations.

Clients are not written in OMG IDL, which is purely a descriptive language, but in languages for which mappings from OMG IDL concepts have been defined. The mapping of an OMG IDL concept to a client language construct will depend on the facilities available in the client language. For example, an OMG IDL exception might be mapped to a structure in a language that has no notion of exception, or to an exception in a language that does. The binding of OMG IDL concepts to several programming languages is described in this manual.

The description of OMG IDL’s lexical conventions is presented in Section 3.2, “Lexical Conventions,” on page 3-3. A description of OMG IDL preprocessing is presented in Section 3.3, “Preprocessing,” on page 3-11. The scope rules for identifiers in an OMG IDL specification are described in Section 3.20, “Names and Scoping,” on page 3-67.

OMG IDL is a declarative language. The grammar is presented in Section 3.4, “OMG IDL Grammar,” on page 3-12 and associated semantics is described in the rest of this chapter either in place or through references to other sections of this standard.

OMG IDL-specific pragmas (those not defined for C++) may appear anywhere in a specification; the textual location of these pragmas may be semantically constrained by a particular implementation.

A source file containing interface specifications written in OMG IDL must have an “.idl” extension.

The description of OMG IDL grammar uses a syntax notation that is similar to Extended Backus-Naur Format (EBNF). Table 3-1 lists the symbols used in this format and their meaning.

Table 3-1 IDL EBNF

Symbol	Meaning
::=	Is defined to be
	Alternatively

Table 3-1 IDL EBNF (Continued)

Symbol	Meaning
<text>	Nonterminal
"text"	Literal
*	The preceding syntactic unit can be repeated zero or more times
+	The preceding syntactic unit can be repeated one or more times
{ }	The enclosed syntactic units are grouped as a single syntactic unit
[]	The enclosed syntactic unit is optional—may occur zero or one time

3.2 Lexical Conventions

This section¹ presents the lexical conventions of OMG IDL. It defines tokens in an OMG IDL specification and describes comments, identifiers, keywords, and literals—integer, character, and floating point constants and string literals.

An OMG IDL specification logically consists of one or more files. A file is conceptually translated in several phases.

The first phase is preprocessing, which performs file inclusion and macro substitution. Preprocessing is controlled by directives introduced by lines having # as the first character other than white space. The result of preprocessing is a sequence of tokens. Such a sequence of tokens, that is, a file after preprocessing, is called a translation unit.

OMG IDL uses the ASCII character set, except for string literals and character literals, which use the ISO Latin-1 (8859.1) character set. The ISO Latin-1 character set is divided into alphabetic characters (letters) digits, graphic characters, the space (blank) character, and formatting characters. Table 3-2 shows the ISO Latin-1 alphabetic characters; upper and lower case equivalences are paired. The ASCII alphabetic characters are shown in the left-hand column of Table 3-2.

Table 3-2 The 114 Alphabetic Characters (Letters)

Char.	Description	Char.	Description
Aa	Upper/Lower-case A	Àà	Upper/Lower-case A with grave accent
Bb	Upper/Lower-case B	Áá	Upper/Lower-case A with acute accent
Cc	Upper/Lower-case C	Ââ	Upper/Lower-case A with circumflex accent
Dd	Upper/Lower-case D	Ãã	Upper/Lower-case A with tilde
Ee	Upper/Lower-case E	Ää	Upper/Lower-case A with diaeresis
Ff	Upper/Lower-case F	Åå	Upper/Lower-case A with ring above
Gg	Upper/Lower-case G	Ææ	Upper/Lower-case diphthong A with E
Hh	Upper/Lower-case H	Çç	Upper/Lower-case C with cedilla
Ii	Upper/Lower-case I	Èè	Upper/Lower-case E with grave accent

1. This section is an adaptation of *The Annotated C++ Reference Manual*, Chapter 2; it differs in the list of legal keywords and punctuation.

Table 3-2 The 114 Alphabetic Characters (Letters) (Continued)

Char.	Description	Char.	Description
Jj	Upper/Lower-case J	Éé	Upper/Lower-case E with acute accent
Kk	Upper/Lower-case K	Êê	Upper/Lower-case E with circumflex accent
Ll	Upper/Lower-case L	Ëë	Upper/Lower-case E with diaeresis
Mm	Upper/Lower-case M	Ìì	Upper/Lower-case I with grave accent
Nn	Upper/Lower-case N	Íí	Upper/Lower-case I with acute accent
Oo	Upper/Lower-case O	Îî	Upper/Lower-case I with circumflex accent
Pp	Upper/Lower-case P	Ïï	Upper/Lower-case I with diaeresis
Qq	Upper/Lower-case Q	Ññ	Upper/Lower-case N with tilde
Rr	Upper/Lower-case R	Òò	Upper/Lower-case O with grave accent
Ss	Upper/Lower-case S	Óó	Upper/Lower-case O with acute accent
Tt	Upper/Lower-case T	Ôô	Upper/Lower-case O with circumflex accent
Uu	Upper/Lower-case U	Õõ	Upper/Lower-case O with tilde
Vv	Upper/Lower-case V	Öö	Upper/Lower-case O with diaeresis
Ww	Upper/Lower-case W	Øø	Upper/Lower-case O with oblique stroke
Xx	Upper/Lower-case X	Ùù	Upper/Lower-case U with grave accent
Yy	Upper/Lower-case Y	Úú	Upper/Lower-case U with acute accent
Zz	Upper/Lower-case Z	Ûû	Upper/Lower-case U with circumflex accent
		Üü	Upper/Lower-case U with diaeresis
		ß	Lower-case German sharp S
		ÿ	Lower-case Y with diaeresis

Table 3-3 lists the decimal digit characters.

Table 3-3 Decimal Digits

0 1 2 3 4 5 6 7 8 9

Table 3-4 shows the graphic characters.

Table 3-4 The 65 Graphic Characters

Char.	Description	Char.	Description
!	exclamation point	¡	inverted exclamation mark
"	double quote	¢	cent sign
#	number sign	£	pound sign
\$	dollar sign	¤	currency sign
%	percent sign	¥	yen sign
&	ampersand	¦	broken bar
'	apostrophe	§	section/paragraph sign
(left parenthesis	¨	diaeresis
)	right parenthesis	©	copyright sign
*	asterisk	ª	feminine ordinal indicator

Table 3-4 The 65 Graphic Characters (Continued)

Char.	Description	Char.	Description
+	plus sign	«	left angle quotation mark
,	comma	¬	not sign
-	hyphen, minus sign		soft hyphen
.	period, full stop	®	registered trade mark sign
/	solidus	ˉ	macron
:	colon	°	ring above, degree sign
;	semicolon		plus-minus sign
<	less-than sign	²	superscript two
=	equals sign	³	superscript three
>	greater-than sign	´	acute
?	question mark	μ	micro
@	commercial at	¶	pilcrow
[left square bracket	•	middle dot
\	reverse solidus	¸	cedilla
]	right square bracket	¹	superscript one
^	circumflex	º	masculine ordinal indicator
_	low line, underscore	»	right angle quotation mark
‘	grave		vulgar fraction 1/4
{	left curly bracket		vulgar fraction 1/2
	vertical line		vulgar fraction 3/4
}	right curly bracket	¿	inverted question mark
~	tilde	¥	multiplication sign
			division sign

The formatting characters are shown in Table 3-5.

Table 3-5 The Formatting Characters

Description	Abbreviation	ISO 646 Octal Value
alert	BEL	007
backspace	BS	010
horizontal tab	HT	011
newline	NL, LF	012
vertical tab	VT	013
form feed	FF	014
carriage return	CR	015

3.2.1 Tokens

There are five kinds of tokens: identifiers, keywords, literals, operators, and other separators. Blanks, horizontal and vertical tabs, newlines, formfeeds, and comments (collective, “white space”), as described below, are ignored except as they serve to separate tokens. Some white space is required to separate otherwise adjacent identifiers, keywords, and constants.

If the input stream has been parsed into tokens up to a given character, the next token is taken to be the longest string of characters that could possibly constitute a token.

3.2.2 Comments

The characters `/*` start a comment, which terminates with the characters `*/`. These comments do not nest. The characters `//` start a comment, which terminates at the end of the line on which they occur. The comment characters `//`, `/*`, and `*/` have no special meaning within a `//` comment and are treated just like other characters. Similarly, the comment characters `//` and `/*` have no special meaning within a `/*` comment. Comments may contain alphabetic, digit, graphic, space, horizontal tab, vertical tab, form feed, and newline characters.

3.2.3 Identifiers

An identifier is an arbitrarily long sequence of ASCII alphabetic, digit, and underscore (“_”) characters. The first character must be an ASCII alphabetic character. All characters are significant.

When comparing two identifiers to see if they collide:

- Upper- and lower-case letters are treated as the same letter. Table 3-2 on page 3-3 defines the equivalence mapping of upper- and lower-case letters.
- All characters are significant.

Identifiers that differ only in case collide, and will yield a compilation error under certain circumstances. An identifier for a given definition must be spelled identically (e.g., with respect to case) throughout a specification.

There is only one namespace for OMG IDL identifiers in each scope. Using the same identifier for a constant and an interface, for example, produces a compilation error.

For example:

```
module M {  
    typedef long Foo;  
    const long thing = 1;  
    interface thing { // error: reuse of identifier  
        void doit (  
            in Foo foo // error: Foo and foo collide and refer to  
                        different things  
        );
```

```

        readonly attribute long Attribute; // error: Attribute collides with
        keyword attribute
    };
};

```

3.2.3.1 Escaped Identifiers

As IDL evolves, new keywords that are added to the IDL language may inadvertently collide with identifiers used in existing IDL and programs that use that IDL. Fixing these collisions will require not only the IDL to be modified, but programming language code that depends upon that IDL will have to change as well. The language mapping rules for the renamed IDL identifiers will cause the mapped identifier names (e.g., method names) to be changed.

To minimize the amount of work, users may lexically “escape” identifiers by prepending an underscore (`_`) to an identifier. This is a purely lexical convention that **ONLY** turns off keyword checking. The resulting identifier follows all the other rules for identifier processing. For example, the identifier `_AnIdentifier` is treated as if it were `AnIdentifier`.

The following is a non-exclusive list of implications of these rules:

- The underscore does not appear in the Interface Repository.
- The underscore is not used in the DII and DSI.
- The underscore is not transmitted over “the wire.”
- Case sensitivity rules are applied to the identifier after stripping off the leading underscore.

For example:

```

module M {
    interface thing {
        attribute boolean abstract; // error: abstract collides with
                                        // keyword abstract
        attribute boolean _abstract; // ok: abstract is an identifier
    };
};

```

To avoid unnecessary confusion for readers of IDL, it is recommended that interfaces only use the escaped form of identifiers when the unescaped form clashes with a newly introduced IDL keyword. It is also recommended that interface designers avoid defining new identifiers that are known to require escaping. Escaped literals are only recommended for IDL that expresses legacy interface, or for IDL that is mechanically generated.

3.2.4 Keywords

The identifiers listed in Table 3-6 are reserved for use as keywords and may not be used otherwise, unless escaped with a leading underscore.

Table 3-6 Keywords

abstract	exception	inout	provides	truncatable
any	emits	interface	public	typedef
attribute	enum	local	publishes	typeid
boolean	eventtype	long	raises	typeprefix
case	factory	module	readonly	unsigned
char	FALSE	multiple	setraises	union
component	finder	native	sequence	uses
const	fixed	Object	short	ValueBase
consumes	float	octet	string	valuetype
context	getraises	oneway	struct	void
custom	home	out	supports	wchar
default	import	primarykey	switch	wstring
double	in	private	TRUE	

Keywords must be written exactly as shown in the above list. Identifiers that collide with keywords (see Section 3.2.3, “Identifiers,” on page 3-6) are illegal. For example, “**boolean**” is a valid keyword; “**Boolean**” and “**BOOLEAN**” are illegal identifiers.

For example:

```

module M {
    typedef Long Foo;           // Error: keyword is long not Long
    typedef boolean BOOLEAN; // Error: BOOLEAN collides with
                                // the keyword boolean;
};

```

OMG IDL specifications use the characters shown in Table 3-7 as punctuation.

Table 3-7 Punctuation Characters

;	{	}	:	,	=	+	-	()	<	>	[]
'	"	\		^	&	*	/	%	~				

In addition, the tokens listed in Table 3-8 are used by the preprocessor.

Table 3-8 Preprocessor Tokens

#	##	!		&&
---	----	---	--	----

3.2.5 Literals

This section describes the following literals:

- Integer

- Character
- Floating-point
- String
- Fixed-point

3.2.5.1 *Integer Literals*

An integer literal consisting of a sequence of digits is taken to be decimal (base ten) unless it begins with 0 (digit zero). A sequence of digits starting with 0 is taken to be an octal integer (base eight). The digits 8 and 9 are not octal digits. A sequence of digits preceded by 0x or 0X is taken to be a hexadecimal integer (base sixteen). The hexadecimal digits include a or A through f or F with decimal values ten through fifteen, respectively. For example, the number twelve can be written 12, 014, or 0XC.

3.2.5.2 *Character Literals*

A character literal is one or more characters enclosed in single quotes, as in 'x'. Character literals have type **char**.

A character is an 8-bit quantity with a numerical value between 0 and 255 (decimal). The value of a space, alphabetic, digit, or graphic character literal is the numerical value of the character as defined in the ISO Latin-1 (8859.1) character set standard (See Table 3-2 on page 3-3, Table 3-3 on page 3-4, and Table 3-4 on page 3-4). The value of a null is 0. The value of a formatting character literal is the numerical value of the character as defined in the ISO 646 standard (see Table 3-5 on page 3-5). The meaning of all other characters is implementation-dependent.

Nongraphic characters must be represented using escape sequences as defined below in Table 3-9. Note that escape sequences must be used to represent single quote and backslash characters in character literals.

Table 3-9 Escape Sequences

Description	Escape Sequence
newline	\n
horizontal tab	\t
vertical tab	\v
backspace	\b
carriage return	\r
form feed	\f
alert	\a
backslash	\\
question mark	\?
single quote	\'
double quote	\"
octal number	\ooo

Table 3-9 Escape Sequences (*Continued*)

Description	Escape Sequence
hexadecimal number	\xhh
unicode character	\uhhhh

If the character following a backslash is not one of those specified, the behavior is undefined. An escape sequence specifies a single character.

The escape \ooo consists of the backslash followed by one, two, or three octal digits that are taken to specify the value of the desired character. The escape \xhh consists of the backslash followed by x followed by one or two hexadecimal digits that are taken to specify the value of the desired character.

The escape \uhhhh consists of a backslash followed by the character 'u', followed by one, two, three or four hexadecimal digits. This represents a unicode character literal. Thus the literal "\u002E" represents the unicode period '.' character and the literal "\u3BC" represents the unicode greek small letter 'mu'. The \u escape is valid only with wchar and wstring types. Because a wide string literal is defined as a sequence of wide character literals a sequence of \u literals can be used to define a wide string literal. Attempts to set a char type to a \u defined literal or a string type to a sequence of \u literals result in an error.

A sequence of octal or hexadecimal digits is terminated by the first character that is not an octal digit or a hexadecimal digit, respectively. The value of a character constant is implementation dependent if it exceeds that of the largest char.

Wide character literals have an **L** prefix, for example:

```
const wchar C1 = L'X';
```

Attempts to assign a wide character literal to a non-wide character constant or to assign a non-wide character literal to a wide character constant result in a compile-time diagnostic.

Both wide and non-wide character literals must be specified using characters from the ISO 8859-1 character set.

3.2.5.3 *Floating-point Literals*

A floating-point literal consists of an integer part, a decimal point, a fraction part, an e or E, and an optionally signed integer exponent. The integer and fraction parts both consist of a sequence of decimal (base ten) digits. Either the integer part or the fraction part (but not both) may be missing; either the decimal point or the letter e (or E) and the exponent (but not both) may be missing.

3.2.5.4 *String Literals*

A string literal is a sequence of characters (as defined in Section 3.2.5.2, "Character Literals," on page 3-9), with the exception of the character with numeric value 0, surrounded by double quotes, as in "...".

Adjacent string literals are concatenated. Characters in concatenated strings are kept distinct. For example,

```
"\xA" "B"
```

contains the two characters '\xA' and 'B' after concatenation (and not the single hexadecimal character '\xAB').

The size of a string literal is the number of character literals enclosed by the quotes, after concatenation. Within a string, the double quote character " must be preceded by a \.

A string literal may not contain the character '\0'.

Wide string literals have an L prefix, for example:

```
const wstring S1 = L"Hello";
```

Attempts to assign a wide string literal to a non-wide string constant or to assign a non-wide string literal to a wide string constant result in a compile-time diagnostic.

Both wide and non-wide string literals must be specified using characters from the ISO 8859-1 character set.

A wide string literal shall not contain the wide character with value zero.

3.2.5.5 *Fixed-Point Literals*

A fixed-point decimal literal consists of an integer part, a decimal point, a fraction part and a d or D. The integer and fraction parts both consist of a sequence of decimal (base 10) digits. Either the integer part or the fraction part (but not both) may be missing; the decimal point (but not the letter d (or D)) may be missing.

3.3 *Preprocessing*

OMG IDL is preprocessed according to the specification of the preprocessor in “International Organization for Standardization. 1998. ISO/IEC 14882 Standard for the C++ Programming Language. Geneva: International Organization for Standardization.” The preprocessor may be implemented as a separate process or built into the IDL compiler.

Lines beginning with # (also called “directives”) communicate with this preprocessor. White space may appear before the #. These lines have syntax independent of the rest of OMG IDL; they may appear anywhere and have effects that last (independent of the OMG IDL scoping rules) until the end of the translation unit. The textual location of OMG IDL-specific pragmas may be semantically constrained.

A preprocessing directive (or any line) may be continued on the next line in a source file by placing a backslash character (“\”), immediately before the newline at the end of the line to be continued. The preprocessor effects the continuation by deleting the backslash and the newline before the input sequence is divided into tokens. A backslash character may not be the last character in a source file.

A preprocessing token is an OMG IDL token (see Section 3.2.1, “Tokens,” on page 3-6), a file name as in a **#include** directive, or any single character other than white space that does not match another preprocessing token.

The primary use of the preprocessing facilities is to include definitions from other OMG IDL specifications. Text in files included with a **#include** directive is treated as if it appeared in the including file, except that **RepositoryId** related pragmas are handled in a special way. The special handling of these pragmas is described in Section 10.7, “RepositoryIds,” on page 10-64.

Note that whether a particular IDL compiler generates code for included files is an implementation-specific issue. To support separate compilation, IDL compilers may not generate code for included files, or do so only if explicitly instructed.

3.4 OMG IDL Grammar

(1)	<specification>	::= <import> * <definition> ⁺
(2)	<definition>	::= <type_dcl> “,” <const_dcl> “,” <except_dcl> “,” <interface> “,” <module> “,” <value> “,” <type_id_dcl> “,” <type_prefix_dcl> “,” <event> “,” <component> “,” <home_dcl> “,”
(3)	<module>	::= “module” <identifier> “{” <definition> ⁺ “}”
(4)	<interface>	::= <interface_dcl> <forward_dcl>
(5)	<interface_dcl>	::= <interface_header> “{” <interface_body> “}”
(6)	<forward_dcl>	::= [“abstract” “local”] “interface” <identifier>
(7)	<interface_header>	::= [“abstract” “local”] “interface” <identifier> [<interface_inheritance_spec>]
(8)	<interface_body>	::= <export> [*]
(9)	<export>	::= <type_dcl> “,” <const_dcl> “,” <except_dcl> “,” <attr_dcl> “,” <op_dcl> “,” <type_id_dcl> “,” <type_prefix_dcl> “,”
(10)	<interface_inheritance_spec>	::= “:” <interface_name> { “,” <interface_name> } [*]
(11)	<interface_name>	::= <scoped_name>
(12)	<scoped_name>	::= <identifier> “:” <identifier> <scoped_name> “:” <identifier>

- (13) `<value>` ::= (`<value_dcl>` | `<value_abs_dcl>` | `<value_box_dcl>` | `<value_forward_dcl>`)
- (14) `<value_forward_dcl>` ::= [“abstract”] “valuetype” `<identifier>`
- (15) `<value_box_dcl>` ::= “valuetype” `<identifier>` `<type_spec>`
- (16) `<value_abs_dcl>` ::= “abstract” “valuetype” `<identifier>`
[`<value_inheritance_spec>`]
“{“ `<export>`* “}”
- (17) `<value_dcl>` ::= `<value_header>` “{“ `<value_element>`* “}”
- (18) `<value_header>` ::= [“custom”] “valuetype” `<identifier>`
[`<value_inheritance_spec>`]
- (19) `<value_inheritance_spec>` ::= [“:” [“truncatable”] `<value_name>`
{ “,” `<value_name>` }*]
[“supports” `<interface_name>`
{ “,” `<interface_name>` }*]
- (20) `<value_name>` ::= `<scoped_name>`
- (21) `<value_element>` ::= `<export>` | `<state_member>` | `<init_dcl>`
- (22) `<state_member>` ::= (“public” | “private”)
`<type_spec>` `<declarators>` “;”
- (23) `<init_dcl>` ::= “factory” `<identifier>`
“(“ [`<init_param_decls>`] “)”
[`<raises_expr>`] “;”
- (24) `<init_param_decls>` ::= `<init_param_decl>` { “,” `<init_param_decl>` }*
- (25) `<init_param_decl>` ::= `<init_param_attribute>` `<param_type_spec>`
`<simple_declarator>`
- (26) `<init_param_attribute>` ::= “in”
- (27) `<const_dcl>` ::= “const” `<const_type>`
`<identifier>` “=” `<const_expr>`
- (28) `<const_type>` ::= `<integer_type>`
| `<char_type>`
| `<wide_char_type>`
| `<boolean_type>`
| `<floating_pt_type>`
| `<string_type>`
| `<wide_string_type>`
| `<fixed_pt_const_type>`
| `<scoped_name>`
| `<octet_type>`
- (29) `<const_expr>` ::= `<or_expr>`
- (30) `<or_expr>` ::= `<xor_expr>`
| `<or_expr>` “|” `<xor_expr>`
- (31) `<xor_expr>` ::= `<and_expr>`
| `<xor_expr>` “^” `<and_expr>`
- (32) `<and_expr>` ::= `<shift_expr>`
| `<and_expr>` “&” `<shift_expr>`
- (33) `<shift_expr>` ::= `<add_expr>`
| `<shift_expr>` “>>” `<add_expr>`
| `<shift_expr>` “<<” `<add_expr>`

- (34) `<add_expr>` ::= `<mult_expr>`
| `<add_expr>` “+” `<mult_expr>`
| `<add_expr>` “-” `<mult_expr>`
- (35) `<mult_expr>` ::= `<unary_expr>`
| `<mult_expr>` “*” `<unary_expr>`
| `<mult_expr>` “/” `<unary_expr>`
| `<mult_expr>` “%” `<unary_expr>`
- (36) `<unary_expr>` ::= `<unary_operator>` `<primary_expr>`
| `<primary_expr>`
- (37) `<unary_operator>` ::= “-”
| “+”
| “~”
- (38) `<primary_expr>` ::= `<scoped_name>`
| `<literal>`
| “(” `<const_exp>` “)”
- (39) `<literal>` ::= `<integer_literal>`
| `<string_literal>`
| `<wide_string_literal>`
| `<character_literal>`
| `<wide_character_literal>`
| `<fixed_pt_literal>`
| `<floating_pt_literal>`
| `<boolean_literal>`
- (40) `<boolean_literal>` ::= “TRUE”
| “FALSE”
- (41) `<positive_int_const>` ::= `<const_exp>`
- (42) `<type_dcl>` ::= “typedef” `<type_declarator>`
| `<struct_type>`
| `<union_type>`
| `<enum_type>`
| “native” `<simple_declarator>`
| `<constr_forward_decl>`
- (43) `<type_declarator>` ::= `<type_spec>` `<declarators>`
- (44) `<type_spec>` ::= `<simple_type_spec>`
| `<constr_type_spec>`
- (45) `<simple_type_spec>` ::= `<base_type_spec>`
| `<template_type_spec>`
| `<scoped_name>`
- (46) `<base_type_spec>` ::= `<floating_pt_type>`
| `<integer_type>`
| `<char_type>`
| `<wide_char_type>`
| `<boolean_type>`
| `<octet_type>`
| `<any_type>`
| `<object_type>`
| `<value_base_type>`
- (47) `<template_type_spec>` ::= `<sequence_type>`

			<string_type>
			<wide_string_type>
			<fixed_pt_type>
(48)	<constr_type_spec>	::=	<struct_type>
			<union_type>
			<enum_type>
(49)	<declarators>	::=	<declarator> { “,” <declarator> }*
(50)	<declarator>	::=	<simple_declarator>
			<complex_declarator>
(51)	<simple_declarator>	::=	<identifier>
(52)	<complex_declarator>	::=	<array_declarator>
(53)	<floating_pt_type>	::=	“float”
			“double”
			“long” “double”
(54)	<integer_type>	::=	<signed_int>
			<unsigned_int>
(55)	<signed_int>	::=	<signed_short_int>
			<signed_long_int>
			<signed_longlong_int>
(56)	<signed_short_int>	::=	“short”
(57)	<signed_long_int>	::=	“long”
(58)	<signed_longlong_int>	::=	“long” “long”
(59)	<unsigned_int>	::=	<unsigned_short_int>
			<unsigned_long_int>
			<unsigned_longlong_int>
(60)	<unsigned_short_int>	::=	“unsigned” “short”
(61)	<unsigned_long_int>	::=	“unsigned” “long”
(62)	<unsigned_longlong_int>	::=	“unsigned” “long” “long”
(63)	<char_type>	::=	“char”
(64)	<wide_char_type>	::=	“wchar”
(65)	<boolean_type>	::=	“boolean”
(66)	<octet_type>	::=	“octet”
(67)	<any_type>	::=	“any”
(68)	<object_type>	::=	“Object”
(69)	<struct_type>	::=	“struct” <identifier> “{” <member_list> “}”
(70)	<member_list>	::=	<member>+
(71)	<member>	::=	<type_spec> <declarators> “;”
(72)	<union_type>	::=	“union” <identifier> “switch” “(” <switch_type_spec> “)” “{” <switch_body> “}”
(73)	<switch_type_spec>	::=	<integer_type>
			<char_type>
			<boolean_type>
			<enum_type>
			<scoped_name>
(74)	<switch_body>	::=	<case>+

(75)	<code><case></code>	::= <code><case_label>+ <element_spec> “;”</code>
(76)	<code><case_label></code>	::= <code>“case” <const_exp> “.”</code> <code>“default” “.”</code>
(77)	<code><element_spec></code>	::= <code><type_spec> <declarator></code>
(78)	<code><enum_type></code>	::= <code>“enum” <identifier></code> <code>“{” <enumerator> { “,” <enumerator> }* “}”</code>
(79)	<code><enumerator></code>	::= <code><identifier></code>
(80)	<code><sequence_type></code>	::= <code>“sequence” “<” <simple_type_spec> “,”</code> <code><positive_int_const> “>”</code> <code>“sequence” “<” <simple_type_spec> “>”</code>
(81)	<code><string_type></code>	::= <code>“string” “<” <positive_int_const> “>”</code> <code>“string”</code>
(82)	<code><wide_string_type></code>	::= <code>“wstring” “<” <positive_int_const> “>”</code> <code>“wstring”</code>
(83)	<code><array_declarator></code>	::= <code><identifier> <fixed_array_size>+</code>
(84)	<code><fixed_array_size></code>	::= <code>“[” <positive_int_const> “]”</code>
(85)	<code><attr_dcl></code>	::= <code><readonly_attr_spec></code> <code><attr_spec></code>
(86)	<code><except_dcl></code>	::= <code>“exception” <identifier> “{“ <member>* “”</code>
(87)	<code><op_dcl></code>	::= <code>[<op_attribute>] <op_type_spec></code> <code><identifier> <parameter_dcls></code> <code>[<raises_expr>] [<context_expr>]</code>
(88)	<code><op_attribute></code>	::= <code>“oneway”</code>
(89)	<code><op_type_spec></code>	::= <code><param_type_spec></code> <code>“void”</code>
(90)	<code><parameter_dcls></code>	::= <code>“(” <param_dcl> { “,” <param_dcl> }* “)”</code> <code>“(” “)”</code>
(91)	<code><param_dcl></code>	::= <code><param_attribute> <param_type_spec></code> <code><simple_declarator></code>
(92)	<code><param_attribute></code>	::= <code>“in”</code> <code>“out”</code> <code>“inout”</code>
(93)	<code><raises_expr></code>	::= <code>“raises” “(” <scoped_name></code> <code>{ “,” <scoped_name> }* “)”</code>
(94)	<code><context_expr></code>	::= <code>“context” “(” <string_literal></code> <code>{ “,” <string_literal> }* “)”</code>
(95)	<code><param_type_spec></code>	::= <code><base_type_spec></code> <code><string_type></code> <code><wide_string_type></code> <code><scoped_name></code>
(96)	<code><fixed_pt_type></code>	::= <code>“fixed” “<” <positive_int_const> “,”</code> <code><positive_int_const> “>”</code>
(97)	<code><fixed_pt_const_type></code>	::= <code>“fixed”</code>
(98)	<code><value_base_type></code>	::= <code>“ValueBase”</code>
(99)	<code><constr_forward_decl></code>	::= <code>“struct” <identifier></code> <code>“union” <identifier></code>

- (100) `<import>` ::= "import" `<imported_scope>` ";"
- (101) `<imported_scope>` ::= `<scoped_name>` | `<string_literal>`
- (102) `<type_id_dcl>` ::= "typeid" `<scoped_name>` `<string_literal>`
- (103) `<type_prefix_dcl>` ::= "typeprefix" `<scoped_name>` `<string_literal>`
- (104) `<readonly_attr_spec>` ::= "readonly" "attribute" `<param_type_spec>`
`<readonly_attr_declarator>`
- (105) `<readonly_attr_declarator >` ::= `<simple_declarator>` `<raises_expr>`
| `<simple_declarator>`
{ "," `<simple_declarator>` }*
- (106) `<attr_spec>` ::= "attribute" `<param_type_spec>`
`<attr_declarator>`
- (107) `<attr_declarator>` ::= `<simple_declarator>` `<attr_raises_expr>`
| `<simple_declarator>`
{ "," `<simple_declarator>` }*
- (108) `<attr_raises_expr>` ::= `<get_except_expr>` [`<set_except_expr>`]
| `<set_except_expr>`
- (109) `<get_except_expr>` ::= "getraises" `<exception_list>`
- (110) `<set_except_expr>` ::= "setraises" `<exception_list>`
- (111) `<exception_list>` ::= "(" `<scoped_name>`
{ "," `<scoped_name>` } * ")"

Note – Grammar rules 1 through 111 with the exception of the last three lines of rule 2 constitutes the portion of IDL that is not related to components.

- (112) `<component>` ::= `<component_dcl>`
| `<component_forward_dcl>`
- (113) `<component_forward_dcl>` ::= "component" `<identifier>`
- (114) `<component_dcl>` ::= `<component_header>`
"{" `<component_body>` "}"
- (115) `<component_header>` ::= "component" `<identifier>`
[`<component_inheritance_spec>`]
[`<supported_interface_spec>`]
- (116) `<supported_interface_spec>` ::= "supports" `<scoped_name>`
{ "," `<scoped_name>` }*
- (117) `<component_inheritance_spec>` ::= ":" `<scoped_name>`
- (118) `<component_body>` ::= `<component_export>`*
- (119) `<component_export>` ::= `<provides_dcl>` ","
| `<uses_dcl>` ","
| `<emits_dcl>` ","
| `<publishes_dcl>` ","
| `<consumes_dcl>` ","
| `<attr_dcl>` ","
- (120) `<provides_dcl>` ::= "provides" `<interface_type>` `<identifier>`
- (121) `<interface_type>` ::= `<scoped_name>`
| "Object"
- (122) `<uses_dcl>` ::= "uses" ["multiple"]
`<interface_type>` `<identifier>`

(123)	<emits_dcl>	::= "emits" <scoped_name> <identifier>
(124)	<publishes_dcl>	::= "publishes" <scoped_name> <identifier>
(125)	<consumes_dcl>	::= "consumes" <scoped_name> <identifier>
(126)	<home_dcl>	::= <home_header> <home_body>
(127)	<home_header>	::= "home" <identifier> [<home_inheritance_spec>] [<supported_interface_spec>] "manages" <scoped_name> [<primary_key_spec>]
(128)	<home_inheritance_spec>	::= ":" <scoped_name>
(129)	<primary_key_spec>	::= "primarykey" <scoped_name>
(130)	<home_body>	::= "{" <home_export>* "}"
(131)	<home_export	::= <export> <factory_dcl> "," <finder_dcl> ","
(132)	<factory_dcl>	::= "factory" <identifier> "(" [<init_param_decls>] ")" [<raises_expr>]
(133)	<finder_dcl>	::= "finder" <identifier> "(" [<init_param_decls>] ")" [<raises_expr>]
(134)	<event>	::= (<event_dcl> <event_abs_dcl> <event_forward_dcl>)
(135)	<event_forward_dcl>	::= ["abstract"] "eventtype" <identifier>
(136)	<event_abs_dcl>	::= "abstract" "eventtype" <identifier> [<value_inheritance_spec>] "{" <export>* "}"
(137)	<event_dcl>	::= <event_header> "{" <value_element> * "}"
(138)	<event_header>	::= ["custom"] "eventtype" <identifier> [<value_inheritance_spec>]

3.5 OMG IDL Specification

An OMG IDL specification consists of one or more type definitions, constant definitions, exception definitions, or module definitions. The syntax is:

(1)	<specification>	::= <import>* <definition> ⁺
(2)	<definition>	::= <type_dcl> ";" <const_dcl> ";" <except_dcl> ";" <interface> ";" <module> ";" <value> ";" <type_id_dcl> ";" <type_prefix_dcl> ";" <event> ";" <component> ";" <home_dcl> ";"

See Section 3.6, “Import Declaration,” on page 3-19, for the specification of `<import>`.

See Section 3.7, “Module Declaration,” on page 3-20, for the specification of `<module>`.

See Section 3.8, “Interface Declaration,” on page 3-20, for the specification of `<interface>`.

See Section 3.9, “Value Declaration,” on page 3-27, for the specification of `<value>`.

See Section 3.10, “Constant Declaration,” on page 3-32, Section 3.11, “Type Declaration,” on page 3-36, and Section 3.12, “Exception Declaration,” on page 3-49 respectively for specifications of `<const_dcl>`, `<type_dcl>`, and `<except_dcl>`.

See Section 3.15, “Repository Identity Related Declarations,” on page 3-55, for specification of Repository Identity declarations which include `<type_id_dcl>` and `<type_prefix_dcl>`.

See Section 3.16, “Event Declaration,” on page 3-57, for specification of `<event>`.

See Section 3.17, “Component Declaration,” on page 3-58, for specification of `<component>`.

See Section 3.18, “Home Declaration,” on page 3-63, for specification of `<home_dcl>`.

3.6 Import Declaration

The grammar for the import statement is described by the following BNF:

- (100) `<import>` ::= “import” `<imported_scope>` “;”
 (101) `<imported_scope>` ::= `<scoped_name>` | `<string_literal>`

The `<imported_scope>` non-terminal may be either a fully-qualified scoped name denoting an IDL name scope, or a string containing the interface repository ID of an IDL name scope, i.e., a definition object in the repository whose interface derives from **CORBA::Container**.

The definition of import obviates the need to define the meaning of IDL constructs in terms of “file scopes”. This specification defines the concepts of a *specification* as a unit of IDL expression. In the abstract, a *specification* consists of a finite sequence of ISO Latin-1 characters that form a legal IDL sentence. The physical representation of the specification is of no consequence to the definition of IDL, though it is generally associated with a file in practice.

Any scoped name that begins with the scope token (“::”) is resolved relative to the global scope of the specification in which it is defined. In isolation, the scope token represents the scope of the specification in which it occurs.

A specification that imports name scopes must be interpreted in the context of a well-defined set of IDL specifications whose union constitutes the space from within which name scopes are imported. By “a well-defined set of IDL specifications,” we mean any identifiable representation of IDL specifications, such as an interface repository. The specific representation from which name scopes are imported is not specified, nor is

the means by which importing is implemented, nor is the means by which a particular set of IDL specifications (such as an interface repository) is associated with the context in which the importing specification is to be interpreted.

The effects of an import statement are as follows:

- The contents of the specified name scope are visible in the context of the importing specification. Names that occur in IDL declarations within the importing specification may be resolved to definitions in imported scopes.
- Imported IDL name scopes exist in the same space as names defined in subsequent declarations in the importing specification.
- IDL module definitions may re-open modules defined in imported name scopes.
- Importing an inner name scope (i.e., a name scope nested within one or more enclosing name scopes) does not implicitly import the contents of any of the enclosing name scopes.
- When a name scope is imported, the names of the enclosing scopes in the fully-qualified pathname of the enclosing scope are *exposed* within the context of the importing specification, but their contents are not imported. An importing specification may not re-define or re-open a name scope which has been exposed (but not imported) by an import statement.
- Importing a name scope recursively imports all name scopes nested within it.
- For the purposes of this specification, name scopes that can be imported (i.e., specified in an import statement) include the following: **modules**, **interfaces**, **valuetypes**, and **eventtypes**.
- Redundant imports (e.g., importing an inner scope and one of its enclosing scopes in the same specification) are disregarded. The union of all imported scopes is visible to the importing program.
- This specification does not define a particular form for generated stubs and skeletons in any given programming language. In particular, it does not imply any normative relationship between units specification and units of generation and/or compilation for any language mapping.

3.7 Module Declaration

A module definition satisfies the following syntax:

(3) `<module> ::= "module" <identifier> "{" <definition>+ "}"`

The module construct is used to scope OMG IDL identifiers; see Section 3.19, "CORBA Module," on page 3-66 for details.

3.8 Interface Declaration

An interface definition satisfies the following syntax:

(4) `<interface> ::= <interface_dcl>
| <forward_dcl>`

```

(5)      <interface_dcl> ::= <interface_header> "{" <interface_body> "}"
(6)      <forward_dcl> ::= [ "abstract" | "local" ] "interface" <identifier>
(7)      <interface_header> ::= [ "abstract" | "local" ] "interface" <identifier>
        [ <interface_inheritance_spec> ]
(8)      <interface_body> ::= <export>*
(9)      <export> ::= <type_dcl> ":",
        | <const_dcl> ":",
        | <except_dcl> ":",
        | <attr_dcl> ":",
        | <op_dcl> ":",
        | <type_id_decl> ":",
        | <type_prefix_decl> ":",

```

3.8.1 Interface Header

The interface header consists of three elements:

1. An optional modifier specifying if the interface is an abstract interface.
2. The interface name. The name must be preceded by the keyword **interface**, and consists of an identifier that names the interface.
3. An optional inheritance specification. The inheritance specification is described in the next section.

The **<identifier>** that names an interface defines a legal type name. Such a type name may be used anywhere an **<identifier>** is legal in the grammar, subject to semantic constraints as described in the following sections. Since one can only hold references to an object, the meaning of a parameter or structure member, which is an interface type is as a *reference* to an object supporting that interface. Each language binding describes how the programmer must represent such interface references.

Abstract interfaces have slightly different rules and semantics from "regular" interfaces, as described in Section 3.8.6, "Abstract Interface," on page 3-26. They also follow different language mapping rules.

Local interfaces have slightly different rules and semantics from "regular" interfaces, as described in Section 3.8.7, "Local Interface," on page 3-26. They also follow different language mapping rules.

3.8.2 Interface Inheritance Specification

The syntax for inheritance is as follows:

```

(10) <interface_inheritance_spec> ::= ":" <interface_name>
        { ":", <interface_name> }*
(11) <interface_name> ::= <scoped_name>
(12) <scoped_name> ::= <identifier>
        | ":" <identifier>
        | <scoped_name> ":" <identifier>

```

Each **<scoped_name>** in an **<interface_inheritance_spec>** must denote a previously defined interface. See Section 3.8.5, “Interface Inheritance,” on page 3-23 for the description of inheritance.

3.8.3 Interface Body

The interface body contains the following kinds of declarations:

- Constant declarations, which specify the constants that the interface exports; constant declaration syntax is described in Section 3.10, “Constant Declaration,” on page 3-32.
- Type declarations, which specify the type definitions that the interface exports; type declaration syntax is described in Section 3.11, “Type Declaration,” on page 3-36.
- Exception declarations, which specify the exception structures that the interface exports; exception declaration syntax is described in Section 3.12, “Exception Declaration,” on page 3-49.
- Attribute declarations, which specify the associated attributes exported by the interface; attribute declaration syntax is described in Section 3.14, “Attribute Declaration,” on page 3-53.
- Operation declarations, which specify the operations that the interface exports and the format of each, including operation name, the type of data returned, the types of all parameters of an operation, legal exceptions that may be returned as a result of an invocation, and contextual information that may affect method dispatch; operation declaration syntax is described in Section 3.13, “Operation Declaration,” on page 3-50.

Empty interfaces are permitted (that is, those containing no declarations).

Some implementations may require interface-specific pragmas to precede the interface body.

3.8.4 Forward Declaration

A forward declaration declares the name of an interface without defining it. This permits the definition of interfaces that refer to each other. The syntax is: optionally either the keyword **abstract** or the keyword **local**, followed by the keyword **interface**, followed by an **<identifier>** that names the interface.

Multiple forward declarations of the same interface name are legal.

It is illegal to inherit from a forward-declared interface whose definition has not yet been seen:

```
module Example {  
    interface base;           // Forward declaration  
  
    // ...
```

```

    interface derived : base {}; // Error
    interface base {}; // Define base
    interface derived : base {}; // OK
};

```

3.8.5 Interface Inheritance

An interface can be derived from another interface, which is then called a *base* interface of the derived interface. A derived interface, like all interfaces, may declare new elements (constants, types, attributes, exceptions, and operations). In addition, unless redefined in the derived interface, the elements of a base interface can be referred to as if they were elements of the derived interface. The name resolution operator (“::”) may be used to refer to a base element explicitly; this permits reference to a name that has been redefined in the derived interface.

A derived interface may redefine any of the type, constant, and exception names that have been inherited; the scope rules for such names are described in Section 3.20, “Names and Scoping,” on page 3-67.

An interface is called a direct base if it is mentioned in the **<interface_inheritance_spec>** and an indirect base if it is not a direct base but is a base interface of one of the interfaces mentioned in the **<interface_inheritance_spec>**.

An interface may be derived from any number of base interfaces. Such use of more than one direct base interface is often called multiple inheritance. The order of derivation is not significant.

An abstract interface may only inherit from other abstract interfaces.

An interface may not be specified as a direct base interface of a derived interface more than once; it may be an indirect base interface more than once. Consider the following example:

```

interface A { ... }
interface B: A { ... }
interface C: A { ... }
interface D: B, C { ... }
interface E: A, B { ... }; // OK

```

The relationships between these interfaces is shown in Figure 3-1. This “diamond” shape is legal, as is the definition of E on the right.

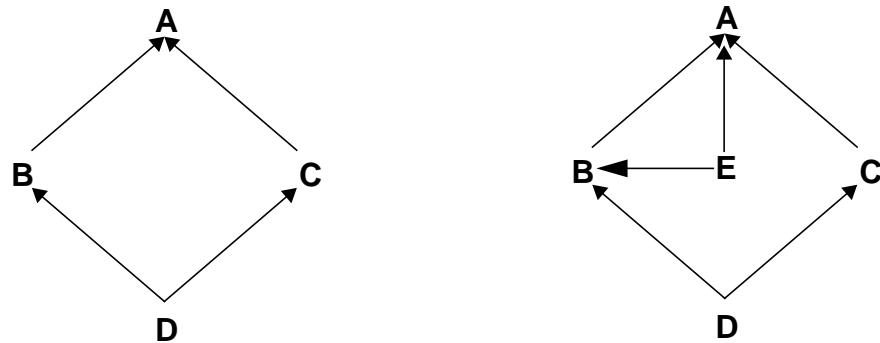

Figure 3-1 Legal Multiple Inheritance Example

References to base interface elements must be unambiguous. A Reference to a base interface element is ambiguous if the name is declared as a constant, type, or exception in more than one base interface. Ambiguities can be resolved by qualifying a name with its interface name (that is, using a **<scoped_name>**). It is illegal to inherit from two interfaces with the same operation or attribute name, or to redefine an operation or attribute name in the derived interface.

So for example in:

```
interface A {
    typedef long L1;
    short opA(in L1 I_1);
};

interface B {
    typedef short L1;
    L1 opB(in long I);
};

interface C: B, A {
    typedef L1 L2;           // Error: L1 ambiguous
    typedef A::L1 L3;       // A::L1 is OK
    B::L1 opC(in L3 I_3);   // all OK no ambiguities
};
```

References to constants, types, and exceptions are bound to an interface when it is defined (i.e., replaced with the equivalent global **<scoped_name>**s). This guarantees that the syntax and semantics of an interface are not changed when the interface is a base interface for a derived interface. Consider the following example:

```
const long L = 3;
```

```
interface A {
```



```

    typedef float coord[L];
    void f (in coord s);           // s has three floats
};

interface B {
    const long L = 4;
};

interface C: B, A { };           // what is C::f()'s signature?

```

The early binding of constants, types, and exceptions at interface definition guarantees that the signature of operation `f` in interface `C` is

```

typedef float coord[3];
void f (in coord s);

```

which is identical to that in interface `A`. This rule also prevents redefinition of a constant, type, or exception in the derived interface from affecting the operations and attributes inherited from a base interface.

Interface inheritance causes all identifiers defined in base interfaces, both direct and indirect, to be visible in the current naming scope. A type name, constant name, enumeration value name, or exception name from an enclosing scope can be redefined in the current scope. An attempt to use an ambiguous name without qualification produces a compilation error. Thus in

```

interface A {
    typedef string<128> string_t;
};

interface B {
    typedef string<256> string_t;
};

interface C: A, B {
    attribute string_t    Title;           // Error: string_t ambiguous
    attribute A::string_t Name;           // OK
    attribute B::string_t City;           // OK
};

```

Operation and attribute names are used at run-time by both the stub and dynamic interfaces. As a result, all operations attributes that might apply to a particular object must have unique names. This requirement prohibits redefining an operation or attribute name in a derived interface, as well as inheriting two operations or attributes with the same name.

```

interface A {
    void make_it_so();
};

interface B: A {

```

```
    short make_it_so(in long times); // Error: redefinition of make_it_so
};
```

For a complete summary of allowable inheritance and supporting relationships among interfaces and valuetypes see Table 3-10 on page 3-32.

3.8.6 *Abstract Interface*

An interface declaration containing the keyword **abstract** in its header, declares an abstract interface. The following special rules apply to abstract interfaces:

- Abstract interfaces may only inherit from other abstract interfaces.
- Value types may support any number of abstract interfaces.

See Section 6.2, “Semantics of Abstract Interfaces,” on page 6-1 for CORBA implementation semantics associated with abstract interfaces.

For a complete summary of allowable inheritance and supporting relationships among interfaces and valuetypes see Table 3-10 on page 3-32.

3.8.7 *Local Interface*

An interface declaration containing the keyword **local** in its header, declares a local interface. An interface declaration not containing the keyword **local** is referred to as an unconstrained interface. An object implementing a local interfaces is referred to as a local object. The following special rules apply to local interfaces:

- A local interface may inherit from other local or unconstrained interfaces.
- An unconstrained interface may not inherit from a local interface. An interface derived from a local interface must be explicitly declared local.
- A valuetype may support a local interface.
- Any IDL type, including an unconstrained interface, may appear as a parameter, attribute, return type, or exception declaration of a local interface.
- A local interface is a local type, as is any non-interface type declaration constructed using a local interface or other local type. For example, a struct, union, or exception with a member that is a local interface is also itself a local type.
- A local type may be used as a parameter, attribute, return type, or exception declaration of a local interface or of a valuetype.
- A local type may not appear as a parameter, attribute, return type, or exception declaration of an unconstrained interface or as a state member of a valuetype.

For a complete summary of allowable inheritance and supporting relationships among interfaces and valuetypes see Table 3-10 on page 3-32.

See Section 4.3.13, “LocalObject Operations,” on page 4-22 for CORBA implementation semantics associated with local objects.

3.9 Value Declaration

There are several kinds of value type declarations: “regular” value types, boxed value types, abstract value types, and forward declarations.

A value declaration satisfies the following syntax:

```
(13) <value> ::= ( <value_dcl> | <value_abs_dcl> |
                <value_box_dcl> | <value_forward_dcl> )
```

3.9.1 Regular Value Type

A regular value type satisfies the following syntax:

```
(17) <value_dcl> ::= <value_header> “{“ <value_element>* “}”
(18) <value_header> ::= [“custom” ] “valuetype” <identifier>
                        [ <value_inheritance_spec> ]
(21) <value_element> ::= <export>
                        | <state_member> |
                        | <init_dcl>
```

3.9.1.1 Value Header

The value header consists of two elements:

1. The value type’s name and optional modifier specifying whether the value type uses custom marshaling.
2. An optional value inheritance specification. The value inheritance specification is described in the next section.

3.9.1.2 Value Element

A value can contain all the elements that an interface can as well as the definition of state members, and initializers for that state.

3.9.1.3 Value Inheritance Specification

```
(19) <value_inheritance_spec> ::= [ “:” [ “truncatable” ] <value_name>
                                   { “,” <value_name>* } ]
                                   [ “supports” <interface_name>
                                   { “,” <interface_name>* } ]
(20) <value_name> ::= <scoped_name>
```

Each **<value_name>** and **<interface_name>** in a **<value_inheritance_spec>** must denote previously defined value type or interface. See Section 3.9.5, “Valuetype Inheritance,” on page 3-30 for the description of value type inheritance.

The **truncatable** modifier may not be used if the value type being defined is a custom value.

A valuetype that supports a local interface does not itself become *local* (i.e. unmarshalable) as a result of that support.

3.9.1.4 State Members

(22) `<state_member> ::= ("public" | "private")
<type_spec> <declarators> ";"`

Each `<state_member>` defines an element of the state, which is marshaled and sent to the receiver when the value type is passed as a parameter. A state member is either public or private. The annotation directs the language mapping to hide or expose the different parts of the state to the clients of the value type. The private part of the state is only accessible to the implementation code and the marshaling routines.

A valuetype that has a state member that is *local* (i.e. non-marshalable like a local interface), is itself rendered *local*. That is, such valuetypes behave similar to local interfaces when an attempt is made to marshal them.

Note that certain programming languages may not have the built in facilities needed to distinguish between the public and private members. In these cases, the language mapping specifies the rules that programmers are responsible for following.

3.9.1.5 Initializers

(23) `<init_dcl> ::= "factory" <identifier>
"(" [<init_param_decls>] ")"
[<raises_expr>] ";"`

(24) `<init_param_decls> ::= <init_param_decl> { "," <init_param_decl> }*`

(25) `<init_param_decl> ::= <init_param_attribute> <param_type_spec>
<simple_declarator>`

(26) `<init_param_attribute> ::= "in"`

In order to ensure portability of value implementations, designers may also define the signatures of initializers (or constructors) for non abstract value types. Syntactically these look like local operation signatures except that they are prefixed with the keyword **factory**, have no return type, and must use only in parameters. There may be any number of factory declarations. The names of the initializers are part of the name scope of the value type. Initializers defined in a valuetype are not inherited by derived valuetypes, and hence the names of the initializers are free to be reused in a derived valuetype.

If no initializers are specified in IDL, the value type does not provide a portable way of creating a runtime instance of its type. There is no default initializer. This allows the definition of IDL value types, which are not intended to be directly instantiated by client code.

3.9.1.6 Value Type Example

```
interface Tree {
    void print()
```

```

};

valuetype WeightedBinaryTree {
    // state definition
    private unsigned long weight;
    private WeightedBinaryTree left;
    private WeightedBinaryTree right;
    // initializer
    factory init(in unsigned long w);
    // local operations
    WeightSeq pre_order();
    WeightSeq post_order();
};

valuetype WTree: WeightedBinaryTree supports Tree {};

```

3.9.2 Boxed Value Type

(15) `<value_box_dcl> ::= "valuetype" <identifier> <type_spec>`

It is often convenient to define a value type with no inheritance or operations and with a single state member. A shorthand IDL notation is used to simplify the use of value types for this kind of simple containment, referred to as a “value box.”

Since a value box of a valuetype adds no additional properties to a valuetype, it is an error to box valuetypes.

Value box is particularly useful for strings and sequences. Basically one does not have to create what is in effect an additional namespace that will contain only one name.

An example is the following IDL:

```

module Example {
    interface Foo {
        ... /* anything */
    };
    valuetype FooSeq sequence<Foo>;
    interface Bar {
        void dolt (in FooSeq seq1);
    };
};

```

The above IDL provides similar functionality to writing the following IDL. However the type identities (repository ID’s) would be different.

```

module Example {
    interface Foo {
        ... /* anything */
    };
    valuetype FooSeq {
        public sequence<Foo> data;
    };
    interface Bar {

```

```

        void dolt (in FooSeq seq);
    };
};

```

The former is easier to manipulate after it is mapped to a concrete programming language.

Any IDL type may be used to declare a value box except for a valuetype.

The declaration of a boxed value type does not open a new scope. Thus a construction such as:

```

valuetype FooSeq sequence <FooSeq>;

```

is not legal IDL. The identifier being declared as a boxed value type cannot be used subsequent to its initial use and prior to the completion of the boxed value declaration.

3.9.3 Abstract Value Type

```

(16)    <value_abs_dcl> ::= "abstract" "valuetype" <identifier>
        [ <value_inheritance_spec> ]
        "{ <export>* "}"

```

Value types may also be abstract. They are called abstract because an abstract value type may not be instantiated. No <state_member> or <initializers> may be specified. However, local operations may be specified. Essentially they are a bundle of operation signatures with a purely local implementation.

Note that a concrete value type with an empty state is not an abstract value type.

3.9.4 Value Forward Declaration

```

(14)    <value_forward_dcl> ::= [ "abstract" ] "valuetype" <identifier>

```

A forward declaration declares the name of a value type without defining it. This permits the definition of value types that refer to each other. The syntax consists simply of the keyword **valuetype** followed by an <identifier> that names the value type.

Multiple forward declarations of the same value type name are legal.

Boxed value types cannot be forward declared; such a forward declaration would refer to a normal value type.

It is illegal to inherit from a forward-declared value type whose definition has not yet been seen.

3.9.5 Valuetype Inheritance

The terminology that is used to describe value type inheritance is directly analogous to that used to describe interface inheritance (see Section 3.8.5, "Interface Inheritance," on page 3-23).

The name scoping and name collision rules for valuetypes are identical to those for interfaces. In addition, no valuetype may be specified as a direct abstract base of a derived valuetype more than once; it may be an indirect abstract base more than once. See Section 3.8.5, “Interface Inheritance,” on page 3-23 for a detailed description of the analogous properties for interfaces.

Values may be derived from other values and can support an interface and any number of abstract interfaces.

Once implementation (state) is specified at a particular point in the inheritance hierarchy, all derived value types (which must of course implement the state) may only derive from a single (concrete) value type. They can however derive from other additional abstract values and support an additional interface.

The single immediate base concrete value type, if present, must be the first element specified in the inheritance list of the value declaration’s IDL. It may be followed by other abstract values from which it inherits. The interface and abstract interfaces that it supports are listed following the **supports** keyword.

While a valuetype may only directly support one interface, it is possible for the valuetype to support other interfaces as well through inheritance. In this case, the supported interface must be derived, directly or indirectly, from each interface that the valuetype supports through inheritance. This rule does not apply to abstract interfaces that the valuetype supports. For example:

```
interface I1 { };
interface I2 { };
interface I3: I1, I2 { };

abstract valuetype V1 supports I1 { };
abstract valuetype V2 supports I2 { };
valuetype V3: V1, V2 supports I3 { }; // legal
valuetype V4: V1 supports I2 { }; // illegal
```

A stateful value that derives from another stateful value may specify that it is **truncatable**. This means that it is to “truncate” (see Section 5.2.5.3, “Value instance - > Value type,” on page 5-5) an instance to be an instance of any of its truncatable parent (stateful) value types under certain conditions. Note that all the intervening types in the inheritance hierarchy must be truncatable in order for truncation to a particular type to be allowed.

Because custom values require an exact type match between the sending and receiving context, **truncatable** may not be specified for a custom value type.

Non-custom value types may not (transitively) inherit from custom value types.

Boxed value types may not be derived from, nor may they derive from anything else.

These rules are summarized in the following table:

Table 3-10 Allowable Inheritance Relationships

May inherit from:	Interface	Abstract Interface	Abstract Value	Stateful Value	Boxed value
Interface	multiple	multiple	no	no	no
Abstract Interface	no	multiple	no	no	no
Abstract Value	supports single	supports multiple	multiple	no	no
Stateful Value	supports single	supports multiple	multiple	single (may be truncatable)	no
Boxed Value	no	no	no	no	no

3.10 Constant Declaration

This section describes the syntax for constant declarations.

3.10.1 Syntax

The syntax for a constant declaration is:

- ```
(27) <const_dcl> ::= "const" <const_type>
 <identifier> "=" <const_exp>
(28) <const_type> ::= <integer_type>
 | <char_type>
 | <wide_char_type>
 | <boolean_type>
 | <floating_pt_type>
 | <string_type>
 | <wide_string_type>
 | <fixed_pt_const_type>
 | <scoped_name>
 | <octet_type>
(29) <const_exp> ::= <or_expr>
(30) <or_expr> ::= <xor_expr>
 | <or_expr> "|" <xor_expr>
(31) <xor_expr> ::= <and_expr>
 | <xor_expr> "^" <and_expr>
(32) <and_expr> ::= <shift_expr>
 | <and_expr> "&" <shift_expr>
(33) <shift_expr> ::= <add_expr>
 | <shift_expr> ">>" <add_expr>
 | <shift_expr> "<<" <add_expr>
(34) <add_expr> ::= <mult_expr>
 | <add_expr> "+" <mult_expr>
 | <add_expr> "-" <mult_expr>
```



- (35)            <mult\_expr> ::= <unary\_expr>  
                  | <mult\_expr> "\*" <unary\_expr>  
                  | <mult\_expr> "/" <unary\_expr>  
                  | <mult\_expr> "%" <unary\_expr>
- (36)            <unary\_expr> ::= <unary\_operator> <primary\_expr>  
                  | <primary\_expr>
- (37)            <unary\_operator> ::= "-"  
                  | "+"  
                  | "~"
- (38)            <primary\_expr> ::= <scoped\_name>  
                  | <literal>  
                  | "(" <const\_exp> ")"
- (39)            <literal> ::= <integer\_literal>  
                  | <string\_literal>  
                  | <wide\_string\_literal>  
                  | <character\_literal>  
                  | <wide\_character\_literal>  
                  | <fixed\_pt\_literal>  
                  | <floating\_pt\_literal>  
                  | <boolean\_literal>
- (40)            <boolean\_literal> ::= "TRUE"  
                  | "FALSE"
- (41)            <positive\_int\_const> ::= <const\_exp>

### 3.10.2 Semantics

The <scoped\_name> in the <const\_type> production must be a previously defined name of an <integer\_type>, <char\_type>, <wide\_char\_type>, <boolean\_type>, <floating\_pt\_type>, <string\_type>, <wide\_string\_type>, <octet\_type>, or <enum\_type> constant.

Integer literals have positive integer values. Only integer values can be assigned to integer type (**short**, **long**, **long long**) constants. Only positive integer values can be assigned to unsigned integer type constants. If the value of the right hand side of an integer constant declaration is too large to fit in the actual type of the constant on the left hand side, for example

```
const short s = 655592;
```

or is inappropriate for the actual type of the left hand side, for example

```
const octet o = -54;
```

it shall be flagged as a compile time error.

Floating point literals have floating point values. Only floating point values can be assigned to floating point type (**float**, **double**, **long double**) constants. If the value of the right hand side is too large to fit in the actual type of the constant to which it is being assigned it shall be flagged as a compile time error.

Fixed point literals have fixed point values. Only fixed point values can be assigned to fixed point type constants. If the fixed point value in the expression on the right hand side is too large to fit in the actual fixed point type of the constant on the left hand side, then it shall be flagged as a compile time error.

An infix operator can combine two integers, floats or fixeds, but not mixtures of these. Infix operators are applicable only to integer, float and fixed types.

If the type of an integer constant is **long** or **unsigned long**, then each subexpression of the associated constant expression is treated as an **unsigned long** by default, or a signed **long** for negated literals or negative integer constants. It is an error if any subexpression values exceed the precision of the assigned type (**long** or **unsigned long**), or if a final expression value (of type **unsigned long**) exceeds the precision of the target type (**long**).

If the type of an integer constant is **long long** or **unsigned long long**, then each subexpression of the associated constant expression is treated as an **unsigned long long** by default, or a signed **long long** for negated literals or negative integer constants. It is an error if any subexpression values exceed the precision of the assigned type (**long long** or **unsigned long long**), or if a final expression value (of type **unsigned long long**) exceeds the precision of the target type (**long long**).

If the type of a floating-point constant is **double**, then each subexpression of the associated constant expression is treated as a **double**. It is an error if any subexpression value exceeds the precision of **double**.

If the type of a floating-point constant is **long double**, then each subexpression of the associated constant expression is treated as a **long double**. It is an error if any subexpression value exceeds the precision of **long double**.

Fixed-point decimal constant expressions are evaluated as follows. A fixed-point literal has the apparent number of total and fractional digits. For example, **0123.450d** is considered to be **fixed<7,3>** and **3000.00d** is **fixed<6,2>**. Prefix operators do not affect the precision; a prefix **+** is optional, and does not change the result. The upper bounds on the number of digits and scale of the result of an infix expression, **fixed<d1,s1> op fixed<d2,s2>**, are shown in the following table:

| Op | Result: <b>fixed&lt;d,s&gt;</b>                                   |
|----|-------------------------------------------------------------------|
| +  | <b>fixed&lt;max(d1-s1,d2-s2) + max(s1,s2) + 1, max(s1,s2)&gt;</b> |
| -  | <b>fixed&lt;max(d1-s1,d2-s2) + max(s1,s2) + 1, max(s1,s2)&gt;</b> |
| *  | <b>fixed&lt;d1+d2, s1+s2&gt;</b>                                  |
| /  | <b>fixed&lt;(d1-s1+s2) + sinf, sinf&gt;</b>                       |

A quotient may have an arbitrary number of decimal places, denoted by a scale of  $s_{inf}$ . The computation proceeds pairwise, with the usual rules for left-to-right association, operator precedence, and parentheses. All intermediate computations shall be performed using double precision (i.e., 62 digit) arithmetic. If an individual computation between a pair of fixed-point literals actually generates more than 31 significant digits, then a 31-digit result is retained as follows:

**fixed<d,s> => fixed<31, 31-d+s>**

Leading and trailing zeros are not considered significant. The omitted digits are discarded; rounding is not performed. The result of the individual computation then proceeds as one literal operand of the next pair of fixed-point literals to be computed.

Unary (+ -) and binary (\* / + -) operators are applicable in floating-point and fixed-point expressions. Unary (+ - ~) and binary (\* / % + - << >> & | ^) operators are applicable in integer expressions.

The “~” unary operator indicates that the bit-complement of the expression to which it is applied should be generated. For the purposes of such expressions, the values are 2’s complement numbers. As such, the complement can be generated as follows:

| Integer Constant Expression Type | Generated 2’s Complement Numbers |
|----------------------------------|----------------------------------|
| <b>long</b>                      | long -(value+1)                  |
| <b>unsigned long</b>             | unsigned long (2**32-1) - value  |
| <b>long long</b>                 | long long -(value+1)             |
| <b>unsigned long long</b>        | unsigned long (2**64-1) - value  |

The “%” binary operator yields the remainder from the division of the first expression by the second. If the second operand of “%” is 0, the result is undefined; otherwise

$$(a/b)*b + a\%b$$

is equal to a. If both operands are nonnegative, then the remainder is nonnegative; if not, the sign of the remainder is implementation dependent.

The “<<” binary operator indicates that the value of the left operand should be shifted left the number of bits specified by the right operand, with 0 fill for the vacated bits. The right operand must be in the range  $0 \leq \text{right operand} < 64$ .

The “>>” binary operator indicates that the value of the left operand should be shifted right the number of bits specified by the right operand, with 0 fill for the vacated bits. The right operand must be in the range  $0 \leq \text{right operand} < 64$ .

The “&” binary operator indicates that the logical, bitwise AND of the left and right operands should be generated.

The “|” binary operator indicates that the logical, bitwise OR of the left and right operands should be generated.

The “^” binary operator indicates that the logical, bitwise EXCLUSIVE-OR of the left and right operands should be generated.

**<positive\_int\_const>** must evaluate to a positive integer constant.

An octet constant can be defined using an integer literal or an integer constant expression, for example:

**const octet O1 = 0x1;**

```

const long L = 3;
const octet O2 = 5 + L;

```

Values for an octet constant outside the range 0 - 255 shall cause a compile-time error.

An enum constant can only be defined using a scoped name for the enumerator. The scoped name is resolved using the normal scope resolution rules Section 3.20, “Names and Scoping,” on page 3-67. For example:

```

enum Color { red, green, blue };
const Color FAVORITE_COLOR = red;

```

```

module M {
 enum Size { small, medium, large };
};
const M::Size MYSIZE = M::medium;

```

The constant name for the RHS of an enumerated constant definition must denote one of the enumerators defined for the enumerated type of the constant. For example:

```

const Color col = red; // is OK but
const Color another = M::medium; // is an error

```

### 3.11 Type Declaration

OMG IDL provides constructs for naming data types; that is, it provides C language-like declarations that associate an identifier with a type. OMG IDL uses the **typedef** keyword to associate a name with a data type; a name is also associated with a data type via the **struct**, **union**, **enum**, and **native** declarations; the syntax is:

- ```

(42)      <type_dcl> ::= “typedef” <type_declarator>
           | <struct_type>
           | <union_type>
           | <enum_type>
           | “native” <simple_declarator>
           | <constr_forward_decl>
(43)      <type_declarator> ::= <type_spec> <declarators>

```

For type declarations, OMG IDL defines a set of type specifiers to represent typed values. The syntax is as follows:

- ```

(44) <type_spec> ::= <simple_type_spec>
 | <constr_type_spec>
(45) <simple_type_spec> ::= <base_type_spec>
 | <template_type_spec>
 | <scoped_name>
(46) <base_type_spec> ::= <floating_pt_type>
 | <integer_type>
 | <char_type>
 | <wide_char_type>

```

|      |                      |     |                                    |
|------|----------------------|-----|------------------------------------|
|      |                      |     | <boolean_type>                     |
|      |                      |     | <octet_type>                       |
|      |                      |     | <any_type>                         |
|      |                      |     | <object_type>                      |
|      |                      |     | <value_base_type>                  |
| (47) | <template_type_spec> | ::= | <sequence_type>                    |
|      |                      |     | <string_type>                      |
|      |                      |     | <wide_string_type>                 |
|      |                      |     | <fixed_pt_type>                    |
| (48) | <constr_type_spec>   | ::= | <struct_type>                      |
|      |                      |     | <union_type>                       |
|      |                      |     | <enum_type>                        |
| (49) | <declarators>        | ::= | <declarator> { “,” <declarator> }* |
| (50) | <declarator>         | ::= | <simple_declarator>                |
|      |                      |     | <complex_declarator>               |
| (51) | <simple_declarator>  | ::= | <identifier>                       |
| (52) | <complex_declarator> | ::= | <array_declarator>                 |

The <scoped\_name> in <simple\_type\_spec> must be a previously defined type introduced by an interface declaration (<interface\_dcl> - see Section 3.8, “Interface Declaration”), a value declaration (<value\_dcl>, <value\_box\_dcl> or <abstract\_value\_dcl> - see Section 3.9, “Value Declaration”) or a type declaration (<type\_dcl> - see Section 3.11, “Type Declaration”). Note that exceptions are not considered types in this context.

As seen above, OMG IDL type specifiers consist of scalar data types and type constructors. OMG IDL type specifiers can be used in operation declarations to assign data types to operation parameters. The next sections describe basic and constructed type specifiers.

### 3.11.1 Basic Types

The syntax for the supported basic types is as follows:

|      |                       |     |                         |
|------|-----------------------|-----|-------------------------|
| (53) | <floating_pt_type>    | ::= | “float”                 |
|      |                       |     | “double”                |
|      |                       |     | “long” “double”         |
| (54) | <integer_type>        | ::= | <signed_int>            |
|      |                       |     | <unsigned_int>          |
| (55) | <signed_int>          | ::= | <signed_short_int>      |
|      |                       |     | <signed_long_int>       |
|      |                       |     | <signed_longlong_int>   |
| (56) | <signed_short_int>    | ::= | “short”                 |
| (57) | <signed_long_int>     | ::= | “long”                  |
| (58) | <signed_longlong_int> | ::= | “long” “long”           |
| (59) | <unsigned_int>        | ::= | <unsigned_short_int>    |
|      |                       |     | <unsigned_long_int>     |
|      |                       |     | <unsigned_longlong_int> |
| (60) | <unsigned_short_int>  | ::= | “unsigned” “short”      |

- (61) `<unsigned_long_int>` ::= “unsigned” “long”  
 (62) `<unsigned_longlong_int>` ::= “unsigned” “long” “long”  
 (63) `<char_type>` ::= “char”  
 (64) `<wide_char_type>` ::= “wchar”  
 (65) `<boolean_type>` ::= “boolean”  
 (66) `<octet_type>` ::= “octet”  
 (67) `<any_type>` ::= “any”

Each OMG IDL data type is mapped to a native data type via the appropriate language mapping. Conversion errors between OMG IDL data types and the native types to which they are mapped can occur during the performance of an operation invocation. The invocation mechanism (client stub, dynamic invocation engine, and skeletons) may signal an exception condition to the client if an attempt is made to convert an illegal value. The standard system exceptions that are to be raised in such situations are defined in Section 4.12, “Exceptions,” on page 4-63.

### 3.11.1.1 Integer Types

OMG IDL integer types are **short**, **unsigned short**, **long**, **unsigned long**, **long long** and **unsigned long long**, representing integer values in the range indicated below in Table 3-11.

Table 3-11 Range of integer types

|                    |                         |
|--------------------|-------------------------|
| short              | $-2^{15} .. 2^{15} - 1$ |
| long               | $-2^{31} .. 2^{31} - 1$ |
| long long          | $-2^{63} .. 2^{63} - 1$ |
| unsigned short     | $0 .. 2^{16} - 1$       |
| unsigned long      | $0 .. 2^{32} - 1$       |
| unsigned long long | $0 .. 2^{64} - 1$       |

### 3.11.1.2 Floating-Point Types

OMG IDL floating-point types are **float**, **double** and **long double**. The **float** type represents IEEE single-precision floating point numbers; the **double** type represents IEEE double-precision floating point numbers. The **long double** data type represents an IEEE double-extended floating-point number, which has an exponent of at least 15 bits in length and a signed fraction of at least 64 bits. See *IEEE Standard for Binary Floating-Point Arithmetic*, ANSI/IEEE Standard 754-1985, for a detailed specification.

### 3.11.1.3 Char Type

OMG IDL defines a **char** data type that is an 8-bit quantity that (1) encodes a single-byte character from any byte-oriented code set, or (2) when used in an array, encodes a multi-byte character from a multi-byte code set. In other words, an implementation is free to use any code set internally for encoding character data, though conversion to another form may be required for transmission.

The ISO 8859-1 (Latin1) character set standard defines the meaning and representation of all possible graphic characters used in OMG IDL (i.e., the space, alphabetic, digit and graphic characters defined in Table 3-2 on page 3-3, Table 3-3 on page 3-4, and Table 3-4 on page 3-4). The meaning and representation of the null and formatting characters (see Table 3-5 on page 3-5) is the numerical value of the character as defined in the ASCII (ISO 646) standard. The meaning of all other characters is implementation-dependent.

During transmission, characters may be converted to other appropriate forms as required by a particular language binding. Such conversions may change the representation of a character but maintain the character's meaning. For example, a character may be converted to and from the appropriate representation in international character sets.

#### 3.11.1.4 *Wide Char Type*

OMG IDL defines a **wchar** data type that encodes wide characters from any character set. As with character data, an implementation is free to use any code set internally for encoding wide characters, though, again, conversion to another form may be required for transmission. The size of **wchar** is implementation-dependent.

#### 3.11.1.5 *Boolean Type*

The **boolean** data type is used to denote a data item that can only take one of the values **TRUE** and **FALSE**.

#### 3.11.1.6 *Octet Type*

The **octet** type is an 8-bit quantity that is guaranteed not to undergo any conversion when transmitted by the communication system.

#### 3.11.1.7 *Any Type*

The **any** type permits the specification of values that can express any OMG IDL type.

An **any** logically contains a **TypeCode** (see Section 4.11, "TypeCodes," on page 4-53) and a value that is described by the **TypeCode**. Each IDL language mapping provides operations that allow programmers to insert and access the **TypeCode** and value contained in an **any**.

### 3.11.2 *Constructed Types*

**Structs, unions** and **enums** are the constructed types. Their syntax is presented in this section:

```
(42) <type_dcl> ::= "typedef" <type_declarator>
 | <struct_type>
 | <union_type>
 | <enum_type>
```

|      |                       |                              |
|------|-----------------------|------------------------------|
|      |                       | "native" <simple_declarator> |
|      |                       | <constr_forward_decl>        |
| (48) | <constr_type_spec>    | ::= <struct_type>            |
|      |                       | <union_type>                 |
|      |                       | <enum_type>                  |
| (99) | <constr_forward_decl> | ::= "struct" <identifier>    |
|      |                       | "union" <identifier>         |

### 3.11.2.1 Structures

The syntax for **struct** type is

|      |               |                                                 |
|------|---------------|-------------------------------------------------|
| (69) | <struct_type> | ::= "struct" <identifier> "{" <member_list> "}" |
| (70) | <member_list> | ::= <member> <sup>+</sup>                       |
| (71) | <member>      | ::= <type_spec> <declarators> ";                |

The <identifier> in <struct\_type> defines a new legal type. Structure types may also be named using a **typedef** declaration.

Name scoping rules require that the member declarators in a particular structure be unique. The value of a **struct** is the value of all of its members.

### 3.11.2.2 Discriminated Unions

The discriminated **union** syntax is:

|      |                    |                                                 |
|------|--------------------|-------------------------------------------------|
| (72) | <union_type>       | ::= "union" <identifier> "switch"               |
|      |                    | "(" <switch_type_spec> ")"                      |
|      |                    | "{" <switch_body> "}"                           |
| (73) | <switch_type_spec> | ::= <integer_type>                              |
|      |                    | <char_type>                                     |
|      |                    | <boolean_type>                                  |
|      |                    | <enum_type>                                     |
|      |                    | <scoped_name>                                   |
| (74) | <switch_body>      | ::= <case> <sup>+</sup>                         |
| (75) | <case>             | ::= <case_label> <sup>+</sup> <element_spec> "; |
| (76) | <case_label>       | ::= "case" <const_exp> ":",                     |
|      |                    | "default" ":",                                  |
| (77) | <element_spec>     | ::= <type_spec> <declarator>                    |

OMG IDL unions are a cross between the C **union** and **switch** statements. IDL unions must be discriminated; that is, the union header must specify a typed tag field that determines which union member to use for the current instance of a call. The <identifier> following the **union** keyword defines a new legal type. Union types may also be named using a **typedef** declaration. The <const\_exp> in a <case\_label> must be consistent with the <switch\_type\_spec>. A **default** case can appear at most once. The <scoped\_name> in the <switch\_type\_spec> production must be a previously defined **integer**, **char**, **boolean** or **enum** type.



Case labels must match or be automatically castable to the defined type of the discriminator. Name scoping rules require that the element declarators in a particular union be unique. If the **<switch\_type\_spec>** is an **<enum\_type>**, the identifier for the enumeration is in the scope of the union; as a result, it must be distinct from the element declarators.

It is not required that all possible values of the union discriminator be listed in the **<switch\_body>**. The value of a union is the value of the discriminator together with one of the following:

- If the discriminator value was explicitly listed in a **case** statement, the value of the element associated with that **case** statement;
- If a default **case** label was specified, the value of the element associated with the default **case** label;
- No additional value.

The values of the constant expressions for the case labels of a single union definition must be distinct. A union type can contain a default label only where the values given in the non-default labels do not cover the entire range of the union's discriminant type.

Access to the discriminator and the related element is language-mapping dependent.

---

**Note** – While any ISO Latin-1 (8859.1) IDL character literal may be used in a **<case\_label>** in a union definition whose discriminator type is **char**, not all of these characters are present in all transmission code sets that may be negotiated by GIOP or in all native code sets that may be used by implementation language compilers and runtimes. When an attempt is made to marshal to CDR a **union** whose discriminator value of **char** type is not available in the negotiated transmission code set, or to demarshal from CDR a **union** whose discriminator value of **char** type is not available in the native code set, a **DATA\_CONVERSION** system exception is raised. Therefore, to ensure portability and interoperability, care must be exercised when assigning the **<case\_label>** for a **union** member whose discriminator type is **char**. Due to these issues, use of **char** types as the discriminator type for **unions** is not recommended.

---

### 3.11.2.3 *Constructed Recursive Types and IForward Declarations*

The IDL syntax allows the generation of recursive structures and unions via members that have a sequence type. The element type of a recursive sequence struct or union member must identify a struct, union, or valuetype. (A valuetype is allowed to have a member of its own type either directly or indirectly through a member of a constructed type—see Section 3.9.1.6, “Value Type Example,” on page 3-28.) For example, the following is legal:

```
struct Foo {
 long value;
 sequence<Foo> chain; // Deprecated (see Section 3.11.6)
}
```

See Section 3.11.3.1, “Sequences,” on page 3-44 for details of the **sequence** template type.

IDL supports recursive types via a forward declaration for structures and unions (as well as for valuetypes—see Section 3.9.1.6, “Value Type Example,” on page 3-28). Because anonymous types are deprecated (see Section 3.11.6, “Deprecated Anonymous Types,” on page 3-47), the previous example is better written as:

```
struct Foo; // Forward declaration
typedef sequence<Foo> FooSeq;
struct Foo {
 long value;
 FooSeq chain;
};
```

The forward declaration for the structure enables the definition of the sequence type **FooSeq**, which is used as the type of the recursive member.

Forward declarations are legal for structures and unions. A structure or union type is termed incomplete until its full definition is provided; that is, until the scope of the structure or union definition is closed by a terminating `};`. For example:

```
struct Foo; // Introduces Foo type name,
 // Foo is incomplete now
 // ...
struct Foo {
 // ...
}; // Foo is complete at this point
```

If a structure or union is forward declared, a definition of that structure or union must follow the forward declaration in the same source file. Compilers shall issue a diagnostic if this rule is violated. Multiple forward declarations of the same structure or union are legal.

If a recursive structure or union member is used, sequence members that are recursive must refer to an incomplete type currently under definition. For example

```
struct Foo; // Forward declaration
typedef sequence<Foo> FooSeq;
struct Bar {
 long value;
 FooSeq chain; //Illegal, Foo is not an enclosing struct or union
};
```

Compilers shall issue a diagnostic if this rule is violated.

Recursive definitions can span multiple levels. For example:

```
union Bar; // Forward declaration
typedef sequence<Bar> BarSeq;
union Bar switch(long) { // Define incomplete union
 case 0:
```

```

 long l_mem;
case 1:
 struct Foo {
 double d_mem;
 BarSeq nested; // OK, recurse on enclosing
 // incomplete type
 } s_mem;
};

```

An incomplete type can only appear as the element type of a sequence definition. A sequence with incomplete element type is termed an *incomplete sequence type*:

```

struct Foo; // Forward declaration
typedef sequence<Foo> FooSeq; // incomplete

```

An incomplete sequence type can appear only as the element type of another sequence, or as the member type of a structure or union definition. For example:

```

struct Foo; // Forward declaration
typedef sequence<Foo> FooSeq; // OK
typedef sequence<FooSeq> FooTree; // OK

```

```

interface I {
 FooSeq op1(); // Illegal, FooSeq is incomplete
 void op2(// Illegal, FooTree is incomplete
 in FooTree t
);
};

```

```

struct Foo { // Provide definition of Foo
 long l_mem;
 FooSeq chain; // OK
 FooTree tree; // OK
};

```

```

interface J {
 FooSeq op1(); // OK, FooSeq is complete
 void op2(// OK, FooTree is complete
 in FooTree t
);
};

```

Compilers shall issue a diagnostic if this rule is violated.

#### 3.11.2.4 Enumerations

Enumerated types consist of ordered lists of identifiers. The syntax is:

- (78) `<enum_type>` ::= “enum” `<identifier>`  
“{” `<enumerator>` { “,” `<enumerator>` }\* “}”
- (79) `<enumerator>` ::= `<identifier>`

A maximum of  $2^{32}$  identifiers may be specified in an enumeration; as such, the enumerated names must be mapped to a native data type capable of representing a maximally-sized enumeration. The order in which the identifiers are named in the specification of an enumeration defines the relative order of the identifiers. Any language mapping that permits two enumerators to be compared or defines successor/predecessor functions on enumerators must conform to this ordering relation. The **<identifier>** following the **enum** keyword defines a new legal type. Enumerated types may also be named using a **typedef** declaration.

### 3.11.3 Template Types

The template types are:

```
(47) <template_type_spec> ::= <sequence_type>
 | <string_type>
 | <wide_string_type>
 | <fixed_pt_type>
```

#### 3.11.3.1 Sequences

OMG IDL defines the sequence type **sequence**. A sequence is a one-dimensional array with two characteristics: a maximum size (which is fixed at compile time) and a length (which is determined at run time).

The syntax is:

```
(80) <sequence_type> ::= "sequence" "<" <simple_type_spec> ","
 <positive_int_const> ">"
 | "sequence" "<" <simple_type_spec> ">"
```

The second parameter in a sequence declaration indicates the maximum size of the sequence. If a positive integer constant is specified for the maximum size, the sequence is termed a bounded sequence. If no maximum size is specified, size of the sequence is unspecified (unbounded).

Prior to passing a bounded or unbounded sequence as a function argument (or as a field in a structure or union), the length of the sequence must be set in a language-mapping dependent manner. After receiving a sequence result from an operation invocation, the length of the returned sequence will have been set; this value may be obtained in a language-mapping dependent manner.

A sequence type may be used as the type parameter for another sequence type. For example, the following:

```
typedef sequence< sequence<long> > Fred;
```

declares Fred to be of type "unbounded sequence of unbounded sequence of long." Note that for nested sequence declarations, white space must be used to separate the two ">" tokens ending the declaration so they are not parsed as a single ">>" token.

### 3.11.3.2 Strings

OMG IDL defines the string type **string** consisting of all possible 8-bit quantities except null. A string is similar to a sequence of char. As with sequences of any type, prior to passing a string as a function argument (or as a field in a structure or union), the length of the string must be set in a language-mapping dependent manner. The syntax is:

```
(81) <string_type> ::= "string" "<" <positive_int_const> ">"
 | "string"
```

The argument to the string declaration is the maximum size of the string. If a positive integer maximum size is specified, the string is termed a bounded string; if no maximum size is specified, the string is termed an unbounded string.

Strings are singled out as a separate type because many languages have special built-in functions or standard library functions for string manipulation. A separate string type may permit substantial optimization in the handling of strings compared to what can be done with sequences of general types.

### 3.11.3.3 Wstrings

The **wstring** data type represents a sequence of wchar, except the wide character null. The type wstring is similar to that of type string, except that its element type is wchar instead of char. The actual length of a wstring is set at run-time and, if the bounded form is used, must be less than or equal to the bound.

The syntax for defining a wstring is:

```
(82) <wide_string_type> ::= "wstring" "<" <positive_int_const> ">"
 | "wstring"
```

### 3.11.3.4 Fixed Type

The **fixed** data type represents a fixed-point decimal number of up to 31 significant digits. The scale factor is a non-negative integer less than or equal to the total number of digits (note that constants with effectively negative scale, such as 10000, are always permitted).

The **fixed** data type will be mapped to the native fixed point capability of a programming language, if available. If there is not a native fixed point type, then the IDL mapping for that language will provide a fixed point data type. Applications that use the IDL fixed point type across multiple programming languages must take into account differences between the languages in handling rounding, overflow, and arithmetic precision.

The syntax of fixed type is:

```
(96) <fixed_pt_type> ::= "fixed" "<" <positive_int_const> ",",
 <positive_int_const> ">"
```

(97) `<fixed_pt_const_type> ::= "fixed"`

### 3.11.4 Complex Declarator

#### 3.11.4.1 Arrays

OMG IDL defines multidimensional, fixed-size arrays. An array includes explicit sizes for each dimension.

The syntax for arrays is:

(83) `<array_declarator> ::= <identifier> <fixed_array_size>+`

(84) `<fixed_array_size> ::= "[" <positive_int_const> "]"`

The array size (in each dimension) is fixed at compile time. When an array is passed as a parameter in an operation invocation, all elements of the array are transmitted.

The implementation of array indices is language mapping specific; passing an array index as a parameter may yield incorrect results.

### 3.11.5 Native Types

OMG IDL provides a declaration for use by object adapters to define an opaque type whose representation is specified by the language mapping for that object adapter.

The syntax is:

(42) `<type_dcl> ::= "native" <simple_declarator>`

(51) `<simple_declarator> ::= <identifier>`

This declaration defines a new type with the specified name. A native type is similar to an IDL basic type. The possible values of a native type are language-mapping dependent, as are the means for constructing them and manipulating them. Any interface that defines a native type requires each language mapping to define how the native type is mapped into that programming language.

A native type may be used only to define operation parameters, results and exceptions. If a native type is used for an exception, it must be mapped to a type in a programming language that can be used as an exception. Native type parameters are permitted only in operations of **local interfaces** or **valuetypes**. Any attempt to transmit a value of a native type in a remote invocation may raise the **MARSHAL** standard system exception.

It is recommended that native types be mapped to equivalent type names in each programming language, subject to the normal mapping rules for type names in that language. For example, in a hypothetical Object Adapter IDL module

```
module HypotheticalObjectAdapter {
 native Servant;
 interface HOA {
```

```

 Object activate_object(in Servant x);
};
};

```

The IDL type `Servant` would map to `HypotheticalObjectAdapter::Servant` in C++ and the `activate_object` operation would map to the following C++ member function signature:

```

CORBA::Object_ptr activate_object(
 HypotheticalObjectAdapter::Servant x);

```

The definition of the C++ type `HypotheticalObjectAdapter::Servant` would be provided as part of the C++ mapping for the `HypotheticalObjectAdapter` module.

---

**Note** – The native type declaration is provided specifically for use in object adapter interfaces, which require parameters whose values are concrete representations of object implementation instances. It is strongly recommended that it not be used in service or application interfaces. The native type declaration allows object adapters to define new primitive types without requiring changes to the OMG IDL language or to OMG IDL compiler.

---

### 3.11.6 *Deprecated Anonymous Types*

IDL currently permits the use of anonymous types in a number of places. For example:

```

struct Foo {
 long value;
 sequence<Foo> chain; // Legal (but deprecated)
}

```

Anonymous types cause a number of problems for language mappings and are therefore deprecated by this specification. Anonymous types will be removed in a future version, so new IDL should avoid use of anonymous types and use a typedef to name such types instead. Compilers need not issue a warning if a deprecated construct is encountered.

The following (non-exhaustive) examples illustrate deprecated uses of anonymous types.

Anonymous bounded string and bounded wide string types are deprecated. This rule affects constant definitions, attribute declarations, return value and parameter type declarations, sequence and array element declarations, and structure, union, exception, and valuetype member declarations. For example

```

const string<5> GREETING = "Hello"; // Deprecated

interface Foo {
 readonly attribute wstring<5> name; // Deprecated
 wstring<5> op(in wstring<5> param); // Deprecated
}

```

```

};
typedef sequence<wstring<5> > WS5Seq; // Deprecated
typedef wstring<5> NameVector [10]; // Deprecated
struct A {
 wstring<5> mem; // Deprecated
};
// Anonymous member type in unions, exceptions,
// and valuetypes are deprecated as well.

```

This is better written as:

```

typedef string<5> GreetingType;
const GreetingType GREETING = "Hello";

typedef wstring<5> ShortWName;
interface Foo {
 readonly attribute ShortWName name;
 ShortWName op(in ShortWName param);
};
typedef sequence<ShortWName> NameSeq;
typedef ShortWName NameVector[10];
struct A {
 GreetingType mem;
};

```

Anonymous fixed-point types are deprecated. This rule affects attribute declarations, return value and parameter type declarations, sequence and array element declarations, and structure, union, exception, and valuetype member declarations.

```

struct Foo {
 fixed<10,5> member; // Deprecated
};

```

This is better written as:

```

typedef fixed<10,5> MyType;
struct Foo {
 MyType member;
};

```

Anonymous member types in structures, unions, exceptions, and valuetypes are deprecated:

```

union U switch(long) {
 case 1:
 long array_mem[10]; // Deprecated
 case 2:
 sequence<long> seq_mem; // Deprecated
 case 3:
 string<5> bstring_mem;
};

```



This is better written as:

```
typedef long LongArray[10];
typedef sequence<long> LongSeq;
typedef string<5> ShortName;
union U switch (long) {
 case 1:
 LongArray array_mem;
 case 2:
 LongSeq seq_mem;
 case 3:
 ShortName bstring_mem;
};
```

Anonymous array and sequence elements are deprecated:

```
typedef sequence<sequence<long> > NumberTree; // Deprecated
typedef fixed<10,2> FixedArray[10];
```

This is better written as:

```
typedef sequence<long> ListOfNumbers;
typedef sequence<ListOfNumbers> NumberTree;
typedef fixed<10,2> Fixed_10_2;
typedef Fixed_10_2 FixedArray[10];
```

The preceding examples are not exhaustive. They simply illustrate the rule that, for a type to be used in the definition of another type, constant, attribute, return value, parameter, or member, that type must have a name. Note that the following example is not deprecated (even though stylistically poor):

```
struct Foo {
 struct Bar {
 long l_mem;
 double d_mem;
 } bar_mem_1; // OK, not anonymous
 Bar bar_mem_2; // OK, not anonymous
};
typedef sequence<Foo::Bar> FooBarSeq; // Scoped names are OK
```

### 3.12 Exception Declaration

Exception declarations permit the declaration of struct-like data structures, which may be returned to indicate that an exceptional condition has occurred during the performance of a request. The syntax is as follows:

(86) `<except_dcl> ::= "exception" <identifier> "{" <member>* "}"`

Each exception is characterized by its OMG IDL identifier, an exception type identifier, and the type of the associated return value (as specified by the **<member>** in its declaration). If an exception is returned as the outcome to a request, then the value of the exception identifier is accessible to the programmer for determining which particular exception was raised.

If an exception is declared with members, a programmer will be able to access the values of those members when an exception is raised. If no members are specified, no additional information is accessible when an exception is raised.

An identifier declared to be an exception identifier may thereafter appear only in a raises clause of an operation declaration, and nowhere else.

A set of standard system exceptions is defined corresponding to standard run-time errors, which may occur during the execution of a request. These standard system exceptions are documented in Section 4.12, “Exceptions,” on page 4-63.

### 3.13 Operation Declaration

Operation declarations in OMG IDL are similar to C function declarations. The syntax is:

```
(87) <op_dcl> ::= [<op_attribute>] <op_type_spec>
 <identifier> <parameter_dcls>
 [<raises_expr>] [<context_expr>]
(88) <op_attribute> ::= “oneway”
(89) <op_type_spec> ::= <param_type_spec>
 | “void”
```

An operation declaration consists of:

- An optional operation attribute that specifies which invocation semantics the communication system should provide when the operation is invoked. Operation attributes are described in Section 3.13.1, “Operation Attribute,” on page 3-51.
- The type of the operation’s return result; the type may be any type that can be defined in OMG IDL. Operations that do not return a result must specify the **void** type.
- An identifier that names the operation in the scope of the interface in which it is defined.
- A parameter list that specifies zero or more parameter declarations for the operation. Parameter declaration is described in Section 3.13.2, “Parameter Declarations,” on page 3-51.
- An optional raises expression that indicates which exceptions may be raised as a result of an invocation of this operation. Raises expressions are described in Section 3.13.3, “Raises Expressions,” on page 3-52.
- An optional context expression that indicates which elements of the request context may be consulted by the method that implements the operation. Context expressions are described in Section 3.13.4, “Context Expressions,” on page 3-53.

Some implementations and/or language mappings may require operation-specific pragmas to immediately precede the affected operation declaration.

### 3.13.1 Operation Attribute

The operation attribute specifies which invocation semantics the communication service must provide for invocations of a particular operation. An operation attribute is optional. The syntax for its specification is as follows:

(88) **<op\_attribute> ::= “oneway”**

When a client invokes an operation with the **oneway** attribute, the invocation semantics are best-effort, which does not guarantee delivery of the call; best-effort implies that the operation will be invoked at most once. An operation with the **oneway** attribute must not contain any output parameters and must specify a **void** return type. An operation defined with the **oneway** attribute may not include a raises expression; invocation of such an operation, however, may raise a standard system exception.

If an **<op\_attribute>** is not specified, the invocation semantics is at-most-once if an exception is raised; the semantics are exactly-once if the operation invocation returns successfully.

### 3.13.2 Parameter Declarations

Parameter declarations in OMG IDL operation declarations have the following syntax:

(90) **<parameter\_dcls> ::= “(” <param\_dcl> { “,” <param\_dcl> }\* “)”**  
 | “(” “)”

(91) **<param\_dcl> ::= <param\_attribute> <param\_type\_spec>**  
**<simple\_declarator>**

(92) **<param\_attribute> ::= “in”**  
 | “out”  
 | “inout”

(95) **<param\_type\_spec> ::= <base\_type\_spec>**  
 | <string\_type>  
 | <wide\_string\_type>  
 | <scoped\_name>

A parameter declaration must have a directional attribute that informs the communication service in both the client and the server of the direction in which the parameter is to be passed. The directional attributes are:

- **in** - the parameter is passed from client to server.
- **out** - the parameter is passed from server to client.
- **inout** - the parameter is passed in both directions.

It is expected that an implementation will *not* attempt to modify an **in** parameter. The ability to even attempt to do so is language-mapping specific; the effect of such an action is undefined.

If an exception is raised as a result of an invocation, the values of the return result and any **out** and **inout** parameters are undefined.

### 3.13.3 Raises Expressions

There are two kinds of raises expressions as described in this section.

#### 3.13.3.1 Raises Expression

A **raises** expression specifies which exceptions may be raised as a result of an invocation of the operation or accessing (invoking the `_get` operation of) a readonly attribute. The syntax for its specification is as follows:

```
(93) <raises_expr> ::= "raises" "(" <scoped_name>
 { "," <scoped_name> }* ")"
```

The **<scoped\_name>**s in the **raises** expression must be previously defined exceptions or native types. If a native type is used as an exception for an operation, the operation must appear in either a local interface or a valuetype.

In addition to any operation-specific exceptions specified in the **raises** expression, there are a standard set of system exceptions that may be signalled by the ORB. These standard system exceptions are described in Section 4.12.3, "Standard System Exception Definitions," on page 4-66. However, standard system exceptions may *not* be listed in a **raises** expression.

The absence of a **raises** expression on an operation implies that there are no operation-specific exceptions. Invocations of such an operation are still liable to receive one of the standard system exceptions.

#### 3.13.3.2 getraises and setraises Expressions

**getraises** and **setraises** expressions specify which exceptions may be raised as a result of an invocation of the accessor (`_get`) and a mutator (`_set`) functions of an attribute. The syntax for its specification is as follows:

```
(108) <attr_raises_expr> ::= <get_excep_expr> [<set_excep_expr>]
 | <set_excep_expr>
(109) <get_excep_expr> ::= "getraises" <exception_list>
(110) <set_excep_expr> ::= "setraises" <exception_list>
(111) <exception_list> ::= "(" <scoped_name>
 { "," <scoped_name> }* ")"
```

The **<scoped\_name>**s in the **getraises** and **setraises** expressions must be previously defined exceptions.

In addition to any attribute-specific exceptions specified in the **getraises** and **setraises** expressions, there are a standard set of exceptions that may be signalled by the ORB. These standard exceptions are described in Section 4.12.3, “Standard System Exception Definitions,” on page 4-66. However, standard exceptions may *not* be listed in a **getraises** or **setraises** expression.

The absence of a **getraises** or **setraises** expression on an attribute implies that there are no accessor-specific or mutator-exceptions respectively. Invocations of such an accessor or mutator are still liable to receive one of the standard exceptions.

---

**Note** – The exceptions associated with the accessor operation corresponding to a **readonly attribute** is specified using a simple **raises** expression as specified in Section 3.13.3.1, “Raises Expression,” on page 3-52. The **getraises** and **setraises** expressions are used only in **attributes** that are not **readonly**.

---

### 3.13.4 Context Expressions

A **context** expression specifies which elements of the client’s context may affect the performance of a request by the object. The syntax for its specification is as follows:

```
(94) <context_expr> ::= “context” “(” <string_literal>
 { “,” <string_literal> } * “)”
```

The run-time system guarantees to make the value (if any) associated with each **<string\_literal>** in the client’s context available to the object implementation when the request is delivered. The ORB and/or object is free to use information in this *request context* during request resolution and performance.

The absence of a context expression indicates that there is no request context associated with requests for this operation.

Each **string\_literal** is a non-empty string. If the character '\*' appears in **string\_literal**, it must appear only once, as the last character of **string\_literal**, and must be preceded by one or more characters other than '\*'.

The mechanism by which a client associates values with the context identifiers is described in Section 4.6, “Context Object,” on page 4-32.

## 3.14 Attribute Declaration

An interface can have attributes as well as operations; as such, attributes are defined as part of an interface. An attribute definition is logically equivalent to declaring a pair of accessor functions; one to retrieve the value of the attribute and one to set the value of the attribute.

The syntax for **attribute** declaration is:

```
(85) <attr_dcl> ::= <readonly_attr_spec>
 | <attr_spec>
```

- (104) `<readonly_attr_spec>` ::= “readonly” “attribute” `<param_type_spec>`  
`<readonly_attr_declarator>`
- (105) `<readonly_attr_declarator >` ::= `<simple_declarator>` `<raises_expr>`  
| `<simple_declarator>`  
{ “,” `<simple_declarator>` }\*
- (106) `<attr_spec>` ::= “attribute” `<param_type_spec>`  
`<attr_declarator>`
- (107) `<attr_declarator>` ::= `<simple_declarator>` `<attr_raises_expr>`  
| `<simple_declarator>`  
{ “,” `<simple_declarator>` }\*

The optional **readonly** keyword indicates that there is only a single accessor function—the retrieve value function. Consider the following example:

```
interface foo {
 enum material_t {rubber, glass};
 struct position_t {
 float x, y;
 };

 attribute float radius;
 attribute material_t material;
 readonly attribute position_t position;

 ...
};
```

The attribute declarations are equivalent to the following pseudo-specification fragment, assuming that one of the leading ‘\_’s is removed by application of the Escaped Identifier rule described in Section 3.2.3.1, “Escaped Identifiers,” on page 3-7:

```
...
float __get_radius ();
void __set_radius (in float r);
material_t __get_material ();
void __set_material (in material_t m);
position_t __get_position ();
...

```

The actual accessor function names are language-mapping specific. The attribute name is subject to OMG IDL’s name scoping rules; the accessor function names are guaranteed *not* to collide with any legal operation names specifiable in OMG IDL.

Attributes are inherited. An attribute name *cannot* be redefined to be a different type. See Section 3.19, “CORBA Module,” on page 3-66 for more information on redefinition constraints and the handling of ambiguity.

## 3.15 Repository Identity Related Declarations

Two constructs that are provided for specifying information related to Repository Id are described in this section.

### 3.15.1 Repository Identity Declaration

The syntax of a repository identity declaration is as follows:

(102)           <type\_id\_dcl> ::= “typeid” <scoped\_name> <string\_literal>

A repository identifier declaration includes the following elements:

- the keyword **typeid**
- a <scoped\_name> that denotes the named IDL construct to which the repository identifier is assigned
- a string literal that must contain a valid repository identifier value

The <scoped\_name> is resolved according to normal IDL name resolution rules, based on the scope in which the declaration occurs. It must denote a previously-declared name of one of the following IDL constructs:

- module
- interface
- component
- home
- facet
- receptacle
- event sink
- event source
- finder
- factory
- event type
- value type
- value type member
- value box
- constant
- typedef
- exception
- attribute
- operation
- enum
- local

The value of the string literal is assigned as the repository identity of the specified type definition. This value will be returned as the **RepositoryId** by the interface repository definition object corresponding to the specified type definition. Language mappings constructs, such as Java helper classes, that return repository identifiers shall return the values declared for their corresponding definitions.

At most one repository identity declaration may occur for any named type definition. An attempt to redefine the repository identity for a type definition is illegal, regardless of the value of the redefinition.

If no explicit repository identity declaration exists for a type definition, the repository identifier for the type definition shall be an IDL format repository identifier, as defined in Section 10.7.1, “OMG IDL Format,” on page 10-65.

### 3.15.2 Repository Identifier Prefix Declaration

The syntax of a repository identifier prefix declaration is as follows:

(103)        **<type\_prefix\_dcl> ::= “typeprefix” <scoped\_name> <string\_literal>**

A repository identifier declaration includes the following elements:

- the keyword **typeprefix**
- a *<scoped\_name>* that denotes an IDL name scope to which the prefix applies
- a string literal that must contain the string to be prefixed to repository identifiers in the specified name scope

The *<scoped\_name>* is resolved according to normal IDL name resolution rules, based on the scope in which the declaration occurs. It must denote a previously-declared name of one of the following IDL constructs:

- module
- interface (including abstract or local interface)
- value type (including abstract, custom, and box value types)
- event type (including abstract and custom value types)
- specification scope ( :: )

The specified string is prefixed to the body of all repository identifiers in the specified name scope, whose values are assigned by default. To elaborate:

By “prefixed to the body of a repository identifier,” we mean that the specified string is inserted into the default IDL format repository identifier immediately after the format name and colon ( “IDL:” ) at the beginning of the identifier. A forward slash ( ‘/’ ) character is inserted between the end of the specified string and the remaining body of the repository identifier.

The prefix is only applied to repository identifiers whose values are not explicitly assigned by a typeid declaration. The prefix is applied to all such repository identifiers in the specified name scope, including the identifier of the construct that constitutes the name scope.



## 3.16 Event Declaration

Event type is a specialization of value type dedicated to asynchronous component communication. There are several kinds of event type declarations: “regular” event types, abstract event types, and forward declarations.

An event declaration satisfies the following syntax:

(134) **<event> ::= ( <event\_dcl> | <event\_abs\_dcl> | <event\_forward\_dcl> )**

### 3.16.1 Regular Event Type

A regular event type satisfies the following syntax:

(137) **<event\_dcl> ::= <event\_header> “{” <value\_element> \* “}”**

(138) **<event\_header> ::= [ “custom” ] “eventtype” <identifier> [ <value\_inheritance\_spec> ]**

#### 3.16.1.1 Event Header

The event header consists of two elements:

- The event type’s name and optional modifier specifying whether the event type uses custom marshaling.
- An optional value inheritance specification described in Section 3.9.1.3, “Value Inheritance Specification,” on page 3-27.

#### 3.16.1.2 Event Element

An event can contain all the elements that a value can as described in Section 3.9.1.2, “Value Element,” on page 3-27 (i.e., attributes, operations, initializers, state members).

### 3.16.2 Abstract Event Type

(136) **<event\_abs\_dcl> ::= “abstract” “eventtype” <identifier> [ <value\_inheritance\_spec> ] “{” <export> \* “}”**

Event types may also be abstract. They are called abstract because an abstract event type may not be instantiated. No <state\_member> or <initializers> may be specified. However, local operations may be specified. Essentially they are a bundle of operation signatures with a purely local implementation.

Note that a concrete event type with an empty state is not an abstract event type.

### 3.16.3 Event Forward Declaration

(135) **<event\_forward\_dcl> ::= [ “abstract” ] “eventtype” <identifier>**

A forward declaration declares the name of an event type without defining it. This permits the definition of event types that refer to each other. The syntax consists simply of the keyword **eventtype** followed by an **<identifier>** that names the event type.

Multiple forward declarations of the same event type name are legal.

It is illegal to inherit from a forward-declared event type whose definition has not yet been seen.

### 3.16.4 Eventtype Inheritance

As event type is a specialization of value type then event type inheritance is directly analogous to value inheritance (see Section 3.9.1.3, “Value Inheritance Specification,” on page 3-27 for a detailed description of the analogous properties for valuetypes). In addition, an event type could inherit from a single immediate base concrete event type, which must be the first element specified in the inheritance list of the event declaration’s IDL. It may be followed by other abstract values or events from which it inherits.

## 3.17 Component Declaration

### 3.17.1 Component

A component declaration describes an interface for a component. The salient characteristics of a component declaration are as follows:

- A component declaration specifies the name of the component.
- A component declaration may specify a list of interfaces that the component supports.
- Component declarations support single inheritance from other component definitions.
- Component declarations may include in its body any attribute declarations that are legal in normal interface declarations, together with declarations of facets and receptacles of the component, and the event sources and sinks that the component defines.

#### 3.17.1.1 Syntax

The syntax for declaring a component is as follows:

```
(112) <component> ::= <component_dcl>
 | <component_forward_dcl>
(113) <component_forward_dcl> ::= “component” <identifier>
(114) <component_dcl> ::= <component_header>
 “{” <component_body> “}”
```

**<component\_forward\_dcl>** is described in Section 3.17.1.2, “Forward Declaration.

**<component\_header>** is described in Section 3.17.2, “Component Header.

**<component\_body>** is described in Section 3.17.3, “Component Body.

### 3.17.1.2 Forward Declaration

A forward declaration declares the name of a component without defining it. This permits the definition of components that refer to each other. The syntax consists simply of the keyword **component** followed by an **<identifier>** that names the component. The actual definition must follow later in the specification.

Multiple forward declarations of the same component name are legal.

It is illegal to inherit from a forward-declared component whose definition has not yet been seen.

## 3.17.2 Component Header

A **<component\_header>** declares the primary characteristics of a component interface.

### 3.17.2.1 Syntax

The syntax for declaring a component header is as follows:

```
(115) <component_header> ::= “component” <identifier>
 [<component_inheritance_spec>]
 [<supported_interface_spec>]
```

```
(116) <supported_interface_spec> ::= “supports” <scoped_name>
 { “,” <scoped_name> }*
```

```
(117) <component_inheritance_spec> ::= “:” <scoped_name>
```

A component header comprises the following elements:

- the keyword **component**.
- an **<identifier>** that names the component type.
- an optional **<inheritance\_spec>**, consisting of a colon and a single **<scoped\_name>** that must denote a previously-defined component type.
- an optional **<supported\_interface\_spec>** that must denote one or more previously-defined IDL interfaces.

### 3.17.2.2 Supported interfaces

A component may optionally support one or more interfaces. When a component definition header includes a supports clause as follows:

```
component <component_name> supports <interface_name> { ... };
```

For further detail see the *CORBA Components* specification, chapter 1, section 1.4.5 (Supported Interfaces).

### 3.17.2.3 Component Inheritance

A component may optionally inherit from a component that supports one or more interfaces. This is specified by using the inheritance construct that looks like:

```
component <component_name> : <component_name> { ... };
```

The following rules apply to component inheritance:

- A derived component type may not directly support an interface.
- The interface for a derived component type is derived from the interface of its base component type.
- A component type may have at most one base component type.
- The features of a component that are inherited by the derived component are:
  - the **provides** statements
  - the **uses** statements
  - the **emits** statements
  - the **publishes** statements
  - the **consumes** statements
  - attributes

See Section 3.17.2.3, “Component Inheritance,” on page 3-60 for details of component inheritance.

### 3.17.3 Component Body

```
(118) <component_body> ::= <component_export>*
(119) <component_export> ::= <provides_dcl> “;”
 | <uses_dcl> “;”
 | <emits_dcl> “;”
 | <publishes_dcl> “;”
 | <consumes_dcl> “;”
 | <attr_dcl> “;”
```

A component forms a naming scope, nested within the scope in which the component is declared. A component body can contain the following kinds of declarations:

- Facet declarations (**provides**)
- Receptacle declarations (**uses**)
- Event source declarations (**emits** or **publishes**)
- Event sink declarations (**consumes**)
- Attribute declarations (**attribute** and **readonly attribute**)

These declarations and their meanings are described in detail in the *CORBA Components* specification, Component Model chapter, “Facets and Navigation” through “Events” sections.

### 3.17.3.1 Facets and Navigation

A component type may provide several independent interfaces to its clients in the form of facets. Facets are intended to be the primary vehicle through which a component exposes its functional application behavior to clients during normal execution. A component may exhibit zero or more facets.

#### 3.17.3.1.1 Syntax

A facet is declared with the following syntax:

```
(120) <provides_dcl> ::= "provides" <interface_type> <identifier>
(121) <interface_type> ::= <scoped_name>
 | "Object"
```

The interface type shall be either the keyword **Object**, or a scoped name that denotes a previously-declared interface type which is not a component interface, i.e., is not the interface corresponding to a component definition. The identifier names the facet within the scope of the component, allowing multiple facets of the same type to be provided by the component.

See the *CORBA Components* specification, Component Model chapter, "Facets and Navigation" for further details.

### 3.17.3.2 Receptacles

A component definition can describe the ability to accept object references upon which the component may invoke operations. When a component accepts an object reference in this manner, the relationship between the component and the referent object is called a *connection*; they are said to be *connected*. The conceptual point of connection is called a *receptacle*. A receptacle is an abstraction that is concretely manifested on a component as a set of operations for establishing and managing connections. A component may exhibit zero or more receptacles.

#### 3.17.3.2.2 Syntax

The syntax for describing a receptacle is as follows:

```
(122) <uses_dcl> ::= "uses" ["multiple"]
 < interface_type> <identifier>
```

A receptacle declaration comprises the following elements:

- The keyword **uses**.
- The optional keyword **multiple**. The presence of this keyword indicates that the receptacle may accept multiple connections simultaneously, and results in different operations on the component's associated interface.
- An *<interface\_type>*, which must be either the keyword **Object** or a scoped name that denotes the interface type that the receptacle will accept. The scoped name must denote a previously-defined non-component interface type.
- An *<identifier>* that names the receptacle in the scope of the component.

See the *CORBA Components* specification, Component Model chapter, “Receptacles” section for further details.

### 3.17.4 Event Sources—publishers and emitters

An event source embodies the potential for the component to generate events of a specified type, and provides mechanisms for associating consumers with sources.

There are two categories of event sources, *publishers* and *emitters*. Both are implemented using event channels supplied by the container. An emitter can be connected to at most one consumer. A publisher can be connected through the channel to an arbitrary number of consumers, who are said to *subscribe* to the publisher event source. A component may exhibit zero or more emitters and publishers.

#### 3.17.4.1 Publishers

##### 3.17.4.1.3 Syntax

The syntax for an event publisher is as follows:

(124) **<publishes\_dcl> ::= “publishes” <scoped\_name> <identifier>**

A publisher declaration consists of the following elements:

- the keyword **publishes**
- a *<scoped\_name>* that denotes a previously-defined event type
- an *<identifier>* that names the publisher event source in the scope of the component

See the *CORBA Components* specification, Component Model chapter, “Publisher” section for further details.

#### 3.17.4.2 Emitters

##### 3.17.4.2.4 Syntax

The syntax for an emitter declaration is as follows:

(123) **<emits\_dcl> ::= “emits” <scoped\_name> <identifier>**

An emitter declaration consists of the following elements:

- the keyword **emits**
- a *<scoped\_name>* that denotes a previously-defined event type
- an *<identifier>* that names the event source in the scope of the component.

See the *CORBA Components* specification, Component Model chapter, “Emitters” section for further details.

### 3.17.5 Event Sinks

An event sink embodies the potential for the component to receive events of a specified type. An event sink is, in essence, a special-purpose facet whose type is an event consumer. External entities, such as clients or configuration services, can obtain the reference for the consumer interface associated with the sink.

A component may exhibit zero or more consumers.

See the *CORBA Components* specification, Component Model chapter, “Event Sinks” section for further details.

#### 3.17.5.1 Syntax

The syntax for an event sink declaration is as follows:

(125)            **<consumes\_dcl> ::= “consumes” <scoped\_name> <identifier>**

An event sink declaration contains the following elements:

- the keyword **consumes**
- a *<scoped\_name>* that denotes a previously-defined event type
- an *<identifier>* that names the event sink in the component’s scope

See the *CORBA Components* specification, Component Model chapter, “Event Sinks” section for further details.

### 3.17.6 Basic and Extended Components

A component that satisfies the following properties is known as a *Basic Component*:

- It does not inherit from another component.
- Its declaration does not contain any provides statements.
- Its declaration does not contain any uses statements.
- Its declaration does not contain any publishes, emits, or consumes statements.

In effect a declaration of a *Basic Component* fits the pattern:

**“component” <identifier> [<supported\_interface\_spec>]  
“{“ {<attr\_dcl> “;”}\* “}”**

A component that is not a *Basic Component* is referred to as an *Extended Component*.

## 3.18 Home Declaration

A home declaration describes an interface for managing instances of a specified component type.

### 3.18.1 Home

The salient characteristics of a home declaration are as follows:

- A home declaration must specify exactly one component type that it manages. Multiple homes may manage the same component type.
- A home declaration may specify a primary key type. Primary keys are values assigned by the application environment that uniquely identify component instances managed by a particular home. Primary key types must be value types derived from **Components::PrimaryKeyBase**. There are more specific constraints placed on primary key types, which are specified in the *CORBA Components* specification, Component Model chapter, “Primary key type constraints” section.
- Home declarations may include any declarations that are legal in normal interface declarations.
- Home declarations support single inheritance from other home definitions, subject to a number of constraints that are described in the *CORBA Components* specification, Component Model chapter, “Home inheritance” section.
- Home declarations may specify a list of interfaces that the home supports.

#### 3.18.1.1 Syntax

The syntax for a home definition is as follows:

(126) **<home\_dcl> ::= <home\_header> <home\_body>**

**<home\_header>** is described in Section 3.18.2, “Home Header.”

**<home\_body>** is described in Section 3.18.3, “Home Body.”

### 3.18.2 Home Header

A *<home\_header>* describes fundamental characteristics of a home interface.

#### 3.18.2.1 Syntax

The syntax for a home header declaration is as follows:

(127) **<home\_header> ::= “home” <identifier>  
[ <home\_inheritance\_spec> ]  
[ <supported\_interface\_spec> ]  
“manages” <scoped\_name>  
[ <primary\_key\_spec> ]**

(128) **<home\_inheritance\_spec> ::= “:” <scoped\_name>**

(129) **<primary\_key\_spec> ::= “primarykey” <scoped\_name>**

A *<home\_header>* consists of the following elements:

- The keyword **home**.
- An *<identifier>* that names the home in the enclosing name scope.



- An optional *<home\_inheritance\_spec>*, consisting of a colon “:” and a single *<scoped\_name>* that denotes a previously defined home type.
- An optional *<supported\_interface\_spec>* that must denote one or more previously defined IDL interfaces.
- The keyword **manages**.
- A *<scoped\_name>* that denotes a previously defined component type.
- An optional primary key definition, consisting of the keyword **primarykey** followed by a *<scoped\_name>* that denotes a previously defined value type that is derived from the abstract value type **Components::PrimaryKeyBase**. Additional constraints on primary keys are described in the *CORBA Components* specification, Component Model chapter, “Primary key type constraints” section.

Details of semantics can be found in the *CORBA Components* specification, Component Model chapter, “Homes” section.

### 3.18.3 Home Body

```
(130) <home_body> ::= "{" <home_export>* "}"
(131) <home_export ::= <export>
 | <factory_dcl> ","
 | <finder_dcl> ","
```

#### 3.18.3.1 Operation Declarations

A home body may include zero or more operation declarations, where the operation may be a *factory* operation, a *finder* operation, or a normal operation or attribute.

##### 3.18.3.1.1 Factory operations

The syntax of a factory operation is as follows:

```
(132) <factory_dcl> ::= "factory" <identifier>
 "(" [<init_param_decls>] ")"
 [<raises_expr>]
```

A factor operation declaration consists of the following elements:

- the keyword **factory**
- an *<identifier>* that names the operation in the scope of the home declaration
- an optional list of initialization parameters (*<init\_param\_decls>*) enclosed in parentheses
- an optional *<raises\_expr>* declaring exceptions that may be raised by the operation

A factory declaration has an implicit return value of type reference to component.

See the *CORBA Components* specification, Component Model chapter, “Factory operations” section for further details.

### 3.18.3.1.2 Finder operations

The syntax of a finder operation is as follows:

```
(133) <finder_dcl> ::= "finder" <identifier>
 "([<init_param_decls>])"
 [<raises_expr>]
```

A finder operation declaration consists of the following elements:

- the keyword **finder**
- an identifier that names the operation in the scope of the storage home declaration
- an optional list of initialization parameters (*<init\_param\_decls>*) enclosed in parentheses
- an optional *<raises\_expr>* declaring exceptions that may be raised by the operation

A finder declaration has an implicit return value of type reference to component.

See the *CORBA Components* specification, Component Model chapter, "Finder operations" section for further details.

## 3.19 CORBA Module

Names defined by the CORBA specification are in a module named CORBA. In an OMG IDL specification, however, OMG IDL keywords such as **Object** must not be preceded by a "**CORBA::**" prefix. Other interface names such as **TypeCode** are not OMG IDL keywords, so they must be referred to by their fully scoped names (e.g., **CORBA::TypeCode**) within an OMG IDL specification.

For example in:

```
#include <orb.idl>
module M {
 typedef CORBA::Object myObjRef; // Error: keyword Object scoped
 typedef TypeCode myTypeCode; // Error: TypeCode undefined
 typedef CORBA::TypeCode TypeCode; // OK
};
```

The file **orb.idl** contains the IDL definitions for the **CORBA** module. Except for **CORBA::TypeCode**, the file **orb.idl** must be included in IDL files that use names defined in the **CORBA** module. IDL files that use **CORBA::TypeCode** may obtain its definition by including either the file **orb.idl** or the file **TypeCode.idl**.

The exact contents of **TypeCode.idl** are implementation dependent. One possible implementation of **TypeCode.idl** may be:

```
// PIDL
#ifndef _TYPECODE_IDL_
#define _TYPECODE_IDL_
#pragma prefix "omg.org"
module CORBA {
```

```

interface TypeCode;
};
#endif // _TYPECODE_IDL_

```

For IDL compilers that implicitly define **CORBA::TypeCode**, **TypeCode.idl** could consist entirely of a comment as shown below:

```

// PIDL
// CORBA::TypeCode implicitly built into the IDL compiler
// Hence there are no declarations in this file

```

Because the compiler implicitly contains the required declaration, this file meets the requirement for compliance.

The version of **CORBA** specified in this release of the specification is version **<x.y>**, and this is reflected in the IDL for the **CORBA** module by including the following pragma version (see Section 10.7.5.3, “The Version Pragma,” on page 10-71):

```

#pragma version CORBA <x.y>

```

as the first line immediately following the very first **CORBA** module introduction line, which in effect associates that version number with the **CORBA** entry in the **IR**. The version number in that version pragma line must be changed whenever any changes are made to any remotely accessible parts of the **CORBA** module in an officially released OMG standard.

### 3.20 Names and Scoping

OMG IDL identifiers are case insensitive; that is, two identifiers that differ only in the case of their characters are considered redefinitions of one another. However, all references to a definition must use the same case as the defining occurrence. This allows natural mappings to case-sensitive languages. For example:

```

module M {
 typedef long Long; // Error: Long clashes with keyword long
 typedef long TheThing;
 interface I {
 typedef long MyLong;
 myLong op1(// Error: inconsistent capitalization
 in TheThing thething; // Error: TheThing clashes with thething
);
 };
};

```

### 3.20.1 Qualified Names

A qualified name (one of the form <scoped-name>::<identifier>) is resolved by first resolving the qualifier <scoped-name> to a scope S, and then locating the definition of <identifier> within S. The identifier must be directly defined in S or (if S is an interface) inherited into S. The <identifier> is not searched for in enclosing scopes.

When a qualified name begins with “::”, the resolution process starts with the file scope and locates subsequent identifiers in the qualified name by the rule described in the previous paragraph.

Every OMG IDL definition in a file has a global name within that file. The global name for a definition is constructed as follows.

Prior to starting to scan a file containing an OMG IDL specification, the name of the current root is initially empty (“”) and the name of the current scope is initially empty (“”). Whenever a **module** keyword is encountered, the string “::” and the associated identifier are appended to the name of the current root; upon detection of the termination of the **module**, the trailing “::” and identifier are deleted from the name of the current root. Whenever an **interface**, **struct**, **union**, or **exception** keyword is encountered, the string “::” and the associated identifier are appended to the name of the current scope; upon detection of the termination of the **interface**, **struct**, **union**, or **exception**, the trailing “::” and identifier are deleted from the name of the current scope. Additionally, a new, unnamed, scope is entered when the parameters of an operation declaration are processed; this allows the parameter names to duplicate other identifiers; when parameter processing has completed, the unnamed scope is exited.

The global name of an OMG IDL definition is the concatenation of the current root, the current scope, a “::”, and the <identifier>, which is the local name for that definition.

Note that the global name in an OMG IDL files corresponds to an absolute **ScopedName** in the Interface Repository. (See Section 10.5.1, “Supporting Type Definitions,” on page 10-12).

Inheritance causes all identifiers defined in base interfaces, both direct and indirect, to be visible in derived interfaces. Such identifiers are considered to be semantically the same as the original definition. Multiple paths to the same original identifier (as results from the diamond shape in Figure 3-1 on page 3-24) do not conflict with each other.

Inheritance introduces multiple global OMG IDL names for the inherited identifiers. Consider the following example:

```
interface A {
 exception E {
 long L;
 };
 void f() raises(E);
};

interface B: A {
 void g() raises(E);
};
```

```
};
```

In this example, the exception is known by the global names `::A::E` and `::B::E`.

Ambiguity can arise in specifications due to the nested naming scopes. For example:

```
interface A {
 typedef string<128> string_t;
};

interface B {
 typedef string<256> string_t;
};

interface C: A, B {
 attribute string_t Title; // Error: Ambiguous
 attribute A::string_t Name; // OK
 attribute B::string_t City; // OK
};
```

The declaration of attribute `Title` in interface `C` is ambiguous, since the compiler does not know which `string_t` is desired. Ambiguous declarations yield compilation errors.

### 3.20.2 Scoping Rules and Name Resolution

Contents of an entire OMG IDL file, together with the contents of any files referenced by `#include` statements, forms a naming scope. Definitions that do not appear inside a scope are part of the global scope. There is only a single global scope, irrespective of the number of source files that form a specification.

The following kinds of definitions form scopes:

- module
- interface
- valuetype
- struct
- union
- operation
- exception
- eventtype
- component
- home

The scope for module, interface, valuetype, struct, exception, eventtype, component, and home begins immediately following its opening `{` and ends immediately preceding its closing `}`. The scope of an operation begins immediately following its `(` and ends immediately preceding its closing `)`. The scope of a union begins

immediately following the ‘(‘ following the keyword **switch**, and ends immediately preceding its closing ‘)’’. The appearance of the declaration of any of these kinds in any scope, subject to semantic validity of such declaration, opens a nested scope associated with that declaration.

An identifier can only be defined once in a scope. However, identifiers can be redefined in nested scopes. An identifier declaring a module is considered to be defined by its first occurrence in a scope. Subsequent occurrences of a module declaration with the same identifier within the same scope reopens the module and hence its scope, allowing additional definitions to be added to it.

The name of an interface, value type, struct, union, exception, or a module may not be redefined within the immediate scope of the interface, value type, struct, union, exception, or the module. For example:

```

module M {
 typedef short M; // Error: M is the name of the module
 // in the scope of which the typedef is.
 interface I {
 void i (in short j); // Error: i clashes with the interface name I
 };
};

```

An identifier from a surrounding scope is introduced into a scope if it is used in that scope. An identifier is not introduced into a scope by merely being visible in that scope. The use of a scoped name introduces the identifier of the outermost scope of the scoped name. For example in:

```

module M {
 module Inner1 {
 typedef string S1;
 };

 module Inner2 {
 typedef string inner1; // OK
 };
}

```

The declaration of **Inner2::inner1** is OK because the identifier **Inner1**, while visible in module **Inner2**, has not been introduced into module **Inner2** by actual use of it. On the other hand, if module **Inner2** were:

```

module Inner2{
 typedef Inner1::S1 S2; // Inner1 introduced
 typedef string inner1; // Error
 typedef string S1; // OK
};

```

The definition of **inner1** is now an error because the identifier **Inner1** referring to the **module Inner1** has been introduced in the scope of module **Inner2** in the first line of the module declaration. Also, the declaration of **S1** in the last line is OK since the identifier **S1** was not introduced into the scope by the use of **Inner1::S1** in the first line.

Only the first identifier in a qualified name is introduced into the current scope. This is illustrated by **Inner1::S1** in the example above, which introduces “**Inner1**” into the scope of “**Inner2**” but does not introduce “**S1**.” A qualified name of the form “**::X::Y::Z**” does not cause “**X**” to be introduced, but a qualified name of the form “**X::Y::Z**” does.

Enumeration value names are introduced into the enclosing scope and then are treated like any other declaration in that scope. For example:

```
interface A {
 enum E { E1, E2, E3 }; // line 1

 enum BadE { E3, E4, E5 }; // Error: E3 is already introduced
 // into the A scope in line 1 above
};

interface C {
 enum AnotherE { E1, E2, E3 };
};

interface D : C, A {
 union U switch (E) {
 case A::E1 : boolean b; // OK.
 case E2 : long l; // Error: E2 is ambiguous (notwithstanding
 // the switch type specification!!)
 };
};
```

Type names defined in a scope are available for immediate use within that scope. In particular, see Section 3.11.2, “Constructed Types,” on page 3-39 on cycles in type definitions.

A name can be used in an unqualified form within a particular scope; it will be resolved by successively searching farther out in enclosing scopes, while taking into consideration inheritance relationships among interfaces. For example:

```
module M {
 typedef long ArgType;
 typedef ArgType AType; // line I1
 interface B {
 typedef string ArgType; // line I3
 ArgType opb(in AType i); // line I2
 };
};
```

```

module N {
 typedef char ArgType; // line I4
 interface Y : M::B {
 void opy(in ArgType i); // line I5
 };
};

```

The following scopes are searched for the declaration of **ArgType** used on **line I5**:

1. Scope of **N::Y** before the use of **ArgType**.
2. Scope of **N::Y**'s base interface **M::B**. (inherited scope)
3. Scope of **module N** before the definition of **N::Y**.
4. Global scope before the definition of **N**.

**M::B::ArgType** is found in **step 2** in **line I3**, and that is the definition that is used in **line I5**, hence **ArgType** in **line I5** is **string**. It should be noted that **ArgType** is not **char** in **line I5**. Now if **line I3** were removed from the definition of interface **M::B** then **ArgType** on **line I5** would be **char** from **line I4**, which is found in **step 3**.

Following analogous search steps for the types used in the operation **M::B::opb** on **line I2**, the type of **AType** used on **line I2** is **long** from the **typedef** in **line I1** and the return type **ArgType** is **string** from **line I3**.

### 3.20.3 Special Scoping Rules for Type Names

Once a type has been defined anywhere within the scope of a module, interface or valuetype, it may not be redefined except within the scope of a nested module, interface or valuetype, or within the scope of a derived interface or valuetype. For example:

```

typedef short TempType; // Scope of TempType begins here

module M {
 typedef string ArgType; // Scope of ArgType begins here
 struct S {
 ::M::ArgType a1; // Nothing introduced here
 M::ArgType a2; // M introduced here
 ::TempType temp; // Nothing introduced here
 }; // Scope of (introduced) M ends here
 // ...
}; // Scope of ArgType ends here

// Scope of global TempType ends here (at end of file)

```

The scope of an introduced type name is from the point of introduction to the end of its enclosing scope.



However, if a *type* name is *introduced* into a scope that is nested in a non-module scope definition, its *potential* scope extends over all its enclosing scopes out to the enclosing non-module scope. (For types that are defined outside an inon-module scope, the scope and the potential scope are identical.) For example:

```

module M {
 typedef long ArgType;
 const long I = 10;
 typedef short Y;

 interface A {
 struct S {
 struct T {
 ArgType x[I]; // ArgType and I introduced
 long y; // a new y is defined, the existing Y
 // is not used
 } m;
 };
 typedef string ArgType; // Error: ArgType redefined
 enum I { I1, I2 }; // Error: I redefined
 typedef short Y; // OK
 }; // Potential scope of ArgType and I ends here

 interface B : A {
 typedef long ArgType // OK, redefined in derived interface
 struct S { // OK, redefined in derived interface
 ArgType x; // x is a long
 A::ArgType y; // y is a string
 };
 };
};

```

A type may not be redefined within its scope or potential scope, as shown in the preceding example. This rule prevents type names from changing their meaning throughout a non-module scope definition, and ensures that reordering of definitions in the presence of introduced types does not affect the semantics of a specification.

Note that, in the following, the definition of **M::A::U::I** is legal because it is outside the potential scope of the I introduced in the definition of **M::A::S::T::ArgType**. However, the definition of **M::A::I** is still illegal because it is within the potential scope of the I introduced in the definition of **M::A::S::T::ArgType**.

```

module M {
 typedef long ArgType;
 const long I = 10;

 interface A {
 struct S {
 struct T {
 ArgType x[I]; // ArgType and I introduced
 } m;
 };
 };
};

```

```
};
struct U {
 long I; // OK, I is not a type name
};
enum I { I1, I2 }; // Error: I redefined
}; // Potential scope of ArgType and I ends here
};
```

Note that redefinition of a type after use in a module is OK as in the example:

```
typedef long ArgType;
module M {
 struct S {
 ArgType x; // x is a long
 };

 typedef string ArgType; // OK!
 struct T {
 ArgType y; // Ugly but OK, y is a string
 };
};
```

## Contents

This chapter contains the following sections.

| Section Title                                      | Page |
|----------------------------------------------------|------|
| “Overview”                                         | 4-1  |
| “The ORB Operations”                               | 4-2  |
| “Object Reference Operations”                      | 4-12 |
| “ValueBase Operations”                             | 4-23 |
| “ORB and OA Initialization and Initial References” | 4-24 |
| “Context Object”                                   | 4-32 |
| “Current Object”                                   | 4-36 |
| “Policy Object”                                    | 4-37 |
| “Management of Policies”                           | 4-43 |
| “Management of Policy Domains”                     | 4-46 |
| “TypeCodes”                                        | 4-52 |
| “Exceptions”                                       | 4-62 |

## 4.1 Overview

This chapter introduces the operations that are implemented by the ORB core, and describes some basic ones, while providing reference to the description of the remaining operations that are described elsewhere. The ORB interface is the interface to those ORB functions that do not depend on which object adapter is used. These

operations are the same for all ORBs and all object implementations, and can be performed either by clients of the objects or implementations. The Object interface contains operations that are implemented by the ORB, and are accessed as implicit operations of the Object Reference. The ValueBase interface contains operations that are implemented by the ORB, and are accessed as implicit operations of the ValueBase Reference.

Because the operations in this section are implemented by the ORB itself, they are not in fact operations on objects, although they are described that way for the Object or ValueBase interface operations and the language binding will, for consistency, make them appear that way.

## 4.2 The ORB Operations

The ORB interface contains the operations that are available to both clients and servers. These operations do not depend on any specific object adapter or any specific object reference.

```

module CORBA {

 interface NVList; // forward declaration
 interface OperationDef; // forward declaration
 interface TypeCode; // forward declaration

 typedef short PolicyErrorCode;

 // for the definition of consts see "PolicyErrorCode" on page 4-39

 typedef unsigned long PolicyType;

 interface Request; // forward declaration
 typedef sequence <Request> RequestSeq;

 native AbstractBase;

 exception PolicyError {PolicyErrorCode reason;};

 typedef string RepositoryId;
 typedef string Identifier;

 // StructMemberSeq defined in Chapter 10
 // UnionMemberSeq defined in Chapter 10
 // EnumMemberSeq defined in Chapter 10

 typedef unsigned short ServiceType;
 typedef unsigned long ServiceOption;
 typedef unsigned long ServiceDetailType;

 const ServiceType Security = 1;

```

```
struct ServiceDetail {
 ServiceDetailType service_detail_type;
 sequence <octet> service_detail;
};

struct ServiceInformation {
 sequence <ServiceOption> service_options;
 sequence <ServiceDetail> service_details;
};

native ValueFactory;

typedef string ORBid;

interface ORB {

 typedef string ObjectId;
 typedef sequence <ObjectId> ObjectIdList;

 exception InvalidName {};

 ORBid id();

 string object_to_string (
 in Object obj
);

 Object string_to_object (
 in string str
);

 // Dynamic Invocation related operations

 void create_list (
 in long count,
 out NVList new_list
);

 void create_operation_list (
 in OperationDef oper,
 out NVList new_list
);

 void get_default_context (
 out Context ctx
);

 void send_multiple_requests_oneway(
 in RequestSeq req
);
};
```

```
void send_multiple_requests_deferred(
 in RequestSeq req
);

boolean poll_next_response();

void get_next_response(
 out Request req
);

// Service information operations

boolean get_service_information (
 in ServiceType service_type,
 out ServiceInformation service_information
);

ObjectIdList list_initial_services ();

// Initial reference operation

Object resolve_initial_references (
 in ObjectId identifier
) raises (InvalidName);

// Type code creation operations

TypeCode create_struct_tc (
 in RepositoryId id,
 in Identifier name,
 in StructMemberSeq members
);

TypeCode create_union_tc (
 in RepositoryId id,
 in Identifier name,
 in TypeCode discriminator_type,
 in UnionMemberSeq members
);

TypeCode create_enum_tc (
 in RepositoryId id,
 in Identifier name,
 in EnumMemberSeq members
);

TypeCode create_alias_tc (
 in RepositoryId id,
 in Identifier name,
 in TypeCode original_type
);
```

```
TypeCode create_exception_tc (
 in RepositoryId id,
 in Identifier name,
 in StructMemberSeq members
);

TypeCode create_interface_tc (
 in RepositoryId id,
 in Identifier name
);

TypeCode create_string_tc (
 in unsigned long bound
);

TypeCode create_wstring_tc (
 in unsigned long bound
);

TypeCode create_fixed_tc (
 in unsigned short digits,
 in short scale
);

TypeCode create_sequence_tc (
 in unsigned long bound,
 in TypeCode element type
);

TypeCode create_recursive_sequence_tc (// deprecated
 in unsigned long bound,
 in unsigned long offset
);

TypeCode create_array_tc (
 in unsigned long length,
 in TypeCode element_type
);

TypeCode create_value_tc (
 in RepositoryId id,
 in Identifier name,
 in ValueModifier type_modifier,
 in TypeCode concrete_base,
 in ValueMembersSeq members
);

TypeCode create_value_box_tc (
 in RepositoryId id,
 in Identifier name,
 in TypeCode boxed_type
```

```
);
TypeCode create_native_tc (
 in RepositoryId id,
 in Identifier name
);
TypeCode create_recursive_tc(
 in RepositoryId id
);
TypeCode create_abstract_interface_tc(
 in RepositoryId id,
 in Identifier name
);
TypeCode create_local_interface_tc(
 in RepositoryId id,
 in Identifier name
);
TypeCode create_component_tc (
 in RepositoryId id,
 in Identifier name
);
TypeCode create_home_tc (
 in RepositoryId id,
 in Identifier name
);
TypeCode create_event_tc (
 in RepositoryId id,
 in Identifier name,
 in ValueModifier type_modifier,
 in TypeCode concrete_base,
 in ValueMemberSeq members
);

// Thread related operations

boolean work_pending();

void perform_work();

void run();

void shutdown(
 in boolean wait_for_completion
);
```



```

void destroy();

// Policy related operations

Policy create_policy(
 in PolicyType type,
 in any val
) raises (PolicyError);

// Dynamic Any related operations deprecated and removed
// from primary list of ORB operations

// Value factory operations

ValueFactory register_value_factory(
 in RepositoryId id,
 in ValueFactory_factory
);

void unregister_value_factory(in RepositoryId id);

ValueFactory lookup_value_factory(in RepositoryId id);

void register_initial_reference(
 in ObjectId id,
 in Object obj
) raises (InvalidName);
};
};

```

All types defined in this chapter are part of the CORBA module. When referenced in OMG IDL, the type names must be prefixed by “CORBA::”.

The operations **object\_to\_string** and **string\_to\_object** are described in “Converting Object References to Strings” on page 4-8.

For a description of the **create\_list** and **create\_operation\_list** operations, see Section 7.4, “Polling” on page 7-12. The **get\_default\_context** operation is described in Section 4.2.4.1, “get\_default\_context” on page 4-9. The **send\_multiple\_requests\_oneway** and **send\_multiple\_requests\_deferred** operations are described in Section 7.3.1, “send\_multiple\_requests” on page 7-11. The **poll\_next\_response** and **get\_next\_response** operations are described in Section 7.3.2, “get\_next\_response and poll\_next\_response” on page 7-11.

The **list\_initial\_services** and **resolve\_initial\_references** operations are described in Section 4.5.2, “Obtaining Initial Object References” on page 4-27.

The Type code creation operations with names of the form **create\_<type>\_tc** are described in Section 4.11.3, “Creating TypeCodes” on page 4-58.

The **work\_pending**, **perform\_work**, **shutdown**, **destroy** and **run** operations are described in Section 4.2.5, “Thread-Related Operations” on page 4-9.

The **create\_policy** operations is described in Section 4.8.2.3, “Create\_policy” on page 4-39.

The **register\_value\_factory**, **unregister\_value\_factory** and **lookup\_value\_factory** operations are described in Section 5.4.3, “Language Specific Value Factory Requirements” on page 5-9.

The **register\_initial\_reference** operation is described in Section 21.8.1, “register\_initial\_reference” on page 21-57

## 4.2.1 ORB Identity

### 4.2.1.1 *id*

**ORBid id();**

The **id** operation returns the identity of the ORB. The returned **ORBid** is the string that was passed to **ORB\_init** (see Section 4.5.1, “ORB Initialization” on page 4-24) as the **orb\_identifier** parameter when the ORB was created. If that was the empty string, the returned string is the value associated with the **-ORBid** tag in the **arg\_list** parameter. Calling **id** on the default ORB returns the empty string.

## 4.2.2 Converting Object References to Strings

### 4.2.2.1 *object\_to\_string*

**string object\_to\_string (**  
**in Object obj**  
**);**

### 4.2.2.2 *string\_to\_object*

**Object string\_to\_object (**  
**in string str**  
**);**

Because an object reference is opaque and may differ from ORB to ORB, the object reference itself is not a convenient value for storing references to objects in persistent storage or communicating references by means other than invocation. Two problems must be solved: allowing an object reference to be turned into a value that a client can store in some other medium, and ensuring that the value can subsequently be turned into the appropriate object reference.

An object reference may be translated into a string by the operation **object\_to\_string**. The value may be stored or communicated in whatever ways strings may be manipulated. Subsequently, the **string\_to\_object** operation will accept a string produced by **object\_to\_string** and return the corresponding object reference.

To guarantee that an ORB will understand the string form of an object reference, that ORB's **object\_to\_string** operation must be used to produce the string. For all conforming ORBs, if **obj** is a valid reference to an object, then **string\_to\_object(object\_to\_string(obj))** will return a valid reference to the same object, if the two operations are performed on the same ORB. For all conforming ORB's supporting IOP, this remains true even if the two operations are performed on different ORBs.

### 4.2.3 Getting Service Information

#### 4.2.3.1 *get\_service\_information*

```
boolean get_service_information (
 in ServiceType service_type;
 out ServiceInformation service_information;
);
```

The **get\_service\_information** operation is used to obtain information about CORBA facilities and services that are supported by this ORB. The service type for which information is being requested is passed in as the in parameter **service\_type**, the values defined by constants in the CORBA module. If service information is available for that type, that is returned in the out parameter **service\_information**, and the operation returns the value TRUE. If no information for the requested services type is available, the operation returns FALSE (i.e., the service is not supported by this ORB).

### 4.2.4 Creating a New Context

#### 4.2.4.1 *get\_default\_context*

```
void get_default_context(// PIDL
 out Context ctx // context object
);
```

This operation creates a new empty Context object every time it is called. The operation is defined in the **ORB** interface.

### 4.2.5 Thread-Related Operations

To support single-threaded ORBs, as well as multi-threaded ORBs that run multi-thread-unaware code, several operations are included in the ORB interface. These operations can be used by single-threaded and multi-threaded applications. An application that is a pure ORB client would not need to use these operations. Both the **ORB::run** and **ORB::shutdown** are useful in fully multi-threaded programs.

These operations are defined on the ORB rather than on an object adapter to allow the main thread to be used for all kinds of asynchronous processing by the ORB. Defining these operations on the ORB also allows the ORB to support multiple object adapters, without requiring the application main to know about all the object adapters. The interface between the ORB and an object adapter is not standardized.

#### 4.2.5.1 *work\_pending*

**boolean work\_pending( );**

This operation returns an indication of whether the ORB needs the main thread to perform some work.

A result of TRUE indicates that the ORB needs the main thread to perform some work and a result of FALSE indicates that the ORB does not need the main thread.

#### 4.2.5.2 *perform\_work*

**void perform\_work();**

If called by the main thread, this operation performs an implementation-defined unit of work; otherwise, it does nothing.

It is platform-specific how the application and ORB arrange to use compatible threading primitives.

The **work\_pending()** and **perform\_work()** operations can be used to write a simple polling loop that multiplexes the main thread among the ORB and other activities. Such a loop would most likely be needed in a single-threaded server. A multi-threaded server would need a polling loop only if there were both ORB and other code that required use of the main thread.

Here is an example of such a polling loop:

```
// C++
for (;;) {
 if (orb->work_pending()) {
 orb->perform_work();
 };
 // do other things
 // sleep?
};
```

Once the ORB has shutdown, **work\_pending** and **perform\_work** will raise the **BAD\_INV\_ORDER** exception with minor code 4. An application can detect this exception to determine when to terminate a polling loop.

#### 4.2.5.3 *run*

**void run();**

This operation provides execution resources to the ORB so that it can perform its internal functions. Single threaded ORB implementations, and some multi-threaded ORB implementations, need the use of the main thread in order to function properly. For maximum portability, an application should call either **run** or **perform\_work** on its main thread. **run** may be called by multiple threads simultaneously.

This operation will block until the ORB has completed the shutdown process, initiated when some thread calls **shutdown**.

#### 4.2.5.4 *shutdown*

```
void shutdown(
 in boolean wait_for_completion
);
```

This operation instructs the ORB to shut down, that is, to stop processing in preparation for destruction.

Shutting down the ORB causes all object adapters to be destroyed, since they cannot exist in the absence of an ORB.

In the case of the **POA**, all **POAManagers** are deactivated prior to destruction of all POAs. The deactivation that the ORB performs should be the equivalent of calling deactivate with the value **TRUE** for **etherealize\_objects** and with the **wait\_for\_completion** parameter same as what **shutdown** was called with.

Shut down is complete when all ORB processing (including request processing and object deactivation or other operations associated with object adapters) has completed and the object adapters have been destroyed. In the case of the **POA**, this means that all object etherealizations have finished and root **POA** has been destroyed (implying that all descendent **POAs** have also been destroyed).

If the **wait\_for\_completion** parameter is **TRUE**, this operation blocks until the shut down is complete. If an application does this in a thread that is currently servicing an invocation, the ORB will not shutdown, and the **BAD\_INV\_ORDER** system exception will be raised with the OMG minor code 3, and completion status **COMPLETED\_NO**, since blocking would result in a deadlock.

If the **wait\_for\_completion** parameter is **FALSE**, then **shutdown** may not have completed upon return. An ORB implementation may require the application to call (or have a pending call to) **run** or **perform\_work** after **shutdown** has been called with its parameter set to **FALSE**, in order to complete the shutdown process.

Additionally in systems that have Portable Object Adapters (see Chapter 11) **shutdown** behaves as if **POA::destroy** is called on the Root **POA** with its first parameter set to **TRUE** and the second parameter set to the value of the **wait\_for\_completion** parameter that **shutdown** is invoked with.

While the ORB is in the process of shutting down, the ORB operates as normal, servicing incoming and outgoing requests until all requests have been completed. An implementation may impose a time limit for requests to complete while a **shutdown** is pending.

Once an ORB has shutdown, only object reference management operations(**duplicate**, **release** and **is\_nil**) may be invoked on the ORB or any object reference obtained from it. An application may also invoke the destroy operation on the ORB itself. Invoking any other operation will raise the **BAD\_INV\_ORDER** system exception with the OMG minor code 4.

#### 4.2.5.5 *destroy*

```
void destroy();
```

This operation destroys the ORB so that its resources can be reclaimed by the application. Any operation invoked on a destroyed ORB reference will raise the **OBJECT\_NOT\_EXIST** exception. Once an ORB has been destroyed, another call to **ORB\_init** with the same **ORBid** will return a reference to a newly constructed ORB.

If **destroy** is called on an ORB that has not been shut down, it will start the shut down process and block until the ORB has shut down before it destroys the ORB. The behavior is similar to that achieved by calling **shutdown** with the **wait\_for\_completion** parameter set to **TRUE**. If an application calls **destroy** in a thread that is currently servicing an invocation, the **BAD\_INV\_ORDER** system exception will be raised with the OMG minor code 3, since blocking would result in a deadlock.

For maximum portability and to avoid resource leaks, an application should always call **shutdown** and **destroy** on all ORB instances before exiting.

### 4.3 *Object Reference Operations*

There are some operations that can be done on any object. These are not operations in the normal sense, in that they are implemented directly by the ORB, not passed on to the object implementation. We will describe these as being operations on the object reference, although the interfaces actually depend on the language binding. As above, where we used interface **Object** to represent the object reference, we define an interface for **Object**:

```
module CORBA {

 interface DomainManager; // forward declaration
 typedef sequence <DomainManager> DomainManagersList;

 interface Policy;
 typedef sequence <Policy> PolicyList;
 typedef sequence<PolicyType> PolicyTypeSeq;
 exception InvalidPolicies { sequence <unsigned short> indices; };

 interface Context;
 // forward declaration

 typedef string Identifier;

```

```

interface Request; // forward declaration
interface NVList; // forward declaration
struct NamedValue{}; // an implicitly well known type
typedef unsigned long Flags;
interface InterfaceDef;

enum SetOverrideType {SET_OVERRIDE, ADD_OVERRIDE};

interface Object { // PIDL

 InterfaceDef get_interface ();

 boolean is_nil();

 Object duplicate ();

 void release ();

 boolean is_a (
 in RepositoryId logical_type_id
);

 boolean non_existent();

 boolean is_equivalent (
 in Object other_object
);

 unsigned long hash(
 in unsigned long maximum
);

 void create_request (
 in Context ctx
 in Identifier operation,
 in NVList arg_list,
 inout NamedValue result,
 out Request request,
 in Flags req_flag
);

 Policy get_policy (
 in PolicyType policy_type
);

 DomainManagersList get_domain_managers ();

 Object set_policy_overrides(
 in PolicyList policies,
 in SetOverrideType set_add
) raises (InvalidPolicies);

```

```
 Policy get_client_policy(
 in PolicyType type
);

 PolicyList get_policy_overrides(
 in PolicyTypeSeq types
);

 boolean validate_connection(
 out PolicyList inconsistent_policies
);

 Object get_component ();
};
```

The **create\_request** operation is part of the Object interface because it creates a pseudo-object (a Request) for an object. It is described with the other Request operations in the section Section 7.2, “Request Operations” on page 7-4.

Unless otherwise stated below, the operations in the IDL above do not require access to remote information.

### 4.3.1 Determining the Object Interface

#### 4.3.1.1 *get\_interface*

```
InterfaceDef get_interface();
```

**get\_interface**, returns an object in the Interface Repository that describes the most derived type of the object addressed by the reference. See the Interface Repository chapter for a definition of operations on the Interface Repository. The implementation of this operation may involve contacting the ORB that implements the target object.

If the interface repository is not available, **get\_interface** raises INTF\_REPOS with standard minor code 1. If the interface repository does not contain an entry for the object's (most derived) interface, **get\_interface** raises INTF\_REPOS with standard minor code 2.

### 4.3.2 Duplicating and Releasing Copies of Object References

#### 4.3.2.1 *duplicate*

```
Object duplicate();
```

#### 4.3.2.2 *release*

```
void release();
```



Because object references are opaque and ORB-dependent, it is not possible for clients or implementations to allocate storage for them. Therefore, there are operations defined to copy or release an object reference.

If more than one copy of an object reference is needed, the client may create a duplicate. Note that the object implementation is not involved in creating the duplicate, and that the implementation cannot distinguish whether the original or a duplicate was used in a particular request.

When an object reference is no longer needed by a program, its storage may be reclaimed by use of the **release** operation. Note that the object implementation is not involved, and that neither the object itself nor any other references to it are affected by the **release** operation.

### 4.3.3 Nil Object References

#### 4.3.3.1 *is\_nil*

```
boolean is_nil();
```

An object reference whose value is **OBJECT\_NIL** denotes no object. An object reference can be tested for this value by the **is\_nil** operation. The object implementation is not involved in the nil test.

### 4.3.4 Equivalence Checking Operation

#### 4.3.4.1 *is\_a*

```
boolean is_a(

 in RepositoryId logical_type_id

);
```

An operation is defined to facilitate maintaining type-safety for object references over the scope of an ORB.

The **logical\_type\_id** is a string denoting a shared type identifier (**RepositoryId**). The operation returns true if the object is really an instance of that type, including if that type is an ancestor of the “most derived” type of that object.

Determining whether an object's type is compatible with the **logical\_type\_id** may require contacting a remote ORB or interface repository. Such an attempt may fail at either the local or the remote end. If **is\_a** cannot make a reliable determination of type compatibility due to failure, it raises an exception in the calling application code. This enables the application to distinguish among the **TRUE**, **FALSE**, and indeterminate cases.

This operation exposes to application programmers functionality that must already exist in ORBs that support “type safe narrow” and allows programmers working in environments that do not have compile time type checking to explicitly maintain type safety.

This operation always returns **TRUE** for the **logical\_type\_id**  
**IDL:omg.org/CORBA/Object:1.0**

### 4.3.5 *Probing for Object Non-Existence*

#### 4.3.5.1 *non\_existent*

**boolean non\_existent ();**

The **non\_existent** operation may be used to test whether an object (e.g., a proxy object) has been destroyed. It does this without invoking any application level operation on the object, and so will never affect the object itself. It returns true (rather than raising **CORBA::OBJECT\_NOT\_EXIST**) if the ORB knows authoritatively that the object does not exist; otherwise, it returns false.

Services that maintain state that includes object references, such as bridges, event channels, and base relationship services, might use this operation in their “idle time” to sift through object tables for objects that no longer exist, deleting them as they go, as a form of garbage collection. In the case of proxies, this kind of activity can cascade, such that cleaning up one table allows others then to be cleaned up.

Probing for object non-existence may require contacting the ORB that implements the target object. Such an attempt may fail at either the local or the remote end. If non-existent cannot make a reliable determination of object existence due to failure, it raises an exception in the calling application code. This enables the application to distinguish among the true, false, and indeterminate cases.

### 4.3.6 *Object Reference Identity*

In order to efficiently manage state that include large numbers of object references, services need to support a notion of object reference identity. Such services include not just bridges, but relationship services and other layered facilities.

Two identity-related operations are provided. One maps object references into disjoint groups of potentially equivalent references, and the other supports more expensive pairwise equivalence testing. Together, these operations support efficient maintenance and search of tables keyed by object references.

#### 4.3.6.1 *Hashing Object Identifiers*

**hash**

**unsigned long hash(**

```

 in unsigned long maximum
);

```

Object references are associated with ORB-internal identifiers that may indirectly be accessed by applications using the **hash** operation. The value of this identifier does not change during the lifetime of the object reference, and so neither will any hash function of that identifier.

The value of this operation is not guaranteed to be unique; that is, another object reference may return the same hash value. However, if two object references hash differently, applications can determine that the two object references are *not* identical.

The **maximum** parameter to the **hash** operation specifies an upper bound on the hash value returned by the ORB. The lower bound of that value is zero. Since a typical use of this feature is to construct and access a collision chained hash table of object references, the more randomly distributed the values are within that range, and the cheaper those values are to compute, the better.

For bridge construction, note that proxy objects are themselves objects, so there could be many proxy objects representing a given “real” object. Those proxies would not necessarily hash to the same value.

#### 4.3.6.2 *Equivalence Testing*

*is\_equivalent*

```

 boolean is_equivalent(
 in Object other_object
);

```

The **is\_equivalent** operation is used to determine if two object references are equivalent, so far as the ORB can easily determine. It returns TRUE if the target object reference is known to be equivalent to the other object reference passed as its parameter, and FALSE otherwise.

If two object references are identical, they are equivalent. Two different object references that in fact refer to the same object are also equivalent.

ORBs are allowed, but not required, to attempt determination of whether two distinct object references refer to the same object. In general, the existence of reference translation and encapsulation, in the absence of an omniscient topology service, can make such determination impractically expensive. This means that a FALSE return from **is\_equivalent** should be viewed as only indicating that the object references are distinct, and not necessarily an indication that the references indicate distinct objects. Setting of local policies on the object reference is not taken into consideration for the purposes of determining object reference equivalence.

A typical application use of this operation is to match object references in a hash table. Bridges could use it to shorten the lengths of chains of proxy object references. Externalization services could use it to “flatten” graphs that represent cyclical relationships between objects. Some might do this as they construct the table, others during idle time.

### 4.3.7 Type Coercion Considerations

Many programming languages map **Object** to programming constructs that support inheritance. Mappings to languages (such as C++ and Java) typically provide a mechanism for narrowing (down-casting) an object reference from a base interface to a more derived interface. To do such down-casting in a type safe way, knowledge of the full inheritance hierarchy of the target interface may be required. The implementation of down-cast must either contact an interface repository or the target itself, to determine whether or not it is safe to down-cast the client’s object reference. This requirement is not acceptable when a client is expecting only asynchronous communication with the target. Therefore, for the appropriate languages an unchecked down-cast operation (also referred to as unchecked narrow operation) shall be provided in the mapping of **Object**. This unchecked narrow always returns a stub of the requested type without checking that the target really implements that interface.

### 4.3.8 Getting Policy Associated with the Object

#### 4.3.8.1 *get\_policy*

The **get\_policy** operation returns the policy object of the specified type (see Section 4.8, “Policy Object” on page 4-37), which applies to this object. It returns the *effective Policy* for the object reference. The effective **Policy** is the one that would be used if a request were made.

This **Policy** is determined first by obtaining the effective override for the **PolicyType** as returned by **get\_client\_policy**. The effective override is then compared with the **Policy** as specified in the **IOR**. The effective **Policy** is determined by reconciling the effective override and the **IOR**-specified **Policy** (see Section 4.9.2, “Server Side Policy Management” on page 4-44). If the two policies cannot be reconciled, the standard system exception **INV\_POLICY** is raised with standard minor code 1. The absence of a **Policy** value in the **IOR** implies that any legal value may be used.

Invoking **non\_existent** on an object reference prior to **get\_policy** ensures the accuracy of the returned effective **Policy**. If **get\_policy** is invoked prior to the object reference being bound, the returned effective **Policy** is implementation dependent. In that situation, a compliant implementation may do any of the following: raise the standard system exception **BAD\_INV\_ORDER**, return some value for that **PolicyType** which may be subject to change once a binding is performed, or attempt a binding and then return the effective **Policy**. Note that if the effective **Policy** may change from invocation to invocation due to transparent rebinding.

**Policy get\_policy (**

```

 in PolicyType policy_type
);

```

**Parameter(s)**

**policy\_type** - The type of policy to be obtained.

**Return Value**

A **Policy** object of the type specified by the **policy\_type** parameter.

**Exception(s)**

**CORBA::INV\_POLICY** - raised when the value of policy type is not valid either because the specified type is not supported by this ORB or because a policy object of that type is not associated with this Object.

The implementation of this operation may involve remote invocation of an operation (e.g., **DomainManager::get\_domain\_policy** for some security policies) for some policy types.

#### 4.3.8.2 *get\_client\_policy*

```

 Policy get_client_policy(
 in PolicyType type
);

```

Returns the *effective overriding* **Policy** for the object reference. The effective override is obtained by first checking for an override of the given **PolicyType** at the **Object** scope, then at the **Current** scope, and finally at the ORB scope. If no override is present for the requested **PolicyType**, the system-dependent default value for that **PolicyType** is used. Portable applications are expected to set the desired “defaults” at the ORB scope since default **Policy** values are not specified.

#### 4.3.8.3 *get\_policy\_overrides*

```

 PolicyList get_policy_overrides(
 in PolicyTypeSeq types
);

```

Returns the list of **Policy** overrides (of the specified policy types) set at the **Object** scope. If the specified sequence is empty, all **Policy** overrides at this scope will be returned. If none of the requested **PolicyTypes** are overridden at the **Object** scope, an empty sequence is returned.

### 4.3.9 Overriding Associated Policies on an Object Reference

#### 4.3.9.1 *set\_policy\_overrides*

The **set\_policy\_overrides** operation returns a new object reference with the new policies associated with it. It takes two input parameters. The first parameter **policies** is a sequence of references to **Policy** objects. The second parameter **set\_add** of type **SetOverrideType** indicates whether these policies should be added onto any other overrides that already exist (**ADD\_OVERRIDE**) in the object reference, or they should be added to a clean override free object reference (**SET\_OVERRIDE**). This operation associates the policies passed in the first parameter with a newly created object reference that it returns. Only certain policies that pertain to the invocation of an operation at the client end can be overridden using this operation. Attempts to override any other policy will result in the raising of the **CORBA::NO\_PERMISSION** exception.

```
enum SetOverrideType {SET_OVERRIDE, ADD_OVERRIDE};
```

```
Object set_policy_overrides(
 in PolicyList policies,
 in SetOverrideType set_add
) raises (InvalidPolicies);
```

#### *Parameter(s)*

**policies** - a sequence of **Policy** objects that are to be associated with the new copy of the object reference returned by this operation. If the sequence contains two or more **Policy** objects with the same **PolicyType** value, the operation raises the standard system exception **BAD\_PARAM** with minor code 30.

**set\_add** - whether the association is in addition to (**ADD\_OVERRIDE**) or as a replacement of (**SET\_OVERRIDE**) any existing overrides already associated with the object reference. If the value of this parameter is **SET\_OVERRIDE**, the supplied **policies** completely replace all existing overrides associated with the object reference. If the value of this parameter is **ADD\_OVERRIDE**, the supplied **policies** are added to the existing overrides associated with the object reference, except that if a supplied **Policy** object has the same **PolicyType** value as an existing override, the supplied **Policy** object replaces the existing override.

#### *Return Value*

A copy of the object reference with the overrides from **policies** associated with it in accordance with the value of **set\_add**.

#### *Exception(s)*

**InvalidPolicies** - raised when an attempt is made to override any policy that cannot be overridden.

### 4.3.10 Validating Connection

#### 4.3.10.1 *validate\_connection*

```

boolean validate_connection(
 out PolicyList inconsistent_policies
);

```

Returns the value TRUE if the current effective policies for the **Object** will allow an invocation to be made. If the object reference is not yet bound, a binding will occur as part of this operation. If the object reference is already bound, but current policy overrides have changed or for any other reason the binding is no longer valid, a rebind will be attempted regardless of the setting of any **RebindPolicy** override. The **validate\_connection** operation is the only way to force such a rebind when implicit rebinds are disallowed by the current effective **RebindPolicy**. The attempt to bind or rebind may involve processing GIOP LocateRequests by the ORB.

Returns the value FALSE if the current effective policies would cause an invocation to raise the standard system exception **INV\_POLICY**. If the current effective policies are incompatible, the out parameter **inconsistent\_policies** contains those policies causing the incompatibility. This returned list of policies is not guaranteed to be exhaustive. If the binding fails due to some reason unrelated to policy overrides, the appropriate standard system exception is raised.

### 4.3.11 Getting the Domain Managers Associated with the Object

#### 4.3.11.1 *get\_domain\_managers*

The **get\_domain\_managers** operation allows administration services (and applications) to retrieve the domain managers (see Section 4.9, “Management of Policies” on page 4-43), and hence the security and other policies applicable to individual objects that are members of the domain.

```

typedef sequence <DomainManager> DomainManagersList;

DomainManagersList get_domain_managers ();

```

#### *Return Value*

The list of immediately enclosing domain managers of this object. At least one domain manager is always returned in the list since by default each object is associated with at least one domain manager at creation.

The implementation of this operation may involve contacting the ORB that implements the target object.

### 4.3.12 Getting Component Associated with the Object

#### 4.3.12.1 *get\_component*

##### **Object get\_component ();**

If the target object reference is itself a component reference (i.e., it denotes the component itself), the **get\_component** operation returns the same reference (or another equivalent reference). If the target object reference is a facet reference the **get\_component** operation returns an object reference for the component. If the target reference is neither a component reference nor a provided reference, **get\_component** returns a nil reference.

### 4.3.13 LocalObject Operations

Local interfaces are implemented by using **CORBA::LocalObject**, which derives from **CORBA::Object** and provides implementations of Object pseudo operations and any other ORB specific support mechanisms that are appropriate for such objects. Object implementation techniques are inherently language mapping specific. Therefore, the **LocalObject** type is not defined in IDL, but is specified by each language mapping.

- The **LocalObject** type provides implementations of the following **Object** pseudo-operations that raise the **NO\_IMPLEMENT** system exception with standard minor code 3:
  - **get\_interface**
  - **get\_domain\_managers**
  - **get\_policy**
  - **get\_client\_policy**
  - **set\_policy\_overrides**
  - **get\_policy\_overrides**
  - **validate\_connection**
  - **get\_component**
- The **LocalObject** type provides implementations of the following pseudo-operations:
  - **non\_existent** - always returns false.
  - **hash** - returns a hash value that is consistent for the lifetime of the object.
  - **is\_equivalent** - returns true if the references refer to the same **LocalObject** implementation.
  - **is\_a** - returns **TRUE** if the **LocalObject** derives from or is itself the type specified by the **logical\_type\_id** argument.
- Attempting to use a **LocalObject** to create a DII request shall result in a **NO\_IMPLEMENT** system exception with standard minor code 4. Attempting to marshal or stringify a **LocalObject** shall result in a **MARSHAL** system exception with standard minor code 4. Narrowing and widening of references to **LocalObjects** must work as for regular object references.



- Local types cannot be marshaled and references to local objects cannot be converted to strings. Any attempt to marshal a local object, such as via an unconstrained base interface, as an **Object**, or as the contents of an **any**, or to pass a local object to **ORB::object\_to\_string**, shall result in a **MARSHAL** system exception with OMG minor code 4.
- The DII is not supported on local objects, nor are asynchronous invocation interfaces.
- Language mappings shall specify server side mechanisms, including base classes and/or skeletons if necessary, for implementing local objects, so that invocation overhead is minimized.
- The usage of client side language mappings for local types shall be identical to those of equivalent unconstrained types.
- Invocations on local objects are not ORB mediated. Specifically, parameter copy semantics are not honored, interceptors are not invoked, and the execution context of a local object does not have ORB service **Current** object contexts that are distinct from those of the caller. Implementations of local interfaces are responsible for providing the parameter copy semantics expected by clients.
- Local objects have no inherent identities beyond their implementations' identities as programming objects. The lifecycle of the implementation is the same as the lifecycle of the reference.
- Instances of local objects defined as part of OMG specifications to be supplied by ORB products or object service products shall be exposed through the **ORB::resolve\_initial\_references** operation or through some other local object obtained from **resolve\_initial\_references**.

#### 4.4 ValueBase Operations

**ValueBase** serves a similar role for value types that **Object** serves for interfaces. Its mapping is language-specific and must be explicitly specified for each language.

Typically it is mapped to a concrete language type which serves as a base for all value types. Any operations that are required to be supported for all values are conceptually defined on **ValueBase**, although in reality their actual mapping depends upon the specifics of any particular language mapping.

Analogous to the definition of the **Object** interface for implicit operations of object references, the implicit operations of **ValueBase** are defined on a pseudo-**valuetype** as follows:

```

module CORBA {
 valuetype ValueBase{ PIDL
 ValueDef get_value_def();
 };
};

```

The **get\_value\_def()** operation returns a description of the value's definition as described in the interface repository (Section 10.5.31, "ValueDef" on page 10-44).

## 4.5 ORB and OA Initialization and Initial References

Before an application can enter the CORBA environment, it must first:

- Be initialized into the ORB and possibly the object adapter (POA) environments.
- Get references to ORB pseudo-object (for use in future ORB operations) and perhaps other objects (including the root POA or some Object Adapter objects).

The following operations are provided to initialize applications and obtain the appropriate object references:

- Operations providing access to the ORB. These operations reside in the CORBA module, but not in the ORB interface and are described in Section 4.5.1, “ORB Initialization” on page 4-24.
- Operations providing access to Object Adapters, Interface Repository, Naming Service, and other Object Services. These operations reside in the ORB interface and are described in Section 4.5.2, “Obtaining Initial Object References” on page 4-27.

### 4.5.1 ORB Initialization

When an application requires a CORBA environment it needs a mechanism to get the ORB pseudo-object reference and possibly an OA object reference (such as the root POA). This serves two purposes. First, it initializes an application into the ORB and OA environments. Second, it returns the ORB pseudo-object reference and the OA object reference to the application for use in future ORB and OA operations.

The ORB and OA initialization operations must be ordered with ORB occurring before OA: an application cannot call OA initialization routines until ORB initialization routines have been called for the given ORB. The operation to initialize an application in the ORB and get its pseudo-object reference is not performed on an object. This is because applications do not initially have an object on which to invoke operations. The ORB initialization operation is an application’s bootstrap call into the CORBA world. The **ORB\_init** call is part of the CORBA module but not part of the ORB interface.

Applications can be initialized in one or more ORBs. When an ORB initialization is complete, its pseudo reference is returned and can be used to obtain other references for that ORB.

In order to obtain an ORB pseudo-object reference, applications call the **ORB\_init** operation. The parameters to the call comprise an identifier for the ORB for which the pseudo-object reference is required, and an **arg\_list**, which is used to allow environment-specific data to be passed into the call. PIDL for the ORB initialization is as follows:

```
// PIDL
module CORBA {
 typedef sequence <string> arg_list;
 ORB ORB_init (inout arg_list argv, in ORBid orb_identifier);
};
```

The identifier for the ORB will be a name of type **CORBA::ORBId**. All **ORBId** strings other than the empty string are allocated by ORB administrators and are not managed by the OMG. ORB administration is the responsibility of each ORB supplier. ORB suppliers may optionally delegate this responsibility. **ORBId** strings other than the empty string are intended to be used to uniquely identify each ORB used within the same address space in a multi-ORB application. These special **ORBId** strings are specific to each ORB implementation and the ORB administrator is responsible for ensuring that the names are unambiguous.

If an empty **ORBId** string is passed to **ORB\_init**, then the **arg\_list** arguments shall be examined to determine if they indicate an ORB reference that should be returned. This is achieved by searching the **arg\_list** parameters for one preceded by “**-ORBId**” for example, “**-ORBId example\_orb**” (the white space after the “**-ORBId**” tag is ignored) or “**-ORBIdMyFavoriteORB**” (with no white space following the “**-ORBId**” tag). Alternatively, two sequential parameters with the first being the string “**-ORBId**” indicates that the second is to be treated as an **ORBId** parameter. If an empty string is passed and no **arg\_list** parameters indicate the ORB reference to be returned, the default ORB for the environment will be returned.

Other parameters of significance to the ORB can also be identified in **arg\_list**, for example, “**Hostname**,” “**SpawnedServer**,” and so forth. To allow for other parameters to be specified without causing applications to be re-written, it is necessary to specify the parameter format that ORB parameters may take. In general, parameters shall be formatted as either one single **arg\_list** parameter:

**-ORB<suffix><optional white space> <value>**

or as two sequential **arg\_list** parameters:

**-ORB<suffix>**

**<value>**

Regardless of whether an empty or non-empty **ORBId** string is passed to **ORB\_init**, the **arg\_list** arguments are examined to determine if any ORB parameters are given. If a non-empty **ORBId** string is passed to **ORB\_init**, all **ORBId** parameters in the **arg\_list** are ignored. All other **-ORB<suffix>** parameters in the **arg\_list** may be of significance during the ORB initialization process.

Before **ORB\_init** returns, it will remove from the **arg\_list** parameter all strings that match the **-ORB<suffix>** pattern described above and that are recognized by that ORB implementation, along with any associated sequential parameter strings. If any strings in **arg\_list** that match this pattern are not recognized by the ORB implementation, **ORB\_init** will raise the **BAD\_PARAM** system exception instead.

The **ORB\_init** operation may be called any number of times and shall return the same ORB reference when the same **ORBId** string is passed, either explicitly as an argument to **ORB\_init** or through the **arg\_list**. All other **-ORB<suffix>** parameters in the **arg\_list** may be considered on subsequent calls to **ORB\_init**.

**Note** – Whenever an **ORB\_init** argument of the form **-ORBxxx** is specified, it is understood that the argument may be represented in different ways in different languages. For example, in Java **-ORBxxx** is equivalent to a property named **org.omg.CORBA.ORBxxx**.

---

#### 4.5.1.1 *Server ID*

A Server ID must uniquely identify a server to an IMR. This specification only requires unique identification using a string of some kind. We do not intend to make more specific requirements for the structure of a server ID.

The server ID may be specified by an **ORB\_init** argument of the form

**-ORBServerId**

The value assigned to this property is a **string**. All templates created in this **ORB** will return this server ID in the **server\_id** attribute.

It is required that all ORBs in the same server share the same server ID. Specific environments may choose to implement **-ORBServerId** in ways that automatically enforce this requirement.

For example, the **org.omg.CORBA.ServerId** system property may be set to the server ID in Java when a Java server is activated. This system property is then picked up as part of the **ORB\_init** call for every **ORB** created in the server.

#### 4.5.1.2 *Server Endpoint*

The server endpoint information is passed into **ORB\_init** by an argument of the form

**-ORBListenEndpoints <endpoints>**

The format of the <endpoints> argument is proprietary. All that is required by this specification is that each time **ORB\_init** is called with the same value for this argument, the resulting **ORB** will listen for requests on the same set of endpoints, so that persistent object references for the **ORB** will continue to function correctly.

#### 4.5.1.3 *Starting Servers with No Proprietary Server Activation Support*

Any server started with the flag:

**-ORBNoProprietaryActivation**

shall avoid the use of any proprietary activation framework.

### 4.5.2 Obtaining Initial Object References

Applications require a portable means by which to obtain their initial object references. References are required for the root POA, POA Current, Interface Repository and various Object Services instances. (The POA is described in the Portable Object Adapter chapter; the Interface Repository is described in the Interface Repository chapter; Object Services are described in the individual service specifications.) The functionality required by the application is similar to that provided by the Naming Service. However, the OMG does not want to mandate that the Naming Service be made available to all applications in order that they may be portably initialized. Consequently, the operations shown in this section provide a simplified, local version of the Naming Service that applications can use to obtain a small, defined set of object references that are essential to its operation. Because only a small well-defined set of objects are expected with this mechanism, the naming context can be flattened to be a single-level name space. This simplification results in only two operations being defined to achieve the functionality required.

Initial references are not obtained via a new interface; instead two operations are provided in the ORB pseudo-object interface, providing facilities to list and resolve initial object references.

#### *list\_initial\_services*

```
typedef string ObjectId;
typedef sequence <ObjectId> ObjectIdList;
ObjectIdList list_initial_services ();
```

#### *resolve\_initial\_references*

```
exception InvalidName {};

Object resolve_initial_references (
 in ObjectId identifier
) raises (InvalidName);
```

The **resolve\_initial\_references** operation is an operation on the ORB rather than the Naming Service's **NamingContext**. The interface differs from the Naming Service's **resolve** in that **ObjectId** (a string) replaces the more complex Naming Service construct (a sequence of structures containing string pairs for the components of the name). This simplification reduces the name space to one context.

**ObjectIds** are strings that identify the object whose reference is required. To maintain the simplicity of the interface for obtaining initial references, only a limited set of objects are expected to have their references found via this route. Unlike the ORB identifiers, the **ObjectId** name space requires careful management. To achieve this, the OMG may, in the future, define which services are required by applications through this interface and specify names for those services.

**resolve\_initial\_references** never returns a **nil** reference. Instead, the non-availability of a particular reference is indicated by throwing an **InvalidName** exception (even if a **nil** reference is explicitly configured for an **ObjectId**).

Currently, reserved **ObjectIds** are **RootPOA**, **POACurrent**, **InterfaceRepository**, **NameService**, **TradingService**, **SecurityCurrent**, **TransactionCurrent**, **DynAnyFactory**, **ORBPolicyManager**, **PolicyCurrent**, **NotificationService**, **TypedNotificationService**, **CodecFactory**, **PICurrent**, **ComponentHomeFinder** and **PSS**.

Table 4-1 ObjectIds for resolve\_initial\_references

| ObjectId                        | Type of Object Reference                                          | Reference                                                                                               |
|---------------------------------|-------------------------------------------------------------------|---------------------------------------------------------------------------------------------------------|
| <b>RootPOA</b>                  | <b>PortableServer::POA</b>                                        | Section 11.3.9, “POA Interface” on page 11-34                                                           |
| <b>POACurrent</b>               | <b>PortableServer::Current</b>                                    | Section 11.3.9, “POA Interface” on page 11-34                                                           |
| <b>InterfaceRepository</b>      | <b>CORBA::Repository</b><br><b>CORBA::ComponentIR::Repository</b> | Section 10.5.6, “Repository” on page 10-22<br>Section 10.6.2, “ComponentIR::Repository” on page 10-52   |
| <b>NameService</b>              | <b>CosNaming::NamingContext</b>                                   | <i>Naming Service</i> specification (formal/01-02-65), the CosNaming Module section.                    |
| <b>TradingService</b>           | <b>CosTrading::Lookup</b>                                         | <i>Trading Object Service</i> specification (formal/00-06-27), the Functional Interfaces section.       |
| <b>SecurityCurrent</b>          | <b>SecurityLevel1::Current</b> or <b>SecurityLevel2::Current</b>  | <i>Security Service</i> specification (formal/02-03-11), the Security Operations on Current section.    |
| <b>TransactionCurrent</b>       | <b>CosTransaction::Current</b>                                    | <i>Transaction Service</i> specification (formal/01-11-03), the Transaction Service Interfaces section. |
| <b>DynAnyFactory</b>            | <b>DynamicAny::DynAnyFactory</b>                                  | Section 9.2.1, “Creating a DynAny Object” on page 9-9                                                   |
| <b>ORBPolicyManager</b>         | <b>CORBA::PolicyManager</b>                                       | Section 4.9.3, “Policy Management Interfaces” on page 4-44                                              |
| <b>PolicyCurrent</b>            | <b>CORBA::PolicyCurrent</b>                                       | Section 4.9.3, “Policy Management Interfaces” on page 4-44                                              |
| <b>NotificationService</b>      | <b>CosNotifyChannelAdmin::EventChannelFactory</b>                 | <i>Notification Service</i> specification (formal/00-06-20)                                             |
| <b>TypedNotificationService</b> | <b>CosTypedNotifyChannelAdmin::TypedEventChannelFactory</b>       | <i>Notification Service</i> specification (formal/00-06-20)                                             |

Table 4-1 ObjectIds for resolve\_initial\_references

| ObjectId            | Type of Object Reference              | Reference                                                              |
|---------------------|---------------------------------------|------------------------------------------------------------------------|
| CodecFactory        | IOP::CodecFactory                     | Section 13.8.2, “Codec Factory” on page 13-34                          |
| PICurrent           | PortableInterceptors::Current         | Section 21.4.3, “Portable Interceptor Current Interface” on page 21-34 |
| ComponentHomeFinder | Components::HomeFinder                | CORBA Components specification.                                        |
| PSS                 | CosPersistentState::ConnectorRegistry | Persistent State specification (ptc/01-12-02).                         |

To allow an application to determine which objects have references available via the initial references mechanism, the **list\_initial\_services** operation (also a call on the ORB) is provided. It returns an **ObjectIdList**, which is a sequence of **ObjectIds**. **ObjectIds** are typed as strings. Each object, which may need to be made available at initialization time, is allocated a string value to represent it. In addition to defining the id, the type of object being returned must be defined; that is, “**InterfaceRepository**” returns an object of type **Repository**, or **ComponentIR::Repository**, which is derived from **Repository**, depending on whether the ORB supports components or not, and “**NameService**” returns a **CosNaming::NamingContext** object.

The application is responsible for narrowing the object reference returned from **resolve\_initial\_references** to the type that was requested in the ObjectId. For example, for **InterfaceRepository** the object returned would be narrowed to **Repository** type or **ComponentIR::Repository** type, depending on whether the ORB supports components.

Specifications for Object Services (see individual service specifications) state whether it is expected that a service’s initial reference be made available via the **resolve\_initial\_references** operation or not; that is, whether the service is necessary or desirable for bootstrap purposes.

### 4.5.3 Configuring Initial Service References

#### 4.5.3.1 ORB-specific Configuration

It is required that an ORB can be administratively configured to return an arbitrary object reference from **CORBA::ORB::resolve\_initial\_references** for non-locality-constrained objects.

In addition to this required implementation-specific configuration, two **CORBA::ORB\_init** arguments are provided to override the ORB initial reference configuration.

### 4.5.3.2 *ORBInitRef*

The ORB initial reference argument, **-ORBInitRef**, allows specification of an arbitrary object reference for an initial service. The format is:

**-ORBInitRef <ObjectID>=<ObjectURL>**

Examples of use are:

**-ORBInitRef NameService=IOR:00230021AB...**

**-ORBInitRef NotificationService=corbaloc::555objs.com/NotificationService**

**-ORBInitRef TradingService=corbaname::555objs.com#Dev/Trader**

**<ObjectID>** represents the well-known **ObjectID** for a service defined in the CORBA specification, such as **NameService**. This mechanism allows an ORB to be configured with new initial service Object IDs that were not defined when the ORB was installed.

**<ObjectURL>** can be any of the URL schemes supported by **CORBA::ORB::string\_to\_object** (Section 13.6.10, “Object URLs” on page 13-24), with the exception of the corbaloc URL scheme with the rir protocol (i.e., corbaloc:rir...). If a URL is syntactically malformed or can be determined to be invalid in an implementation defined manner, **ORB\_init** raises a **BAD\_PARAM** exception.

### 4.5.3.3 *ORBDefaultInitRef*

The ORB default initial reference argument, **-ORBDefaultInitRef**, assists in resolution of initial references not explicitly specified with **-ORBInitRef**.

**-ORBDefaultInitRef** requires a URL that, after appending a slash ‘/’ character and a stringified object key, forms a new URL to identify an initial object reference. For example:

**-ORBDefaultInitRef corbaloc::555objs.com**

A call to **resolve\_initial\_references** (see the “NotificationService”) with this argument results in a new URL:

**corbaloc::555objs.com/NotificationService**

That URL is passed to **CORBA::ORB::string\_to\_object** to obtain the initial reference for the service.

Another example is:

**-ORBDefaultInitRef \  
corbaname::555ResolveRefs.com,:555Backup.com#Prod/Local**

After calling **resolve\_initial\_references(“NameService”)**, one of the corbaname URLs



**corbaname::555ResolveRefs.com#Prod/Local/NameService**

or

**corbaname::555Backup411.com#Prod/Local/NameService**

is used to obtain an object reference from **string\_to\_object**. (In this example, **Prod/Local/NameService** represents a stringified **CosNaming::Name**).

Section 13.6.7, “Profile and Component Composition in IORs” on page 13-22 provides details of the **corbaloc** and **corbaname** URL schemes. The **-ORBDefaultInitRef** argument naturally extends to URL schemes that may be defined in the future, provided the final part of the URL is an object key.

#### 4.5.3.4 *Configuration Effect on resolve\_initial\_references*

##### *Default Resolution Order*

The default order for processing a call to **CORBA::ORB::resolve\_initial\_references** for a given **<ObjectID>** is:

1. Resolve with **register\_initial\_reference** entry if possible.
1. Resolve with **-ORBInitRef** for this **<ObjectID>** if possible
2. Resolve with pre-configured ORB settings if possible.
3. Resolve with an **-ORBDefaultInitRef** entry if possible.

##### *ORB Configured Resolution Order*

There are cases where the default resolution order may not be appropriate for all services and use of **-ORBDefaultInitRef** may have unintended resolution side effects. For example, an ORB may use a proprietary service, such as **ImplementationRepository**, for internal purposes and may want to prevent a client from unknowingly diverting the ORB’s reference to an implementation repository from another vendor. To prevent this, an ORB is allowed to ignore the **-ORBDefaultInitRef** argument for any or all **<ObjectID>**s for those services that are not OMG-specified services with a well-known service name as accepted by **resolve\_initial\_references**. An ORB can only ignore the **-ORBDefaultInitRef** argument but must always honor the **-ORBInitRef** argument.

#### 4.5.3.5 *Configuration Effect on list\_initial\_services*

The **<ObjectID>**s of all **-ORBInitRef** arguments to **ORB\_init** appear in the list of tokens returned by **list\_initial\_services** as well as all ORB-configured **<ObjectID>**s. Any other tokens that may appear are implementation-dependent.

The list of **<ObjectID>**s returned by **list\_initial\_services** can be a subset of the **<ObjectID>**s recognized as valid by **resolve\_initial\_references**.

## 4.6 Context Object

### 4.6.1 Introduction

A context object contains a list of properties, each consisting of a name and a string value associated with that name. By convention, context properties represent information about the client, environment, or circumstances of a request that are passed as a single parameter representing that collection of information.

Context properties represent a portion of a client's or application's environment that is meant to be propagated to (and made available to) a server's environment (for example, a window identifier, or user preference information). Once an operation has been invoked in the server, the operation implementation may query its context object for these properties.

An operation definition may contain a context clause that specifies the context properties that may be of interest to a particular operation. These context properties (if present for the actual call) are propagated to the server. A client-side ORB may choose to pass more properties than are specified by an operation's context clause. An example of an operation with a context clause is

```
interface Example {
 void op() context("USER", "X*");
};
```

This context clause specifies that the "USER" property is to be made available to the server, as well as all properties with names beginning with "X". Note that there is no obligation on the client to actually pass values for these properties at run time; if the client omits one or more properties, the call proceeds normally and the operation implementation simply will not be able to retrieve the corresponding property values.

Property names are non-empty strings that cannot contain the character '\*'; there are no other syntactic restrictions on property names. Property names that differ only in case are distinct names, so the following is a legal context clause that transmits two distinct properties:

```
interface Example2 {
 void op() context("FOO", "foo");
};
```

**Context** property values are strings. An empty string is a legal property value.

Property values are modified and accessed via the **Context** interface. A **Context** object represents a collection of property values. **Context** objects may be connected into hierarchies; properties defined in child **Context** objects lower in the hierarchy override properties in parent **Context** objects higher in the hierarchy.

### 4.6.2 Context Object Operations

Properties are represented as named value lists.

```

module CORBA {
 interface Context { // PIDL
 void set_one_value(
 in Identifier prop_name, // property name to set
 in string value // property value to set
);
 void set_values(
 in NVList values // property values to set
);
 void get_values(
 in Identifier start_scope, // search scope
 in Flags op_flags, // operation flags
 in Identifier prop_name, // name of property(s) to retrieve
 out NVList values // requested property(s)
);
 void delete_values(
 in Identifier prop_name // name of property(s) to delete
);
 void create_child(
 in Identifier ctx_name, // name of context object
 out Context child_ctx // newly created context object
);
 void delete(
 in Flags del_flags // flags controlling deletion
);
 };
};

```

#### 4.6.2.1 *set\_one\_value*

```

void set_one_value(
 in Identifier prop_name, // property name to set
 in string value // property value to set
);

```

This operation sets a single context object property. If **prop\_name** is the empty string or contains the character '\*', the operation raises **BAD\_PARAM** with minor code 35.

#### 4.6.2.2 *set\_values*

```

void set_values(
 in NVList values // property values to set
);

```

This operation sets one or more property values in its context object. If a property name appears more than once in the **NVList**, the value with higher index (later in the list) overwrites the value with lower index.

The **flags** field of each passed **NVList** element must be zero. A non-zero flag in any of the **NVList** elements raises **INV\_FLAGS**.

The property name of each **NVList** element must be a non-empty string not containing the character '\*'; otherwise, the operation raises **BAD\_PARAM** with minor code 35.

The value of each property of the passed **NVList** must be a (possibly empty) unbounded string. Property values other than unbounded strings raise **BAD\_TYPECODE** with minor code 3.

#### 4.6.2.3 *get\_values*

```
void get_values(
 in Identifier start_scope, // search scope
 in Flags op_flags, // operation flags
 in Identifier prop_name, // name of property(s) to retrieve
 out NVList values // requested property(s)
);
```

This operation returns an **NVList** with those properties that match the **prop\_name** parameter. Legal values for **prop\_name** are:

- a non-empty string that does not contain the character '\*'

In this case, the **values** parameter returns the property with the name specified by **prop\_name**.

- a string beginning with one or more characters other than '\*', followed by a single '\*' at the end, such as "XYZ\*"

In this case, the **values** parameter contains the properties that have names beginning with "XYZ" (such as "XYZABC" or "XYZ").

If **prop\_name** is the empty string, the string "\*", contains more than one '\*' character, or contains a '\*' anywhere but at the end of the string, the operation raises **BAD\_PARAM** with minor code 36.

The **start\_scope** parameter controls the **context** object level at which to initiate the search for the specified properties as follows:

- The **start\_scope** parameter specifies the name of the **context** object in which the search for properties is to start.
- If the context object on which **get\_values** is invoked has a name equal to **start\_scope**, that context object becomes the starting **context** object for the search.
- If **start\_scope** is "", the context object on which **get\_values** is invoked becomes the starting **context** object for the search.
  - If the **context** object on which **get\_values** is invoked does not have a name equal to **start\_scope** (and **start\_scope** is not ""), the parent context object is retrieved and its name compared to **start\_scope**; this process repeats until either a starting **context** object whose name equals **start\_scope** is found, or the search terminates because it runs out of parent objects.

The name of the root **context** object created by **get\_default\_context** is "RootContext".

If no starting **context** object can be found, the operation raises **BAD\_CONTEXT** with minor code 1.

- Once a starting **context** object is found, **get\_values** searches for properties in the matching **context** object.
- If **op\_flags** is **CORBA::CTX\_RESTRICT\_SCOPE**, **get\_values** searches only the starting **context** object for properties that match **prop\_name**. (The value of **CTX\_RESTRICT\_SCOPE** is 15.)
- If **op\_flags** is zero, **get\_values** searches the starting **context** and its parent **contexts** for properties that match **prop\_name**. The property values that are returned are taken from the first **context** object in which they are found, so properties in child contexts override the values of properties in parent contexts.

In either case, if no property matches **prop\_name**, the operation raises **BAD\_CONTEXT** with minor code 2.

#### 4.6.2.4 *delete\_values*

```
void delete_values(
 in Identifier prop_name // name of property(s) to delete
);
```

This operation deletes the properties that match **prop\_name**. **prop\_name** may have a trailing '\*' character, in which case all properties whose name matches the specified prefix are deleted.

If **prop\_name** is the empty string, the string "\*", contains more than one '\*' character, or contains a '\*' anywhere but at the end of the string, the operation raises **BAD\_PARAM** with minor code 36. The operation only affects the context object on which it is invoked (that is, parent contexts are never affected by **delete\_values**).

If no property name matches **prop\_name**, the operation raises **BAD\_CONTEXT** with minor code 2.

#### 4.6.2.5 *create\_child*

```
void create_child(
 in Identifier ctx_name, // name of context object
 out Context child_ctx // newly created context object
);
```

This operation creates an empty child context object. The child context has the name **ctx\_name**. **ctx\_name** may not be the empty string or "RootContext"; otherwise, the operation raises **BAD\_PARAM** with minor code 37. Calling **create\_child** more than once with the same name on the same parent context is legal and results in the creation of a new, empty child context for each call.

#### 4.6.2.6 *delete*

```
void delete(
 in Flags del_flags // flags controlling deletion
);
```

This operation deletes the context object on which it is invoked:

- If **del\_flags** is zero, the context object is deleted only if it has no child contexts; otherwise, if **del\_flags** is zero and the context object has child contexts, the operation raises **BAD\_PARAM** with minor code 38.
- If **del\_flags** is **CORBA::CTX\_DELETE\_DESCENDANTS**, the context object on which delete is invoked is destroyed, together with (recursively) its child contexts. The value of **CTX\_DELETE\_DESCENDANTS** is 1.

If **del\_flags** has a value other than zero or **CTX\_DELETE\_DESCENDANTS**, the operation raises **INV\_FLAGS**.

### 4.7 *Current Object*

ORB and CORBA services may wish to provide access to information (context) associated with the thread of execution in which they are running. This information is accessed in a structured manner using interfaces derived from the **Current** interface defined in the CORBA module.

Each ORB or CORBA service that needs its own context derives an interface from the CORBA module's **Current**. Users of the service can obtain an instance of the appropriate **Current** interface by invoking **ORB::resolve\_initial\_references**. For example the Security service obtains the **Current** relevant to it by invoking

```
ORB::resolve_initial_references("SecurityCurrent")
```

A CORBA service does not have to use this method of keeping context but may choose to do so.

```
module CORBA {
 // interface for the Current object
 local interface Current {
 };
};
```

Operations on interfaces derived from **Current** access state associated with the thread in which they are invoked, not state associated with the thread from which the **Current** was obtained. This prevents one thread from manipulating another thread's state, and avoids the need to obtain and narrow a new **Current** in each method's thread context.

**Current** objects must not be exported to other processes, or externalized with **ORB::object\_to\_string**. If any attempt is made to do so, the offending operation will raise a **MARSHAL** system exception. **Currents** are per-process singleton objects, so no destroy operation is needed.

## 4.8 Policy Object

### 4.8.1 Definition of Policy Object

An ORB or CORBA service may choose to allow access to certain choices that affect its operation. This information is accessed in a structured manner using interfaces derived from the **Policy** interface defined in the CORBA module. A CORBA service does not have to use this method of accessing operating options, but may choose to do so. The *Security Service* in particular uses this technique for associating *Security Policy* with objects in the system.

```

module CORBA {
 typedef unsigned long PolicyType;

 // Basic IDL definition
 interface Policy {
 readonly attribute PolicyType policy_type;
 Policy copy();
 void destroy();
 };

 typedef sequence <Policy> PolicyList;
 typedef sequence <PolicyType> PolicyTypeSeq;
};

```

**PolicyType** defines the type of **Policy** object. In general the constant values that are allocated are defined in conjunction with the definition of the corresponding **Policy** object. The values of **PolicyTypes** for policies that are standardized by OMG are allocated by OMG. Additionally, vendors may reserve blocks of 4096 **PolicyType** values identified by a 20 bit *Vendor PolicyType Valueset ID (VPVID)* for their own use.

**PolicyType** which is an unsigned long consists of the 20-bit **VPVID** in the high order 20 bits, and the vendor assigned policy value in the low order 12 bits. The **VPVIDs** 0 through *\xf* are reserved for OMG. All values for the standard **PolicyTypes** are allocated within this range by OMG. Additionally, the **VPVIDs** *\xffff* is reserved for experimental use and **OMGVMCID** (Section 4.12.3, “Standard System Exception Definitions” on page 4-65) is reserved for OMG use. These will not be allocated to anybody. Vendors can request allocation of **VPVID** by sending mail to *tag-request@omg.org*.

When a **VMCID** (Section 4.12, “Exceptions” on page 4-62) is allocated to a vendor automatically the same value of **VPVID** is reserved for the vendor and vice versa. So once a vendor gets either a **VMCID** or a **VPVID** registered they can use that value for both their minor codes and their policy types.

#### 4.8.1.1 Copy

```

Policy copy();

```

**Return Value**

This operation copies the policy object. The copy does not retain any relationships that the policy had with any domain, or object.

**4.8.1.2 Destroy****void destroy();**

This operation destroys the policy object. It is the responsibility of the policy object to determine whether it can be destroyed.

**Exception(s)**

**CORBA::NO\_PERMISSION** - raised when the policy object determines that it cannot be destroyed.

**4.8.1.3 Policy\_type****readonly attribute policy\_type****Return Value**

This readonly attribute returns the constant value of type **PolicyType** that corresponds to the type of the **Policy** object.

**4.8.2 Creation of Policy Objects**

A generic ORB operation for creating new instances of Policy objects is provided as described in this section.

```
module CORBA {

 typedef short PolicyErrorCode;
 const PolicyErrorCode BAD_POLICY = 0;
 const PolicyErrorCode UNSUPPORTED_POLICY = 1;
 const PolicyErrorCode BAD_POLICY_TYPE = 2;
 const PolicyErrorCode BAD_POLICY_VALUE = 3;
 const PolicyErrorCode UNSUPPORTED_POLICY_VALUE = 4;

 exception PolicyError {PolicyErrorCode reason;};

 interface ORB {

 Policy create_policy(
 in PolicyType type,
 in any val
) raises(PolicyError);
 };
};
```



```
};
};
```

#### 4.8.2.1 *PolicyErrorCode*

A request to create a **Policy** may be invalid for the following reasons:

**BAD\_POLICY** - the requested **Policy** is not understood by the ORB.

**UNSUPPORTED\_POLICY** - the requested **Policy** is understood to be valid by the ORB, but is not currently supported.

**BAD\_POLICY\_TYPE** - The type of the value requested for the **Policy** is not valid for that **PolicyType**.

**BAD\_POLICY\_VALUE** - The value requested for the **Policy** is of a valid type but is not within the valid range for that type.

**UNSUPPORTED\_POLICY\_VALUE** - The value requested for the **Policy** is of a valid type and within the valid range for that type, but this valid value is not currently supported.

#### 4.8.2.2 *PolicyError*

```
exception PolicyError {PolicyErrorCode reason;};
```

**PolicyError** exception is raised to indicate problems with parameter values passed to the **ORB::create\_policy** operation. Possible reasons are described above.

#### 4.8.2.3 *Create\_policy*

The ORB operation **create\_policy** can be invoked to create new instances of policy objects of a specific type with specified initial state. If **create\_policy** fails to instantiate a new **Policy** object due to its inability to interpret the requested type and content of the policy, it raises the **PolicyError** exception with the appropriate reason as described in Section 4.8.2.1, “PolicyErrorCode” on page 4-39.

```
Policy create_policy(
 in PolicyType type,
 in any val
) raises(PolicyError);
```

##### *Parameter(s)*

**type** - the **PolicyType** of the policy object to be created.

**val** - the value that will be used to set the initial state of the **Policy** object that is created.

##### *ReturnValue*

Reference to a newly created **Policy** object of type specified by the **type** parameter and initialized to a state specified by the **val** parameter.

**Exception(s)**

**PolicyError** - raised when the requested policy is not supported or a requested initial state for the policy is not supported.

When new policy types are added to CORBA or CORBA Services specification, it is expected that the IDL type and the valid values that can be passed to **create\_policy** also be specified.

### 4.8.3 Usages of Policy Objects

Policy Objects are used in general to encapsulate information about a specific policy, with an interface derived from the policy interface. The type of the Policy object determines how the policy information contained within it is used. Usually a Policy object is associated with another object to associate the contained policy with that object.

Objects with which policy objects are typically associated are Domain Managers, POA, the execution environment, both the process/capsule/ORB instance and thread of execution (Current object) and object references. Only certain types of policy object can be meaningfully associated with each of these types of objects.

These relationships are documented in sections that pertain to these individual objects and their usages in various core facilities and object services. The use of Policy Objects with the POA are discussed in the *Portable Object Adapter* chapter. The use of Policy objects in the context of the Security services, involving their association with Domain Managers as well as with the Execution Environment are discussed in the *Security Service* specification.

In the following section the association of Policy objects with the Execution Environment is discussed. In Section 4.9, “Management of Policies” on page 4-43 the use of Policy objects in association with Domain Managers is discussed.

### 4.8.4 Policy Associated with the Execution Environment

Certain policies that pertain to services like security (e.g., QOP, Mechanism, invocation credentials, etc.) are associated by default with the process/capsule(RM-ODP)/ORB instance (hereinafter referred to as “capsule”) when the application is instantiated together with the capsule. By default these policies are applicable whenever an invocation of an operation is attempted by any code executing in the said capsule. The Security service provides operations for modulating these policies on a per-execution thread basis using operations in the **Current** interface. Certain of these policies (e.g., invocation credentials, qop, mechanism, etc.) which pertain to the invocation of an operation through a specific object reference can be further modulated at the client end, using the **set\_policy\_overrides** operation of the **Object** reference. For a description of this operation see Section 4.3.9, “Overriding Associated Policies on an Object Reference” on page 4-20. It associates a specified set of policies with a newly created object reference that it returns.

The association of these overridden policies with the object reference is a purely local phenomenon. These associations are never passed on in any IOR or any other marshaled form of the object reference. The associations last until the object reference in the capsule is destroyed or the capsule in which it exists is destroyed.

The policies thus overridden in this new object reference and all subsequent duplicates of this new object reference apply to all invocations that are done through these object references. The overridden policies apply even when the default policy associated with **Current** is changed. It is always possible that the effective policy on an object reference at any given time will fail to be successfully applied, in which case the invocation attempt using that object reference will fail and return a **CORBA::NO\_PERMISSION** exception. Only certain policies that pertain to the invocation of an operation at the client end can be overridden using this operation. These are listed in the Security specification. Attempts to override any other policy will result in the raising of the **CORBA::NO\_PERMISSION** exception.

In general the policy of a specific type that will be used in an invocation through a specific object reference using a specific thread of execution is determined first by determining if that policy type has been overridden in that object reference. If so then the overridden policy is used. If not then if the policy has been set in the thread of execution then that policy is used. If not then the policy associated with the capsule is used. For policies that matter, the ORB ensures that there is a default policy object of each type that matters associated with each capsule (ORB instance). Hence, in a correctly implemented ORB there is no case when a required type policy is not available to use with an operation invocation.

#### 4.8.5 Specification of New Policy Objects

When new **PolicyTypes** are added to CORBA specifications, the following details must be defined. It must be clearly stated which particular uses of a new policy are legal and which are not:

- Specify the assigned **CORBA::PolicyType** and the policy's interface definition.
- If the **Policy** can be created through **CORBA::ORB::create\_policy**, specify the allowable values for the any argument 'val' and how they correspond to the initial state/behavior of that **Policy** (such as initial values of attributes). For example, if a Policy has multiple attributes and operations, it is most likely that create\_policy will receive some complex data for the implementation to initialize the state of the specific policy:

```
//IDL
struct MyPolicyRange {
 long low;
 long high;
};

const CORBA::PolicyType MY_POLICY_TYPE = 666;
interface MyPolicy : Policy {
 readonly attribute long low;
```

```

 readonly attribute long high;
 };

```

If this sample **MyPolicy** can be constructed via `create_policy`, the specification of **MyPolicy** will have a statement such as: “When instances of **MyPolicy** are created, a value of type **MyPolicyRange** is passed to **CORBA::ORB::create\_policy** and the resulting **MyPolicy**’s attribute ‘low’ has the same value as the **MyPolicyRange** member ‘low’ and attribute ‘high’ has the same value as the **MyPolicyRange** member ‘high.’

- If the **Policy** can be passed as an argument to **POA::create\_POA**, specify the effects of the new policy on that **POA**. Specifically define incompatibilities (or inter-dependencies) with other **POA** policies, effects on the behavior of invocations on objects activated with the **POA**, and whether or not presence of the **POA** policy implies some **IOR** profile/component contents for object references created with that **POA**. If the **POA** policy implies some addition/modification to the object reference it is marked as “client-exposed” and the exact details are specified including which profiles are affected and how the effects are represented.
- If the component that is used to carry this information can be set within a client to tune the client’s behavior, specify the policy’s effects on the client specifically with respect to (a) establishment of connections and reconnections for an object reference; (b) effects on marshaling of requests; (c) effects on insertion of service contexts into requests; (d) effects upon receipt of service contexts in replies. In addition, incompatibilities (or inter-dependencies) with other client-side policies are stated. For policies that cause service contexts to be added to requests, the exact details of this addition are given.
- If the **Policy** can be used with **POA** creation to tune **IOR** contents and can also be specified (overridden) in the client, specify how to reconcile the policy’s presence from both the client and server. It is strongly recommended to avoid this case! As an exercise in completeness, most **POA** policies can probably be extended to have some meaning in the client and vice versa, but this does not help make usable systems, it just makes them more complicated without adding really useful features. There are very few cases where a policy is really appropriate to specify in both places, and for these policies the interaction between the two must be described.
- Pure client-side policies are assumed to be immutable. This allows efficient processing by the runtime that can avoid re-evaluating the policy upon every invocation and instead can perform updates only when new overrides are set (or policies change due to rebind). If the newly specified policy is mutable, it must be clearly stated what happens if non-readonly attributes are set or operations are invoked that have side-effects.
- For certain policy types, override operations may be disallowed. If this is the case, the policy specification must clearly state what happens if such overrides are attempted.

## 4.8.6 Standard Policies

---

**Note** – See Appendix A for a list of the standard policy types that are defined by various parts of CORBA and CORBAServices in this version of CORBA.

---

## 4.9 Management of Policies

### 4.9.1 Client Side Policy Management

Client-side Policy management is performed through operations accessible in the following contexts:

- ORB-level Policies - A locality-constrained **PolicyManager** is accessible through the ORB interface. This **PolicyManager** has operations through which a set of Policies can be applied and the current overriding Policy settings can be obtained. Policies applied at the ORB level override any system defaults. The ORB's **PolicyManager** is obtained through an invocation of **ORB::resolve\_initial\_references**, specifying an identifier of "ORBPolicyManager."
- Thread-level Policies - A standard **PolicyCurrent** is defined with operations for the querying and applying of quality of service values specific to a thread. Policies applied at the thread level override any system defaults or values set at the ORB level. The locality-constrained **PolicyCurrent** is obtained through an invocation of **ORB::resolve\_initial\_references**, specifying an identifier of "PolicyCurrent." When accessed from a newly spawned thread, the **PolicyCurrent** initially has no overridden policies. The **PolicyCurrent** also has no overridden values when a POA with **ThreadPolicy** of **ORB\_CONTROL\_MODEL** dispatches an invocation to a servant. Each time an invocation is dispatched through a **SINGLE\_THREAD\_MODEL** POA, the thread-level overrides are reset to have no overridden values.
- Object-level Policies - Operations are defined on the base Object interface through which a set of Policies can be applied. Policies applied at the Object level override any system defaults or values set at the ORB or Thread levels. In addition, accessors are defined for querying the current *overriding* Policies set at the Object level, and for obtaining the current *effective client-side* Policy of a given **PolicyType**. The *effective client-side* **Policy** is the value of a **PolicyType** that would be in effect if a request were made. This is determined by checking for overrides at the Object level, then at the Thread level, and finally at the ORB level. If no overriding policies are set at any level, the system-dependent default value is returned. Portable applications are expected to override the ORB-level policies since default values are not specified in most cases.

## 4.9.2 Server Side Policy Management

Server-side Policy management is handled by associating Policy objects with a POA. Since all policy objects are derived from interface **Policy**, those that are applicable to server-side behavior can be passed as arguments to **POA::create\_POA**. Any such Policies that affect the behavior of requests (and therefore must be accessible to the ORB at the client side) are exported within the Object references that the POA creates. It is clearly noted in a POA **Policy** definition when that **Policy** is of interest to the Client. For those policies that can be exported within an Object reference, the absence of a value for that policy type implies that the target supports any legal value of that **PolicyType**.

Most Policies are appropriate only for management at either the Server or Client, but not both. For those Policies that can be established at the time of Object reference creation (through POA Policies) and overridden by the client (through overrides set at the ORB, thread, or Object reference scopes), reconciliation is done on a per-Policy basis. Such Policies are clearly noted in their definitions and describe the mechanism of reconciliation between the Policies that are set by the POA and overridden in the client. Furthermore, obtaining the effective **Policy** of some PolicyTypes requires evaluating the effective **Policy** of other types of Policies. Such hierarchical **Policy** definitions are also noted clearly when used.

At the Thread and ORB scopes, the common operations for querying the current set of policies and for overriding these settings are encapsulated in the **PolicyManager** interface.

## 4.9.3 Policy Management Interfaces

```

module CORBA {

 local interface PolicyManager {

 PolicyList get_policy_overrides(in PolicyTypeSeq ts);

 void set_policy_overrides(
 in PolicyList policies,
 in SetOverrideType set_add
) raises (InvalidPolicies);
 };

 local interface PolicyCurrent : PolicyManager, Current {
 };
};

```

### 4.9.3.1 *interface PolicyManager*

The **PolicyManager** operations are used for setting and accessing **Policy** overrides at a particular scope. For example, an instance of the **PolicyCurrent** is used for specifying **Policy** overrides that apply to invocations from that thread (unless they are overridden at the Object scope as described in Section 4.9.1, “Client Side Policy Management” on page 4-43).

#### *get\_policy\_overrides*

```
PolicyList get_policy_overrides(in PolicyTypeSeq ts);
```

#### *Parameter*

ts                      a sequence of overridden policy types identifying the policies that are to be retrieved.

#### *Return Value*

policy list            the list of overridden policies of the types specified by ts.

#### *Exceptions*

none

Returns a **PolicyList** containing the overridden Policies for the requested PolicyTypes. If the specified sequence is empty, all **Policy** overrides at this scope will be returned. If none of the requested PolicyTypes are overridden at the target **PolicyManager**, an empty sequence is returned. This accessor returns only those **Policy** overrides that have been set at the specific scope corresponding to the target **PolicyManager** (no evaluation is done with respect to overrides at other scopes).

#### *set\_policy\_overrides*

```
void set_policy_overrides(
 in PolicyList policies,
 in SetOverrideType set_add
) raises (InvalidPolicies);
```

#### *Parameter*

policies                a sequence of **Policy** objects that are to be associated with the **PolicyManager** object. If the sequence contains two or more **Policy** objects with the same **PolicyType** value, the operation raises the standard system exception **BAD\_PARAM** with standard minor code 30.

set\_add                 whether the association is in addition to (**ADD\_OVERRIDE**) or as a replacement of (**SET\_OVERRIDE**) any existing overrides already associated with the **PolicyManager** object. If the value of this parameter is **SET\_OVERRIDE**, the supplied **policies** completely replace all existing overrides associated with the

**PolicyManager** object. If the value of this parameter is **ADD\_OVERRIDE**, the supplied **policies** are added to the existing overrides associated with the **PolicyManager** object, except that if a supplied **Policy** object has the same **PolicyType** value as an existing override, the supplied **Policy** object replaces the existing override.

#### ***Return Value***

none.

#### ***Exceptions***

**InvalidPolicies** a list of indices identifying the position in the input policies list that are occupied by invalid policies.

Modifies the current set of overrides with the requested list of **Policy** overrides. The first parameter **policies** is a sequence of references to **Policy** objects. The second parameter **set\_add** of type **SetOverrideType** indicates whether these policies should be added onto any other overrides that already exist (**ADD\_OVERRIDE**) in the **PolicyManager**, or they should be added to a clean **PolicyManager** free of any other overrides (**SET\_OVERRIDE**). Invoking **set\_policy\_overrides** with an empty sequence of policies and a mode of **SET\_OVERRIDE** removes all overrides from a **PolicyManager**. Only certain policies that pertain to the invocation of an operation at the client end can be overridden using this operation. Attempts to override any other policy will result in the raising of the **CORBA::NO\_PERMISSION** exception. If the request would put the set of overriding policies for the target **PolicyManager** in an inconsistent state, no policies are changed or added, and the exception **InvalidPolicies** is raised. There is no evaluation of compatibility with policies set within other **PolicyManagers**.

#### ***4.9.3.2 interface PolicyCurrent***

This specific **PolicyManager** provides access to policies overridden at the Thread scope. A reference to a thread's **PolicyCurrent** is obtained through an invocation of **CORBA::ORB::resolve\_initial\_references**.

## ***4.10 Management of Policy Domains***

### ***4.10.1 Basic Concepts***

This section describes how policies, such as security policies, are associated with objects that are managed by an ORB. The interfaces and operations that facilitate this aspect of management is described in this section together with the section describing **Policy** objects.



#### 4.10.1.1 *Policy Domain*

A policy domain is a set of objects to which the policies associated with that domain apply. These objects are the domain members. The policies represent the rules and criteria that constrain activities of the objects which belong to the domain. On object reference creation, the ORB implicitly associates the object reference with one or more policy domains. Policy domains provide leverage for dealing with the problem of scale in policy management by allowing application of policy at a domain granularity rather than at an individual object instance granularity.

#### 4.10.1.2 *Policy Domain Manager*

A policy domain includes a unique object, one per policy domain, called the domain manager, which has associated with it the policy objects for that domain. The domain manager also records the membership of the domain and provides the means to add and remove members. The domain manager is itself a member of a domain, possibly the domain it manages.

#### 4.10.1.3 *Policy Objects*

A policy object encapsulates a policy of a specific type. The policy encapsulated in a policy object is associated with the domain by associating the policy object with the domain manager of the policy domain.

There may be several policies associated with a domain, with a policy object for each. There is at most one policy of each type associated with a policy domain. The policy objects are thus shared between objects in the domain, rather than being associated with individual objects. Consequently, if an object needs to have an individual policy, then it must be a singleton member of a domain.

#### 4.10.1.4 *Object Membership of Policy Domains*

Since the only way to access objects is through object references, associating object references with policy domains, implicitly associates the domain policies with the object associated with the object reference. Care should be taken by the application that is creating object references using POA operations to ensure that object references to the same object are not created by the server of that object with different domain associations. Henceforth whenever the concept of “object membership” is used, it actually means the membership of an object reference to the object in question.

An object can simultaneously be a member of more than one policy domain. In that case the object is governed by all policies of its enclosing domains. The reference model allows an object to be a member of multiple domains, which may overlap for the same type of policy (for example, be subject to overlapping access policies). This would require conflicts among policies defined by the multiple overlapping domains to be resolved. The specification does not include explicit support for such overlapping domains and, therefore, the use of policy composition rules required to resolve conflicts at policy enforcement time.

Policy domain managers and policy objects have two types of interfaces:

- The operational interfaces used when enforcing the policies. These are the interfaces used by the ORB during an object invocation. Some policy objects may also be used by applications, which enforce their own policies.

The caller asks for the policy of a particular type (e.g., the delegation policy), and then uses the policy object returned to enforce the policy. The caller finding a policy and then enforcing it does not see the domain manager objects and the domain structure.

- The administrative interfaces used to set policies (e.g., specifying which events to audit or who can access objects of a specified type in this domain). The administrator sees and navigates the domain structure, so he is aware of the scope of what he is administering.

---

**Note** – This specification does not include any explicit interfaces for managing the policy domains themselves: creating and deleting them; moving objects between them; changing the domain structure and adding, changing, and removing policies applied to the domains.

---

#### 4.10.1.5 *Domains Association at Object Reference Creation*

When a new object reference is created, the ORB implicitly associates the object reference (and hence the object that it is associated with) with the following elements forming its environment:

- One or more *Policy Domains*, defining all the policies to which the object associated with the object reference is subject.
- The *Technology Domains*, characterizing the particular variants of mechanisms (including security) available in the ORB.

The ORB will establish these associations when one of the object reference creation operations of the POA is called. Some or all of these associations may subsequently be explicitly referenced and modified by administrative or application activity, which might be specifically security-related but could also occur as a side-effect of some other activity, such as moving an object to another host machine.

In some cases, when a new object reference is created, it needs to be associated with a new domain. Within a given domain a construction policy can be associated with a specific object type thus causing a new domain; that is, a domain manager object to be created whenever an object reference of that type is created and the newly created object reference associated with the new domain manager. This construction policy is enforced at the same time as the domain membership; that is, by the POA when it creates an object reference.

#### 4.10.1.6 *Implementor's View of Object Creation*

For policy domains, the construction policy of the application or factory creating the object proceeds as follows. The application (which may be a generic factory) calls one of the object reference creation operations of the POA to create the new object reference. The ORB obtains the construction policy associated with the creating object, or the default domain absent a creating object.

By default, the new object reference that is created is made a member of the domain to which the parent belongs. Non-object applications on the client side are associated with a default, per-ORB instance policy domain by the ORB.

Each domain manager has a construction policy associated with it, which controls whether, in addition to creating the specified new object reference, a new domain manager is created with it. This object provides a single operation **make\_domain\_manager** which can be invoked with the **constr\_policy** parameter set to TRUE to indicate to the ORB that new object references of the specified type are to be associated their own separate domains. Once such a construction policy is set, it can be reversed by invoking **make\_domain\_manager** again with the **constr\_policy** parameter set to FALSE.

When creating an object reference of the type specified in the **make\_domain\_manager** call with **constr\_policy** set to TRUE, the ORB must also create a new domain for the newly created object reference. If a new domain is needed, the ORB creates both the requested object reference and a domain manager object. A reference to this domain manager can be found by calling **get\_domain\_managers** on the newly created object reference.

While the management interface to the construction policy object is standardized, the interface from the ORB to the policy object is assumed to be a private one, which may be optimized for different implementations.

If a new domain is created, the policies initially applicable to it are the policies of the enclosing domain. The ORB will always arrange to provide a default enclosing domain with default ORB policies associated with it, in those cases where there would be no such domain as in the case of a non-object client invoking object creation operations.

The calling application, or an administrative application later, can change the domains to which this object belongs, using the domain management interfaces, which will be defined in the future.

Since the ORB has control only over domain associations with object references, it is the responsibility of the creator of new object to ensure that the object references that are created to the new object are associated meaningfully with domains.

#### 4.10.2 *Domain Management Operations*

This section defines the interfaces and operations needed to find domain managers and find the policies associated with these. However, it does not include operations to manage domain membership, structure of domains, or to manage which policies are associated with domains.

This section also includes the interface to the construction policy object, as that is relevant to domains. The basic definitions of the interfaces and operations related to these are part of the CORBA module, since other definitions in the CORBA module depend on these.

```

module CORBA {
 interface DomainManager {
 Policy get_domain_policy (
 in PolicyType policy_type
);
 };

 const PolicyType SecConstruction = 11;

 interface ConstructionPolicy: Policy{
 void make_domain_manager(
 in CORBA::InterfaceDef object_type,
 in boolean constr_policy
);
 };

 typedef sequence <DomainManager> DomainManagersList;
};

```

#### 4.10.2.1 Domain Manager

The domain manager provides mechanisms for:

- Establishing and navigating relationships to superior and subordinate domains.
- Creating and accessing policies.

There should be no unnecessary constraints on the ordering of these activities, for example, it must be possible to add new policies to a domain with a pre-existing membership. In this case, some means of determining the members that do not conform to a policy that may be imposed is required. It should be noted that interfaces for adding new policies to domains or for changing domain memberships have not currently been standardized.

All domain managers provide the **get\_domain\_policy** operation. By virtue of being an object, the Domain Managers also have the **get\_policy** and **get\_domain\_managers** operations, which is available on all objects (see Section 4.3.8, “Getting Policy Associated with the Object” on page 4-18 and Section 4.3.11, “Getting the Domain Managers Associated with the Object” on page 4-21).

##### *CORBA::DomainManager::get\_domain\_policy*

This returns the policy of the specified type for objects in this domain.

```

Policy get_domain_policy (
 in PolicyType policy_type

```

);

***Parameter(s)***

**policy\_type** - The type of policy for objects in the domain which the application wants to administer. For security, the possible policy types are described in the *Security Service* specification, Security Policies Introduction section.

***Return Value***

A reference to the policy object for the specified type of policy in this domain.

***Exception(s)***

CORBA::INV\_POLICY - raised when the value of policy type is not valid either because the specified type is not supported by this ORB or because a policy object of that type is not associated with this Object.

#### 4.10.2.2 *Construction Policy*

The construction policy object allows callers to specify that when instances of a particular object reference are created, they should be automatically assigned membership in a newly created domain at creation time.

***CORBA::ConstructionPolicy::make\_domain\_manager***

This operation enables the invoker to set the construction policy that is to be in effect in the domain with which this **ConstructionPolicy** object is associated. Construction Policy can either be set so that when an object reference of the type specified by the input parameter is created, a new domain manager will be created and the newly created object reference will respond to **get\_domain\_managers** by returning a reference to this domain manager. Alternatively the policy can be set to associate the newly created object reference with the domain associated with the creator. This policy is implemented by the ORB during execution of any one of the object reference creation operations of the POA, and results in the construction of the application-specified object reference and a Domain Manager object if so dictated by the policy in effect at the time of the creation of the object reference.

```
void make_domain_manager (
 in InterfaceDef object_type,
 in boolean constr_policy
);
```

***Parameter(s)***

**object\_type** - The type of the object references for which Domain Managers will be created. If this is nil, the policy applies to all object references in the domain.

**constr\_policy** - If TRUE the construction policy is set to create a new domain manager associated with the newly created object reference of this type in this domain. If FALSE construction policy is set to associate the newly created object references with the domain of the creator or a default domain as described above.

## 4.11 TypeCodes

**TypeCodes** are values that represent invocation argument types and attribute types. They can be obtained from the Interface Repository or from IDL compilers.

**TypeCodes** have a number of uses. They are used in the dynamic invocation interface to indicate the types of the actual arguments. They are used by an Interface Repository to represent the type specifications that are part of many OMG IDL declarations. Finally, they are crucial to the semantics of the **any** type.

Abstractly, **TypeCodes** consist of a “kind” field, and a set of parameters appropriate for that kind. For example, the **TypeCode** describing OMG IDL type **long** has kind **tk\_long** and no parameters. The **TypeCode** describing OMG IDL type **sequence<boolean,10>** has kind **tk\_sequence** and two parameters: **10** and **boolean**.

### 4.11.1 The TypeCode Interface

The PIDL interface for **TypeCodes** is as follows:

```

module CORBA {
 enum TCKind {
 tk_null, tk_void,
 tk_short, tk_long, tk_ushort, tk_ulong,
 tk_float, tk_double, tk_boolean, tk_char,
 tk_octet, tk_any, tk_TypeCode, tk_Principal, tk_objref,
 tk_struct, tk_union, tk_enum, tk_string,
 tk_sequence, tk_array, tk_alias, tk_except,
 tk_longlong, tk_ulonglong, tk_longdouble,
 tk_wchar, tk_wstring, tk_fixed,
 tk_value, tk_value_box,
 tk_native,
 tk_abstract_interface,
 tk_local_interface
 tk_component, tk_home,
 tk_event
 };

 typedef short ValueModifier;
 const ValueModifier VM_NONE = 0;
 const ValueModifier VM_CUSTOM = 1;
 const ValueModifier VM_ABSTRACT = 2;
 const ValueModifier VM_TRUNCATABLE = 3;

 interface TypeCode {

```

```

exception Bounds {};
exception BadKind {};

// for all TypeCode kinds
boolean equal (in TypeCode tc);

boolean equivalent(in TypeCode tc);
TypeCode get_compact_typecode();

TCKind kind ();

// for tk_objref, tk_struct, tk_union, tk_enum, tk_alias,
// tk_value, tk_value_box, tk_native, tk_abstract_interface
// tk_local_interface, tk_except
// tk_component, tk_home and tk_event
RepositoryId id () raises (BadKind);

// for tk_objref, tk_struct, tk_union, tk_enum, tk_alias,
// tk_value, tk_value_box, tk_native, tk_abstract_interface
// tk_local_interface, tk_except
// tk_component, tk_home and tk_event
Identifier name () raises (BadKind);

// for tk_struct, tk_union, tk_enum, tk_value,
// tk_except and tk_event
unsigned long member_count () raises (BadKind);
Identifier member_name (in unsigned long index)
 raises(BadKind, Bounds);

// for tk_struct, tk_union, tk_value,
// tk_except and tk_event
TypeCode member_type (in unsigned long index)
 raises (BadKind, Bounds);

// for tk_union
any member_label (in unsigned long index)
 raises(BadKind, Bounds);
TypeCode discriminator_type () raises (BadKind);
long default_index () raises (BadKind);

// for tk_string, tk_wstring, tk_sequence, and tk_array
unsigned long length () raises (BadKind);

// for tk_sequence, tk_array, tk_value_box and tk_alias
TypeCode content_type () raises (BadKind);

// for tk_fixed
unsigned short fixed_digits() raises(BadKind);
short fixed_scale() raises(BadKind);

// for tk_value and tk_event

```

```

 Visibility member_visibility(in unsigned long index)
 raises(BadKind, Bounds);
 ValueModifier type_modifier() raises(BadKind);
 TypeCode concrete_base_type() raises(BadKind);
 };
};

```

With the above operations, any **TypeCode** can be decomposed into its constituent parts. The **BadKind** exception is raised if an operation is not appropriate for the **TypeCode** kind it invoked.

The **equal** operation can be invoked on any **TypeCode**. The **equal** operation returns **TRUE** if and only if for the target **TypeCode** and the **TypeCode** passed through the parameter **tc**, the set of legal operations is the same and invoking any operation from that set on the two **TypeCodes** return identical results.

The **equivalent** operation is used by the ORB when determining type equivalence for values stored in an IDL **any**. **TypeCodes** are considered equivalent based on the following semantics:

- If the result of the **kind** operation on either **TypeCode** is **tk\_alias**, recursively replace the **TypeCode** with the result of calling **content\_type**, until the kind is no longer **tk\_alias**.
- If results of the **kind** operation on each typecode differ, **equivalent** returns false.
- If the **id** operation is valid for the **TypeCode kind**, **equivalent** returns **TRUE** if the results of **id** for both **TypeCodes** are non-empty strings and both strings are equal. If both ids are non-empty but are not equal, then **equivalent** returns **FALSE**. If either or both id is an empty string, or the **TypeCode kind** does not support the **id** operation, **equivalent** will perform a structural comparison of the **TypeCodes** by comparing the results of the other **TypeCode** operations in the following bullet items (ignoring aliases as described in the first bullet.). The structural comparison only calls operations that are valid for the given **TypeCode kind**. If any of these operations do not return equal results, then **equivalent** returns **FALSE**. If all comparisons are equal, **equivalent** returns true.
- The results of the **name** and **member\_name** operations are ignored and not compared.
- The results of the **member\_count**, **default\_index**, **length**, **digits**, **scale**, and **type\_modifier** operations are compared.
- The results of the **member\_label** operation for each member index of a **union TypeCode** are compared for equality. Note that this means that **unions** whose members are not defined in the same order are not considered structurally equivalent.
- The results of the **discriminator\_type**, **member\_type**, and **concrete\_base\_type** operation and for each member index, and the result of the **content\_type** operation are compared by recursively calling **equivalent**.
- The results of the **member\_visibility** operation are compared for each member index.



Applications that need to distinguish between a type and different aliases of that type can supplement **equivalent** by directly invoking the **id** operation and comparing the results.

The **get\_compact\_typecode** operation strips out all optional **name** and **member name** fields, but it leaves all alias typecodes intact.

The **kind** operation can be invoked on any **TypeCode**. Its result determines what other operations can be invoked on the **TypeCode**.

The **id** operation can be invoked on object reference, valuetype, boxed valuetype, abstract interface, local interface, native, structure, union, enumeration, alias, exception, component, home, and event **TypeCodes**. It returns the **RepositoryId** globally identifying the type. Object reference, valuetype, boxed valuetype, native, exception, component, home, and event **TypeCodes** always have a **RepositoryId**. Structure, union, enumeration, and alias **TypeCodes** obtained from the Interface Repository or the **ORB::create\_operation\_list** operation also always have a **RepositoryId**. Otherwise, the **id** operation can return an empty string.

When the **id** operation is invoked on an object reference **TypeCode** that contains a base **Object**, the returned value is **IDL:omg.org/CORBA/Object:1.0**.

When it is invoked on a valuetype **TypeCode** that contains a **ValueBase**, the returned value is **IDL:omg.org/CORBA/ValueBase:1.0**.

When it is invoked on a component **TypeCode** that contains a **Components::CCMObject**, the returned value is **IDL:omg.org/Components/CCMObject:1.0**.

When it is invoked on a home **TypeCode** that contains a **Components::CCMHome**, the returned value is **IDL:omg.org/Components/CCMHome:1.0**.

When it is invoked on an eventtype **TypeCode** that contains a **Components::EventBase**, the returned value is **IDL:omg.org/Components/EventBase:1.0**.

The **name** operation can also be invoked on object reference, structure, union, enumeration, alias, abstract interface, local interface, value type, boxed valuetype, native, and exception **TypeCodes**. It returns the simple name identifying the type within its enclosing scope. Since names are local to a **Repository**, the name returned from a **TypeCode** may not match the name of the type in any particular **Repository**, and may even be an empty string.

The order in which members are presented in the interface repository is the same as the order in which they appeared in the IDL specification, and this ordering determines the index value for each member. The first member has index value 0. For example for a structure definition:

```
struct example {
 short member1;
 short member2;
 long member3;
};
```

In this example **member1** has **index** = 0, **member2** has **index** = 1, and **member3** has **index** = 2. The value of **member\_count** in this case is 3.

The **member\_count** and **member\_name** operations can be invoked on structure, union, non-boxed valuetype, non-boxed eventtype, exception, and enumeration **TypeCodes**. **Member\_count** returns the number of members constituting the type. **Member\_name** returns the simple name of the member identified by **index**. Since names are local to a **Repository**, the name returned from a **TypeCode** may not match the name of the member in any particular **Repository**, and may even be an empty string.

The **member\_type** operation can be invoked on structure, non-boxed valuetype, non-boxed eventtype, exception and union **TypeCodes**. It returns the **TypeCode** describing the type of the member identified by **index**.

The **member\_label**, **discriminator\_type**, and **default\_index** operations can only be invoked on union **TypeCodes**. **Member\_label** returns the label of the union member identified by **index**. For the default member, the label is the zero octet. The **discriminator\_type** operation returns the type of all non-default member labels. The **default\_index** operation returns the index of the default member, or -1 if there is no default member.

The **member\_visibility** operation can only be invoked on non-boxed valuetype and non-boxed eventtype, **TypeCodes**. It returns the **Visibility** of the valuetype/eventtype member identified by **index**.

The **member\_name**, **member\_type**, **member\_label** and **member\_visibility** operations raise **Bounds** if the **index** parameter is greater than or equal to the number of members constituting the type.

The **content\_type** operation can be invoked on sequence, array, boxed valuetype and alias **TypeCodes**. For sequences and arrays, it returns the element type. For aliases, it returns the original type. For boxed valuetype, it returns the boxed type.

An array **TypeCode** only describes a single dimension of an OMG IDL array. Multi-dimensional arrays are represented by nesting **TypeCodes**, one per dimension. The outermost **tk\_array Typecode** describes the leftmost array index of the array as defined in IDL. Its **content\_type** describes the next index. The innermost nested **tk\_array TypeCode** describes the rightmost index and the array element type.

The **type\_modifier** and **concrete\_base\_type** operations can be invoked on non-boxed valuetype and non-boxed eventtype **TypeCodes**. The **type\_modifier** operation returns the **ValueModifier** that applies to the valuetype/eventtype represented by the target **TypeCode**. If the valuetype/eventtype represented by the target **TypeCode** has a concrete base valuetype/eventtype, the **concrete\_base\_type** operation returns a **TypeCode** for the concrete base, otherwise it returns a nil **TypeCode** reference.

The **length** operation can be invoked on string, wide string, sequence, and array **TypeCodes**. For strings and sequences, it returns the bound, with zero indicating an unbounded string or sequence. For arrays, it returns the number of elements in the array. For wide strings, it returns the bound, or zero for unbounded wide strings.

### 4.11.2 *TypeCode Constants*

For IDL type declarations, the IDL compiler produces (if asked) a declaration of a **TypeCode** constant. See the language mapping rules for more information about the names of the generated **TypeCode** constants. **TypeCode** constants include tk\_alias definitions wherever an IDL typedef is referenced. These constants can be used with the dynamic invocation interface and other routines that require **TypeCodes**.

The predefined **TypeCode** constants, named according to the C language mapping, are:

```
TC_null
TC_void
TC_short
TC_long
TC_longlong
TC_ushort
TC_ulong
TC_ulonglong
TC_float
TC_double
TC_longdouble
TC_boolean
TC_char
TC_wchar
TC_octet
TC_any
TC_TypeCode
TC_Object = tk_objref {Object}
TC_string= tk_string {0} // unbounded
TC_wstring = tk_wstring{0}/// unbounded
TC_ValueBase = tk_value {ValueBase}
TC_Component = tk_component {CCMObject}
TC_Home = tk_home {CCMHome}
TC_EventBase = tk_event {EventBase}
```

For the **TC\_Object TypeCode** constant, calling **id** returns "IDL:omg.org/CORBA/Object:1.0" and calling **name** returns "Object."

For the **TC\_ValueBase TypeCode** constant, calling **id** returns "IDL:omg.org/CORBA/ValueBase:1.0," calling **name** returns "ValueBase," calling **member\_count** returns **0**, calling **type\_modifier** returns **CORBA::VM\_NONE**, and calling **concrete\_base\_type** returns a **nil TypeCode**.

For the **TC\_Component TypeCode** constant, calling **id** returns "IDL:omg.org/Components/CCMObject:1.0" and calling **name** returns "CCMObject."

For the **TC\_Home TypeCode** constant, calling **id** returns "IDL:omg.org/Components/CCMHome:1.0" and calling **name** returns "CCMHome."

For the **TC\_EventBase TypeCode** constant, calling **id** returns "IDL:omg.org/Components/EventBase:1.0," calling **name** returns "EventBase," calling **member\_count** returns **0**, calling **type\_modifier** returns **CORBA::VM\_NONE**, and calling **concrete\_base\_type** returns a **nil TypeCode**.

### 4.11.3 Creating TypeCodes

When creating type definition objects in an Interface Repository, types are specified in terms of object references, and the **TypeCodes** describing them are generated automatically.

In some situations, such as bridges between ORBs, **TypeCodes** need to be constructed outside of any Interface Repository. This can be done using operations on the **ORB** pseudo-object.

```

module CORBA {
 interface ORB {
 // other operations ...

 TypeCode create_struct_tc (
 in RepositoryId id;
 in Identifier name,
 in StructMemberSeq members
);

 TypeCode create_union_tc (
 in RepositoryId id,
 in Identifier name,
 in TypeCode discriminator_type,
 in UnionMemberSeq members
);

 TypeCode create_enum_tc (
 in RepositoryId id,
 in Identifier name,
 in EnumMemberSeq members
);

 TypeCode create_alias_tc (
 in RepositoryId id,
 in Identifier name,
 in TypeCode original_type
);

 TypeCode create_exception_tc (
 in RepositoryId id,
 in Identifier name,
 in StructMemberSeq members
);
 }
}

```

```
TypeCode create_interface_tc (
 in RepositoryId id,
 in Identifier name
);

TypeCode create_string_tc (
 in unsigned long bound
);

TypeCode create_wstring_tc (
 in unsigned long bound
);

TypeCode create_fixed_tc (
 in unsigned short digits,
 in unsigned short scale
);

TypeCode create_sequence_tc (
 in unsigned long bound,
 in TypeCode element_type
);

TypeCode create_recursive_sequence_tc (// deprecated
 in unsigned long bound,
 in unsigned long offset
);

TypeCode create_array_tc (
 in unsigned long length,
 in TypeCode element_type
);

TypeCode create_value_tc (
 in RepositoryId id,
 in Identifier name,
 in ValueModifier type_modifier,
 in TypeCode concrete_base,
 in ValueMemberSeq members
);

TypeCode create_value_box_tc (
 in RepositoryId id,
 in Identifier name,
 in TypeCode boxed_type
);

TypeCode create_native_tc (
 in RepositoryId id,
 in Identifier name
);
```

```

TypeCode create_recursive_tc(
 in RepositoryId id
);

TypeCode create_abstract_interface_tc(
 in RepositoryId id,
 in Identifier name
);

TypeCode create_local_interface_tc(
 in RepositoryId id,
 in Identifier name
);

TypeCode create_component_tc (
 in RepositoryId id,
 in Identifier name
);

TypeCode create_home_tc (
 in RepositoryId id,
 in Identifier name
);

TypeCode create_event_tc (
 in RepositoryId id,
 in Identifier name,
 in ValueModifier type_modifier,
 in TypeCode concrete_base,
 in ValueMemberSeq members
);
};
};

```

Most of these operations are similar to corresponding IR operations for creating type definitions. **TypeCode**s are used here instead of **IDLType** object references to refer to other types. In the **StructMember**, **UnionMember** and **ValueMember** structures, only the **type** is used, and the **type\_def** should be set to nil.

Typecode creation operations that take **name** as an argument shall check that the name is a valid IDL name or is a null string. If not, they shall raise the **BAD\_PARAM** exception with standard minor code 15. Operations that take a **RepositoryId** argument shall check that the argument passed in is a string of the form **<format>:<string>** and if not, then raise a **BAD\_PARAM** exception with standard minor code 16. Operations that take **content** or **member** types as arguments shall check that they are legitimate (i.e., that they don't have kinds **tk\_null**, **tk\_void** or **tk\_exception**). If not, they shall raise the **BAD\_TYPECODE** exception with standard minor code 2. Operations that take members shall check that the member names are valid IDL names and that they are unique within the member list, and if the name is found to be incorrect, they shall raise a **BAD\_PARAM** with standard minor code 17.

The **create\_union\_tc** operation shall check that there are no duplicate label values. It shall also check that each label **TypeCode** compares equivalent to the discriminator **TypeCode**. If a duplicate label is found, raise **BAD\_PARAM** with standard minor code 18. If incompatible **TypeCode** of label and discriminator is found, raise **BAD\_PARAM** with standard minor code 19. The **create\_union\_tc** operation shall also check that the supplied discriminator type is legitimate, and if the check fails, raise **BAD\_PARAM** with standard minor code 20.

---

**Note** – The **create\_recursive\_sequence\_tc** operation is deprecated. No new code should make use of this operation. Its functionality is subsumed by the new operation **create\_recursive\_tc**. The **create\_recursive\_sequence\_tc** operation will be removed from a future revision of the standard.

---

The **create\_recursive\_sequence\_tc** operation is used to create **TypeCodes** describing recursive sequences that are members of structs or unions. The result of this operation should be used as the typecode in the **StructMemberSeq** or **UnionMemberSeq** arguments of the **create\_struct\_tc** or **create\_union\_tc** operations. The **offset** parameter specifies which enclosing struct or union is the target of the recursion, with the value **1** indicating the most immediate enclosing struct or union, and larger values indicating successive enclosing struct or unions. For example, the offset would be **1** for the following IDL structure:

```
struct foo {
 long value;
 sequence <foo> chain;
};
```

Once the recursive sequence **TypeCode** has been properly embedded in its enclosing **TypeCodes**, it will function as a normal sequence **TypeCode**. Invoking operations on the recursive sequence **TypeCode** before it has been embedded in the required number of enclosing **TypeCodes** will result in undefined behavior. Attempt to marshal incomplete typecodes shall raise the **BAD\_TYPECODE** exception with standard minor code 1. Attempt to use an incomplete **TypeCode** as a parameter of any operation when detected shall cause the **BAD\_PARAM** exception to be raised with standard minor code 13.

For **create\_value\_tc** operation, the **concrete\_base** parameter is a **TypeCode** for the immediate concrete valuetype base of the valuetype for which the **TypeCode** is being created. If the valuetype does not have a concrete base, the **concrete\_base** parameter is a nil **TypeCode** reference.

The **create\_recursive\_tc** operation is used to create a recursive **TypeCode**, which serves as a place holder for a concrete **TypeCode** during the process of creating **TypeCodes** that contain recursion. The **id** parameter specifies the repository id of the type for which the recursive **TypeCode** is serving as a place holder. Once the recursive **TypeCode** has been properly embedded in the enclosing **TypeCode**, which corresponds to the specified repository id, it will function as a normal **TypeCode**. Invoking operations on the recursive **TypeCode** before it has been embedded in the enclosing **TypeCode** will result in undefined behavior. For example, the following IDL type declarations contain recursion:

```

struct foo {
 long value;
 sequence<foo> chain;
};

valuetype V {
 public V member;
};

```

To create a **TypeCode** for **valuetype V**, you would invoke the **TypeCode** creation operations as shown below:

```

// C++
TypeCode_var recursive_tc
 = orb->create_recursive_tc("IDL:V:1.0");

ValueMemberSeq v_seq;
v_seq.length(1);
v_seq[0].name = string_dup("member");
v_seq[0].type = recursive_tc;
v_seq[0].access = PUBLIC_MEMBER;
TypeCode_var v_val_tc
 = orb->create_value_tc("IDL:V:1.0",
 "V",
 VM_NONE,
 TypeCode::_nil(),
 v_seq);

```

For **create\_event\_tc** operation, the **concrete\_base** parameter is a **TypeCode** for the immediate concrete base of the eventtype for which the **TypeCode** is being created. If the eventtype does not have a concrete base, the **concrete\_base** parameter is a nil **TypeCode** reference.

## 4.12 Exceptions

The terms “system” and “user” exception are defined in this section. Further the terms “standard system exception” and “standard user exception” are defined, and then a list of “standard system exceptions” is provided.

### 4.12.1 Definition of Terms

In general the following terms should be used consistently in all OMG standards documents to refer to exceptions:

**Standard Exception:** Any exception that is defined in an OMG Standard.

**System Exception:** Clients must be prepared to handle these exceptions even though they are not declared in a raises clause. These exceptions cannot appear in a raises clause. These have the structure defined in section 3.17.2 “System Exception,” and they are of type **SYSTEM\_EXCEPTION** (see PIDL below).



**Standard System Exception:** A System Exception that is part of the CORBA Standard as enumerated in section 3.17. (e.g., BAD\_PARAM). These are enumerated in Section 3.17.2 “Standard System Exceptions.”

**Non-Standard System Exceptions:** System exceptions that are proprietary to a particular vendor/implementation.

**User Exception:** Exceptions that can be raised only by those operations that explicitly declare them in the raises clause of their signature. These exceptions are of type USER\_EXCEPTION (see IDL below).

**Standard User Exception:** Any User Exception that is defined in a published OMG standard (e.g., WrongTransaction). These are documented in the documentation of individual interfaces.

**Non-standard User Exception:** User exceptions that are not defined in any published OMG specification.

### 4.12.2 System Exceptions

In order to bound the complexity in handling the standard exceptions, the set of standard exceptions should be kept to a tractable size. This constraint forces the definition of equivalence classes of exceptions rather than enumerating many similar exceptions. For example, an operation invocation can fail at many different points due to the inability to allocate dynamic memory. Rather than enumerate several different exceptions corresponding to the different ways that memory allocation failure causes the exception (during marshaling, unmarshaling, in the client, in the object implementation, allocating network packets), a single exception corresponding to dynamic memory allocation failure is defined.

```

module CORBA {
 const unsigned long OMGVMCID = 0x4f4d0000;

#define ex_body {unsigned long minor; completion_status completed;}

 enum completion_status {
 COMPLETED_YES,
 COMPLETED_NO,
 COMPLETED_MAYBE
 };

 enum exception_type {
 NO_EXCEPTION,
 USER_EXCEPTION,
 SYSTEM_EXCEPTION
 };
};

```

Each system exception includes a minor code to designate the subcategory of the exception.

Minor exception codes are of type **unsigned long** and consist of a 20-bit “Vendor Minor Codeset ID”(VMCID), which occupies the high order 20 bits, and the minor code which occupies the low order 12 bits.

The standard minor codes for the standard system exceptions are prefaced by the **VMCID** assigned to OMG, defined as the unsigned long constant **CORBA::OMGVMCID**, which has the VMCID allocated to OMG occupying the high order 20 bits. The minor exception codes associated with the standard exceptions that are found in Appendix A, Section A.5, “Exception Codes” are or-ed with **OMGVMCID** to get the minor code value that is returned in the **ex\_body** structure (see Section 4.12.3, “Standard System Exception Definitions” on page 4-65 and Section 4.12.4, “Standard Minor Exception Codes” on page 4-72).

Within a vendor assigned space, the assignment of values to minor codes is left to the vendor. Vendors may request allocation of **VMCID**s by sending email to [tag-request@omg.org](mailto:tag-request@omg.org).

The **VMCID 0** and **0xffff** are reserved for experimental use. The **VMCID OMGVMCID** (Section 4.12.3, “Standard System Exception Definitions” on page 4-65) and **1 through 0xf** are reserved for OMG use.

Each standard system exception also includes a **completion\_status** code that takes one of the values {COMPLETED\_YES, COMPLETED\_NO, COMPLETED\_MAYBE}. These have the following meanings:

|                 |                                                                                         |
|-----------------|-----------------------------------------------------------------------------------------|
| COMPLETED_YES   | The object implementation has completed processing prior to the exception being raised. |
| COMPLETED_NO    | The object implementation was never initiated prior to the exception being raised.      |
| COMPLETED_MAYBE | The status of implementation completion is indeterminate.                               |

Client applications must be prepared to handle system exceptions other than the standard system exception defined below in Section 4.12.3, “Standard System Exception Definitions” on page 4-65, both because future versions of this specification may define additional standard system exceptions, and because ORB implementations may raise non-standard system exceptions.

Vendors may define non-standard system exceptions, but these exceptions are discouraged because they are non-portable. A non-standard system exception, when passed to an ORB that does not recognize it, shall be presented by that ORB as an **UNKNOWN** standard system exception. The completion status shall be preserved in the **UNKNOWN** exception, and the minor code shall be set to standard value 2 for system exception and standard value 1 for user exception.

Non-standard system exceptions shall have the same structure as of standard standard system exceptions as specified in section Section 4.12.3, “Standard System Exception Definitions” on page 4-65 (i.e., they have the same **ex\_body**). They also shall follow

the same language mappings as standard system exceptions. Although they are PIDL, vendors should ensure that their names do not clash with any other names following the normal naming and scoping rules as they apply to regular IDL exceptions.

### 4.12.3 *Standard System Exception Definitions*

The standard system exceptions are defined in this section.

```

module CORBA { // PIDL

 exception UNKNOWN ex_body;
 // the unknown exception
 exception BAD_PARAM ex_body;
 // an invalid parameter was passed
 exception NO_MEMORY ex_body;
 // dynamic memory allocation failure
 exception IMP_LIMIT ex_body;
 // violated implementation limit
 exception COMM_FAILURE ex_body;
 // communication failure
 exception INV_OBJREF ex_body;
 // invalid object reference
 exception NO_PERMISSION ex_body;
 // no permission for attempted op.
 exception INTERNAL ex_body;
 // ORB internal error
 exception MARSHAL ex_body;
 // error marshaling param/result
 exception INITIALIZE ex_body;
 // ORB initialization failure
 exception NO_IMPLEMENT ex_body;
 // operation implementation unavailable
 exception BAD_TYPECODE ex_body;
 // bad typecode
 exception BAD_OPERATION ex_body;
 // invalid operation
 exception NO_RESOURCES ex_body;
 // insufficient resources for req.
 exception NO_RESPONSE ex_body;
 // response to req. not yet available
 exception PERSIST_STORE ex_body;
 // persistent storage failure
 exception BAD_INV_ORDER ex_body;
 // routine invocations out of order
 exception TRANSIENT ex_body;
 // transient failure - reissue request
 exception FREE_MEM ex_body;
 // cannot free memory
 exception INV_IDENT ex_body;
 // invalid identifier syntax

```

```

exception INV_FLAG ex_body;
 // invalid flag was specified
exception INTF_REPOS ex_body;
 // error accessing interface repository
exception BAD_CONTEXT ex_body;
 // error processing context object
exception OBJ_ADAPTER ex_body;
 // failure detected by object adapter
exception DATA_CONVERSION ex_body;
 // data conversion error
exception OBJECT_NOT_EXIST ex_body;
 // non-existent object, delete reference
exception TRANSACTION_REQUIRED ex_body;
 // transaction required
exception TRANSACTION_ROLLEDBACK x_body;
 // transaction rolled back
exception INVALID_TRANSACTION ex_body;
 // invalid transaction
exception INV_POLICY ex_body;
 // invalid policy
exception CODESET_INCOMPATIBLE ex_body
 // incompatible code set
exception REBIND ex_body;
 // rebind needed
exception TIMEOUT ex_body;
 // operation timed out
exception TRANSACTION_UNAVAILABLE ex_body;
 // no transaction
exception TRANSACTION_MODE ex_body;
 // invalid transaction mode
exception BAD_QOS ex_body;
 // bad quality of service
exception INVALID_ACTIVITY ex_body;
 // bad quality of service
exception ACTIVITY_COMPLETED ex_body;
 // bad quality of service
exception ACTIVITY_REQUIRED ex_body;
 // bad quality of service
};

```

#### 4.12.3.1 UNKNOWN

This exception is raised if an operation implementation throws a non-CORBA exception (such as an exception specific to the implementation's programming language), or if an operation raises a user exception that does not appear in the operation's raises expression. UNKNOWN is also raised if the server returns a system exception that is unknown to the client. (This can happen if the server uses a later version of CORBA than the client and new system exceptions have been added to the later version.)

#### 4.12.3.2 *BAD\_PARAM*

A parameter passed to a call is out of range or otherwise considered illegal. An ORB may raise this exception if null values or null pointers are passed to an operation (for language mappings where the concept of a null pointers or null values applies). *BAD\_PARAM* can also be raised as a result of client generating requests with incorrect parameters using the DII.

#### 4.12.3.3 *NO\_MEMORY*

The ORB run time has run out of memory.

#### 4.12.3.4 *IMP\_LIMIT*

This exception indicates that an implementation limit was exceeded in the ORB run time. For example, an ORB may reach the maximum number of references it can hold simultaneously in an address space, the size of a parameter may have exceeded the allowed maximum, or an ORB may impose a maximum on the number of clients or servers that can run simultaneously.

#### 4.12.3.5 *COMM\_FAILURE*

This exception is raised if communication is lost while an operation is in progress, after the request was sent by the client, but before the reply from the server has been returned to the client.

#### 4.12.3.6 *INV\_OBJREF*

This exception indicates that an object reference is internally malformed. For example, the repository ID may have incorrect syntax or the addressing information may be invalid.

An ORB may choose to detect calls via nil references (but is not obliged to detect them). *INV\_OBJREF* is used to indicate this.

If the client invokes an operation that results in an attempt by the client ORB to marshal wchar or wstring data for an in parameter (or to unmarshal wchar or wstring data for an in/out parameter, out parameter or the return value), and the associated object reference does not contain a codeset component, the *INV\_OBJREF* standard system exception is raised.

#### 4.12.3.7 *NO\_PERMISSION*

An invocation failed because the caller has insufficient privileges.

#### 4.12.3.8 *INTERNAL*

This exception indicates an internal failure in an ORB, for example, if an ORB has detected corruption of its internal data structures.

#### 4.12.3.9 *MARSHAL*

A request or reply from the network is structurally invalid. This error typically indicates a bug in either the client-side or server-side run time. For example, if a reply from the server indicates that the message contains 1000 bytes, but the actual message is shorter or longer than 1000 bytes, the ORB raises this exception. *MARSHAL* can also be caused by using the DII or DSI incorrectly, for example, if the type of the actual parameters sent does not agree with IDL signature of an operation.

#### 4.12.3.10 *INITIALIZE*

An ORB has encountered a failure during its initialization, such as failure to acquire networking resources or detecting a configuration error.

#### 4.12.3.11 *NO\_IMPLEMENT*

This exception indicates that even though the operation that was invoked exists (it has an IDL definition), no implementation for that operation exists. *NO\_IMPLEMENT* can, for example, be raised by an ORB if a client asks for an object's type definition from the interface repository, but no interface repository is provided by the ORB.

#### 4.12.3.12 *BAD\_TYPECODE*

The ORB has encountered a malformed type code (for example, a type code with an invalid **TCKind** value).

#### 4.12.3.13 *BAD\_OPERATION*

This indicates that an object reference denotes an existing object, but that the object does not support the operation that was invoked.

#### 4.12.3.14 *NO\_RESOURCES*

The ORB has encountered some general resource limitation. For example, the run time may have reached the maximum permissible number of open connections.

#### 4.12.3.15 *NO\_RESPONSE*

This exception is raised if a client attempts to retrieve the result of a deferred synchronous call, but the response for the request is not yet available.

#### 4.12.3.16 *PERSIST\_STORE*

This exception indicates a persistent storage failure, for example, failure to establish a database connection or corruption of a database.

#### 4.12.3.17 *BAD\_INV\_ORDER*

This exception indicates that the caller has invoked operations in the wrong order. For example, it can be raised by an ORB if an application makes an ORB-related call without having correctly initialized the ORB first.

#### 4.12.3.18 *TRANSIENT*

*TRANSIENT* indicates that the ORB attempted to reach an object and failed. It is not an indication that an object does not exist. Instead, it simply means that no further determination of an object's status was possible because it could not be reached. This exception is raised if an attempt to establish a connection fails, for example, because the server or the implementation repository is down.

#### 4.12.3.19 *FREE\_MEM*

The ORB failed in an attempt to free dynamic memory, for example because of heap corruption or memory segments being locked.

#### 4.12.3.20 *INV\_IDENT*

This exception indicates that an IDL identifier is syntactically invalid. It may be raised if, for example, an identifier passed to the interface repository does not conform to IDL identifier syntax, or if an illegal operation name is used with the DII.

#### 4.12.3.21 *INV\_FLAG*

An invalid flag was passed to an operation (for example, when creating a DII request).

#### 4.12.3.22 *INTF\_REPOS*

An ORB raises this exception if it cannot reach the interface repository, or some other failure relating to the interface repository is detected.

#### 4.12.3.23 *BAD\_CONTEXT*

An operation may raise this exception if a client invokes the operation but the passed context does not contain the context values required by the operation.

#### 4.12.3.24 *OBJ\_ADAPTER*

This exception typically indicates an administrative mismatch. For example, a server may have made an attempt to register itself with an implementation repository under a name that is already in use, or is unknown to the repository. *OBJ\_ADAPTER* is also raised by the POA to indicate problems with application-supplied servant managers.

#### 4.12.3.25 *DATA\_CONVERSION*

This exception is raised if an ORB cannot convert the representation of data as marshaled into its native representation or vice-versa. For example, *DATA\_CONVERSION* can be raised if wide character codeset conversion fails, or if an ORB cannot convert floating point values between different representations.

#### 4.12.3.26 *OBJECT\_NOT\_EXIST*

The *OBJECT\_NOT\_EXIST* exception is raised whenever an invocation on a deleted object was performed. It is an authoritative “hard” fault report. Anyone receiving it is allowed (even expected) to delete all copies of this object reference and to perform other appropriate “final recovery” style procedures.

Bridges forward this exception to clients, also destroying any records they may hold (for example, proxy objects used in reference translation). The clients could in turn purge any of their own data structures.

#### 4.12.3.27 *TRANSACTION\_REQUIRED*

The *TRANSACTION\_REQUIRED* exception indicates that the request carried a null transaction context, but an active transaction is required.

#### 4.12.3.28 *TRANSACTION\_ROLLEDBACK*

The *TRANSACTION\_ROLLEDBACK* exception indicates that the transaction associated with the request has already been rolled back or marked to roll back. Thus, the requested operation either could not be performed or was not performed because further computation on behalf of the transaction would be fruitless.

#### 4.12.3.29 *INVALID\_TRANSACTION*

The *INVALID\_TRANSACTION* indicates that the request carried an invalid transaction context. For example, this exception could be raised if an error occurred when trying to register a resource.

#### 4.12.3.30 *INV\_POLICY*

*INV\_POLICY* is raised when an invocation cannot be made due to an incompatibility between Policy overrides that apply to the particular invocation.



#### 4.12.3.31 *CODESET\_INCOMPATIBLE*

This exception is raised whenever meaningful communication is not possible between client and server native code sets. See Section 13.7.2.6, “Code Set Negotiation,” on page 13-34.

#### 4.12.3.32 *REBIND*

**REBIND** is raised when the current effective **RebindPolicy**, as described in Section 22.2.1.2, “interface RebindPolicy” on page 22-5, has a value of **NO\_REBIND** or **NO\_RECONNECT** and an invocation on a bound object reference results in a LocateReply message with status **OBJECT\_FORWARD** or a Reply message with status **LOCATION\_FORWARD**. This exception is also raised if the current effective **RebindPolicy** has a value of **NO\_RECONNECT** and a connection must be re-opened. The invocation can be retried once the effective **RebindPolicy** is changed to **TRANSPARENT** or binding is re-established through an invocation of **CORBA::Object::validate\_connection**.

#### 4.12.3.33 *TIMEOUT*

**TIMEOUT** is raised when no delivery has been made and the specified time-to-live period has been exceeded. It is a standard system exception because time-to-live QoS can be applied to any invocation.

#### 4.12.3.34 *TRANSACTION\_UNAVAILABLE*

**TRANSACTION\_UNAVAILABLE** exception is raised by the ORB when it cannot process a transaction service context because its connection to the Transaction Service has been abnormally terminated.

#### 4.12.3.35 *TRANSACTION\_MODE*

**TRANSACTION\_MODE** exception is raised by the ORB when it detects a mismatch between the **TransactionPolicy** in the IOR and the current transaction mode.

#### 4.12.3.36 *BAD\_QOS*

The **BAD\_QOS** exception is raised whenever an object cannot support the quality of service required by an invocation parameter that has a quality of service semantics associated with it.

#### 4.12.3.37 *INVALID\_ACTIVITY*

The `INVALID_ACTIVITY` system exception may be raised on the Activity or Transaction services' resume methods if a transaction or Activity is resumed in a context different to that from which it was suspended. It is also raised when an attempted invocation is made that is incompatible with the Activity's current state.

#### 4.12.3.38 *ACTIVITY\_COMPLETED*

The `ACTIVITY_COMPLETED` system exception may be raised on any method for which Activity context is accessed. It indicates that the Activity context in which the method call was made has been completed due to a timeout of either the Activity itself or a transaction that encompasses the Activity, or that the Activity completed in a manner other than that originally requested.

#### 4.12.3.39 *ACTIVITY\_REQUIRED*

The `ACTIVITY_REQUIRED` system exception may be raised on any method for which an Activity context is required. It indicates that an Activity context was necessary to perform the invoked operation, but one was not found associated with the calling thread.

### 4.12.4 *Standard Minor Exception Codes*

Please refer to Appendix A for a table that specifies standard minor exception codes that have been assigned for the standard system exceptions.

## Contents

This chapter contains the following sections.

| Section Title                    | Page |
|----------------------------------|------|
| “Overview”                       | 5-1  |
| “Architecture”                   | 5-2  |
| “Standard Value Box Definitions” | 5-9  |
| “Language Mappings”              | 5-9  |
| “Custom Marshaling”              | 5-10 |

## 5.1 Overview

Objects, more specifically, interface types that objects support, are defined by an IDL interface, allowing arbitrary implementations. There is great value, which is described in great detail elsewhere, in having a distributed object system that places almost no constraints on implementations.

However there are many occasions in which it is desirable to be able to pass an object by value, rather than by reference. This may be particularly useful when an object’s primary “purpose” is to encapsulate data, or an application explicitly wishes to make a “copy” of an object.

The semantics of passing an object by value are similar to that of standard programming languages. The receiving side of a parameter passed by value receives a description of the “state” of the object. It then instantiates a new instance with that

state but having a separate identity from that of the sending side. Once the parameter passing operation is complete, no relationship is assumed to exist between the two instances.

Because it is necessary for the receiving side to instantiate an instance, it must necessarily know something about the object's state and implementation.

**Value** types provide semantics that bridge between CORBA structs and CORBA interfaces:

- They support description of complex state (i.e., arbitrary graphs, with recursion and cycles)
- Their instances are always local to the context in which they are used (because they are always copied when passed as a parameter to a remote call)
- They support both public and private (to the implementation) data members.
- They can be used to specify the state of an object implementation (i.e., they can support an interface).
- They support single inheritance (of **valuetype**) and can support an **interface**.
- They may be also be **abstract**.

## 5.2 Architecture

The basic notion is relatively simple. A **value type** is, in some sense, half way between a “regular” IDL interface type and a struct. The use of a value type is a signal from the designer that some additional properties (state) and implementation details be specified beyond that of an interface type. Specification of this information puts some additional constraints on the implementation choices beyond that of interface types. This is reflected in both the semantics specified herein, and in the language mappings.

An essential property of value types is that their implementations are always local. That is, the explicit use of value type in a concrete programming language is always guaranteed to use a local implementation, and will not require a remote call. They have no identity (their value is their identity) and they are not “registered” with the ORB.

There are two kinds of value types, concrete (or stateful) value types, and abstract (stateless) ones. As explained below the essential characteristics of both are the same. The differences between them result from the differences in the way they are mapped in the language mappings. In this specification the semantics of value types apply to both kinds, unless specifically stated otherwise.

Concrete (stateful) values add to the expressive power of (IDL) structs by supporting:

- single derivation (from other value types)
- supports a single non-abstract interface
- arbitrary recursive value type definitions, with sharing semantics providing the ability to define lists, trees, lattices and more generally arbitrary graphs using value types.

- null value semantics

When an instance of such a type is passed as a parameter, the sending context marshals the state (data) and passes it to the receiving context. The receiving context instantiates a new instance using the information in the GIOP request and unmarshals the state. It is assumed that the receiving context has available to it an implementation that is consistent with the sender's (i.e., only needs the state information), or that it can somehow download a usable implementation. Provision is made in the on-the-wire format to support the carrying of an optional call back object (**CodeBase**) to the sending context, which enables such downloading when it is appropriate.

It should be noted that it is possible to define a concrete value type with an empty state as a degenerate case.

### 5.2.1 *Abstract Values*

Value types may also be abstract. They are called abstract because an abstract value type may not be instantiated. Only concrete types derived from them may be actually instantiated and implemented. Their implementation, of course, is still local. However, because no state information may be specified (only local operations are allowed), abstract value types are not subject to the single inheritance restrictions placed upon concrete value types. Essentially they are a bundle of operation signatures with a purely local implementation. This distinction is made clear in the language mappings for abstract values.

Note that a concrete value type with an empty state is not an abstract value type. They are considered to be stateful, may be instantiated, marshaled and passed as actual parameters. Consider them to be a degenerate case of stateful values.

### 5.2.2 *Operations*

Operations defined on a value type specify signatures whose implementation can only be local. Because these operations are local, they must be directly implemented by a body of code in the language mapping (no proxy or indirection is involved).

The language mappings of such operations require that instances of value types passed into and returned by such local methods are passed by reference (programming language reference semantics, not CORBA object reference semantics) and that a copy is not made. Note, such a (local) invocation is not a CORBA invocation. Hence it is not mediated by the ORB, although the API to be used is specified in the language mapping.

The (copy) semantics for instances of value type are only guaranteed when instances of these value types are passed as a parameter to an operation defined on a CORBA interface, and hence mediated by the ORB. If an instance of a value type is passed as a parameter to a method of another value type in an invocation, then this call is a "normal" programming language call. In this case both of the instances are local programming language constructs. No CORBA style copy semantics are used and programming language reference semantics apply.

Operations on the value type are supported in order to guarantee the portability of the client code for these value types. They have no representation on the wire and hence no impact on interoperability.

### 5.2.3 *Value Type vs. Interfaces*

By default value types are not CORBA Objects. In particular instances of value types do not inherit from **CORBA::Object** and do not support normal object reference semantics. However it is always possible to explicitly declare that a given value type supports an interface type. In this case instances of the type may support CORBA object reference semantics (if they are registered with the ORB using an object adapter).

### 5.2.4 *Parameter Passing*

This section describes semantics when a value instance is passed as parameter in a CORBA invocation. It does not deal with the case of calling another non-CORBA (i.e., local) programming method, which happens to have a parameter of the same type.

#### 5.2.4.1 *Value vs. Reference Semantics*

Determination of whether a parameter is to be passed by value or reference is made by examining the parameter's formal type (i.e., the signature of the operation it is being passed to). If it is a value type then it is passed by value. If it is an ordinary interface then it is passed by reference (the case today for all CORBA objects). This rule is simple and consistent with the handling of the same situation in recursive state definitions or in structs.

In the case of abstract interfaces, the determination is made at runtime. See Section 6.2, "Semantics of Abstract Interfaces," on page 6-1 for a description of the rules.

#### 5.2.4.2 *Sharing Semantics*

In order to be expressive enough to describe arbitrary graphs, lattice, trees etc., value types support sharing and null semantics. Instances of a value type can be shared by others across or within other instances. They can also be null. This is unlike other IDL data types such as structs, unions, and sequences that can never be shared. The sharing of values within and between the parameters to an operation, is preserved across an invocation; that is, the graph that is reconstructed in the receiving context is structurally isomorphic to the sending context's.

#### 5.2.4.3 *Identity Semantics*

When an instance of the value type is passed as a parameter to an operation of a non-local interface, the effect in all cases shall be as if an independent copy of the instance is instantiated in the receiving context. While certain implementation optimizations are possible the net effect shall be as if the copy is a separate independent entity and there

is no explicit or implicit sharing of state. This applies to all valuetypes involved in the invocation, including those embedded in other IDL datatypes or in an **any**. This notional copying occurs twice, once for in and inout parameters when the invocation is initiated, and once again for inout, out and return parameters when the invocation completes. Optimization techniques such as copy on write etc. must make sure that the semantics of copying as described above is preserved.

#### 5.2.4.4 *Any parameter type*

When an instance of a value type is passed to an **any**, as with all cases of passing instances to an **any**, it is the responsibility of the implementor to insert and extract the value according to the language mapping specification.

### 5.2.5 *Substitutability Issues*

The substitutability requirements for CORBA require the definition of what happens when an instance of a derived value type is passed as a parameter that is declared to be a base value type or an instance of a value type that supports an interface is passed as a parameter that is declared as the interface type.

There are three cases to consider: the parameter type is a regular interface, the parameter type is an abstract interface, and the parameter type is a value type.

#### 5.2.5.1 *Value instance -> Interface type*

A value type that supports a regular interface is not a subtype of that interface, and hence cannot be substituted for that interface in an invocation parameter. In this case an object reference corresponding to the value type instance that has been registered with the ORB must be obtained and this object reference must be used as the actual parameter. Different language mappings provide different facilities to aid in such parameter passing.

#### 5.2.5.2 *Value Instance -> Abstract interface type*

A value type that supports an abstract interface is a subtype of that interface, and can be substituted for that interface in an invocation parameter.

#### 5.2.5.3 *Value instance -> Value type*

In this case the receiving context is expecting to receive a value type. If the receiving context currently has the appropriate implementation class then there is no problem.

If the receiving context does not currently hold an implementation with which to reconstruct the original type then the following algorithm is used to find such an implementation:

1. **Load** - Attempt to load (locally in C/C++, possibly remotely in Java and other “portable” languages) the real type of the object (with its methods). If this succeeds, OK.
2. **Truncate** - Truncate the type of the object to the base type (if specified as **truncatable** in the IDL). Truncation can never lead to faulty programs because, from a structural point view base types structurally subsume a derived type and an object created in the receiving context bears no relationship with the original one. However, it might be semantically puzzling, as the derived type may completely re-interpret the meaning of the state of the base. For that reason a derived value needs to indicate if it is safe to truncate to its immediate non-abstract parent.
3. **Raise Exception** - If none of these work or are possible, then raise the **NO\_IMPLEMENT** exception with standard minor code 1.

Truncatability is a transitive property.

#### *Example*

```
valuetype EmployeeRecord { // note this is not a CORBA::Object
 // state definition
 private string name;
 private string email;
 private string SSN;
 // initializer
 factory init(in string name, in string SSN);
};

valuetype ManagerRecord: truncatable EmployeeRecord {
 // state definition
 private sequence<EmployeeRecord> direct_reports;
};
```

### 5.2.6 Widening/Narrowing

As has been described above, value type instances may be widened/narrowed to other value types. Each language mapping is responsible for specifying how these operations are made available to the programmer.

Narrowing from an interface type instance to a value type instance is not allowed. If the interface designer wants to allow the receiving context to create a local implementation of the value type (i.e., a value representing the interface) an operation that returns the appropriate value type may be defined.

### 5.2.7 Value Base Type

All value types have a conventional base type called **ValueBase**. This is a type, which fulfills a role that is similar to that played by **Object**. Conceptually it supports the common operations available on all value types. See Section 4.4, “ValueBase



Operations,” on page 4-23 for a description of those operations. In each language mapping **ValueBase** will be mapped to an appropriate base type that supports the marshaling/unmarshaling protocol as well as the model for custom marshaling.

The mapping for other operations, which all value types must support, such as getting meta information about the type, may be found in the specifics for each language mapping.

### 5.2.8 *Life Cycle issues*

Value type instances are always local to their creating context. For example, in a given language mapping an instance of a value type is always created as a local “language” object with no POA semantics attached to it initially.

When passed using a CORBA invocation, a copy of the value is made in the receiving context and that copy starts its life as a local programming language entity with no POA semantics attached to it.

If a value type supports an ordinary interface type, its instances may also be passed by reference when the formal parameter type is an interface type (see Section 5.2.4, “Parameter Passing,” on page 5-4). In this case they behave like ordinary object implementations and must be associated with a POA policy and also be registered with the ORB (e.g., **POA::activate\_object()**) before they can be passed by reference. Not registering the value as a CORBA object and/or not associating an appropriate policy with it results in an exception when trying to use it as a remote object, the “normal” behavior. The exception raised shall be **OBJECT\_NOT\_EXIST** with standard minor code 1.

#### 5.2.8.1 *Creation and Factories*

When an instance of a value type is received by the ORB, it must be unmarshaled and an appropriate factory for its actual type found in order for the new instance to be created. The type is encoded by the **RepositoryID**, which is passed over the wire as part of an invocation. The mapping between the type (as specified by the **RepositoryID**) and the factory is language specific. In certain languages it may be possible to specify default policies that are used to find the factory, without requiring that specific routines be called. In others the runtime and/or generated code may have to explicitly specify the mapping on a per type basis. In others a combination may be used. In any event the ORB implementation is responsible for maintaining this mapping. See Section 5.4.3, “Language Specific Value Factory Requirements,” on page 5-9 for more details on the requirements for each language mapping. Value box types do not need or use factories.

### 5.2.9 *Security Considerations*

The addition of value types has few impacts on the CORBA security model. In essence, the security implications in defining and using value types are similar to those involved with the use of IDL structs. Instances of value types are mapped to local, concrete programming language constructs. Except for providing the marshaling

mechanisms, the ORB is not directly involved with accessing value type implementations. This specification is mostly about two things: how value types manifest themselves as concrete programming language constructs and how they are transmitted.

To see this consider how value types are actually used. The IDL definition of a value type in conjunction with a programming language mapping is used to generate the concrete programming language definitions for that type.

Let us consider its life cycle. In order to use it, the programmer uses the mechanisms in the programming language to instantiate an instance. This instance is a local programming language construct. It is not “registered” with the ORB, object adapter, etc. The programmer may manipulate this programming construct just like any other programming language construct. So far there are no security implications. As long as no ORB-mediated invocations are made, the programmer may manipulate the construct. Note, this includes making “local,” non ORB-mediated calls to any locally implemented operations. Any assignments to the construct are the responsibility of the programmer and have no special security implications.

Things get interesting when the program attempts to pass one of these constructs through an orb-mediated invocation (i.e., calls a stub that uses it as a parameter type, or uses the DII). There are two cases to consider: 1) Value as Value and 2) Value as Object Reference.

#### *5.2.9.1 Value as Value*

The formal type of the parameter is a value. This case is no different from using any other kind of a value (long, string, struct) in a CORBA invocation, with respect to security. The value (data) is marshaled and delivered to the receiving context. On the receiving context, the knowledge of the type is used (at least implicitly) to find the factory to create the correct local programming language construct. The data is then unmarshaled to fill in the newly created construct. This is similar to using other values (longs, strings, structs) except that the knowledge of the factory is not “built-in” to the ORB’s skeleton/DSI engine.

#### *5.2.9.2 Value as Object Reference*

The formal type of the parameter is an interface type that is supported by a value. The program must have “registered” the value with an object adapter and is really using the returned object reference (see for the specific rules.) Thus this case “reduces” to a regular CORBA invocation, using a regular object reference. An IOR is passed to the receiving context. All the “normal” security considerations apply. From the point of view of the receiving context, the IOR is a “normal” object reference. No “special” rules, with respect to security or otherwise, apply to it. The fact that it is ultimately a reference to an implementation that was created from instantiating and registering an value type implementation is not relevant.

In both of these cases, security considerations are involved with the decision to allow the ORB-mediated invocation to proceed. The fact that a value type is involved is not material.

### 5.3 *Standard Value Box Definitions*

For some CORBA-defined types for which preservation of sharing and transmission of nulls are likely to be important, the following value box type definitions are added to the CORBA module:

```
module CORBA {
 valuetype StringValue string;
 valuetype WStringValue wstring;
};
```

## 5.4 *Language Mappings*

### 5.4.1 *General Requirements*

A concrete value is mapped to a concrete usable “class” construct in each programming language, plus possibly some helper classes where appropriate. In Java, C++, and Smalltalk this is a real concrete class. In C it is a struct.

An abstract value is mapped to some sort of an abstract construct--an interface in Java, and an abstract class with pure virtual function members in C++.

Tools that implement the language mapping are free to “extend” the implementation classes with “extra” data members and methods. When an instance of such a class is used as a parameter, only the portions that correspond directly to the IDL declaration, are marshaled and delivered to the receiving context. This allows freedom of implementations while preserving the notion of contract and type safety in IDL.

### 5.4.2 *Language Specific Marshaling*

Each language mapping defines an appropriate marshaling/unmarshaling API and the entry point for custom marshaling/unmarshaling.

### 5.4.3 *Language Specific Value Factory Requirements*

Each language mapping specifies the algorithm and means by which RepositoryIDs are used to find the appropriate factory for an instance of a value type so that it may be created as it is unmarshaled “off the wire.”

It is desirable, where it makes sense, to specify a “default” policy for automatically using RepositoryIDs that are in common formats to find the appropriate factory. Such a policy can be thought of as an implicit registration.

Each language mapping specifies how and when the registration occurs, both explicit and implicit. The registration must occur before an attempt is made to unmarshal an instance of a value type. If the ORB is unable to locate and use the appropriate factory, then a **MARSHAL** exception with standard minor code 1 is raised.

Because the type of the factory is programming language specific and each programming language platform has different policies, the factory type is specified as native. It is the responsibility of each language mapping to specify the actual programming language type of the factory.

```

module CORBA {

 // IDL
 native ValueFactory;
};

```

#### 5.4.4 Value Method Implementation

The mapped class must support method bodies (i.e., code) that implement the required IDL operations. The means by which this association is accomplished is a language mapping “detail” in much the same way that an IDL compiler is.

### 5.5 Custom Marshaling

Value types can override the default marshaling/unmarshaling model and provide their own way to encode/decode their state. Custom marshaling is intended to be used to facilitate integration of existing “class libraries” and other legacy systems. It is explicitly not intended to be a standard practice, nor used in other OMG specifications to avoid “standard ORB” marshaling.

The fact that a value type has some custom marshaling code is declared explicitly in the IDL. This explicit declaration has two goals:

- *type safety* - stub and skeleton can know statically that a given type is custom marshaled and can then do sanity check on what is coming over the wire.
- *efficiency* - for value types that are not custom marshaled no run time test is necessary in the marshaling code.

If a custom marshaled value type has a state definition, the state definition is treated the same as that of a non custom value type for mapping purposes (i.e., the fields show up in the same fashion in the concrete programming language). It is provided to help with application portability.

A custom marshaled value type is always a stateful value type.

```

// Example IDL

custom valuetype T {
 // optional state definition
 ...
};

```

Custom value types can never be safely truncated to base (i.e., they always require an exact match for their RepositoryId in the receiving context).

Once a value type has been marked as custom, it needs to provide an implementation that marshals and unmarshals the valuetype. The marshaling code encapsulates the application code that can marshal and unmarshal instances of the value type over a stream using the CDR encoding. It is the responsibility of the implementation to marshal the state of all of its base types.

The following sections define the operations and streams that are used for custom marshaling.

### 5.5.1 Implementation of Custom Marshaling

Once a value type has been marked as custom, an implementation of the custom marshaling code must be provided. This is specified by providing a concrete implementation of an abstract value type, **CustomMarshal**, as part of the implementation of the value type. **CustomMarshal** encapsulates the application code that can marshal and unmarshal instances of the value type over a stream using the CDR encoding.

The following IDL defines the interfaces that are used to support the definition and use of custom marshaling.

```

module CORBA {
 abstract valuetype CustomMarshal {
 void marshal (in DataOutputStream os);
 void unmarshal (in DataInputStream is);
 };
};

```

**CustomMarshal** is an abstract value type that is meant to be used by the ORB, not the user. Semantically it is treated as a custom valuetype's implicit base class, although the custom valuetype does not actually inherit it in IDL. The implementor of a custom value type provides an implementation of the **CustomMarshal** operations. The manner in which this is done is specified for each language mapping. Each custom marshaled value type has its own implementation. The interface is exposed in the CORBA module so that the implementor can use the skeletons generated by the IDL compiler as the basis for the implementation. Hence there is no need for the application to acquire a reference to a Stream.

Note that while nothing prevents a user from writing IDL that inherits from **CustomMarshal**, doing so will not make the type custom, nor will it cause the ORB to treat it as custom.

The implementation requirements of the streaming mechanism require that the implementations must be local since local memory addresses (i.e., the marshal buffers) have to be manipulated.

### 5.5.2 Marshaling Streams

The streams used for marshaling are defined below. They are responsible for marshaling and demarshaling the data that makes up a custom value in CDR format.

```
module CORBA {

 typedef sequence<any> AnySeq;
 typedef sequence<boolean> BooleanSeq;
 typedef sequence<char> CharSeq;
 typedef sequence<wchar> WCharSeq;
 typedef sequence<octet> OctetSeq;
 typedef sequence<short> ShortSeq;
 typedef sequence<unsigned short> UShortSeq;
 typedef sequence<long> LongSeq;
 typedef sequence<unsigned long> ULongSeq;
 typedef sequence<long long> LongLongSeq;
 typedef sequence<unsigned long long> ULongLongSeq;
 typedef sequence<float> FloatSeq;
 typedef sequence<double> DoubleSeq;
 typedef sequence<long double> LongDoubleSeq;

 typedef sequence<string> StringSeq;
 typedef sequence<wstring> WStringSeq;

 exception BadFixedValue {
 unsigned long offset;
 };

 abstract valuetype DataOutputStream {
 void write_any(in any value);
 void write_boolean(in boolean value);
 void write_char(in char value);
 void write_wchar(in wchar value);
 void write_octet(in octet value);
 void write_short(in short value);
 void write_ushort(in unsigned short value);
 void write_long(in long value);
 void write_ulong(in unsigned long value);
 void write_longlong(in long long value);
 void write_ulonglong(in unsigned long long value);
 void write_float(in float value);

 void write_double(in double value);
 void write_longdouble(in long double value);
 void write_string(in string value);
 void write_wstring(in wstring value);
 void write_Object(in Object value);
 void write_Abstract(in AbstractBase value);

 void write_Value(in ValueBase value);
 void write_TypeCode(in TypeCode value);

 void write_any_array(
 in AnySeq seq,
 in unsigned long offset,
 in unsigned long length
```

```
);
void write_boolean_array(
 in BooleanSeq seq,
 in unsigned long offset,
 in unsigned long length
);
void write_char_array(
 in CharSeq seq,
 in unsigned long offset,
 in unsigned long length
);
void write_wchar_array(
 in WCharSeq seq,
 in unsigned long offset,
 in unsigned long length
);
void write_octet_array(
 in OctetSeq seq,
 in unsigned long offset,
 in unsigned long length
);
void write_short_array(
 in ShortSeq seq,
 in unsigned long offset,
 in unsigned long length
);
void write_ushort_array(
 in UShortSeq seq,
 in unsigned long offset,
 in unsigned long length
);
void write_long_array(
 in LongSeq seq,
 in unsigned long offset,
 in unsigned long length
);
void write_ulong_array(
 in ULongSeq seq,
 in unsigned long offset,
 in unsigned long length
);
void write_ulonglong_array(
 in ULongLongSeq seq,
 in unsigned long offset,
 in unsigned long length
);
void write_longlong_array(
 in LongLongSeq seq,
 in unsigned long offset,
 in unsigned long length
);
```

```
void write_float_array(
 in FloatSeq seq,
 in unsigned long offset,
 in unsigned long length
);
void write_double_array(
 in DoubleSeq seq,
 in unsigned long offset,
 in unsigned long length
);
void write_long_double_array(
 in LongDoubleSeq seq,
 in unsigned long offset,
 in unsigned long length
);
void write_fixed(
 in any fixed_value
) raises (BadFixedValue);
void write_fixed_array(
 in AnySeq seq,
 in unsigned long offset,
 in unsigned long length
) raises (BadFixedValue);
};

abstract valuetype DataInputStream {
 any read_any();
 boolean read_boolean();
 char read_char();
 wchar read_wchar();
 octet read_octet();
 short read_short();
 unsigned short read_ushort();
 long read_long();
 unsigned long read_ulong();
 long long read_longlong();
 unsigned long long read_ulonglong();
 float read_float();
 double read_double();
 long double read_longdouble();
 string read_string();
 wstring read_wstring();
 Object read_Object();
 AbstractBase read_Abstract();
 ValueBase read_Value();
 TypeCode read_TypeCode();

 void read_any_array(
 inout AnySeq seq,
 in unsigned long offset,
 in unsigned long length
);
};
```



```
);
void read_boolean_array(
 inout BooleanSeq seq,
 in unsigned long offset,
 in unsigned long length
);
void read_char_array(
 inout CharSeq seq,
 in unsigned long offset,
 in unsigned long length
);
void read_wchar_array(
 inout WCharSeq seq,
 in unsigned long offset,
 in unsigned long length
);
void read_octet_array(
 inout OctetSeq seq,
 in unsigned long offset,
 in unsigned long length
);
void read_short_array(
 inout ShortSeq seq,
 in unsigned long offset,
 in unsigned long length
);
void read_ushort_array(
 inout UShortSeq seq,
 in unsigned long offset,
 in unsigned long length
);
void read_long_array(
 inout LongSeq seq,
 in unsigned long offset,
 in unsigned long length
);
void read_ulong_array(
 inout ULongSeq seq,
 in unsigned long offset,
 in unsigned long length
);
void read_ulonglong_array(
 inout ULongLongSeq seq,
 in unsigned long offset,
 in unsigned long length
);
void read_longlong_array(
 inout LongLongSeq seq,
 in unsigned long offset,
 in unsigned long length
);
```

```

void read_float_array(
 inout FloatSeq seq,
 in unsigned long offset,
 in unsigned long length
);
void read_double_array(
 inout DoubleSeq seq,
 in unsigned long offset,
 in unsigned long length
);
void read_long_double_array(
 inout DoubleSeq seq,
 in unsigned long offset,
 in unsigned long length
);
any read_fixed(
 in unsigned short digits,
 in short scale
) raises (BadFixedValue);
void read_fixed_array(
 inout AnySeq seq,
 in unsigned long offset,
 in unsigned long length,
 in unsigned short digits,
 in short scale
) raises (BadFixedValue);
};
};

```

Note that the Data streams are abstract value types. This ensures that their implementation will be local, which is required in order for them to properly flatten and encode nested value types.

The **read\_\*** operations that have an inout parameter named seq are expected to extend the sequence to fit the read value.

The ORB (i.e., the CDR encoding engine) is responsible for actually constructing the value's encoding. The application marshaling code merely calls the above operations. The details of writing the value tag, header information, end tag(s) are specifically not exposed to the application code. In particular the size of the custom data is not written by the application. This guarantees that the custom marshaling (and unmarshaling code) cannot corrupt the other parameters of the call.

If an inconsistency is detected, then the standard system exception **MARSHAL** is raised.

A possible implementation might have the engine determine that a custom marshal parameter is "next." It would then write the value tag and other header information and then return control back to the application defined marshaling policy, which would do the marshaling by calling the **DataOutputStream** operations to write the data as appropriate. (Note the stream takes care of breaking the data into chunks, if necessary.)

When control was returned back to the engine, it performs any other cleanup activities to complete the value type, and then proceeds onto the next parameter. How this is actually accomplished is an implementation detail of the ORB.

The Data Streams shall test for possible shared or null values and place appropriate indirections or null encodings (even when used from the custom streaming policy).

There are no explicit operations for creating the streams. It is assumed that the ORB implicitly acts as a factory. In a sense they are always available.

For **write\_fixed**, the **fixed\_value** parameter must be an "any" containing a fixed value. If the "any" passed in does not contain a fixed value, then a **BadFixedValue** exception is raised with the offset field set to 0.

For **write\_fixed\_array**, the elements of the **seq** parameter that are specified by the offset and length parameters must be a sequence of "any"s each of which contains a fixed value. If any of these "any"s does not contain a fixed value, or if any of them contains a fixed value whose **digits** and **scale** (as specified by the **TypeCode** in the "any") differ from those of the first of these "any"s (as specified by its **TypeCode**), then a **BadFixedValue** exception is raised with the offset field set to a zero-origin ordinal number indicating the position of the first incorrect "any" within the subsequence of fixed values written to the stream.

For both **write\_fixed** and **write\_fixed\_array**, the **TypeCode** within each "any" being written specifies the **digits** and **scale** to be used to write the fixed value contained in the "any." The **TypeCode** itself is not written to the **DataOutputStream**.

The **read\_fixed** operation returns an "any" containing the fixed value that was read from the **DataInputStream**. The **digits** and **scale** in the **TypeCode** of the returned "any" are set to the **digits** and **scale** parameters passed to **read\_fixed**. If the fixed value read from the **DataInputStream** is incompatible with the **digits** and **scale** parameters passed to **read\_fixed**, then a **BadFixedValue** exception is raised with the offset field set to 0.

The **read\_fixed\_array** operation sets the elements of the **seq** parameter that are specified by the **offset** and **length** parameters. These elements are set to "any"s with **TypeCodes** specifying a fixed value whose **digits** and **scale** are the same as the **digits** and **scale** parameters, and fixed values that were read from the **DataInputStream**. The previous contents of these "any"s, including their **TypeCodes**, are destroyed by the **read\_fixed\_array** operation. Other "any"s in the **seq** parameter (if any) are left unchanged. No **TypeCode** information is read from the **DataInputStream**. If any of the fixed values read from the **DataInputStream** is incompatible with the **digits** and **scale** parameters, then a **BadFixedValue** exception is raised with the **offset** field set to a zero-origin ordinal number indicating the position of the first incorrect "any" within the subsequence of fixed values read from the stream.

The stream representation of a fixed value is considered incompatible if its **digit** and **scale** values do not match the **digits** and **scale** values being used to read it from the stream.

## 5.6 Access to the Sending Context Run Time

There are two cases where a receiving context might want to access the run time environment of the sending context:

- To attempt the downloading of some missing implementation for the value.
- To access some meta information about the version of the value just received.

In order to provide that kind of service a call back object interface is defined. It may optionally be supported by the sending context (it can be seen as a service). If such a callback object is supported its IOR may be added to an optional service context in the GIOP header passed from the sending context to the receiving context.

A service context tagged with the ServiceID **SendingContextRunTime** (see Section 13.7, “Service Context,” on page 13-28) contains an encapsulation of the IOR for a **SendingContext::RunTime** object. Because ORBs are always free to skip a service context they don’t understand, this addition does not impact IIOP interoperability.

```

module SendingContext {

 interface RunTime {}; // so that we can provide more
 // sending context run time
 // services in the future

 interface CodeBase: RunTime {
 typedef string URL; // blank-separated list of one or more URLs
 typedef sequence<URL> URLSeq;
 typedef sequence
 <CORBA::ValueDef::FullValueDescription> ValueDescSeq;

 // Operation to obtain the IR from the sending context
 CORBA::Repository get_ir();

 // Operations to obtain a location of the implementation code
 URL implementation(in CORBA::RepositoryId x);
 URLSeq implementations(in CORBA::RepositoryIdSeq x);

 // Operations to obtain complete meta information about a Value
 // This is just a performance optimization the IR can provide
 // the same information
 CORBA::FullValueDescription meta(in CORBA::RepositoryId x);
 ValueDescSeq metas(in CORBA::RepositoryIdSeq x);

 // To obtain a type graph for a value type
 // same comment as before the IR can provide similar
 // information
 CORBA::RepositoryIdSeq bases(in CORBA::RepositoryId x);
 };
};

```

---

Supporting the **CodeBase** interface for a given ORB run time is an issue of quality of service. The point here is that if the sending context does not support a **CodeBase**, then the receiving context will simply raise an exception with which the sending context had to be prepared to deal. There will always be cases where a receiving context will get a value type and won't be able to interpret it because:

- It can't get a legal implementation for it (even if it knows where it is, possibly due to security and/or resource access issues).
- Its local version is so radically different that it cannot make sense out of the piece of state being provided.

These two failure modes will be represented by the CORBA system exception **NO\_IMPLEMENT** with identified minor codes, for a missing local value implementation and for incompatible versions (see Section 4.12.4, "Standard Minor Exception Codes," on page 4-72).

Under certain conditions it is possible that when several values of the same CORBA type (same repository id) are sent in either a request or reply, that the reality is that they have distinct implementations. In this case, in addition to the codebase URL(s) sent in the service context, each value that has a different codebase may have codebase URL(s) associated with it. This is encoded by using a different tag to encode the value on the wire.

The sending context does not need to resend the same value for this service context on subsequent requests over the same underlying connection. Resending a different value for this service context is only necessary if the callback object reference in use is changed by the sending context within the lifetime of the underlying connection.



This chapter describes the semantics of abstract interfaces.

## Contents

This chapter contains the following sections.

| Section Title                      | Page |
|------------------------------------|------|
| “Overview”                         | 6-1  |
| “Semantics of Abstract Interfaces” | 6-1  |
| “Usage Guidelines”                 | 6-3  |
| “Example”                          | 6-3  |
| “Security Considerations”          | 6-4  |

## 6.1 Overview

In many cases it may be useful to defer the determination of whether an object is passed by reference or by value until runtime. An IDL abstract interface provides this capability. See Section 6.4, “Example,” on page 6-3 for an example of when this might be useful.

## 6.2 Semantics of Abstract Interfaces

Abstract interfaces differ from regular IDL interfaces in the following ways:

1. When used in an operation signature, they do not determine whether actual parameters are passed as an object reference or by value. Instead, the type of the actual parameter (regular interface or value) is used to make this determination using the following rules:
  - The actual parameter is passed as an object reference if it is a regular interface type (or a subtype of a regular interface type), and that regular interface type is a subtype of the signature abstract interface type, and the object is already registered with the ORB/OA.
  - The actual parameter is passed as a value if it cannot be passed as an object reference but can be passed as a value. Otherwise, a `BAD_PARAM` exception is raised.
2. Abstract interfaces do not implicitly inherit from **CORBA::Object**. This is because they can represent either value types or CORBA object references, and value types do not necessarily support the object reference operations (see Section 4.3, “Object Reference Operations,” on page 4-12). If an IDL abstract interface type can be successfully narrowed to an object reference type (a regular IDL interface), then the **CORBA::Object** operations can be invoked on the narrowed object reference.
3. Abstract interfaces implicitly inherit from **CORBA::AbstractBase**. This type is defined as native. It is the responsibility of each language mapping to specify the actual programming language type that is used for this type.

```

module CORBA {
 // IDL
 native AbstractBase;
};

```

4. Abstract interfaces do not imply copy semantics for value types passed as arguments to their operations. This is because their operations may be either CORBA invocations (for abstract interfaces that represent CORBA object references) or local programming language calls (for abstract interfaces that represent CORBA value types). See Section 5.2.2, “Operations,” on page 5-3 and Section 5.2.4, “Parameter Passing,” on page 5-4 for details of these differences.
5. Special inheritance rules that apply to abstract interfaces are described in Section 3.8.6, “Abstract Interface,” on page 3-26.
6. See Section 15.3.7, “Abstract Interfaces,” on page 15-30 for special consideration when transmitting an abstract interface using GIOP.

In other respects, abstract interfaces are identical to regular IDL interfaces.

For example, consider the following operation **m1()** in abstract interface **foo**.

```

abstract interface foo {
 void m1(in AnInterfaceType x, in AnAbstractInterfaceType y,
 in AValueType z);
};

```

**x**'s are always passed by reference,



**z**'s are:

- passed as copied values if **foo** refers to an ordinary interface.
- passed as non-copied values if **foo** refers to a value type

**y**'s are:

- passed as reference if their concrete type is an ordinary interface subtype of **AnAbstractInterfaceType** (registered with the ORB), no matter what **foo**'s concrete type is.
- passed as copied values if their concrete type is value and **foo**'s concrete type is ordinary interface.
- passed as non-copied values if their concrete type is value and **foo**'s concrete type is value.

### 6.3 Usage Guidelines

Abstract interfaces are intended for situations where it cannot be known at compile time whether an object reference or a value will be passed. In other cases, a regular interface or value type should be used. Abstract interfaces are not intended to replace regular CORBA interfaces in situations where there is no clear need to provide runtime flexibility to pass either an object reference or a value. If reference semantics are intended, regular interfaces should be used.

### 6.4 Example

For example, in a business application it is extremely common to need to display a list of objects of a given type, with some identifying attribute like account number and a translated text description such as "Savings Account." A developer might define an interface such as **Describable** whose methods provide this information, and implement this interface on a wide range of types. This allows the method that displays items to take an argument of type **Describable** and query it for the necessary information. The **Describable** objects passed in to the **display** method may be either CORBA interface types (passed in as object references) or CORBA value types (passed in by value).

In this example, **Describable** is used as a polymorphic abstract type. No instances of type **Describable** exist, but many different instances have interfaces that support the **Describable** type abstraction. In C++, **Describable** would be an abstract base class; in Java, an interface. In statically typed languages, the compiler can check that the actual parameter type passed by callers of **display** is a valid subtype of **Describable** and therefore supports the methods defined by **Describable**. The **display** method can simply invoke the methods of **Describable** on the objects that it receives, without concern for any details of their implementation.

**Describable** could not be declared as a regular IDL interface. This is because arguments of declared interface type are always passed as object references (see Section 5.2.4, "Parameter Passing," on page 5-4) and we also want the **display** method to be able to accept value type objects that can only be passed by value. Similarly we

cannot define **Describable** as a value type because then the **display** method would not be able to accept actual parameter objects that only support passing as an object reference. Abstract interfaces are needed to cover such cases.

The **Describable** abstract interface could be defined and used by the following IDL:

```
abstract interface Describable {
 string get_description();
};

interface Example {
 void display (in Describable anObject);
};

interface Account : Describable { // passed by reference
 // add Account methods here
};

valuetype Currency supports Describable { // passed by value
 // add Currency methods here
};
```

If **Describable** were defined as a regular interface instead of an abstract interface, then it would not be possible to pass a **Currency** value to the display method, even though the **Currency** IDL type supports the **Describable** interface.

## 6.5 Security Considerations

Security considerations for abstract interfaces are similar to those for regular interfaces and values (see Section 5.2.9, “Security Considerations,” on page 5-7). This is because an abstract interface formal parameter type allows either a regular interface (IOR) or a value to be passed. Likewise, an operation defined in an abstract interface can be implemented by either a regular interface (with “normal” security considerations) or by a value type (in which case it is a local call, not mediated by the ORB). The security implication of making the choice between these alternatives a runtime determination is that the programmer must ensure that for both alternatives, no security violations can occur. For example, a technique similar to that described in Section 6.5.1, “Passing Values to Trusted Domains,” on page 6-4 could be used to avoid inadvertently passing values outside a domain of trust.

### 6.5.1 Passing Values to Trusted Domains

When a server passes an object reference, it can be sure that access control policies will apply to any attempt to access anything through that object reference. When the underlying object is passed as a value, the granularity and level/semantics of access control are different. In the “by value” case, all the data for the object is passed, and method invocations on the passed object are local calls that are not mediated by the

ORB. Whether the server wants to use the (potentially more permissive) pass by value access control or not could depend on the security domain, which is receiving the said object or object reference.

Consider the case where the server S has an object O that it is willing to pass only in the form of an object reference Or' to a domain Du that it does not trust, but is willing to pass the object by value Ow to another domain Ot that it trusts.

This flexibility is not possible without abstract interfaces. Signatures would have to be written to either always pass references or always pass values, irrespective of the level of trust of the invocation target domain. However, abstract interfaces provide the necessary flexibility. The formal parameter type **MyType** can be declared as an abstract interface and the method invocation can be coded along the lines of

```
myExample->foo(security_check(myExample,mydata));
```

where the **security\_check** function determines the level of trust of **myExample**'s domain and returns an regular interface subtype of **MyType** for untrusted domains and a value subtype of **MyType** for trusted domains. The rules for abstract interfaces will then pass the correct thing in both these cases.



# Dynamic Invocation Interface

The Dynamic Invocation Interface (DII) describes the client's side of the interface that allows dynamic creation and invocation of request to objects. All types defined in this chapter are part of the CORBA module.

## Contents

This chapter contains the following sections.

| Section Title        | Page |
|----------------------|------|
| "Overview"           | 7-1  |
| "Request Operations" | 7-4  |
| "ORB Operations"     | 7-11 |
| "Polling"            | 7-12 |
| "List Operations"    | 7-16 |

## 7.1 Overview

The Dynamic Invocation Interface (DII) allows dynamic creation and invocation of requests to objects. A client using this interface to send a request to an object obtains the same semantics as a client using the operation stub generated from the type specification.

A request consists of an object reference, an operation, and a list of parameters. The ORB applies the implementation-hiding (encapsulation) principle to requests.

In the Dynamic Invocation Interface, parameters in a request are supplied as elements of a list. Each element is an instance of a **NamedValue** (see Section 7.1.1, "Common Data Structures," on page 7-2). Each parameter is passed in its native data form.

Parameters supplied to a request may be subject to run-time type checking upon request invocation. Parameters must be supplied in the same order as the parameters defined for the operation in the Interface Repository.

The standard user exception `WrongTransaction` is defined in the CORBA module, prior to the definitions of the ORB and Request interfaces, as follows:

```
exception WrongTransaction {};
```

This exception can be raised only if the request is implicitly associated with a transaction (the current transaction at the time that the request was issued).

### 7.1.1 Common Data Structures

The type `NamedValue` is a well-known data type in OMG IDL. It can be used either as a parameter type directly or as a mechanism for describing arguments to a request. The types are described in OMG IDL as:

```
module CORBA {

 typedef unsigned long Flags;

 struct NamedValue { PIDL
 Identifier name; // argument name
 any argument; // argument
 long len; // length/count of argument value
 Flags arg_modes; // argument mode flags
 };

};
```

For out parameters, applications can set the `argument` member of the `NamedValue` structure to a value that includes either a NULL or a non-NULL storage pointer. If a non-null storage pointer is provided for an out parameter, the ORB will attempt to use the storage pointed to for holding the value of the out parameter. If the storage pointed to is not sufficient to hold the value of the out parameter, the behavior is undefined.

A named value includes an argument name, argument value (as an `any`), length of the argument, and a set of argument mode flags. When named value structures are used to describe arguments to a request, the names are the argument identifiers specified in the OMG IDL definition for a specific operation.

As described in Section 19.7, “Mapping for Basic Data Types,” on page 19-10, an `any` consists of a `TypeCode` and a pointer to the data value. The `TypeCode` is a well-known opaque type that can encode a description of any type specifiable in OMG IDL. See this section for a full description of `TypeCodes`.

For most data types, **len** is the actual number of bytes that the value occupies. For object references, **len** is 1. Table 7-1 shows the length of data values for the C language binding. The behavior of a **NamedValue** is undefined if the **len** value is inconsistent with the TypeCode.

Table 7-1 C Type Lengths

| Data type: X          | Length (X)                                                              |
|-----------------------|-------------------------------------------------------------------------|
| short                 | sizeof (CORBA_short)                                                    |
| unsigned short        | sizeof (CORBA_unsigned_short)                                           |
| long                  | sizeof (CORBA_long)                                                     |
| unsigned long         | sizeof (CORBA_unsigned_long)                                            |
| long long             | sizeof (CORBA_long_long)                                                |
| unsigned long long    | sizeof (CORBA_unsigned_long_long)                                       |
| float                 | sizeof (CORBA_float)                                                    |
| double                | sizeof (CORBA_double)                                                   |
| long double           | sizeof (CORBA_long_double)                                              |
| fixed<d,s>            | sizeof (CORBA_fixed_d_s)                                                |
| char                  | sizeof (CORBA_char)                                                     |
| wchar                 | sizeof (CORBA_wchar)                                                    |
| boolean               | sizeof (char)                                                           |
| octet                 | sizeof (CORBA_octet)                                                    |
| string                | strlen (string) /* does NOT include '\0' byte! */                       |
| wstring               | number of wide characters in string, not including wide null terminator |
| enum E {};            | sizeof (CORBA_enum)                                                     |
| union U { };          | sizeof (U)                                                              |
| struct S { };         | sizeof (S)                                                              |
| Object                | 1                                                                       |
| array N of type T1    | Length (T1) * N                                                         |
| sequence V of type T2 | Length (T2) * V /* V is the actual, dynamic, number of elements */      |

The **arg\_mode** field is of type **Flags** which is an **unsigned long**. This field is used as follows in this structure. It should be noted that **Flags** type is used as parameter type in many operations and the meaning of the constants passed in those cases are

specific to those operations. Those values should not be confused with the specific use of this type in the context of the **NamedValue** structure. These values are reserved, as are the high order 16 bits of the **unsigned long**:

|                  |   |                                                  |
|------------------|---|--------------------------------------------------|
| CORBA::ARG_IN    | 1 | The associated value is an input only argument.  |
| CORBA::ARG_OUT   | 2 | The associated value is an output only argument. |
| CORBA::ARG_INOUT | 3 | The associated value is an in/out argument.      |

The specific usage of **Flags** in other contexts are described as part of the description of the operation that uses this type of parameters.

### 7.1.2 Memory Usage

The values for output argument data types that are unbounded strings or unbounded sequences are returned as pointers to dynamically allocated memory. In order to facilitate the freeing of all “out-arg memory,” the request routines provide a mechanism for grouping, or keeping track of, this memory. If so specified, out-arg memory is associated with the argument list passed to the create request routine. When the list is deleted, the associated out-arg memory will automatically be freed.

If the programmer chooses not to associate out-arg memory with an argument list, the programmer is responsible for freeing each out parameter using **CORBA\_free()**, which is discussed in the *C Language Mapping* specification (*Mapping for Structure Types* section).

### 7.1.3 Return Status and Exceptions

In the Dynamic Invocation interface, routines typically indicate errors or exceptional conditions either via programming language exception mechanisms, or via an Environment parameter for those languages that do not support exceptions. Thus, the return type of these routines is void.

## 7.2 Request Operations

The request operations (except **create\_request**) are defined in terms of the **Request** pseudo-object. The **Request** routines use the **NVList** definition defined in the preceding section.

```

module CORBA {

 native OpaqueValue;

 interface Request { // PIDL

 void add_arg (

```



```

 in Identifier name, // argument name
 in TypeCode arg_type, // argument datatype
 in OpaqueValue value, // argument value to be added
 in long len, // length/count of argument value
 in Flags arg_flags // argument flags
);

 void invoke (
 in Flags invoke_flags // invocation flags
);

 void delete ();

 void send (
 in Flags invoke_flags // invocation flags
);

 void get_response () raises (WrongTransaction);

 boolean poll_response();

 Object sendp();

 void prepare(in Object p);

 void sendc(in Object handler);
};
};

```

In IDL, The **native** type **OpaqueValue** is used to identify the type of the implementation language representation of the value that is to be passed as a parameter. For example in the C language this is the C language type (**void \***). Each language mapping specifies what **OpaqueValue** maps to in that specific language.

For each **Request** pseudo-object instance, only one call to either the **invoke** or the **send** operations is legal during the lifetime of the **Request** object. In addition, once a **Request** object was passed to one of the **send\_multiple\_requests\_\*** operations, neither **invoke** nor **send** can be called, nor can it be passed in another invocation of **send\_multiple\_request\_\*** operation. Violations raise **BAD\_INV\_ORDER** with standard minor code 5.

### 7.2.1 *create\_request*

Because it creates a pseudo-object, this operation is defined in the **Object** interface (see Section 4.3, “Object Reference Operations,” on page 4-12 for the complete interface definition). The **create\_request** operation is performed on the **Object** that is to be invoked.

```

module CORBA{

 interface Object{ // PIDL

 void create_request (
 in Context ctx, // context object for operation
 in Identifier operation, // intended operation on object
 in NVList arg_list, // args to operation
 inout NamedValue result, // operation result
 out Request request, // newly created request
 in Flags req_flags // request flags
);
 };
};

```

This operation creates an ORB request. The actual invocation occurs by calling **invoke** or by using the **send / get\_response** calls.

The operation name specified on **create\_request** is the same operation identifier that is specified in the OMG IDL definition for this operation. In the case of attributes, it is the name as constructed following the rules specified in the **ServerRequest** interface as described in the DSI in Section 8.3, “ServerRequestPseudo-Object,” on page 8-3.

The **arg\_list**, if specified, contains a list of arguments (input, output, and/or input/output) that become associated with the request. If **arg\_list** is omitted (specified as **NULL**), the arguments (if any) must be specified using the **add\_arg** call below.

Arguments may be associated with a request by passing in an argument list or by using repetitive calls to **add\_arg**. One mechanism or the other may be used for supplying arguments to a given request; a mixture of the two approaches is not supported.

If specified, the **arg\_list** becomes associated with the request; until the **invoke** call has completed (or the request has been deleted), the ORB assumes that **arg\_list** (and any values it points to) remains unchanged.

When specifying an argument list, the **value** and **len** for each argument must be specified. An argument’s datatype, name, and usage flags (i.e., in, out, inout) may also be specified; if so indicated, arguments are validated for data type, order, name, and usage correctness against the set of arguments expected for the indicated operation.

An implementation of the request services may relax the order constraint (and allow arguments to be specified out of order) by doing ordering based upon argument name.

The context properties associated with the operation are passed to the object implementation. The object implementation may not modify the context information passed to it.

The operation result is placed in the **result** argument after the invocation completes.

The **req\_flags** argument is defined as a bitmask (**long**) that may contain the following flag values:

**CORBA::OUT\_LIST\_MEMORY** indicates that any out-arg memory is associated with the argument list (**NVList**).

Setting the **OUT\_LIST\_MEMORY** flag controls the memory allocation mechanism for out-arg memory (output arguments, for which memory is dynamically allocated). If **OUT\_LIST\_MEMORY** is specified, an argument list must also have been specified on the **create\_request** call. When output arguments of this type are allocated, they are associated with the list structure. When the list structure is freed (see below), any associated out-arg memory is also freed.

If **OUT\_LIST\_MEMORY** is *not* specified, then each piece of out-arg memory remains available until the programmer explicitly frees it with procedures provided by the language mappings (see the *C Language Mapping* specification, *Argument Passing Considerations* section; *C++ Language Mapping* specification, *NVList* section; and the *COBOL Language Mapping* specification, *Argument Passing Considerations* section).

The implicit object reference operations **non\_existent**, **is\_a**, and **get\_interface** may be invoked using DII. No other implicit object reference operations may be invoked via DII.

To create a request for any one of these allowed implicit object reference operations, **create\_request** must be passed the name of the operation with a “\_” prepended, in the parameter “operation.” For example to create a DII request for “**is\_a**”, the name passed to **create\_request** must be “\_is\_a.” If the name of an implicit operation that is not invocable through DII is passed to **create\_request** with a “\_” prepended, **create\_request** shall raise a **BAD\_PARAM** standard system exception with the standard minor code 32. For example, if “\_is\_equivalent” is passed to **create\_request** as the “operation” parameter will cause **create\_request** to raise the **BAD\_PARAM** standard system exception with the standard minor code 32.

### 7.2.2 *add\_arg*

```

void add_arg (
 in Identifier name, // PIDL
 in TypeCode arg_type, // argument name
 in OpaqueValue value, // argument datatype
 in long len, // argument value to be added
 in Flags arg_flags // length/count of argument value
);

```

**add\_arg** incrementally adds arguments to the request.

For each argument, minimally its **value** and **len** must be specified. An argument’s data type, name, and usage flags (i.e., in, out, inout) may also be specified. If so indicated, arguments are validated for data type, order, name, and usage correctness against the set of arguments expected for the indicated operation.

An implementation of the request services may relax the order constraint (and allow arguments to be specified out of order) by doing ordering based upon argument name.

The arguments added to the request become associated with the request and are assumed to be unchanged until the invoke has completed (or the request has been deleted).

Arguments may be associated with a request by specifying them on the **Object::create\_request** call or by adding them via calls to **add\_arg**. Using both methods for specifying arguments for the same request is not supported.

In addition to the argument modes defined in Section 7.1.1, “Common Data Structures,” on page 7-2, **arg\_flags** may also take the flag value **IN\_COPY\_VALUE**. The argument passing flags defined in Section 7.1.1, “Common Data Structures,” on page 7-2 may be used here to indicate the intended parameter passing mode of an argument.

If the **IN\_COPY\_VALUE** flag is set, a copy of the argument value is made and used instead. This flag is ignored for inout and out arguments.

### 7.2.3 *invoke*

```
void invoke (// PIDL
 in Flags invoke_flags // invocation flags
);
```

This operation calls the ORB, which performs method resolution and invokes an appropriate method. If the method returns successfully, its result is placed in the **result** argument specified on **create\_request**. Calling **invoke** on a **Request** after **invoke**, **send**, or **ORB::send\_multiple\_requests** for that **Request** was called raises **BAD\_INV\_ORDER** with standard minor code 10.

### 7.2.4 *delete*

```
void delete (); // PIDL
```

This operation deletes the request. Any memory associated with the request (i.e., by using the **IN\_COPY\_VALUE** flag) is also freed.

### 7.2.5 *send*

```
void send (// PIDL
 in Flags invoke_flags // invocation flags
);
```

**Send** initiates an operation according to the information in the **Request**. Unlike **invoke**, **send** returns control to the caller without waiting for the operation to finish. To determine when the operation is done, the caller must use the **get\_response** or **ORB::get\_next\_response** operations described below. The out parameters and return value must not be used until the operation is done.

Although it is possible for some standard system exceptions to be raised by the **send** operation, there is no guarantee that all possible errors will be detected. For example, if the object reference is not valid, **send** might detect it and raise an exception, or might return before the object reference is validated, in which case the exception will be raised when **get\_response** is called.

If the operation is defined to be oneway or if **INV\_NO\_RESPONSE** is specified, and the effective **SyncScopePolicy** does not have a value of **WITH\_SERVER** or **WITH\_TARGET**, then **get\_response** does not need to be called. In such cases, some errors might go unreported, since if they are not detected before **send** returns there is no way to inform the caller of the error.

The following invocation flags are currently defined for **send**:

**CORBA::INV\_NO\_RESPONSE** indicates that the invoker wishes the request to be subject to the effective **SyncScopePolicy**. If the **SyncScopePolicy** has a value of **NONE** or **WITH\_TRANSPORT**, the invoker will not receive a response, nor does it expect any of the output arguments (in/out and out) to be updated. This option may be specified even if the operation has not been defined to be **oneway**.

### 7.2.6 *poll\_response*

```
// PIDL
boolean poll_response ();
```

**poll\_response** determines whether the request has completed. A **TRUE** return indicates that it has; **FALSE** indicates it has not.

Return is immediate, whether the response has completed or not. Values in the request are not changed.

### 7.2.7 *get\_response*

```
//PIDL
void get_response () raises (WrongTransaction);
```

**get\_response** returns the result of a request. If **get\_response** is called before the request has completed, it blocks until the request has completed. Upon return, the out parameters and return values defined in the **Request** are set appropriately and they may be treated as if the **Request** invoke operation had been used to perform the request.

A request has an associated transaction context if the thread originating the request had a non-null transaction context and the target object is a transactional object. The **get\_response** operation may raise the **WrongTransaction** exception if the request has an associated transaction context, and the thread invoking **get\_response** either has a null transaction context or a non-null transaction context that differs from that of the request.

### 7.2.8 *sendp*

**sendp** initiates an operation according to the information in the Request and returns a reference to a **MessageRouting::PersistentRequest** as a **CORBA::Object**. As with **send**, the results of invocations made with **sendp** will be available once the caller uses **get\_response** or **get\_next\_response**. The out parameters and return value must not be used before the operation is done. A new **CORBA::Request** may be constructed (in this same or a different process) and used to poll for the response to this request by calling **create\_request**, properly associating the out arguments and return value with that request and then passing the **PersistentRequest** reference to the new Request's **prepare** (described below). The caller can then invoke **get\_response** or **get\_next\_response** to obtain the operation results.

As with **send**, **sendc** may raise a standard system exception if a failure is detected before control is returned to the client, but this is not guaranteed. All other exceptions will be raised when **get\_response** is called.

### 7.2.9 *prepare*

**prepare** is called to associate an initialized **CORBA::Request** with a previous operation that was initiated via **sendp**. The Request must be created and associated with the operation's out arguments and return value prior to calling **prepare**. Once **prepare** has been called, it is as if that prepared Request was the one that actually had **sendp** used. Each Request is subject only to one of these operations, which puts it in a valid state for an invocation of **get\_response**: **send**, **sendp**, **sendc**, or **prepare**. Invoking **prepare** on a Request that had previously been used for a **send** (or one of its variants) raises the standard system exception **BAD\_INV\_ORDER**. Invoking **prepare** with an object reference that was not previously returned from an invocation of **sendp** raises the standard system exception **BAD\_PARAM**.

### 7.2.10 *sendc*

**sendc** initiates an operation according to the information in the Request. Unlike **send**, the results of invocations made with **sendc** will be available through the callback **Messaging::ReplyHandler** passed into **sendc** as a base **CORBA::Object**. A truly dynamic client can implement this **ReplyHandler** using the DSI. Specifying a nil **ReplyHandler** is equivalent to invoking **send** with a flag of **CORBA::INV\_NO\_RESPONSE**.

As with **send**, **sendc** may raise a standard system exception if a failure is detected before control is returned to the client, but this is not guaranteed. All other exceptions will be passed to the **ReplyHandler**.

## 7.3 ORB Operations

### 7.3.1 *send\_multiple\_requests*

```

module CORBA {

 interface Request; // forward declaration
 typedef sequence <Request> RequestSeq;

 interface ORB {

 void send_multiple_requests_oneway(
 in RequestSeq req
);

 void send_multiple_requests_deferred(
 in RequestSeq req
);
 };
};

```

**send\_multiple\_requests** initiates more than one request in parallel. Like **send**, **send\_multiple\_requests** returns to the caller without waiting for the operations to finish. To determine when each operation is done, the caller must use the **Request::get\_response** or **get\_next\_response** operations.

Calling **send** on a request after **invoke**, **send**, or **send\_multiple\_requests** for that request was called raises **BAD\_INV\_ORDER** with standard minor code 10.

Calling **send\_multiple\_requests** for a request after **invoke**, **send**, or **send\_multiple\_requests** for that request was called raises **BAD\_INV\_ORDER** with standard minor code 10. If **send\_multiple\_requests** raises **BAD\_INV\_ORDER**, the actual number of requests that were sent is implementation dependent.

### 7.3.2 *get\_next\_response and poll\_next\_response*

```

module CORBA {

 interface Request; // forward declaration
 typedef sequence <Request> RequestSeq;

 interface ORB {

 boolean poll_next_response();

 void get_next_response(

```

```

 out Request req
) raises (WrongTransaction);
};
};

```

**Poll\_next\_response** determines whether any request has completed. A **TRUE** return indicates that at least one has; **FALSE** indicates that none have completed. Return is immediate, whether any response has completed or not.

**Get\_next\_response** returns the next request that completes. Despite the name, there is no guaranteed ordering among the completed requests, so the order in which they are returned from successive **get\_next\_response** calls is not necessarily related to the order in which they finish.

A request has an associated transaction context if the thread originating the request had a non-null transaction context and the target object is a transactional object. The **get\_next\_response** operation may raise the **WrongTransaction** exception if the request has an associated transaction context, and the thread invoking **get\_next\_response** has a non-null transaction context that differs from that of the request.

Calling **poll\_response** before **send** or **send\_multiple\_requests** for that request raises **BAD\_INV\_ORDER** with standard minor code 11. Calling **poll\_response** after calling **invoke** raises **BAD\_INV\_ORDER** with standard minor code 13. Calling **poll\_response** after calling **get\_response** raises **BAD\_INV\_ORDER** with standard minor code 12. Calling **poll\_response** after that request was returned by **get\_next\_response** raises **BAD\_INV\_ORDER** with standard minor code 12.

Calling **get\_next\_response** or **poll\_next\_response** at a time when no requests are outstanding raises **BAD\_INV\_ORDER** with standard minor code 11. If concurrent calls to **get\_next\_response** or **poll\_next\_response** are in progress, the exact outcome is implementation dependent; however, **get\_next\_response** is guaranteed not to return the same completed request to more than one caller.

## 7.4 Polling

There are two types of Polling model invocations that allow a client to proceed before the request finishes: The DII's **send** (which supports deferred synchronous invocations) and the typed **sendp** variants of the interface stubs (which support both deferred synchronous and asynchronous invocations). This section describes a single mechanism that allows a client to query or block on the completion of outstanding requests.

- For the typed polling model (**sendp**), a client invokes the request's type-specific **Poller** to receive the response. This poll can either block (wait for the completion) or return immediately if the request isn't finished yet, depending on the value of the first parameter. Alternately, a client can simply query whether the request has completed by using the generic non-blocking **CORBA::Pollable::is\_ready( )** operation defined on the base interface that is inherited by all type-specific pollers.



For the sake of efficiency, it must be possible to query or block on multiple async pollers in a single operation. To do this, it is necessary to identify precisely, which such pollers are to be polled.

- A client might want to mix deferred typed and dynamic operations. Deferred DII (in some unholy combination of language mappings) has operations somewhat similar to those of the typed **Poller: ORB::poll\_next\_response** and **ORB::get\_next\_response**. It should be possible to mix the two kinds of polling: typed and dynamic.
- Other potential happenings might occur that are susceptible to polling in current or future CORBA. This mechanism is designed for extensibility so that other ORB services can perform a poll as a part of the single poll operation described here.

The mechanism for generalized polling on multiple types of occurrences uses the **CORBA::PollableSet** interface.

```

module CORBA {

 local interface PollableSet;

 abstract valuetype Pollable {
 boolean is_ready(
 in unsigned long timeout
);

 PollableSet create_pollable_set();
 };

 abstract valuetype DIIPollable : Pollable { };

 local interface PollableSet {

 exception NoPossiblePollable { };
 exception UnknownPollable { };

 DIIPollable create_dii_pollable();

 void add_pollable(
 in Pollable potential
);

 Pollable get_ready_pollable(
 in unsigned long timeout
) raises(NoPossiblePollable);

 void remove(
 in Pollable potential
) raises(UnknownPollable);
 };

```

```
 unsigned short number_left();
 };
};
```

### 7.4.1 Abstract Valuetype Pollable

A **Pollable** supports queries to see if it is ready to be used, and can be registered with a pollable set to allow a single client thread to block on multiple potential happenings at the same time.

#### 7.4.1.1 *is\_ready*

```
 boolean is_ready(
 in unsigned long timeout
);
```

Returns the value **TRUE** if and only if the specific happening represented by the pollable is ready to be consumed. Returns the value **FALSE** if the pollable is not yet ready to be consumed. If the **timeout** argument is the maximum value for **unsigned long**, the operation will block until it can return the value **TRUE** indicating that its happening is ready to be consumed. If the **timeout** argument is the value 0, the operation returns immediately.

#### 7.4.1.2 *create\_pollable\_set*

```
 PollableSet create_pollable_set();
```

Once there is a **Pollable**, it is possible to create a set of such pollables, which can be queried or upon which a client can block. The **create\_pollable\_set** operation creates a **PollableSet** object reference for an object with an empty set of pollable entities.

### 7.4.2 Abstract Valuetype DIIPollable

The specific **Pollable** that indicates interest in DII requests. A **DIIPollable** can be used in conjunction with a pollable set to allow a client to block or poll for the completion of DII requests, similar to the use of **CORBA::ORB::get\_next\_response**. When the **DIIPollable** is returned from **PollableSet::poll**, the reply to some DII request must be ready for processing.

### 7.4.3 interface PollableSet

The pollable set contains potential happenings for which a poll can be performed. The client adds potential happenings to the set and later queries the set to see if any have occurred. **PollableSet** is a locality constrained object.

---

**Note** – There is a factory for **PollableSet** on the generic **Pollable** interface. Some implementation of this interface, such as a type-specific poller value, must first be accessible before a client can create a **PollableSet**.

---

#### 7.4.3.1 *create\_dii\_pollable*

```
DIIPollable create_dii_pollable();
```

Returns an instance of **DIIPollable** that can subsequently be registered to indicate interest in replies to DII requests.

#### 7.4.3.2 *add\_pollable*

```
void add_pollable(
 in Pollable potential
);
```

The **add\_pollable** operation adds a potential happening to the **PollableSet**. The supplied **Pollable** parameter is some implementation that can be polled for readiness. To register interest in DII requests, an instance of **DIIPollable** is added to the pollable set.

#### 7.4.3.3 *get\_ready\_pollable*

```
Pollable get_ready_pollable(
 in unsigned long timeout
) raises(NoPossiblePollable);
```

The **get\_ready\_pollable** operation asks the **PollableSet** if any of its potential happenings have occurred. The **timeout** parameter indicates how many milliseconds this call should wait until the response becomes available. If this timeout expires before a reply is available, the operation raises the standard system exception **TIMEOUT**. Any delegated invocations used by the implementation of this polling operation are subject to the single **timeout** parameter, which supersedes any ORB or thread-level timeout quality of service. Two specific values are of interest:

- 0 - the call is a non-blocking query that raises the standard system exception **NO\_RESPONSE** if the reply is not immediately available.
- $2^{32}-1$  - the maximum value for **unsigned long** indicates no timeout should be used. The query will not return until the reply is available.

If the **PollableSet** contains no potential happenings, the **NoPossiblePollable** exception is raised. If an actual happening is returned, the **PollableSet** removes that happening from the set. For the typed **Poller**, removing the happening is necessary since its usefulness ends once the **Poller** completes. In the case of a DII happening, there may still be deferred requests outstanding; if this is the case, the client application must add the **DIIPollable** again to the **PollableSet**.

When the **get\_ready\_pollable** operation blocks, the ORB has control of the thread and can process any work it has (such as receiving and dispatching requests through its Object Adapter). The **get\_ready\_pollable** operation can be used in an “event-style main loop” using **ORB::work\_pending** and **ORB::perform\_work**.

If the ORB supports multiple threads, one thread may be blocking on a **PollableSet** while another is adding and removing potential happenings from the set. It is valid for the **PollableSet** to change dynamically while a **poll** is in progress. If another thread’s **PollableSet::remove** operation leaves the **PollableSet** empty, any blocked threads raise the **NoPossiblePollable** exception.

#### 7.4.3.4 *remove*

```
void remove(
 in Pollable potential
) raises(UnknownPollable);
```

The **remove** operation deletes the potential happening identified by the **potential** parameter from the **PollableSet**. If it was not a member of the set, the **UnknownPollable** exception is raised.

#### 7.4.3.5 *number\_left*

```
unsigned short number_left();
```

The **number\_left** operation returns the number of potential happenings in the pollable set. A returned value of zero means that there are no potential happenings in the set, in which case a query on the set would raise the **NoPossibleHappening** exception.

## 7.5 *List Operations*

**NVList** is a pseudo-interface that facilitates manipulation of list of name value pairs. The operations that create **NVList** objects are defined in the **ORB** interface section of Chapter 4, but are described in this section. The **NVList** pseudo-interface is shown below.

```
interface NVList { // PIDL
 void add_item (
 in Identifier item_name, // name of item
 in TypeCode item_type, // item datatype
 in OpaqueValue value, // item value
 in long value_len, // length of item value
 in Flags item_flags // item flags
);
 void free ();
 void free_memory ();
```

```

 void get_count (
 out long count // number of entries in the list
);
 };

```

Interface **NVList** is defined in the CORBA module.

### 7.5.1 *create\_list*

This operation, which creates a pseudo-object, is defined in the ORB interface and excerpted below.

```

 void create_list (
 in long count, // number of items to allocate for list
 out NVList new_list // newly created list
);

```

This operation allocates a list and clears it for initial use. The specified count is a “hint” to help with the storage allocation. List items may be added to the list using the **add\_item** routine. Items are added starting with the “**slot()**,” in the next available slot.

An **NVList** is a partially opaque structure. It may only be allocated via a call to **create\_list**.

### 7.5.2 *add\_item*

```

 void add_item (
 in Identifier item_name, // PIDL
 in TypeCode item_type, // name of item
 in OpaqueValue value, // item datatype
 in long value_len, // item value
 in Flags item_flags, // length of item value
 in long value_len, // item flags
);

```

This operation adds a new item to the indicated list. The item is added after the previously added item.

In addition to the argument modes defined in Section 7.1.1, “Common Data Structures,” on page 7-2, **item\_flags** may also take the following flag values: **IN\_COPY\_VALUE**, **DEPENDENT\_LIST**. The argument passing flags defined in Section 7.1.1, “Common Data Structures,” on page 7-2 may be used here to indicate the intended parameter passing mode of an argument.

If the **IN\_COPY\_VALUE** flag is set, a copy of the argument value is made and used instead.

If a list structure is added as an item (e.g., a “sublist”), the **DEPENDENT\_LIST** flag may be specified to indicate that the sublist should be freed when the parent list is freed.

### 7.5.3 *free*

```
void free (); // PIDL
```

This operation frees the list structure and any associated memory (an implicit call to the list **free\_memory** operation is done).

### 7.5.4 *free\_memory*

```
void free_memory (); // PIDL
```

This operation frees any dynamically allocated out-arg memory associated with the list. The list structure itself is not freed.

### 7.5.5 *get\_count*

```
void get_count (// PIDL
 out long count // number of entries in the list
);
```

This operation returns the total number of items added to the list.

### 7.5.6 *create\_operation\_list*

This operation, which creates a pseudo-object, is defined in the ORB interface.

```
void create_operation_list (// PIDL
 in OperationDef oper, // operation
 out NVList new_list // argument definitions
);
```

This operation returns an **NVList** initialized with the argument descriptions for a given operation. The information is returned in a form that may be used in *Dynamic Invocation* requests. The arguments are returned in the same order as they were defined for the operation.

The list **free** operation is used to free the returned information.

The Dynamic Skeleton Interface (DSI) allows dynamic handling of object invocations. That is, rather than being accessed through a skeleton that is specific to a particular operation, an object's implementation is reached through an interface that provides access to the operation name and parameters in a manner analogous to the client side's Dynamic Invocation Interface. Purely static knowledge of those parameters may be used, or dynamic knowledge (perhaps determined through an Interface Repository) may also be used, to determine the parameters.

## Contents

This chapter contains the following sections.

| Section Title                | Page |
|------------------------------|------|
| "Introduction"               | 8-1  |
| "Overview"                   | 8-2  |
| "ServerRequestPseudo-Object" | 8-3  |
| "DSI: Language Mapping"      | 8-4  |

## 8.1 Introduction

The Dynamic Skeleton Interface is a way to deliver requests from an ORB to an object implementation that does not have compile-time knowledge of the type of the object it is implementing. This contrasts with the type-specific, OMG IDL-based skeletons, but serves the same architectural role.

DSI is the server side's analogue to the client side's Dynamic Invocation Interface (DII). Just as the implementation of an object cannot distinguish whether its client is using type-specific stubs or the DII, the client who invokes an object cannot determine whether the implementation is using a type-specific skeleton or the DSI to connect the implementation to the ORB.

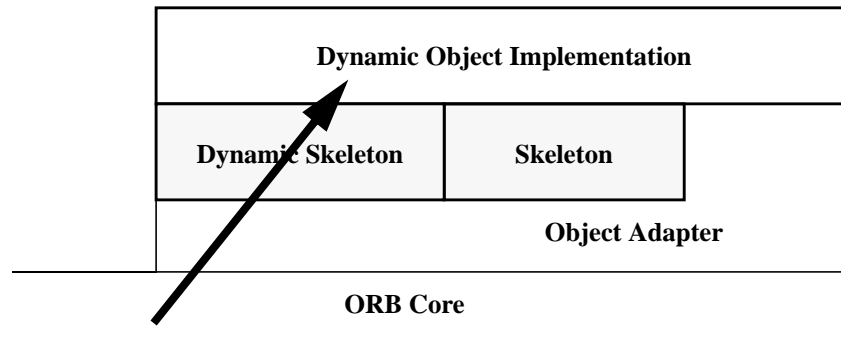

Figure 8-1 Requests are delivered through skeletons, including dynamic ones

DSI, like DII, has many applications beyond interoperability solutions. Uses include interactive software development tools based on interpreters, debuggers and monitors that want to dynamically interpose on objects, and support for dynamically-typed languages such as LISP.

## 8.2 Overview

The basic idea of the DSI is to implement all requests on a particular object by having the ORB invoke the same upcall routine, a Dynamic Implementation Routine (DIR). Since in any language binding all DIRs have the same signature, a single DIR could be used as the implementation for many objects, with different interfaces.

The DIR is passed all the explicit operation parameters, and an indication of the object that was invoked and the operation that was requested. The information is encoded in the request parameters. The DIR can use the invoked object, its object adapter, and the Interface Repository to learn more about the particular object and invocation. It can access and operate on individual parameters. It can make the same use of an object adapter as other object implementations.

This chapter describes the elements of the DSI that are common to all object adapters that provide a DSI. See Section 11.6.11, "Single Servant, Many Objects and Types, Using DSI," on page 11-64 for the specification of the DSI for the Portable Object Adapter.



## 8.3 *ServerRequestPseudo-Object*

### 8.3.1 *ExplicitRequest State: ServerRequestPseudo-Object*

The `ServerRequest` pseudo-object captures the explicit state of a request for the DSI, analogous to the `Request` pseudo-object in the DII. The object adapter dispatches an invocation to a DSI-based object implementation by passing an instance of `ServerRequest` to the DIR associated with the object implementation. The following shows how it provides access to the request information:

```

module CORBA {
 ...
 interface ServerRequest { // PIDL
 readonly attribute Identifier operation;
 void arguments(inout NVList nv);
 Context ctx();
 void set_result(in Any val);
 void set_exception(in Any val);
 };
};

```

The identity and/or reference of the target object of the invocation is provided by the object adapter and its language mapping. In the context of a bridge, the target object will typically be a proxy for an object in some other ORB.

The **operation** attribute provides the identifier naming the operation being invoked; according to OMG IDL's rules, these names must be unique among all operations supported by the object's "most-derived" interface. Note that the operation names for getting and setting attributes are **\_get\_<attribute\_name>** and **\_set\_<attribute\_name>**, respectively. The operation attribute can be accessed by the DIR at any time.

Operation parameter types will be specified, and "in" and "inout" argument values will be retrieved, with **arguments**. Unless it calls **set\_exception**, the DIR must call **arguments** exactly once, even if the operation signature contains no parameters. Once **arguments** or **set\_exception** has been called, calling **arguments** on the same **ServerRequest** will result in a `BAD_INV_ORDER` system exception with standard minor code 7. The DIR must pass in to **arguments** an **NVList** initialized with `TypeCodes` and `Flags` describing the parameter types for the operation, in the order in which they appear in the IDL specification (left to right). A potentially-different **NVList** will be returned from **arguments**, with the "in" and "inout" argument values supplied. If it does not call **set\_exception**, the DIR must supply the returned **NVList** with return values for any "out" arguments before returning, and may also change the return values for any "inout" arguments.

When the operation is not an attribute access, and the operation's IDL definition contains a context expression, **ctx** will return the context information specified in IDL for the operation. Otherwise it will return a nil **Context** reference. Calling **ctx** before

**arguments** has been called or after **ctx**, **set\_result**, or **set\_exception** has been called will result in a **BAD\_INV\_ORDER** system exception with standard minor code 8.

The **set\_result** operation is used to specify any return value for the call. Unless **set\_exception** is called, if the invoked operation has a non-void result type, **set\_result** must be called exactly once before the DIR returns. If the operation has a void result type, **set\_result** may optionally be called once with an **Any** whose type is **tk\_void**. Calling **set\_result** before **arguments** has been called or after **set\_result** or **set\_exception** has been called will result in a **BAD\_INV\_ORDER** system exception with standard minor code 8. Calling **set\_result** without having previously called **ctx** when the operation IDL contains a context expression will result in a **MARSHAL** system exception with standard minor code 2. If the **NVList** passed to **arguments** did not describe all parameters passed by the client, it may result in a **MARSHAL** system exception with standard minor code 3.

The DIR may call **set\_exception** at any time to return an exception to the client. The **Any** passed to **set\_exception** must contain either a system exception or one of the user exceptions specified in the **raises** expression of the invoked operation's IDL definition. Passing in an **Any** that does not contain an exception will result in a **BAD\_PARAM** system exception with standard minor code 21. Passing in an unlisted user exception will result in either the DIR receiving a **BAD\_PARAM** system exception with standard minor code 22 or in the client receiving an **UNKNOWN** system exception with standard minor code 1.

See each language mapping for a description of the memory management aspects of the parameters to the **ServerRequest** operations.

## 8.4 DSI: Language Mapping

Because DSI is defined in terms of a pseudo-object, special attention must be paid to it in the language mapping. This section provides general information about mapping the Dynamic Skeleton Interface to programming languages. Each language provides its own mapping for DSI.

### 8.4.1 *ServerRequest's Handling of Operation Parameters*

There is no requirement that a **ServerRequest** pseudo-object be usable as a general argument in OMG IDL operations, or listed in "orb.idl."

The client-side memory management rules normally applied to pseudo-objects do not strictly apply to a **ServerRequest's** handling of operation parameters. Instead, the memory associated with parameters follows the memory management rules applied to data passed from skeletons into statically typed implementation routines, and vice versa.

### *8.4.2 Registering Dynamic Implementation Routines*

In an ORB implementation, the Dynamic Skeleton Interface is supported entirely through the Object Adapter. An Object Adapter does not have to support the Dynamic Skeleton Interface but, if it does, the Object Adapter is responsible for the details.



## *Dynamic Management of Any Values* **9**

---

An **any** can be passed to a program that doesn't have any static information for the type of the **any** (code generated for the type by an IDL compiler has not been compiled with the object implementation). As a result, the object receiving the **any** does not have a portable method of using it.

The facility presented here enables traversal of the data value associated with an **any** at runtime and extraction of the primitive constituents of the data value. This is especially helpful for writing powerful generic servers (bridges, event channels supporting filtering).

Similarly, this facility enables the construction of an **any** at runtime, without having static knowledge of its type. This is especially helpful for writing generic clients (bridges, browsers, debuggers, user interface tools).

### *Contents*

This chapter contains the following sections.

| <b>Section Title</b>    | <b>Page</b> |
|-------------------------|-------------|
| "Overview"              | 9-1         |
| "DynAny API"            | 9-3         |
| "Usage in C++ Language" | 9-26        |

### *9.1 Overview*

Unless explicitly stated otherwise, all IDL presented in Section 9.1, "Overview," on page 9-1 through Section 9.3, "Usage in C++ Language," on page 9-26 is part of the **DynamicAny** module.

**Any** values can be dynamically interpreted (traversed) and constructed through **DynAny** objects. A **DynAny** object is associated with a data value, which corresponds to a copy of the value inserted into an **any**.

A **DynAny** object may be viewed as an ordered collection of component **DynAnys**. For **DynAnys** representing a basic type, such as **long**, or a type without components, such as an empty exception, the ordered collection of components is empty. Each **DynAny** object maintains the notion of a current position into its collection of component **DynAnys**. The current position is identified by an index value that runs from 0 to  $n-1$ , where  $n$  is the number of components. The special index value  $-1$  indicates a current position that points nowhere. For values that cannot have a current position (such as an empty exception), the index value is fixed at  $-1$ . If a **DynAny** is initialized with a value that has components, the index is initialized to 0. After creation of an uninitialized **DynAny** (that is, a **DynAny** that has no value but a **TypeCode** that permits components), the current position depends on the type of value represented by the **DynAny**. (The current position is set to 0 or  $-1$ , depending on whether the new **DynAny** gets default values for its components.)

The iteration operations **rewind**, **seek**, and **next** can be used to change the current position and the **current\_component** operation returns the component at the current position. The **component\_count** operation returns the number of components of a **DynAny**. Collectively, these operations enable iteration over the components of a **DynAny**, for example, to (recursively) examine its contents.

A constructed **DynAny** object is a **DynAny** object associated with a constructed type. There is a different interface, inheriting from the **DynAny** interface, associated with each kind of constructed type in IDL (fixed, enum, struct, sequence, union, array, exception, and valuetype).

A constructed **DynAny** object exports operations that enable the creation of new **DynAny** objects, each of them associated with a component of the constructed data value.

As an example, a **DynStruct** is associated with a struct value. This means that the **DynStruct** may be seen as owning an ordered collection of components, one for each structure member. The **DynStruct** object exports operations that enable the creation of new **DynAny** objects, each of them associated with a member of the struct.

If a **DynAny** object has been obtained from another (constructed) **DynAny** object, such as a **DynAny** representing a structure member that was created from a **DynStruct**, the member **DynAny** is logically contained in the **DynStruct**.

Destroying a top-level **DynAny** object (one that was not obtained as a component of another **DynAny**) also destroys any component **DynAny** objects obtained from it. Destroying a non-top level **DynAny** object does nothing. Invoking operations on a destroyed top-level **DynAny** or any of its descendants raises **OBJECT\_NOT\_EXIST**. Note that simply releasing all references to a **DynAny** object does not delete the **DynAny** or components; each **DynAny** created with one of the create operations or with the **copy** operation must be explicitly destroyed to avoid memory leaks.

If the programmer wants to destroy a **DynAny** object but still wants to manipulate some component of the data value associated with it, then he or she should first create a **DynAny** for the component and, after that, make a copy of the created **DynAny** object.

The behavior of **DynAny** objects has been defined in order to enable efficient implementations in terms of allocated memory space and speed of access. **DynAny** objects are intended to be used for traversing values extracted from **any**s or constructing values of **any**s at runtime. Their use for other purposes is not recommended.

## 9.2 *DynAny API*

The **DynAny** API comprises the following IDL definitions, located in the **DynamicAny** module:

```
// IDL
// File: DynamicAny.idl
#ifndef _DYNAMIC_ANY_IDL_
#define _DYNAMIC_ANY_IDL_

import ::CORBA;

module DynamicAny {
 typeprefix DynamicAny "omg.org";

 local interface DynAny {
 exception InvalidValue {};
 exception TypeMismatch {};

 CORBA::TypeCode type();

 void assign(in DynAny dyn_any) raises(TypeMismatch);
 void from_any(in any value) raises(TypeMismatch, InvalidValue);
 any to_any();

 boolean equal(in DynAny dyn_any);

 void destroy();
 DynAny copy();
 };
};
```

```
void insert_boolean(in boolean value)
 raises(TypeMismatch, InvalidValue);
void insert_octet(in octet value)
 raises(TypeMismatch, InvalidValue);
void insert_char(in char value)
 raises(TypeMismatch, InvalidValue);
void insert_short(in short value)
 raises(TypeMismatch, InvalidValue);
void insert_ushort(in unsigned short value)
 raises(TypeMismatch, InvalidValue);
void insert_long(in long value)
 raises(TypeMismatch, InvalidValue);
void insert_ulong(in unsigned long value)
 raises(TypeMismatch, InvalidValue);
void insert_float(in float value)
 raises(TypeMismatch, InvalidValue);
void insert_double(in double value)
 raises(TypeMismatch, InvalidValue);
void insert_string(in string value)
 raises(TypeMismatch, InvalidValue);
void insert_reference(in Object value)
 raises(TypeMismatch, InvalidValue);
void insert_typecode(in CORBA::TypeCode value)
 raises(TypeMismatch, InvalidValue);
void insert_longlong(in long long value)
 raises(TypeMismatch, InvalidValue);
void insert_ulonglong(in unsigned long long value)
 raises(TypeMismatch, InvalidValue);
void insert_longdouble(in long double value)
 raises(TypeMismatch, InvalidValue);
void insert_wchar(in wchar value)
 raises(TypeMismatch, InvalidValue);
void insert_wstring(in wstring value)
 raises(TypeMismatch, InvalidValue);
void insert_any(in any value)
 raises(TypeMismatch, InvalidValue);
void insert_dyn_any(in DynAny value)
 raises(TypeMismatch, InvalidValue);
void insert_val(in ValueBase value)
 raises(TypeMismatch, InvalidValue);

boolean get_boolean()
 raises(TypeMismatch, InvalidValue);
octet get_octet()
 raises(TypeMismatch, InvalidValue);
char get_char()
 raises(TypeMismatch, InvalidValue);
short get_short()
 raises(TypeMismatch, InvalidValue);
unsigned short get_ushort()
 raises(TypeMismatch, InvalidValue);
```



```

long get_long()
 raises(TypeMismatch, InvalidValue);
unsigned long get_ulong()
 raises(TypeMismatch, InvalidValue);
float get_float()
 raises(TypeMismatch, InvalidValue);
double get_double()
 raises(TypeMismatch, InvalidValue);
string get_string()
 raises(TypeMismatch, InvalidValue);
Object get_reference()
 raises(TypeMismatch, InvalidValue);
CORBA::TypeCode get_typecode()
 raises(TypeMismatch, InvalidValue);
long long get_longlong()
 raises(TypeMismatch, InvalidValue);
unsigned long long get_ulonglong()
 raises(TypeMismatch, InvalidValue);
long double get_longdouble()
 raises(TypeMismatch, InvalidValue);
wchar get_wchar()
 raises(TypeMismatch, InvalidValue);
wstring get_wstring()
 raises(TypeMismatch, InvalidValue);
any get_any()
 raises(TypeMismatch, InvalidValue);
DynAny get_dyn_any()
 raises(TypeMismatch, InvalidValue);
ValueBase get_val()
 raises(TypeMismatch, InvalidValue);

boolean seek(in long index);
void rewind();
boolean next();
unsigned long component_count();
DynAny current_component() raises(TypeMismatch);

void insert_abstract(in CORBA::AbstractBase value)
 raises(TypeMismatch, InvalidValue);
CORBA::AbstractBase get_abstract()
 raises(TypeMismatch, InvalidValue);

void insert_boolean_seq(in CORBA::BooleanSeq value)
 raises(TypeMismatch, InvalidValue);
void insert_octet_seq(in CORBA::OctetSeq value)
 raises(TypeMismatch, InvalidValue);
void insert_char_seq(in CORBA::CharSeq value)
 raises(TypeMismatch, InvalidValue);
void insert_short_seq(in CORBA::ShortSeq value)
 raises(TypeMismatch, InvalidValue);
void insert_ushort_seq(in CORBA::UShortSeq value)

```

```

 raises(TypeMismatch, InvalidValue);
void insert_long_seq(in CORBA::LongSeq value)
 raises(TypeMismatch, InvalidValue);
void insert_ulong_seq(in CORBA::ULongSeq value)
 raises(TypeMismatch, InvalidValue);
void insert_float_seq(in CORBA::FloatSeq value)
 raises(TypeMismatch, InvalidValue);
void insert_double_seq(in CORBA::DoubleSeq value)
 raises(TypeMismatch, InvalidValue);
void insert_longlong_seq(in CORBA::LongLongSeq value)
 raises(TypeMismatch, InvalidValue);
void insert_ulonglong_seq(in CORBA::ULongLongSeq value)
 raises(TypeMismatch, InvalidValue);
void insert_longdouble_seq(in CORBA::LongDoubleSeq value)
 raises(TypeMismatch, InvalidValue);
void insert_wchar_seq(in CORBA::WCharSeq value)
 raises(TypeMismatch, InvalidValue);

CORBA::BooleanSeq get_boolean_seq()
 raises(TypeMismatch, InvalidValue);
CORBA::OctetSeq get_octet_seq()
 raises(TypeMismatch, InvalidValue);
CORBA::CharSeq get_char_seq()
 raises(TypeMismatch, InvalidValue);
CORBA::ShortSeq get_short_seq()
 raises(TypeMismatch, InvalidValue);
CORBA::UShortSeq get_ushort_seq()
 raises(TypeMismatch, InvalidValue);
CORBA::LongSeq get_long_seq()
 raises(TypeMismatch, InvalidValue);
CORBA::ULongSeq get_ulong_seq()
 raises(TypeMismatch, InvalidValue);
CORBA::FloatSeq get_float_seq()
 raises(TypeMismatch, InvalidValue);
CORBA::DoubleSeq get_double_seq()
 raises(TypeMismatch, InvalidValue);
CORBA::LongLongSeq get_longlong_seq()
 raises(TypeMismatch, InvalidValue);
CORBA::ULongLongSeq get_ulonglong_seq()
 raises(TypeMismatch, InvalidValue);
CORBA::LongDoubleSeq get_longdouble_seq()
 raises(TypeMismatch, InvalidValue);
CORBA::WCharSeq get_wchar_seq()
 raises(TypeMismatch, InvalidValue);
};

local interface DynFixed : DynAny {
 string get_value();
 boolean set_value(in string val) raises(TypeMismatch, InvalidValue);
};

```

```

local interface DynEnum : DynAny {
 string get_as_string();
 void set_as_string(in string value) raises(InvalidValue);
 unsigned long get_as_ulong();
 void set_as_ulong(in unsigned long value) raises(InvalidValue);
};

typedef string FieldName;

struct NameValuePair {
 FieldName id;
 any value;
};

typedef sequence<NameValuePair> NameValuePairSeq;

struct NameDynAnyPair {
 FieldName id;
 DynAny value;
};

typedef sequence<NameDynAnyPair> NameDynAnyPairSeq;

local interface DynStruct : DynAny {
 FieldName current_member_name()
 raises(TypeMismatch, InvalidValue);
 CORBA::TCKind current_member_kind()
 raises(TypeMismatch, InvalidValue);
 NameValuePairSeq get_members();
 void set_members(in NameValuePairSeq value)
 raises(TypeMismatch, InvalidValue);
 NameDynAnyPairSeq get_members_as_dyn_any();
 void set_members_as_dyn_any(in NameDynAnyPairSeq value)
 raises(TypeMismatch, InvalidValue);
};

local interface DynUnion : DynAny {
 DynAny get_discriminator();
 void set_discriminator(in DynAny d) raises(TypeMismatch);
 void set_to_default_member() raises(TypeMismatch);
 void set_to_no_active_member() raises(TypeMismatch);
 boolean has_no_active_member();
 CORBA::TCKind discriminator_kind();
 DynAny member() raises(InvalidValue);
 FieldName member_name() raises(InvalidValue);
 CORBA::TCKind member_kind() raises(InvalidValue);
};

typedef sequence<any> AnySeq;
typedef sequence<DynAny> DynAnySeq;

```

```
local interface DynSequence : DynAny {
 unsigned long get_length();
 void set_length(in unsigned long len) raises(InvalidValue);
 AnySeq get_elements();
 void set_elements(in AnySeq value)
 raises(TypeMismatch, InvalidValue);
 DynAnySeq get_elements_as_dyn_any();
 void set_elements_as_dyn_any(in DynAnySeq value)
 raises(TypeMismatch, InvalidValue);
};

local interface DynArray : DynAny {
 AnySeq get_elements();
 void set_elements(in AnySeq value)
 raises(TypeMismatch, InvalidValue);
 DynAnySeq get_elements_as_dyn_any();
 void set_elements_as_dyn_any(in DynAnySeq value)
 raises(TypeMismatch, InvalidValue);
};

local interface DynValueCommon : DynAny {
 boolean is_null();
 void set_to_null();
 void set_to_value();
};

local interface DynValue : DynValueCommon {
 FieldName current_member_name()
 raises(TypeMismatch, InvalidValue);
 CORBA::TCKind current_member_kind()
 raises(TypeMismatch, InvalidValue);
 NameValuePairSeq get_members()
 raises(InvalidValue);
 void set_members(in NameValuePairSeq value)
 raises(TypeMismatch, InvalidValue);
 NameDynAnyPairSeq get_members_as_dyn_any()
 raises(InvalidValue);
 void set_members_as_dyn_any(in NameDynAnyPairSeq value)
 raises(TypeMismatch, InvalidValue);
};

local interface DynValueBox : DynValueCommon {
 any get_boxed_value()
 raises(InvalidValue);
 void set_boxed_value(in any boxed)
 raises(TypeMismatch, InvalidValue);
 DynAny get_boxed_value_as_dyn_any()
 raises(InvalidValue);
 void set_boxed_value_as_dyn_any(in DynAny boxed)
 raises(TypeMismatch);
};
```

```

exception MustTruncate { };

local interface DynAnyFactory {
 exception InconsistentTypeCode {};
 DynAny create_dyn_any(in any value)
 raises(InconsistentTypeCode);
 DynAny
 create_dyn_any_from_type_code(in CORBA::TypeCode type)
 raises(InconsistentTypeCode);

 DynAny create_dyn_any_without_truncation(in any value)
 raises(InconsistentTypeCode, MustTruncate);
 DynAnySeq create_multiple_dyn_anys(
 in AnySeq values,
 in boolean allow_truncate)
 raises(InconsistentTypeCode, MustTruncate);

 AnySeq create_multiple_anys(in DynAnySeq values);
};
}; // module DynamicAny
#endif // _DYNAMIC_ANY_IDL_

```

### 9.2.1 Creating a DynAny Object

A **DynAny** object can be created as a result of:

- invoking an operation on an existing **DynAny** object
- invoking an operation on a **DynAnyFactory** object

A constructed **DynAny** object supports operations that enable the creation of new **DynAny** objects encapsulating access to the value of some constituent. **DynAny** objects also support the **copy** operation for creating new **DynAny** objects.

In addition, **DynAny** objects can be created by invoking operations on the **DynAnyFactory** object. A reference to the **DynAnyFactory** object is obtained by calling **CORBA::ORB::resolve\_initial\_references** with the **identifier** parameter set to “**DynAnyFactory**”.

```

local interface DynAnyFactory {
 exception InconsistentTypeCode {};
 DynAny create_dyn_any(in any value)
 raises(InconsistentTypeCode);
 DynAny create_dyn_any_from_type_code(in CORBA::TypeCode type)
 raises(InconsistentTypeCode);
};

```

The **create\_dyn\_any** operation creates a new **DynAny** object from an **any** value. A copy of the **TypeCode** associated with the **any** value is assigned to the resulting **DynAny** object. The value associated with the **DynAny** object is a copy of the value in the original any. The **create\_dyn\_any** operation sets the current position of the

created **DynAny** to zero if the passed value has components; otherwise, the current position is set to  $-1$ . The operation raises **InconsistentTypeCode** if **value** has a **TypeCode** with a **TCKind** of **tk\_Principal** or **tk\_native**.

The **create\_dyn\_any\_from\_type\_code** operation creates a **DynAny** from a **TypeCode**. Depending on the **TypeCode**, the created object may be of type **DynAny**, or one of its derived types, such as **DynStruct**. The returned reference can be narrowed to the derived type.

For both **create\_dyn\_any** and **create\_dyn\_any\_from\_type\_code**, the source type code is copied into the **DynAny** object unchanged. This means that, after creation of a **DynAny** object, the source type code and the type code inside the **DynAny** must compare equal as determined by **TypeCode::equal**. The same is true for type codes extracted from a **DynAny** with the type operation and for type codes that are part of any values that are constructed from a **DynAny**: such type codes compare equal to the type code that was originally used to create the **DynAny**. For a given parent **DynAny** with its associated **TypeCode**, the **TypeCode** of a component **DynAny** also compares equal to the corresponding results of the **member\_type** or **component\_type** operation on the parent **TypeCode**.

The **create\_dyn\_any\_without\_truncation** operation has the same semantics as **create\_dyn\_any**, but will raise the **MustTruncate** exception if it cannot avoid truncating a valuetype.

The **create\_multiple\_dyn\_anys** operation converts a sequence of anys into a sequence of **DynAnys**, ensuring that each reference to a valuetype instance is converted consistently to the same **DynValue** or **DynValueBox** instance. If the **allow\_truncate** parameter is false, the operation will raise the **MustTruncate** exception if it cannot avoid truncating a valuetype.

The **create\_multiple\_anys** operation converts a sequence of **DynAnys** into a sequence of **anys**, ensuring that each **DynValue** or **DynValueBox** instance is consistently converted to the same valuetype instance.

Creation of **DynAnys** with **TCKind** **tk\_null** and **tk\_void** is legal and results in the creation of a **DynAny** without a value and with zero components.

In all cases, a **DynAny** constructed from a **TypeCode** has an initial default value. The default values of basic types are:

- **FALSE** for **Boolean**
- zero for numeric types
- zero for types **octet**, **char**, and **wchar**
- the empty string for **string** and **wstring**
- nil for object references
- a type code with a **TCKind** value of **tk\_null** for type codes
- for **any** values, an **any** containing a type code with a **TCKind** value of **tk\_null** type and no value

For complex types, creation of the corresponding **DynAny** assigns a default value as follows:

- For **DynSequence**, the operation sets the current position to  $-1$  and creates an empty sequence.
- For **DynEnum**, the operation sets the current position to  $-1$  and sets the value of the enumerator to the first enumerator value indicated by the **TypeCode**.
- For **DynFixed**, operations set the current position to  $-1$  and sets the value zero.
- For **DynStruct**, the operation sets the current position to  $-1$  for empty exceptions and to zero for all other **TypeCodes**. The members (if any) are (recursively) initialized to their default values.
- For **DynArray**, the operation sets the current position to zero and (recursively) initializes elements to their default value.
- For **DynUnion**, the operation sets the current position to zero. The discriminator value is set to a value consistent with the first named member of the union. That member is activated and (recursively) initialized to its default value.
- **DynValue** and **DynValueBox** are initialized to a null value.

Dynamic interpretation of an **any** usually involves creating a **DynAny** object using **DynAnyFactory::create\_dyn\_any** as the first step. Depending on the type of the **any**, the resulting **DynAny** object reference can be narrowed to a **DynFixed**, **DynStruct**, **DynSequence**, **DynArray**, **DynUnion**, **DynEnum**, or **DynValue** object reference.

Dynamic creation of an **any** involves creating a **DynAny** object using **DynAnyFactory::create\_dyn\_any\_from\_type\_code**, passing the **TypeCode** associated with the value to be created. The returned reference is narrowed to one of the complex types, such as **DynStruct**, if appropriate. Then, the value can be initialized by means of invoking operations on the resulting object. Finally, the **to\_any** operation can be invoked to create an **any** value from the constructed **DynAny**.

### 9.2.2 The DynAny Interface

The following operations can be applied to a **DynAny** object:

- Obtaining the **TypeCode** associated with the **DynAny** object.
- Generating an **any** value from the **DynAny** object.
- Comparing two **DynAny** objects for equality.
- Destroying the **DynAny** object.
- Creating a **DynAny** object as a copy of the **DynAny** object.
- Inserting/getting a value of some basic type into/from the **DynAny** object.
- Iterating through the components of a **DynAny**.
- Initializing a **DynAny** object from another **DynAny** object.
- Initializing a **DynAny** object from an **any** value.

### 9.2.2.1 *Obtaining the TypeCode associated with a DynAny object*

**CORBA::TypeCode type();**

A **DynAny** object is created with a **TypeCode** value assigned to it. This **TypeCode** value determines the type of the value handled through the **DynAny** object. The **type** operation returns the **TypeCode** associated with a **DynAny** object.

Note that the **TypeCode** associated with a **DynAny** object is initialized at the time the **DynAny** is created and cannot be changed during lifetime of the **DynAny** object.

### 9.2.2.2 *Initializing a DynAny object from another DynAny object*

**void assign(in DynAny dyn\_any) raises(TypeMismatch);**

The **assign** operation initializes the value associated with a **DynAny** object with the value associated with another **DynAny** object.

If the type of the passed **DynAny** is not equivalent to the type of target **DynAny**, the operation raises **TypeMismatch**. The current position of the target **DynAny** is set to zero for values that have components and to -1 for values that do not have components.

### 9.2.2.3 *Initializing a DynAny object from an any value*

**void from\_any(in any value) raises(TypeMismatch, InvalidValue);**

The **from\_any** operation initializes the value associated with a **DynAny** object with the value contained in an **any**.

If the type of the passed **Any** is not equivalent to the type of target **DynAny**, the operation raises **TypeMismatch**. If the passed **Any** does not contain a legal value (such as a null string), the operation raises **InvalidValue**. The current position of the target **DynAny** is set to zero for values that have components and to -1 for values that do not have components.

### 9.2.2.4 *Generating an any value from a DynAny object*

**any to\_any();**

The **to\_any** operation creates an **any** value from a **DynAny** object. A copy of the **TypeCode** associated with the **DynAny** object is assigned to the resulting **any**. The value associated with the **DynAny** object is copied into the **any**.



### 9.2.2.5 Comparing *DynAny* values

**boolean equal(in DynAny dyn\_any);**

The **equal** operation compares two **DynAny** references for equality and returns true if the **DynAny**s are equal, false otherwise. For **DynAny** references that are not derived from **DynValueCommon**, they are equal if their **TypeCodes** are equivalent and, recursively, all component **DynAny**s are equal. For **DynAny** references that are derived from **DynValueCommon**, they are equal only if they are exactly the same reference. The current position of the two **DynAny**s being compared has no effect on the result of **equal**. To determine equality of object references, the **equal** operation uses **Object::is\_equivalent**. To determine equality of type codes, the **equal** operation uses **TypeCode::equivalent**.

---

**Note** – If two **DynAny**s happen to contain \*values\* of type **TypeCode**, these values are compared using **TypeCode::equal**. The type codes that \*describe\* the values of **DynAny**s are always compared using **TypeCode::equivalent**, however. (In the case of comparing two **DynAny**s containing type code values, the type codes describing these type code values are **tk\_TypeCode** in each **DynAny**, and will therefore always compare as equivalent.)

---

### 9.2.2.6 Destroying a *DynAny* object

**void destroy();**

The **destroy** operation destroys a **DynAny** object. This operation frees any resources used to represent the data value associated with a **DynAny** object. **destroy** must be invoked on references obtained from one of the creation operations on the **DynAnyFactory** interface or on a reference returned by **DynAny::copy** to avoid resource leaks. Invoking **destroy** on component **DynAny** objects (for example, on objects returned by the **current\_component** operation) does nothing.

Destruction of a **DynAny** object implies destruction of all **DynAny** objects obtained from it. That is, references to components of a destroyed **DynAny** become invalid; invocations on such references raise **OBJECT\_NOT\_EXIST**.

It is possible to manipulate a component of a **DynAny** beyond the life time of the **DynAny** from which the component was obtained by making a copy of the component with the **copy** operation before destroying the **DynAny** from which the component was obtained.

### 9.2.2.7 *Creating a copy of a DynAny object*

#### **DynAny copy();**

The **copy** operation creates a new **DynAny** object whose value is a deep copy of the **DynAny** on which it is invoked. The operation is polymorphic, that is, invoking it on one of the types derived from **DynAny**, such as **DynStruct**, creates the derived type but returns its reference as the **DynAny** base type.

### 9.2.2.8 *Accessing a value of some basic type in a DynAny object*

The insert and get operations enable insertion/extraction of basic data type values into/from a **DynAny** object.

Both bounded and unbounded strings are inserted using **insert\_string** and **insert\_wstring**. These operations raise the **InvalidValue** exception if the string inserted is longer than the bound of a bounded string.

Calling an insert or get operation on a **DynAny** that has components but has a current position of  $-1$  raises **InvalidValue**.

Get operations raise **TypeMismatch** if the accessed component in the **DynAny** is of a type that is not equivalent to the requested type. (Note that **get\_string** and **get\_wstring** are used for both unbounded and bounded strings.)

A type is consistent for inserting or extracting a value if its **TypeCode** is equivalent to the **TypeCode** contained in the **DynAny** or, if the **DynAny** has components, is equivalent to the **TypeCode** of the **DynAny** at the current position.

The **get\_dyn\_any** and **insert\_dyn\_any** operations are provided to deal with **any** values that contain another **any**. The operations behave identically to **get\_any** and **insert\_any**, but use parameters of type **DynAny** (instead of **any**); they are useful to avoid otherwise redundant conversions between **any** and **DynAny**.

Calling an insert or get operation leaves the current position unchanged.

These operations are necessary to handle basic **DynAny** objects but are also helpful to handle constructed **DynAny** objects. Inserting a basic data type value into a constructed **DynAny** object implies initializing the current component of the constructed data value associated with the **DynAny** object. For example, invoking **insert\_boolean** on a **DynStruct** implies inserting a boolean data value at the current position of the associated struct data value. If **dyn\_construct** points to a constructed **DynAny** object, then:

```
result = dyn_construct->get_boolean();
```

has the same effect as:

```
DynamicAny::DynAny_var temp =
 dyn_construct->current_component();
result = temp->get_boolean();
```

Calling an insert or get operation on a **DynAny** whose current component itself has components raises **TypeMismatch**.

In addition, availability of these operations enable the traversal of **any**s associated with sequences of basic data types without the need to generate a **DynAny** object for each element in the sequence.

In the same way that basic types are inserted/extracted from a **DynAny** object, arrays or sequences of basic types can be inserted/extracted from a **DynAny**. For example, the **get\_boolean\_seq** operation extracts a sequence of **booleans** from a **DynAny** that contains either a sequence or an array of **booleans**, and the **insert\_boolean\_seq** operation stores the sequence back into the **DynAny**.

The **TypeCode** of the **DynAny**, or the **TypeCode** of the component at the current position of the **DynAny**, must be equivalent to a sequence or array **TypeCode** with the basic type as its element, otherwise the operations raise **TypeMismatch**. For the insert operations, if the length of the sequence is incompatible with a bounded sequence or array represented by the **DynAny**, then the operations raise **InvalidValue**.

#### 9.2.2.9 *Iterating through components of a DynAny*

The **DynAny** interface allows a client to iterate through the components of the values pointed to by **DynStruct**, **DynSequence**, **DynArray**, **DynUnion**, **DynAny**, and **DynValue** objects.

As mentioned previously, a **DynAny** object may be seen as an ordered collection of components, together with a current position.

##### **boolean seek(in long index);**

The **seek** operation sets the current position to **index**. The current position is indexed 0 to  $n-1$ , that is, index zero corresponds to the first component. The operation returns true if the resulting current position indicates a component of the **DynAny** and false if **index** indicates a position that does not correspond to a component.

Calling **seek** with a negative index is legal. It sets the current position to  $-1$  to indicate no component and returns false. Passing a non-negative index value for a **DynAny** that does not have a component at the corresponding position sets the current position to  $-1$  and returns false.

##### **void rewind();**

The **rewind** operation is equivalent to calling **seek(0)**;

##### **boolean next();**

The **next** operation advances the current position to the next component. The operation returns true while the resulting current position indicates a component, false otherwise. A false return value leaves the current position at  $-1$ . Invoking **next** on a **DynAny** without components leaves the current position at  $-1$  and returns false.

**unsigned long component\_count();**

The **component\_count** operation returns the number of components of a **DynAny**. For a **DynAny** without components, it returns zero. The operation only counts the components at the top level. For example, if **component\_count** is invoked on a **DynStruct** with a single member, the return value is 1, irrespective of the type of the member.

For sequences, the operation returns the current number of elements. For structures, exceptions, and valuetypes, the operation returns the number of members. For arrays, the operation returns the number of elements. For unions, the operation returns 2 if the discriminator indicates that a named member is active; otherwise, it returns 1. For **DynFixed** and **DynEnum**, the operation returns zero.

**DynAny current\_component() raises(TypeMismatch);**

The **current\_component** operation returns the **DynAny** for the component at the current position. It does not advance the current position, so repeated calls to **current\_component** without an intervening call to **rewind**, **next**, or **seek** return the same component.

The returned **DynAny** object reference can be used to get/set the value of the current component. If the current component represents a complex type, the returned reference can be narrowed based on the **TypeCode** to get the interface corresponding to the to the complex type.

Calling **current\_component** on a **DynAny** that cannot have components, such as a **DynEnum** or an empty exception, raises **TypeMismatch**. Calling **current\_component** on a **DynAny** whose current position is -1 returns a nil reference.

The iteration operations, together with **current\_component**, can be used to dynamically compose an **any** value. After creating a dynamic any, such as a **DynStruct**, **current\_component** and **next** can be used to initialize all the components of the value. Once the dynamic value is completely initialized, **to\_any** creates the corresponding **any** value.

### 9.2.3 The DynFixed Interface

**DynFixed** objects are associated with values of the IDL **fixed** type.

```
local interface DynFixed : DynAny {
 string get_value();
 boolean set_value(in string val)
 raises (TypeMismatch, InvalidValue);
};
```

Because IDL does not have a generic type that can represent fixed types with arbitrary number of digits and arbitrary scale, the operations use the IDL **string** type.

The **get\_value** operation returns the value of a **DynFixed**.

The **set\_value** operation sets the value of the **DynFixed**. The **val** string must contain a **fixed** string constant in the same format as used for IDL fixed-point literals. However, the trailing **d** or **D** is optional. If **val** has more fractional digits than specified by the scale of the **DynFixed**, the extra digits are truncated. If the truncated value has more digits than the **DynFixed**, the operation raises **InvalidValue**. If the value is not too large, **set\_value** returns **TRUE** if no truncation was required, **FALSE** otherwise. The return value is **TRUE** if **val** can be represented as the **DynFixed** without loss of precision. If **val** has more fractional digits than can be represented in the **DynFixed**, fractional digits are truncated and the return value is **FALSE**. If **val** does not contain a valid fixed-point literal or contains extraneous characters other than leading or trailing white space, the operation raises **TypeMismatch**.

#### 9.2.4 The *DynEnum* Interface

**DynEnum** objects are associated with enumerated values.

```
local interface DynEnum : DynAny {
 string get_as_string();
 void set_as_string(in string value) raises(InvalidValue);
 unsigned long get_as_ulong();
 void set_as_ulong(in unsigned long value) raises(InvalidValue);
};
```

The **get\_as\_string** operation returns the value of the **DynEnum** as an IDL identifier.

The **set\_as\_string** operation sets the value of the **DynEnum** to the enumerated value whose IDL identifier is passed in the **value** parameter. If **value** contains a string that is not a valid IDL identifier for the corresponding enumerated type, the operation raises **InvalidValue**.

The **get\_as\_ulong** operation returns the value of the **DynEnum** as the enumerated value's ordinal value. Enumerators have ordinal values 0 to n-1, as they appear from left to right in the corresponding IDL definition.

The **set\_as\_ulong** operation sets the value of the **DynEnum** as the enumerated value's ordinal value. If **value** contains a value that is outside the range of ordinal values for the corresponding enumerated type, the operation raises **InvalidValue**.

The current position of a **DynEnum** is always -1.

#### 9.2.5 The *DynStruct* Interface

**DynStruct** objects are associated with struct values and exception values.

```

typedef string FieldName;

struct NameValuePair {
 FieldName id;
 any value;
};
typedef sequence<NameValuePair> NameValuePairSeq;

struct NameDynAnyPair {
 FieldName id;
 DynAny value;
};
typedef sequence<NameDynAnyPair> NameDynAnyPairSeq;

local interface DynStruct : DynAny {
 FieldName current_member_name()
 raises(TypeMismatch, InvalidValue);
 CORBA::TCKind current_member_kind()
 raises(TypeMismatch, InvalidValue);
 NameValuePairSeq get_members();
 void set_members(in NameValuePairSeq value)
 raises(TypeMismatch, InvalidValue);
 NameDynAnyPairSeq get_members_as_dyn_any();
 void set_members_as_dyn_any(in NameDynAnyPairSeq value)
 raises(TypeMismatch, InvalidValue);
};

 FieldName current_member_name()
 raises(TypeMismatch, InvalidValue);

```

The **current\_member\_name** operation returns the name of the member at the current position. If the **DynStruct** represents an empty exception, the operation raises **TypeMismatch**. If the current position does not indicate a member, the operation raises **InvalidValue**.

This operation may return an empty string since the **TypeCode** of the value being manipulated may not contain the names of members.

```

 CORBA::TCKind current_member_kind()
 raises(TypeMismatch, InvalidValue);

```

**current\_member\_kind** returns the **TCKind** associated with the member at the current position. If the **DynStruct** represents an empty exception, the operation raises **TypeMismatch**. If the current position does not indicate a member, the operation raises **InvalidValue**.

```

 NameValuePairSeq get_members();

```

The **get\_members** operation returns a sequence of name/value pairs describing the name and the value of each member in the struct associated with a **DynStruct** object. The sequence contains members in the same order as the declaration order of members

as indicated by the **DynStruct**'s **TypeCode**. The current position is not affected. The member names in the returned sequence will be empty strings if the **DynStruct**'s **TypeCode** does not contain member names.

```
void set_members(in NameValuePairSeq value)
 raises(TypeMismatch, InvalidValue);
```

The **set\_members** operation initializes the struct data value associated with a **DynStruct** object from a sequence of name value pairs. The operation sets the current position to zero if the passed sequences has non-zero length; otherwise, if an empty sequence is passed, the current position is set to  $-1$ .

Members must appear in the **NameValuePairSeq** in the order in which they appear in the IDL specification of the struct. If one or more sequence elements have a type that is not equivalent to the **TypeCode** of the corresponding member, the operation raises **TypeMismatch**. If the passed sequence has a number of elements that disagrees with the number of members as indicated by the **DynStruct**'s **TypeCode**, the operation raises **InvalidValue**.

If member names are supplied in the passed sequence, they must either match the corresponding member name in the **DynStruct**'s **TypeCode** or must be empty strings, otherwise, the operation raises **TypeMismatch**. Members must be supplied in the same order as indicated by the **DynStruct**'s **TypeCode**. (The operation makes no attempt to assign member values based on member names.)

The **get\_members\_as\_dyn\_any** and **set\_members\_as\_dyn\_any** operations have the same semantics as their **Any** counterparts, but accept and return values of type **DynAny** instead of **Any**.

**DynStruct** objects can also be used for handling exception values. In that case, members of the exceptions are handled in the same way as members of a struct.

### 9.2.6 The *DynUnion* Interface

**DynUnion** objects are associated with unions.

```
local interface DynUnion : DynAny {
 DynAny get_discriminator();
 void set_discriminator(in DynAny d)
 raises(TypeMismatch);
 void set_to_default_member()
 raises(TypeMismatch);
 void set_to_no_active_member()
 raises(TypeMismatch);
 boolean has_no_active_member()
 raises(InvalidValue);
 CORBA::TCKind discriminator_kind();
 DynAny member()
 raises(InvalidValue);
 FieldName member_name()
 raises(InvalidValue);
```

```

CORBA::TCKind member_kind()
 raises(InvalidValue);
boolean is_set_to_default_member();
};

```

The **DynUnion** interface allows for the insertion/extraction of an OMG IDL union type into/from a **DynUnion** object.

A union can have only two valid current positions: zero, which denotes the discriminator, and one, which denotes the active member. The **component\_count** value for a union depends on the current discriminator: it is 2 for a union whose discriminator indicates a named member, and 1 otherwise.

```

DynAny get_discriminator()

```

The **get\_discriminator** operation returns the current discriminator value of the **DynUnion**.

```

void set_discriminator(in DynAny d)
 raises(TypeMismatch);

```

The **set\_discriminator** operation sets the discriminator of the **DynUnion** to the specified value. If the **TypeCode** of the **d** parameter is not equivalent to the **TypeCode** of the union's discriminator, the operation raises **TypeMismatch**.

Setting the discriminator to a value that is consistent with the currently active union member does not affect the currently active member. Setting the discriminator to a value that is inconsistent with the currently active member deactivates the member and activates the member that is consistent with the new discriminator value (if there is a member for that value) by initializing the member to its default value.

Setting the discriminator of a union sets the current position to 0 if the discriminator value indicates a non-existent union member (**has\_no\_active\_member** returns true in this case). Otherwise, if the discriminator value indicates a named union member, the current position is set to 1 (**has\_no\_active\_member** returns false and **component\_count** returns 2 in this case).

```

void set_to_default_member()
 raises(TypeMismatch);

```

The **set\_to\_default\_member** operation sets the discriminator to a value that is consistent with the value of the **default** case of a union; it sets the current position to zero and causes **component\_count** to return 2. Calling **set\_to\_default\_member** on a union that does not have an explicit **default** case raises **TypeMismatch**.



```
void set_to_no_active_member()
 raises(TypeMismatch);
```

The **set\_to\_no\_active\_member** operation sets the discriminator to a value that does not correspond to any of the union's case labels; it sets the current position to zero and causes **component\_count** to return 1. Calling **set\_to\_no\_active\_member** on a union that has an explicit **default** case or on a union that uses the entire range of discriminator values for explicit **case** labels raises **TypeMismatch**.

```
boolean has_no_active_member();
```

The **has\_no\_active\_member** operation returns true if the union has no active member (that is, the union's value consists solely of its discriminator because the discriminator has a value that is not listed as an explicit **case** label). Calling this operation on a union that has a **default** case returns false. Calling this operation on a union that uses the entire range of discriminator values for explicit **case** labels returns false.

```
CORBA::TCKind discriminator_kind();
```

The **discriminator\_kind** operation returns the **TCKind** value of the discriminator's **TypeCode**.

```
CORBA::TCKind member_kind()
 raises(InvalidValue);
```

The **member\_kind** operation returns the **TCKind** value of the currently active member's **TypeCode**. Calling this operation on a union that does not have a currently active member raises **InvalidValue**.

```
DynAny member()
 raises(InvalidValue);
```

The **member** operation returns the currently active member. If the union has no active member, the operation raises **InvalidValue**. Note that the returned reference remains valid only for as long as the currently active member does not change. Using the returned reference beyond the life time of the currently active member raises **OBJECT\_NOT\_EXIST**.

```
FieldName member_name()
 raises(InvalidValue);
```

The **member\_name** operation returns the name of the currently active member. If the union's **TypeCode** does not contain a member name for the currently active member, the operation returns an empty string. Calling **member\_name** on a union without an active member raises **InvalidValue**.

```
boolean is_set_to_default_member();
```

The **is\_set\_to\_default\_member** operation returns **TRUE** if a union has an explicit default label and the discriminator value does not match any of the union's other case labels.

### 9.2.7 The DynSequence Interface

**DynSequence** objects are associated with sequences.

```
typedef sequence<any> AnySeq;
typedef sequence<DynAny> DynAnySeq;

local interface DynSequence : DynAny {
 unsigned long get_length();
 void set_length(in unsigned long len)
 raises(InvalidValue);
 AnySeq get_elements();
 void set_elements(in AnySeq value)
 raises(TypeMismatch, InvalidValue);
 DynAnySeq get_elements_as_dyn_any();
 void set_elements_as_dyn_any(in DynAnySeq value)
 raises(TypeMismatch, InvalidValue);
};

 unsigned long get_length();
```

The **get\_length** operation returns the current length of the sequence.

```
 void set_length(in unsigned long len)
 raises(InvalidValue);
```

The **set\_length** operation sets the length of the sequence. Increasing the length of a sequence adds new elements at the tail without affecting the values of already existing elements. Newly added elements are default-initialized.

Increasing the length of a sequence sets the current position to the first newly-added element if the previous current position was  $-1$ . Otherwise, if the previous current position was not  $-1$ , the current position is not affected.

Increasing the length of a bounded sequence to a value larger than the bound raises **InvalidValue**.

Decreasing the length of a sequence removes elements from the tail without affecting the value of those elements that remain. The new current position after decreasing the length of a sequence is determined as follows:

- If the length of the sequence is set to zero, the current position is set to  $-1$ .
- If the current position is  $-1$  before decreasing the length, it remains at  $-1$ .
- If the current position indicates a valid element and that element is not removed when the length is decreased, the current position remains unaffected.
- If the current position indicates a valid element and that element is removed, the current position is set to  $-1$ .

```
 DynAnySeq get_elements();
```

The **get\_elements** operation returns the elements of the sequence.

```
void set_elements(in AnySeq value)
 raises(TypeMismatch, InvalidValue);
```

The **set\_elements** operation sets the elements of a sequence. The length of the **DynSequence** is set to the length of **value**. The current position is set to zero if **value** has non-zero length and to  $-1$  if **value** is a zero-length sequence.

If **value** contains one or more elements whose **TypeCode** is not equivalent to the element **TypeCode** of the **DynSequence**, the operation raises **TypeMismatch**. If the length of **value** exceeds the bound of a bounded sequence, the operation raises **InvalidValue**.

The **get\_elements\_as\_dyn\_any** and **set\_elements\_as\_dyn\_any** operations have the same semantics, but accept and return values of type **DynAny** instead of **Any**.

### 9.2.8 The DynArray Interface

**DynArray** objects are associated with arrays.

```
local interface DynArray : DynAny {
 AnySeq get_elements();
 void set_elements(in AnySeq value)
 raises(TypeMismatch, InvalidValue);
 DynAnySeq get_elements_as_dyn_any();
 void set_elements_as_dyn_any(in DynAnySeq value)
 raises(TypeMismatch, InvalidValue);
};

DynAnySeq get_elements();
```

The **get\_elements** operation returns the elements of the **DynArray**.

```
void set_elements(in DynAnySeq value)
 raises(TypeMismatch, InvalidValue);
```

The **set\_elements** operation sets the **DynArray** to contain the passed elements. If the sequence does not contain the same number of elements as the array dimension, the operation raises **InvalidValue**. If one or more elements have a type that is inconsistent with the **DynArray**'s **TypeCode**, the operation raises **TypeMismatch**.

The **get\_elements\_as\_dyn\_any** and **set\_elements\_as\_dyn\_any** operations have the same semantics as their **Any** counterparts, but accept and return values of type **DynAny** instead of **Any**.

Note that the dimension of the array is contained in the **TypeCode**, which is accessible through the **type** attribute. It can also be obtained by calling the **component\_count** operation.

### 9.2.9 The *DynValueCommon* Interface

**DynValueCommon** provides operations supported by both the **DynValue** and **DynValueBox** interfaces.

```
local interface DynValueCommon : DynAny {
 boolean is_null();
 void set_to_null();
 void set_to_value();
};
```

```
boolean is_null();
```

The **is\_null** operation returns **TRUE** if the **DynValueCommon** represents a null valuetype.

```
void set_to_null();
```

The **set\_to\_null** operation changes the representation of a **DynValueCommon** to a null valuetype.

```
void set_to_value();
```

If the **DynValueCommon** represents a null valuetype, then **set\_to\_value** replaces it with a newly constructed value, with its components initialized to default values as in **DynAnyFactory::create\_dyn\_any\_from\_type\_code**. If the **DynValueCommon** represents a non-null valuetype, then this operation has no effect.

A reference to a **DynValueCommon** interface (and interfaces derived from it) exhibit the same sharing semantics as the underlying **valuetype** that it represents. This means that the relationships between **valuetypes** in a graph of valuetypes will remain unchanged when converted into **DynAny** form and vice versa. This is necessary to ensure that applications that use the **DII** and **DSI** can correctly view and preserve the semantics of the **valuetype** graph.

### 9.2.10 The *DynValue* Interface

**DynValue** objects are associated with non-boxed valuetypes.

```

local interface DynValue : DynValueCommon {
 FieldName current_member_name()
 raises(TypeMismatch, InvalidValue);
 CORBA::TCKind current_member_kind()
 raises(TypeMismatch, InvalidValue);
 NameValuePairSeq get_members()
 raises(InvalidValue);
 void set_members(in NameValuePairSeq value)
 raises(TypeMismatch, InvalidValue);
 NameDynAnyPairSeq get_members_as_dyn_any()
 raises(InvalidValue);
 void set_members_as_dyn_any(in NameDynAnyPairSeq value)
 raises(TypeMismatch, InvalidValue);
};

```

The **DynValue** interface can represent both null and non-null valuetypes. For a **DynValue** representing a non-null valuetype, the **DynValue**'s components comprise the public and private members of the valuetype, including those inherited from concrete base valuetypes, in the order of definition. A **DynValue** representing a null valuetype has no components and a current position of **-1**.

The remaining operations on the **DynValue** interface generally have equivalent semantics to the same operations on **DynStruct**. When invoked on a **DynValue** representing a null valuetype, **get\_members** and **get\_members\_as\_dyn\_any** raise **InvalidValue**. When invoked on a **DynValue** representing a non-null valuetype, **set\_members** and **set\_members\_as\_dyn\_any** convert the **DynValue** to a non-null valuetype.

---

**Warning** – Indiscriminately changing the contents of private valuetype members can cause the valuetype implementation to break by violating internal constraints. Access to private members is provided to support such activities as ORB bridging and debugging and should not be used to arbitrarily violate the encapsulation of the valuetype.

---

### 9.2.11 The DynValueBox Interface

**DynValueBox** objects are associated with boxed valuetypes.

```

local interface DynValueBox : DynValueCommon {
 any get_boxed_value()
 raises(InvalidValue);
 void set_boxed_value(in any boxed)
 raises(TypeMismatch, InvalidValue);
 DynAny get_boxed_value_as_dyn_any()
 raises(InvalidValue);
 void set_boxed_value_as_dyn_any(in DynAny boxed)
 raises(TypeMismatch);
};

```

The **DynValueBox** interface can represent both null and non-null valuetypes. For a **DynValueBox** representing a non-null valuetype, the **DynValueBox** has a single component of the boxed type. A **DynValueBox** representing a null valuetype has no components and a current position of **-1**.

```
any get_boxed_value()
 raises(InvalidValue);
```

The **get\_boxed\_value** operation returns the boxed value as an any. If the **DynBoxedValue** represents a null valuetype, the operation raises **InvalidValue**.

```
void set_boxed_value(in any boxed)
 raises(TypeMismatch, InvalidValue);
```

The **set\_boxed\_value** operation replaces the boxed value with the specified value. If the type of the passed Any is not equivalent to the boxed type, the operation raises **TypeMismatch**. If the passed **Any** does not contain a legal value, the operation raises **InvalidValue**. If the **DynBoxedValue** represents a **null valuetype**, it is converted to a non-null value.

The **get\_boxed\_value\_as\_dyn\_any** and **set\_boxed\_value\_as\_dyn\_any** have the same semantics as their any counterparts, but accept and return values of type **DynAny** instead of any.

## 9.3 Usage in C++ Language

### 9.3.1 Dynamic Creation of CORBA::Any Values

#### 9.3.1.1 Creating an any that contains a struct

Consider the following IDL definition:

```
// IDL
struct MyStruct {
 long member1;
 boolean member2;
};
```

The following example illustrates how a **CORBA::Any** value may be constructed on the fly containing a value of type **MyStruct**:

```
// C++
CORBA::ORB_var orb = ...;
DynamicAny::DynAnyFactory_var dafact
 = orb->resolve_initial_references("DynAnyFactory");
CORBA::StructMemberSeq mems(2);
CORBA::Any_var result;
CORBA::Long value1 = 99;
CORBA::Boolean value2 = 1;
```

```

 mems.length(2);
 mems[0].name = CORBA::string_dup("member1");
 mems[0].type = CORBA::TypeCode::_duplicate(CORBA::_tc_long);
 mems[1].name = CORBA::string_dup("member2");
 mems[1].type
 = CORBA::TypeCode::_duplicate(CORBA::_tc_boolean);

 CORBA::TypeCode_var new_tc = orb->create_struct_tc(
 "IDL:MyStruct:1.0",
 "MyStruct",
 mems
);

 // Construct the DynStruct object. Values for members are
 // the value1 and value2 variables

 DynamicAny::DynAny_ptr dyn_any
 = dafact->create_dyn_any(new_tc);
 DynamicAny::DynStruct_ptr dyn_struct
 = DynamicAny::DynStruct::_narrow(dyn_any);
 CORBA::release(dyn_any);
 dyn_struct->insert_long(value1);

 dyn_struct->next();
 dyn_struct->insert_boolean(value2);
 result = dyn_struct->to_any();
 dyn_struct->destroy();
 CORBA::release(dyn_struct);

```

## 9.3.2 Dynamic Interpretation of CORBA::Any Values

### 9.3.2.1 Filtering of events

Suppose there is a CORBA object that receives events and prints all those events, which correspond to a data structure containing a member called **is\_urgent** whose value is true.

The following fragment of code corresponds to a method that determines if an event should be printed or not. Note that the program allows several struct events to be filtered with respect to some common member.

```

// C++
CORBA::Boolean Tester::eval_filter(
 DynamicAny::DynAnyFactory_ptr dafact,
 const CORBA::Any & event
)
{
 CORBA::Boolean success = FALSE;
 DynamicAny::DynAny_var;
 try {

```

```
// First, convert the event to a DynAny.
// Then attempt to narrow it to a DynStruct.
// The _narrow only returns a reference
// if the event is a struct.
dyn_var = dafact->create_dyn_any(event);
DynamicAny::DynStruct_var dyn_struct
 = DynamicAny::DynStruct::_narrow(dyn_any);
if (!CORBA::is_nil(dyn_struct)) {
 CORBA::Boolean found = FALSE;
 do {
 CORBA::String_var member_name
 = dyn_struct->current_member_name();
 found = (strcmp(member_name, "is_urgent") == 0);
 } while (!found && dyn_struct->next());
 if (found) {
 // We only create a DynAny object for the member
 // we were looking for:
 DynamicAny::DynAny_var dyn_member
 = dyn_struct->current_component();
 success = dyn_member->get_boolean();
 }
}
}
}
catch(...) {};
if (!CORBA::is_nil(dyn_var))
 dyn_var->destroy();
return success;
}
```



## *Contents*

This chapter contains the following sections.

| <b>Section Title</b>               | <b>Page</b> |
|------------------------------------|-------------|
| “Overview”                         | 10-1        |
| “Scope of an Interface Repository” | 10-2        |
| “Implementation Dependencies”      | 10-4        |
| “Basics”                           | 10-5        |
| “Interface Repository Interfaces”  | 10-11       |
| “RepositoryIds”                    | 10-64       |
| “OMG IDL for Interface Repository” | 10-75       |

## *10.1 Overview*

The Interface Repository is the component of the ORB that provides persistent storage of interface definitions—it manages and provides access to a collection of object definitions specified in OMG IDL.

An ORB provides distributed access to a collection of objects using the objects’ publicly defined interfaces specified in OMG IDL. The Interface Repository provides for the storage, distribution, and management of a collection of related objects’ interface definitions.

For an ORB to correctly process requests, it must have access to the definitions of the objects it is handling. Object definitions can be made available to an ORB in one of two forms:

1. By incorporating the information procedurally into stub routines (e.g., as code that maps C language subroutines into communication protocols).
2. As objects accessed through the dynamically accessible Interface Repository (i.e., as interface objects accessed through OMG IDL-specified interfaces).

In particular, the ORB can use object definitions maintained in the Interface Repository to interpret and handle the values provided in a request to:

- Provide type-checking of request signatures (whether the request was issued through the DII or through a stub).
- Assist in checking the correctness of interface inheritance graphs.
- Assist in providing interoperability between different ORB implementations.

As the interface to the object definitions maintained in an Interface Repository is public, the information maintained in the Repository can also be used by clients and services. For example, the Repository can be used to:

- Manage the installation and distribution of interface definitions.
- Provide components of a CASE environment (for example, an interface browser).
- Provide interface information to language bindings (such as a compiler).
- Provide components of end-user environments (for example, a menu bar constructor).

The complete OMG IDL specification for the Interface Repository is in Section 10.8, “OMG IDL for Interface Repository,” on page 10-75; however, fragments of the specification are used throughout this chapter as necessary.

## 10.2 Scope of an Interface Repository

Interface definitions are maintained in the Interface Repository as a set of objects that are accessible through a set of OMG IDL-specified interface definitions. An interface definition contains a description of the operations it supports, including the types of the parameters, exceptions it may raise, and context information it may use.

In addition, the interface repository stores constant values, which might be used in other interface and value definitions or might simply be defined for programmer convenience and it stores TypeCodes [Section 4.11, “TypeCodes,” on page 4-52], which are values that describe a type in structural terms.

The Interface Repository uses modules as a way to group interfaces and to navigate through those groups by name. Modules can contain constants, typedefs, exceptions, interface/component/home definitions, and other modules. Modules may, for example, correspond to the organization of OMG IDL definitions. They may also be used to represent organizations defined for administration or other purposes.

The Interface Repository consists of a set of *interface repository objects* that represent the information in it. There are operations that operate on this apparent object structure. It is an implementation’s choice whether these objects exist persistently or

are created when referenced in an operation on the repository. There are also operations that extract information in an efficient form, obtaining a block of information that describes a whole interface or a whole operation.

An ORB may have access to multiple Interface Repositories. This may occur because

- two ORBs have different requirements for the implementation of the Interface Repository,
- an object implementation (such as an OODB) prefers to provide its own type information, or
- it is desired to have different additional information stored in different repositories.

The use of TypeCodes (Section 4.11, “TypeCodes,” on page 4-52) and repository identifiers is intended to allow different repositories to keep their information consistent.

As shown in Figure 10-1 on page 10-3, the same interface **Doc** is installed in two different repositories, one at SoftCo, Inc., which sells Doc objects, and one at Customer, Inc., which buys Doc objects from SoftCo. SoftCo sets the repository id for the Doc interface when it defines it. Customer might first install the interface in its repository in a module where it could be tested before exposing it for general use. Because it has the same repository id, even though the Doc interface is stored in a different repository and is nested in a different module, it is known to be the same.

Meanwhile at SoftCo, someone working on a new Doc interface has given it a new repository id 456, which allows the ORBs to distinguish it from the current product Doc interface.

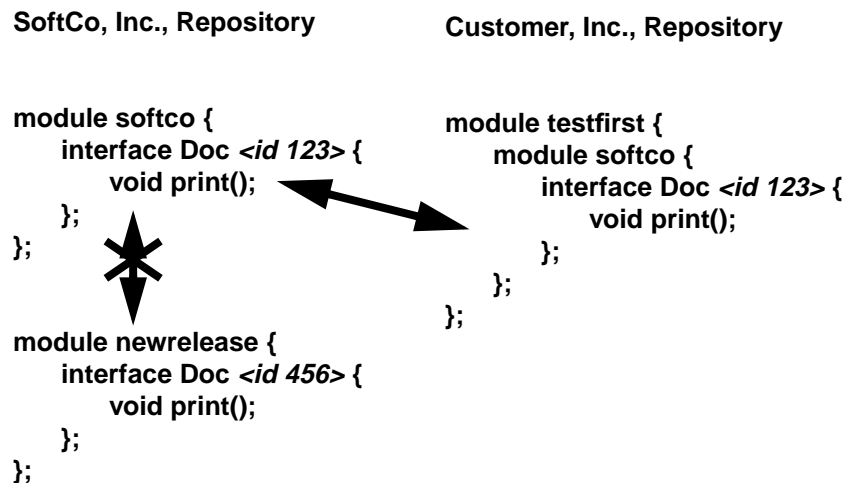

Figure 10-1 Using Repository IDs to establish correspondence between repositories

Not all interfaces will be visible in all repositories. For example, Customer employees cannot see the new release of the Doc interface. However, widely used interfaces will generally be visible in most repositories.

This Interface Repository specification defines operations for retrieving information from the repository as well as creating definitions within it. There may be additional ways to insert information into the repository (for example, compiling OMG IDL definitions, copying objects from one repository to another).

A critical use of the interface repository information is for connecting ORBs together. When an object is passed in a request from one ORB to another, it may be necessary to create a new object to represent the passed object in the receiving ORB. This may require locating the interface information in an interface repository in the receiving ORB. By getting the repository id from a repository in the sending ORB, it is possible to look up the interface in a repository in the receiving ORB. To succeed, the interface for that object must be installed in both repositories with the same repository id.

### *10.3 Implementation Dependencies*

An implementation of an Interface Repository requires some form of persistent object store. Normally the kind of persistent object store used determines how interface definitions are distributed and/or replicated throughout a network domain. For example, if an Interface Repository is implemented using a filing system to provide object storage, there may be only a single copy of a set of interfaces maintained on a single machine. Alternatively, if an OODB is used to provide object storage, multiple copies of interface definitions may be maintained each of which is distributed across several machines to provide both high-availability and load-balancing.

The kind of object store used may determine the scope of interface definitions provided by an implementation of the Interface Repository. For example, it may determine whether each user has a local copy of a set of interfaces or if there is one copy per community of users. The object store may also determine whether or not all clients of an interface set see exactly the same set at any given point in time or whether latency in distributing copies of the set gives different users different views of the set at any point in time.

An implementation of the Interface Repository is also dependent on the security mechanism in use. The security mechanism (usually operating in conjunction with the object store) determines the nature and granularity of access controls available to constrain access to objects in the repository.

#### *10.3.1 Managing Interface Repositories*

Interface Repositories contain the information necessary to allow programs to determine and manipulate the type information at run-time. Programs may attempt to access the interface repository at any time by using the **get\_interface** operation on the object reference. Once information has been installed in the repository, programs, stubs, and objects may depend on it. Updates to the repository must be done with care to avoid disrupting the environment. A variety of techniques are available to help do so.

A coherent repository is one whose contents can be expressed as a valid collection of OMG IDL definitions. For example, all inherited interfaces exist, there are no duplicate operation names or other name collisions, all parameters have known types, and so forth. As information is added to the repository, it is possible that it may pass through incoherent states. Media failures or communication errors might also cause it to appear incoherent. In general, such problems cannot be completely eliminated.

Replication is one technique to increase the availability and performance of a shared database. It is likely that the same interface information will be stored in multiple repositories in a computing environment. Using repository IDs, the repositories can establish the identity of the interfaces and other information across the repositories.

Multiple repositories might also be used to insulate production environments from development activity. Developers might be permitted to make arbitrary updates to their repositories, but administrators may control updates to widely used repositories. Some repository implementations might permit sharing of information, for example, several developers' repositories may refer to parts of a shared repository. Other repository implementations might instead copy the common information. In any case, the result should be a repository facility that creates the impression of a single, coherent repository.

The interface repository itself cannot make all repositories have coherent information, and it may be possible to enter information that does not make sense. The repository will report errors that it detects (e.g., defining two attributes with the same name) but might not report all errors, for example, adding an attribute to a base interface may or may not detect a name conflict with a derived interface. Despite these limitations, the expectation is that a combination of conventions, administrative controls, and tools that add information to the repository will work to create a coherent view of the repository information.

Transactions and concurrency control mechanisms defined by the Object Services may be used by some repositories when updating the repository. Those services are designed so that they can be used without changing the operations that update the repository. For example, a repository that supports the Transaction Service would inherit the Repository interface, which contains the update operations, as well as the Transaction interface, which contains the transaction management operations. (For more information about Object Services, including the Transaction and Concurrency Control Services, refer to the individual CORBA Services specifications).

Often, rather than change the information, new versions will be created, allowing the old version to continue to be valid. The new versions will have distinct repository IDs and be completely different types as far as the repository and the ORBs are concerned. The IR provides storage for version identifiers for named types, but does not specify any additional versioning mechanism or semantics.

## 10.4 Basics

This section introduces some basic ideas that are important to understanding the Interface Repository. Topics addressed in this section are:

- Names and Identifiers

- Types and TypeCodes
- Interface Repository Objects
- Structure and Navigation of the Interface Repository

### 10.4.1 Names and Identifiers

Simple names are not necessarily unique within an Interface Repository; they are always relative to an explicit or implicit module. In this context, interface, struct, union, exception and value type definitions are considered implicit modules.

Scoped names uniquely identify modules, interfaces, components, homes, value and event types, value members, value boxes, constant, typedefs, exceptions, attributes, and operations in an Interface Repository.

Repository identifiers globally identify modules, interfaces, components, homes, value and event types, value members, value boxes, constants, typedefs, exceptions, attributes, and operations. They can be used to synchronize definitions across multiple ORBs and Repositories.

### 10.4.2 Types and TypeCodes

The Interface Repository stores information about types that are not interfaces in a data value called a TypeCode. From the TypeCode alone it is possible to determine the complete structure of a type. See Section 4.11, “TypeCodes,” on page 4-52 for more information on the internal structure of TypeCodes.

### 10.4.3 Interface Repository Objects

Information about the entities that are managed in an Interface Repository is maintained as a collection of *interface repository objects* of the following types:

- **Repository**: the top-level module for the repository name space; it contains constants, typedefs, exceptions, interface , component, home, value or event type definitions, and modules.
- **ModuleDef**: a logical grouping of interfaces and value types; it contains constants, typedefs, exceptions, interface, component, home, value or event type definitions, and other modules.
- **InterfaceDef**: an interface definition; it contains lists of constants, types, exceptions, operations, and attributes.
- **ExtInterfaceDef**: an extended version of **InterfaceDef** that is capable of accommodating attributes with exceptions.
- **AbstractInterfaceDef**: an abstract interface definition; it contains lists of constants, types, exceptions, operations, and attributes.
- **ExtAbstractInterfaceDef**: an extended version of **AbstractInterfaceDef** that is capable of accommodating attributes with exceptions.

- **LocalInterfaceDef**: a local interface definition; it contains lists of constants, types, exceptions, operations, and attributes.
- **ExtLocalInterfaceDef**: an extended version of **LocalInterfaceDef** that is capable of accommodating attributes with exceptions.
- **ValueDef**: a value type definition that contains lists of constants, types, exceptions, operations, attributes and members
- **ExtValueDef**: an extended version of **ValueDef** that is capable of accommodating attributes and initializers with exceptions.
- **EventDef**: an event type definition that contains lists of constants, types, exceptions, operations, attributes and members.
- **ValueBoxDef**: the definition of a boxed value type.
- **ValueMemberDef**: the definition of a member of the value type.
- **AttributeDef**: the definition of an attribute of the interface or value type.
- **ExtAttributeDef**: an extended version of **AttributeDef** that is capable of accommodating attributes with exceptions.
- **OperationDef**: the definition of an operation of the interface, value or event type; it contains lists of parameters and exceptions raised by this operation.
- **TypedefDef**: base interface for definitions of named types that are not interfaces components, homes, or value and event types.
- **ConstantDef**: the definition of a named constant.
- **ExceptionDef**: the definition of an exception that can be raised by an operation.
- **ComponentDef**: a component definition; it contains lists of provides, uses, consumes, publishes, supports, emits and attributes.
- **HomeDef**: a home definition; it contains lists of constants, types, exceptions, operations, attributes, factories and finders.
- **FactoryDef**: the definition of a factory; it is an operation that is specifically used for creating new instances of components in a home.
- **FinderDef**: the definition of a finder; it is an operation that is specifically used to find components within a home.
- **ProvidesDef**: the definition of an interface that is provided by a component.
- **UsesDef**: the definition of an interface that is used by a component.
- **EmitsDef**: the definition of events that are emitted by a component.
- **PublishesDef**: the definition of events that are published by a component.
- **ConsumesDef**: the definition of events that are consumed by a component.

The interface specifications for each *interface repository object* lists the attributes maintained by that object (see Section 10.5, “Interface Repository Interfaces,” on page 10-11). Many of these attributes correspond directly to OMG IDL statements. An implementation can choose to maintain additional attributes to facilitate managing the

Repository or to record additional (proprietary) information about an interface. Implementations that extend the IR interfaces shall do so by deriving new interfaces, not by modifying the standard interfaces.

The *CORBA* specification defines a minimal set of operations for *interface repository objects*. Additional operations that an implementation of the Interface Repository may provide could include operations that provide for the versioning of entities and for the reverse compilation of specifications (i.e., the generation of a file containing an object's OMG IDL specification).

#### *10.4.4 Structure and Navigation of the Interface Repository*

The definitions in the Interface Repository are structured as a set of *interface repository objects*. These objects are structured the same way definitions are structured—some objects (definitions) “contain” other objects.

The containment relationships for the *interface repository objects* types in the Interface Repository are shown in Figure 10-2.



|                                                                                                                                                                                                                                                          |                                                                                                                                                                                                                                                                                                  |
|----------------------------------------------------------------------------------------------------------------------------------------------------------------------------------------------------------------------------------------------------------|--------------------------------------------------------------------------------------------------------------------------------------------------------------------------------------------------------------------------------------------------------------------------------------------------|
| Repository or ComponentIR::Repository                                                                                                                                                                                                                    | Each interface repository is represented by a global root repository object.                                                                                                                                                                                                                     |
| ConstantDef<br>TypedefDef<br>ExceptionDef<br>[Ext]InterfaceDef<br>[Ext]ValueDef<br>EventDef - only in ComponentIR::Repository<br>ValueBoxDef<br>ModuleDef<br>ComponentDef - only in ComponentIR::Repository<br>HomeDef - only in ComponentIR::Repository | The Repository IR object represents the constants, typedefs, exceptions, interfaces, valuetypes, value boxes and modules that are defined outside the scope of a module.                                                                                                                         |
| ConstantDef<br>TypedefDef<br>ExceptionDef<br>ValueBoxDef<br>ModuleDef<br>[Ext][Abstract   local]InterfaceDef                                                                                                                                             | The Module IR object represents the constants, typedefs, exceptions, interfaces, valuetypes, value boxes, eventtypes, components, homes and other modules defined within the scope of the module.                                                                                                |
| ConstantDef<br>TypedefDef<br>ExceptionDef<br>[Ext]AttributeDef<br>OperationDef                                                                                                                                                                           | An Interface IR object represents constants, typedefs, exceptions, attributes, and operations defined within or inherited by the interface.<br><br>Operation IR objects reference exception objects.                                                                                             |
| [Ext]ValueDef   EventDef - only in ComponentIR::Repository                                                                                                                                                                                               |                                                                                                                                                                                                                                                                                                  |
| ConstantDef<br>TypedefDef<br>ExceptionDef<br>[Ext]AttributeDef<br>OperationDef<br>ValueMemberDef                                                                                                                                                         | A Valuetype IR object represents constants, typedefs, exceptions, attributes, and operations defined within or inherited by the interface.<br><br>Operation IR objects reference ExceptionDef exception objects.                                                                                 |
| ComponentDef - only in ComponentIR::Repository<br>ProvidesDef<br>UsesDef<br>EmitsDef<br>PublishesDef<br>ConsumesDef<br>[Ext]AttributeDef                                                                                                                 | A ComponentDef IR object represents the provides, uses, emits, publishes, consumes and attributes contained in the component.<br>Emits, publishes and consumes refers to event objects.<br>Provides and uses refers to interface objects.<br>AttributeDef IR objects reference exception objects |
| HomeDef - only in ComponentIR::Repository                                                                                                                                                                                                                |                                                                                                                                                                                                                                                                                                  |
| FactoryDef<br>FinderDef                                                                                                                                                                                                                                  | A HomeDef IR object represents factory and finder defined within or inherited by home.<br>Factory and finder refer to exception objects.                                                                                                                                                         |

Figure 10-2 Interface Repository Object Containment

There are three ways to locate an interface in the Interface Repository, by:

1. Obtaining an **InterfaceDef** object directly from the ORB.

2. Navigating through the module name space using a sequence of names.
3. Locating the **InterfaceDef** object that corresponds to a particular repository identifier.

There are four ways to locate a component in the Interface Repository, by:

1. Obtaining an **ComponentDef** object directly from the ORB.
2. Navigating through the module name space using a sequence of names.
3. Locating the **ComponentDef** object that corresponds to a particular repository identifier.
4. Obtaining the **ComponentDef** from the **HomeDef** object corresponding to its home.

There are three ways to locate a home in the Interface Repository, by:

1. Obtaining an **HomeDef** object directly from the ORB.
2. Navigating through the module name space using a sequence of names.
3. Locating the **HomeDef** object that corresponds to a particular repository identifier.

---

**Note** – It should be noted that given a **ComponentDef** IR object, it is not possible to obtain the **HomeDef** IR object for the home that manages this component, since there could be multiple such homes, and the actual relation of a specific component to a specific home is available only at runtime. To get to the **HomeDef** object corresponding to the home of a given component, one needs to do a **CCMObject::get\_home**, and then do a **CCMHome::get\_home\_def** on the home thus obtained.

---

Obtaining an **InterfaceDef** object directly is useful when an object is encountered whose type was not known at compile time. By using the **get\_interface** operation on the object reference, it is possible to retrieve the Interface Repository information about the object. That information could then be used to perform operations on the object. Similarly, by using the **CCMObject::get\_component\_def** operation, it is possible to retrieve the Component Repository information about a component.

Navigating the module name space is useful when information about a particular named interface is desired. Starting at the root module of the repository, it is possible to obtain entries by name.

Locating the **InterfaceDef** object by ID is useful when looking for an entry in one repository that corresponds to another. A repository identifier must be globally unique. By using the same identifier in two repositories, it is possible to obtain the interface identifier for an interface in one repository, and then obtain information about that interface from another repository that may be closer or contain additional information about the interface.

Analogous operations are provided for manipulating value and event types.

The **ComponentIR** module contains the IR Objects that were added to reflect new IDL constructs that were added to support Components. These are built upon the IR interfaces defined in **CORBA** module including **ExtInterfaceDef**, **ExtValueDef**, and **ExtAttributeDef** and thus are backward compatible extensions of the 2.5 and earlier versions of the IR.

## 10.5 Interface Repository Interfaces

Several interfaces are used as *base interfaces* for objects in the IR. These *base interfaces* are not instantiable.

A common set of operations is used to locate objects within the Interface Repository. These operations are defined in the interfaces **IObject**, **Container**, and **Contained** described below. All IR objects inherit from the **IObject** interface, which provides an operation for identifying the actual type of the object. Objects that are containers inherit navigation operations from the **Container** interface. Objects that are contained by other objects inherit navigation operations from the **Contained** interface.

The **IDLType** interface is inherited by all IR objects that represent IDL types, including interfaces, typedefs, and anonymous types. The **TypedefDef** interface is inherited by all named non-interface types.

The *base interfaces* **IObject**, **Contained**, **Container**, **IDLType**, **TypedefDef** **ComponentIR::Container** and **ComponentIR::EventPortDef** are not instantiable.

All string data in the Interface Repository are encoded as defined by the ISO 8859-1 coded character set.

Interface Repository operations indicate error conditions using the system exceptions **BAD\_PARAM** and **BAD\_INV\_ORDER** with specific minor codes. The specific operations that raise these exceptions are documented in the description of the operations. For a description of how these minor codes are encoded in the **ex\_body** of standard exceptions see Section 4.12.2, “System Exceptions,” on page 4-63 and Section 4.12.4, “Standard Minor Exception Codes,” on page 4-72. The exceptions and minor codes that are used by Interface Repository interfaces are as follows:

Table 10-1 Standard Exceptions used by the Interface Repository Operations

| Exception | Minor Code | Explanation                             |
|-----------|------------|-----------------------------------------|
| BAD_PARAM | 2          | RID is already defined in IFR           |
|           | 3          | Name already used in the context in IFR |
|           | 4          | Target is not a valid container         |
|           | 5          | Name clash in inherited context         |

Table 10-1 Standard Exceptions used by the Interface Repository Operations

| Exception     | Minor Code | Explanation                                                                                            |
|---------------|------------|--------------------------------------------------------------------------------------------------------|
| BAD_PARAM     | 31         | Attempt to define a oneway operation with non-void result, out or inout parameters or user exceptions. |
| BAD_INV_ORDER | 1          | Dependency exists in IFR preventing destruction of this object                                         |
|               | 2          | Attempt to destroy indestructible objects in IFR                                                       |

### 10.5.1 Supporting Type Definitions

Several types are used throughout the IR interface definitions.

```

module CORBA {
 typedef string Identifier;
 typedef string ScopedName;
 typedef string RepositoryId;

 enum DefinitionKind {
 dk_none, dk_all,
 dk_Attribute, dk_Constant, dk_Exception, dk_Interface,
 dk_Module, dk_Operation, dk_Typedef,
 dk_Alias, dk_Struct, dk_Union, dk_Enum,
 dk_Primitive, dk_String, dk_Sequence, dk_Array,
 dk_Repository,
 dk_Wstring, dk_Fixed,
 dk_Value, dk_ValueBox, dk_ValueMember,
 dk_Native,
 dk_AbstractInterface,
 dk_LocalInterface
 dk_Component, dk_Home,
 dk_Factory, dk_Finder,
 dk_Emits, dk_Publishes, dk_Consumes,
 dk_Provides, dk_Uses,
 dk_Event
 };
};

```

**Identifiers** are the simple names that identify modules, interfaces, components, homes, value and event types, value members, value boxes, constants, typedefs, exceptions, attributes, operations, ports, and native types. They correspond exactly to OMG IDL identifiers. An **Identifier** is not necessarily unique within an entire Interface Repository; it is unique only within a particular **Repository**, **ModuleDef**, **InterfaceDef**, **ComponentDef**, **HomeDef**, **ValueDef**, **EventDef**, **OperationDef**, **FactoryDef**, or **FinderDef**.

A **ScopedName** is a name made up of one or more **Identifiers** separated by the characters “:.”. They correspond to OMG IDL scoped names.

An *absolute* **ScopedName** is one that begins with “::” and unambiguously identifies a definition in a **Repository**. An *absolute* **ScopedName** in a **Repository** corresponds to a *global name* in an OMG IDL file. A *relative* **ScopedName** does not begin with “::” and must be resolved relative to some context.

A **RepositoryId** is an identifier used to uniquely and globally identify a module, interface, component, home, value type, event type, value member, value box, native type, constant, typedef, exception, attribute or operation. As **RepositoryIds** are defined as strings, they can be manipulated (e.g., copied and compared) using a language binding’s string manipulation routines.

A **DefinitionKind** identifies the type of an IR object.

## 10.5.2 *IObject*

The *base interface* **IObject** represents the most generic interface from which all other Interface Repository interfaces are derived, even the Repository itself.

```

module CORBA {
 interface IObject {

 // read interface
 readonly attribute DefinitionKind def_kind;

 // write interface
 void destroy ();
 };
};

```

### 10.5.2.1 *Read Interface*

The **def\_kind type\_name** attribute identifies the type of the definition.

### 10.5.2.2 *Write Interface*

The **destroy** operation causes the object to cease to exist. If the object is a **Container**, **destroy** is applied to all its contents. If the object contains an **IDLType** attribute for an anonymous type, that **IDLType** is destroyed. If the object is currently contained in some other object, it is removed. If **destroy** is invoked on a **Repository** or on a **PrimitiveDef** then the **BAD\_INV\_ORDER** exception is raised with minor value 2. Implementations may vary in their handling of references to an object that is being destroyed, but the Repository should not be left in an incoherent state. Attempt to destroy an object that would leave the repository in an incoherent state shall cause **BAD\_INV\_ORDER** exception to be raised with the minor code 1.

### 10.5.3 Contained

The *base interface* **Contained** is inherited by all Interface Repository interfaces that are contained by other IR objects. All objects within the Interface Repository, except the root object (**Repository**) and definitions of anonymous (**ArrayDef**, **StringDef**, **WstringDef**, **FixedDef** and **SequenceDef**), and primitive types are contained by other objects.

```

module CORBA {
 typedef string VersionSpec;

 interface Contained : IObject {
 // read/write interface

 attribute RepositoryId id;
 attribute Identifier name;
 attribute VersionSpec version;

 // read interface

 readonly attribute Container defined_in;
 readonly attribute ScopedName absolute_name;
 readonly attribute Repository containing_repository;

 struct Description {
 DefinitionKind kind;
 any value;
 };

 Description describe ();

 // write interface

 void move (
 in Container new_container,
 in Identifier new_name,
 in VersionSpec new_version
);
 };
};

```

#### 10.5.3.1 Read Interface

An object that is contained by another object has an **id** attribute that identifies it globally, and a **name** attribute that identifies it uniquely within the enclosing **Container** object. It also has a **version** attribute that distinguishes it from other versioned objects with the same **name**. IRs are not required to support simultaneous containment of multiple versions of the same named object. Supporting multiple versions will require mechanisms and policy not specified in this document.

**Contained** objects also have a **defined\_in** attribute that identifies the **Container** within which they are defined. Objects can be contained either because they are defined within the containing object (for example, an interface is defined within a module) or because they are inherited by the containing object (for example, an operation may be contained by an interface because the interface inherits the operation from another interface). If an object is contained through inheritance, the **defined\_in** attribute identifies the **InterfaceDef** or **ValueDef** from which the object is inherited.

The **absolute\_name** attribute is an absolute **ScopedName** that identifies a **Contained** object uniquely within its enclosing **Repository**. If this object's **defined\_in** attribute references a **Repository**, the **absolute\_name** is formed by concatenating the string "::" and this object's **name** attribute. Otherwise, the **absolute\_name** is formed by concatenating the **absolute\_name** attribute of the object referenced by this object's **defined\_in** attribute, the string "::", and this object's **name** attribute.

The **containing\_repository** attribute identifies the **Repository** that is eventually reached by recursively following the object's **defined\_in** attribute.

The **within** operation returns the list of objects that contain the object. If the object is an interface or module it can be contained only by the object that defines it. Other objects can be contained by the objects that define them and by the objects that inherit them.

The **describe** operation returns a structure containing information about the interface. The description structure associated with each interface is provided below with the interface's definition. The kind of definition described by name of the structure returned is provided with the returned structure. The **kind** field of the returned **Description** struct shall give the **DefinitionKind** for the most derived type of the object. For example, if the **describe** operation is invoked on an attribute object, the **kind** field contains **dk\_Attribute** name field contains "AttributeDescription" and the **value** field contains an **any**, which contains the **AttributeDescription** structure. The **kind** field in this must contain **dk\_attribute** and not the kind of any **IObject** from which the **attribute** object is derived. For example returning **dk\_all** would be an error.

### 10.5.3.2 Write Interface

Setting the **id** attribute changes the global identity of this definition. A **BAD\_PARAM** exception is raised with minor code 2 if an object with the specified **id** attribute already exists within this object's **Repository**.

Setting the **name** attribute changes the identity of this definition within its **Container**. A **BAD\_PARAM** exception is raised with minor code 1 if an object with the specified **name** attribute already exists within this object's **Container**. The **absolute\_name** attribute is also updated, along with any other attributes that reflect the name of the object. If this object is a **Container**, the **absolute\_name** attribute of any objects it contains are also updated.

The **move** operation atomically removes this object from its current **Container**, and adds it to the **Container** specified by **new\_container** must satisfy the following conditions:

- It must be in the same **Repository**. If it is not, then **BAD\_PARAM** exception is raised with minor code 4.
- It must be capable of containing this object's type (see Section 10.4.4, "Structure and Navigation of the Interface Repository," on page 10-8). If it is not, then **BAD\_PARAM** exception is raised with minor code 4.
- It must not already contain an object with this object's name (unless multiple versions are supported by the IR). If this condition is not satisfied, then **BAD\_PARAM** exception is raised with minor code 3.

The **name** attribute is changed to **new\_name**, and the **version** attribute is changed to **new\_version**.

The **defined\_in** and **absolute\_name** attributes are updated to reflect the new container and **name**. If this object is also a **Container**, the **absolute\_name** attributes of any objects it contains are also updated.

#### 10.5.4 Container

The *base interface* **Container** is used to form a containment hierarchy in the Interface Repository. A **Container** can contain any number of objects derived from the **Contained** interface. All **Containers**, except for **Repository**, are also derived from **Contained**.

```

module CORBA {
 typedef sequence <Contained> ContainedSeq;

 interface Container : IObject {
 // read interface

 Contained lookup (in ScopedName search_name);

 ContainedSeq contents (
 in DefinitionKind limit_type,
 in boolean exclude_inherited
);

 ContainedSeq lookup_name (
 in Identifier search_name,
 in long levels_to_search,
 in DefinitionKind limit_type,
 in boolean exclude_inherited
);

 struct Description {
 Contained contained_object;
 DefinitionKind kind;
 any value;
 };
 };
}

```



```

typedef sequence<Description> DescriptionSeq;

DescriptionSeq describe_contents (
 in DefinitionKind limit_type,
 in boolean exclude_inherited,
 in long max_returned_objs
);

// write interface

ModuleDef create_module (
 in RepositoryId id,
 in Identifier name,
 in VersionSpec version
);

ConstantDef create_constant (
 in RepositoryId id,
 in Identifier name,
 in VersionSpec version,
 in IDLType type,
 in any value
);

StructDef create_struct (
 in RepositoryId id,
 in Identifier name,
 in VersionSpec version,
 in StructMemberSeq members
);

UnionDef create_union (
 in RepositoryId id,
 in Identifier name,
 in VersionSpec version,
 in IDLType discriminator_type,
 in UnionMemberSeq members
);

EnumDef create_enum (
 in RepositoryId id,
 in Identifier name,
 in VersionSpec version,
 in EnumMemberSeq members
);

AliasDef create_alias (
 in RepositoryId id,
 in Identifier name,
 in VersionSpec version,
 in IDLType original_type
);

```

);

```
InterfaceDef create_interface (
 in RepositoryId id,
 in Identifier name,
 in VersionSpec version,
 in InterfaceDefSeq base_interfaces,
);
```

```
ExceptionDef create_exception(
 in RepositoryId id,
 in Identifier name,
 in VersionSpec version,
 in StructMemberSeq members
);
```

```
ValueDef create_value(
 in RepositoryId id,
 in Identifier name,
 in VersionSpec version,
 in boolean is_custom,
 in boolean is_abstract,
 in ValueDef base_value,
 in boolean is_truncatable,
 in ValueDefSeq abstract_base_values,
 in InterfaceDefSeq supported_interfaces,
 in InitializerSeq initializers
);
```

```
ValueBoxDef create_value_box(
 in RepositoryId id,
 in Identifier name,
 in VersionSpec version,
 in IDLType original_type_def
);
```

```
NativeDef create_native(
 in RepositoryId id,
 in Identifier name,
 in VersionSpec version
);
```

```
AbstractInterfaceDef create_abstract_interface(
 in RepositoryId id,
 in Identifier name,
 in VersionSpec version,
 in AbstractInterfaceDefSeq base_interfaces,
);
```

```
LocalInterfaceDef create_local_interface(
 in RepositoryId id,
```

```

 in Identifier name,
 in VersionSpec version,
 in InterfaceDefSeq base_interfaces
);

 ExtValueDef create_ext_value (
 in RepositoryId id,
 in Identifier name,
 in VersionSpec version,
 in boolean is_custom,
 in boolean is_abstract,
 in ValueDef base_value,
 in boolean is_truncatable,
 in ValueDefSeq abstract_base_values,
 in InterfaceDefSeq supported_interfaces,
 in ExtInitializerSeq initializers
);
};
};
};

```

#### 10.5.4.1 Read Interface

The **lookup** operation locates a definition relative to this container given a scoped name using OMG IDL's name scoping rules. An absolute scoped name (beginning with "::") locates the definition relative to the enclosing **Repository**. If no object is found, a nil object reference is returned.

The **contents** operation returns the list of objects directly contained by or inherited into the object. The operation is used to navigate through the hierarchy of objects. Starting with the Repository object, a client uses this operation to list all of the objects contained by the Repository, all of the objects contained by the modules within the Repository, and then all of the interfaces and value types within a specific module, and so on.

|                   |                                                                                                                                                                                                                                                                                                                                                                                                     |
|-------------------|-----------------------------------------------------------------------------------------------------------------------------------------------------------------------------------------------------------------------------------------------------------------------------------------------------------------------------------------------------------------------------------------------------|
| limit_type        | If limit_type is set to dk_all "all," objects of all interface types are returned. For example, if this is an InterfaceDef, the attribute, operation, and exception objects are all returned. If limit_type is set to a specific interface, only objects of that interface type are returned. For example, only attribute objects are returned if limit_type is set to dk_Attribute "AttributeDef". |
| exclude_inherited | If set to TRUE, inherited objects (if there are any) are not returned. If set to FALSE, all contained objects—whether contained due to inheritance or because they were defined within the object—are returned.                                                                                                                                                                                     |

The `lookup_name` operation is used to locate an object by name within a particular object or within the objects contained by that object. Use of values of `levels_to_search` of 0 or of negative numbers other than -1 is undefined.

|                               |                                                                                                                                                                   |
|-------------------------------|-------------------------------------------------------------------------------------------------------------------------------------------------------------------|
| <code>search_name</code>      | Specifies which name is to be searched for.                                                                                                                       |
| <code>levels_to_search</code> | Controls whether the lookup is constrained to the object the operation is invoked on or whether it should search through objects contained by the object as well. |

Setting `levels_to_search` to -1 searches the current object and all contained objects. Setting `levels_to_search` to 1 searches only the current object. Use of values of `levels_to_search` of 0 or of negative numbers other than -1 is undefined.

The `describe_contents` operation combines the `contents` operation and the `describe` operation. For each object returned by the `contents` operation, the description of the object is returned (i.e., the object's `describe` operation is invoked and the results returned).

|                                |                                                                                                                                                                        |
|--------------------------------|------------------------------------------------------------------------------------------------------------------------------------------------------------------------|
| <code>max_returned_objs</code> | Limits the number of objects that can be returned in an invocation of the call to the number provided. Setting the parameter to -1 means return all contained objects. |
|--------------------------------|------------------------------------------------------------------------------------------------------------------------------------------------------------------------|

**contents** and **describe\_contents** return a list of elements in their original order (i.e., the order in which the elements were created in or moved into the container). If **exclude\_inherited** is false, the ordering of inherited elements is undefined.

#### 10.5.4.2 *Write Interface*

The **Container** interface provides operations to create **ModuleDefs**, **ConstantDefs**, **StructDefs**, **UnionDefs**, **EnumDefs**, **AliasDefs**, **InterfaceDefs**, **ValueDefs**, **ValueBoxDefs**, and **NativeDefs** as contained objects. The **defined\_in** attribute of a definition created with any of these operations is initialized to identify the **Container** on which the operation is invoked, and the **containing\_repository** attribute is initialized to its **Repository**.

The **create\_<type>** operations all take **id** and **name** parameters that are used to initialize the identity of the created definition. A **BAD\_PARAM** exception is raised with minor code 2 if an object with the specified **id** already exists in the **Repository**. A **BAD\_PARAM** exception with minor code 3 is raised if the specified **name** already exists within this **Container** and multiple versions are not supported. Certain interfaces derived from **Container** may restrict the types of definitions that they may contain. Any **create\_<type>** operation that would insert a definition that is not allowed by a **Container** will raise the **BAD\_PARAM** exception with minor code 4.

The **create\_module** operation returns a new empty **ModuleDef**. Definitions can be added using **Container::create\_<type>** operations on the new module, or by using the **Contained::move** operation.

The **create\_constant** operation returns a new **ConstantDef** with the specified **type** and **value**.

The **create\_struct** operation returns a new **StructDef** with the specified **members**. The **type** member of the **StructMember** structures is ignored, and should be set to **TC\_void**. See Section 10.5.10, “StructDef,” on page 10-26 for more information.

The **create\_union** operation returns a new **UnionDef** with the specified **discriminator\_type** and **members**. The **type** member of the **UnionMember** structures is ignored, and should be set to **TC\_void**. See Section 10.5.11, “UnionDef,” on page 10-27 for more information.

The **create\_enum** operation returns a new **EnumDef** with the specified **members**. See Section 10.5.12, “EnumDef,” on page 10-28 for more information.

The **create\_alias** operation returns a new **AliasDef** with the specified **original\_type**.

The **create\_interface** operation returns a new empty **ExtInterfaceDef** with the specified **base\_interfaces**. Type, exception, and constant definitions can be added using **Container::create\_<type>** operations on the new **InterfaceDef**. **OperationDefs** can be added using **InterfaceDef::create\_operation** and **AttributeDefs** can be added using **InterfaceDef::create\_attribute**. Definitions can also be added using the **Contained::move** operation.

The **create\_abstract\_interface** operation returns a new empty **ExtAbstractInterfaceDef** with the specified **base\_interfaces**. Type, exception, and constant definitions can be added using **Container::create\_<type>** operations on the new **AbstractInterfaceDef**. **OperationDefs** can be added using **AbstractInterfaceDef::create\_operation** and **AttributeDefs** can be added using **AbstractInterfaceDef::create\_attribute**. Definitions can also be added using the **Contained::move** operation.

The **create\_local\_interface** operation returns a new empty **ExtLocalInterfaceDef** with the specified **base\_interfaces**. Type, exception, and constant definitions can be added using **Container::create\_<type>** operations on the new **LocalInterfaceDef**. **OperationDefs** can be added using **LocalInterfaceDef::create\_operation** and **AttributeDefs** can be added using **LocalInterfaceDef::create\_attribute**. Definitions can also be added using the **Contained::move** operation.

The **create\_value** operation returns a new empty **ValueDef** with the specified base interfaces and values (**base\_value**, **supported\_interfaces**, and **abstract\_base\_values**) as well as the other information describing the new values characteristics (**is\_custom**, **is\_abstract**, **is\_truncatable**, and **initializers**). Type, exception, and constant definitions can be added using **Container::create\_<type>** operations on the new **ValueDef**. **OperationDefs** can be added using

**ValueDef::create\_operation** and **AttributeDefs** can be added using **ValueDef::create\_attribute**. Definitions can also be added using the **Contained::move** operation.

The **create\_value\_box** operation returns a new **ValueBoxDef** with the specified **original\_type\_def**.

The **create\_exception** operation returns a new **ExceptionDef** with the specified members. The **type** member of the **StructMember** structures should be set to **TC\_void**.

The **create\_native** operation returns a new **NativeDef** with the specified **name**.

The **create\_ext\_value** operation returns a new empty **ExtValueDef** with the specified base interfaces and values (**base\_value**, **supported\_interfaces**, and **abstract\_base\_values**) as well as the other information describing the new values characteristics (**is\_custom**, **is\_abstract**, **is\_truncatable**, and **initializers**). The **initializers** argument is of type **ExtInitializerSeq** allowing one to specify user exceptions for initializers. Type, exception, and constant definitions can be added using **Container::create\_<type>** operations on the new **ExtValueDef**. **OperationDefs** can be added using **ExtValueDef::create\_operation** and **ExtAttributeDefs** can be added using **ExtValueDef::create\_ext\_attribute**. Definitions can also be added using the **Contained::move** operation.

### 10.5.5 IDLType

The *base interface* **IDLType** is inherited by all IR objects that represent OMG IDL types. It provides access to the **TypeCode** describing the type, and is used in defining other interfaces wherever definitions of IDL types must be referenced.

```
module CORBA {
 interface IDLType : IObject {
 readonly attribute TypeCode type;
 };
};
```

The **type** attribute describes the type defined by an object derived from **IDLType**.

### 10.5.6 Repository

**Repository** is an interface that provides global access to the Interface Repository that does not support access to information related to CORBA Components. The **Repository** object can contain constants, typedefs, exceptions, interfaces, value types, value boxes, native types, and modules. As it inherits from **Container**, it can be used to look up any definition (whether globally defined or defined within a module or interface) either by **name** or by **id**.

Since **Repository** derives only from **Container** and not from **Contained**, it does not have a **RepositoryId** associated with it. By default it is deemed to have the **RepositoryId ""** (the empty string) for purposes of assigning a value to the

**defined\_in** field of the **description** structure of **ModuleDef**, **InterfaceDef**, **ValueDef**, **ValueBoxDef**, **TypedefDef**, **ExceptionDef**, and **ConstantDef** that are contained immediately in the Repository object.

There may be more than one Interface Repository in a particular ORB environment (although some ORBs might require that definitions they use be registered with a particular repository). Each ORB environment will provide a means for obtaining object references to the Repositories available within the environment.

```

module CORBA {
 interface Repository : Container {
 // read interface

 Contained lookup_id (in RepositoryId search_id);

 TypeCode get_canonical_typecode(in TypeCode tc);

 PrimitiveDef get_primitive (in PrimitiveKind kind);

 // write interface

 StringDef create_string (in unsigned long bound);

 WstringDef create_wstring(in unsigned long bound);

 SequenceDef create_sequence (
 in unsigned long bound,
 in IDLType element_type
);

 ArrayDef create_array (
 in unsigned long length,
 in IDLType element_type
);

 FixedDef create_fixed(
 in unsigned short digits,
 in short scale
);
 };
};

```

#### 10.5.6.1 Read Interface

The **lookup\_id** operation is used to lookup an object in a **Repository** given its **RepositoryId**. If the **Repository** does not contain a definition for **search\_id**, a nil object reference is returned. The **lookup\_id** operations always return a nil reference if the value of **search\_id** is **IDL:omg.org/CORBA/Object:1.0**, or **IDL:omg.org/CORBA/ValueBase:1.0**, signifying the fact that the implicit base types are not contained in the Interface Repository.

The **get\_canonical\_typecode** operation looks up the **TypeCode** in the Interface Repository and returns an equivalent **TypeCode** that includes all **repository ids**, **names**, and **member\_names**. If the top level **TypeCode** does not contain a **RepositoryId**, such as array and sequence **TypeCodes**, or **TypeCodes** from older ORBs, or if it contains a **RepositoryId** that is not found in the target **Repository**, then a new **TypeCode** is constructed by recursively calling **get\_canonical\_typecode** on each member **TypeCode** of the original **TypeCode**.

The **get\_primitive** operation returns a reference to a **PrimitiveDef** (see Section 10.5.14, “PrimitiveDef,” on page 10-29) with the specified **kind** attribute. All **PrimitiveDefs** are immutable and are owned by the **Repository**.

### 10.5.6.2 Write Interface

The five **create\_<type>** operations that create new IR objects defining anonymous types. As these interfaces are not derived from **Contained**, it is the caller’s responsibility to invoke **destroy** on the returned object if it is not successfully used in creating a definition that is derived from **Contained**. Each anonymous type definition must be used in defining exactly one other object.

1. The **create\_string** operation returns a new **StringDef** with the specified **bound**, which must be non-zero. The **get\_primitive** operation is used for unbounded strings.
2. The **create\_wstring** operation returns a new **WstringDef** with the specified **bound**, which must be non-zero. The **get\_primitive** operation is used for unbounded strings.
3. The **create\_sequence** operation returns a new **SequenceDef** with the specified **bound** and **element\_type**.
4. The **create\_array** operation returns a new **ArrayDef** with the specified **length** and **element\_type**.
5. The **create\_fixed** operation returns a new **FixedDef** with the specified number of digits and scale. The number of digits must be from 1 to 31, inclusive.

### 10.5.7 ModuleDef

A **ModuleDef** can contain constants, typedefs, exceptions, interfaces, value types, value boxes, native types and other module objects.

```

module CORBA {
 interface ModuleDef : Container, Contained {};

 struct ModuleDescription {
 Identifier name;
 RepositoryId id;
 RepositoryId defined_in;
 };

```



```

 VersionSpec version;
 };
};

```

The inherited **describe** operation for a **ModuleDef** object returns a **ModuleDescription**.

### 10.5.8 ConstantDef

A **ConstantDef** object defines a named constant.

```

module CORBA {
 interface ConstantDef : Contained {
 readonly attribute TypeCode type;
 attribute IDLType type_def;
 attribute any value;
 };

 struct ConstantDescription {
 Identifier name;
 RepositoryId id;
 RepositoryId defined_in;
 VersionSpec version;
 TypeCode type;
 any value;
 };
};

```

#### 10.5.8.1 Read Interface

The **type** attribute specifies the **TypeCode** describing the type of the constant. The type of a constant must be one of the primitive types allowed in constant declarations (see Section 3.10, “Constant Declaration,” on page 3-32). The **type\_def** attribute identifies the definition of the type of the constant.

The **value** attribute contains the value of the constant, not the computation of the value (e.g., the fact that it was defined as “1+2”).

The **describe** operation for a **ConstantDef** object returns a **ConstantDescription**.

#### 10.5.8.2 Write Interface

Setting the **type\_def** attribute also updates the **type** attribute.

When setting the **value** attribute, the **TypeCode** of the supplied any must be equal to the **type** attribute of the **ConstantDef**.

### 10.5.9 TypedefDef

The *base interface* **TypedefDef** is inherited by all named non-object types (structures, unions, enumerations, and aliases). The **TypedefDef** interface is not inherited by the definition objects for primitive or anonymous types.

```

module CORBA {
 interface TypedefDef : Contained, IDLType {};

 struct TypeDescription {
 Identifier name;
 RepositoryId id;
 RepositoryId defined_in;
 VersionSpec version;
 TypeCode type;
 };
};

```

The inherited **describe** operation for interfaces derived from **TypedefDef** returns a **TypeDescription**.

### 10.5.10 StructDef

A **StructDef** represents an OMG IDL structure definition. It can contain structs, unions, and enums.

```

module CORBA {

 struct StructMember {
 Identifier name;
 TypeCode type;
 IDLType type_def;
 };

 typedef sequence <StructMember> StructMemberSeq;

 interface StructDef : TypedefDef, Container {
 attribute StructMemberSeq members;
 };
};

```

#### 10.5.10.1 Read Interface

The **members** attribute contains a description of each structure member. The inherited **type** attribute is a **tk\_struct TypeCode** describing the structure.

### 10.5.10.2 Write Interface

Setting the **members** attribute also updates the **type** attribute. When setting the **members** attribute, the **type** member of the **StructMember** structure should be set to **TC\_void**.

A **StructDef** used as a **Container** may only contain **StructDef**, **UnionDef**, or **EnumDef** definitions.

### 10.5.11 UnionDef

A **UnionDef** represents an OMG IDL union definition.

```

module CORBA {
 struct UnionMember {
 Identifier name;
 any label;
 TypeCode type;
 IDLType type_def;
 };
 typedef sequence <UnionMember> UnionMemberSeq;

 interface UnionDef : TypedefDef, Container {
 readonly attribute TypeCode discriminator_type;
 attribute IDLType discriminator_type_def;
 attribute UnionMemberSeq members;
 };
};

```

#### 10.5.11.1 Read Interface

The **discriminator\_type** and **discriminator\_type\_def** attributes describe and identify the union's discriminator type.

The **members** attribute contains a description of each union member. The **label** of each **UnionMemberDescription** is a distinct value of the **discriminator\_type**. Adjacent members can have the same **name**. Members with the same **name** must also have the same **type**. A **label** with type **octet** and value 0 indicates the default union member.

The inherited **type** attribute is a **tk\_union TypeCode** describing the union.

#### 10.5.11.2 Write Interface

Setting the **discriminator\_type\_def** attribute also updates the **discriminator\_type** attribute and setting the **discriminator\_type\_def** or **members** attribute also updates the **type** attribute.

When setting the **members** attribute, the **type** member of the **UnionMember** structure should be set to **TC\_void**.

A **UnionDef** used as a **Container** may only contain **StructDef**, **UnionDef**, or **EnumDef** definitions.

### 10.5.12 EnumDef

An **EnumDef** represents an OMG IDL enumeration definition.

```
module CORBA {
 typedef sequence <Identifier> EnumMemberSeq;

 interface EnumDef : TypedefDef {
 attribute EnumMemberSeq members;
 };
};
```

#### 10.5.12.1 Read Interface

The **members** attribute contains a distinct name for each possible value of the enumeration.

The inherited **type** attribute is a **tk\_enum TypeCode** describing the enumeration.

#### 10.5.12.2 Write Interface

Setting the **members** attribute also updates the **type** attribute.

### 10.5.13 AliasDef

An **AliasDef** represents an OMG IDL typedef that aliases another definition.

```
module CORBA {
 interface AliasDef : TypedefDef {
 attribute IDLType original_type_def;
 };
};
```

#### 10.5.13.1 Read Interface

The **original\_type\_def** attribute identifies the type being aliased.

The inherited **type** attribute is a **tk\_alias TypeCode** describing the alias.

#### 10.5.13.2 Write Interface

Setting the **original\_type\_def** attribute also updates the **type** attribute.

### 10.5.14 PrimitiveDef

A **PrimitiveDef** represents one of the OMG IDL primitive types. As primitive types are unnamed, this interface is not derived from **TypedefDef** or **Contained**.

```

module CORBA {
 enum PrimitiveKind {
 pk_null, pk_void, pk_short, pk_long, pk_ushort, pk_ulong,
 pk_float, pk_double, pk_boolean, pk_char, pk_octet,
 pk_any, pk_TypeCode, pk_Principal, pk_string, pk_objref,
 pk_longlong, pk_ulonglong, pk_longdouble, pk_wchar, pk_wstring,
 pk_value_base
 };

 interface PrimitiveDef: IDLType {
 readonly attribute PrimitiveKind kind;
 };
};

```

The **kind** attribute indicates which primitive type the **PrimitiveDef** represents. There are no **PrimitiveDefs** with kind **pk\_null**. A **PrimitiveDef** with kind **pk\_string** represents an unbounded string. A **PrimitiveDef** with kind **pk\_objref** represents the IDL type **Object**. A **PrimitiveDef** with kind **pk\_value\_base** represents the IDL type **ValueBase**.

The inherited **type** attribute describes the primitive type.

All **PrimitiveDefs** are owned by the Repository. References to them are obtained using **Repository::get\_primitive**.

### 10.5.15 StringDef

A **StringDef** represents an IDL bounded string type. The unbounded string type is represented as a **PrimitiveDef**. As string types are anonymous, this interface is not derived from **TypedefDef** or **Contained**.

```

module CORBA {
 interface StringDef : IDLType {
 attribute unsigned long bound;
 };
};

```

The **bound** attribute specifies the maximum number of characters in the string and must not be zero. The inherited **type** attribute is a **tk\_string TypeCode** describing the string.

### 10.5.16 *WstringDef*

A **WstringDef** represents an IDL wide string. The unbounded wide string type is represented as a **PrimitiveDef**. As wide string types are anonymous, this interface is not derived from **TypedefDef** or **Contained**.

```
module CORBA {
 interface WstringDef : IDLType {
 attribute unsigned long bound;
 };
};
```

The **bound** attribute specifies the maximum number of wide characters in a wide string, and must not be zero. The inherited **type** attribute is a **tk\_wstring TypeCode** describing the wide string.

### 10.5.17 *FixedDef*

A **FixedDef** represents an IDL fixed point type.

```
module CORBA {
 interface FixedDef : IDLType {
 attribute unsigned short digits;
 attribute short scale;
 };
};
```

The **digits** attribute specifies the total number of decimal digits in the number, and must be from 1 to 31, inclusive. The **scale** attribute specifies the position of the decimal point.

The inherited **type** attribute is a **tk\_fixed TypeCode**, which describes a fixed-point decimal number.

### 10.5.18 *SequenceDef*

A **SequenceDef** represents an IDL sequence type. As sequence types are anonymous, this interface is not derived from **TypedefDef** or **Contained**.

```
module CORBA {
 interface SequenceDef : IDLType {
 attribute unsigned long bound;
 readonly attribute TypeCode element_type;
 attribute IDLType element_type_def;
 };
};
```

### 10.5.18.1 Read Interface

The **bound** attribute specifies the maximum number of elements in the sequence. A **bound** of zero indicates an unbounded sequence.

The type of the elements is described by **element\_type** and identified by **element\_type\_def**. The inherited **type** attribute is a **tk\_sequence TypeCode** describing the sequence.

### 10.5.18.2 Write Interface

Setting the **element\_type\_def** attribute also updates the **element\_type** attribute. Setting the **bound** or **element\_type\_def** attribute also updates the **type** attribute.

## 10.5.19 ArrayDef

An **ArrayDef** represents an IDL array type. As array types are anonymous, this interface is not derived from **TypedefDef** or **Contained**.

```

module CORBA {
 interface ArrayDef : IDLType {
 attribute unsigned long length;
 readonly attribute TypeCode element_type;
 attribute IDLType element_type_def;
 };
};

```

### 10.5.19.1 Read Interface

The **length** attribute specifies the number of elements in the array.

The type of the elements is described by **element\_type** and identified by **element\_type\_def**. Since an **ArrayDef** only represents a single dimension of an array, multi-dimensional IDL arrays are represented by multiple **ArrayDef** objects, one per array dimension. The **element\_type\_def** attribute of the **ArrayDef** representing the leftmost index of the array, as defined in IDL, will refer to the **ArrayDef** representing the next index to the right, and so on. The innermost **ArrayDef** represents the rightmost index and the element type of the multi-dimensional OMG IDL array.

The inherited **type** attribute is a **tk\_array TypeCode** describing the array.

### 10.5.19.2 Write Interface

Setting the **element\_type\_def** attribute also updates the **element\_type** attribute. Setting the **bound** or **element\_type\_def** attribute also updates the **type** attribute.

### 10.5.20 *ExceptionDef*

An **ExceptionDef** represents an exception definition. It can contain structs, unions, and enums.

```

module CORBA {
 interface ExceptionDef : Contained, Container {
 readonly attribute TypeCode type;
 attribute StructMemberSeq members;
 };

 struct ExceptionDescription {
 Identifier name;
 RepositoryId id;
 RepositoryId defined_in;
 VersionSpec version;
 TypeCode type;
 };
};

```

#### 10.5.20.1 *Read Interface*

The **type** attribute is a **tk\_except TypeCode** describing the exception. The members **attribute** describes any exception members. The **describe** operation for a **ExceptionDef** object returns an **ExceptionDescription**.

#### 10.5.20.2 *Write Interface*

Setting the **members** attribute also updates the **type** attribute. When setting the **members** attribute, the **type** member of the **StructMember** structure is ignored and should be set to **TC\_void**.

An **ExceptionDef** used as a **Container** may only contain **StructDef**, **UnionDef**, or **EnumDef** definitions.

### 10.5.21 *AttributeDef*

An **AttributeDef** represents the information that defines an attribute of an interface, component, home, valuetype, or eventtype.

```

module CORBA {
 enum AttributeMode {ATTR_NORMAL, ATTR_READONLY};

 interface AttributeDef : Contained {
 readonly attribute TypeCode type;
 attribute IDLType type_def;
 attribute AttributeMode mode;
 };

```



```

struct AttributeDescription {
 Identifier name;
 RepositoryId id;
 RepositoryId defined_in;
 VersionSpec version;
 TypeCode type;
 AttributeMode mode;
};

```

### 10.5.21.1 Read Interface

The **type** attribute provides the **TypeCode** describing the type of this attribute. The **type\_def** attribute identifies the object defining the type of this attribute.

The **mode** attribute specifies read only or read/write access for this attribute.

The **describe** operation for an **AttributeDef** object returns an **AttributeDescription**.

### 10.5.21.2 Write Interface

Setting the **type\_def** attribute also updates the **type** attribute.

## 10.5.22 ExtAttributeDef

An **ExtAttributeDef** represents the information that defines an attribute of an interface, component, home, valuetype, or eventtype that can potentially have user exceptions associated with it.

```

module CORBA{
 struct ExtAttributeDescription {
 Identifier name;
 RepositoryId id;
 RepositoryId defined_in;
 VersionSpec version;
 TypeCode type;
 AttributeMode mode;
 ExcDescriptionSeq get_exceptions;
 ExcDescriptionSeq put_exceptions;
 };

 interface ExtAttributeDef : AttributeDef {

 // read/write interface
 attribute ExcDescriptionSeq get_exceptions;
 attribute ExcDescriptionSeq set_exceptions;
 };
}

```

```

 // read interface
 ExtAttributeDescription describe_attribute();
 };

```

### 10.5.22.1 Read Interface

The operations inherited from **AttributeDef** behave exactly the same as in **AttributeDef**. In particular, the **def\_kind** attribute that has the value **dk\_Attribute**, exactly as in **AttributeDef**.

The **get\_exceptions** and **set\_exceptions** attributes specify the list of exception types that can be raised by the attribute.

The **describe\_attribute** operation for an **ExtAttributeDef** object returns an **ExtAttributeDescription**, that contains information about user exceptions in addition to the information that is available through **AttributeDescription**.

### 10.5.22.2 Write Interface

Same as for **AttributeDef**.

## 10.5.23 OperationDef

An **OperationDef** represents the information needed to define an operation of an interface.

```

module CORBA {
 enum OperationMode {OP_NORMAL, OP_ONeway};

 enum ParameterMode {PARAM_IN, PARAM_OUT, PARAM_INOUT};

 struct ParameterDescription {
 Identifier name;
 TypeCode type;
 IDLType type_def;
 ParameterMode mode;
 };
 typedef sequence <ParameterDescription> ParDescriptionSeq;

 typedef Identifier ContextIdentifier;
 typedef sequence <ContextIdentifier> ContextIdSeq;

 typedef sequence <ExceptionDef> ExceptionDefSeq;
 typedef sequence <ExceptionDescription> ExcDescriptionSeq;

 interface OperationDef : Contained {
 readonly attribute TypeCode result;
 attribute IDLType result_def;
 attribute ParDescriptionSeq params;
 attribute OperationMode mode;
 };

```

```

 attribute ContextIdSeq contexts;
 attribute ExceptionDefSeq exceptions;
 };

 struct OperationDescription {
 Identifier name;
 RepositoryId id;
 RepositoryId defined_in;
 VersionSpec version;
 TypeCode result;
 OperationMode mode;
 ContextIdSeq contexts;
 ParDescriptionSeq parameters;
 ExcDescriptionSeq exceptions;
 };
};

```

### 10.5.23.1 Read Interface

The **result** attribute is a **TypeCode** describing the type of the value returned by the operation. The **result\_def** attribute identifies the definition of the returned type.

The **params** attribute describes the parameters of the operation. It is a sequence of **ParameterDescription** structures. The order of the **ParameterDescriptions** in the sequence is significant. The **name** member of each structure provides the parameter name. The **type** member is a **TypeCode** describing the type of the parameter. The **type\_def** member identifies the definition of the type of the parameter. The **mode** member indicates whether the parameter is an in, out, or inout parameter.

The operation's **mode** is either oneway (i.e., no output is returned) or normal.

The **contexts** attribute specifies the list of context identifiers that apply to the operation.

The **exceptions** attribute specifies the list of exception types that can be raised by the operation.

The inherited **describe** operation for an **OperationDef** object returns an **OperationDescription**.

### 10.5.23.2 Write Interface

Setting the **result\_def** attribute also updates the **result** attribute.

The mode attribute can be set to **OP\_ONEWAY** only if the result is **TC\_void** and all elements of params have a mode of **PARAM\_IN**, and the list of exceptions is empty. If the mode is set to **OP\_ONEWAY** when these conditions do not hold, a **BAD\_PARAM** exception is raised with minor code 31.

### 10.5.24 InterfaceDef

An **InterfaceDef** object represents interface definition. It can contain constants, typedefs, exceptions, operations, and attributes.

```

module CORBA {
 interface InterfaceDef;
 typedef sequence <InterfaceDef> InterfaceDefSeq;
 typedef sequence <RepositoryId> RepositoryIdSeq;
 typedef sequence <OperationDescription> OpDescriptionSeq;
 typedef sequence <AttributeDescription> AttrDescriptionSeq;

 interface InterfaceDef : Container, Contained, IDLType {
 // read/write interface

 attribute InterfaceDefSeq base_interfaces;

 // read interface

 boolean is_a (in RepositoryId interface_id);

 struct FullInterfaceDescription {
 Identifier name;
 RepositoryId id;
 RepositoryId defined_in;
 VersionSpec version;
 OpDescriptionSeq operations;
 AttrDescriptionSeq attributes;
 RepositoryIdSeq base_interfaces;
 TypeCode type;
 };

 FullInterfaceDescription describe_interface();

 // write interface

 AttributeDef create_attribute (
 in RepositoryId id,
 in Identifier name,
 in VersionSpec version,
 in IDLType type,
 in AttributeMode mode
);

 OperationDef create_operation (
 in RepositoryId id,
 in Identifier name,
 in VersionSpec version,
 in IDLType result,
 in OperationMode mode,
 in ParDescriptionSeq params,

```

```

 in ExceptionDefSeq exceptions,
 in ContextIdSeq contexts
);
};

struct InterfaceDescription {
 Identifier name;
 RepositoryId id;
 RepositoryId defined_in;
 VersionSpec version;
 RepositoryIdSeq base_interfaces;
};
};

```

### 10.5.24.1 Read Interface

The **base\_interfaces** attribute lists all the interfaces from which this interface inherits.

The **is\_a** operation returns **TRUE** if the interface on which it is invoked either is identical to or inherits, directly or indirectly, from the interface identified by its **interface\_id** parameter. Otherwise it returns **FALSE**. If the value of **interface\_id** is **IDL:omg.org/CORBA/Object:1.0**, **is\_a** returns **TRUE** signifying the fact that all interfaces are implicitly derived from the base type **Object**.

The **describe\_interface** operation returns a **FullInterfaceDescription** describing the interface, including its operations and attributes. The **operations** and **attributes** fields of the **FullInterfaceDescription** structure include descriptions of all of the operations and attributes in the transitive closure of the inheritance graph of the interface being described.

The inherited **describe** operation for an **InterfaceDef** returns an **InterfaceDescription**.

The inherited **contents** operation returns the list of constants, typedefs, and exceptions defined in this **InterfaceDef** and the list of attributes and operations either defined or inherited in this **InterfaceDef**. If the **exclude\_inherited** parameter is set to **TRUE**, only attributes and operations defined within this interface are returned. If the **exclude\_inherited** parameter is set to **FALSE**, all attributes and operations are returned.

### 10.5.24.2 Write Interface

Setting the **base\_interfaces** attribute causes a **BAD\_PARAM** exception with minor code 5 to be raised if the **name** attribute of any object contained by this **InterfaceDef** conflicts with the **name** attribute of any object contained by any of the specified base **InterfaceDefs**.

The **create\_attribute** operation returns a new **AttributeDef** contained in the **InterfaceDef** on which it is invoked. The **id**, **name**, **version**, **type\_def**, and **mode** attributes are set as specified. The **type** attribute is also set. The **defined\_in** attribute

is initialized to identify the containing **InterfaceDef**. A **BAD\_PARAM** exception with standard minor code 2 is raised if an object with the specified **id** already exists in the **Repository**. **BAD\_PARAM** exception with standard minor code 3 is raised if an object with the same **name** already exists in this **InterfaceDef**.

The **create\_operation** operation returns a new **OperationDef** contained in the **InterfaceDef** on which it is invoked. The **id**, **name**, **version**, **result\_def**, **mode**, **params**, **exceptions**, and **contexts** attributes are set as specified. The **result** attribute is also set. The **defined\_in** attribute is initialized to identify the containing **InterfaceDef**. A **BAD\_PARAM** exception with standard minor code 2 is raised if an object with the specified **id** already exists in the **Repository**. **BAD\_PARAM** exception with standard minor code 3 is raised if an object with the same **name** already exists in this **InterfaceDef**.

An **InterfaceDef** used as a **Container** may only contain **TypedefDef**, (including definitions derived from **TypedefDef**), **ConstantDef**, and **ExceptionDef** definitions.

### 10.5.25 *ExtInterfaceDef*

An **ExtInterfaceDef** object represents interface definition. It can contain constants, typedefs, exceptions, operations, and attributes with exceptions.

```

module CORBA {

 interface InterfaceAttrExtension {

 // read interface

 struct ExtFullInterfaceDescription {
 Identifier name;
 RepositoryId id;
 RepositoryId defined_in;
 VersionSpec version;
 OpDescriptionSeq operations;
 ExtAttrDescriptionSeq attributes;
 RepositoryIdSeq base_interfaces;
 TypeCode type;
 };
 ExtFullInterfaceDescription describe_ext_interface();

 // write interface
 ExtAttributeDef create_ext_attribute (
 in RepositoryId id,
 in Identifier name,
 in VersionSpec version,
 in IDLType type,
 in AttributeMode mode,
 in ExceptionDefSeq get_exceptions,

```

```

 in ExceptionDefSeq set_exceptions
);
};

interface ExtInterfaceDef : InterfaceDef,
 InterfaceAttrExtension {
};
};

```

#### 10.5.25.1 Read Interface

All operations and attributes inherited from **InterfaceDef** behave the same as for **InterfaceDef**. In particular, the **def\_kind** attribute has the value **dk\_Interface**, exactly as in **InterfaceDef**.

The inherited **describe\_ext\_interfaces** operation returns the **ExtFullInterfaceDescription** structure that contains information about attributes with exceptions, in addition to the information found in **FullInterfaceDescription**.

#### 10.5.25.2 Write Interface

All operations and attributes inherited from **InterfaceDef** behave the same as for **InterfaceDef**.

The inherited **create\_ext\_attribute** operation returns a new **ExtAttributeDef** contained in the **ExtInterfaceDef** on which it is invoked. The **id**, **name**, **version**, **type\_def**, **mode**, **get\_exceptions** and **set\_exceptions** attributes are set as specified. The **type** attribute is also set. The **defined\_in** attribute is initialized to identify the containing **ExtInterfaceDef**. A **BAD\_PARAM** exception with standard minor code 2 is raised if an object with the specified **id** already exists in the **Repository**. **BAD\_PARAM** exception with standard minor code 3 is raised if an object with the same **name** already exists in this **ExtInterfaceDef**.

### 10.5.26 AbstractInterfaceDef

An **AbstractInterfaceDef** object represents a CORBA 2.3 abstract interface definition. It can contain constants, typedefs, exceptions, operations, and attributes. Its base interfaces can only contain **AbstractInterfaceDefs**.

```

module CORBA {
 interface AbstractInterfaceDef;
 typedef sequence <AbstractInterfaceDef> AbstractInterfaceDefSeq;

 interface AbstractInterfaceDef : InterfaceDef {
 };
};

```

### 10.5.26.1 *Read Interface*

The inherited **base\_interfaces** attribute returns a list of abstract interfaces from which this abstract interface inherits.

---

**Note** – **base\_interfaces** is of type **InterfaceDefSeq**, but since **AbstractInterfaceDef** is derived from **InterfaceDef**, a list of **AbstractInterfaceDefs** can legitimately be returned in an **InterfaceDefSeq**.

---

The inherited **is\_a** operation returns **TRUE** if the interface on which it is invoked either is identical to or inherits, directly or indirectly, from the abstract interface identified by its **interface\_id** parameter, or if the value of **interface\_id** is **IDL:omg.org/CORBA/AbstractBase:1.0**. Otherwise it returns **FALSE**.

The inherited **describe\_interface** operation returns a **FullInterfaceDescription** describing the abstract interface, including its operations and attributes.

The inherited **describe** operation for an **AbstractInterfaceDef** returns an **InterfaceDescription**.

The inherited **contents** operation returns the list of constants, typedefs, and exceptions defined in this **AbstractInterfaceDef** and the list of attributes and operations either defined or inherited in this **AbstractInterfaceDef**. If the **exclude\_inherited** parameter is set to **TRUE**, only attributes and operations defined within this abstract interface are returned. If the **exclude\_inherited** parameter is set to **FALSE**, all attributes and operations are returned.

### 10.5.26.2 *Write Interface*

Setting the inherited **base\_interfaces** attribute causes a **BAD\_PARAM** exception with standard minor code 5 to be raised if the name attribute of any object contained by this **AbstractInterfaceDef** conflicts with the name attribute of any object contained by any of the specified base **AbstractInterfaceDefs**. If any of the **InterfaceDefs** in **base\_interface** are not **AbstractInterfaceDefs** then a **BAD\_PARAM** exception with standard minor code 11 is raised.

The inherited **create\_attribute** operation returns a new **AttributeDef** contained in the **AbstractInterfaceDef** on which it is invoked. The **id**, **name**, **version**, **type\_def**, and **mode** attributes are set as specified. The **type** attribute is also set. The **defined\_in** attribute is initialized to identify the containing **AbstractInterfaceDef**. A **BAD\_PARAM** exception with standard minor code 2 is raised if an object with the specified **id** already exists in the **Repository**. **BAD\_PARAM** exception with standard minor code 3 is raised if an object with the same **name** already exists in this **AbstractInterfaceDef**.

The inherited **create\_operation** operation returns a new **OperationDef** contained in the **AbstractInterfaceDef** on which it is invoked. The **id**, **name**, **version**, **result\_def**, **mode**, **params**, **exceptions**, and **contexts** attributes are set as specified. The **result** attribute is also set. The **defined\_in** attribute is initialized to identify the containing **AbstractInterfaceDef**. A **BAD\_PARAM** exception with



standard minor code 2 is raised if an object with the specified **id** already exists in the **Repository**. **BAD\_PARAM** exception with standard minor code 3 is raised if an object with the same **name** already exists in this **AbstractInterfaceDef**.

### 10.5.27 *ExtAbstractInterfaceDef*

An **ExtAbstractInterfaceDef** object represents an abstract interface definition. It can contain constants, typedefs, exceptions, operations, and attributes with exceptions. Its base interfaces can only contain **ExtAbstractInterfaceDefs**.

```
module CORBA {
 interface ExtAbstractInterfaceDef : AbstractInterfaceDef,
 InterfaceAttrExtension {
 };
};
```

#### 10.5.27.1 *Read Interface*

All operations and attributes inherited from **AbstractInterfaceDef** behave the same as for **AbstractInterfaceDef**. In particular, the **def\_kind** attribute has the value **dk\_AbstractInterface**, exactly as in **AbstractInterfaceDef**.

The inherited **describe\_ext\_interface** operation returns the **ExtFullInterfaceDescription** structure which contains information about attributes with exceptions, in addition to the information found in **FullInterfaceDescription**.

#### 10.5.27.2 *Write Interface*

All operations and attributes inherited from **AbstractInterfaceDef** behave the same as for **AbstractInterfaceDef**.

The inherited **create\_ext\_attribute** operation returns a new **ExtAttributeDef** contained in the **ExtAbstractInterfaceDef** on which it is invoked. The **id**, **name**, **version**, **type\_def**, **mode**, **get\_exceptions** and **set\_exceptions** attributes are set as specified. The **type** attribute is also set. The **defined\_in** attribute is initialized to identify the containing **ExtAbstractInterfaceDef**. A **BAD\_PARAM** exception with standard minor code 2 is raised if an object with the specified **id** already exists in the **Repository**. **BAD\_PARAM** exception with standard minor code 3 is raised if an object with the same **name** already exists in this **ExtAbstractInterfaceDef**.

### 10.5.28 *LocalInterfaceDef*

An **LocalInterfaceDef** object represents a local interface definition. It can contain constants, typedefs, exceptions, operations, and attributes. Its base interfaces can only contain **InterfaceDefs** or **LocalInterfaceDefs**.

```
module CORBA {
 interface LocalInterfaceDef;
```

```

typedef sequence <LocalInterfaceDef> LocalInterfaceDefSeq;

interface LocalInterfaceDef : InterfaceDef {
};
};

```

### 10.5.28.1 *Read Interface*

The inherited **base\_interfaces** attribute returns a list of interfaces, local or otherwise, from which this local interface inherits.

---

**Note** – **base\_interfaces** is of type **InterfaceDefSeq**, but since **LocalInterfaceDef** is derived from **InterfaceDef**, a list that consists of some regular **InterfaceDefs** and some **LocalInterfaceDefs** can legitimately be returned in an **InterfaceDefSeq**.

---

The inherited **is\_a** operation returns **TRUE** if the local interface on which it is invoked either is identical to or inherits, directly or indirectly, from the local interface identified by its **interface\_id** parameter, or if the value of **interface\_id** is **IDL:omg.org/CORBA/LocalBase:1.0**. Otherwise it returns **FALSE**.

The inherited **describe\_interface** operation returns a **FullInterfaceDescription** describing the local interface, including its operations and attributes.

The inherited **describe** operation for a **LocalInterfaceDef** returns an **InterfaceDescription**.

The inherited **contents** operation returns the list of constants, typedefs, and exceptions defined in this **LocalInterfaceDef** and the list of attributes and operations either defined or inherited in this **LocalInterfaceDef**. If the **exclude\_inherited** parameter is set to **TRUE**, only attributes and operations defined within this local interface are returned. If the **exclude\_inherited** parameter is set to **FALSE**, all attributes and operations are returned.

### 10.5.28.2 *Write Interface*

Setting the inherited **base\_interfaces** attribute causes a **BAD\_PARAM** exception with standard minor code 5 to be raised if the name attribute of any object contained by this **LocalInterfaceDef** conflicts with the name attribute of any object contained by any of the specified base **InterfaceDefs** (local or otherwise).

The inherited **create\_attribute** operation returns a new **AttributeDef** contained in the **LocalInterfaceDef** on which it is invoked. The **id**, **name**, **version**, **type\_def**, and **mode** attributes are set as specified. The **type** attribute is also set. The **defined\_in** attribute is initialized to identify the containing **LocalInterfaceDef**. A **BAD\_PARAM** exception with standard minor code 2 is raised if an object with the specified **id** already exists in the **Repository**. **BAD\_PARAM** exception with standard minor code 3 is raised if an object with the same **name** already exists in this **LocalInterfaceDef**.

The inherited **create\_operation** operation returns a new **OperationDef** contained in the **LocalInterfaceDef** on which it is invoked. The **id**, **name**, **version**, **result\_def**, **mode**, **params**, **exceptions**, and **contexts** attributes are set as specified. The **result** attribute is also set. The **defined\_in** attribute is initialized to identify the containing **LocalInterfaceDef**. A **BAD\_PARAM** exception with standard minor code 2 is raised if an object with the specified **id** already exists in the **Repository**. **BAD\_PARAM** exception with standard minor code 3 is raised if an object with the same **name** already exists in this **LocalInterfaceDef**.

### 10.5.29 *ExtLocalInterfaceDef*

An **ExtLocalInterfaceDef** object represents a local interface definition. It can contain constants, typedefs, exceptions, operations, and attributes with exceptions. Its base interfaces can only contain **ExtInterfaceDefs** or **ExtLocalInterfaceDefs**.

```

module CORBA {

 interface ExtLocalInterfaceDef : LocalInterfaceDef,
 InterfaceAttrExtension {

 };
};

```

#### 10.5.29.1 *Read Interface*

All operations and attributes inherited from **LocalInterfaceDef** behave the same as for **LocalInterfaceDef**. In particular, the **def\_kind** attribute has the value **dk\_LocalInterface**, exactly as in **LocalInterfaceDef**.

The inherited **describe\_ext\_interface** operation returns the **ExtFullInterfaceDescription** structure that contains information about attributes with exceptions, in addition to the information found in **FullInterfaceDescription**.

#### 10.5.29.2 *Write Interface*

All operations and attributes inherited from **LocalInterfaceDef** behave the same as for **LocalInterfaceDef**.

The inherited **create\_ext\_attribute** operation returns a new **ExtAttributeDef** contained in the **ExtLocalInterfaceDef** on which it is invoked. The **id**, **name**, **version**, **type\_def**, **mode**, **get\_exceptions** and **set\_exceptions** attributes are set as specified. The **type** attribute is also set. The **defined\_in** attribute is initialized to identify the containing **ExtLocalInterfaceDef**. A **BAD\_PARAM** exception with standard minor code 2 is raised if an object with the specified **id** already exists in the **Repository**. **BAD\_PARAM** exception with standard minor code 3 is raised if an object with the same **name** already exists in this **ExtLocalInterfaceDef**.

### 10.5.30 *ValueMemberDef*

A **ValueMemberDef** IR Object represents a value member.

```

module CORBA {
 typedef short Visibility;
 const Visibility PRIVATE_MEMBER = 0;
 const Visibility PUBLIC_MEMBER = 1;

 struct ValueMember {
 Identifier name;
 RepositoryId id;
 RepositoryId defined_in;
 VersionSpec version;
 TypeCode type;
 IDLType type_def;
 Visibility access;
 };

 typedef sequence <ValueMember> ValueMemberSeq;

 interface ValueMemberDef : Contained {
 readonly attribute TypeCode type;
 attribute IDLType type_def;
 attribute Visibility access;
 };
};

```

### 10.5.30.1 Read Interface

The **type** attribute provides the **TypeCode** describing the type of this value member. The **type\_def** attribute identifies the object defining the type of this value member. The **access** attribute specifies private or public access for this value member. The describe operation for a **ValueMemberDef** object returns a **ValueMember**.

### 10.5.30.2 Write Interface

Setting the **type\_def** attribute also updates the **type** attribute.

## 10.5.31 ValueDef

A **ValueDef** object represents a value definition. It can contain constants, typedefs, exceptions, operations, and attributes.

```

module CORBA {
 interface ValueDef;
 typedef sequence <ValueDef> ValueDefSeq;

 struct Initializer {
 StructMemberSeq members;
 Identifier name;
 };
};

```

```

typedef sequence<Initializer> InitializerSeq;

interface ValueDef : Container, Contained, IDLType {
 // read/write interface

 attribute InterfaceDefSeq supported_interfaces;
 attribute InitializerSeq initializers;
 attribute ValueDef base_value;
 attribute ValueDefSeq abstract_base_values;
 attribute boolean is_abstract;
 attribute boolean is_custom;
 attribute boolean is_truncatable;

 // read interface
 boolean is_a(
 in RepositoryId id
);

 struct FullValueDescription {
 Identifier name;
 RepositoryId id;
 boolean is_abstract;
 boolean is_custom;
 RepositoryId defined_in;
 VersionSpec version;
 OpDescriptionSeq operations;
 AttrDescriptionSeq attributes;
 ValueMemberSeq members;
 InitializerSeq initializers;
 RepositoryIdSeq supported_interfaces;
 RepositoryIdSeq abstract_base_values;
 boolean is_truncatable;
 RepositoryId base_value;
 TypeCode type;
 };

 FullValueDescription describe_value();

 // write interface

 ValueMemberDef create_value_member(
 in RepositoryId id,
 in Identifier name,
 in VersionSpec version,
 in IDLType type,
 in Visibility access
);

 AttributeDef create_attribute(
 in RepositoryId id,
 in Identifier name,

```

```

 in VersionSpec version,
 in IDLType type,
 in AttributeMode mode
);

 OperationDef create_operation (
 in RepositoryId id,
 in Identifier name,
 in VersionSpec version,
 in IDLType result,
 in OperationMode mode,
 in ParDescriptionSeq params,
 in ExceptionDefSeq exceptions,
 in ContextIdSeq contexts
);
};

struct ValueDescription {
 Identifier name;
 RepositoryId id;
 boolean is_abstract;
 boolean is_custom;
 RepositoryId defined_in;
 VersionSpec version;
 RepositoryIdSeq supported_interfaces;
 RepositoryIdSeq abstract_base_values;
 boolean is_truncatable;
 RepositoryId base_value;
};
};

```

### 10.5.31.1 Read Interface

The **supported\_interfaces** attribute lists the interfaces that this value type supports.

The **initializers** attribute lists the initializers this value type supports.

The **base\_value** attribute describes the value type from which this value inherits.

The **abstract\_base\_values** attribute lists the abstract value types from which this value inherits.

The **is\_abstract** attribute is **TRUE** if the value is an abstract value type.

The **is\_custom** attribute is **TRUE** if the value uses custom marshaling.

The **is\_truncatable** attribute is **TRUE** if the value inherits “safely” (i.e., supports truncation) from another value.

The **is\_a** operation returns **TRUE** if the value on which it is invoked either is identical to or inherits, directly or indirectly, from the interface or value identified by its **id** parameter or if the value of **id** is **IDL:omg.org/CORBA/ValueBase:1.0**. Otherwise it returns **FALSE**.

The **describe\_value** operation returns a **FullValueDescription** describing the value, including its operations and attributes.

The inherited **describe** operation for an **ValueDef** returns an **ValueDescription**.

The inherited **contents** operation returns the list of constants, typedefs, and exceptions defined in this **ValueDef** and the list of attributes, operations and members either defined or inherited in this **ValueDef**. If the **exclude\_inherited** parameter is set to **TRUE**, only attributes, operations and members defined within this value are returned. If the **exclude\_inherited** parameter is set to **FALSE**, all attributes, operations and members are returned.

### 10.5.31.2 Write Interface

Setting the **supported\_interfaces**, **base\_value**, or **abstract\_base\_values** attribute causes a **BAD\_PARAM** exception with minor code 5 to be raised if the **name** attribute of any object contained by this **ValueDef** conflicts with the **name** attribute of any object contained by any of the specified bases. If an attempt is made to set the **supported\_interfaces** attribute to an **InterfaceDefSeq** that contains more than one **InterfaceDef** that is not an **AbstractInterfaceDef**, then the **BAD\_PARAM** exception shall be raised with standard minor code 12.

The **create\_value\_member** operation returns a new **ValueMemberDef** contained in the **ValueDef** on which it is invoked. The **id**, **name**, **version**, **type\_def**, and **access** attributes are set as specified. The **type** attribute is also set. The **defined\_in** attribute is initialized to identify the containing **ValueDef**. A **BAD\_PARAM** exception with minor code 2 is raised if an object with the specified **id** already exists in the **Repository**. A **BAD\_PARAM** exception with minor code 3 is raised if an object with the same **name** already exists in this **ValueDef**.

The **create\_attribute** operation returns a new **AttributeDef** contained in the **ValueDef** on which it is invoked. The **id**, **name**, **version**, **type\_def**, and **mode** attributes are set as specified. The **type** attribute is also set. The **defined\_in** attribute is initialized to identify the containing **ValueDef**. A **BAD\_PARAM** exception with minor code 2 is raised if an object with the specified **id** already exists in the **Repository**. A **BAD\_PARAM** exception with minor code 3 is raised if an object with the same **name** already exists in this **ValueDef**.

The **create\_operation** operation returns a new **OperationDef** contained in the **ValueDef** on which it is invoked. The **id**, **name**, **version**, **result\_def**, **mode**, **params**, **exceptions**, and **contexts** attributes are set as specified. The **result** attribute is also set. The **defined\_in** attribute is initialized to identify the containing **ValueDef**. A **BAD\_PARAM** exception with minor code 2 is raised if an object with the specified **id** already exists in the **Repository**. A **BAD\_PARAM** exception with minor code 3 is raised if an object with the same **name** already exists in this **ValueDef**.

A **ValueDef** used as a **Container** may only contain **TypedefDef**, (including definitions derived from **TypedefDef**), **ConstantDef**, and **ExceptionDef** definitions.

### 10.5.32 ExtValueDef

An **ExtValueDef** object represents a value definition. It can contain constants, typedefs, exceptions, operations, and attributes with exceptions. Value definitions that contain initializers with user exceptions can also be represented in **ExtValueDef** objects.

```

module CORBA {

 struct ExtInitializer {
 StructMemberSeq members;
 ExcDescriptionSeq exceptions;
 Identifier name;
 };
 typedef sequence <ExtInitializer> ExtInitializerSeq;

 interface ExtValueDef : ValueDef {

 // read/write interface
 attribute ExtInitializerSeq ext_initializers;

 // read interface

 struct ExtFullValueDescription {
 Identifier name;
 RepositoryId id;
 boolean is_abstract;
 boolean is_custom;
 RepositoryId defined_in;
 VersionSpec version;
 OpDescriptionSeq operations;
 ExtAttrDescriptionSeq attributes;
 ValueMemberSeq members;
 ExtInitializerSeq initializers;
 RepositoryIdSeq supported_interfaces;
 RepositoryIdSeq abstract_base_values;
 boolean is_truncatable;
 RepositoryId base_value;
 TypeCode type;
 };

 ExtFullValueDescription describe_ext_value();

 // write interface
 ExtAttributeDef create_ext_attribute (
 in RepositoryId id,
 in Identifier name,

```



```

 in VersionSpec version,
 in IDLType type,
 in AttributeMode mode,
 in ExceptionDefSeq get_exceptions,
 in ExceptionDefSeq set_exceptions
);
};
};

```

### 10.5.32.1 Read Interface

All operations and attributes inherited from **ValueDef** behave the same as for **ValueDef**. In particular, the **def\_kind** attribute has the value **dk\_Value**, exactly as in **ValueDef**.

The **ext\_initializers** attribute lists the initializers with exceptions that this value type supports.

The inherited **initializers** attribute list the same initializers as in **ext\_initializers** but does not have the exception information.

The **describe\_ext\_value** operation returns the **ExtFullValueDescription** structure which contains information about attributes with exceptions and initializers with exceptions, in addition to the information found in **FullValueDescription**.

### 10.5.32.2 Write Interface

All operations and attributes inherited from **ValueDef** behave the same as for **ValueDef**.

The **create\_ext\_attribute** operation returns a new **ExtAttributeDef** contained in the **ExtValueDef** on which it is invoked. The **id**, **name**, **version**, **type\_def**, **mode**, **get\_exceptions** and **set\_exceptions** attributes are set as specified. The **type** attribute is also set. The **defined\_in** attribute is initialized to identify the containing **ExtValueDef**. A **BAD\_PARAM** exception with standard minor code 2 is raised if an object with the specified **id** already exists in the **Repository**. **BAD\_PARAM** exception with standard minor code 3 is raised if an object with the same **name** already exists in this **ExtValueDef**.

## 10.5.33 ValueBoxDef

A **ValueBoxDef** object represents a value box definition. It merely identifies the IDL **type\_def** that is being “boxed.”

```

module CORBA {
 interface ValueBoxDef : TypedefDef {
 attribute IDLType original_type_def;
 };
};

```

### 10.5.33.1 Read Interface

The **original\_type\_def** attribute identifies the type being boxed. The inherited **type** attribute is a **tk\_value\_box TypeCode** describing the value box.

### 10.5.33.2 Write Interface

Setting the **original\_type\_def** attribute also updates the **type** attribute.

### 10.5.34 NativeDef

A **NativeDef** object represents a native definition.

```
module CORBA {
 interface NativeDef : TypedefDef {};
};
```

The inherited **type** attribute is a **tk\_native TypeCode** describing the native type.

## 10.6 Component Interface Repository Interfaces

The **IObjects** that represent IDL concepts that are specific to the Components extension are described in this section. These IObjects can be contained only in a **ComponentIR::Repository** described in this section.

### 10.6.1 ComponentIR::Container

The *base interface* **ComponentIR::Container** is used to form a containment hierarchy in the Component Interface Repository.

```
module CORBA {
 module ComponentIR {

 interface Container {
 ComponentDef create_component (
 in RepositoryId id,
 in Identifier name,
 in VersionSpec version,
 in ComponentDef base_component,
 in InterfaceDefSeq supports_interfaces
);

 HomeDef create_home (
 in RepositoryId id,
 in Identifier name,
 in VersionSpec version,
 in HomeDef base_home,
 in ComponentDef managed_component,
 in InterfaceDefSeq supports_interfaces,

```

```

 in ValueDef primary_key
);

 EventDef create_event (
 in RepositoryId id,
 in Identifier name,
 in VersionSpec version,
 in boolean is_custom,
 in boolean is_abstract,
 in ValueDef base_value,
 in boolean is_truncatable,
 in ValueDefSeq abstract_base_values,
 in InterfaceDefSeq supported_interfaces,
 in ExtInitializerSeq initializers
);
};
};
};

```

### 10.6.1.1 Write Interface

The three **create\_<type>** operations defined in the **ComponentIR::Container** interface create new empty IR objects defining component, home, and event types. The **defined\_in** attribute of a definition created with any of these operations is initialized to identify the **ComponentIR::Container** on which the operation is invoked, and the **containing\_repository** attribute is initialized to its **ComponentIR::Repository**.

These **create\_<type>** operations all take **id** and **name** parameters that are used to initialize the identity of the created definition.

- A **BAD\_PARAM** exception is raised with minor code 2 if an object with the specified **id** already exists in the **ComponentIR::Repository**.
- A **BAD\_PARAM** exception with minor code 3 is raised if the specified **name** already exists within this **ComponentIR::Container** and multiple versions are not supported.

The **create\_component** operation returns a new empty **ComponentDef** with the specified **base\_component**, and the specified **supports\_interfaces**. **AttributeDefs** can be added using **ComponentDef::create\_attribute**. **ComponentDef::create\_provides**, **ComponentDef::create\_uses**, **ComponentDef::create\_emits**, **ComponentDef::create\_publishes**, and **ComponentDef::create\_consumes** can be used to add **ProvidesDefs**, **UsesDefs**, **EmitsDefs**, **PublishesDefs** and **ConsumesDefs** respectively. Definitions can also be added using the **Contained::move** operation.

The **create\_home** operation returns a new **HomeDef** with the specified **base\_home**, **managed\_component**, **supported\_interfaces**, and **primary\_key**. Type, exception, and constant definitions can be added using **Container::create\_<type>** operations on the new **HomeDefs**. **OperationDefs** can be added using **HomeDef::create\_operation** and **AttributeDefs** can be added using

**HomeDef::create\_attribute**, **FinderDefs** and **FactoryDefs** can be added using **HomeDef::create\_finder** and **HomeDef::create\_factory** respectively. Definitions can also be added using the **Contained::move** operation.

The **create\_event** operation returns a new empty **EventDef** with the specified base interfaces and events (**base\_value**, **supported\_interfaces**, and **abstract\_base\_values**) as well as the other information describing the new events characteristics (**is\_custom**, **is\_abstract**, **is\_truncatable**, and **initializers**). The **initializers** argument is of type **ExtInitializerSeq** allowing one to specify user exceptions for initializers. Type, exception, and constant definitions can be added using **Container::create\_<type>** operations on the new **EventDef**. **OperationDefs** can be added using **ExtValueDef::create\_operation** and **ExtAttributeDefs** can be added using **ExtValueDef::create\_ext\_attribute**. Definitions can also be added using the **Contained::move** operation.

## 10.6.2 *ComponentIR::Repository*

**ComponentIR::Repository** is an interface that provides global access to the Interface Repository that supports access to information related to CORBA Components. The **ComponentIR::Repository** object can contain components, home, and event definitions in addition to everything else that a **Repository** type can contain. As it inherits from **Container** and **ComponentIR::Container**, it can be used to look up any definition (whether globally defined or defined within a module or interface) either by name or by id.

Since **ComponentIR::Repository** derives from **CORBA::Repository** and hence from **Container** and not from **Contained**, it does not have a **RepositoryId** associated with it. By default it is deemed to have the **RepositoryId** "" (the empty string) for purposes of assigning a value to the **defined\_in** field of the description structure of **ModuleDef**, **InterfaceDef**, **ValueDef**, **ValueBoxDef**, **ComponentDef**, **HomeDef**, **EventDef**, **TypedefDef**, **ExceptionDef**, and **ConstantDef** that are contained immediately in the **ComponentIR::Repository** object. Since **ComponentIR::Repository** derives from **ComponentIR::Container**, it can contain **ComponentDefs**, **HomeDefs** as well as **EventDefs**.

```
module CORBA {
 module ComponentIR {

 interface Repository : CORBA::Repository, Container {};
 };
};
```

### 10.6.2.1 *Read Interface*

**ComponentIR::Repository** has the same read operations as **Repository**.

### 10.6.2.2 Write Interface

Write operations inherited from **ComponentIR::Container** behave the same way as in **ComponentIR::Container**.

The rest of the write operations are inherited from **CORBA::Repository** and behave the same way as in **CORBA::Repository**.

### 10.6.3 ComponentIR::ProvidesDef

A **ComponentIR::ProvidesDef** object represents an interface that is provided by a component.

```

module CORBA {
 module ComponentIR {

 interface ProvidesDef : Contained {
 attribute InterfaceDef interface_type;
 };

 struct ProvidesDescription {
 Identifier name;
 RepositoryId id;
 RepositoryId defined_in;
 VersionSpec version;
 RepositoryId interface_type;
 };
 };
};

```

#### 10.6.3.1 Read Interface

The attribute **interface\_type** returns the object identifying the interface that is provided by the component.

The inherited operation **describe** returns a **ProvidesDescription**.

#### 10.6.3.2 Write Interface

Setting the attribute **interface\_type** changes the object identifying the interface that is provided by the component.

The rest of the write operations are inherited from **CORBA::Contained** and behave the same way as in **CORBA::Contained**.

### 10.6.4 ComponentIR::UsesDef

A **ComponentIR::UsesDef** object represents an interface that is used by a component.

```

module CORBA {
 module ComponentIR {

 interface UsesDef : Contained {
 attribute InterfaceDef interface_type;
 attribute boolean is_multiple;
 };

 struct UsesDescription {
 Identifier name;
 RepositoryId id;
 RepositoryId defined_in;
 VersionSpec version;
 RepositoryId interface_type;
 boolean is_multiple;
 };
 };
};

```

#### 10.6.4.1 Read Interface

The attribute **interface\_type** returns the object identifying the interface that is used by the component.

The attribute **is\_multiple** is **TRUE** if the interface is used multiple times.

The inherited operation **describe** returns a **UsesDescription**.

#### 10.6.4.2 Write Interface

Setting the attribute **interface\_type** changes the object identifying the interface that is used by the component. Setting the attribute **is\_multiple** changes the multiplicity of the used interface.

The rest of the write operations are inherited from **CORBA::Contained** and behave the same way as in **CORBA::Contained**.

### 10.6.5 ComponentIR::EventDef

A **ComponentIR::EventDef** object represents an eventtype definition. It can contain constants, typedefs, exceptions, operations, and attributes with exceptions. Eventtype definitions that contain initializers with user exceptions can also be represented in **ComponentIR::EventDef** objects.

```

module CORBA {
 module ComponentIR {

 interface EventDef : ExtValueDef {};
 };
};

```

The read and write interfaces for **ComponentIR::EventDef** have the same semantics as the read and write interfaces for **ExtValueDef**.

### 10.6.6 *ComponentIR::EventPortDef*

A **ComponentIR::EventPortDef** object represents an event port definition. It refers to an **EventDef** object which contains the actual information about the event. This interface is never instantiated as itself. It is instantiated only as one of its derived types (i.e., **EmitsDef**, **PublishesDef**, or **ConsumesDef**).

```

module CORBA {
 module ComponentIR {

 interface EventPortDef : Contained {

 // read/write interface
 attribute EventDef event;

 // read interface
 boolean is_a (in RepositoryId event_id);
 };

 struct EventPortDescription {
 Identifier name;
 RepositoryId id;
 RepositoryId defined_in;
 VersionSpec version;
 RepositoryId event;
 };
 };
};

```

#### 10.6.6.1 *Read Interface*

The **event** attribute returns the object containing the definition of the event for this event port.

The **is\_a** operation returns **TRUE** if the event value associated with this **EventPortDef** is identical to or inherits from the event value associated with the **EventPortDef** identified by the **event\_id**.

The inherited **describe** operation returns an **EventPortDescription**.

#### 10.6.6.2 *Write Interface*

Setting the attribute **event** changes the object containing the definition of the event for this event port.

The rest of the write operations are inherited from **CORBA::Contained** and behave the same way as in **CORBA::Contained**.

### 10.6.7 *ComponentIR::EmitsDef*

A **ComponentIR::EmitsDef** object represents the port definition of an event that is emitted by a component.

```
module CORBA {
 module ComponentIR {

 interface EmitsDef : EventPortDef {};
 };
};
```

#### 10.6.7.1 *Read Interface*

The read interface for **EmitsDef** has the same semantics as the read interface for **EventPortDef**.

#### 10.6.7.2 *Write Interface*

The write interface for **EmitsDef** has the same semantics as the write interface for **EventPortDef**.

### 10.6.8 *ComponentIR::PublishesDef*

A **ComponentIR::PublishesDef** object represents the port definition of an event that is published by a component.

```
module CORBA {
 module ComponentIR {

 interface PublishesDef : EventPortDef {};
 };
};
```

#### 10.6.8.1 *Read Interface*

The read interface for **PublishesDef** has the same semantics as the read interface for **EventPortDef**.

#### 10.6.8.2 *Write Interface*

The write interface for **PublishesDef** has the same semantics as the write interface for **EventPortDef**.



### 10.6.9 *ComponentIR::ConsumesDef*

A **ComponentIR::ConsumesDef** object represents the port definition of an event that is consumed by a component.

```

module CORBA {
 module ComponentIR {

 interface ConsumesDef : EventPortDef {};
 };
};

```

#### 10.6.9.1 *Read Interface*

The read interface for **ConsumesDef** has the same semantics as the read interface for **EventPortDef**.

#### 10.6.9.2 *Write Interface*

The write interface for **ConsumesDef** has the same semantics as the write interface for **EventPortDef**.

### 10.6.10 *ComponentIR::ComponentDef*

A **ComponentIR::ComponentDef** object represents the definition of a component. It contains provides, uses, emits, publishes, consumes, and attributes.

```

module CORBA {
 module ComponentIR {

 interface ComponentDef : ExtInterfaceDef {
 // read/write interface
 attribute ComponentDef base_component;
 attribute InterfaceDefSeq supported_interfaces;

 // write interface
 ProvidesDef create_provides (
 in RepositoryId id,
 in Identifier name,
 in VersionSpec version,
 in InterfaceDef interface_type
);

 UsesDef create_uses (
 in RepositoryId id,
 in Identifier name,
 in VersionSpec version,
 in InterfaceDef interface_type,

```

```
 in boolean is_multiple
);

 EmitsDef create_emits (
 in RepositoryId id,
 in Identifier name,
 in VersionSpec version,
 in EventDef event
);

 PublishesDef create_publishes (
 in RepositoryId id,
 in Identifier name,
 in VersionSpec version,
 in EventDef event
);

 ConsumesDef create_consumes (
 in RepositoryId id,
 in Identifier name,
 in VersionSpec version,
 in EventDef event
);
};

typedef sequence<ProvidesDescription>
 ProvidesDescriptionSeq;
typedef sequence<UsesDescription> UsesDescriptionSeq;
typedef sequence<EventPortDescription>
 EventPortDescriptionSeq;

struct ComponentDescription {
 Identifier name;
 RepositoryId id;
 RepositoryId defined_in;
 VersionSpec version;
 RepositoryId base_component;
 RepositoryIdSeq supported_interfaces;
 ProvidesDescriptionSeq provided_interfaces;
 UsesDescriptionSeq used_interfaces;
 EventPortDescriptionSeq emits_events;
 EventPortDescriptionSeq publishes_events;
 EventPortDescriptionSeq consumes_events;
 ExtAttrDescriptionSeq attributes;
 TypeCode type;
};
};
};
```

### 10.6.10.1 Read Interface

The **base\_component** attribute returns the component that this component derives from.

The **supported\_interfaces** attribute lists the interfaces which this component type supports.

The inherited **is\_a** operation returns **TRUE** if the component on which it is invoked either is identical to or inherits from the component identified by its **id** parameter. Otherwise it returns **FALSE**.

The inherited **describe** operation for a **ComponentDef** returns a **ComponentDescription**.

The inherited **contents** operation returns the list of attributes, provides, uses, emits, publishes, and consumes either defined or inherited in this **ComponentDef**. If the **exclude\_inherited** parameter is set to **TRUE**, only attributes, provides, uses, emits, publishes, and consumes defined within this object are returned. If the **exclude\_inherited** parameter is set to **FALSE**, all attributes, provides, uses, emits, publishes, and consumes are returned.

### 10.6.10.2 Write Interface

Setting the **base\_component** attribute causes a **BAD\_PARAM** exception with minor code 5 to be raised if the **name** attribute of any object contained by this **ComponentDef** conflicts with the **name** attribute of any object contained by the specified base **ComponentDef**.

Setting the **supported\_interfaces** attribute changes the interfaces which this component type supports.

The **create\_<type>** operations defined in the **ComponentIR::ComponentDef** interface create new corresponding empty IR objects. The **defined\_in** attribute is initialized to identify the containing **ComponentDef**, and the **containing\_repository** attribute is initialized to its **ComponentIR::Repository**.

These **create\_<type>** operations all take **id** and **name** parameters that are used to initialize the identity of the created definition. A **BAD\_PARAM** exception is raised with minor code 2 if an object with the specified **id** already exists in the **ComponentIR::Repository**. A **BAD\_PARAM** exception with minor code 3 is raised if the specified **name** already exists within this **ComponentDef** and multiple versions are not supported.

The inherited **create\_ext\_attribute** operation returns a new **ExtAttributeDef** contained in the **ComponentDef** on which it is invoked. The **id**, **name**, **version**, **type\_def**, **mode**, **get\_exceptions** and **set\_exceptions** attributes are set as specified. The **type** attribute is also set.

The inherited **create\_operation**, and all other **create\_\*** operations inherited from **Container** and **Contained** return **BAD\_PARAM** exception with minor code 4.

The **create\_provides** operation returns a new **ProvidesDef** contained in the **ComponentDef** on which it is invoked. The **id**, **name**, **version** and **interface\_type** attributes are set as specified.

The **create\_uses** operation returns a new **UsesDef** contained in the **ComponentDef** on which it is invoked. The **id**, **name**, **version**, **interface\_type** and **is\_multiple** attributes are set as specified.

The **create\_emits**, **create\_publishes** and **create\_consumes** operations respectively return new **EmitsDef**, **PublishesDef** and **ConsumesDef** contained in the **ComponentDef** on which it is invoked. The **id**, **name**, **version**, and **event** attributes are set as specified.

A **ComponentDef** used as a **Container** may not contain any **TypedefDef** (including definitions derived from **TypedefDef**), **ConstantDef**, or **ExceptionDef** definitions.

A **ComponentDef** used as an **InterfaceDef** may only contain **ExtAttributeDef** definitions.

### 10.6.11 *ComponentIR::FactoryDef*

A **ComponentIR::FactoryDef** object represents the definition of a factory operation in a home.

```

module CORBA {
 module ComponentIR {

 interface FactoryDef : OperationDef { // only PARAM_IN parameters
 };
 };
};

```

#### 10.6.11.1 *Read Interface*

The **result** attribute is a **TypeCode** describing the type of the value returned by the operation, which is always **tk\_component** for **FactoryDef**. The **result\_def** attribute identifies the definition of the returned type, which is always a **ComponentDef** in case of **FactoryDef**.

The **params** attribute describes the parameters of the operation. It is a sequence of **ParameterDescription** structures. The order of the **ParameterDescriptions** in the sequence is significant. The **name** member of each structure provides the parameter name. The **type** member is a **TypeCode** describing the type of the parameter. The **type\_def** member identifies the definition of the type of the parameter. The **mode** member indicates whether the parameter is an in, out, or inout parameter. For **FactoryDef** the value of mode for all parameters is **PARAM\_IN**.

The operation's **mode** is always **normal** for **FactoryDef**.

The **kind** attribute is always **OP\_IDL** for **FactoryDef**.

The **contexts** attribute specifies the list of context identifiers that apply to the operation, and is an empty list for **FactoryDef**.

The **exceptions** attribute specifies the list of exception types that can be raised by the operation.

The inherited **describe** operation for a **FactoryDef** object returns an **OperationDescription**.

### 10.6.11.2 Write Interface

Setting the **result\_def** attribute has no effect.

The **mode** and **contexts** attributes cannot be changed.

### 10.6.12 ComponentIR::FinderDef

A **ComponentIR::FinderDef** object represents the definition of a finder operation in a home.

```
module CORBA {
 module ComponentIR {

 interface FinderDef : OperationDef { // only PARAM_IN parameters
 };
 };
};
```

#### 10.6.12.1 Read Interface

The **result** attribute is a **TypeCode** describing the type of the value returned by the operation, which is always **tk\_component** for **FinderDef**. The **result\_def** attribute identifies the definition of the returned type, which is always a **ComponentDef** in case of a **FinderDef**.

The **params** attribute describes the parameters of the operation. It is a sequence of **ParameterDescription** structures. The order of the **ParameterDescriptions** in the sequence is significant. The **name** member of each structure provides the parameter name. The **type** member is a **TypeCode** describing the type of the parameter. The **type\_def** member identifies the definition of the type of the parameter. The **mode** member indicates whether the parameter is an in, out, or inout parameter. For **FinderDef** the value of mode for all parameters is **PARAM\_IN**.

The operation's **mode** is always **normal** for **FinderDef**.

The **kind** attribute is always **OP\_IDL** for **FinderDef**.

The **contexts** attribute specifies the list of context identifiers that apply to the operation, and is an empty list for **FinderDef**.

The **exceptions** attribute specifies the list of exception types that can be raised by the operation.

The inherited **describe** operation for an **FinderDef** object returns an **OperationDescription**.

#### 10.6.12.2 Write Interface

Setting the **result\_def** attribute has no effect.

The **mode** and **contexts** attributes cannot be changed.

#### 10.6.13 ComponentIR::HomeDef

A **ComponentIR::HomeDef** object represents the definition of a home. It contains attributes, operations, factories, and finders.

```
module CORBA {
 module ComponentIR {

 interface HomeDef : ExtInterfaceDef {

 // read/write interface
 attribute HomeDef base_home;
 attribute InterfaceDefSeq supported_interfaces;
 attribute ComponentDef managed_component;
 attribute ValueDef primary_key;

 // write interface
 FactoryDef create_factory (
 in RepositoryId id,
 in Identifier name,
 in VersionSpec version,
 in ParDescriptionSeq params,
 in ExceptionDefSeq exceptions
);

 FinderDef create_finder (
 in RepositoryId id,
 in Identifier name,
 in VersionSpec version,
 in ParDescriptionSeq params,
 in ExceptionDefSeq exceptions
);
 };

 struct HomeDescription {
 Identifier name;
 RepositoryId id;
 RepositoryId defined_in;
 };
 };
};
```

```

 VersionSpec version;
 RepositoryId base_home;
 RepositoryId managed_component;
 ValueDescription primary_key;
 OpDescriptionSeq factories;
 OpDescriptionSeq finders;
 OpDescriptionSeq operations;
 ExtAttrDescriptionSeq attributes;
 TypeCode type;
 };
};
};

```

### 10.6.13.1 Read Interface

The **base\_home** attribute returns the home that this home definition derives from.

The **supported\_interfaces** attribute lists the interfaces which this home type supports.

The **managed\_component** attribute returns the component that this home manages.

The **primary\_key** attribute returns the primary key that is associated with this home.

The inherited **is\_a** operation returns **TRUE** if the home on which it is invoked either is identical to or inherits from the home identified by its **id** parameter. Otherwise it returns **FALSE**.

The inherited **describe** operation for a **HomeDef** returns a **HomeDescription**.

The inherited **contents** operation returns the list of constants, typedefs, exceptions, attributes, operations, finders and factories defined or inherited in this **HomeDef**. If the **exclude\_inherited** parameter is set to **TRUE**, only objects defined within this home are returned. If the **exclude\_inherited** parameter is set to **FALSE**, all objects are returned.

### 10.6.13.2 Write Interface

Setting the **base\_home** attribute causes a **BAD\_PARAM** exception with minor code 5 to be raised if the **name** attribute of any object contained by this **HomeDef** conflicts with the **name** attribute of any object contained by the specified base **HomeDef**.

The **create\_<type>** operations defined in the **HomeDef** interface create new corresponding empty IR objects. The **defined\_in** attribute is initialized to identify the containing **HomeDef**, and the **containing\_repository** attribute is initialized to its **ComponentIR::Repository**.

These **create\_<type>** operations all take **id** and **name** parameters that are used to initialize the identity of the created definition. A **BAD\_PARAM** exception is raised with minor code 2 if an object with the specified **id** already exists in the

**ComponentIR::Repository.** A **BAD\_PARAM** exception with minor code 3 is raised if the specified **name** already exists within this **HomeDef** and multiple versions are not supported.

The inherited **create\_ext\_attribute** operation returns a new **ExtAttributeDef** contained in the **HomeDef** on which it is invoked. The **id**, **name**, **version**, **type\_def**, **mode**, **get\_exceptions**, and **set\_exceptions** attributes are set as specified. The **type** attribute is also set.

The inherited **create\_operation** operation returns a new **OperationDef** contained in the **HomeDef** on which it is invoked. The **id**, **name**, **version**, **result\_def**, **mode**, **params**, **exceptions**, and **contexts** attributes are set as specified. The **result** attribute is also set.

The **create\_factory** operation returns a new **FactoryDef** contained in the **HomeDef** on which it is invoked. The **id**, **name**, **version**, **params**, and **exceptions** attributes are set as specified. The parameters in the **params** attribute must all be of **PARAM\_IN** type.

The **create\_finder** operation returns a new **FinderDef** contained in the **HomeDef** on which it is invoked. The **id**, **name**, **versions**, **params**, and **exceptions** attributes are set as specified. The parameters in the **params** attribute must all be of **PARAM\_IN** type.

A **HomeDef** used as a **Container** may only contain **TypedefDef** (including definitions derived from **TypedefDef**), **ConstantDef**, and **ExceptionDef** definitions.

## 10.7 RepositoryIds

**RepositoryIds** are values that can be used to establish the identity of information in the repository. A **RepositoryId** is represented as a string, allowing programs to store, copy, and compare them without regard to the structure of the value. It does not matter what format is used for any particular **RepositoryId**. However, conventions are used to manage the name space created by these IDs.

**RepositoryIds** may be associated with OMG IDL definitions in a variety of ways. Installation tools might generate them, they might be defined with pragmas in OMG IDL source, or they might be supplied with the package to be installed. Ensuring consistency of **RepositoryIds** with the IDL source or the IR contents is the responsibility of the programmer allocating **Repositoryids**.

The format of the id is a short format name followed by a colon (":") followed by characters according to the format. This specification defines four formats:

1. one derived from OMG IDL names,
2. one that uses Java class names and Java serialization version UIDs,
3. one that uses DCE UUIDs, and
4. another intended for short-term use, such as in a development environment.



Since new repository ID formats may be added from time to time, compliant IDL compilers must accept any string value of the form

**“<format>:<string>”**

provided as the argument to the id pragma and use it as the repository ID. The OMG maintains a registry of allocated format identifiers. The **<format>** part of the ID may not contain a colon (:) character.

The version and prefix pragmas only affect default repository IDs that are generated by the IDL compiler using the IDL format.

### 10.7.1 *OMG IDL Format*

The OMG IDL format for **RepositoryIds** primarily uses OMG IDL scoped names to distinguish between definitions. It also includes an optional unique prefix, and major and minor version numbers.

The **RepositoryId** consists of three components, separated by colons, (“:”)

1. The first component is the format name, “IDL.”
2. The second component is a list of identifiers, separated by “/” characters. These identifiers are arbitrarily long sequences of alphabetic, digit, underscore (“\_”), hyphen (“-”), and period (“.”) characters. Typically, the first identifier is a unique prefix, and the rest are the OMG IDL Identifiers that make up the scoped name of the definition.
3. The third component is made up of major and minor version numbers, in decimal format, separated by a “.”. When two interfaces have **RepositoryIds** differing only in minor version number it can be assumed that the definition with the higher version number is upwardly compatible with (i.e., can be treated as derived from) the one with the lower minor version number.

### 10.7.2 *RMI Hashed Format*

The OMG IDL format defined above does not include any structural information. Identity of IDL types determined for this format depends upon the names used in the **RepositoryID** being correct. For interfaces, if stubs and skeletons are not actually in synch, even though the **RepositoryIds** report they are, the worst that can happen is that the result of an invocation is a **BAD\_OPERATION** exception. With value types, these kinds of errors are more problematic. An inconsistency between the stub and skeleton marshaling/unmarshaling code can confuse the marshaling engine and may even corrupt memory and/or cause a crash failure.

The RMI Hashed format is used for Java RMI values mapped to IDL using the Java to IDL Mapping (see the Java/IDL Language Mapping document). It is computed based upon the structural information of the original Java definition. Whenever the Java definition changes, the hash function will (statistically) produce a hash code, which is different from the previous one. When an ORB run time receives a **value** with a

different hash from what is expected, it is free to raise a **BAD\_PARAM** exception. It may also try to resolve the incompatibility by some means. If it is not successful, then it shall raise the **BAD\_PARAM** exception.

An RMI Hashed **RepositoryId** consists of either three or four components, separated by colons:

**RMI: <class name> : <hash code> [ : <serialization version UID> ]**

The class name is a Java class name as returned by the **getName** method of **java.lang.Class**. Any characters not in *ISO Latin 1* are replaced by “\U” followed by the 4 hexadecimal characters (in upper case) representing the *Unicode* value.

For classes that do not implement **java.io.Serializable**, and for interfaces, the hash code is always zero, and the **RepositoryID** does not contain a *serial version UID*.

For classes that implement **java.io.Externalizable**, the hash code is always the *64-bit value 1*.

For classes that implement **java.io.Serializable** but not **java.io.Externalizable**, the hash code is a *64-bit hash of a stream of bytes*. (transcribed as a 16-digit upper case hex string). An instance of **java.lang.DataOutputStream** is used to convert primitive data types to a sequence of bytes. The sequence of items in the stream is as follows:

1. The hash code of the superclass, written as a 64-bit long.
2. The value 1 if the class has no **writeObject** method, or the value 2 if the class has a **writeObject** method, written as a 32-bit integer.
3. For each field of the class that is mapped to IDL, sorted lexicographically by Java field name, in increasing order:
  - a. Java field name, in *UTF encoding*
  - b. field descriptor, as defined by the *Java Virtual Machine Specification*, in *UTF encoding*

The *National Institute of Standards and Technology (NIST) Secure Hash Algorithm (SHA-1)* is executed on the stream of bytes produced by **DataOutputStream**, producing a *20 byte array of values, sha[0..19]*. The hash code is assembled from the *first 8 bytes* of this array as follows:

```
long hash = 0;
for (int i = 0; i < Math.min(8, sha.length); i++) {
 hash += (long)(sha[i] & 255) << (i * 8);
}
```

For Serializable (including Externalizable) classes, the Java serialization version **UUID**, transcribed as a 16 digit upper-case hex string, shall be appended to the **RepositoryId** following the hash code and a colon. The Java serialization version **UUID** is defined in the Java Object Serialization Specification.

Examples for the valuetype **::foo::bar** would be

**RMI:foo/bar;;1234567812345678**  
**RMI:foo/bar;;1234567812345678:ABCD123456781234**

An example of a Java array of valuetype **::foo::bar** would be

**RMI:[Lfoo.bar;;1234567812345678:ABCD123456781234**

For a Java class **x\u03bCy** that contains a Unicode character not in ISO Latin 1, an example **RepositoryId** is

**RMI:foo.x\u03BCy:8765432187654321**

A conforming implementation that uses this format shall implement the standard hash algorithm defined above.

### 10.7.3 DCE UUID Format

DCE UUID format **RepositoryIds** start with the characters “DCE:” and are followed by the printable form of the UUID, a colon, and a decimal minor version number, for example: “DCE:700dc518-0110-11ce-ac8f-0800090b5d3e:1”.

### 10.7.4 LOCAL Format

Local format **RepositoryIds** start with the characters “LOCAL:” and are followed by an arbitrary string. Local format IDs are not intended for use outside a particular repository, and thus do not need to conform to any particular convention. Local IDs that are just consecutive integers might be used within a development environment to have a very cheap way to manufacture the IDs while avoiding conflicts with well-known interfaces.

### 10.7.5 Pragma Directives for RepositoryId

Three pragma directives (id, prefix, and version), are specified to accommodate arbitrary **RepositoryId** formats and still support the OMG IDL **RepositoryId** format with minimal annotation. The prefix and version pragma directives apply only to the IDL format. An IDL compiler must interpret these annotations as specified. Conforming IDL compilers may support additional non-standard pragmas, but must not refuse to compile IDL source containing non-standard pragmas that are not understood by the compiler.

### 10.7.5.1 The ID Pragma

An OMG IDL pragma of the format

```
#pragma ID <name> “<id>”
```

associates an arbitrary **RepositoryId** string with a specific OMG IDL name. The **<name>** can be a fully or partially scoped name or a simple identifier, interpreted according to the usual OMG IDL name lookup rules relative to the scope within which the pragma is contained. The **<id>** must be a repository ID of the form described in Section 10.7, “RepositoryIds,” on page 10-64.

An attempt to assign a repository ID to the same IDL construct a second time shall be an error unless the repository ID used in the attempt is identical to the previous one.

```
interface A {};
#pragma ID A “IDL:A:1.1”
#pragma ID A “IDL:X:1.1” // Compile-time error

interface B {};
#pragma ID B “IDL:BB:1.1”
#pragma ID B “IDL:BB:1.1” // OK, same ID
```

It is also an error to apply an ID to a forward-declared IDL construct (interface, valuetype, structure, and union) and then later assign a different ID to that IDL construct.

### 10.7.5.2 The Prefix Pragma

An OMG IDL pragma of the format:

```
#pragma prefix “<string>”
```

sets the current prefix used in generating OMG IDL format **RepositoryIds**. For example, the **RepositoryId** for the initial version of interface **Printer** defined on module **Office** by an organization known as “SoftCo” might be “IDL:SoftCo/Office/Printer:1.0”.

This format makes it convenient to generate and manage a set of IDs for a collection of OMG IDL definitions. The person creating the definitions sets a prefix (“SoftCo”), and the IDL compiler or other tool can synthesize all the needed IDs.

Because **RepositoryIds** may be used in many different computing environments and ORBs, as well as over a long period of time, care must be taken in choosing them. Prefixes that are distinct, such as trademarked names, domain names, UUIDs, and so forth, are preferable to generic names such as “document.”

The specified prefix applies to **RepositoryIds** generated after the pragma until the end of the current scope is reached or another prefix pragma is encountered. An IDL file forms a scope for this purpose, so a prefix resets to the previous prefix at the end of the scope of an included file:

```
// A.idl
#pragma prefix "A"
interface A {};
```

```
// B.idl
#pragma prefix "B"
#include "A.idl"
interface B {};
```

The repository IDs for interfaces A and B in this case are:

```
IDL:A/A:1.0
IDL:B/B:1.0
```

Similarly, a prefix in an including file does not affect the prefix of an included file:

```
// C.idl
interface C {};
```

```
// D.idl
#pragma prefix "D"
#include "C.idl"
interface D {};
```

The repository IDs for interface C and D in this case are:

```
IDL:C:1.0
IDL:D/D:1.0
```

If an included file does not contain a `#pragma` prefix, the current prefix implicitly resets to the empty prefix:

```
// E.idl
interface E {};
```

```
// F.idl
module M {
 #include <E.idl>
};
```

The repository IDs for module M and interface E in this case are:

```
IDL:M:1.0
IDL:E:1.0
```

If a `#include` directive appears at non-global scope and the included file contains a prefix pragma, the included file's prefix takes precedence, for example:

```
// A.idl
#pragma prefix "A"
interface A {};
```

```
// B.idl
#pragma prefix "B"
module M {
#include "A.idl"
};
```

The repository ID for module M and interface A in this case are:

```
IDL:B/M:1.0
IDL:A/A:1.0
```

Forward-declared constructs (interfaces, value types, structures, and unions) must have the same prefix in effect wherever they appear. Attempts to assign conflicting prefixes to a forward-declared construct result in a compile-time diagnostic. For example:

```
#pragma prefix "A"
interface A; // Forward decl.

#pragma prefix "B"
interface A; // Compile-time error

#pragma prefix "C"
interface A { // Compile-time error
 void op();
};
```

A prefix pragma of the form

```
#pragma prefix ""
```

resets the prefix to the empty string. For example:

```
#pragma prefix "X"
interface X {};
#pragma prefix ""
interface Y {};
```

The repository IDs for interface X and Y in this case are:

```
IDL:X/X:1.0
IDL:Y:1.0
```

If a specification contains both a prefix pragma and an ID or version pragma, the prefix pragma does not affect the repository ID for an ID pragma, but does affect the repository ID for a version pragma:

```
#pragma prefix "A"
interface A {};
interface B {};
interface C {};
#pragma ID B "IDL:myB:1.0"
#pragma version C 9.9
```

The repository IDs for this specification are

```
IDL:A/A:1.0
IDL:myB:1.0
IDL:A/C:9.9
```

A `#pragma` prefix must appear before the beginning of an IDL definition. Placing a `#pragma` prefix elsewhere has undefined behavior, for example:

```
interface Bar
 #pragma prefix "foo" // Undefined behavior
 {
 // ...
 };
```

### 10.7.5.3 *The Version Pragma*

An OMG IDL pragma of the format:

```
#pragma version <name> <major>.<minor>
```

provides the version specification used in generating an OMG IDL format **RepositoryId** for a specific OMG IDL name. The **<name>** can be a fully or partially scoped name or a simple identifier, interpreted according to the usual OMG IDL name lookup rules relative to the scope within which the pragma is contained. The **<major>** and **<minor>** components are decimal unsigned shorts.

If no version pragma is supplied for a definition, version 1.0 is assumed.

If an attempt is made to change the version of a repository ID that was specified with an ID pragma, a compliant compiler shall emit a diagnostic:

```
interface A {};
#pragma ID A "IDL:myA:1.1"
#pragma version A 9.9 // Compile-time error
```

An attempt to assign a version to the same IDL construct a second time shall be an error unless the version used in the attempt is identical to the existing one.

```
interface A {};
#pragma version A 1.1
#pragma version A 1.1 // OK
#pragma version A 1.2 // Error

interface B {};
#pragma ID B "IDL:myB:1.2"
#pragma version B 1.2 // OK
```

#### 10.7.5.4 Generation of OMG IDL - Format IDs

A definition is globally identified by an OMG IDL - format **RepositoryId** if no ID pragma is encountered for it.

The ID string shall be generated by starting with the string "IDL:". Then, if the current prefix pragma is a non-empty string, it is appended, followed by a "/" character. Next, the components of the scoped name of the definition, relative to the scope in which any prefix that applies was encountered, are appended, separated by "/" characters. Finally, a ":" and the version specification are appended.

For example, the following OMG IDL:

```

module M1 {
 typedef long T1;
 typedef long T2;
 #pragma ID T2 "DCE:d62207a2-011e-11ce-88b4-0800090b5d3e:3"
};

#pragma prefix "P1"

module M2 {
 module M3 {
 #pragma prefix "P2"
 typedef long T3;
 };
 typedef long T4;
 #pragma version T4 2.4
};

```

specifies types with the following scoped names and **RepositoryIds**:

|              |                                            |
|--------------|--------------------------------------------|
| ::M1::T1     | IDL:M1/T1:1.0                              |
| ::M1::T2     | DCE:d62207a2-011e-11ce-88b4-0800090b5d3e:3 |
| ::M2::M3::T3 | IDL:P2/T3:1.0                              |
| ::M2::T4     | IDL:P1/M2/T4:2.4                           |

For this scheme to provide reliable global identity, the prefixes used must be unique. Two non-colliding options are suggested: Internet domain names and DCE UUIDs.

Furthermore, in a distributed world where different entities independently evolve types, a convention must be followed to avoid the same **RepositoryId** being used for two different types. Only the entity that created the prefix has authority to create new IDs by simply incrementing the version number. Other entities must use a new prefix, even if they are only making a minor change to an existing type.

Prefix pragmas can be used to preserve the existing IDs when a module or other container is renamed or moved.

```

module M4 {
 #pragma prefix "P1/M2"

```



```

module M3 {
#pragma prefix "P2"
typedef long T3;
};
typedef long T4;
#pragma version T4 2.4
};

```

This OMG IDL declares types with the same global identities as those declared in module M2 above.

See Section 10.7.5.2, “The Prefix Pragma,” on page 10-68 for further details of the effects of various prefix pragma settings on the generated **RepositoryIds**.

### *10.7.6 For More Information*

Section 10.8, “OMG IDL for Interface Repository,” on page 10-75 shows the OMG IDL specification of the IR, including the `#pragma` directive. Section 3.3, “Preprocessing,” on page 3-11 contains additional, general information on the pragma directive.

### *10.7.7 RepositoryIDs for OMG-Specified Types*

Interoperability between implementations of official OMG specifications, including but not limited to CORBA, CORBA Services, and CORBA Facilities, depends on unambiguous specification of **RepositoryIds** for all IDL-defined types in such specifications.

All official OMG IDL files shall contain the following pragma prefix directive:

```
#pragma prefix "omg.org"
```

unless said file already contains a pragma prefix identifying the original source of the file (e.g., “**w3c.org**”).

Revisions to existing OMG specifications must not change the definition of an existing type in any way. Two types with different repository Ids are considered different types, regardless of which part of the repository Id differs.

If an implementation must extend an OMG-specified interface, interoperability requires it to derive a new interface from the standard interface, rather than modify the standard definition.

### *10.7.8 Uniqueness Constraints on Repository IDs*

Within an IDL definition, a module must have the same repository ID throughout. For example:

```
#pragma prefix "A"
module M {
```

```

 // ...
};

#pragma prefix "B"
module M { // Error, inconsistent repository ID
 // ...
};

```

This definition attempts to use the same type name M with two different repository IDs in the same compilation unit. Compilers shall issue a diagnostic for this error.

The same error can arise through inclusion of source files in the same compilation unit. For example:

```

// File1.idl
module M {
 module N {
 // ...
 };
#pragma ID N "abc"
};

// File2.idl
module M {
 module N {
 // ...
 };
};

// File3.idl
#include "File1.idl"
#include "File2.idl" // Error, inconsistent repository ID

```

Similarly:

```

// File1.idl
module M {
 // ...
};

// File2.idl
#include File1.idl
#pragma prefix "X"
module M { // Error, inconsistent repository ID
 // ...
};

```

Such errors are detectable only if they occur in a single compilation unit (or in files included in a single compilation unit); if, in different compilation units, different repository IDs are used for the same module, and these compilation units are combined into a single executable, the behavior is undefined.

## 10.8 *OMG IDL for Interface Repository*

This section contains the complete OMG IDL specification for the Interface Repository.

```

module CORBA {
 typeprefix CORBA "omg.org";
 typedef string Identifier;
 typedef string ScopedName;
 typedef string RepositoryId;

 enum DefinitionKind {
 dk_none, dk_all,
 dk_Attribute, dk_Constant, dk_Exception, dk_Interface,
 dk_Module, dk_Operation, dk_Typedef,
 dk_Alias, dk_Struct, dk_Union, dk_Enum,
 dk_Primitive, dk_String, dk_Sequence, dk_Array,
 dk_Repository,
 dk_Wstring, dk_Fixed,
 dk_Value, dk_ValueBox, dk_ValueMember,
 dk_Native,
 dk_AbstractInterface,
 dk_LocalInterface
 dk_Component, dk_Home,
 dk_Factory, dk_Finder,
 dk_Emits, dk_Publishes, dk_Consumes,
 dk_Provides, dk_Uses,
 dk_Event
 };

 interface IObject {
 // read interface
 readonly attribute DefinitionKind def_kind;
 // write interface
 void destroy ();
 };

 typedef string VersionSpec;

 interface Contained;
 interface Repository;
 interface Container;

 interface Contained : IObject {

 // read/write interface

 attribute RepositoryId id;
 attribute Identifier name;
 attribute VersionSpec version;
 };

```

```
// read interface

readonly attribute Container defined_in;
readonly attribute ScopedName absolute_name;
readonly attribute Repository containing_repository;

struct Description {
 DefinitionKind kind;
 any value;
};

Description describe ();

// write interface

void move (
 in Container new_container,
 in Identifier new_name,
 in VersionSpec new_version
);

};

interface ModuleDef;
interface ConstantDef;
interface IDLType;
interface StructDef;
interface UnionDef;
interface EnumDef;
interface AliasDef;
interface InterfaceDef;
interface ExceptionDef;
interface NativeDef;
typedef sequence <InterfaceDef> InterfaceDefSeq;
interface ValueDef;
typedef sequence <ValueDef> ValueDefSeq;
interface ValueBoxDef;
interface AbstractInterfaceDef;
typedef sequence <AbstractInterfaceDef> AbstractInterfaceDefSeq;
interface LocalInterfaceDef;
typedef sequence <LocalInterfaceDef> LocalInterfaceDefSeq;
interface ExtInterfaceDef;
typedef sequence <ExtInterfaceDef> ExtInterfaceDefSeq;
interface ExtValueDef;
typedef sequence <ExtValueDef> ExtValueDefSeq;
interface ExtAbstractInterfaceDef;
typedef sequence <ExtAbstractInterfaceDef>
 ExtAbstractInterfaceDefSeq;
interface ExtLocalInterfaceDef;
typedef sequence <ExtLocalInterfaceDef>
 ExtLocalInterfaceDefSeq;
```

```

typedef sequence <Contained> ContainedSeq;
struct StructMember {
 Identifier name;
 TypeCode type;
 IDLType type_def;
};

typedef sequence <StructMember> StructMemberSeq;

struct Initializer {
 StructMemberSeq members;
 Identifier name;
};
typedef sequence <Initializer> InitializerSeq;

struct ExceptionDescription {
 Identifier name;
 RepositoryId id;
 RepositoryId defined_in;
 VersionSpec version;
 TypeCode type;
};
typedef sequence <ExceptionDescription> ExcDescriptionSeq;

struct ExtInitializer {
 StructMemberSeq members;
 ExcDescriptionSeq exceptions;
 Identifier name;
};
typedef sequence <ExtInitializer> ExtInitializerSeq;

struct UnionMember {
 Identifier name;
 any label;
 TypeCode type;
 IDLType type_def;
};

typedef sequence <UnionMember> UnionMemberSeq;

typedef sequence <Identifier> EnumMemberSeq;

interface Container : IObject {
 // read interface

 Contained lookup (
 in ScopedName search_name);

 ContainedSeq contents (
 in DefinitionKind limit_type,
 in boolean exclude_inherited
);
};

```

```
);

ContainedSeq lookup_name (
 in Identifier search_name,
 in long levels_to_search,
 in DefinitionKind limit_type,
 in boolean exclude_inherited
);

struct Description {
 Contained contained_object;
 DefinitionKind kind;
 any value;
};

typedef sequence<Description> DescriptionSeq;

DescriptionSeq describe_contents (
 in DefinitionKind limit_type,
 in boolean exclude_inherited,
 in long max_returned_objs
);

// write interface

ModuleDef create_module (
 in RepositoryId id,
 in Identifier name,
 in VersionSpec version
);

ConstantDef create_constant (
 in RepositoryId id,
 in Identifier name,
 in VersionSpec version,
 in IDLType type,
 in any value
);

StructDef create_struct (
 in RepositoryId id,
 in Identifier name,
 in VersionSpec version,
 in StructMemberSeq members
);

UnionDef create_union (
 in RepositoryId id,
 in Identifier name,
 in VersionSpec version,
 in IDLType discriminator_type,
```

```

 in UnionMemberSeq members
);

EnumDef create_enum (
 in RepositoryId id,
 in Identifier name,
 in VersionSpec version,
 in EnumMemberSeq members
);

AliasDef create_alias (
 in RepositoryId id,
 in Identifier name,
 in VersionSpec version,
 in IDLType original_type
);

InterfaceDef create_interface (
 in RepositoryId id,
 in Identifier name,
 in VersionSpec version,
 in InterfaceDefSeq base_interfaces,
);

ValueDef create_value(
 in RepositoryId id,
 in Identifier name,
 in VersionSpec version,
 in boolean is_custom,
 in boolean is_abstract,
 in ValueDef base_value,
 in boolean is_truncatable,
 in ValueDefSeq abstract_base_values,
 in InterfaceDefSeq supported_interfaces,
 in InitializerSeq initializers
);

ValueBoxDef create_value_box(
 in RepositoryId id,
 in Identifier name,
 in VersionSpec version,
 in IDLType original_type_def
);

ExceptionDef create_exception(
 in RepositoryId id,
 in Identifier name,
 in VersionSpec version,
 in StructMemberSeq members
);

```

```

NativeDef create_native(
 in RepositoryId id,
 in Identifier name,
 in VersionSpec version
);

AbstractInterfaceDef create_abstract_interface (
 in RepositoryId id,
 in Identifier name,
 in VersionSpec version,
 in AbstractInterfaceDefSeq base_interfaces,
);

LocalInterfaceDef create_local_interface (
 in RepositoryId id,
 in Identifier name,
 in VersionSpec version,
 in InterfaceDefSeq base_interfaces
);

ExtValueDef create_ext_value (
 in RepositoryId id,
 in Identifier name,
 in VersionSpec version,
 in boolean is_custom,
 in boolean is_abstract,
 in ValueDef base_value,
 in boolean is_truncatable,
 in ValueDefSeq abstract_base_values,
 in InterfaceDefSeq supported_interfaces,
 in ExtInitializerSeq initializers
);
};

interface IDLType : IObject {
 readonly attribute TypeCode type;
};

interface PrimitiveDef;
interface StringDef;
interface SequenceDef;
interface ArrayDef;
interface WstringDef;
interface FixedDef;

enum PrimitiveKind {
 pk_null, pk_void, pk_short, pk_long, pk_ushort, pk_ulong,
 pk_float, pk_double, pk_boolean, pk_char, pk_octet,
 pk_any, pk_TypeCode, pk_Principal, pk_string, pk_objref,
 pk_longlong, pk_ulonglong, pk_longdouble,
 pk_wchar, pk_wstring, pk_value_base
};

```



```

};

interface Repository : Container {
 // read interface

 Contained lookup_id (in RepositoryId search_id);

 TypeCode get_canonical_typecode(in TypeCode tc);

 PrimitiveDef get_primitive (in PrimitiveKind kind);

 // write interface

 StringDef create_string (in unsigned long bound);

 WstringDef create_wstring (in unsigned long bound);

 SequenceDef create_sequence (
 in unsigned long bound,
 in IDLType element_type
);

 ArrayDef create_array (
 in unsigned long length,
 in IDLType element_type
);

 FixedDef create_fixed (
 in unsigned short digits,
 in short scale
);
};

interface ModuleDef : Container, Contained {
};

struct ModuleDescription {
 Identifier name;
 RepositoryId id;
 RepositoryId defined_in;
 VersionSpec version;
};

interface ConstantDef : Contained {
 readonly attribute TypeCode type;
 attribute IDLType type_def;
 attribute any value;
};

struct ConstantDescription {
 Identifier name;
};

```

```
 RepositoryId id;
 RepositoryId defined_in;
 VersionSpec version;
 TypeCode type;
 any value;
};

interface TypedefDef : Contained, IDLType {
};

struct TypeDescription {
 Identifier name;
 RepositoryId id;
 RepositoryId defined_in;
 VersionSpec version;
 TypeCode type;
};

interface StructDef : TypedefDef, Container {
 attribute StructMemberSeq members;
};

interface UnionDef : TypedefDef, Container {
 readonly attribute TypeCode discriminator_type;
 attribute IDLType discriminator_type_def;
 attribute UnionMemberSeq members;
};

interface EnumDef : TypedefDef {
 attribute EnumMemberSeq members;
};

interface AliasDef : TypedefDef {
 attribute IDLType original_type_def;
};

interface NativeDef : TypedefDef {
};

interface PrimitiveDef: IDLType {
 readonly attribute PrimitiveKind kind;
};

interface StringDef : IDLType {
 attribute unsigned long bound;
};

interface WstringDef : IDLType {
 attribute unsigned long bound;
};
```

```

interface FixedDef : IDLType {
 attribute unsigned short digits;
 attribute short scale;
};

interface SequenceDef : IDLType {
 attribute unsigned long bound;
 readonly attribute TypeCode element_type;
 attribute IDLType element_type_def;
};

interface ArrayDef : IDLType {
 attribute unsigned long length;
 readonly attribute TypeCode element_type;
 attribute IDLType element_type_def;
};

interface ExceptionDef : Contained, Container {
 readonly attribute TypeCode type;
 attribute StructMemberSeq members;
};

enum AttributeMode {ATTR_NORMAL, ATTR_READONLY};

interface AttributeDef : Contained {
 readonly attribute TypeCode type;
 attribute IDLType type_def;
 attribute AttributeMode mode;
};

struct AttributeDescription {
 Identifier name;
 RepositoryId id;
 RepositoryId defined_in;
 VersionSpec version;
 TypeCode type;
 AttributeMode mode;
};

struct ExtAttributeDescription {
 Identifier name;
 RepositoryId id;
 RepositoryId defined_in;
 VersionSpec version;
 TypeCode type;
 AttributeMode mode;
 ExcDescriptionSeq get_exceptions;
 ExcDescriptionSeq put_exceptions;
};

interface ExtAttributeDef : AttributeDef {

```

```

// read/write interface
attribute ExcDescriptionSeq get_exceptions;
attribute ExcDescriptionSeq set_exceptions;

// read interface
ExtAttributeDescription describe_attribute ();
};

enum OperationMode {OP_NORMAL, OP_ONEWAY};
enum ParameterMode {PARAM_IN, PARAM_OUT, PARAM_INOUT};

struct ParameterDescription {
 Identifier name;
 TypeCode type;
 IDLType type_def;
 ParameterMode mode;
};

typedef sequence <ParameterDescription> ParDescriptionSeq;
typedef Identifier ContextIdentifier;
typedef sequence <ContextIdentifier> ContextIdSeq;
typedef sequence <ExceptionDef> ExceptionDefSeq;

interface OperationDef : Contained {
 readonly attribute TypeCode result;
 attribute IDLType result_def;
 attribute ParDescriptionSeq params;
 attribute OperationMode mode;
 attribute ContextIdSeq contexts;
 attribute ExceptionDefSeq exceptions;
};

struct OperationDescription {
 Identifier name;
 RepositoryId id;
 RepositoryId defined_in;
 VersionSpec version;
 TypeCode result;
 OperationMode mode;
 ContextIdSeq contexts;
 ParDescriptionSeq parameters;
 ExcDescriptionSeq exceptions;
};

typedef sequence <RepositoryId> RepositoryIdSeq;
typedef sequence <OperationDescription> OpDescriptionSeq;
typedef sequence <AttributeDescription> AttrDescriptionSeq;
typedef sequence <ExtAttributeDescription> ExtAttrDescriptionSeq;

interface InterfaceDef : Container, Contained, IDLType {
 // read/write interface

```

```

attribute InterfaceDefSeq base_interfaces;

// read interface

boolean is_a (
 in RepositoryId interface_id
);

struct FullInterfaceDescription {
 Identifier name;
 RepositoryId id;
 RepositoryId defined_in;
 VersionSpec version;
 OpDescriptionSeq operations;
 AttrDescriptionSeq attributes;
 RepositoryIdSeq base_interfaces;
 TypeCode type;
};

FullInterfaceDescription describe_interface();

// write interface
AttributeDef create_attribute (
 in RepositoryId id,
 in Identifier name,
 in VersionSpec version,
 in IDLType type,
 in AttributeMode mode
);

OperationDef create_operation (
 in RepositoryId id,
 in Identifier name,
 in VersionSpec version,
 in IDLType result,
 in OperationMode mode,
 in ParDescriptionSeq params,
 in ExceptionDefSeq exceptions,
 in ContextIdSeq contexts
);
};

struct InterfaceDescription {
 Identifier name;
 RepositoryId id;
 RepositoryId defined_in;
 VersionSpec version;
 RepositoryIdSeq base_interfaces;
};

interface InterfaceAttrExtension {

```

```

// read interface

struct ExtFullInterfaceDescription {
 Identifier name;
 RepositoryId id;
 RepositoryId defined_in;
 VersionSpec version;
 OpDescriptionSeq operations;
 ExtAttrDescriptionSeq attributes;
 RepositoryIdSeq base_interfaces;
 TypeCode type;
};

ExtFullInterfaceDescription describe_ext_interface ();

// write interface
ExtAttributeDef create_ext_attribute (
 in RepositoryId id,
 in Identifier name,
 in VersionSpec version,
 in IDLType type,
 in AttributeMode mode,
 in ExceptionDefSeq get_exceptions,
 in ExceptionDefSeq set_exceptions
);

};

interface ExtInterfaceDef : InterfaceDef,
 InterfaceAttrExtension {
};

typedef short Visibility;
const Visibility PRIVATE_MEMBER = 0;
const Visibility PUBLIC_MEMBER = 1;

struct ValueMember {
 Identifier name;
 RepositoryId id;
 RepositoryId defined_in;
 VersionSpec version;
 TypeCode type;
 IDLType type_def;
 Visibility access;
};

typedef sequence <ValueMember> ValueMemberSeq;

interface ValueMemberDef : Contained {
 readonly attribute TypeCode type;
 attribute IDLType type_def;
 attribute Visibility access;
};

```

```

};

interface ValueDef : Container, Contained, IDLType {
 // read/write interface

 attribute InterfaceDefSeq supported_interfaces;
 attribute InitializerSeq initializers;
 attribute ValueDef base_value;
 attribute ValueDefSeq abstract_base_values;
 attribute boolean is_abstract;
 attribute boolean is_custom;
 attribute boolean is_truncatable;

 // read interface
 boolean is_a(
 in RepositoryId id
);

 struct FullValueDescription {
 Identifier name;
 RepositoryId id;
 boolean is_abstract;
 boolean is_custom;
 RepositoryId defined_in;
 VersionSpec version;
 OpDescriptionSeq operations;
 AttrDescriptionSeq attributes;
 ValueMemberSeq members;
 InitializerSeq initializers;
 RepositoryIdSeq supported_interfaces;
 RepositoryIdSeq abstract_base_values;
 boolean is_truncatable;
 RepositoryId base_value;
 TypeCode type;
 };

 FullValueDescription describe_value();

 // write interface

 ValueMemberDef create_value_member(
 in RepositoryId id,
 in Identifier name,
 in VersionSpec version,
 in IDLType type,
 in Visibility access
);

 AttributeDef create_attribute(
 in RepositoryId id,
 in Identifier name,

```

```

 in VersionSpec version,
 in IDLType type,
 in AttributeMode mode
);

 OperationDef create_operation (
 in RepositoryId id,
 in Identifier name,
 in VersionSpec version,
 in IDLType result,
 in OperationMode mode,
 in ParDescriptionSeq params,
 in ExceptionDefSeq exceptions,
 in ContextIdSeq contexts
);
};

struct ValueDescription {
 Identifier name;
 RepositoryId id;
 boolean is_abstract;
 boolean is_custom;
 RepositoryId defined_in;
 VersionSpec version;
 RepositoryIdSeq supported_interfaces;
 RepositoryIdSeq abstract_base_values;
 boolean is_truncatable;
 RepositoryId base_value;
};

interface ExtValueDef : ValueDef {

 // read/write interface
 attribute ExtInitializerSeq ext_initializers;

 // read interface

 struct ExtFullValueDescription {
 Identifier name;
 RepositoryId id;
 boolean is_abstract;
 boolean is_custom;
 RepositoryId defined_in;
 VersionSpec version;
 OpDescriptionSeq operations;
 ExtAttrDescriptionSeq attributes;
 ValueMemberSeq members;
 ExtInitializerSeq initializers;
 RepositoryIdSeq supported_interfaces;
 RepositoryIdSeq abstract_base_values;
 boolean is_truncatable;
 };
};

```



```

 RepositoryId base_value;
 TypeCode type;
 };

 ExtFullValueDescription describe_ext_value ();

 // write interface
 ExtAttributeDef create_ext_attribute (
 in RepositoryId id,
 in Identifier name,
 in VersionSpec version,
 in IDLType type,
 in AttributeMode mode,
 in ExceptionDefSeq get_exceptions,
 in ExceptionDefSeq set_exceptions
);
};

interface ValueBoxDef : TypedefDef {
 attribute IDLType original_type_def;
};

interface AbstractInterfaceDef : InterfaceDef {
};

interface ExtAbstractInterfaceDef : AbstractInterfaceDef,
 InterfaceAttrExtension {
};

interface LocalInterfaceDef : InterfaceDef {
};

interface ExtLocalInterfaceDef : LocalInterfaceDef,
 InterfaceAttrExtension {
};

//

module ComponentIR {
 typeprefix ComponentIR "omg.org";

 interface ComponentDef;
 interface HomeDef;

 interface EventDef : ExtValueDef {};

 interface Container{
 ComponentDef create_component (
 in RepositoryId id,
 in Identifier name,
 in VersionSpec version,

```

```
 in ComponentDef base_component,
 in InterfaceDefSeq supports_interfaces
);

 HomeDef create_home (
 in RepositoryId id,
 in Identifier name,
 in VersionSpec version,
 in HomeDef base_home,
 in ComponentDef managed_component,
 in InterfaceDefSeq supports_interfaces,
 in ValueDef primary_key
);

 EventDef create_event (
 in RepositoryId id,
 in Identifier name,
 in VersionSpec version,
 in boolean is_custom,
 in boolean is_abstract,
 in ValueDef base_value,
 in boolean is_truncatable,
 in ValueDefSeq abstract_base_values,
 in InterfaceDefSeq supported_interfaces,
 in ExtInitializerSeq initializers
);
};

interface ModuleDef : CORBA::ModuleDef, Container{};

interface Repository : CORBA::Repository, Container{};

interface ProvidesDef : Contained {
 attribute InterfaceDef interface_type;
};

struct ProvidesDescription {
 Identifier name;
 RepositoryId id;
 RepositoryId defined_in;
 VersionSpec version;
 RepositoryId interface_type;
};

interface UsesDef : Contained {
 attribute InterfaceDef interface_type;
 attribute boolean is_multiple;
};

struct UsesDescription {
 Identifier name;
```

```

 RepositoryId id;
 RepositoryId defined_in;
 VersionSpec version;
 RepositoryId interface_type;
 boolean is_multiple;
};

interface EventPortDef : Contained {

 // read/write interface
 attribute EventDef event;

 // read interface
 boolean is_a (in RepositoryId event_id);
};

struct EventPortDescription {
 Identifier name;
 RepositoryId id;
 RepositoryId defined_in;
 VersionSpec version;
 RepositoryId event;
};

interface EmitsDef : EventPortDef {};

interface PublishesDef : EventPortDef {};

interface ConsumesDef : EventPortDef {};

interface ComponentDef : ExtInterfaceDef {

 // read/write interface
 attribute ComponentDef base_component;
 attribute InterfaceDefSeq supported_interfaces;

 // write interface
 ProvidesDef create_provides (
 in RepositoryId id,
 in Identifier name,
 in VersionSpec version,
 in InterfaceDef interface_type
);

 UsesDef create_uses (
 in RepositoryId id,
 in Identifier name,
 in VersionSpec version,
 in InterfaceDef interface_type,
 in boolean is_multiple
);
};

```

```

EmitsDef create_emits (
 in RepositoryId id,
 in Identifier name,
 in VersionSpec version,
 in EventDef event
);

PublishesDef create_publishes (
 in RepositoryId id,
 in Identifier name,
 in VersionSpec version,
 in EventDef event
);

ConsumesDef create_consumes (
 in RepositoryId id,
 in Identifier name,
 in VersionSpec version,
 in EventDef event
);
};

typedef sequence<ProvidesDescription>
 ProvidesDescriptionSeq;
typedef sequence<UsesDescription> UsesDescriptionSeq;
typedef sequence<EventPortDescription>
 EventPortDescriptionSeq;

struct ComponentDescription {
 Identifier name;
 RepositoryId id;
 RepositoryId defined_in;
 VersionSpec version;
 RepositoryId base_component;
 RepositoryIdSeq supported_interfaces;
 ProvidesDescriptionSeq provided_interfaces;
 UsesDescriptionSeq used_interfaces;
 EventPortDescriptionSeq emits_events;
 EventPortDescriptionSeq publishes_events;
 EventPortDescriptionSeq consumes_events;
 ExtAttrDescriptionSeq attributes;
 TypeCode type;
};

interface FactoryDef : OperationDef {};

interface FinderDef : OperationDef {};

interface HomeDef : ExtInterfaceDef {

 // read/write interface

```

```

attribute HomeDef base_home;
attribute InterfaceDefSeq supported_interfaces;
attribute ComponentDef managed_component;
attribute ValueDef primary_key;

// write interface
FactoryDef create_factory (
 in RepositoryId id,
 in Identifier name,
 in VersionSpec version,
 in ParDescriptionSeq params,
 in ExceptionDefSeq exceptions
);

FinderDef create_finder (
 in RepositoryId id,
 in Identifier name,
 in VersionSpec version,
 in ParDescriptionSeq params,
 in ExceptionDefSeq exceptions
);
};

struct HomeDescription {
 Identifier name;
 RepositoryId id;
 RepositoryId defined_in;
 VersionSpec version;
 RepositoryId base_home;
 RepositoryId managed_component;
 ValueDescription primary_key;
 OpDescriptionSeq factories;
 OpDescriptionSeq finders;
 OpDescriptionSeq operations;
 ExtAttrDescriptionSeq attributes;
 TypeCode type;
};
};
};

```



This chapter describes the Portable Object Adapter, or POA. It presents the design goals, a description of the abstract model of the POA and its interfaces, followed by a detailed description of the interfaces themselves.

## *Contents*

This chapter contains the following sections.

| <b>Section Title</b>                | <b>Page</b> |
|-------------------------------------|-------------|
| “Overview”                          | 11-1        |
| “Abstract Model Description”        | 11-2        |
| “Interfaces”                        | 11-14       |
| “IDL for PortableServer Module”     | 11-46       |
| “UML Description of PortableServer” | 11-52       |
| “Usage Scenarios”                   | 11-54       |

## *11.1 Overview*

The POA is designed to meet the following goals:

- Allow programmers to construct object implementations that are portable between different ORB products.
- Provide support for objects with persistent identities. More precisely, the POA is designed to allow programmers to build object implementations that can provide consistent service for objects whose lifetimes (from the perspective of a client holding a reference for such an object) span multiple server lifetimes.

- Provide support for transparent activation of objects.
- Allow a single servant to support multiple object identities simultaneously.
- Allow multiple distinct instances of the POA to exist in a server.
- Provide support for transient objects with minimal programming effort and overhead.
- Provide support for implicit activation of servants with POA-allocated Object Ids.
- Allow object implementations to be maximally responsible for an object's behavior. Specifically, an implementation can control an object's behavior by establishing the datum that defines an object's identity, determining the relationship between the object's identity and the object's state, managing the storage and retrieval of the object's state, providing the code that will be executed in response to requests, and determining whether or not the object exists at any point in time.
- Avoid requiring the ORB to maintain persistent state describing individual objects, their identities, where their state is stored, whether certain identity values have been previously used or not, whether an object has ceased to exist or not, and so on.
- Provide an extensible mechanism for associating policy information with objects implemented in the POA.
- Allow programmers to construct object implementations that inherit from static skeleton classes, generated by OMG IDL compilers, or a DSI implementation.

## 11.2 *Abstract Model Description*

The POA interfaces described in this chapter imply a particular abstract computational model. This section presents that model and defines terminology and basic concepts that will be used in subsequent sections.

This section provides the rationale for the POA design, describes some of its intended uses, and provides a background for understanding the interface descriptions.

### 11.2.1 *Model Components*

The model supported by the POA is a specialization of the general object model described in the OMA guide. Most of the elements of the CORBA object model are present in the model described here, but there are some new components, and some of the names of existing components are defined more precisely than they are in the CORBA object model. The abstract model supported by the POA has the following components:

- *Client*—A client is a computational context that makes requests on an object through one of its references.
- *Server*—A server is a computational context in which the implementation of an object exists. Generally, a server corresponds to a process. Note that *client* and *server* are roles that programs play with respect to a given object. A program that is a client for one object may be the server for another. The same process may be both client and server for a single object.



- *Object*—In this discussion, we use *object* to indicate a CORBA object in the abstract sense, that is, a programming entity with an identity, an interface, and an implementation. From a client's perspective, the object's identity is encapsulated in the object's reference. This specification defines the server's view of object identity, which is explicitly managed by object implementations through the POA interface.
- *Servant*—A servant is a programming language object or entity that implements requests on one or more objects. Servants generally exist within the context of a server process. Requests made on an object's references are mediated by the ORB and transformed into invocations on a particular servant. In the course of an object's lifetime it may be associated with (that is, requests on its references will be targeted at) multiple servants.
- *Object Id*—An Object Id is a value that is used by the POA and by the user-supplied implementation to identify a particular abstract CORBA object. Object Id values may be assigned and managed by the POA, or they may be assigned and managed by the implementation. Object Id values are hidden from clients, encapsulated by references. Object Ids have no standard form; they are managed by the POA as uninterpreted octet sequences.

Note that the Object Id defined in this specification is a mechanical device used by an object implementation to correlate incoming requests with references it has previously created and exposed to clients. It does not constitute a unique logical identity for an object in any larger sense. The assignment and interpretation of Object Id values is primarily the responsibility of the application developer, although the **SYSTEM\_ID** policy enables the POA to generate Object Id values for the application.

- *Object Reference*—An object reference in this model is the same as in the CORBA object model. This model implies, however, that a reference specifically encapsulates an Object Id and a POA identity.

Note that a concrete reference in a specific ORB implementation will contain more information, such as the location of the server and POA in question. For example, it might contain the full name of the POA (the names of all POAs starting from the root and ending with the specific POA). The reference might not, in fact, actually contain the Object Id, but instead contain more compact values managed by the ORB that can be mapped to the Object Id. This is a description of the abstract information model implied by the POA. Whatever encoding is used to represent the POA name and the Object Id must not restrict the ability to use any legal character in a POA name or any legal octet in an Object Id.

- *POA*—A POA is an identifiable entity within the context of a server. Each POA provides a namespace for Object Ids and a namespace for other (nested or child) POAs. Policies associated with a POA describe characteristics of the objects implemented in that POA. Nested POAs form a hierarchical name space for objects within a server.
- *Policy*—A Policy is an object associated with a POA by an application in order to specify a characteristic shared by the objects implemented in that POA. This specification defines policies controlling the POA's threading model as well as a

variety of other options related to the management of objects. Other specifications may define other policies that affect how an ORB processes requests on objects implemented in the POA.

- *POA Manager*—A POA manager is an object that encapsulates the processing state of one or more POAs. Using operations on a POA manager, the developer can cause requests for the associated POAs to be queued or discarded. The developer can also use the POA manager to deactivate the POAs.
- *POA Manger Factory* -- A POA Manager Factory allows explicit creation of POA managers and lookup of existing POA managers. With explicit creation, the developer can control the identity (the name) of a POA manager as well as pass configuration policies to the factory operation.
- *Servant Manager*—A servant manager is an object that the application developer can associate with a POA. The ORB will invoke operations on servant managers to activate servants on demand, and to deactivate servants. Servant managers are responsible for managing the association of an object (as characterized by its Object Id value) with a particular servant, and for determining whether an object exists or not. There are two kinds of servant managers, called **ServantActivator** and **ServantLocator**; the type used in a particular situation depends on policies in the POA.
- *Adapter Activator*—An adapter activator is an object that the application developer can associate with a POA. The ORB will invoke an operation on an adapter activator when a request is received for a child POA that does not currently exist. The adapter activator can then create the required POA on demand.

### 11.2.2 Model Architecture

This section describes the architecture of the abstract model implied by the POA, and the interactions between various components. The ORB is an abstraction visible to both the client and server. The POA is an object visible to the server. User-supplied implementations are registered with the POA (this statement is a simplification; more detail is provided below). Clients hold references upon which they can make requests. The ORB, POA, and implementation all cooperate to determine which servant the operation should be invoked on, and to perform the invocation.

shows the detail of the relationship between the POA and the implementation. Ultimately, a POA deals with an Object Id and an active servant. By *active servant*, we mean a programming object that exists in memory and has been presented to the POA with one or more associated object identities. There are several ways for this association to be made.

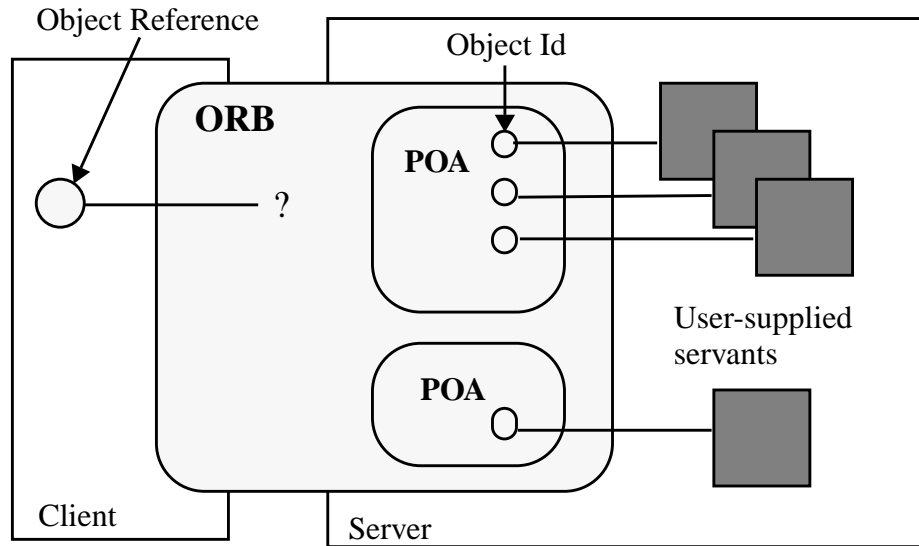

Figure 11-1 Abstract POA Model

If the POA supports the **RETAIN** policy, it maintains a map, labeled *Active Object Map*, that associates Object Ids with active servants, each association constituting an active object. If the POA has the **USE\_DEFAULT\_SERVANT** policy, a default servant may be registered with the POA. Alternatively, if the POA has the **USE\_SERVANT\_MANAGER** policy, a user-written servant manager may be registered with the POA. If the Active Object Map is not used, or a request arrives for an object not present in the Active Object Map, the POA either uses the default servant to perform the request or it invokes the servant manager to obtain a servant to perform the request. If the **RETAIN** policy is used, the servant returned by a servant manager is retained in the Active Object Map. Otherwise, the servant is used only to process the one request.

In this specification, the term *active* is applied equally to servants, Object Ids, and objects. An object is active in a POA if the POA's Active Object Map contains an entry that associates an Object Id with an existing servant. When this specification refers to *active Object Ids* and *active servants*, it means that the Object Id value or servant in question is part of an entry in the Active Object Map. An Object Id can appear in a POA's Active Object Map only once.

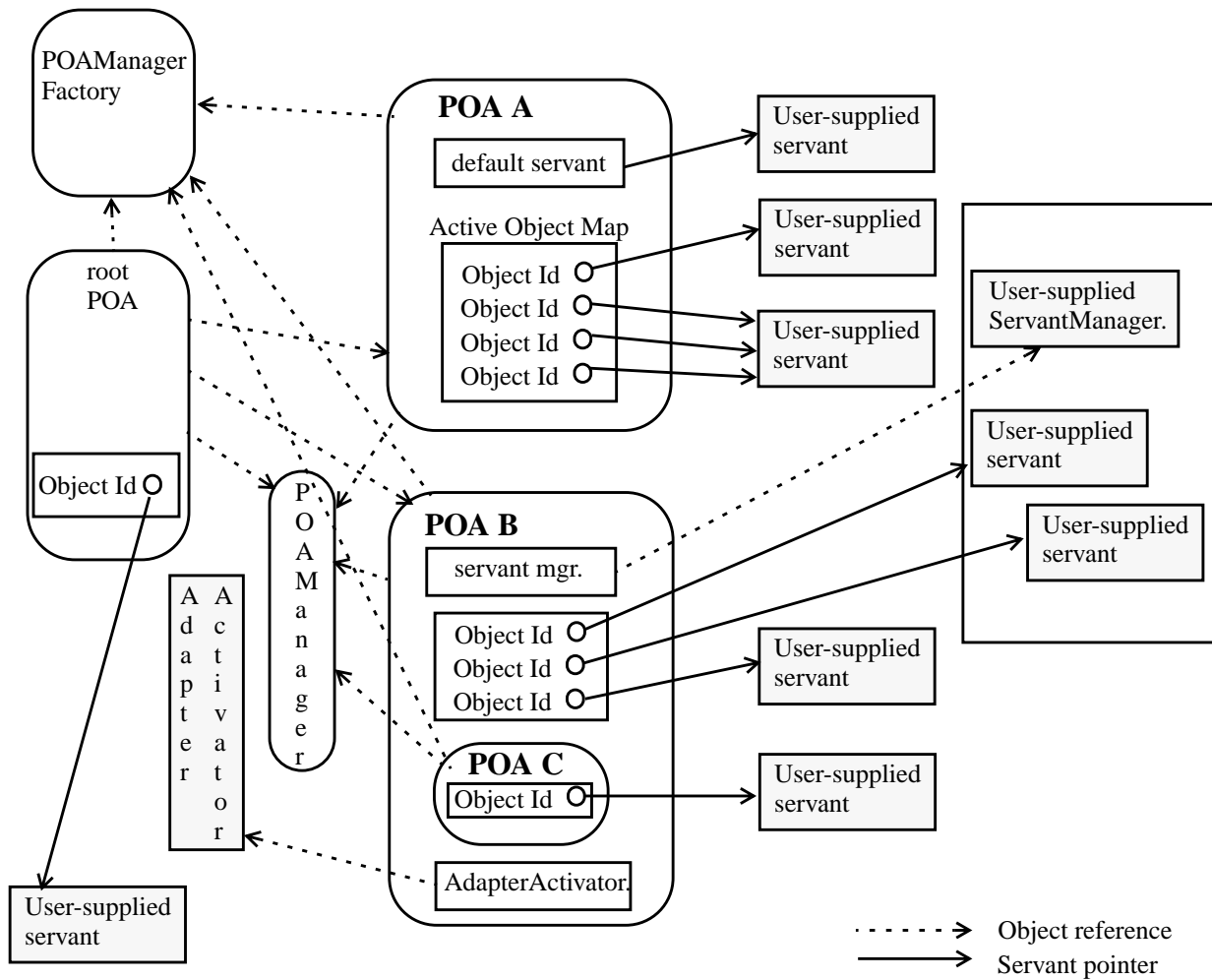

Figure 11-2 POA Architecture

### 11.2.3 POA Creation

To implement an object using the POA requires that the server application obtain a POA object. A distinguished POA object, called the *root POA*, is managed by the ORB and provided to the application using the ORB initialization interface under the initial object name "RootPOA." The application developer can create objects using the root POA if those default policies are suitable. The root POA has the following policies.

- Thread Policy: **ORB\_CTRL\_MODEL**
- Lifespan Policy: **TRANSIENT**
- Object Id Uniqueness Policy: **UNIQUE\_ID**
- Id Assignment Policy: **SYSTEM\_ID**

- Servant Retention Policy: **RETAIN**
- Request Processing Policy: **USE\_ACTIVE\_OBJECT\_MAP\_ONLY**
- Implicit Activation Policy: **IMPLICIT\_ACTIVATION**

The developer can also create new POAs. Creating a new POA allows the application developer to declare specific policy choices for the new POA and to provide a different adapter activator and servant manager (these are callback objects used by the POA to activate objects and nested POAs on demand). Creating new POAs also allows the application developer to partition the name space of objects, as Object Ids are interpreted relative to a POA. Finally, by creating new POAs, the developer can independently control request processing for multiple sets of objects.

A POA is created as a child of an existing POA using the **create\_POA** operation on the parent POA. When a POA is created, the POA is given a name that must be unique with respect to all other POAs with the same parent.

POA objects are not persistent. No POA state can be assumed to be saved by the ORB. It is the responsibility of the server application to create and initialize the appropriate POA objects during server initialization or to set an **AdapterActivator** to create POA objects needed later.

Creating the appropriate POA objects is particularly important for persistent objects, objects whose existence can span multiple server lifetimes. To support an object reference created in a previous server process, the application must recreate the POA that created the object reference as well as all of its ancestor POAs. To ensure portability, each POA must be created with the same name as the corresponding POA in the original server process and with the same policies. (It is the user's responsibility to create the POA with these conditions.)

A portable server application can presume that there is no conflict between its POA names and the POA names chosen by other applications. It is the responsibility of the ORB implementation to provide a way to support this behavior.

Each distinct ORB created as the result of an **ORB\_init** call in an application has its own separate root POA and POA namespace.

#### 11.2.4 Reference Creation

Object references are created in servers. Once they are created, they may be exported to clients.

From this model's perspective, object references encapsulate object identity information and information required by the ORB to identify and locate the server and POA with which the object is associated (that is, in whose scope the reference was created.)

References are created in the following ways:

- The server application may directly create a reference with the **create\_reference** and **create\_reference\_with\_id** operations on a POA object. These operations collect the necessary information to constitute the reference, either from

information associated with the POA or as parameters to the operation. These operations only create a reference. In doing so, they bring the abstract object into existence, but do not associate it with an active servant.

- The server application may explicitly activate a servant, associating it with an object identity using the **activate\_object** or **activate\_object\_with\_id** operations. Once a servant is activated, the server application can map the servant to its corresponding reference using the **servant\_to\_reference** or **id\_to\_reference** operations.
- The server application may cause a servant to implicitly activate itself. This behavior can only occur if the POA has been created with the **IMPLICIT\_ACTIVATION** policy. If an attempt is made to obtain an object reference corresponding to an inactive servant, the POA may automatically assign a generated unique Object Id to the servant and activate the resulting object. The reference may be obtained by invoking **POA::servant\_to\_reference** with an inactive servant, or by performing an explicit or implicit type conversion from the servant to a reference type in programming language mappings that permit this conversion.

Once a reference is created in the server, it can be made available to clients in a variety of ways. It can be advertised through the OMG Naming and Trading Services. It can be converted to a string via **ORB::object\_to\_string** and published in some way that allows the client to discover the string and convert it to a reference using **ORB::string\_to\_object**. It can be returned as the result of an operation invocation.

Once a reference becomes available to a client, that reference constitutes the identity of the object from the client's perspective. As long as the client program holds and uses that reference, requests made on the reference should be sent to the "same" object.

---

**Note** – The meaning of object identity and "sameness" is at present the subject of debate in the OMG. This specification does not attempt to resolve that debate in any way, particularly by defining a concrete notion of identity that is exposed to clients, beyond the existing notions of identity described in the CORBA specifications and the OMA guide.

---

The states of servers and implementation objects are opaque to clients. This specification deals primarily with the view of the ORB from the server's perspective.

### 11.2.5 Object Activation States

At any point in time, a CORBA object may or may not be associated with an active servant.

If the POA has the **RETAIN** policy, the servant and its associated Object Id are entered into the Active Object Map of the appropriate POA. This type of activation can be accomplished in one of the following ways.

- The server application itself explicitly activates individual objects (via the **activate\_object** or **activate\_object\_with\_id** operations).

- The server application instructs the POA to activate objects on demand by having the POA invoke a user-supplied servant manager. The server application registers this servant manager with **set\_servant\_manager**.
- Under some circumstances (when the **IMPLICIT\_ACTIVATION** policy is also in effect and the language binding allows such an operation), the POA may implicitly activate an object when the server application attempts to obtain a reference for a servant that is not already active (that is, not associated with an Object Id).

If the **USE\_DEFAULT\_SERVANT** policy is also in effect, the server application instructs the POA to activate unknown objects by having the POA invoke a single servant no matter what the Object Id is. The server application registers this servant with **set\_servant**.

If the POA has the **NON\_RETAIN** policy, for every request, the POA may use either a default servant or a servant manager to locate an active servant. From the POA's point of view, the servant is active only for the duration of that one request. The POA does not enter the servant-object association into the Active Object Map.

### 11.2.6 Request Processing

A request must be capable of conveying the Object Id of the target object as well as the identification of the POA that created the target object reference. When a client issues a request, the ORB first locates an appropriate server (perhaps starting one if needed) and then it locates the appropriate POA within that server.

If the POA does not exist in the server process, the application has the opportunity to re-create the required POA by using an adapter activator. An adapter activator is a user-implemented object that can be associated with a POA. It is invoked by the ORB when a request is received for a non-existent child POA. The adapter activator has the opportunity to create the required POA. If it does not, the client receives the **OBJECT\_NOT\_EXIST** exception with standard minor code 2.

Once the ORB has located the appropriate POA, it delivers the request to that POA. The further processing of that request depends both upon the policies associated with that POA as well as the object's current state of activation.

If the POA has the **RETAIN** policy, the POA looks in the Active Object Map to find out if there is a servant associated with the Object Id value from the request. If such a servant exists, the POA invokes the appropriate method on the servant.

If the POA has the **NON\_RETAIN** policy or has the **RETAIN** policy but didn't find a servant in the Active Object Map, the POA takes the following actions:

- If the POA has the **USE\_DEFAULT\_SERVANT** policy, a default servant has been associated with the POA so the POA will invoke the appropriate method on that servant. If no servant has been associated with the POA, the POA raises the **OBJ\_ADAPTER** system exception with standard minor code 3.
- If the POA has the **USE\_SERVANT\_MANAGER** policy, a servant manager has been associated with the POA so the POA will invoke **incarnate** or **preinvoke** on it to find a servant that may handle the request. (The choice of method depends on the

**NON\_RETAIN** or **RETAIN** policy of the POA.) If no servant manager has been associated with the POA, the POA raises the **OBJ\_ADAPTER** system exception with standard minor code 4.

- If the **USE\_OBJECT\_MAP\_ONLY** policy is in effect, the POA raises the **OBJECT\_NOT\_EXIST** system exception with standard minor code 2.

If a servant manager is located and invoked, but the servant manager is not directly capable of incarnating the object, it (the servant manager) may deal with the circumstance in a variety of ways, all of which are the application's responsibility. Any system exception raised by the servant manager will be returned to the client in the reply. In addition to standard system exceptions, a servant manager is capable of raising a **ForwardRequest** exception. This exception includes an object reference. The ORB will process this exception as specified in section 11.3.5.1.

### 11.2.7 *Implicit Activation*

A POA can be created with a policy that indicates that its objects may be implicitly activated. This policy, **IMPLICIT\_ACTIVATION**, also requires the **SYSTEM\_ID** and **RETAIN** policies.

When a POA supports implicit activation, an inactive servant may be implicitly activated in that POA by certain operations that logically require an *Object Id* to be assigned to that servant. (**IMPLICIT\_ACTIVATION** does not disallow explicit activation; instead, it enables both implicit and explicit activation.)

Implicit activation of an object involves allocating a system-generated Object Id and registering the servant with that *Object Id* in the *Active Object Map*. The interface associated with the implicitly activated object is determined from the servant (using static information from the skeleton, or, in the case of a dynamic servant, using the **\_primary\_interface()** operation).

The operations that support implicit activation include:

- The **POA::servant\_to\_reference** operation, which takes a servant parameter and returns a reference.
- The **POA::servant\_to\_id** operation, which takes a servant parameter and returns an Object Id.
- Operations supported by a language mapping to obtain an object reference or an Object Id for a servant. For example, the **\_this()** servant member function in C++ returns an object reference for the servant.
- Implicit conversions supported by a language mapping that convert a servant to an object reference or an Object Id.

The last two categories of operations are language-mapping-dependent.

If the POA has the **UNIQUE\_ID** policy, then implicit activation will occur when any of these operations are performed on a servant that is not currently active (that is, it is associated with no Object Id in the POA's Active Object Map).



If the POA has the **MULTIPLE\_ID** policy, the **servant\_to\_reference** and **servant\_to\_id** operations will *always* perform implicit activation, even if the servant is already associated with an Object Id. The behavior of language mapping operations in the **MULTIPLE\_ID** case is specified by the language mapping. For example, in C++, the **\_this()** servant member function will not implicitly activate a **MULTIPLE\_ID** servant if the invocation of **\_this()** is immediately within the dynamic context of a request invocation directed by the POA to that servant; instead, it returns the object reference used to issue the request.

---

**Note** – The exact timing of implicit activation is ORB implementation-dependent. For example, instead of activating the object immediately upon creation of a local object reference, the ORB could defer the activation until the Object Id is actually needed (for example, when the object reference is exported outside the process).

---

## 11.2.8 Multi-threading

The POA does not require the use of threads and does not specify what support is needed from a threads package. However, in order to allow the development of portable servers that utilize threads, the behavior of the POA and related interfaces when used within a multiple-thread environment must be specified.

Specifying this behavior does not require that an ORB must support being used in a threaded environment, nor does it require that an ORB must utilize threads in the processing of requests. The only requirement given here is that if an ORB does provide support for multi-threading, these are the behaviors that will be supported by that ORB. This allows a programmer to take advantage of multiple ORBs that support threads in a portable manner across those ORBs.

The POA's processing is affected by the thread-related calls available in the ORB: **work\_pending**, **perform\_work**, **run**, and **shutdown**.

### 11.2.8.1 POA Threading Models

The POA supports three models of threading when used in conjunction with multi-threaded ORB implementations; ORB controlled, single thread and main-thread behavior. The three models can be used together or independently. All can be used in environments where a single-threaded ORB is used.

The threading model associated with a POA is indicated when the POA is created by including a **ThreadPolicy** object in the policies parameter of the POA's **create\_POA** operation. Once a POA is created with one model, it cannot be changed to the other. All uses of the POA within the server must conform to that threading model associated with the POA.

### 11.2.8.2 *Using the Single Thread Model*

Requests for each single-threaded POA are processed sequentially. In a multi-threaded environment, upcalls made by this POA to servants shall not be made concurrently. This provides a degree of safety for code that is multi-thread-unaware.

---

**Note** – In a multi-threaded environment, requests to distinct single-threaded POAs may be processed concurrently.

---

The POA will still allow reentrant calls from an object implementation to itself, or to another object implementation managed by the same POA.

### 11.2.8.3 *Using the ORB Controlled Model*

The ORB controlled model of threading is used in environments where the developer wants the ORB/POA to control the use of threads in the manner provided by the ORB. This model can also be used in environments that do not support threads.

In this model, the ORB is responsible for the creation, management, and destruction of threads used with one or more POAs.

### 11.2.8.4 *Using the Main Thread Model*

Requests for all main-thread POAs are processed sequentially. In a multi-threaded environment, all upcalls made by all POAs with this policy to servants are made in a manner that is safe for code that is multi-thread-unaware.

If the environment has special requirements that some code must run on a distinguished "main" thread, servant upcalls will be processed on that thread. (See Section 4.2.5, "Thread-Related Operations," on page 4-9.)

---

**Note** – Not all environments have such a special requirement. If not, while requests will be processed sequentially they might not all be processed by the same thread.

---

### 11.2.8.5 *Limitations When Using Multiple Threads*

There are no guarantees that the ORB and POA will do anything specific about dispatching requests across threads with a single POA. Therefore, a server programmer who wants to use one or more POAs within multiple threads must take on all of the serialization of access to objects within those threads.

There may be requests active for the same object being dispatched within multiple threads at the same time. The programmer must be aware of this possibility and code with it in mind.

### 11.2.9 Dynamic Skeleton Interface

The POA is designed to enable programmers to connect servants to:

- type-specific skeletons, typically generated by OMG IDL compilers, or
- dynamic skeletons.

Servants that are members of type-specific skeleton classes are referred to as type-specific servants. Servants connected to dynamic skeletons are used to implement the Dynamic Skeleton Interface (DSI) and are referred to as DSI servants.

Whether a CORBA object is being incarnated by a DSI servant or a type-specific servant is transparent to its clients. Two CORBA objects supporting the same interface may be incarnated, one by a DSI servant and the other with a type-specific servant. Furthermore, a CORBA object may be incarnated by a DSI servant only during some period of time, while the rest of the time is incarnated by a static servant.

The mapping for POA DSI servants is language-specific, with each language providing a set of interfaces to the POA. These interfaces are used only by the POA. The interfaces required are the following.

- Take a **CORBA::ServerRequest** object from the POA and perform the processing necessary to execute the request.
- Return the Interface Repository Id identifying the most-derived interface supported by the target CORBA object in a request.

The reason for the first interface is the entire reason for existence of the DSI: to be able to handle any request in the way the programmer wishes to handle it. A single DSI servant may be used to incarnate several CORBA objects, potentially supporting different interfaces.

The reason for the second interface can be understood by comparing DSI servants to type-specific servants.

A type-specific servant may incarnate several CORBA objects but all of them will support the same IDL interface as the most-derived IDL interface. In C++, for example, an IDL interface **Window** in module **GraphicalSystem** will generate a type-specific skeleton class called **Window** in namespace **POA\_GraphicalSystem**. A type-specific servant that is directly derived from the **POA\_GraphicalSystem::Window** skeleton class may incarnate several CORBA objects at a time, but all those CORBA objects will support the **GraphicalSystem::Window** interface as the most-derived interface.

A DSI servant may incarnate several CORBA objects, not necessarily supporting the same IDL interface as the most-derived IDL interface.

In both cases (type-specific and DSI) the POA may need to determine, at runtime, the Interface Repository Id identifying the most-derived interface supported by the target CORBA object in a request. The POA should be able to determine this by asking the servant that is going to serve the CORBA object.

In the case of type-specific servants, the POA obtains that information from the type-specific skeleton class from which the servant is directly derived. In the case of DSI servants, the POA obtains that information by using the second language-specific interface above.

### 11.2.10 Location Transparency

The POA supports location transparency for objects implemented using the POA. Unless explicitly stated to the contrary, all POA behavior described in this specification applies regardless of whether the client is local (same process) or remote. For example, like a request from a remote client, a request from a local client may cause object activation if the object is not active, block indefinitely if the target object's POA is in the holding state, be rejected if the target object's POA is in the discarding or inactive states, be delivered to a thread-unaware object implementation, or be delivered to a different object if the target object's servant manager raises the **ForwardRequest** exception. The Object Id and POA of the target object will also be available to the server via the **Current** object, regardless of whether the client is local or remote.

---

**Note** – The implication of these requirements on the ORB implementation is to require the ORB to mediate all requests to POA-based objects, even if the client is co-resident in the same process. This specification is not intended to change CORBAServices specifications that allow for behaviors that are not location transparent. This specification does not prohibit (nonstandard) POA extensions to support object behavior that is not location-transparent.

---

## 11.3 Interfaces

The POA-related interfaces are defined in a module separate from the **CORBA** module, the **PortableServer** module. It consists of these interfaces:

- **POA**
- **POAManager**
- **POAManagerFactory**
- **ServantManager**
- **ServantActivator**
- **ServantLocator**
- **AdapterActivator**
- **ThreadPolicy**
- **LifespanPolicy**
- **IdUniquenessPolicy**
- **IdAssignmentPolicy**
- **ImplicitActivationPolicy**
- **ServantRetentionPolicy**
- **RequestProcessingPolicy**
- **Current**

In addition, the POA defines the **Servant** native type.

### 11.3.1 The Servant IDL Type

This specification defines a native type **PortableServer::Servant**. Values of the type **Servant** are programming-language-specific implementations of CORBA interfaces. Each language mapping must specify how **Servant** is mapped to the programming language data type that corresponds to an object implementation. The **Servant** type has the following characteristics and constraints.

- Values of type **Servant** are opaque from the perspective of CORBA application programmers. There are no operations that can be performed directly on them by user programs. They can be passed as parameters to certain POA operations. Some language mappings may allow **Servant** values to be implicitly converted to object references under appropriate conditions.
- Values of type **Servant** support a language-specific programming interface that can be used by the ORB to obtain a default POA for that servant. This interface is used only to support implicit activation. A language mapping may provide a default implementation of this interface that returns the root POA of a default ORB.
- Values of type **Servant** provide default implementations of the standard object reference operations **get\_interface**, **is\_a**, and **non\_existent**. These operations can be overridden by the programmer to provide additional behavior needed by the object implementation. The default implementations of **get\_interface** and **is\_a** operations use the most derived interface of a static servant or the most derived interface retrieved from a dynamic servant to perform the operation. The default implementation of the **non\_existent** operation returns **FALSE**. These operations are invoked by the POA just like any other operation invocation, so the **PortableServer::Current** interface and any language-mapping-provided method of accessing the invocation context are available.
- Values of type **Servant** must be testable for identity.
- Values of type **Servant** have no meaning outside of the process context or address space in which they are generated.

### 11.3.2 POAManager Interface

Each POA object has an associated **POAManager** object. A POA manager may be associated with one or more POA objects. A POA manager encapsulates the processing state of the POAs it is associated with. Using operations on the POA manager, an application can cause requests for those POAs to be queued or discarded, and can cause the POAs to be deactivated.

Each **POAManager** has a unique string as its identity. The scope of the **POAManager** identity is the **ORB**, so no two **POAManagers** within the same **ORB** can have the same identity (but **POAManagers** in different **ORB**s can). The **POAManager** for the Root **POA** has the name "**RootPOAManager**".

If a **POAManager** is created implicitly (as part of the creation of a new **POA**), it is assigned a unique identity by the **ORB** run time. If a **POAManager** is created explicitly (using the **POAManagerFactory**), its identity is the string passed to the factory operation. (An empty identity string is legal.) A **POAManager** is destroyed implicitly, when the last of its **POAs** is destroyed.

**POAManager** is a local interface.

### 11.3.2.1 *Processing States*

A POA manager has four possible processing states; *active*, *inactive*, *holding*, and *discarding*. The processing state determines the capabilities of the associated POAs and the disposition of requests received by those POAs. Figure 11-3 on page 11-17 illustrates the processing states and the transitions between them. For simplicity of presentation, this specification sometimes describes these states as POA states, referring to the POA or POAs that have been associated with a particular POA manager. A POA manager is created in the *holding* state. The root POA is therefore initially in the *holding* state.

For simplicity in the figure and the explanation, operations that would not cause a state change are not shown. For example, if a POA is in “active” state, it does not change state due to an activate operation. Such operations complete successfully with no special notice.

The only exception is the inactive state: a “deactivate” operation raises an exception just the same as every other attempted state change operation.

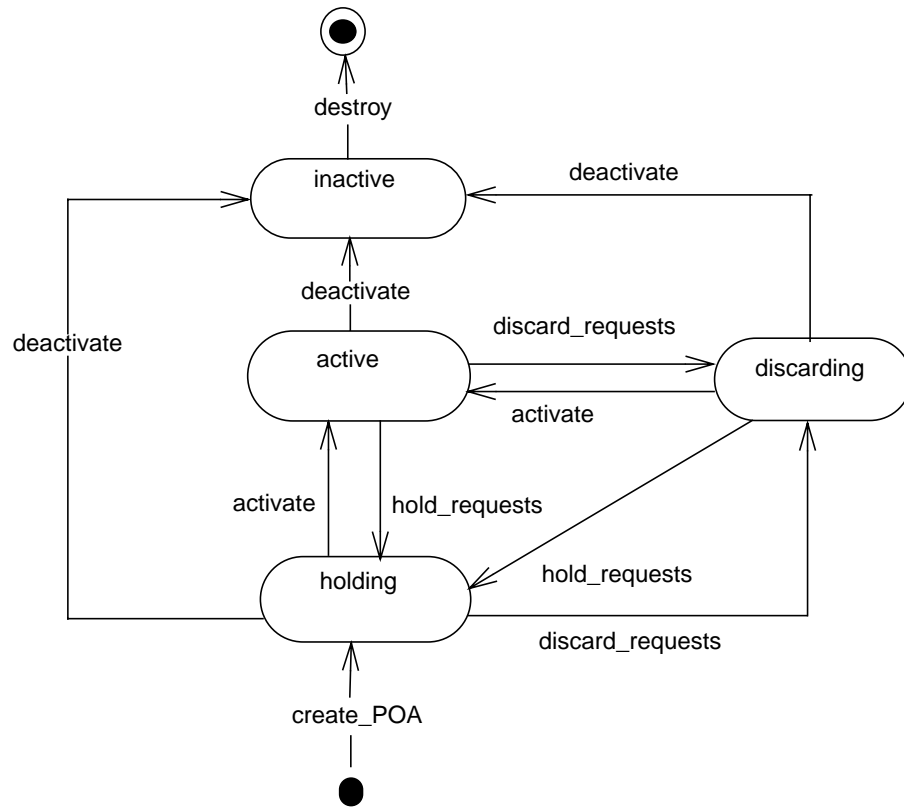

Figure 11-3 Processing States

### Active State

When a POA manager is in the *active* state, the associated POAs will receive and start processing requests (assuming that appropriate thread resources are available). Note that even in the active state, a POA may need to queue requests depending upon the ORB implementation and resource limits. The number of requests that can be received and/or queued is an implementation limit. If this limit is reached, the POA should return a **TRANSIENT** system exception, with standard minor code 1, to indicate that the client should re-issue the request.

A user program can legally transition a POA manager from the *active* state to either the *discarding*, *holding*, or *inactive* state by calling the **discard\_requests**, **hold\_requests**, or **deactivate** operations, respectively. The POA enters the *active* state through the use of the **activate** operation when in the *discarding* or *holding* state.

### *Discarding State*

When a POA manager is in the *discarding* state, the associated POAs will discard all incoming requests (whose processing has not yet begun). When a request is discarded, the **TRANSIENT** system exception, with standard minor code 1, must be returned to the client-side to indicate that the request should be re-issued. (Of course, an ORB may always reject a request for other reasons and raise some other system exception.)

In addition, when a POA manager is in the *discarding* state, the adapter activators registered with the associated POAs will not get called. Instead, requests that require the invocation of an adapter activator will be discarded, as described in the previous paragraph.

The primary purpose of the *discarding* state is to provide an application with flow-control capabilities when it determines that an object's implementation or POA is being flooded with requests. It is expected that the application will restore the POA manager to the *active* state after correcting the problem that caused flow-control to be needed.

A POA manager can legally transition from the *discarding* state to either the *active*, *holding*, or *inactive* state by calling the **activate**, **hold\_requests**, or **deactivate** operations, respectively. The POA enters the *discarding* state through the use of the **discard\_requests** operation when in the *active* or *holding* state.

### *Holding State*

When a POA manager is in the *holding* state, the associated POAs will queue incoming requests. The number of requests that can be queued is an implementation limit. If this limit is reached, the POAs may discard requests and return the **TRANSIENT** system exception, with standard minor code 1, to the client to indicate that the client should reissue the request. (Of course, an ORB may always reject a request for other reasons and raise some other system exception.)

In addition, when a POA manager is in the *holding* state, the adapter activators registered with the associated POAs will not get called. Instead, requests that require the invocation of an adapter activator will be queued, as described in the previous paragraph.

A POA manager can legally transition from the *holding* state to either the *active*, *discarding*, or *inactive* state by calling the **activate**, **discard\_requests**, or **deactivate** operations, respectively. The POA enters the *holding* state through the use of the **hold\_requests** operation when in the *active* or *discarding* state. A POA manager is created in the holding state.

### *Inactive State*

The *inactive* state is entered when the associated POAs are to be shut down. Unlike the *discarding* state, the *inactive* state is not a temporary state. When a POA manager is in the *inactive* state, the associated POAs will reject new requests. The rejection mechanism used is specific to the vendor. The GIOP location forwarding mechanism and CloseConnection message are examples of mechanisms that could be used to indicate the rejection. If the client is co-resident in the same process, the ORB could raise the **OBJ\_ADAPTER** system exception, with standard minor code 1, to indicate that the object implementation is unavailable.



In addition, when a POA manager is in the *inactive* state, the adapter activators registered with the associated POAs will not get called. Instead, requests that require the invocation of an adapter activator will be rejected, as described in the previous paragraph.

The *inactive* state is entered using the **deactivate** operation. It is legal to enter the *inactive* state from either the *active*, *holding*, or *discarding* states.

If the transition into the *inactive* state is a result of calling **deactivate** with an **etherealize\_objects** parameter of

- **TRUE** - the associated POAs will call **etherealize** for each active object associated with the POA once all currently executing requests have completed processing (if the POAs have the **RETAIN** and **USE\_SERVANT\_MANAGER** policies). If a servant manager has been registered for the POA, the POA will get rid of the object. If there are any queued requests that have not yet started executing, they will be treated as if they were new requests and rejected.
- **FALSE** - No deactivations or etherealizations will be attempted.

### 11.3.2.2 *activate*

**void activate()  
raises (AdapterInactive);**

This operation changes the state of the POA manager to *active*. If issued while the POA manager is in the *inactive* state, the **AdapterInactive** exception is raised. Entering the *active* state enables the associated POAs to process requests.

### 11.3.2.3 *hold\_requests*

**void hold\_requests( in boolean wait\_for\_completion )  
raises(AdapterInactive);**

This operation changes the state of the POA manager to *holding*. If issued while the POA manager is in the *inactive* state, the **AdapterInactive** exception is raised. Entering the *holding* state causes the associated POAs to queue incoming requests. Any requests that have been queued but have not started executing will continue to be queued while in the *holding* state.

If the **wait\_for\_completion** parameter is **FALSE**, this operation returns immediately after changing the state. If the parameter is **TRUE** and the current thread is not in an invocation context dispatched by some POA belonging to the same ORB as this POA, this operation does not return until either there are no actively executing requests in any of the POAs associated with this POA manager (that is, all requests that were started prior to the state change have completed) or the state of the POA manager is changed to a state other than *holding*. If the parameter is **TRUE** and the current thread is in an invocation context dispatched by some POA belonging to the same ORB as this POA the **BAD\_INV\_ORDER** system exception with standard minor code 3 is raised and the state is not changed.

#### 11.3.2.4 *discard\_requests*

**void discard\_requests( in boolean wait\_for\_completion )  
raises (AdapterInactive);**

This operation changes the state of the POA manager to *discarding*. If issued while the POA manager is in the *inactive* state, the **AdapterInactive** exception is raised. Entering the *discarding* state causes the associated POAs to discard incoming requests. In addition, any requests that have been queued but have not started executing are discarded. When a request is discarded, a **TRANSIENT** system exception with standard minor code 1 is returned to the client.

If the **wait\_for\_completion** parameter is **FALSE**, this operation returns immediately after changing the state. If the parameter is **TRUE** and the current thread is not in an invocation context dispatched by some POA belonging to the same ORB as this POA, this operation does not return until either there are no actively executing requests in any of the POAs associated with this POA manager (that is, all requests that were started prior to the state change have completed) or the state of the POA manager is changed to a state other than *discarding*. If the parameter is **TRUE** and the current thread is in an invocation context dispatched by some POA belonging to the same ORB as this POA the **BAD\_INV\_ORDER** system exception with standard minor code 3 is raised and the state is not changed.

#### 11.3.2.5 *deactivate*

**void deactivate( in boolean etherealize\_objects,  
in boolean wait\_for\_completion);  
raises (AdapterInactive);**

This operation changes the state of the POA manager to *inactive*. This operation has no affect on the POA manager's state if it is already in the *inactive* state, but may still block if **wait\_for\_completion** is **TRUE** and another call to **deactivate** on the same POA manager is pending. Entering the *inactive* state causes the associated POAs to reject requests that have not begun to be executed as well as any new requests.

After changing the state, if the **etherealize\_objects** parameter is

- **TRUE** - the POA manager will cause all associated POAs that have the **RETAIN** and **USE\_SERVANT\_MANAGER** policies to perform the **etherealize** operation on the associated servant manager for all active objects.
- **FALSE** - the **etherealize** operation is not called. The purpose is to provide developers with a means to shut down POAs in a crisis (for example, unrecoverable error) situation.

If the **wait\_for\_completion** parameter is **FALSE**, this operation will return immediately after changing the state. If the parameter is **TRUE** and the current thread is not in an invocation context dispatched by some POA belonging to the same ORB as this POA, this operation does not return until there are no actively executing requests in any of the POAs associated with this POA manager (that is, all requests that were started prior to the state change have completed) and, in the case of a **TRUE**

**etherealize\_objects**, all invocations of **etherealize** have completed for POAs having the **RETAIN** and **USE\_SERVANT\_MANAGER** policies. If the parameter is **TRUE** and the current thread is in an invocation context dispatched by some POA belonging to the same ORB as this POA the **BAD\_INV\_ORDER** system exception with standard minor code 3 is raised and the state is not changed.

If **deactivate** is called multiple times before destruction is complete (because there are active requests), the **etherealize\_objects** parameter applies only to the first call of **deactivate**; subsequent calls with conflicting **etherealize\_objects** settings will use the value of the **etherealize\_objects** from the first call. The **wait\_for\_completion** parameter will be handled as defined above for each individual call (some callers may choose to block, while others may not).

#### 11.3.2.6 *get\_state*

```
enum State {HOLDING, ACTIVE, DISCARDING, INACTIVE};
State get_state();
```

This operation returns the state of the POA manager.

#### 11.3.2.7 *get\_id*

```
string get_id();
```

This operation returns the **POAManager**'s unique identity. The **id** of the **POAManager** for the Root POA is "**RootPOAManager**".

### 11.3.3 *POAManagerFactory Interface*

**POAManager**s can be created implicitly, by passing a nil **POAManager** reference to the **create\_POA** operation, or can be created explicitly using a **POAManagerFactory**. Explicit creation of a **POAManager** permits application control of the **POAManager**'s identity, whereas implicit creation results in creation of a unique identity by the ORB run time. Explicit creation of a **POAManager** also permits the application to assign policies to the new **POAManager**.

#### 11.3.3.1 *create\_POAManager*

```
exception ManagerAlreadyExists {};
```

```
POAManager create_POAManager(
 in string id,
 in CORBA::PolicyList policies
) raises(ManagerAlreadyExists, CORBA::PolicyError);
```

This operation creates a new **POAManager** with the given id. If a **POAManager** with the given id exists already within the ORB, the operation raises **ManagerAlreadyExists**. (Note that placing a **POAManager** into the inactive state does not necessarily result in

destruction of the POAManager because destruction of a POAManager only occurs once the last of its POAs has been destroyed. **create\_POAManager** succeeds in creation of a new POAManager with the same identity as a previous POAManager only once the previous POAManager's POAs are destroyed.)

The policies parameter permits an arbitrary number of policies to be passed; these policies can be used by an ORB implementation to influence the POAManager's behavior in some way; for example, an ORB may choose to use this mechanism to pass configuration information to the factory. The policies passed to **create\_POAManager** are deep-copied during creation; modification of a policy sequence after creation has therefore no effect on already existing POAManagers. If one or more of the policies are invalid, **create\_POAManager** raises **CORBA::PolicyError**.

The newly created POAManager is in the Holding state.

### 11.3.3.2 *list*

```
typedef sequence<POAManager> POAManagerSeq;
POAManagerSeq list();
```

The list operation returns all POAManagers (whether created implicitly or explicitly) that currently exist within the ORB.

### 11.3.3.3 *find*

```
POAManager find(in string id);
```

The find operation return the POAManager with the specified id. If no such POAManager exists, find returns a nil reference.

## 11.3.4 *AdapterActivator Interface*

Adapter activators are associated with POAs. An adapter activator supplies a POA with the ability to create child POAs on demand, as a side-effect of receiving a request that names the child POA (or one of its children), or when **find\_POA** is called with an activate parameter value of TRUE. An application server that creates all its needed POAs at the beginning of execution does not need to use or provide an adapter activator; it is necessary only for the case in which POAs need to be created during request processing.

While a request from the POA to an adapter activator is in progress, all requests to objects managed by the new POA (or any descendant POAs) will be queued. This serialization allows the adapter activator to complete any initialization of the new POA before requests are delivered to that POA.

An **AdapterActivator** object must be local to the process containing the POA objects it is registered with. **AdapterActivator** is a local interface.

### 11.3.4.1 *unknown\_adapter*

#### **boolean unknown\_adapter(in POA parent, in string name);**

This operation is invoked when the ORB receives a request for an object reference that identifies a target POA that does not exist. The ORB invokes this operation once for each POA that must be created in order for the target POA to exist (starting with the ancestor POA closest to the root POA). The operation is invoked on the adapter activator associated with the POA that is the parent of the POA that needs to be created. That parent POA is passed as the **parent** parameter. The name of the POA to be created (relative to the parent) is passed as the **name** parameter.

The implementation of this operation should either create the specified POA and return TRUE, or it should return FALSE. If the operation returns TRUE, the ORB will proceed with processing the request. If the operation returns FALSE, the ORB will return **OBJECT\_NOT\_EXIST** with standard minor code 2 to the client. If multiple POAs need to be created, the ORB will invoke **unknown\_adapter** once for each POA that needs to be created. If the parent of a nonexistent POA does not have an associated adapter activator, the ORB will return the **OBJECT\_NOT\_EXIST** system exception with standard minor code 2.

If **unknown\_adapter** raises a system exception, the ORB will report an **OBJ\_ADAPTER** system exception with standard minor code 1.

---

**Note** – It is possible for another thread to create the same **POA** the **AdapterActivator** is being asked to create if **AdapterActivators** are used in conjunction with other threads calling **create\_POA** with the same **POA** name. Applications should be prepared to deal with failures from either the manual or automatic (**AdapterActivator**) **POA** creation request. There can be no guarantee of the order of such calls.

---

For example, if the target object reference was created by a **POA** whose full name is “A,” “B,” “C,” “D” and only **POAs** “A” and “B” currently exist, the **unknown\_adapter** operation will be invoked on the adapter activator associated with **POA** “B” passing **POA** “B” as the parent parameter and “C” as the name of the missing **POA**. Assuming that the adapter activator creates **POA** “C” and returns TRUE, the ORB will then invoke **unknown\_adapter** on the adapter activator associated with **POA** “C,” passing **POA** “C” as the parent parameter and “D” as the name.

The **unknown\_adapter** operation is also invoked when **find\_POA** is called on the **POA** with which the **AdapterActivator** is associated, the specified child does not exist, and the **activate\_it** parameter to **find\_POA** is TRUE. If **unknown\_adapter** creates the specified **POA** and returns TRUE, that **POA** is returned from **find\_POA**. If **unknown\_adapter** returns FALSE then **find\_POA** raises **AdapterNonExistent**. If **unknown\_adapter** raises any system exception then **find\_POA** passes through the system exception it gets back from **unknown\_adapter**.

---

**Note** – This allows the same code, the **unknown\_adapter** implementation, to be used to initialize a **POA** whether that **POA** is created explicitly by the application or as a side-effect of processing a request. Furthermore, it makes this initialization atomic with respect to delivery of requests to the **POA**.

---

### 11.3.5 *ServantManager Interface*

Servant managers are associated with POAs. A servant manager supplies a POA with the ability to activate objects on demand when the POA receives a request targeted at an inactive object. A servant manager is registered with a POA as a callback object, to be invoked by the POA when necessary. An application server that activates all its needed objects at the beginning of execution does not need to use a servant manager; it is used only for the case in which an object must be activated during request processing.

The **ServantManager** interface is itself empty. It is inherited by two other interfaces, **ServantActivator** and **ServantLocator**.

The two types of servant managers correspond to the POA's **RETAIN** policy (**ServantActivator**) and to the **NON\_RETAIN** policy (**ServantLocator**). The meaning of the policies and the operations that are available for POAs using each policy are listed under the two types of derived interfaces.

Each servant manager type contains two operations, the first called to find and return a servant and the second to deactivate a servant. The operations differ according to the amount of information usable for their situation.

**ServantManager** is a local interface. A **ServantManager** object must be local to the process containing the **POA** objects it is registered with.

#### 11.3.5.1 *Common Information for Servant Manager Types*

The two types of servant managers have certain semantics that are identical.

The **incarnate** and **preinvoke** operation may raise any system exception deemed appropriate (for example, **OBJECT\_NOT\_EXIST** if the object corresponding to the Object Id value has been destroyed).

---

**Note** – If a user-written routine (servant manager or method code) raises the **OBJECT\_NOT\_EXIST** exception, the POA does nothing but pass on that exception. It is the user's responsibility to deactivate the object if it had been previously activated.

---

The **incarnate** and **preinvoke** operation may also raise a **ForwardRequest** exception. If this occurs, the ORB is responsible for delivering the current request and subsequent requests to the object denoted in the **forward\_reference** member of the exception. The behavior of this mechanism must be the functional equivalent of the GIOP location forwarding mechanism. If the current request was delivered via an implementation of the GIOP protocol (such as IIOP), the reference in the exception

should be returned to the client in a reply message with **LOCATION\_FORWARD** reply status. If some other protocol or delivery mechanism was used, the ORB is responsible for providing equivalent behavior, from the perspectives of the client and the object denoted by the new reference.

If the **ForwardRequest** exception is raised anywhere else, it is passed through the ORB as a normal user exception.

If a **ServantManager** returns a null servant (or the equivalent in a language mapping) as the result of an **incarnate** or **preinvoke** operation, the **POA** returns the **OBJ\_ADAPTER** system exception with standard minor code 7 as the result of the request. If the **ServantManager** returns the wrong type of servant, it is indeterminate when that error is detected. An **ORB** that chooses to detect the error shall raise **OBJ\_ADAPTER** with standard minor code 2; an **ORB** that does not explicitly check for this error condition likely raises **BAD\_OPERATION** with standard minor code 2 or a **MARSHAL** exception (with unspecified minor code) at the time of method invocation.

### 11.3.6 *ServantActivator Interface*

When the POA has the **RETAIN** policy it uses servant managers that are **ServantActivators**. When using such servant managers, the following statements apply for a given **Objectid** used in the **incarnate** and **etherealize** operations:

- Servants incarnated by the servant manager will be placed in the Active Object Map with objects they have activated.
- Invocations of **incarnate** on the servant manager are serialized.
- Invocations of **etherealize** on the servant manager are serialized.
- Invocations of **incarnate** and **etherealize** on the servant manager are mutually exclusive.
- Incarnations of a particular object may not overlap; that is, **incarnate** shall not be invoked with a particular **Objectid** while, within the same POA, that **Objectid** is in use as the **Objectid** of an activated object or as the argument of a call to **incarnate** or **etherealize** that has not completed.

It should be noted that there may be a period of time between an object's deactivation and the etherealization (during which outstanding requests are being processed) in which arriving requests on that object should not be passed to its servant. During this period, requests targeted for such an object act as if the POA were in *holding* state until **etherealize** completes. If **etherealize** is called as a consequence of a **deactivate** call with an **etherealize\_objects** parameter of **TRUE**, incoming requests are rejected.

It should also be noted that a similar situation occurs with **incarnate**. There may be a period of time after the POA invokes **incarnate** and before that method returns in which arriving requests bound for that object should not be passed to the servant.

A single servant manager object may be concurrently registered with multiple POAs. Invocations of **incarnate** and **etherealize** on a servant manager in the context of different POAs are not necessarily serialized or mutually exclusive. There are no assumptions made about the thread in which **etherealize** is invoked.

### 11.3.6.1 *incarnate*

```
Servant incarnate (
 in ObjectId oid,
 in POA adapter)
 raises (ForwardRequest);
```

This operation is invoked by the POA whenever the POA receives a request for an object that is not currently active, assuming the POA has the **USE\_SERVANT\_MANAGER** and **RETAIN** policies.

The **oid** parameter contains the **ObjectId** value associated with the incoming request. The **adapter** is an object reference for the POA in which the object is being activated.

The user-supplied servant manager implementation is responsible for locating or creating an appropriate servant that corresponds to the **ObjectId** value if possible. **incarnate** returns a value of type **Servant**, which is the servant that will be used to process the incoming request (and potentially subsequent requests, since the POA has the **RETAIN** policy).

The POA enters the returned **Servant** value into the Active Object Map so that subsequent requests with the same **ObjectId** value will be delivered directly to that servant without invoking the servant manager.

If the **incarnate** operation returns a servant that is already active for a different Object Id and if the POA also has the **UNIQUE\_ID** policy, the **incarnate** has violated the POA policy and is considered to be in error. The POA will raise an **OBJ\_ADAPTER** system exception for the request. In this case, **etherealize** is not called by the POA because the servant was never added to the Active Object Map.

---

**Note** – If the same servant is used in two different POAs, it is legal for the POAs to use that servant even if the POAs have different Object Id uniqueness policies. The POAs do not interact with each other in this regard.

---

### 11.3.6.2 *etherealize*

```
void etherealize (
 in ObjectId oid,
 in POA adapter,
 in Servant serv,
 in boolean cleanup_in_progress,
 in boolean remaining_activations);
```

This operation is invoked whenever a servant for an object is deactivated, assuming the POA has the **USE\_SERVANT\_MANAGER** and **RETAIN** policies. Note that an active servant may be deactivated by the servant manager via **etherealize** even if it was not incarnated by the servant manager.



The **oid** parameter contains the Object Id value of the object being deactivated. The **adapter** parameter is an object reference for the **POA** in whose scope the object was active. The **serv** parameter contains a reference to the servant that is associated with the object being deactivated. If the servant denoted by the **serv** parameter is associated with other objects in the **POA** denoted by the **adapter** parameter (that is, in the **POA**'s Active Object Map) at the time that **etherealize** is called, the **remaining\_activations** parameter has the value **TRUE**. Otherwise, it has the value **FALSE**.

If the **cleanup\_in\_progress** parameter is **TRUE**, the reason for the **etherealize** operation is that either the **deactivate** or **destroy** operation was called with an **etherealize\_objects** parameter of **TRUE**. If the parameter is **FALSE**, the **etherealize** operation is called for other reasons.

Deactivation occurs in the following circumstances:

- When an object is deactivated explicitly by an invocation of **POA::deactivate\_object**.
- When the ORB or POA determines internally that an object must be deactivated. For example, an ORB implementation may provide policies that allow objects to be deactivated after some period of quiescence, or when the number of active objects reaches some limit.
- If **POAManager::deactivate** is invoked on a POA manager associated with a POA that has currently active objects.

Destroying a servant that is in the Active Object Map or is otherwise known to the POA can lead to undefined results.

In a multi-threaded environment, the **POA** makes certain guarantees that allow servant managers to safely destroy servants. Specifically, the servant's entry in the Active Object Map corresponding to the target object is removed before **etherealize** is called. Because calls to **incarnate** and **etherealize** are serialized, this prevents new requests for the target object from being invoked on the servant during etherealization. After removing the entry from the Active Object Map, if the **POA** determines before invoking **etherealize** that other requests for the same target object are already in progress on the servant, it delays the call to **etherealize** until all active methods for the target object have completed. Therefore, when **etherealize** is called, the servant manager can safely destroy the servant if it wants to, unless the **remaining\_activations** argument is **TRUE**.

If the **etherealize** operation returns a system exception, the **POA** ignores the exception.

### *11.3.7 ServantLocator Interface*

When the **POA** has the **NON\_RETAIN** policy it uses servant managers that are **ServantLocators**. Because the **POA** knows that the servant returned by this servant manager will be used only for a single request, it can supply extra information to the servant manager's operations and the servant manager's pair of operations may be able to cooperate to do something different than a **ServantActivator**.

**ServantLocator** is a local interface. A **ServantLocator** object must be local to the process containing the **POA** objects it is registered with.

When the **POA** uses the **ServantLocator** interface, immediately after performing the operation invocation on the servant returned by **preinvoke**, the **POA** will invoke **postinvoke** on the servant manager, passing the **Objectld** value and the **Servant** value as parameters (among others). The next request with this **Objectld** value will then cause **preinvoke** to be invoked again. This feature may be used to force every request for objects associated with a **POA** to be mediated by the servant manager.

When using such a **ServantLocator**, the following statements apply for a given **Objectld** used in the **preinvoke** and **postinvoke** operations:

- The servant returned by **preinvoke** is used only to process the single request that caused **preinvoke** to be invoked.
- No servant incarnated by the servant manager will be placed in the Active Object Map.
- When the invocation of the request on the servant is complete, **postinvoke** will be invoked for the object.
- No serialization of invocations of **preinvoke** or **postinvoke** may be assumed; there may be multiple concurrent invocations of **preinvoke** for the same **Objectld**. (However, if the **SINGLE\_THREAD\_MODEL** policy is being used, that policy will serialize these calls.)
- The same thread will be used to **preinvoke** the object, process the request, and **postinvoke** the object.
- If **preinvoke** raises an exception, **postinvoke** is not called. Otherwise the **preinvoke** and **postinvoke** operations are always called in pairs in response to any ORB activity. In particular, for a response to a **GIOP Locate** message a **GIOP**-conforming ORB may (or may not) call **preinvoke** to determine whether the object could be served at this location. If the ORB makes such a call, whatever the result, the ORB does not invoke a method, but does call **postinvoke** before responding to the **Locate** message.

---

Note – The **ServantActivator** interface does not behave similarly with respect to a **GIOP Locate** message since the etherealize operation is not associated with request processing.

---

### 11.3.7.1 *preinvoke*

```
Servant preinvoke(
 in Objectld oid,
 in POA adapter,
 in CORBA::Identifier operation,
 out Cookie the_cookie)
 raises (ForwardRequest
);
```

This operation is invoked by the POA whenever the POA receives a request for an object that is not currently active, assuming the POA has the **USE\_SERVANT\_MANAGER** and **NON\_RETAIN** policies.

The **oid** parameter contains the **ObjectId** value associated with the incoming request. The **adapter** is an object reference for the POA in which the object is being activated.

The user-supplied servant manager implementation is responsible for locating or creating an appropriate servant that corresponds to the **ObjectId** value if possible. **preinvoke** returns a value of type **Servant**, which is the servant that will be used to process the incoming request.

The **Cookie** is a type opaque to the **POA** that can be set by the servant manager for use later by **postinvoke**. The operation is the name of the operation that will be called by the **POA** when the servant is returned.

### 11.3.7.2 *postinvoke*

```
void postinvoke(
 in ObjectId oid,
 in POA adapter,
 in CORBA::Identifier operation,
 in Cookie the_cookie,
 in Servant the_servant
);
```

This operation is invoked whenever a servant completes a request, assuming the POA has the **USE\_SERVANT\_MANAGER** and **NON\_RETAIN** policies.

The **postinvoke** operation is considered to be part of a request on an object. That is, the request is not complete until **postinvoke** finishes. If the method finishes normally but **postinvoke** raises a system exception, the method's normal return is overridden; the request completes with the exception.

The **oid** parameter contains the Object Id value of the object on which the request was made. The **adapter** parameter is an object reference for the POA in whose scope the object was active. The **the\_servant** parameter contains a reference to the servant that is associated with the object.

The **Cookie** is a type opaque to the **POA**; it contains any value that was set by the **preinvoke** operation. The operation is the name of the operation that was called by the **POA** for the request.

Destroying a servant that is known to the **POA** can lead to undefined results.

### 11.3.7.3 *ServantLocator and Location Determination*

Under certain circumstances, an ORB may need to determine the actual location of an object's implementation. For objects that are managed by a POA that is configured with a **ServantLocator**, it may invoke **preinvoke** and **postinvoke** or it may determine the object's location by some other means. If it invokes **preinvoke** and **postinvoke** under these circumstances it shall use the argument “**\_locate**.”

### 11.3.8 POA Policy Objects

Interfaces derived from **CORBA::Policy** are used with the **POA::create\_POA** operation to specify policies that apply to a POA. Policy objects are created using factory operations on any pre-existing POA, such as the root POA, or by a call to **ORB::create\_policy**. Policy objects are specified when a POA is created. Policies may not be changed on an existing POA. Policies are not inherited from the parent POA. All **Policy** interfaces defined in this section are local interfaces.

The POA shall preserve Policies whose types have been registered via **PortableInterceptor::ORBInitInfo::register\_policy\_factory**, even if the POA itself does not know about those policies.

#### 11.3.8.1 Thread Policy

Objects with the **ThreadPolicy** interface are obtained using the **POA::create\_thread\_policy** operation and passed to the **POA::create\_POA** operation to specify the threading model used with the created POA. The value attribute of **ThreadPolicy** contains the value supplied to the **POA::create\_thread\_policy** operation from which it was obtained. The following values can be supplied.

- **ORB\_CTRL\_MODEL** - The ORB is responsible for assigning requests for an ORB-controlled POA to threads. In a multi-threaded environment, concurrent requests may be delivered using multiple threads.
- **SINGLE\_THREAD\_MODEL** - Requests for a single-threaded POA are processed sequentially. In a multi-threaded environment, all upcalls made by this POA to implementation code (servants and servant managers) are made in a manner that is safe for code that is multi-thread-unaware. The POA will still allow reentrant calls from an object implementation to itself, or to another object implementation managed by the same POA.
- **MAIN\_THREAD\_MODEL** - Requests for all main-thread POAs are processed sequentially. In a multi-threaded environment, all upcalls made by all POAs with this policy to servants are made in a manner that is safe for code that is multi-thread-unaware. If the environment has special requirements that some code must run on a distinguished “main” thread, servant upcalls will be processed on that thread. (See Section 4.2.5, “Thread-Related Operations,” on page 4-9.)

If no **ThreadPolicy** object is passed to **create\_POA**, the thread policy defaults to **ORB\_CTRL\_MODEL**.

---

**Note** – In some environments, calling multi-thread-unaware code safely (that is, using the **MAIN\_THREAD\_MODEL**) may mean that the POA will use only the main thread, in which case the application programmer is responsible to ensure that the main thread is given to the ORB, using **ORB::perform\_work** or **ORB::run**.

POAs using the **SINGLE\_THREAD\_MODEL** may need to cooperate to ensure that calls are safe even when implementation code (such as a servant manager) is shared by multiple single-threaded POAs.

These models presume that the ORB and the application are using compatible threading primitives in a multi-threaded environment.

---

### 11.3.8.2 *Lifespan Policy*

Objects with the **LifespanPolicy** interface are obtained using the **POA::create\_lifespan\_policy** operation and passed to the **POA::create\_POA** operation to specify the lifespan of the objects implemented in the created POA. The following values can be supplied.

- **TRANSIENT** - The objects implemented in the **POA** cannot outlive the **POA** instance in which they are first created. Once the POA's **POAManager** enters the deactivated state, any requests received by this **POA** will cause the **POA** to raise an **OBJECT\_NOT\_EXIST** system exception with standard minor code 4.
- **PERSISTENT** - The objects implemented in the **POA** can outlive the process in which they are first created.
  - Persistent objects have a **POA** associated with them (the **POA** that created them). When the ORB receives a request on a persistent object, it first searches for the matching **POA**, based on the names of the **POA** and all of its ancestors.
  - Administrative action beyond the scope of this specification may be necessary to inform the ORB's location service of the creation and eventual termination of existence of this **POA**, and optionally to arrange for on-demand activation of a process implementing this **POA**.
  - **POA** names must be unique within their enclosing scope (the parent **POA**). A portable program can assume that **POA** names used in other processes will not conflict with its own **POA** names. A conforming CORBA implementation will provide a method for ensuring this property.

If no **LifespanPolicy** object is passed to **create\_POA**, the lifespan policy defaults to **TRANSIENT**.

### 11.3.8.3 *Object Id Uniqueness Policy*

Objects with the **IdUniquenessPolicy** interface are obtained using the **POA::create\_id\_uniqueness\_policy** operation and passed to the **POA::create\_POA** operation to specify whether the servants activated in the created **POA** must have unique object identities. The following values can be supplied.

- **UNIQUE\_ID** - Servants activated with that POA support exactly one Object Id.
- **MULTIPLE\_ID** - a servant activated with that POA may support one or more Object Ids.

If no **IdUniquenessPolicy** is specified at POA creation, the default is **UNIQUE\_ID**.

---

**Note** – Use of **UNIQUE\_ID** policy is meaningless in conjunction with **NON\_RETAIN** policy. A conforming application should not use this policy combination. A conforming orb may, but need not, report an error during **create\_POA** if this combination is used. If an orb permits this combination of policies to be used, the resulting **POA** shall not treat the use of the same servant for concurrent requests on different object ids as an error.

---

#### 11.3.8.4 *Id Assignment Policy*

Objects with the **IdAssignmentPolicy** interface are obtained using the **POA::create\_id\_assignment\_policy** operation and passed to the **POA::create\_POA** operation to specify whether Object Ids in the created **POA** are generated by the application or by the ORB. The following values can be supplied.

- **USER\_ID** - Objects created with that **POA** are assigned Object Ids only by the application.
- **SYSTEM\_ID** - Objects created with that **POA** are assigned Object Ids only by the **POA**. If the **POA** also has the **PERSISTENT** policy, assigned Object Ids must be unique across all instantiations of the same **POA**.

If no **IdAssignmentPolicy** is specified at **POA** creation, the default is **SYSTEM\_ID**.

#### 11.3.8.5 *Servant Retention Policy*

Objects with the **ServantRetentionPolicy** interface are obtained using the **POA::create\_servant\_retention\_policy** operation and passed to the **POA::create\_POA** operation to specify whether the created **POA** retains active servants in an Active Object Map. The following values can be supplied.

- **RETAIN** - The **POA** will retain active servants in its Active Object Map.
- **NON\_RETAIN** - Servants are not retained by the **POA**.

If no **ServantRetentionPolicy** is specified at **POA** creation, the default is **RETAIN**.

---

**Note** – The **NON\_RETAIN** policy requires either the **USE\_DEFAULT\_SERVANT** or **USE\_SERVANT\_MANAGER** policies.

---

#### 11.3.8.6 *Request Processing Policy*

Objects with the **RequestProcessingPolicy** interface are obtained using the **POA::create\_request\_processing\_policy** operation and passed to the **POA::create\_POA** operation to specify how requests are processed by the created **POA**. The following values can be supplied.

- **USE\_ACTIVE\_OBJECT\_MAP\_ONLY** - If the Object Id is not found in the Active Object Map, an **OBJECT\_NOT\_EXIST** system exception with standard minor code 2 is returned to the client. The **RETAIN** policy is also required.

- **USE\_DEFAULT\_SERVANT** - If the Object Id is not found in the Active Object Map or the **NON\_RETAIN** policy is present, and a default servant has been registered with the **POA** using the **set\_servant** operation, the request is dispatched to the default servant. If no default servant has been registered, an **OBJ\_ADAPTER** system exception with standard minor code 3 is returned to the client. The **MULTIPLE\_ID** policy is also required.
- **USE\_SERVANT\_MANAGER** - If the Object Id is not found in the Active Object Map or the **NON\_RETAIN** policy is present, and a servant manager has been registered with the **POA** using the **set\_servant\_manager** operation, the servant manager is given the opportunity to locate a servant or raise an exception. If no servant manager has been registered, an **OBJ\_ADAPTER** system exception with standard minor code 4 is returned to the client.

If no **RequestProcessingPolicy** is specified at **POA** creation, the default is **USE\_ACTIVE\_OBJECT\_MAP\_ONLY**.

By means of combining the **USE\_ACTIVE\_OBJECT\_MAP\_ONLY** / **USE\_DEFAULT\_SERVANT** / **USE\_SERVANT\_MANAGER** policies and the **RETAIN** / **NON\_RETAIN** policies, the programmer is able to define a rich number of possible behaviors.

#### *RETAIN and USE\_ACTIVE\_OBJECT\_MAP\_ONLY*

This combination represents the situation where the **POA** does no automatic object activation (that is, the **POA** searches only the Active Object Map).

#### *RETAIN and USE\_SERVANT\_MANAGER*

This combination represents a very common situation, where there is an Active Object Map and a **ServantManager**.

Because **RETAIN** is in effect, the application can call **activate\_object** or **activate\_object\_with\_id** to establish known servants in the Active Object Map for use in later requests.

If the **POA** doesn't find a servant in the Active Object Map for a given object, it tries to determine the servant by means of invoking **incarnate** in the **ServantManager** (specifically a **ServantActivator**) registered with the **POA**. If no **ServantManager** is available, the **POA** raises the **OBJ\_ADAPTER** system exception with standard minor code 4.

#### *RETAIN and USE\_DEFAULT\_SERVANT*

This combination represents the situation where there is a default servant defined for all requests involving unknown objects.

Because **RETAIN** is in effect, the application can call **activate\_object** or **activate\_object\_with\_id** to establish known servants in the Active Object Map for use in later requests.

The **POA** first tries to find a servant in the Active Object Map for a given object. If it does not find such a servant, it uses the default servant. If no default servant is available, the **POA** raises the **OBJ\_ADAPTER** system exception with standard minor code 3.

#### *NON-RETAIN and USE\_SERVANT\_MANAGER*

This combination represents the situation where one servant is used per method call.

The **POA** doesn't try to find a servant in the Active Object Map because the **ActiveObjectMap** does not exist. In every request, it will call preinvoke on the **ServantManager** (specifically a **ServantLocator**) registered with the **POA**. If no **ServantManager** is available, the **POA** will raise the **OBJ\_ADAPTER** system exception.

#### *NON-RETAIN and USE\_DEFAULT\_SERVANT*

This combination represents the situation where there is one single servant defined for all CORBA objects.

The **POA** does not try to find a servant in the Active Object Map because the **ActiveObjectMap** doesn't exist. In every request, the **POA** will invoke the appropriate operation on the default servant registered with the **POA**. If no default servant is available, the **POA** will raise the **OBJ\_ADAPTER** system exception.

### *11.3.8.7 Implicit Activation Policy*

Objects with the **ImplicitActivationPolicy** interface are obtained using the **POA::create\_implicit\_activation\_policy** operation and passed to the **POA::create\_POA** operation to specify whether implicit activation of servants is supported in the created POA. The following values can be supplied.

- **IMPLICIT\_ACTIVATION** - the POA will support implicit activation of servants. **IMPLICIT\_ACTIVATION** also requires the **SYSTEM\_ID** and **RETAIN** policies.
- **NO\_IMPLICIT\_ACTIVATION** - the POA will not support implicit activation of servants.

If no **ImplicitActivationPolicy** is specified at POA creation, the default is **NO\_IMPLICIT\_ACTIVATION**.

### *11.3.9 POA Interface*

A POA object manages the implementation of a collection of objects. The POA supports a name space for the objects, which are identified by Object Ids.

A POA also provides a name space for POAs. A POA is created as a child of an existing POA, which forms a hierarchy starting with the root POA.

The **POA** interface is a local interface.



### 11.3.9.1 *create\_POA*

```

POA create_POA(
 in string adapter_name,
 in POAManager a_POAManager,
 in CORBA::PolicyList policies)
 raises (AdapterAlreadyExists, InvalidPolicy
);

```

This operation creates a new POA as a child of the target POA. The specified name identifies the new POA with respect to other POAs with the same parent POA. If the target POA already has a child POA with the specified name, the **AdapterAlreadyExists** exception is raised.

If the **a\_POAManager** parameter is null, a new **POAManager** object is created and associated with the new POA. Otherwise, the specified **POAManager** object is associated with the new POA. The **POAManager** object can be obtained using the attribute name **the\_POAManager**.

The specified policy objects are associated with the POA and used to control its behavior. The policy objects are effectively copied before this operation returns, so the application is free to destroy them while the POA is in use. Policies are *not* inherited from the parent POA.

The POA shall preserve Policies whose types have been registered via **PortableInterceptor::ORBInitInfo::register\_policy\_factory**, even if the POA itself does not know about those policies.

If any of the policy objects specified are not valid for the ORB implementation, if conflicting policy objects are specified, or if any of the specified policy objects require prior administrative action that has not been performed, an **InvalidPolicy** exception is raised containing the index in the policies parameter value of the first offending policy object.

---

**Note** – Creating a POA using a POA manager that is in the active state can lead to race conditions if the POA supports preexisting objects, because the new POA may receive a request before its adapter activator, servant manager, or default servant have been initialized. These problems do not occur if the POA is created by an adapter activator registered with a parent of the new POA, because requests are queued until the adapter activator returns. To avoid these problems when a POA must be explicitly initialized, the application can initialize the POA by invoking **find\_POA** with a **TRUE** activate parameter.

---

### 11.3.9.2 *find\_POA*

```

POA find_POA(
 in string adapter_name,
 in boolean activate_it)

```

```

 raises (AdapterNonExistent
);

```

If the target **POA** is the parent of a child **POA** with the specified name (relative to the target **POA**), that child **POA** is returned. If a child **POA** with the specified name does not exist and the value of the **activate\_it** parameter is **TRUE**, the target **POA**'s **AdapterActivator**, if one exists, is invoked, and, if it successfully activates the child **POA**, that child **POA** is returned. Otherwise, the **AdapterNonExistent** exception is raised.

If **find\_POA** receives a system exception in response to a call to **unknown\_adapter** on a **POA**, **find\_POA** raises **OBJ\_ADAPTER** system exception with standard minor code 1

### 11.3.9.3 *destroy*

```

void destroy(
 in boolean etherealize_objects,
 in boolean wait_for_completion
);

```

This operation destroys the **POA** and all descendant **POAs**. All descendant **POAs** are destroyed (recursively) before the destruction of the containing **POA**. The **POA** so destroyed (that is, the **POA** with its name) may be re-created later in the same process. (This differs from the **POAManager::deactivate** operation that does not allow a re-creation of its associated **POA** in the same process. After a deactivate, re-creation is allowed only if the **POA** is later destroyed.)

When **destroy** is called the **POA** behaves as follows:

- The **POA** assumes the *discarding* state except when its **POAManager** is in the *inactive* state in which case the **POA** assumes the *inactive* state. Any further changes to the **POAManager**'s state do not affect this **POA**.
- The **POA** disables the **create\_POA** operation. Subsequent calls to **create\_POA** will result in a **BAD\_INV\_ORDER** system exception with standard minor code 17.
- The **POA** calls **destroy** on all of its immediate descendants.
- After all descendant **POAs** have been destroyed and their servants etherealized, the **POA** continues to process requests until there are no requests executing in the **POA**. At this point, apparent destruction of the **POA** has occurred.
- After destruction has become apparent, the **POA** may be re-created via either an **AdapterActivator** or a call to **create\_POA**.
- If the **etherealize\_objects** parameter is **TRUE**, the **POA** has the **RETAIN** policy, and a servant manager is registered with the **POA**, the **etherealize** operation on the servant manager is called for each *active* object in the *Active Object Map*. The apparent destruction of the **POA** occurs before any calls to **etherealize** are made. Thus, for example, an **etherealize** method that attempts to invoke operations on the **POA** receives the **OBJECT\_NOT\_EXIST** exception.

- If the **POA** has an **AdapterActivator** installed, any requests that would have caused **unknown\_adapter** to be called cause a **TRANSIENT** exception with standard minor code 4 to be raised instead.

The **wait\_for\_completion** parameter is handled as follows:

- If **wait\_for\_completion** is **TRUE** and the current thread is not in an invocation context dispatched from some **POA** belonging to the same ORB as this **POA**, the destroy operation returns only after all active requests have completed and all invocations of **etherealize** have completed.
- If **wait\_for\_completion** is **TRUE** and the current thread is in an invocation context dispatched from some **POA** belonging to the same ORB as this **POA**, the **BAD\_INV\_ORDER** system exception with standard minor code 3 is raised and **POA** destruction does not occur.
- If **wait\_for\_completion** is **FALSE**, the **destroy** operation destroys the **POA** and its children but waits neither for active requests to complete nor for etherealization to occur. If **destroy** is called multiple times before destruction is complete (because there are active requests), the **etherealize\_objects** parameter applies only to the first call of **destroy**. Subsequent calls with conflicting **etherealize\_objects** settings use the value of **etherealize\_objects** from the first call. The **wait\_for\_completion** parameter is handled as defined above for each individual call (some callers may choose to block, while others may not).

#### 11.3.9.4 Policy Creation Operations

```

ThreadPolicy create_thread_policy(
 in ThreadPolicyValue value);
LifespanPolicy create_lifespan_policy(
 in LifespanPolicyValue value);
IdUniquenessPolicy create_id_uniqueness_policy(
 in IdUniquenessPolicyValue value);
IdAssignmentPolicy create_id_assignment_policy(
 in IdAssignmentPolicyValue value);
ImplicitActivationPolicy create_implicit_activation_policy(
 in ImplicitActivationPolicyValue value);
ServantRetentionPolicy create_servant_retention_policy(
 in ServantRetentionPolicyValue value);
RequestProcessingPolicy create_request_processing_policy(
 in RequestProcessingPolicyValue value);

```

These operations each return a reference to a policy object with the specified value. The application is responsible for calling the inherited **destroy** operation on the returned reference when it is no longer needed.

#### 11.3.9.5 *the\_name*

```
readonly attribute string the_name;
```

This attribute identifies the POA relative to its parent. This name is assigned when the POA is created. The name of the root POA is system-dependent and should not be relied upon by the application. In order to work properly with Portable Interceptors (see Section 21.5.2.1, “Adapter Names,” on page 21-41 ) the name of the root POA must be the sequence containing only the string “RootPOA.”

#### *11.3.9.6 the\_parent*

**readonly attribute POA the\_parent;**

This attribute identifies the parent of the POA. The parent of the root POA is null.

#### *11.3.9.7 the\_children*

**readonly attribute POAList the\_children;**

This attribute identifies the current set of all child POAs of the POA. The set of child POAs includes only the POA's immediate children, and not their descendants.

#### *11.3.9.8 the\_POAManager*

**readonly attribute POAManager the\_POAManager;**

This attribute identifies the POA manager associated with the POA.

#### *11.3.9.9 the\_activator*

**attribute AdapterActivator the\_activator;**

This attribute identifies the adapter activator associated with the POA. A newly created POA has no adapter activator (the attribute is null). It is system-dependent whether the root POA initially has an adapter activator; the application is free to assign its own adapter activator to the root POA.

#### *11.3.9.10 the\_POAManagerFactory*

**readonly attribute POAManagerFactory the\_POAManagerFactory;**

This attribute returns the **POAManagerFactory** that created the **POA**.

#### *11.3.9.11 get\_servant\_manager*

**ServantManager get\_servant\_manager()  
raises(WrongPolicy);**

This operation requires the **USE\_SERVANT\_MANAGER** policy; if not present, the **WrongPolicy** exception is raised.

This operation returns the servant manager associated with the POA. If no servant manager has been associated with the POA, it returns a null reference.

#### 11.3.9.12 *set\_servant\_manager*

```
void set_servant_manager(
 in ServantManager imgr
) raises(WrongPolicy);
```

This operation requires the **USE\_SERVANT\_MANAGER** policy; if not present, the **WrongPolicy** exception is raised.

If the **ServantRetentionPolicy** of the **POA** is **RETAIN**, then the **ServantManager** argument (**imgr**) shall support the **ServantActivator** interface (e.g., in C++ **imgr** is narrowable to **ServantActivator**). If the **ServantRetentionPolicy** of the **POA** is **NON\_RETAIN**, then the **ServantManager** argument shall support the **ServantLocator** interface. If the argument is **nil**, or does not support the required interface, then the **OBJ\_ADAPTER** system exception with standard minor code 4 is raised.

This operation sets the default servant manager associated with the POA. This operation may only be invoked once after a POA has been created. Attempting to set the servant manager after one has already been set will result in the **BAD\_INV\_ORDER** system exception with standard minor code 6 being raised.

#### 11.3.9.13 *get\_servant*

```
Servant get_servant()
 raises(NoServant, WrongPolicy);
```

This operation requires the **USE\_DEFAULT\_SERVANT** policy; if not present, the **WrongPolicy** exception is raised.

This operation returns the default servant associated with the POA. If no servant has been associated with the POA, the **NoServant** exception is raised.

#### 11.3.9.14 *set\_servant*

```
void set_servant(
 in Servant p_servan
) raises(WrongPolicy);
```

This operation requires the **USE\_DEFAULT\_SERVANT** policy; if not present, the **WrongPolicy** exception is raised.

This operation registers the specified servant with the POA as the default servant. This servant will be used for all requests for which no servant is found in the Active Object Map.

### 11.3.9.15 *activate\_object*

**ObjectId activate\_object(  
in Servant p\_servant  
) raises (ServantAlreadyActive, WrongPolicy);**

This operation requires the **SYSTEM\_ID** and **RETAIN** policy; if not present, the **WrongPolicy** exception is raised.

If the POA has the **UNIQUE\_ID** policy and the specified servant is already in the Active Object Map, the **ServantAlreadyActive** exception is raised. Otherwise, the **activate\_object** operation generates an Object Id and enters the Object Id and the specified servant in the Active Object Map. The Object Id is returned.

### 11.3.9.16 *activate\_object\_with\_id*

**void activate\_object\_with\_id(  
in ObjectId oid,  
in Servant p\_servant  
) raises (ObjectAlreadyActive, ServantAlreadyActive, WrongPolicy);**

This operation requires the **RETAIN** policy; if not present, the **WrongPolicy** exception is raised.

If the CORBA object denoted by the Object Id value is already active in this POA (there is a servant bound to it in the Active Object Map), the **ObjectAlreadyActive** exception is raised. If the POA has the **UNIQUE\_ID** policy and the servant is already in the Active Object Map, the **ServantAlreadyActive** exception is raised. Otherwise, the **activate\_object\_with\_id** operation enters an association between the specified Object Id and the specified servant in the Active Object Map.

If the **POA** has the **SYSTEM\_ID** policy and it detects that the Object Id value was not generated by the system or for this **POA**, the **activate\_object\_with\_id** operation may raise the **BAD\_PARAM** system exception. An ORB is not required to detect all such invalid Object Id values, but a portable application must not invoke **activate\_object\_with\_id** on a **POA** that has the **SYSTEM\_ID** policy with an Object Id value that was not previously generated by the system for that **POA**, or, if the **POA** also has the **PERSISTENT** policy, for a previous instantiation of the same **POA**. A **POA** is not required to raise the **BAD\_PARAM** exception in this case because, in the general case, accurate rejection of an invalid Object Id requires unbounded persistent memory of all previously generated Id values.

### 11.3.9.17 *deactivate\_object*

**void deactivate\_object(  
in ObjectId oid  
) raises (ObjectNotActive, WrongPolicy);**

This operation requires the **RETAIN** policy; if not present, the **WrongPolicy** exception is raised.

This operation causes the **Objectld** specified in the **oid** parameter to be deactivated. An **Objectld** that has been deactivated continues to process requests until there are no active requests for that **Objectld**. Active requests are those requests that arrived before **deactivate\_object** was called. A deactivated **Objectld** is removed from the Active Object Map when all requests executing for that **Objectld** have completed. If a servant manager is associated with the **POA**, **ServantActivator::etherealize** is invoked with the **oid** and the associated servant after the **Objectld** has been removed from the Active Object Map. Reactivation for the **Objectld** blocks until etherealization (if necessary) is complete. This includes implicit activation (as described in **etherealize**) and explicit activation via **POA::activate\_object\_with\_id**. Once an **Objectld** has been removed from the Active Object Map and etherealized (if necessary) it may then be reactivated through the usual mechanisms.

The operation does not wait for requests or etherealization to complete and always returns immediately after deactivating the **Objectld**.

---

**Note** – If the servant associated with the **oid** is serving multiple Object Ids, **ServantActivator::etherealize** may be invoked multiple times with the same servant when the other objects are deactivated. It is the responsibility of the object implementation to refrain from destroying the servant while it is active with any Id.

---

#### 11.3.9.18 *create\_reference*

**Object create\_reference (**  
     **in CORBA::RepositoryId intf**  
**) raises (WrongPolicy);**

This operation requires the **SYSTEM\_ID** policy; if not present, the **WrongPolicy** exception is raised.

This operation creates an object reference that encapsulates a POA-generated Object Id value and the specified interface repository id. The specified repository id, which may be a null string, will become the **type\_id** of the generated object reference. A repository id that does not identify the most derived interface of the object or one of its base interfaces will result in undefined behavior.

This operation does not cause an activation to take place. The resulting reference may be passed to clients, so that subsequent requests on those references will cause the appropriate servant manager to be invoked, if one is available. The generated Object Id value may be obtained by invoking **POA::reference\_to\_id** with the created reference.

#### 11.3.9.19 *create\_reference\_with\_id*

**Object create\_reference\_with\_id (**  
     **in Objectld                    oid,**  
     **in CORBA::RepositoryId intf**  
**);**

This operation creates an object reference that encapsulates the specified Object Id and interface repository Id values. The specified repository id, which may be a null string, will become the **type\_id** of the generated object reference. A repository id that does not identify the most derived interface of the object or one of its base interfaces will result in undefined behavior.

This operation does not cause an activation to take place. The resulting reference may be passed to clients, so that subsequent requests on those references will cause the object to be activated if necessary, or the default servant used, depending on the applicable policies.

If the **POA** has the **SYSTEM\_ID** policy and it detects that the Object Id value was not generated by the system or for this POA, the **create\_reference\_with\_id** operation may raise the **BAD\_PARAM** system exception with standard minor code 14. An ORB is not required to detect all such invalid Object Id values, but a portable application must not invoke this operation on a POA that has the **SYSTEM\_ID** policy with an Object Id value that was not previously generated by the system for that **POA**, or, if the **POA** also has the **PERSISTENT** policy, for a previous instantiation of the same **POA**.

#### 11.3.9.20 *servant\_to\_id*

**ObjectId servant\_to\_id(  
    in Servant                    p\_servant  
) raises (ServantNotActive, WrongPolicy);**

This operation requires the **USE\_DEFAULT\_SERVANT** policy or a combination of the **RETAIN** policy and either the **UNIQUE\_ID** or **IMPLICIT\_ACTIVATION** policies if invoked outside the context of an operation dispatched by this POA. If this operation is not invoked in the context of executing a request on the specified servant and the policies specified previously are not present, the **WrongPolicy** exception is raised.

This operation has four possible behaviors.

1. If the **POA** has both the **RETAIN** and the **UNIQUE\_ID** policy and the specified servant is active, the Object Id associated with that servant is returned.
2. If the **POA** has both the **RETAIN** and the **IMPLICIT\_ACTIVATION** policy and either the POA has the **MULTIPLE\_ID** policy or the specified servant is not active, the servant is activated using a POA-generated Object Id and the Interface Id associated with the servant, and that Object Id is returned.
3. If the **POA** has the **USE\_DEFAULT\_SERVANT** policy, the servant specified is the default servant, and the operation is being invoked in the context of executing a request on the default servant, then the ObjectId associated with the current invocation is returned.
4. Otherwise, the **ServantNotActive** exception is raised.



### 11.3.9.21 *servant\_to\_reference*

**Object servant\_to\_reference (**  
**in Servant                      p\_servant**  
**) raises (ServantNotActive, WrongPolicy);**

This operation requires the **RETAIN** policy and either the **UNIQUE\_ID** or **IMPLICIT\_ACTIVATION** policies if invoked outside the context of an operation dispatched by this POA. If this operation is not invoked in the context of executing a request on the specified servant and the policies specified previously are not present the **WrongPolicy** exception is raised.

This operation has four possible behaviors.

1. If the POA has both the **RETAIN** and the **UNIQUE\_ID** policy and the specified servant is active, an object reference encapsulating the information used to activate the servant is returned.
2. If the POA has both the **RETAIN** and the **IMPLICIT\_ACTIVATION** policy and either the POA has the **MULTIPLE\_ID** policy or the specified servant is not active, the servant is activated using a POA-generated Object Id and the Interface Id associated with the servant, and a corresponding object reference is returned.
3. If the operation was invoked in the context of executing a request on the specified servant, the reference associated with the current invocation is returned.
4. Otherwise, the **ServantNotActive** exception is raised.

---

**Note** – The allocation of an Object Id value and installation in the Active Object Map caused by implicit activation may actually be deferred until an attempt is made to externalize the reference. The real requirement here is that a reference is produced that will behave appropriately (that is, yield a consistent Object Id value when asked politely).

---

### 11.3.9.22 *reference\_to\_servant*

**Servant reference\_to\_servant (**  
**in Object                      reference**  
**) raises (ObjectNotActive, WrongAdapter, WrongPolicy);**

This operation requires the **RETAIN** policy or the **USE\_DEFAULT\_SERVANT** policy. If neither policy is present, the **WrongPolicy** exception is raised.

If the POA has the **RETAIN** policy and the specified object is present in the Active Object Map, this operation returns the servant associated with that object in the Active Object Map. Otherwise, if the POA has the **USE\_DEFAULT\_SERVANT** policy and a default servant has been registered with the POA, this operation returns the default servant. Otherwise, the **ObjectNotActive** exception is raised.

If the object reference was not created by this POA, the **WrongAdapter** exception is raised.

### 11.3.9.23 *reference\_to\_id*

**ObjectId reference\_to\_id(  
    in Object                   reference  
) raises (WrongAdapter, WrongPolicy);**

The WrongPolicy exception is declared to allow future extensions.

This operation returns the Object Id value encapsulated by the specified **reference**. This operation is valid only if the reference was created by the POA on which the operation is being performed. If the reference was not created by that POA, a WrongAdapter exception is raised. The object denoted by the reference does not have to be active for this operation to succeed.

### 11.3.9.24 *id\_to\_servant*

**Servant id\_to\_servant(  
    in ObjectId                   oid  
) raises (ObjectNotActive, WrongPolicy);**

This operation requires the **RETAIN** policy or the **USE\_DEFAULT\_SERVANT** policy. If neither policy is present, the WrongPolicy exception is raised.

If the POA has the **RETAIN** policy and the specified **ObjectId** is in the Active Object Map, this operation returns the servant associated with that object in the Active Object Map. Otherwise, if the POA has the **USE\_DEFAULT\_SERVANT** policy and a default servant has been registered with the POA, this operation returns the default servant. Otherwise the **ObjectNotActive** exception is raised.

### 11.3.9.25 *id\_to\_reference*

**Object id\_to\_reference(  
    in ObjectId                   oid  
) raises (ObjectNotActive, WrongPolicy);**

This operation requires the **RETAIN** policy; if not present, the WrongPolicy exception is raised.

If an object with the specified Object Id value is currently active, a reference encapsulating the information used to activate the object is returned. If the Object Id value is not active in the POA, an **ObjectNotActive** exception is raised.

### 11.3.9.26 *id*

**readonly attribute CORBA::OctetSeq id;**

This returns the unique id of the POA in the process in which it is created. It is for use by portable interceptors.

This id is guaranteed unique for the life span of the POA in the process. For persistent POAs, this means that if a POA is created in the same path with the same name as another POA, these POAs are identical and, therefore, have the same id. For transient POAs, each POA is unique.

### 11.3.10 Current Operations

The **PortableServer::Current** interface, derived from **CORBA::Current**, provides method implementations with access to the identity of the object on which the method was invoked. The **Current** interface is provided to support servants that implement multiple objects, but can be used within the context of POA-dispatched method invocations on any servant. To provide location transparency, ORBs are required to support use of **Current** in the context of both locally and remotely invoked operations.

An instance of **Current** can be obtained by the application by issuing the **CORBA::ORB::resolve\_initial\_references("POACurrent")** operation. Thereafter, it can be used within the context of a method dispatched by the **POA** to obtain the **POA** and **Objectld** that identify the object on which that operation was invoked.

**PortableServer::Current** is a local interface.

#### 11.3.10.1 *get\_POA*

**POA get\_POA()**  
**raises (NoContext);**

This operation returns a reference to the POA implementing the object in whose context it is called. If called outside the context of a POA-dispatched operation, a **NoContext** exception is raised.

#### 11.3.10.2 *get\_object\_id*

**Objectld get\_object\_id()**  
**raises (NoContext);**

This operation returns the **Objectld** identifying the object in whose context it is called. If called outside the context of a POA-dispatched operation, a **NoContext** exception is raised.

#### 11.3.10.3 *get\_reference*

**Object get\_reference()**  
**raises(NoContext);**

This operation returns a locally manufactured reference to the object in the context of which it is called. If called outside the context of a POA dispatched operation, a **NoContext** exception is raised.

**Note** – This reference is not guaranteed to be identical to the original reference the client used to make the invocation, and calling the **Object::is\_equivalent** operation to compare the two references may not necessarily return true.

---

#### 11.3.10.4 *get\_servant*

**Servant get\_servant()**  
**raises(NoContext);**

This operation returns a reference to the servant that hosts the object in whose context it is called. If called outside the context of a POA dispatched operation, a **NoContext** exception is raised.

### 11.4 *IDL for PortableServer Module*

```
// IDL
// File: PortableServer.idl
#ifndef _PORTABLE_SERVER_IDL_
#define _PORTABLE_SERVER_IDL_

import ::CORBA;
module PortableServer {
 typeprefix PortableServer "org.omg";
 local interface POA; // forward declaration
 typedef sequence<POA> POAList;

 native Servant;

 typedef CORBA::OctetSeq ObjectId;

 exception ForwardRequest {
 Object forward_reference;
 };

 // Policy interfaces

 const CORBA::PolicyType THREAD_POLICY_ID = 16;
 const CORBA::PolicyType LIFESPAN_POLICY_ID = 17;
 const CORBA::PolicyType ID_UNIQUENESS_POLICY_ID = 18;
 const CORBA::PolicyType ID_ASSIGNMENT_POLICY_ID = 19;
 const CORBA::PolicyType IMPLICIT_ACTIVATION_POLICY_ID = 20;
 const CORBA::PolicyType SERVANT_RETENTION_POLICY_ID = 21;
 const CORBA::PolicyType REQUEST_PROCESSING_POLICY_ID = 22;

 enum ThreadPolicyValue {
 ORB_CTRL_MODEL,
 SINGLE_THREAD_MODEL,
 };
};
```

```
 MAIN_THREAD_MODEL
};

local interface ThreadPolicy : CORBA::Policy {
 readonly attribute ThreadPolicyValue value;
};

enum LifespanPolicyValue {
 TRANSIENT,
 PERSISTENT
};

local interface LifespanPolicy : CORBA::Policy {
 readonly attribute LifespanPolicyValue value;
};

enum IdUniquenessPolicyValue {
 UNIQUE_ID,
 MULTIPLE_ID
};

local interface IdUniquenessPolicy : CORBA::Policy {
 readonly attribute IdUniquenessPolicyValue value;
};

enum IdAssignmentPolicyValue {
 USER_ID,
 SYSTEM_ID
};

local interface IdAssignmentPolicy : CORBA::Policy {
 readonly attribute IdAssignmentPolicyValue value;
};

enum ImplicitActivationPolicyValue {
 IMPLICIT_ACTIVATION,
 NO_IMPLICIT_ACTIVATION
};

local interface ImplicitActivationPolicy : CORBA::Policy {
 readonly attribute ImplicitActivationPolicyValue value;
};

enum ServantRetentionPolicyValue {
 RETAIN,
 NON_RETAIN
};

local interface ServantRetentionPolicy : CORBA::Policy {
 readonly attribute ServantRetentionPolicyValue value;
};
```

```
enum RequestProcessingPolicyValue {
 USE_ACTIVE_OBJECT_MAP_ONLY,
 USE_DEFAULT_SERVANT,
 USE_SERVANT_MANAGER
};

local interface RequestProcessingPolicy : CORBA::Policy {
 readonly attribute RequestProcessingPolicyValue value;
};

// POAManager interface

local interface POAManager {
 exception AdapterInactive{};

 enum State {HOLDING, ACTIVE, DISCARDING, INACTIVE};

 void activate()
 raises(AdapterInactive);
 void hold_requests(
 in boolean wait_for_completion)
 raises(AdapterInactive);
 void discard_requests(
 in boolean wait_for_completion)
 raises(AdapterInactive);
 void deactivate(
 in boolean etherealize_objects,
 in boolean wait_for_completion)
 raises(AdapterInactive);
 State get_state();
 string get_id();
};

// PoaManagerFactory

local interface POAManagerFactory {
 typedef sequence<POAManager> POAManagerSeq;

 exception ManagerAlreadyExists {};

 POAManager create_POAManager(
 in string id,
 in CORBA::PolicyList policies
) raises(ManagerAlreadyExists, CORBA::PolicyError);

 POAManagerSeq list();
 POAManager find(in string id);
};

// AdapterActivator interface
```

```

local interface AdapterActivator {
 boolean unknown_adapter(
 in POA parent,
 in string name);
};

// ServantManager interface

local interface ServantManager{ };

local interface ServantActivator : ServantManager {
 Servant incarnate (
 in ObjectId oid,
 in POA adapter)
 raises (ForwardRequest);

 void etherealize (
 in ObjectId oid,
 in POA adapter,
 in Servant serv,
 in boolean cleanup_in_progress,
 in boolean remaining_activations);
};

local interface ServantLocator : ServantManager {
 native Cookie;
 Servant preinvoke(
 in ObjectId oid,
 in POA adapter,
 in CORBA::Identifier operation,
 out Cookie the_cookie)
 raises (ForwardRequest);

 void postinvoke(
 in ObjectId oid,
 in POA adapter,
 in CORBA::Identifier operation,
 in Cookie the_cookie,
 in Servant the_servant
);
};

// POA interface

local interface POA {
 exception AdapterAlreadyExists {};
 exception AdapterNonExistent {};
 exception InvalidPolicy {unsigned short index;};
 exception NoServant {};
 exception ObjectAlreadyActive {};
 exception ObjectNotActive {};
};

```

```
exception ServantAlreadyActive {};
exception ServantNotActive {};
exception WrongAdapter {};
exception WrongPolicy {};

// POA creation and destruction

POA create_POA(
 in string adapter_name,
 in POAManager a_POAManager,
 in CORBA::PolicyList policies)
raises (AdapterAlreadyExists, InvalidPolicy);

POA find_POA(
 in string adapter_name,
 in boolean activate_it)
raises (AdapterNonExistent);

void destroy(
 in boolean etherealize_objects,
 in boolean wait_for_completion);

// Factories for Policy objects

ThreadPolicy create_thread_policy(
 in ThreadPolicyValue value);
LifespanPolicy create_lifespan_policy(
 in LifespanPolicyValue value);
IdUniquenessPolicy create_id_uniqueness_policy(
 in IdUniquenessPolicyValue value);
IdAssignmentPolicy create_id_assignment_policy(
 in IdAssignmentPolicyValue value);
ImplicitActivationPolicy create_implicit_activation_policy(
 in ImplicitActivationPolicyValue value);
ServantRetentionPolicy create_servant_retention_policy(
 in ServantRetentionPolicyValue value);
RequestProcessingPolicy create_request_processing_policy(
 in RequestProcessingPolicyValue value);

// POA attributes

readonly attribute string the_name;
readonly attribute POA the_parent;
readonly attribute POAList the_children;
readonly attribute POAManager the_POAManager;
attribute AdapterActivator the_activator;

// Servant Manager registration:

ServantManager get_servant_manager()
raises (WrongPolicy);
```



```
void set_servant_manager(
 in ServantManager imgr)
raises (WrongPolicy);

// operations for the USE_DEFAULT_SERVANT policy

Servant get_servant()
raises (NoServant, WrongPolicy);

void set_servant(in Servant p_servant)
raises (WrongPolicy);

// object activation and deactivation

ObjectId activate_object(
 in Servant p_servant)
raises (ServantAlreadyActive, WrongPolicy);

void activate_object_with_id(
 in ObjectId id,
 in Servant p_servant)
raises (ServantAlreadyActive, ObjectAlreadyActive, WrongPolicy);

void deactivate_object(
 in ObjectId oid)
raises (ObjectNotActive, WrongPolicy);

// reference creation operations

Object create_reference (
 in CORBA::RepositoryId intf)
raises (WrongPolicy);

Object create_reference_with_id (
 in ObjectId oid,
 in CORBA::RepositoryId intf
);

// Identity mapping operations:

ObjectId servant_to_id(
 in Servant p_servant)
raises (ServantNotActive, WrongPolicy);

Object servant_to_reference(
 in Servant p_servant)
raises (ServantNotActive, WrongPolicy);

Servant reference_to_servant(
 in Object reference)
raises(ObjectNotActive, WrongAdapter, WrongPolicy);
```

```
 ObjectId reference_to_id(
 in Object reference)
 raises (WrongAdapter, WrongPolicy);

 Servant id_to_servant(
 in ObjectId oid)
 raises (ObjectNotActive, WrongPolicy);

 Object id_to_reference(in ObjectId oid)
 raises (ObjectNotActive, WrongPolicy);

 readonly attribute CORBA::OctetSeq id;
 readonly attribute POAManagerFactory the_POAManagerFactory;
 };

 // Current interface

 local interface Current : CORBA::Current {
 exception NoContext { };

 POA get_POA()
 raises (NoContext);

 ObjectId get_object_id()
 raises (NoContext);

 Object get_reference()
 raises(NoContext);

 Servant get_servant()
 raises(NoContext);
 };
};
```

## 11.5 UML Description of PortableServer

The following diagrams were generated by an automated tool and then annotated with the cardinalities of the associations. They are intended to be an aid in comprehension to those who enjoy such representations. They are not normative.

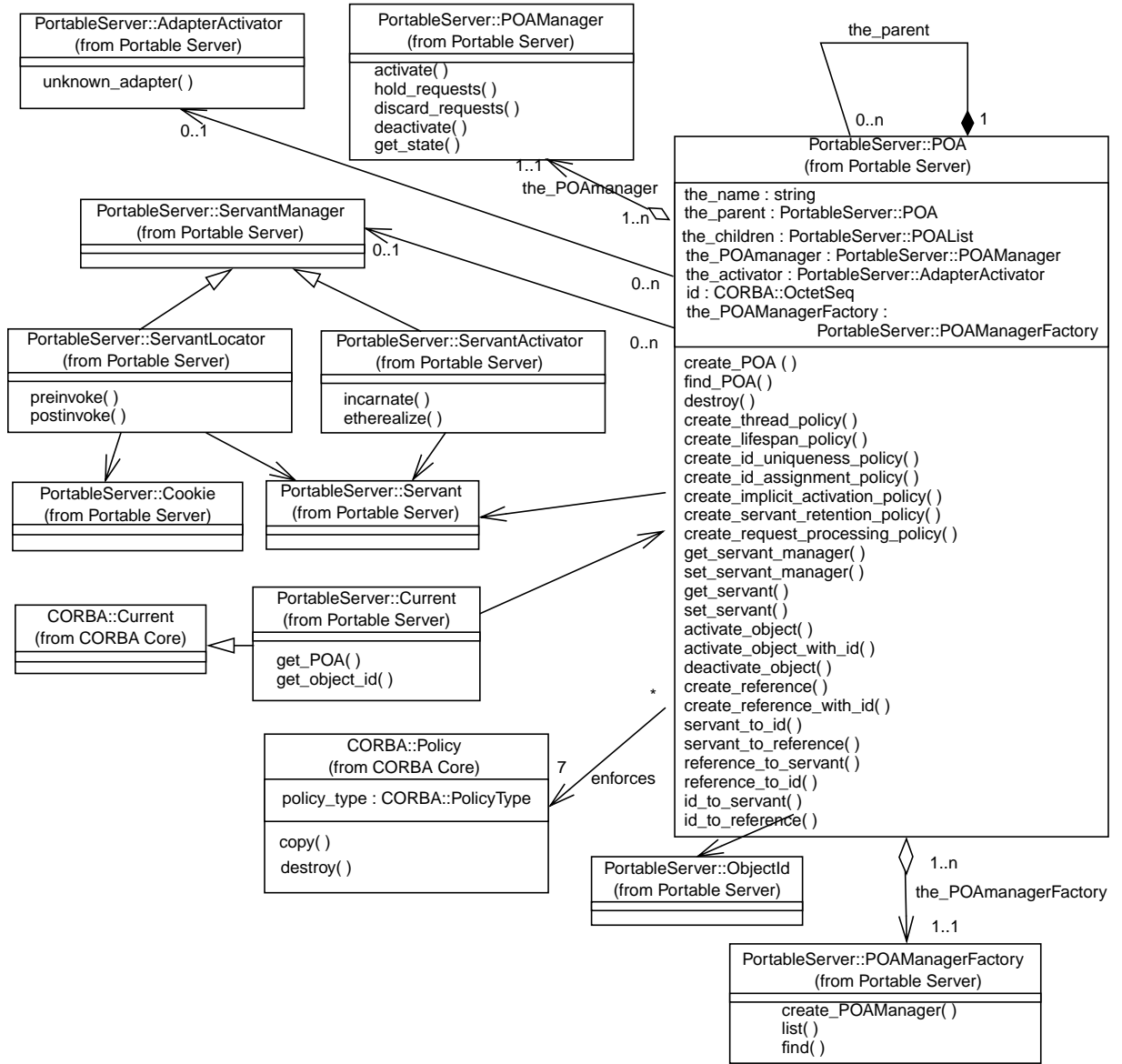

Figure 11-4 UML for main part of PortableServer

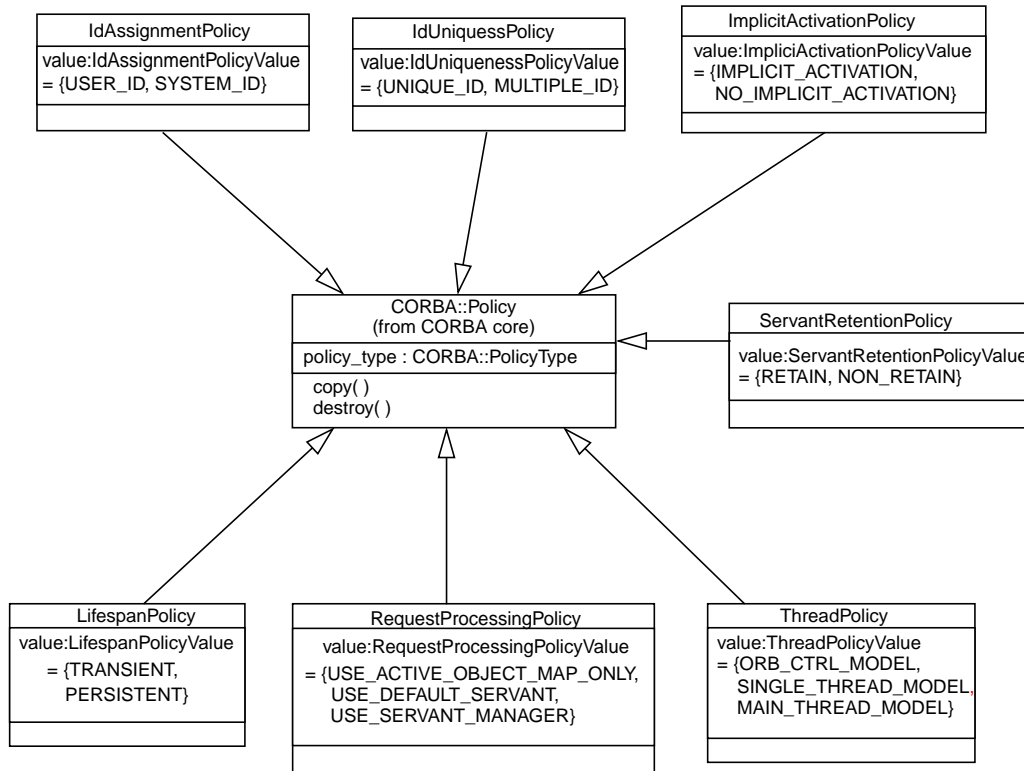

Figure 11-5 UML for PortableServer Policies

## 11.6 Usage Scenarios

This section illustrates how different capabilities of the POA may be used in applications.

**Note** – In some of the following C++ examples, PortableServer names are not explicitly scoped. It is assumed that all the examples have the C++ statement `using namespace PortableServer;`

### 11.6.1 Getting the Root POA

All server applications must obtain a reference to the root POA, either to use it directly to manage objects, or to create new POA objects. The following example demonstrates how the application server can obtain a reference to the root POA.

```

// C++
CORBA::ORB_ptr orb = CORBA::ORB_init(argc, argv);
CORBA::Object_ptr pobj =
orb->resolve_initial_references("RootPOA");

```

```
PortableServer::POA_ptr rootPOA;
rootPOA = PortableServer::POA::narrow(pfobj);
```

### 11.6.2 Creating a POA

For a variety of reasons, a server application might want to create a new POA. The POA is created as a child of an existing POA. In this example, it is created as a child of the root POA.

```
// C++
CORBA::PolicyList policies(2);
policies.length(2);
policies[0] = rootPOA->create_thread_policy(
PortableServer::ThreadPolicy::ORB_CTRL_MODEL);
policies[1] = rootPOA->create_lifespan_policy(
PortableServer::LifespanPolicy::TRANSIENT);
PortableServer::POA_ptr poa =
rootPOA->create_POA("my_little_poa",
PortableServer::POAManager::_nil(), policies);
```

### 11.6.3 Explicit Activation with POA-assigned Object Ids

By specifying the **SYSTEM\_ID** policy on a POA, objects may be explicitly activated through the POA without providing a user-specified identity value. Using this approach, objects are activated by performing the **activate\_object** operation on the POA with the object in question. For this operation, the POA allocates, assigns, and returns a unique identity value for the object.

Generally this capability is most useful for transient objects, where the Object Id needs to be valid only as long as the servant is active in the server. The Object Ids can remain completely hidden and no servant manager need be provided. When this is the case, the identity and lifetime of the servant and the abstract object are essentially equivalent. When POA-assigned Object Ids are used with persistent objects or objects that are activated on demand, the application must be able to associate the generated Object Id value with its corresponding object state.

This example illustrates a simple implementation of transient objects using POA-assigned Object Ids. It presumes a POA that has the **SYSTEM\_ID**, **USE\_SERVANT\_MANAGER**, and **RETAIN** policies.

Assume this interface:

```
// IDL
interface Foo {
 long doit();
};
```

This might result in the generation of the following skeleton:

```
class POA_Foo : public ServantBase
{
public:
 ...
 virtual CORBA::Long doit() = 0;
}
```

Derive your implementation:

```
class MyFooServant : public POA_Foo
{
public:
 MyFooServant(POA_ptr poa, Long value)
 : my_poa(POA::_duplicate(poa)), my_value(value) {}
 ~MyFooServant() {CORBA::release(my_poa);}
 virtual POA_ptr _default_POA()
 {return POA::_duplicate(my_poa);}
 virtual Long doit() {return my_value;}
protected:
 POA_ptr my_poa;
 Long my_value;
};
```

Now, somewhere in the program during initialization, probably in `main()`:

```
MyFooServant* afoo = new MyFooServant(poa,27);
PortableServer::ObjectId_var oid =
 poa->activate_object(afoo);
Foo_var foo = afoo->_this();
poa->the_POAManager()->activate();
orb->run();
```

This object is activated with a generated Object Id.

#### 11.6.4 *Explicit Activation with User-assigned Object Ids*

An object may be explicitly activated by a server using a user-assigned identity. This may be done for several reasons. For example, a programmer may know that certain objects are commonly used, or act as initial points of contact through which clients access other objects (for example, factories). The server could be implemented to create and explicitly activate these objects during initialization, avoiding the need for a servant manager.

If an implementation has a reasonably small number of servants, the server may be designed to keep them all active continuously (as long as the server is executing). If this is the case, the implementation need not provide a servant manager. When the server initializes, it could create all available servants, loading their state and identities from some persistent store. The POA supports an explicit activation operation, **activate\_object\_with\_id**, that associates a servant with an Object Id. This operation would be used to activate all of the existing objects managed by the server during server initialization. Assuming the POA has the **USE\_SERVANT\_MANAGER** policy and no

servant manager is associated with a POA, any request received by the POA for an Object Id value not present in the Active Object Map will result in an **OBJ\_ADAPTER** exception.

In simple cases of well-known, long-lived objects, it may be sufficient to activate them with well-known Object Id values during server initialization, before activating the POA. This approach ensures that the objects are always available when the POA is active, and doesn't require writing a servant manager. It has severe practical limitations for a large number of objects, though.

This example illustrates the explicit activation of an object using a user-chosen Object Id. This example presumes a POA that has the **USER\_ID**, **USE\_SERVANT\_MANAGER**, and **RETAIN** policies.

The code is like the previous example, but replace the last portion of the example shown above with the following code:

```
// C++
MyFooServant* afoo = new MyFooServant(poa, 27);
PortableServer::ObjectId_var oid =
 PortableServer::string_to_ObjectId("myLittleFoo");
poa->activate_object_with_id(oid.in(), afoo);
Foo_var foo = afoo->_this();
```

### 11.6.5 *Creating References before Activation*

It is sometimes useful to create references for objects before activating them. This example extends the previous example to illustrate this option:

```
// C++
PortableServer::ObjectId_var oid =
PortableServer::string_to_ObjectId("myLittleFoo");
CORBA::Object_var obj = poa->create_reference_with_id(
 oid.in(), "IDL:Foo:1.0");
Foo_var foo = Foo::_narrow(obj);

// ...later...
MyFooServant* afoo = new MyFooServant(poa, 27);
poa->activate_object_with_id(oid.in(), afoo);
```

### 11.6.6 *Servant Manager Definition and Creation*

Servant managers are object implementations, and are required to satisfy all of the requirements of object implementations necessary for their intended function. Because servant managers are local objects, and their use is limited to a single narrow role, some simplifications in their implementation are possible. Note that these simplifications are suggestions, not normative requirements. They are intended as examples of ways to reduce the programming effort required to define servant managers.

A servant manager implementation must provide the following things:

- implementation code for either
  - **incarnate( )** and **etherealize( )**, or
  - **preinvoke( )** and **postinvoke( )**
- implementation code for the servant operations, as for all servants

The first two are obvious; their content is dictated by the requirements of the implementation that the servant manager is managing. For the third point, the default servant manager on the root POA already supplies this implementation code. User-written servant managers will have to provide this themselves.

Since servant managers are objects, they themselves must be activated. It is expected that most servant managers can be activated on the root POA with its default set of policies (see “POA Creation” on page 11-6). It is for this reason that the root POA has the **IMPLICIT\_ACTIVATION** policy so that a servant manager can easily be activated. Users may choose to activate a servant manager on other POAs.

The following is an example servant manager to activate objects on demand. This example presumes a POA that has the **USER\_ID**, **USE\_SERVANT\_MANAGER**, and **RETAIN** policies.

Since **RETAIN** is in effect, the type of servant manager used is a **ServantActivator**. The ORB supplies a servant activator skeleton class in a library:

```
// C++
namespace POA_PortableServer
{
 class ServantActivator : public virtual ServantManager
 {
 public:
 virtual ~ServantActivator();
 virtual Servant incarnate(
 const ObjectId& POA_ptr poa) = 0;
 virtual void etherealize(
 const ObjectId&, POA_ptr poa,
 Servant, Boolean remaining_activations) = 0;
 };
};
```

A **ServantActivator** servant manager might then look like:

```
// C++
class MyFooServantActivator : public
 POA_PortableServer::ServantActivator
{
public:
 // ...
 Servant incarnate(
 const ObjectId& oid, POA_ptr poa)
 {
 String_var s = PortableServer::ObjectId_to_string
 (oid);
 }
};
```



```

 if (strcmp(s, "myLittleFoo") == 0) {
 return new MyFooServant(poa, 27);
 }
 else {
 throw CORBA::OBJECT_NOT_EXIST();
 }
 }

void etherealize(
 const ObjectId& oid,
 POA_ptr poa,
 Servant servant,
 Boolean remaining_activations)
{
 if (remaining_activations == 0)
 delete servant;
}
// ...
};

```

### 11.6.7 Object Activation on Demand

The precondition for this scenario is the existence of a client with a reference for an object with which no servant is associated at the time the client makes a request on the reference. It is the responsibility of the ORB, in collaboration with the POA and the server application to find or create an appropriate servant and perform the requested operation on it. Such an object is said to be *incarnated* (or *incarnation*) when it has an active servant. Note that the client had to obtain the reference in question previously from some source. From the client's perspective, the abstract object exists as long as it holds a reference, until it receives an `OBJECT_NOT_EXIST` system exception in a reply from an attempted request on the object. Incarnation state does not imply existence or non-existence of the abstract object.

---

**Note** – This specification does not address the issues of communication or server process activation, as they are immaterial to the POA interface and operation. It is assumed that the ORB activates the server if necessary, and can deliver the request to the appropriate POA.

---

To support object activation on demand, the server application must register a servant manager with the appropriate POA. Upon receiving the request, if the POA consults the Active Object Map and discovers that there is no active servant associated with the target Object Id, the POA invokes the **incarnate** operation on the servant manager.

---

**Note** – An implication that this model has for GIOP is that the object key in the request message must encapsulate the Object Id value. In addition, it may encapsulate other values as necessitated by the ORB implementation. For example, the server must be able to determine to which POA the request should be directed. It could assign a different communication endpoint to each POA so that the POA identity is implicit in the request, or it could use a single endpoint for the entire server and encapsulate POA

identities in object key values.

Note that this is not a concrete requirement; the object key may not actually contain any of those values. Whatever the concrete information is, the ORB and POA must be able to use it to find the servant manager, invoke activate if necessary (that requires the actual Object Id value), and/or find the active servant in some map.

The **incarnate** invocation passes the Object Id value to the servant manager. At this point, the servant manager may take any action necessary to produce a servant that it considers to be a valid incarnation of the object in question. The operation returns the servant to the POA, which invokes the operation on it. The **incarnate** operation may alternatively raise an **OBJECT\_NOT\_EXIST** system exception that will be returned to the invoking client. In this way, the user-supplied implementation is responsible for determining object existence and non-existence.

After activation, the POA maintains the association of the servant and the Object Id in the Active Object Map. (This example presumes the **RETAIN** and **USE\_SERVANT\_MANAGER** policies.)

As an obvious example of transparent activation, the Object Id value could contain a key for a record in a database that contains the object's state. The servant manager would retrieve the state from the database, construct a servant of the appropriate implementation class (assuming an object-oriented programming language), initialize it with the state from the database, and return it to the POA.

The example servant manager in the last section (Section 11.6.6, "Servant Manager Definition and Creation," on page 11-57) could be used for this scenario. Recall that the POA would have the **USER\_ID**, **USE\_SERVANT\_MANAGER**, and **RETAIN** policies.

Given such a **ServantActivator**, all that remains is initialization code such as the following.

```
PortableServer::ObjectId_var oid =
 PortableServer::string_to_ObjectId("myLittleFoo");
CORBA::Object_var obj = poa->create_reference_with_id(
 oid, "IDL:foo:1.0");
MyFooServantActivator* fooIM = new MyFooServantActivator;
ServantActivator_var IMref = fooIM->_this();
poa->set_servant_manager(IMref);
poa->the_POAmanager()->activate();
orb->run();
```

### 11.6.8 Persistent Objects with POA-assigned Ids

It is possible to access the Object Id value assigned to an object by the POA, with the **POA::reference\_to\_id** operation. If the reference is for an object managed by the POA that is the operation's target, the operation will return the Object Id value, whether it was assigned by the POA or the user. By doing this, an implementation may provide a

servant manager that associates the POA-allocated Object Id values with persistently stored state. It may also pass the POA-allocated Object Id values to POA operations such as **activate\_object\_with\_id** and **create\_reference\_with\_id**.

A POA with the **PERSISTENT** policy may be destroyed and later reinstantiated in the same or a different process. A POA with both the **SYSTEM\_ID** and **PERSISTENT** policies generates Object Id values that are unique across all instantiations of the same POA.

### 11.6.9 Multiple Object Ids Mapping to a Single Servant

Each POA is created with a policy that indicates whether or not servants are allowed to support multiple object identities simultaneously. If a POA allows multiple identities per servant, the POA's treatment of the servants is affected in the following ways:

- Servants of the type may be explicitly activated multiple times with different identity values without raising an exception.
- A servant cannot be mapped onto or converted to an individual object reference using that POA, since the identity is potentially ambiguous.

### 11.6.10 One Servant for All Objects

By using the **USE\_DEFAULT\_SERVANT** policy, the developer can create a POA that will use a single servant to implement all of its objects. This approach is useful when there is very little data associated with each object, so little that the data can be encoded in the Object Id.

The following example illustrates this approach by using a single servant to incarnate all CORBA objects that export a given interface in the context of a server. This example presumes a POA that has the **USER\_ID**, **NON\_RETAIN**, and **USE\_DEFAULT\_SERVANT** policies.

Two interfaces are defined in IDL. The **FileDescriptor** interface is supported by objects that will encapsulate access to operations in a file associated with a file system. Global operations in a file system, such as the ones necessary to create **FileDescriptor** objects, are supported by objects that export the **FileSystem** interface.

```
// IDL
interface FileDescriptor {
 typedef sequence<octet> DataBuffer;

 long write (in DataBuffer buffer);
 DataBuffer read (
 in long num_bytes);
 void destroy ();
};

interface FileSystem {
 ...
 FileDescriptor open (
```

```
 in string file_name,
 in long flags);
 ...
};
```

Implementation of these two IDL interfaces may inherit from static skeleton classes generated by an IDL to C++ compiler as follows:

```
// C++
class FileDescriptorImpl : public POA_FileDescriptor
{
public:
 FileDescriptorImpl(POA_ptr poa);
 ~FileDescriptorImpl();
 POA_ptr _default_POA();
 CORBA::Long write(
 const FileDescriptor::DataBuffer& buffer);
 FileDescriptor::DataBuffer* read(
 CORBA::Long num_bytes);
 void destroy();
private:
 POA_ptr my_poa;
};

class FileSystemImpl : public POA_FileSystem
{
public:
 FileSystemImpl(POA_ptr poa);
 ~FileSystemImpl();
 POA_ptr _default_POA();
 FileDescriptor_ptr open(
 const char* file_name, CORBA::Long flags);
private:
 POA_ptr my_poa;
 FileDescriptorImpl* fd_servant;
};
```

A single servant may be used to serve all requests issued to all **FileDescriptor** objects created by a **FileSystem** object. The following fragment of code illustrates the steps to perform when a **FileSystem** servant is created.

```
// C++
FileSystemImpl::FileSystemImpl(POA_ptr poa)
 : my_poa(POA::_duplicate(poa))
{
 fd_servant = new FileDescriptorImpl(poa);
 poa->set_servant(fd_servant);
};
```

The following fragment of code illustrates how **FileDescriptor** objects are created as a result of invoking an operation (**open**) exported by a **FileSystem** object. First, a local file descriptor is created using the appropriate operating system call. Then a CORBA object reference is created and returned to the client. The value of the local file descriptor will be used to distinguish the new **FileDescriptor** object from other **FileDescriptor** objects. Note that **FileDescriptor** objects in the example are transient, since they use the value of their file descriptors for their ObjectIds, and of course the file descriptors are only valid for the life of a process.

```
// C++
FileDescriptor_ptr
FileSystemImpl::open(
 const char* file_name, CORBA::Long flags)
{
 int fd = ::open(file_name, flags);
 ostringstream ostr;
 ostr << fd;
 PortableServer::ObjectId_var oid =
 PortableServer::string_to_ObjectId(ostr.str());
 Object_var obj = my_poa->create_reference_with_id(
 oid.in(), "IDL:FileDescriptor:1.0");
 return FileDescriptor::_narrow(obj);
};
```

Any request issued to a **FileDescriptor** object is handled by the same servant. In the context of a method invocation, the servant determines which particular object is being incarnated by invoking an operation that returns a reference to the target object and, after that, invoking **POA::reference\_to\_id**. In C++, the operation used to obtain a reference to the target object is **\_this()**. Typically, the **ObjectId** value associated with the reference will be used to retrieve the state of the target object. However, in this example, such a step is not required since the only thing that is needed is the value for the local file descriptor and that value coincides with the **ObjectId** value associated with the reference.

Implementation of the **read** operation is rather simple. The servant determines which object it is incarnating, obtains the local file descriptor matching its identity, performs the appropriate operating system call, and returns the result in a **DataBuffer** sequence.

```
// C++
FileDescriptor::DataBuffer*
FileDescriptorImpl::read(CORBA::Long num_bytes)
{
 FileDescriptor_var me = _this();
 PortableServer::ObjectId_var oid =
 my_poa->reference_to_id(me.in());
 CORBA::String_var s =
 PortableServer::ObjectId_to_string(oid.in());
 istringstream is(s);
 int fd;
 is >> fd;
 CORBA::Octet* buffer = DataBuffer::alloc_buf(num_bytes);
```

```

 int len = ::read(fd, buffer, num_bytes);
 DataBuffer* result = new DataBuffer(len, len, buffer, 1);
 return result;
 };

```

Using a single servant per interface is useful in at least two situations.

- In one case, it may be appropriate for encapsulating access to legacy APIs that are not object-oriented (system calls in the Unix environment, as we have shown in the example).
- In another case, this technique is useful in handling scalability issues related to the number of CORBA objects that can be associated with a server. In the example above, there may be a million **FileDescriptor** objects in the same server and this would only require one entry in the ORB. Although there are operating system limitations in this respect (a Unix server is not able to open so many local file descriptors) the important point to take into account is that usage of CORBA doesn't introduce scalability problems but provides mechanisms to handle them.

### 11.6.11 Single Servant, Many Objects and Types, Using DSI

The ability to associate a single DSI servant with many CORBA objects is rather powerful in some scenarios. It can be the basis for development of gateways to legacy systems or software that mediates with external hardware, for example.

Usage of the DSI is illustrated in the following example. This example presumes a POA that supports the **USER\_ID**, **USE\_DEFAULT\_SERVANT**, and **RETAIN** policies.

A single servant will be used to incarnate a huge number of CORBA objects, each of them representing a separate entry in a Database. There may be several types of entries in the Database, representing different entity types in the Database model. Each type of entry in the Database is associated with a separate interface that comprises operations supported by the Database on entries of that type. All these interfaces inherit from the **DatabaseEntry** interface. Finally, an object supporting the **DatabaseAgent** interface supports basic operations in the database such as creating a new entry, destroying an existing entry, etc.

```

// IDL
interface DatabaseEntry {
 readonly attribute string name;
};

interface Employee : DatabaseEntry {
 attribute long id;
 attribute long salary;
};
...

interface DatabaseAgent {
 DatabaseEntry create_entry (
 in string key,

```

```

 in CORBA::Identifier entry_type,
 in NVPairSequence initial_attribute_values
);

 void destroy_entry (
 in string key);
 ...
};

```

Implementation of the **DatabaseEntry** interface may inherit from the standard dynamic skeleton class as follows:

```

// C++
class DatabaseEntryImpl :
 public PortableServer::DynamicImplementation
{
public:
 DatabaseEntryImpl (DatabaseAccessPoint db);
 virtual void invoke (ServerRequest_ptr request);
 ~DatabaseEntryImpl ();

 virtual POA_ptr _default_POA()
 {
 return poa;
 }
};

```

On the other hand, implementation of the **DatabaseAgent** interface may inherit from a static skeleton class generated by an IDL to C++ compiler as follows:

```

// C++
class DatabaseAgentImpl :
 public DatabaseAgentImplBase
{
protected:
 DatabaseAccessPoint mydb;
 DatabaseEntryImpl * common_servant;
public:
 DatabaseAgentImpl ();
 virtual DatabaseEntry_ptr create_entry (
 const char * key,
 const char * entry_type,
 const NVPairSequence& initial_attribute_values
);
 virtual void destroy_entry (const char * key);
 ~DatabaseAgentImpl ();
};

```

A single servant may be used to serve all requests issued to all **DatabaseEntry** objects created by a **DatabaseAgent** object. The following fragment of code illustrates the steps to perform when a **DatabaseAgent** servant is created. First, access to the

database is initialized. As a result, some kind of descriptor (a **DatabaseAccessPoint** local object) used to operate on the database is obtained. Finally, a servant will be created and associated with the POA.

```
// C++
void DatabaseAgentImpl::DatabaseAgentImpl ()
{
 mydb = ...;
 common_servant = new DatabaseEntryImpl(mydb);
 poa->set_servant(common_servant);
};
```

The code used to create **DatabaseEntry** objects representing entries in the database is similar to the one used for creating **FileDescriptor** objects in the example of the previous section. In this case, a new entry is created in the database and the key associated with that entry will be used to represent the identity for the corresponding **DatabaseEntry** object. All requests issued to a **DatabaseEntry** object are handled by the same servant because references to this type of object are associated with a common POA created with the **USE\_DEFAULT\_SERVANT** policy.

```
// C++
DatabaseEntry_ptr DatabaseAgentImpl::create_entry (
 const char * key,
 const char * entry_type,
 const NVPairSequence& initial_attribute_values)

// creates a new entry in the database:
mydb->new_entry (key, ...);

// creates a reference to the CORBA object used to
// encapsulate access to the new entry in the database.
// There is an interface for each entry type:
CORBA::Object_ptr obj = poa->create_reference_with_id(
 string_to_ObjectId (key),
 identifierToRepositoryId (entry_type),
);

DatabaseEntry_ptr entry = DatabaseEntry::_narrow (obj);
CORBA::release (obj);
return entry;
};
```

Any request issued to a **DatabaseEntry** object is handled by the same servant. In the context of a method invocation, the servant determines which particular object it is incarnating, obtains the database key matching its identity, invokes the appropriate operation in the database and returns the result as an output parameter in the **ServerRequest** object.



Sometimes, a program may need to determine the type of an entry in the database in order to invoke operations on the entry. If that is the case, the servant may obtain the type of an entry based on the interface supported by the **DatabaseEntry** object encapsulating access to that entry. This interface may be obtained by means of invoking the **get\_interface** operation exported by the reference to the **DatabaseEntry** object.

```
// C++
void DatabaseEntryImpl::invoke (ServerRequest_ptr request)
{
 CORBA::Object_ptr current_obj = _this ();

 // The servant determines the key associated with
 // the database entry represented by current_obj:
 PortableServer::ObjectId oid =
 poa->reference_to_id (current_obj);
 char * key = ObjectId_to_string (oid);

 // The servant handles the incoming CORBA request. This
 // typically involves the following steps:
 // 1. mapping the CORBA request into a database request
 // using the key obtained previously
 // 2. constructing output parameters to the CORBA request
 // from the response to the database request
 ...
};
```

Note that in this example, we may have a billion **DatabaseEntry** objects in a server requiring only a single entry in map tables supported by the POA (that is, the ORB at the server). No permanent storage is required for references to **DatabaseEntry** objects at the server. Actually, references to **DatabaseEntry** objects will only occupy space:

- at clients, as long as those references are used; or
- at the server, only while a request is being served.

Scalability problems can be handled using this technique. There are many scenarios where this scalability causes no penalty in terms of performance (basically, when there is no need to restore the state of an object, each time a request to it is being served).



## Contents

This chapter contains the following sections.

| Section Title                                | Page |
|----------------------------------------------|------|
| “Elements of Interoperability”               | 12-1 |
| “Relationship to Previous Versions of CORBA” | 12-4 |
| “Examples of Interoperability Solutions”     | 12-5 |
| “Motivating Factors”                         | 12-8 |
| “Interoperability Design Goals”              | 12-9 |

ORB interoperability specifies a comprehensive, flexible approach to supporting networks of objects that are distributed across and managed by multiple, heterogeneous CORBA-compliant ORBs. The approach to “interORBability” is universal, because its elements can be combined in many ways to satisfy a very broad range of needs.

## 12.1 Elements of Interoperability

The elements of interoperability are as follows:

- ORB interoperability architecture
- Inter-ORB bridge support
- General and Internet inter-ORB Protocols (GIOPs and IIOPs)

In addition, the architecture accommodates environment-specific inter-ORB protocols (ESIOPs) that are optimized for particular environments such as DCE.

### 12.1.1 ORB Interoperability Architecture

The ORB Interoperability Architecture provides a conceptual framework for defining the elements of interoperability and for identifying its compliance points. It also characterizes new mechanisms and specifies conventions necessary to achieve interoperability between independently produced ORBs.

Specifically, the architecture introduces the concepts of *immediate* and *mediated bridging* of ORB domains. The Internet Inter-ORB Protocol (IIOP) forms the common basis for broad-scope mediated bridging. The inter-ORB bridge support can be used to implement both immediate bridges and to build “half-bridges” to mediated bridge domains.

By use of bridging techniques, ORBs can interoperate without knowing any details of that ORB’s implementation, such as what particular IPC or protocols (such as ESIOPs) are used to implement the *CORBA* specification.

The IIOP may be used in bridging two or more ORBs by implementing “half bridges” that communicate using the IIOP. This approach works for both stand-alone ORBs, and networked ones that use an ESIOP.

The IIOP may also be used to implement an ORB’s internal messaging, if desired. Since ORBs are not required to use the IIOP internally, the goal of not requiring prior knowledge of each others’ implementation is fully satisfied.

### 12.1.2 Inter-ORB Bridge Support

The interoperability architecture clearly identifies the role of different kinds of domains for ORB-specific information. Such domains can include object reference domains, type domains, security domains (e.g., the scope of a *Principal* identifier), a transaction domain, and more.

Where two ORBs are in the same domain, they can communicate directly. In many cases, this is the preferable approach. This is not always true, however, since organizations often need to establish local control domains.

When information in an invocation must leave its domain, the invocation must traverse a bridge. The role of a bridge is to ensure that content and semantics are mapped from the form appropriate to one ORB to that of another, so that users of any given ORB only see their appropriate content and semantics.

The inter-ORB bridge support element specifies ORB APIs and conventions to enable the easy construction of interoperability bridges between ORB domains. Such bridge products could be developed by ORB vendors, Sieves, system integrators, or other third-parties.

Because the extensions required to support Inter-ORB Bridges are largely general in nature, do not impact other ORB operation, and can be used for many other purposes besides building bridges, they are appropriate for all ORBs to support. Other applications include debugging, interposing of objects, implementing objects with interpreters and scripting languages, and dynamically generating implementations.

The inter-ORB bridge support can also be used to provide interoperability with non-CORBA systems, such as Microsoft's Component Object Model (COM). The ease of doing this will depend on the extent to which those systems conform to the CORBA Object Model.

### *12.1.3 General Inter-ORB Protocol (GIOP)*

The General Inter-ORB Protocol (GIOP) element specifies a standard transfer syntax (low-level data representation) and a set of message formats for communications between ORBs. The GIOP is specifically built for ORB to ORB interactions and is designed to work directly over any connection-oriented transport protocol that meets a minimal set of assumptions. It does not require or rely on the use of higher level RPC mechanisms. The protocol is simple, scalable and relatively easy to implement. It is designed to allow portable implementations with small memory footprints and reasonable performance, with minimal dependencies on supporting software other than the underlying transport layer.

While versions of the GIOP running on different transports would not be directly interoperable, their commonality would allow easy and efficient bridging between such networking domains.

### *12.1.4 Internet Inter-ORB Protocol (IIOP)<sup>®</sup>*

The Internet Inter-ORB Protocol (IIOP) element specifies how GIOP messages are exchanged using TCP/IP connections. The IIOP specifies a standardized interoperability protocol for the Internet, providing "out of the box" interoperation with other compatible ORBs based on the most popular product- and vendor-neutral transport layer. It can also be used as the protocol between half-bridges (see below).

The protocol is designed to be suitable and appropriate for use by any ORB to interoperate in Internet Protocol domains unless an alternative protocol is necessitated by the specific design center or intended operating environment of the ORB. In that sense it represents the basic inter-ORB protocol for TCP/IP environments, a most pervasive transport layer.

The IIOP's relationship to the GIOP is similar to that of a specific language mapping to OMG IDL; the GIOP may be mapped onto a number of different transports, and specifies the protocol elements that are common to all such mappings. The GIOP by itself, however, does not provide complete interoperability, just as IDL cannot be used to build complete programs. The IIOP and other similar mappings to different transports, are concrete realizations of the abstract GIOP definitions, as shown in Figure 12-1 on page 12-4.

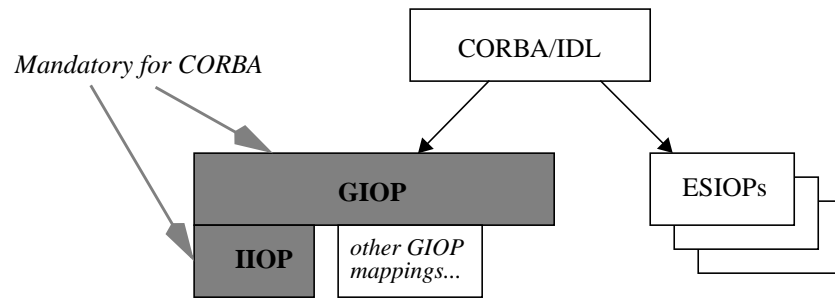

Figure 12-1 Inter-ORB Protocol Relationships.

### 12.1.5 Environment-Specific Inter-ORB Protocols (ESIOPs)

This specification also makes provision for an open-ended set of Environment-Specific Inter-ORB Protocols (ESIOPs). Such protocols would be used for “out of the box” interoperation at user sites where a particular networking or distributing computing infrastructure is already in general use.

Because of the opportunity to leverage and build on facilities provided by the specific environment, ESIOPs might support specialized capabilities such as those relating to security and administration.

While ESIOPs may be optimized for particular environments, all ESIOP specifications will be expected to conform to the general ORB interoperability architecture conventions to enable easy bridging. The inter-ORB bridge support enables bridges to be built between ORB domains that use the IIOP and ORB domains that use a particular ESIOP.

## 12.2 Relationship to Previous Versions of CORBA

The ORB Interoperability Architecture builds on Common Object Request Broker Architecture by adding the notion of ORB Services and their domains. (ORB Services are described in Section 13.2, “ORBs and ORB Services,” on page 13-3). The architecture defines the problem of ORB interoperability in terms of bridging between those domains, and defines several ways in which those bridges can be constructed. The bridges can be internal (in-line) and external (request-level) to ORBs.

APIs included in the interoperability specifications include compatible extensions to previous versions of *CORBA* to support request-level bridging:

- A Dynamic Skeleton Interface (DSI) is the basic support needed for building request-level bridges. It is the server-side analogue of the Dynamic Invocation Interface and in the same way it has general applicability beyond bridging. For information about the Dynamic Skeleton Interface, refer to the *Dynamic Skeleton Interface* chapter.

- APIs for managing object references have been defined, building on the support identified for the Relationship Service. The APIs are defined in Object Reference Operations in the *ORB Interface* chapter of this book. The Relationship Service is described in the Relationship Service specification; refer to the *CosObjectIdentity Module* section of that specification.

## 12.3 Examples of Interoperability Solutions

The elements of interoperability (Inter-ORB Bridges, General and Internet Inter-ORB Protocols, Environment-Specific Inter-ORB Protocols) can be combined in a variety of ways to satisfy particular product and customer needs. This section provides some examples.

### 12.3.1 Example 1

ORB product A is designed to support objects distributed across a network and provide “out of the box” interoperability with compatible ORBs from other vendors. In addition it allows bridges to be built between it and other ORBs that use environment-specific or proprietary protocols. To accomplish this, ORB A uses the IIOP and provides inter-ORB bridge support.

### 12.3.2 Example 2

ORB product B is designed to provide highly optimized, very high-speed support for objects located on a single machine. For example, to support thousands of Fresco GUI objects operated on at near function-call speeds. In addition, some of the objects will need to be accessible from other machines and objects on other machines will need to be infrequently accessed. To accomplish this, ORB A provides a half-bridge to support the Internet IOP for communication with other “distributed” ORBs.

### 12.3.3 Example 3

ORB product C is optimized to work in a particular operating environment. It uses a particular environment-specific protocol based on distributed computing services that are commonly available at the target customer sites. In addition, ORB C is expected to interoperate with other arbitrary ORBs from other vendors. To accomplish this, ORB C provides inter-ORB bridge support and a companion half-bridge product (supplied by the ORB vendor or some third-party) provides the connection to other ORBs. The half-bridge uses the IIOP to enable interoperability with other compatible ORBs.

### 12.3.4 Interoperability Compliance

An ORB is considered to be interoperability-compliant when it meets the following requirements:

- In the CORBA Core part of this specification, standard APIs are provided by an ORB to enable the construction of request-level inter-ORB bridges. APIs are defined by the Dynamic Invocation Interface, the Dynamic Skeleton Interface, and by the object identity operations described in the *Interface Repository* chapter of this book.
- An Internet Inter-ORB Protocol (IIOP) (explained in the *Building Inter-ORB Bridges* chapter) defines a transfer syntax and message formats (described independently as the General Inter-ORB Protocol), and defines how to transfer messages via TCP/IP connections. The IIOP can be supported natively or via a half-bridge.

Support for additional ESIOPs and other proprietary protocols is optional in an interoperability-compliant system. However, any implementation that chooses to use the other protocols defined by the CORBA interoperability specifications must adhere to those specifications to be compliant with CORBA interoperability.

Figure 12-2 on page 12-7 shows examples of interoperable ORB domains that are CORBA-compliant.

These compliance points support a range of interoperability solutions. For example, the standard APIs may be used to construct “half bridges” to the IIOP, relying on another “half bridge” to connect to another ORB. The standard APIs also support construction of “full bridges,” without using the Internet IOP to mediate between separated bridge components. ORBs may also use the Internet IOP internally. In addition, ORBs may use GIOP messages to communicate over other network protocol families (such as Novell or OSI), and provide transport-level bridges to the IIOP.

The GIOP is described separately from the IIOP to allow future specifications to treat it as an independent compliance point.



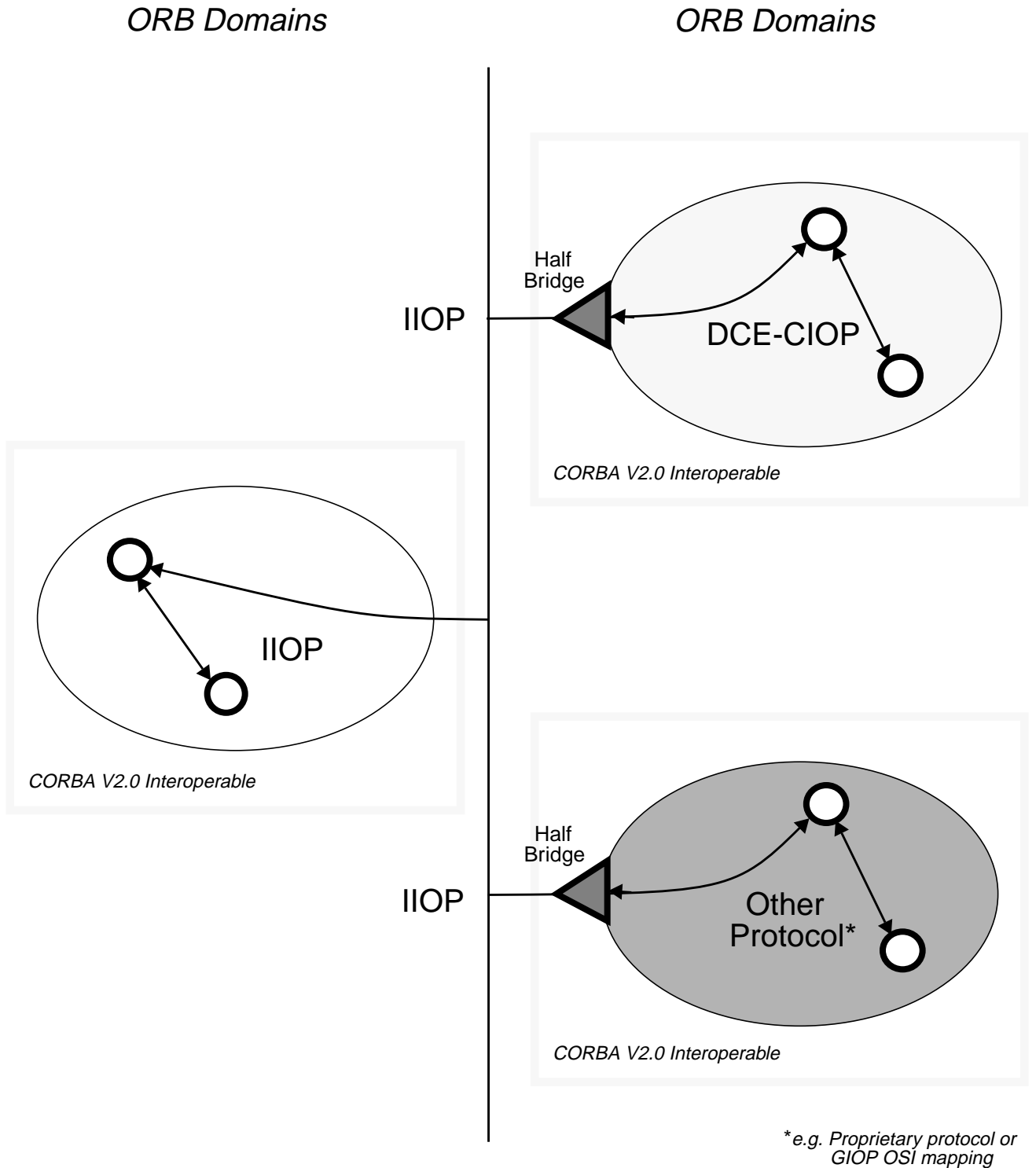

Figure 12-2 Examples of CORBA Interoperability Compliance

## 12.4 *Motivating Factors*

This section explains the factors that motivated the creation of interoperability specifications.

### 12.4.1 *ORB Implementation Diversity*

Today, there are many different ORB products that address a variety of user needs. A large diversity of implementation techniques is evident. For example, the time for a request ranges over at least 5 orders of magnitude, from a few microseconds to several seconds. The scope ranges from a single application to enterprise networks. Some ORBs have high levels of security, others are more open. Some ORBs are layered on a particular widely used protocol, others use highly optimized, proprietary protocols.

The market for object systems and applications that use them will grow as object systems are able to be applied to more kinds of computing. From application integration to process control, from loosely coupled operating systems to the information superhighway, CORBA-based object systems can be the common infrastructure.

### 12.4.2 *ORB Boundaries*

Even when it is not required by implementation differences, there are other reasons to partition an environment into different ORBs.

For security reasons, it may be important to know that it is not generally possible to access objects in one domain from another. For example, an “internet ORB” may make public information widely available, but a “company ORB” will want to restrict what information can get out. Even if they used the same ORB implementation, these two ORBs would be separate, so that the company could allow access to public objects from inside the company without allowing access to private objects from outside. Even though individual objects should protect themselves, prudent system administrators will want to avoid exposing sensitive objects to attacks from outside the company.

Supporting multiple ORBs also helps handle the difficult problem of testing and upgrading the object system. It would be unwise to test new infrastructure without limiting the set of objects that might be damaged by bugs, and it may be impractical to replace “the ORB” everywhere simultaneously. A new ORB might be tested and deployed in the same environment, interoperating with the existing ORB until either a complete switch is made or it incrementally displaces the existing one.

Management issues may also motivate partitioning an ORB. Just as networks are subdivided into domains to allow decentralized control of databases, configurations, resources, management of the state in an ORB (object reference location and translation information, interface repositories, per-object data) might also be done by creating sub-ORBs.

### 12.4.3 ORBs Vary in Scope, Distance, and Lifetime

Even in a single computing environment produced by a single vendor, there are reasons why some of the objects an application might use would be in one ORB, and others in another ORB. Some objects and services are accessed over long distances, with more global visibility, longer delays, and less reliable communication. Other objects are nearby, are not accessed from elsewhere, and provide higher quality service. By deciding which ORB to use, an implementor sets expectations for the clients of the objects.

One ORB might be used to retain links to information that is expected to accumulate over decades, such as library archives. Another ORB might be used to manage a distributed chess program in which the objects should all be destroyed when the game is over. Although while it is running, it makes sense for “chess ORB” objects to access the “archives ORB,” we would not expect the archives to try to keep a reference to the current board position.

## 12.5 Interoperability Design Goals

Because of the diversity in ORB implementations, multiple approaches to interoperability are required. Options identified in previous versions of *CORBA* include:

- *Protocol Translation*, where a gateway residing somewhere in the system maps requests from the format used by one ORB to that used by another.
- *Reference Embedding*, where invocation using a native object reference delegates to a special object whose job is to forward that invocation to another ORB.
- *Alternative ORBs*, where ORB implementations agree to coexist in the same address space so easily that a client or implementation can transparently use any of them, and pass object references created by one ORB to another ORB without losing functionality.

In general, there is no single protocol that can meet everyone's needs, and there is no single means to interoperate between two different protocols. There are many environments in which multiple protocols exist, and there are ways to bridge between environments that share no protocols.

This specification adopts a flexible architecture that allows a wide variety of ORB implementations to interoperate and that includes both bridging and common protocol elements.

The following goals guided the creation of interoperability specifications:

- The architecture and specifications should allow high-performance, small footprint, lightweight interoperability solutions.
- The design should scale, should not be unduly difficult to implement, and should not unnecessarily restrict implementation choices.

- Interoperability solutions should be able to work with any vendors' existing ORB implementations with respect to their CORBA-compliant core feature set; those implementations are diverse.
- All operations implied by the CORBA object model (i.e., the stringify and destringify operations defined on the **CORBA:ORB** pseudo-object and all the operations on **CORBA:Object**) as well as type management (e.g., narrowing, as needed by the C++ mapping) should be supported.

### *12.5.1 Non-Goals*

The following were taken into account, but were not goals:

- Support for security
- Support for future ORB Services

## Contents

This chapter contains the following sections.

| Section Title                                | Page  |
|----------------------------------------------|-------|
| “Overview”                                   | 13-1  |
| “ORBs and ORB Services”                      | 13-3  |
| “Domains”                                    | 13-5  |
| “Interoperability Between ORBs”              | 13-7  |
| “Object Addressing”                          | 13-11 |
| “An Information Model for Object References” | 13-14 |
| “Service Context”                            | 13-28 |
| “Coder/Decoder Interfaces”                   | 13-32 |
| “Feature Support and GIOP Versions”          | 13-35 |
| “Code Set Conversion”                        | 13-37 |

## 13.1 Overview

The original Interoperability RFP defines interoperability as the ability for a client on ORB A to invoke an OMG IDL-defined operation on an object on ORB B, where ORB A and ORB B are independently developed. It further identifies general requirements including in particular:

- Ability for two vendors’ ORBs to interoperate without prior knowledge of each other’s implementation.

- Support of all ORB functionality.
- Preservation of content and semantics of ORB-specific information across ORB boundaries (for example, security).

In effect, the requirement is for invocations between client and server objects to be independent of whether they are on the same or different ORBs, and not to mandate fundamental modifications to existing ORB products.

### 13.1.1 Domains

The CORBA Object Model identifies various distribution transparencies that must be supported within a single ORB environment, such as location transparency. Elements of ORB functionality often correspond directly to such transparencies. Interoperability can be viewed as extending transparencies to span multiple ORBs.

In this architecture a *domain* is a distinct scope, within which certain common characteristics are exhibited and common rules are observed over which a distribution transparency is preserved. Thus, interoperability is fundamentally involved with transparently crossing such domain boundaries.

Domains tend to be either administrative or technological in nature, and need not correspond to the boundaries of an ORB installation. Administrative domains include naming domains, trust groups, resource management domains and other “run-time” characteristics of a system. Technology domains identify common protocols, syntaxes and similar “build-time” characteristics. In many cases, the need for technology domains derives from basic requirements of administrative domains.

Within a single ORB, most domains are likely to have similar scope to that of the ORB itself: common object references, network addresses, security mechanisms, and more. However, it is possible for there to be multiple domains of the same type supported by a given ORB: internal representation on different machine types, or security domains. Conversely, a domain may span several ORBs: similar network addresses may be used by different ORBs, type identifiers may be shared.

### 13.1.2 Bridging Domains

The abstract architecture describes ORB interoperability in terms of the translation required when an object request traverses domain boundaries. Conceptually, a mapping or *bridging mechanism* resides at the boundary between the domains, transforming requests expressed in terms of one domain’s model into the model of the destination domain.

The concrete architecture identifies two approaches to inter-ORB bridging:

- At application level, allowing flexibility and portability.
- At ORB level, built into the ORB itself.

## 13.2 ORBs and ORB Services

The ORB Core is that part of the ORB which provides the basic representation of objects and the communication of requests. The ORB Core therefore supports the minimum functionality to enable a client to invoke an operation on a server object, with (some of) the distribution transparencies required by *CORBA*.

An object request may have implicit attributes which affect the way in which it is communicated - though not the way in which a client makes the request. These attributes include security, transactional capabilities, recovery, and replication. These features are provided by "ORB Services," which will in some ORBs be layered as internal services over the core, or in other cases be incorporated directly into an ORB's core. It is an aim of this specification to allow for new ORB Services to be defined in the future, without the need to modify or enhance this architecture.

Within a single ORB, ORB services required to communicate a request will be implemented and (implicitly) invoked in a private manner. For interoperability between ORBs, the ORB services used in the ORBs, and the correspondence between them, must be identified.

### 13.2.1 The Nature of ORB Services

ORB Services are invoked implicitly in the course of application-level interactions. ORB Services range from fundamental mechanisms such as reference resolution and message encoding to advanced features such as support for security, transactions, or replication.

An ORB Service is often related to a particular transparency. For example, message encoding – the marshaling and unmarshaling of the components of a request into and out of message buffers – provides transparency of the representation of the request. Similarly, reference resolution supports location transparency. Some transparencies, such as security, are supported by a combination of ORB Services and Object Services while others, such as replication, may involve interactions between ORB Services themselves.

ORB Services differ from Object Services in that they are positioned below the application and are invoked transparently to the application code. However, many ORB Services include components which correspond to conventional Object Services in that they are invoked explicitly by the application.

Security is an example of service with both ORB Service and normal Object Service components, the ORB components being those associated with transparently authenticating messages and controlling access to objects while the necessary administration and management functions resemble conventional Object Services.

### 13.2.2 ORB Services and Object Requests

Interoperability between ORBs extends the scope of distribution transparencies and other request attributes to span multiple ORBs. This requires the establishment of relationships between supporting ORB Services in the different ORBs.

In order to discuss how the relationships between ORB Services are established, it is necessary to describe an abstract view of how an operation invocation is communicated from client to server object.

1. The client generates an operation request, using a reference to the server object, explicit parameters, and an implicit invocation context. This is processed by certain ORB Services on the client path.
2. On the server side, corresponding ORB Services process the incoming request, transforming it into a form directly suitable for invoking the operation on the server object.
3. The server object performs the requested operation.
4. Any result of the operation is returned to the client in a similar manner.

The correspondence between client-side and server-side ORB Services need not be one-to-one and in some circumstances may be far more complex. For example, if a client application requests an operation on a replicated server, there may be multiple server-side ORB service instances, possibly interacting with each other.

In other cases, such as security, client-side or server-side ORB Services may interact with Object Services such as authentication servers.

### *13.2.3 Selection of ORB Services*

The ORB Services used are determined by:

- Static properties of both client and server objects; for example, whether a server is replicated.
- Dynamic attributes determined by a particular invocation context; for example, whether a request is transactional.
- Administrative policies (e.g., security).

Within a single ORB, private mechanisms (and optimizations) can be used to establish which ORB Services are required and how they are provided. Service selection might in general require negotiation to select protocols or protocol options. The same is true between different ORBs: it is necessary to agree which ORB Services are used, and how each transforms the request. Ultimately, these choices become manifest as one or more protocols between the ORBs or as transformations of requests.

In principle, agreement on the use of each ORB Service can be independent of the others and, in appropriately constructed ORBs, services could be layered in any order or in any grouping. This potentially allows applications to specify selective transparencies according to their requirements, although at this time CORBA provides no way to penetrate its transparencies.

A client ORB must be able to determine which ORB Services must be used in order to invoke operations on a server object. Correspondingly, where a client requires dynamic attributes to be associated with specific invocations, or administrative policies dictate, it must be possible to cause the appropriate ORB Services to be used on client and



server sides of the invocation path. Where this is not possible - because, for example, one ORB does not support the full set of services required - either the interaction cannot proceed or it can only do so with reduced facilities or transparencies.

### 13.3 Domains

From a computational viewpoint, the OMG Object Model identifies various distribution transparencies which ensure that client and server objects are presented with a uniform view of a heterogeneous distributed system. From an engineering viewpoint, however, the system is not wholly uniform. There may be distinctions of location and possibly many others such as processor architecture, networking mechanisms and data representations. Even when a single ORB implementation is used throughout the system, local instances may represent distinct, possibly optimized scopes for some aspects of ORB functionality.

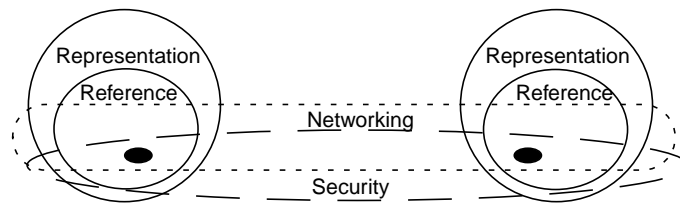

Figure 13-1 Different Kinds of Domains can Coexist.

Interoperability, by definition, introduces further distinctions, notably between the scopes associated with each ORB. To describe both the requirements for interoperability and some of the solutions, this architecture introduces the concept of *domains* to describe the scopes and their implications.

Informally, a domain is a set of objects sharing a common characteristic or abiding by common rules. It is a powerful modelling concept which can simplify the analysis and description of complex systems. There may be many types of domains (e.g., management domains, naming domains, language domains, and technology domains).

#### 13.3.1 Definition of a Domain

Domains allow partitioning of systems into collections of components which have some characteristic in common. In this architecture a domain is a scope in which a collection of objects, said to be members of the domain, is associated with some common characteristic; any object for which the association does not exist, or is undefined, is not a member of the domain. A domain can be modeled as an object and may be itself a member of other domains.

It is the scopes themselves and the object associations or bindings defined within them which characterize a domain. This information is disjoint between domains. However, an object may be a member of several domains, of similar kinds as well as of different kinds, and so the sets of members of domains may overlap.

The concept of a domain boundary is defined as the limit of the scope in which a particular characteristic is valid or meaningful. When a characteristic in one domain is translated to an equivalent in another domain, it is convenient to consider it as traversing the boundary between the two domains.

Domains are generally either administrative or technological in nature. Examples of domains related to ORB interoperability issues are:

- Referencing domain – the scope of an object reference
- Representation domain – the scope of a message transfer syntax and protocol
- Network addressing domain – the scope of a network address
- Network connectivity domain – the potential scope of a network message
- Security domain – the extent of a particular security policy
- Type domain – the scope of a particular type identifier
- Transaction domain – the scope of a given transaction service

Domains can be related in two ways: containment, where a domain is contained within another domain, and federation, where two domains are joined in a manner agreed to and set up by their administrators.

### *13.3.2 Mapping Between Domains: Bridging*

Interoperability between domains is only possible if there is a well-defined mapping between the behaviors of the domains being joined. Conceptually, a mapping mechanism or bridge resides at the boundary between the domains, transforming requests expressed in terms of one domain's model into the model of the destination domain. Note that the use of the term "bridge" in this context is conceptual and refers only to the functionality which performs the required mappings between distinct domains. There are several implementation options for such bridges and these are discussed elsewhere.

For full interoperability, it is essential that all the concepts used in one domain are transformable into concepts in other domains with which interoperability is required, or that if the bridge mechanism filters such a concept out, nothing is lost as far as the supported objects are concerned. In other words, one domain may support a superior service to others, but such a superior functionality will not be available to an application system spanning those domains.

A special case of this requirement is that the object models of the two domains need to be compatible. This specification assumes that both domains are strictly compliant with the CORBA Object Model and the *CORBA* specifications. This includes the use of OMG IDL when defining interfaces, the use of the CORBA Core Interface Repository, and other modifications that were made to *CORBA*. Variances from this model could easily compromise some aspects of interoperability.

## 13.4 Interoperability Between ORBs

An ORB “provides the mechanisms by which objects transparently make and receive requests and responses. In so doing, the ORB provides interoperability between applications on different machines in heterogeneous distributed environments...” ORB interoperability extends this definition to cases in which client and server objects on different ORBs “transparently make and receive requests.”

Note that a direct consequence of this transparency requirement is that bridging must be bidirectional: that is, it must work as effectively for object references passed as parameters as for the target of an object invocation. Were bridging unidirectional (e.g., if one ORB could only be a client to another) then transparency would not have been provided, because object references passed as parameters would not work correctly: ones passed as “callback objects,” for example, could not be used.

Without loss of generality, most of this specification focuses on bridging in only one direction. This is purely to simplify discussions, and does not imply that unidirectional connectivity satisfies basic interoperability requirements.

### 13.4.1 ORB Services and Domains

In this architecture, different aspects of ORB functionality - ORB Services - can be considered independently and associated with different domain types. The architecture does not, however, prescribe any particular decomposition of ORB functionality and interoperability into ORB Services and corresponding domain types. There is a range of possibilities for such a decomposition:

1. The simplest model, for interoperability, is to treat all objects supported by one ORB (or, alternatively, all ORBs of a given type) as comprising one domain. Interoperability between any pair of different domains (or domain types) is then achieved by a specific all-encompassing bridge between the domains. (This is all *CORBA* implies.)
2. More detailed decompositions would identify particular domain types - such as referencing, representation, security, and networking. A core set of domain types would be pre-determined and allowance made for additional domain types to be defined as future requirements dictate (e.g., for new ORB Services).

### 13.4.2 ORBs and Domains

In many respects, issues of interoperability between ORBs are similar to those which can arise with a single type of ORB (e.g., a product). For example:

- Two installations of the ORB may be installed in different security domains, with different Principal identifiers. Requests crossing those security domain boundaries will need to establish locally meaningful Principals for the caller identity, and for any Principals passed as parameters.
- Different installations might assign different type identifiers for equivalent types, and so requests crossing type domain boundaries would need to establish locally meaningful type identifiers (and perhaps more).

Conversely, not all of these problems need to appear when connecting two ORBs of a different type (e.g., two different products). Examples include:

- They could be administered to share user visible naming domains, so that naming domains do not need bridging.
- They might reuse the same networking infrastructure, so that messages could be sent without needing to bridge different connectivity domains.

Additional problems can arise with ORBs of different types. In particular, they may support different concepts or models, between which there are no direct or natural mappings. CORBA only specifies the application level view of object interactions, and requires that distribution transparencies conceal a whole range of lower level issues. It follows that within any particular ORB, the mechanisms for supporting transparencies are not visible at the application-level and are entirely a matter of implementation choice. So there is no guarantee that any two ORBs support similar internal models or that there is necessarily a straightforward mapping between those models.

These observations suggest that the concept of an ORB (instance) is too coarse or superficial to allow detailed analysis of interoperability issues between ORBs. Indeed, it becomes clear that an ORB instance is an elusive notion: it can perhaps best be characterized as the intersection or coincidence of ORB Service domains.

### 13.4.3 Interoperability Approaches

When an interaction takes place across a domain boundary, a mapping mechanism, or bridge, is required to transform relevant elements of the interaction as they traverse the boundary. There are essentially two approaches to achieving this: mediated bridging and immediate bridging. These approaches are described in the following subsections.

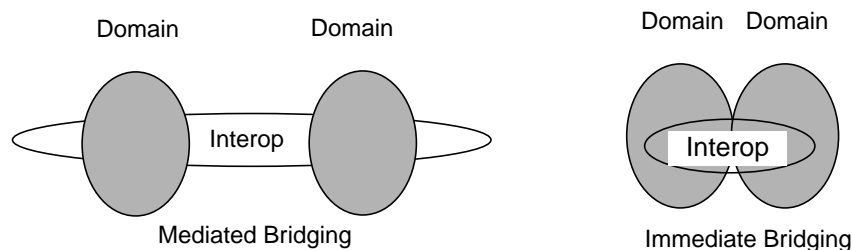

Figure 13-2 Two bridging techniques, different uses of an intermediate form agreed on between the two domains.

#### 13.4.3.1 Mediated Bridging

With mediated bridging, elements of the interaction relevant to the domain are transformed, at the boundary of each domain, between the internal form of that domain and an agreed, common form.

Observations on mediated bridging are as follows:

- The scope of agreement of a common form can range from a private agreement between two particular ORB/domain implementations to a universal standard.

- There can be more than one common form, each oriented or optimized for a different purpose.
- If there is more than one possible common form, then which is used can be static (e.g., administrative policy agreed between ORB vendors, or between system administrators) or dynamic (e.g., established separately for each object, or on each invocation).
- Engineering of this approach can range from in-line specifically compiled (compare to stubs) or generic library code (such as encryption routines), to intermediate bridges to the common form.

### 13.4.3.2 *Immediate Bridging*

With immediate bridging, elements of the interaction relevant to the domain are transformed, at the boundary of each domain, directly between the internal form of one domain and the internal form of the other.

Observations on immediate bridging are as follows:

- This approach has the potential to be optimal (in that the interaction is not mediated via a third party, and can be specifically engineered for each pair of domains) but sacrifices flexibility and generality of interoperability to achieve this.
- This approach is often applicable when crossing domain boundaries which are purely administrative (i.e., there is no change of technology). For example, when crossing security administration domains between similar ORBs, it is not necessary to use a common intermediate standard.

As a general observation, the two approaches can become almost indistinguishable when private mechanisms are used between ORB/domain implementations.

### 13.4.3.3 *Location of Inter-Domain Functionality*

Logically, an inter-domain bridge has components in both domains, whether the mediated or immediate bridging approach is used. However, domains can span ORB boundaries and ORBs can span machine and system boundaries; conversely, a machine may support, or a process may have access to more than one ORB (or domain of a given type). From an engineering viewpoint, this means that the components of an inter-domain bridge may be dispersed or co-located, with respect to ORBs or systems. It also means that the distinction between an ORB and a bridge can be a matter of perspective: there is a duality between viewing inter-system messaging as belonging to ORBs, or to bridges.

For example, if a single ORB encompasses two security domains, the inter-domain bridge could be implemented wholly within the ORB and thus be invisible as far as ORB interoperability is concerned. A similar situation arises when a bridge between two ORBs or domains is implemented wholly within a process or system which has access to both. In such cases, the engineering issues of inter-domain bridging are

confined, possibly to a single system or process. If it were practical to implement all bridging in this way, then interactions between systems or processes would be solely within a single domain or ORB.

#### 13.4.3.4 *Bridging Level*

As noted at the start of this section, bridges may be implemented both internally to an ORB and as layers above it. These are called respectively “in-line” and “request-level” bridges.

Request-level bridges use the CORBA APIs, including the Dynamic Skeleton Interface, to receive and issue requests. However, there is an emerging class of “implicit context” which may be associated with some invocations, holding ORB Service information such as transaction and security context information, which is not at this time exposed through general purpose public APIs. (Those APIs expose only OMG IDL-defined operation parameters, not implicit ones.) Rather, the precedent set with the Transaction Service is that special purpose APIs are defined to allow bridging of each kind of context. This means that request-level bridges must be built to specifically understand the implications of bridging such ORB Service domains, and to make the appropriate API calls.

#### 13.4.4 *Policy-Mediated Bridging*

An assumption made through most of this specification is that the existence of domain boundaries should be transparent to requests: that the goal of interoperability is to hide such boundaries. However, if this were always the goal, then there would be no real need for those boundaries in the first place.

Realistically, administrative domain boundaries exist because they reflect ongoing differences in organizational policies or goals. Bridging the domains will in such cases require *policy mediation*. That is, inter-domain traffic will need to be constrained, controlled, or monitored; fully transparent bridging may be highly undesirable. Resource management policies may even need to be applied, restricting some kinds of traffic during certain periods.

Security policies are a particularly rich source of examples: a domain may need to audit external access, or to provide domain-based access control. Only a very few objects, types of objects, or classifications of data might be externally accessible through a “firewall.”

Such policy-mediated bridging requires a bridge that knows something about the traffic being bridged. It could in general be an application-specific policy, and many policy-mediated bridges could be parts of applications. Those might be organization-specific, off-the-shelf, or anywhere in between.

Request-level bridges, which use only public ORB APIs, easily support the addition of policy mediation components, without loss of access to any other system infrastructure that may be needed to identify or enforce the appropriate policies.

### 13.4.5 Configurations of Bridges in Networks

In the case of network-aware ORBs, we anticipate that some ORB protocols will be more frequently bridged to than others, and so will begin to serve the role of “backbone ORBs.” (This is a role that the IIOP is specifically expected to serve.) This use of “backbone topology” is true both on a large scale and a small scale. While a large scale public data network provider could define its own backbone ORB, on a smaller scale, any given institution will probably designate one commercially available ORB as its backbone.

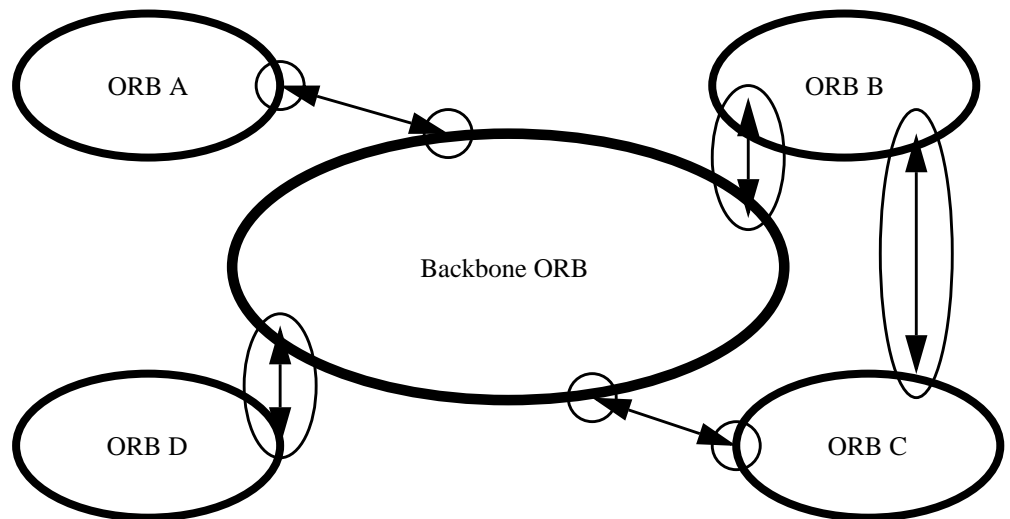

Figure 13-3 An ORB chosen as a backbone will connect other ORBs through bridges, both full-bridges and half-bridges.

Adopting a backbone style architecture is a standard administrative technique for managing networks. It has the consequence of minimizing the number of bridges needed, while at the same time making the ORB topology match typical network organizations. (That is, it allows the number of bridges to be proportional to the number of protocols, rather than combinatorial.)

In large configurations, it will be common to notice that adding ORB bridges doesn’t even add any new “hops” to network routes, because the bridges naturally fit in locations where connectivity was already indirect, and augment or supplant the existing network firewalls.

## 13.5 Object Addressing

The Object Model (see Chapter 1, Requests) defines an object reference as an object name that reliably denotes a particular object. An object reference identifies the same object each time the reference is used in a request, and an object may be denoted by multiple, distinct references.

The fundamental ORB interoperability requirement is to allow clients to use such object names to invoke operations on objects in other ORBs. Clients do not need to distinguish between references to objects in a local ORB or in a remote one. Providing this transparency can be quite involved, and naming models are fundamental to it.

This section discusses models for naming entities in multiple domains, and transformations of such names as they cross the domain boundaries. That is, it presents transformations of object reference information as it passes through networks of inter-ORB bridges. It uses the word “ORB” as synonymous with referencing domain; this is purely to simplify the discussion. In other contexts, “ORB” can usefully denote other kinds of domain.

### *13.5.1 Domain-relative Object Referencing*

Since CORBA does not require ORBs to understand object references from other ORBs, when discussing object references from multiple ORBs one must always associate the object reference’s domain (ORB) with the object reference. We use the notation *DO.R0* to denote an object reference *R0* from domain *DO*; this is itself an object reference. This is called “domain-relative” referencing (or addressing) and need not reflect the implementation of object references within any ORB.

At an implementation level, associating an object reference with an ORB is only important at an inter-ORB boundary; that is, inside a bridge. This is simple, since the bridge knows from which ORB each request (or response) came, including any object references embedded in it.

### *13.5.2 Handling of Referencing Between Domains*

When a bridge hands an object reference to an ORB, it must do so in a form understood by that ORB: the object reference must be in the recipient ORB’s native format. Also, in cases where that object originated from some other ORB, the bridge must associate each newly created “proxy” object reference with (what it sees as) the original object reference.

Several basic schemes to solve these two problems exist. These all have advantages in some circumstances; all can be used, and in arbitrary combination with each other, since CORBA object references are opaque to applications. The ramifications of each scheme merits attention, with respect to scaling and administration. The schemes include:

1. *Object Reference Translation Reference Embedding*: The bridge can store the original object reference itself, and pass an entirely different proxy reference into the new domain. The bridge must then manage state on behalf of each bridged object reference, map these references from one ORB’s format to the other’s, and vice versa.



2. *Reference Encapsulation*: The bridge can avoid holding any state at all by conceptually concatenating a domain identifier to the object name. Thus if a reference  $D0.R$ , originating in domain  $D0$ , traversed domains  $D1... D4$  it could be identified in  $D4$  as proxy reference  $d3.d2.d1.d0.R$ , where  $dn$  is the address of  $Dn$  relative to  $Dn+1$ .

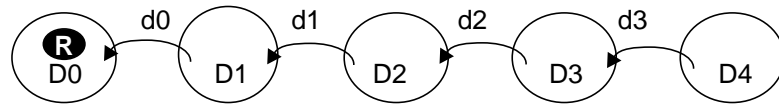

Figure 13-4 Reference encapsulation adds domain information during bridging.

3. *Domain Reference Translation*: Like object reference translation, this scheme holds some state in the bridge. However, it supports sharing that state between multiple object references by adding a domain-based route identifier to the proxy (which still holds the original reference, as in the reference encapsulation scheme). It achieves this by providing encoded domain route information each time a domain boundary is traversed; thus if a reference  $D0.R$ , originating in domain  $D0$ , traversed domains  $D1...D4$  it would be identified in  $D4$  as  $(d3, x3).R$ , and in  $D2$  as  $(d1, x1).R$ , and so on, where  $dn$  is the address of  $Dn$  relative to  $Dn+1$ , and  $xn$  identifies the pair  $(dn-1, xn-1)$ .

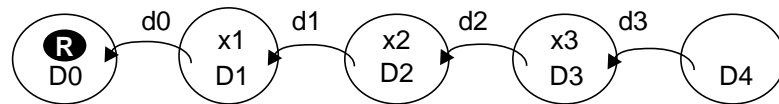

Figure 13-5 Domain Reference Translation substitutes domain references during bridging.

4. *Reference Canonicalization*: This scheme is like domain reference translation, except that the proxy uses a “well-known” (e.g., global) domain identifier rather than an encoded path. Thus a reference  $R$ , originating in domain  $D0$  would be identified in other domains as  $D0.R$ .

Observations about these approaches to inter-domain reference handling are as follows:

- Naive application of reference encapsulation could lead to arbitrarily large references. A “topology service” could optimize cycles within any given encapsulated reference and eliminate the appearance of references to local objects as alien references.
- A topology service could also optimize the chains of routes used in the domain reference translation scheme. Since the links in such chains are re-used by any path traversing the same sequence of domains, such optimization has particularly high leverage.

- With the general purpose APIs defined in *CORBA*, object reference translation can be supported even by ORBs not specifically intended to support efficient bridging, but this approach involves the most state in intermediate bridges. As with reference encapsulation, a topology service could optimize individual object references. (APIs are defined by the Dynamic Skeleton Interface and Dynamic Invocation Interface)
- The chain of addressing links established with both object and domain reference translation schemes must be represented as state within the network of bridges. There are issues associated with managing this state.
- Reference canonicalization can also be performed with managed hierarchical name spaces such as those now in use on the Internet and X.500 naming.

## 13.6 *An Information Model for Object References*

This section provides a simple, powerful information model for the information found in an object reference. That model is intended to be used directly by developers of bridging technology, and is used in that role by the IIOP, described in the *General Inter-ORB Protocol* chapter, *Object References* section.

### 13.6.1 *What Information Do Bridges Need?*

The following potential information about object references has been identified as critical for use in bridging technologies:

- *Is it null?* Nulls only need to be transmitted and never support operation invocation.
- *What type is it?* Many ORBs require knowledge of an object's type in order to efficiently preserve the integrity of their type systems.
- *What protocols are supported?* Some ORBs support objrefs that in effect live in multiple referencing domains, to allow clients the choice of the most efficient communications facilities available.
- *What ORB Services are available?* As noted in Section 13.2.3, "Selection of ORB Services" on page 13-4, several different ORB Services might be involved in an invocation. Providing information about those services in a standardized way could in many cases reduce or eliminate negotiation overhead in selecting them.

### 13.6.2 *Interoperable Object References: IORs*

To provide the information above, an "Interoperable Object Reference," (IOR) data structure has been provided. This data structure need not be used internally to any given ORB, and is not intended to be visible to application-level ORB programmers. It should be used only when crossing object reference domain boundaries, within bridges.

This data structure is designed to be efficient in typical single-protocol configurations, while not penalizing multiprotocol ones.

```

module IOP { // IDL

 // Standard Protocol Profile tag values

 typedef unsigned long ProfileId;

 struct TaggedProfile {
 ProfileId tag;
 sequence <octet> profile_data;
 };
 typedef sequence <TaggedProfile> TaggedProfileSeq ;

 // an Interoperable Object Reference is a sequence of
 // object-specific protocol profiles, plus a type ID.

 struct IOR {
 string type_id;
 sequence <TaggedProfile> profiles;
 };

 // Standard way of representing multicomponent profiles.
 // This would be encapsulated in a TaggedProfile.

 typedef unsigned long ComponentId;
 struct TaggedComponent {
 ComponentId tag;
 sequence <octet> component_data;
 };
 typedef sequence<TaggedComponent> TaggedComponentSeq;
};

```

### 13.6.3 IOR Profiles

Object references have at least one *tagged profile*. Each profile supports one or more protocols and encapsulates all the basic information the protocols it supports need to identify an object. Any single profile holds enough information to drive a complete invocation using any of the protocols it supports; the content and structure of those profile entries are wholly specified by these protocols.

When a specific protocol is used to convey an object reference passed as a parameter in an IDL operation invocation (or reply), an IOR which reflects, in its contained profiles, the full protocol understanding of the operation client (or server in case of reply) may be sent. A receiving ORB which operates (based on topology and policy information available to it) on profiles rather than the received IOR as a whole, to create a derived reference for use in its own domain of reference, is placing itself as a bridge between reference domains. Interoperability inhibiting situations can arise when an orb sends an IOR with multiple profiles (using one of its supported protocols)

to a receiving orb, and that receiving orb later returns a derived reference to that object, which has had profiles or profile component data removed or transformed from the original IOR contents.

To assist in classifying behavior of ORBS in such bridging roles, two classes of IOR conformance may be associated with the conformance requirements for a given ORB interoperability protocol:

- Full IOR conformance requires that an orb which receives an IOR for an object passed to it through that ORB interoperability protocol, shall recover the original IOR, in its entirety, for passing as a reference to that object from that orb through that same protocol
- Limited-Profile IOR conformance requires that an orb which receives an IOR passed to it through a given ORB interoperability protocol, shall recover all of the standard information contained in the IOR profile for that protocol, whenever passing a reference to that object, using that same protocol, to another ORB.

---

**Note** – Conformance to IIOP versions 1.0, 1.1 and 1.2 only requires support of limited-Profile IOR conformance, specifically for the IIOP IOR profile. However, due to interoperability problems induced by Limited-Profile IOR conformance, it is now deprecated by the CORBA 2.4 specification for an orb to not support Full IOR conformance. Some future IIOP versions could require Full IOR conformance.

---

An ORB may be unable to use any of the profiles provided in an IOR for various reasons which may be broadly categorized as transient ones like temporary network outage, and non-transient ones like unavailability of appropriate protocol software in the ORB. The decision about the category of outage that causes an ORB to be unable to use any profile from an IOR is left up to the ORB. At an appropriate point, when an ORB discovers that it is unable to use any profile in an IOR, depending on whether it considers the reason transient or non-transient, it should raise the standard system exception **TRANSIENT** with standard minor code 2, or **IMP\_LIMIT** with the standard minor code 1.

Each profile has a unique numeric tag, assigned by the OMG. The ones defined here are for the IIOP (see Section 15.7.3, “IIOP IOR Profile Components” on page 15-55) and for use in “multiple component profiles.” Profile tags in the range **0x80000000** through **0xffffffff** are reserved for future use, and are not currently available for assignment.

Null object references are indicated by an empty set of profiles, and by a “Null” type ID (a string which contains only a single terminating character). Type IDs may only be “Null” in any message, requiring the client to use existing knowledge or to consult the object, to determine interface types supported. The type ID is a Repository ID identifying the interface type, and is provided to allow ORBs to preserve strong typing. This identifier is agreed on within the bridge and, for reasons outside the scope of this interoperability specification, needs to have a much broader scope to address various problems in system evolution and maintenance. Type IDs support detection of type equivalence, and in conjunction with an Interface Repository, allow processes to reason about the relationship of the type of the object referred to and any other type.

The type ID, if provided by the server, indicates the most derived type that the server wishes to publish, at the time the reference is generated. The object's actual most derived type may later change to a more derived type. Therefore, the type ID in the IOR can only be interpreted by the client as a hint that the object supports at least the indicated interface. The client can succeed in narrowing the reference to the indicated interface, or to one of its base interfaces, based solely on the type ID in the IOR, but must not fail to narrow the reference without consulting the object via the “\_is\_a” or “\_get\_interface” pseudo-operations.

ORBs claiming to support the Full-IOR conformance are required to preserve all the semantic content of any IOR (including the ordering of each profile and its components), and may only apply transformations which preserve semantics (e.g., changing Byte order for encapsulation).

For example, consider an echo operation for object references:

```
interface Echoer {Object echo(in Object o);};
```

Assume that the method body implementing this “echo” operation simply returns its argument. When a client application invokes the echo operation and passes an arbitrary object reference, if both the client and server ORBs claim support to Full IOR conformance, the reference returned by the operation is guaranteed to have not been semantically altered by either client or server ORB. That is, all its profiles will remain intact and in the same order as they were present when the reference was sent. This requirement for ORBs which claim support for Full-IOR conformance, ensures that, for example, a client can safely store an object reference in a naming service and get that reference back again later without losing information inside the reference.

### 13.6.4 Standard IOR Profiles

```
module IOP {
 const ProfileId TAG_INTERNET_IOP = 0;
 const ProfileId TAG_MULTIPLE_COMPONENTS = 1;
 const ProfileId TAG_SCCP_IOP = 2;

 typedef sequence <TaggedComponent> MultipleComponentProfile;
};
```

#### 13.6.4.1 The TAG\_INTERNET\_IOP Profile

The **TAG\_INTERNET\_IOP** tag identifies profiles that support the Internet Inter-ORB Protocol. The **ProfileBody** of this profile, described in detail in Section 15.7.2, “IOP IOR Profiles” on page 15-52, contains a CDR encapsulation of a structure containing addressing and object identification information used by IOP. Version 1.1 of the **TAG\_INTERNET\_IOP** profile also includes a **sequence<TaggedComponent>** that can contain additional information supporting optional IOP features, ORB services such as security, and future protocol extensions.

Protocols other than IIOP (such as ESIOPs and other GIOPs) can share profile information (such as object identity or security information) with IIOP by encoding their additional profile information as components in the **TAG\_INTERNET\_IOP** profile. All **TAG\_INTERNET\_IOP** profiles support IIOP, regardless of whether they also support additional protocols. Interoperable ORBs are not required to create or understand any other profile, nor are they required to create or understand any of the components defined for other protocols that might share the **TAG\_INTERNET\_IOP** profile with IIOP.

The **profile\_data** for the **TAG\_INTERNET\_IOP** profile is a CDR encapsulation of the **IOP::ProfileBody\_1\_1** type, described in Section 15.7.2, “IIOP IOR Profiles” on page 15-52.

#### 13.6.4.2 *The TAG\_MULTIPLE\_COMPONENTS Profile*

The **TAG\_MULTIPLE\_COMPONENTS** tag indicates that the value encapsulated is of type **MultipleComponentProfile**. In this case, the profile consists of a list of protocol components, the use of which must be specified by the protocol using this profile. This profile may be used to carry IOR components, as specified in Section 13.6.5, “IOR Components” on page 13-18.

The **profile\_data** for the **TAG\_MULTIPLE\_COMPONENTS** profile is a CDR encapsulation of the **MultipleComponentProfile** type shown above.

#### 13.6.4.3 *The TAG\_SCCP\_IOP Profile*

See the CORBA/IN Interworking specification (dtc/2000-02-02).

### 13.6.5 *IOR Components*

**TaggedComponents** contained in **TAG\_INTERNET\_IOP** and **TAG\_MULTIPLE\_COMPONENTS** profiles are identified by unique numeric tags using a namespace distinct from that is used for profile tags. Component tags are assigned by the OMG.

Specifications of components must include the following information:

- *Component ID*: The compound tag that is obtained from OMG.
- *Structure and encoding*: The syntax of the component data and the encoding rules. If the component value is encoded as a CDR encapsulation, the IDL type that is encapsulated and the GIOP version which is used for encoding the value, if different than GIOP 1.0, must be specified as part of the component definition.
- *Semantics*: How the component data is intended to be used.
- *Protocols*: The protocol for which the component is defined, and whether it is intended that the component be usable by other protocols.
- *At most once*: whether more than one instance of this component can be included in a profile.

Specifications of protocols must describe how the components affect the protocol. In addition, a protocol definition must specify, for each TaggedComponent, whether inclusion of the component in profiles supporting the protocol is required (MANDATORY PRESENCE) or not required (OPTIONAL PRESENCE). An ORB claiming to support Full-IOR conformance shall not drop optional components, once they have been added to a profile.

### 13.6.6 Standard IOR Components

The following are standard IOR components that can be included in **TAG\_INTERNET\_IOP** and **TAG\_MULTIPLE\_COMPONENTS** profiles, and may apply to IIOP, other GIOPs, ESIOPs, or other protocols. An ORB must not drop these components from an existing IOR.

```

module IOP {
 const ComponentId TAG_ORB_TYPE = 0;
 const ComponentId TAG_CODE_SETS = 1;
 const ComponentId TAG_POLICIES = 2;
 const ComponentId TAG_ALTERNATE_IIOP_ADDRESS = 3;

 const ComponentId TAG_ASSOCIATION_OPTIONS = 13;
 const ComponentId TAG_SEC_NAME = 14;
 const ComponentId TAG_SPKM_1_SEC_MECH = 15;
 const ComponentId TAG_SPKM_2_SEC_MECH = 16;
 const ComponentId TAG_KerberosV5_SEC_MECH = 17;
 const ComponentId TAG_CSI_ECMA_Secret_SEC_MECH = 18;
 const ComponentId TAG_CSI_ECMA_Hybrid_SEC_MECH = 19;
 const ComponentId TAG_SSL_SEC_TRANS = 20;
 const ComponentId TAG_CSI_ECMA_Public_SEC_MECH = 21;
 const ComponentId TAG_GENERIC_SEC_MECH = 22;
 const ComponentId TAG_FIREWALL_TRANS = 23;
 const ComponentId TAG_SCCP_CONTACT_INFO = 24;
 const ComponentId TAG_JAVA_CODEBASE = 25;
 const ComponentId TAG_TRANSACTION_POLICY = 26;
 const ComponentId TAG_MESSAGE_ROUTERS = 30;
 const ComponentId TAG_OTS_POLICY = 31;
 const ComponentId TAG_INV_POLICY = 32;
 const ComponentId TAG_CSI_SEC_MECH_LIST = 33;
 const ComponentId TAG_NULL_TAG = 34;
 const ComponentId TAG_SECIOP_SEC_TRANS = 35;
 const ComponentId TAG_TLS_SEC_TRANS = 36;
 const ComponentId TAG_ACTIVITY_POLICY = 37;
 const ComponentId TAG_INET_SEC_TRANS = 123;
};

```

The following additional components that can be used by other protocols are specified in the DCE ESIOP chapter of this document and *CORBAServices*, Security Service, in the Security Service for DCE ESIOP section:

```

const ComponentId TAG_COMPLETE_OBJECT_KEY = 5;

```

```

const ComponentId TAG_ENDPOINT_ID_POSITION = 6;
const ComponentId TAG_LOCATION_POLICY = 12;
const ComponentId TAG_DCE_STRING_BINDING = 100;
const ComponentId TAG_DCE_BINDING_NAME = 101;
const ComponentId TAG_DCE_NO_PIPES = 102;
const ComponentId TAG_DCE_SEC_MECH = 103; // Security Service

```

### 13.6.6.1 *TAG\_ORB\_TYPE Component*

It is often useful in the real world to be able to identify the particular kind of ORB an object reference is coming from, to work around problems with that particular ORB, or exploit shared efficiencies.

The **TAG\_ORB\_TYPE** component has an associated value of type **unsigned long**, encoded as a CDR encapsulation, designating an ORB type ID allocated by the OMG for the ORB type of the originating ORB. Anyone may register any ORB types by submitting a short (one-paragraph) description of the ORB type to the OMG, and will receive a new ORB type ID in return. A list of ORB type descriptions and values will be made available on the OMG web server.

The **TAG\_ORB\_TYPE** component can appear at most once in any IOR profile. For profiles supporting IIOP 1.1 or greater, it is optionally present.

### 13.6.6.2 *TAG\_ALTERNATE\_IOP\_ADDRESS Component*

In cases where the same object key is used for more than one internet location, the following standard IOR Component is defined for support in IIOP version 1.2.

The **TAG\_ALTERNATE\_IOP\_ADDRESS** component has an associated value of type

```

struct {
 string HostID,
 unsigned short Port
};

```

encoded as a CDR encapsulation.

Zero or more instances of the **TAG\_ALTERNATE\_IOP\_ADDRESS** component type may be included in a version 1.2 **TAG\_INTERNET\_IOP** Profile. Each of these alternative addresses may be used by the client orb, in addition to the host and port address expressed in the body of the Profile. In cases where one or more **TAG\_ALTERNATE\_IOP\_ADDRESS** components are present in a **TAG\_INTERNET\_IOP** Profile, no order of use is prescribed by Version 1.2 of IIOP.

### 13.6.6.3 *Other Components*

The following standard components are specified in various OMG specifications:

- **TAG\_CODE\_SETS** - See Section 13.10.2.4, “CodeSet Component of IOR Multi-Component Profile” on page 13-43.



- TAG\_POLICIES - See the CORBA Messaging chapter.
- TAG\_SEC\_NAME - See the Security Service specification, Mechanism Tags section.
- TAG\_ASSOCIATION\_OPTIONS - See the Security Service specification, Tag Association Options section.
- TAG\_SSL\_SEC\_TRANS - See the Security Service specification, Mechanism Tags section.
- TAG\_GENERIC\_SEC\_MECH and all other tags with names in the form TAG\_\*\_SEC\_MECH - See the Security Service specification, Mechanism Tags section.
- TAG\_FIREWALL\_SEC - See the Firewall specification (orbos/98-05-04).
- TAG\_SCCP\_CONTACT\_INFO - See the CORBA/IN Interworking specification (telecom/98-10-03).
- TAG\_JAVA\_CODEBASE - See the Java to IDL Language Mapping specification (formal/99-07-59), Codebase Transmission section.
- TAG\_TRANSACTION\_POLICY - See the Object Transaction Service specification (formal/00-06-28).
- TAG\_MESSAGE\_ROUTERS - See the CORBA Messaging chapter.
- TAG\_OTS\_POLICY - See the Object Transaction Service specification (formal/00-06-28).
- TAG\_INV\_POLICY - See the Object Transaction Service specification (formal/00-06-28).
- TAG\_INET\_SEC\_TRANS - See the Security Service specification (formal/00-06-25).
- TAG\_CSI\_SEC\_MECH\_LIST, TAG\_NULL\_TAG, TAG\_SECIOP\_SEC\_TRANS, TAG\_TLS\_SEC\_TRANS - See the Secure Interoperability chapter.
- TAG\_ACTIVITY\_POLICY - See the Additional Structuring Mechanisms for OTS specification (orbos/01-11-08).
- TAG\_COMPLETE\_OBJECT\_KEY (See Section 16.5.4, “Complete Object Key Component” on page 16-19).
- TAG\_ENDPOINT\_ID\_POSITION (See Section 16.5.5, “Endpoint ID Position Component” on page 16-20).
- TAG\_LOCATION\_POLICY (See Section 16.5.6, “Location Policy Component” on page 16-20).
- TAG\_DCE\_STRING\_BINDING (See Section 16.5.1, “DCE-CIOP String Binding Component” on page 16-17).
- TAG\_DCE\_BINDING\_NAME (See Section 16.5.2, “DCE-CIOP Binding Name Component” on page 16-18).

- TAG\_DCE\_NO\_PIPES (See Section 16.5.3, “DCE-CIOP No Pipes Component” on page 16-19).

### *13.6.7 Profile and Component Composition in IORs*

The following rules augment the preceding discussion:

1. Profiles must be independent, complete, and self-contained. Their use shall not depend on information contained in another profile.
2. Any invocation uses information from exactly one profile.
3. Information used to drive multiple inter-ORB protocols may coexist within a single profile, possibly with some information (e.g., components) shared between the protocols, as specified by the specific protocols.
4. Unless otherwise specified in the definition of a particular profile, multiple profiles with the same profile tag may be included in an IOR.
5. Unless otherwise specified in the definition of a particular component, multiple components with the same component tag may be part of a given profile within an IOR.
6. A **TAG\_MULTIPLE\_COMPONENTS** profile may hold components shared between multiple protocols. Multiple such profiles may exist in an IOR.
7. The definition of each protocol using a **TAG\_MULTIPLE\_COMPONENTS** profile must specify which components it uses, and how it uses them.
8. Profile and component definitions can be either public or private. Public definitions are those whose tag and data format is specified in OMG documents. For private definitions, only the tag is registered with OMG.
9. Public component definitions shall state whether or not they are intended for use by protocols other than the one(s) for which they were originally defined, and dependencies on other components.

The OMG is responsible for allocating and registering protocol and component tags. Neither allocation nor registration indicates any “standard” status, only that the tag will not be confused with other tags. Requests to allocate tags should be sent to [tag\\_request@omg.org](mailto:tag_request@omg.org).

### *13.6.8 IOR Creation and Scope*

IORs are created from object references when required to cross some kind of referencing domain boundary. ORBs will implement object references in whatever form they find appropriate, including possibly using the IOR structure. Bridges will normally use IORs to mediate transfers where that standard is appropriate.

### 13.6.9 Stringified Object References

Object references can be “stringified” (turned into an external string form) by the **ORB::object\_to\_string** operation, and then “destringified” (turned back into a programming environment’s object reference representation) using the **ORB::string\_to\_object** operation.

There can be a variety of reasons why being able to parse this string form might *not* help make an invocation on the original object reference:

- Identifiers embedded in the string form can belong to a different domain than the ORB attempting to destringify the object reference.
- The ORBs in question might not share a network protocol, or be connected.
- Security constraints may be placed on object reference destringification.

Nonetheless, there is utility in having a defined way for ORBs to generate and parse stringified IORs, so that in some cases an object reference stringified by one ORB could be destringified by another.

To allow a stringified object reference to be internalized by what may be a different ORB, a stringified IOR representation is specified. This representation instead establishes that ORBs could parse stringified object references using that format. This helps address the problem of bootstrapping, allowing programs to obtain and use object references, even from different ORBs.

The following is the representation of the stringified (externalized) IOR:

|      |                           |                                                                    |
|------|---------------------------|--------------------------------------------------------------------|
| (1)  | <b>&lt;oref&gt;</b>       | ::= <prefix> <hex_Octets>                                          |
| (2)  | <b>&lt;prefix&gt;</b>     | ::= <i><o><r>“:”                                                   |
| (3)  | <b>&lt;hex_Octets&gt;</b> | ::= <hex_Octet> {<hex_Octet>}*                                     |
| (4)  | <b>&lt;hex_Octet&gt;</b>  | ::= <hexDigit> <hexDigit>                                          |
| (5)  | <b>&lt;hexDigit&gt;</b>   | ::= <digit>   <a>   <b>   <c>   <d>   <e>   <f>                    |
| (6)  | <b>&lt;digit&gt;</b>      | ::= “0”   “1”   “2”   “3”   “4”   “5”  <br>  “6”   “7”   “8”   “9” |
| (7)  | <b>&lt;a&gt;</b>          | ::= “a”   “A”                                                      |
| (8)  | <b>&lt;b&gt;</b>          | ::= “b”   “B”                                                      |
| (9)  | <b>&lt;c&gt;</b>          | ::= “c”   “C”                                                      |
| (10) | <b>&lt;d&gt;</b>          | ::= “d”   “D”                                                      |
| (11) | <b>&lt;e&gt;</b>          | ::= “e”   “E”                                                      |
| (12) | <b>&lt;f&gt;</b>          | ::= “f”   “F”                                                      |
| (13) | <b>&lt;i&gt;</b>          | ::= “i”   “I”                                                      |
| (14) | <b>&lt;o&gt;</b>          | ::= “o”   “O”                                                      |
| (15) | <b>&lt;r&gt;</b>          | ::= “r”   “R”                                                      |

---

**Note** – The case for characters in a stringified IOR is not significant.

---

The hexadecimal strings are generated by first turning an object reference into an IOR, and then encapsulating the IOR using the encoding rules of CDR, as specified in GIOP 1.0. (See Section 15.3, “CDR Transfer Syntax” on page 15-4 for more information.) The content of the encapsulated IOR is then turned into hexadecimal digit pairs, starting with the first octet in the encapsulation and going until the end. The high four bits of each octet are encoded as a hexadecimal digit, then the low four bits.

### 13.6.10 Object URLs

To address the problem of bootstrapping and allow for more convenient exchange of human-readable object references, **ORB::string\_to\_object** allows URLs in the **corbaloc** and **corbaname** formats to be converted into object references.

If conversion fails, **string\_to\_object** raises a **BAD\_PARAM** exception with one of following standard minor codes, as appropriate:

- 7 - **string\_to\_object** conversion failed due to bad scheme name
- 8 - **string\_to\_object** conversion failed due to bad address
- 9 - **string\_to\_object** conversion failed due to bad bad schema specific part
- 10 - **string\_to\_object** conversion failed due to non specific reason

#### 13.6.10.1 corbaloc URL

The **corbaloc** URL scheme provides stringified object references that are more easily manipulated by users than **IOR** URLs. Currently, **corbaloc** URLs denote objects that can be contacted by IIOP or **resolve\_initial\_references**. Other transport protocols can be explicitly specified when they become available. Examples of IIOP and **resolve\_initial\_references** (**rir**;) based **corbaloc** URLs are:

```
corbaloc::555xyz.com/Prod/TradingService
corbaloc:iiop:1.1@555xyz.com/Prod/TradingService
corbaloc::555xyz.com,:556xyz.com:80/Dev/NameService
corbaloc:rir:/TradingService
corbaloc:rir:/NameService
```

A **corbaloc** URL contains one or more:

- protocol identifiers
- protocol specific components such as address and protocol version information

When the **rir** protocol is used, no other protocols are allowed.

After the addressing information, a **corbaloc** URL ends with a single object key.

The full syntax is:

```
<corbaloc> = "corbaloc:"<obj_addr_list>["/"<key_string>]
<obj_addr_list> = [<obj_addr> ","]* <obj_addr>
<obj_addr> = <prot_addr> | <future_prot_addr>
<prot_addr> = <rir_prot_addr> | <iiop_prot_addr>
```

|                                        |                                                                   |
|----------------------------------------|-------------------------------------------------------------------|
| <code>&lt;rir_prot_addr&gt;</code>     | = <code>&lt;rir_prot_token&gt;”:</code>                           |
| <code>&lt;rir_prot_token&gt;</code>    | = <code>“rir”</code>                                              |
| <code>&lt;iiop_prot_addr&gt;</code>    | = <code>&lt;iiop_id&gt;&lt;iiop_addr&gt;</code>                   |
| <code>&lt;iiop_id&gt;</code>           | = <code>“:”   &lt;iiop_prot_token&gt;”:</code>                    |
| <code>&lt;iiop_prot_token&gt;</code>   | = <code>“iiop”</code>                                             |
| <code>&lt;iiop_addr&gt;</code>         | = [ <code>&lt;version&gt; &lt;host&gt; [“:” &lt;port&gt;]]</code> |
| <code>&lt;host&gt;</code>              | = <code>DNS_style_Host_Name   ip_address</code>                   |
| <code>&lt;version&gt;</code>           | = <code>&lt;major&gt; “.” &lt;minor&gt; “@”   empty_string</code> |
| <code>&lt;port&gt;</code>              | = <code>number</code>                                             |
| <code>&lt;major&gt;</code>             | = <code>number</code>                                             |
| <code>&lt;minor&gt;</code>             | = <code>number</code>                                             |
| <code>&lt;future_prot_addr&gt;</code>  | = <code>&lt;future_prot_id&gt;&lt;future_prot_addr&gt;</code>     |
| <code>&lt;future_prot_id&gt;</code>    | = <code>&lt;future_prot_token&gt;”:</code>                        |
| <code>&lt;future_prot_token&gt;</code> | = possible examples: <code>“atm”   “dce”</code>                   |
| <code>&lt;future_prot_addr&gt;</code>  | = <code>protocol specific address</code>                          |
| <code>&lt;key_string&gt;</code>        | = <code>&lt;string&gt;   empty_string</code>                      |

Where:

**obj\_addr\_list:** comma-separated list of protocol id, version, and address information. This list is used in an implementation-defined manner to address the object. An object may be contacted by any of the addresses and protocols.

---

**Note** – If the **rir** protocol is used, no other protocols are allowed.

---

**obj\_addr:** A protocol identifier, version tag, and a protocol specific address. The comma ‘,’ and ‘/’ characters are specifically prohibited in this component of the URL.

**rir\_prot\_addr:** **resolve\_initial\_references** protocol identifier. This protocol does not have a version tag or address. See Section 13.6.10.2, “**corbaloc:rir** URL”.

**iiop\_prot\_addr:** **iiop** protocol identifier, version tag, and address containing a DNS-style host name or IP address. See Section 13.6.10.3, “**corbaloc:iiop** URL” for the **iiop** specific definitions.

**future\_prot\_addr:** a placeholder for future **corbaloc** protocols.

**future\_prot\_id:** token representing a protocol terminated with a “:”.

**future\_prot\_token:** token representing a protocol. Currently only “**iiop**” and “**rir**” are defined.

**future\_prot\_addr:** a protocol specific address and possibly protocol version information. An example of this for **iiop** is “**1.1@555xyz.com**”.

**key\_string:** a stringified object key.

The **key\_string** corresponds to the octet sequence in the **object\_key** member of a **GIOP Request** or **LocateRequest** header as defined in section 15.4 of CORBA 2.3. The **key\_string** uses the escape conventions described in RFC 2396 to map away

from octet values that cannot directly be part of a URL. US-ASCII alphanumeric characters are not escaped. Characters outside this range are escaped, except for the following:

```
“;” | “/” | “.” | “?” | “:” | “@” | “&” | “=” | “+” | “$” |
“,” | “-” | “_” | “!” | “~” | “*” | “” | “(” | “)”
```

The **key\_string** is not NUL-terminated.

### 13.6.10.2 *corbaloc:rir URL*

The *corbaloc:rir* URL is defined to allow access to the ORB’s configured initial references through a URL.

The protocol address syntax is:

```
<rir_prot_addr> = <rir_prot_token>“:”
<rir_prot_token> = “rir”
```

Where:

**rir\_prot\_addr:** **resolve\_initial\_references** protocol identifier. There is no version or address information when **rir** is used.

**rir\_prot\_token:** The token “**rir**” identifies this protocol..

For a **corbaloc:rir** URL, the **<key\_string>** is used as the argument to **resolve\_initial\_references**. An empty **<key\_string>** is interpreted as the default “**NameService**”.

The **rir** protocol can not be used with any other protocol in a URL.

### 13.6.10.3 *corbaloc:iiop URL*

The *corbaloc:iiop* URL is defined for use in TCP/IP- and DNS-centric environments. The full protocol address syntax is:

```
<iiop_prot_addr> = <iiop_id><iiop_addr>
<iiop_id> = <iiop_default> | <iiop_prot_token>“:”
<iiop_default> = “.”
<iiop_prot_token> = “iiop”
<iiop_addr> = [<version> <host> [“:” <port>]]
<host> = DNS_style_Host_Name | ip_address
<version> = <major> “.” <minor> “@” | empty_string
<port> = number
<major> = number
<minor> = number
```

Where:

**iiop\_prot\_addr:** **iiop** protocol identifier, version tag, and address containing a DNS-style host name or IP address.

**iiop\_id:** tokens recognized to indicate an iiop protocol corbaloc.

**iiop\_default:** default token indicating iiop protocol, “:”.

**iiop\_prot\_token:** iiop protocol token, “iiop”

**iiop\_address:** a single address

**host:** DNS-style host name or IP address. If not present, the local host is assumed.

**version:** a major and minor version number, separated by ‘.’ and followed by ‘@’. If the version is absent, 1.0 is assumed.

**ip\_address:** numeric IP address (dotted decimal notation)

**port:** port number the agent is listening on (see below). Default is 2809.

#### 13.6.10.4 *corbaloc Server Implementation*

The only requirements on an object advertised by a **corbaloc** URL are that there must be a software agent listening on the host and port specified by the URL. This agent must be capable of handling GIOP **Request** and **LocateRequest** messages targeted at the object key specified in the URL.

A normal CORBA server meets these criteria. It is also possible to implement lightweight object location forwarding agents that respond to GIOP **Request** messages with **Reply** messages with a **LOCATION\_FORWARD** status, and respond to GIOP **LocateRequest** messages with **LocateReply** messages.

#### 13.6.10.5 *corbaname URL*

The **corbaname** URL scheme is described in the Naming Service specification. It extends the capabilities of the **corbaloc** scheme to allow URLs to denote entries in a Naming Service. Resolving **corbaname** URLs does not require a Naming Service implementation in the ORB core. Some examples are:

**corbaname::555objs.com#a/string/path/to/obj**

This URL specifies that at host **555objs.com**, a object of type **NamingContext** (with an object key of **NameService**) can be found, or alternatively, that an agent is running at that location which will return a reference to a **NamingContext**. The (stringified) name **a/string/path/to/obj** is then used as the argument to a **resolve** operation on that **NamingContext**. The URL denotes the object reference that results from that lookup.

**corbaname:rir:#a/local/obj**

This URL specifies that the stringified name **a/local/obj** is to be resolved relative to the naming context returned by **resolve\_initial\_references(“NameService”)**.

### 13.6.10.6 Future corbaloc URL Protocols

This specification only defines use of iiop with corbaloc. New protocols can be added to **corbaloc** as required. Each new protocol must implement the <future\_prot\_addr> component of the URL and define a described in Section 13.6.10.1, “corbaloc URL” on page 13-24.”

A possible example of a future corbaloc URL that incorporates an ATM address is:

**corbaloc:iiop:xyz.com,atm:E.164:358.400.1234567/dev/test/objectX**

### 13.6.10.7 Future URL Schemes

Several currently defined non-CORBA URL scheme names are reserved. Implementations may choose to provide these or other URL schemes to support additional ways of denoting objects with URLs.

Table 13-1 lists the required and some optional formats.

Table 13-1 URL formats

| Scheme     | Description                                                                | Status   |
|------------|----------------------------------------------------------------------------|----------|
| IOR:       | Standard stringified IOR format                                            | Required |
| corbaloc:  | Simple object reference. rir: must be supported.                           | Required |
| corbaname: | CosName URL                                                                | Required |
| file://    | Specifies a file containing a URL/IOR                                      | Optional |
| ftp://     | Specifies a file containing a URL/IOR that is accessible via ftp protocol. | Optional |
| http://    | Specifies an HTTP URL that returns an object URL/IOR.                      | Optional |

## 13.7 Service Context

Emerging specifications for Object Services occasionally require service-specific context information to be passed implicitly with requests and replies. The Interoperability specifications define a mechanism for identifying and passing this service-specific context information as “hidden” parameters. The specification makes the following assumptions:

- Object Service specifications that need additional context passed will completely specify that context as an OMG IDL data type.
- ORB APIs will be provided that will allow services to supply and consume context information at appropriate points in the process of sending and receiving requests and replies.



- It is an ORB's responsibility to determine when to send service-specific context information, and what to do with such information in incoming messages. It may be possible, for example, for a server receiving a request to be unable to de-encapsulate and use a certain element of service-specific context, but nevertheless still be able to successfully reply to the message.

As shown in the following OMG IDL specification, the IOP module provides the mechanism for passing Object Service-specific information. It does not describe any service-specific information. It only describes a mechanism for transmitting it in the most general way possible. The mechanism is currently used by the DCE ESIOP and could also be used by the Internet Inter-ORB protocol (IIOP) General Inter\_ORB Protocol (GIOP).

Each Object Service requiring implicit service-specific context to be passed through GIOP will be allocated a unique service context ID value by OMG. Service context ID values are of type **unsigned long**. Object service specifications are responsible for describing their context information as single OMG IDL data types, one data type associated with each service context ID.

The marshaling of Object Service data is described by the following OMG IDL:

```

module IOP { // IDL

 typedef unsigned long ServiceId;

 struct ServiceContext {
 ServiceId context_id;
 sequence <octet> context_data;
 };
 typedef sequence <ServiceContext>ServiceContextList;
};

```

The context data for a particular service will be encoded as specified for its service-specific OMG IDL definition, and that encoded representation will be encapsulated in the **context\_data** member of **IOP::ServiceContext**. (See Section 15.3.3, "Encapsulation" on page 15-14). The **context\_id** member contains the service ID value identifying the service and data format. Context data is encapsulated in octet sequences to permit ORBs to handle context data without unmarshaling, and to handle unknown context data types.

During request and reply marshaling, ORBs will collect all service context data associated with the *Request* or *Reply* in a **ServiceContextList**, and include it in the generated messages. No ordering is specified for service context data within the list. The list is placed at the beginning of those messages to support security policies that may need to apply to the majority of the data in a request (including the message headers).

Each Object Service requiring implicit service-specific context to be passed through GIOP will be allocated a unique service context ID value by the OMG. Service context ID values are of type unsigned long. Object service specifications are responsible for describing their context information as single OMG IDL data types, one data type associated with each service context ID.

The high-order 24 bits of a service context ID contain a 24-bit vendor service context codeset ID (VSCID); the low-order 8 bits contain the rest of the service context ID. A vendor (or group of vendors) who wishes to define a specific set of service context IDs should obtain a unique VSCID from the OMG, and then define a specific set of service context IDs using the VSCID for the high-order bits.

The VSCIDs of zero to 15 inclusive (0x000000 to 0x00000f) are reserved for use for OMG-defined standard service context IDs (i.e., service context IDs in the range 0-4095 are reserved as OMG standard service contexts).

### 13.7.1 Standard Service Contexts

```

module IOP { // IDL
 const Serviced TransactionService = 0;
 const Serviced CodeSets = 1;
 const Serviced ChainBypassCheck = 2;
 const Serviced ChainBypassInfo = 3;
 const Serviced LogicalThreadId = 4;
 const Serviced BI_DIR_IIOB = 5;
 const Serviced SendingContextRunTime = 6;
 const Serviced INVOCATION_POLICIES = 7;
 const Serviced FORWARDED_IDENTITY = 8;
 const Serviced UnknownExceptionInfo = 9;
 const Serviced RTCorbaPriority = 10;
 const Serviced RTCorbaPriorityRange = 11;
 const Serviced FT_GROUP_VERSION = 12;
 const Serviced FT_REQUEST = 13;
 const Serviced ExceptionDetailMessage = 14;
 const Serviced SecurityAttributeService = 15;
 const Serviced ActivityService = 16;
};

```

The standard **Serviced**s currently defined are:

- **TransactionService** identifies a CDR encapsulation of the **CosTransactions::PropogationContext** defined in the Object Transaction Service specification (formal/01-11-03).
- **CodeSets** identifies a CDR encapsulation of the **CONV\_FRAME::CodeSetContext** defined in Section 13.10.2.5, “GIOP Code Set Service Context” on page 13-44.
- DCOM-CORBA Interworking uses three service contexts as defined in “DCOM-CORBA Interworking” in the “Interoperability with non-CORBA Systems” chapter. They are:

- **ChainBypassCheck**, which carries a CDR encapsulation of the **struct CosBridging::ChainBypassCheck**. This is carried only in a **Request** message as described in Section 20.9.1, “CORBA Chain Bypass” on page 20-19.
- **ChainBypassInfo**, which carries a CDR encapsulation of the **struct CosBridging::ChainBypassInfo**. This is carried only in a **Reply** message as described in Section 20.9.1, “CORBA Chain Bypass” on page 20-19.
- **LogicalThreadId**, which carries a CDR encapsulation of the **struct CosBridging::LogicalThreadId** as described in Section 20.10, “Thread Identification” on page 20-21.
- **BI\_DIR\_IIOB** identifies a CDR encapsulation of the **IIOB::BiDirIIOBServiceContext** defined in Section 15.8, “Bi-Directional GIOP” on page 15-56.
- **SendingContextRunTime** identifies a CDR encapsulation of the IOR of the **SendingContext::RunTime** object (see Section 5.6, “Access to the Sending Context Run Time” on page 5-18).
- For information on **INVOCATION\_POLICIES** refer to the CORBA Messaging chapter.
- For information on **FORWARDED\_IDENTITY** refer to the *Firewall* specification (orbos/98-05-04).
- **UnknownExceptionInfo** identifies a CDR encapsulation of a marshaled instance of a **java.lang.throwable** or one of its subclasses as described in Java to IDL Language Mapping, “Mapping of UnknownExceptionInfo Service Context,” section.
- For information on **RTCorbaPriority** refer to the *Real-Time CORBA* specification.
- For information on **RTCorbaPriorityRange** refer to the *Real-Time CORBA* specification.
- **FT\_GROUP\_VERSION, FT\_REQUEST** - refer to the Fault Tolerant CORBA chapter.
- **ExceptionDetailMessage** identifies a CDR encapsulation of a wstring, encoded using GIOP 1.2 with a TCS-W of UTF-16. This service context may be sent on Reply messages with a **reply\_status** of **SYSTEM\_EXCEPTION** or **USER\_EXCEPTION**. The usage of this service context is defined by language mappings.
- SecurityAttributeService - refer to the Secure Interoperability chapter.
- ActivityService - refer to the *Additional Structuring Mechanisms for OTS* specification (orbos/01-11-08).

### 13.7.2 Service Context Processing Rules

Service context IDs are associated with a specific version of GIOP, but will always be allocated in the OMG service context range. This allows any ORB to recognize when it is receiving a standard service context, even if it has been defined in a version of GIOP that it does not support.

The following are the rules for processing a received service context:

- The service context is in the OMG defined range:
  - If it is valid for the supported GIOP version, then it must be processed correctly according to the rules associated with it for that GIOP version level.
  - If it is not valid for the GIOP version, then it may be ignored by the receiving ORB, however it must be passed on through a bridge and must be made available to interceptors. No exception shall be raised.
- The service context is not in the OMG-defined range:
  - The receiving ORB may choose to ignore it, or process it if it “understands” it, however the service context must be passed on through a bridge and must be made available to interceptors.

## 13.8 *Coder/Decoder Interfaces*

The formats of IOR components and service context data used by ORB services are often defined as CDR encapsulations encoding instances of IDL defined data types. The **Codec** provides a mechanism to transfer these components between their IDL data types and their CDR encapsulation representations.

A **Codec** is obtained from the **CodecFactory**. The **CodecFactory** is obtained through a call to **ORB::resolve\_initial\_references (“CodecFactory”)**.

### 13.8.1 *Codec Interface*

```

module IOP {
 local interface Codec {
 exception InvalidTypeForEncoding {};
 exception FormatMismatch {};
 exception TypeMismatch {};

 CORBA::OctetSeq encode (in any data)
 raises (InvalidTypeForEncoding);
 any decode (in CORBA::OctetSeq data)
 raises (FormatMismatch);
 CORBA::OctetSeq encode_value (in any data)
 raises (InvalidTypeForEncoding);
 any decode_value (
 in CORBA::OctetSeq data,
 in CORBA::TypeCode tc)
 raises (FormatMismatch, TypeMismatch);
 };
};

```

### 13.8.1.1 Exceptions

#### *InvalidTypeForEncoding*

This exception is raised by **encode** or **encode\_value** when the type is invalid for the encoding. For example, this exception is raised if the encoding is **ENCODING\_CDR\_ENCAPS** version 1.0 and a type that does not exist in that version, such as **wstring**, is passed to the operation.

#### *FormatMismatch*

This exception is raised by **decode** or **decode\_value** when the data in the octet sequence cannot be decoded into an **any**.

#### *TypeMismatch*

This exception is raised by **decode\_value** when the given **TypeCode** does not match the given octet sequence.

### 13.8.1.2 Operations

#### *encode*

Convert the given **any** into an octet sequence based on the encoding format effective for this **Codec**.

This operation may raise **InvalidTypeForEncoding**.

#### *Parameter*

**data** The data, in the form of an **any**, to be encoded into an octet sequence.

#### *Return Value*

An octet sequence containing the encoded **any**. This octet sequence contains both the **TypeCode** and the data of the type.

#### *decode*

Decode the given octet sequence into an **any** based on the encoding format effective for this **Codec**.

This operation raises **FormatMismatch** if the octet sequence cannot be decoded into an **any**.

#### *Parameter*

**data** The data, in the form of an octet sequence, to be decoded into an **any**.

#### *Return Value*

An **any** containing the data from the decoded octet sequence.

***encode\_value***

Convert the given **any** into an octet sequence based on the encoding format effective for this **Codec**. Only the data from the **any** is encoded, not the **TypeCode**.

This operation may raise **InvalidTypeForEncoding**.

*Parameter*

**data**                   The data, in the form of an **any**, to be encoded into an octet sequence.

*Return Value*

An octet sequence containing the data from the encoded **any**.

***decode\_value***

Decode the given octet sequence into an **any** based on the given **TypeCode** and the encoding format effective for this **Codec**.

This operation raises **FormatMismatch** if the octet sequence cannot be decoded into an **any**.

*Parameter*

**data**                   The data, in the form of an octet sequence, to be decoded into an **any**.

**tc**                      The **TypeCode** to be used to decode the data.

*Return Value*

An **any** containing the data from the decoded octet sequence.

### 13.8.2 Codec Factory

```

module IOP {
 typedef short EncodingFormat;
 const EncodingFormat ENCODING_CDR_ENCAPS = 0;

 struct Encoding {
 EncodingFormat format;
 octet major_version;
 octet minor_version;
 };

 local interface CodecFactory {
 exception UnknownEncoding {};
 Codec create_codec (in Encoding enc)
 raises (UnknownEncoding);
 };
};

```

### 13.8.2.1 Encoding Structure

The **Encoding** structure defines the encoding format of a **Codec**. It details the encoding format, such as CDR Encapsulation encoding, and the major and minor versions of that format.

The encodings which shall be supported are:

- **ENCODING\_CDR\_ENCAPS**, version 1.0;
- **ENCODING\_CDR\_ENCAPS**, version 1.1;
- **ENCODING\_CDR\_ENCAPS**, version 1.2;
- **ENCODING\_CDR\_ENCAPS** for all future versions of GIOP as they arise.

Vendors are free to support additional encodings.

### 13.8.2.2 CodecFactory Interface

#### *create\_codec*

Create a **Codec** of the given encoding.

This operation raises **UnknownEncoding** if this factory cannot create a **Codec** of the given encoding.

#### *Parameter*

**enc**                      The **Encoding** for which to create a **Codec**.

#### *Return Value*

A **Codec** obtained with the given encoding.

## 13.9 Feature Support and GIOP Versions

The association of service contexts with GIOP versions, (along with some other supported features tied to GIOP minor version), is shown in Table 13-2..

Table 13-2 Feature Support Tied to Minor GIOP Version Number

| <b>Feature</b>                                                                            | <b>Version 1.0</b> | <b>Version 1.1</b> | <b>Version 1.2</b> | <b>Version 1.3</b> |
|-------------------------------------------------------------------------------------------|--------------------|--------------------|--------------------|--------------------|
| TransactionService Service Context                                                        | yes                | yes                | yes                | yes                |
| CodeSets Service Context                                                                  |                    | yes                | yes                | yes                |
| DCOM Bridging Service Contexts:<br>ChainBypassCheck<br>ChainBypassInfo<br>LogicalThreadId |                    |                    | yes                | yes                |
| Object by Value Service Context:<br>SendingContextRunTime                                 |                    |                    | yes                | yes                |

Table 13-2 Feature Support Tied to Minor GIOP Version Number (Continued)

| Feature                                                                    | Version 1.0 | Version 1.1 | Version 1.2                             | Version 1.3                             |
|----------------------------------------------------------------------------|-------------|-------------|-----------------------------------------|-----------------------------------------|
| Bi-Directional IIOP Service Context:<br>BI_DIR_IIOP                        |             |             | yes                                     | yes                                     |
| Asynch Messaging Service Context<br>INVOCATION_POLICIES                    |             |             | optional <sup>\$</sup>                  | yes                                     |
| Firewall Service Context<br>FORWARDED_IDENTITY                             |             |             | optional <sup>\$</sup>                  | yes                                     |
| Java Language Throwable Service<br>Context:<br>UnknownExceptionInfo        |             |             | yes                                     | yes                                     |
| Realtime CORBA Service Contexts<br>RTCorbaPriority<br>RTCorbaPriorityRange |             |             | optional<br>(Realtime<br>CORBA<br>only) | optional<br>(Realtime<br>CORBA<br>only) |
| ExceptionDetailMessage Service Context                                     |             |             | optional                                | yes                                     |
| FT_GROUP_VERSION                                                           |             |             | optional <sup>\$\$</sup>                | yes                                     |
| FT_REQUEST                                                                 |             |             | optional <sup>\$\$</sup>                | yes                                     |
| SecurityAttributeService                                                   |             |             | optional <sup>\$\$</sup>                | yes                                     |
| ActivityService                                                            |             |             | optional <sup>\$\$</sup>                | yes                                     |
| IOR components in IIOP profile                                             |             | yes         | yes                                     | yes                                     |
| TAG_ORB_TYPE                                                               |             | yes         | yes                                     | yes                                     |
| TAG_CODE_SETS                                                              |             | yes         | yes                                     | yes                                     |
| TAG_ALTERNATE_IIOP_ADDRESS                                                 |             |             | yes                                     | yes                                     |
| TAG_ASSOCIATION_OPTION                                                     |             | yes         | yes                                     | yes                                     |
| TAG_SEC_NAME                                                               |             | yes         | yes                                     | yes                                     |
| TAG_SSL_SEC_TRANS                                                          |             | yes         | yes                                     | yes                                     |
| TAG_GENERIC_SEC_MECH                                                       |             | yes         | yes                                     | yes                                     |
| TAG_*_SEC_MECH                                                             |             | yes         | yes                                     | yes                                     |
| TAG_JAVA_CODEBASE                                                          |             |             | yes                                     | yes                                     |
| TAG_FIREWALL_TRANS                                                         |             |             | optional <sup>\$</sup>                  | yes                                     |
| TAG_SCCP_CONTACT_INFO                                                      |             |             | optional <sup>\$</sup>                  | yes                                     |
| TAG_TRANSACTION_POLICY                                                     |             |             | optional <sup>\$</sup>                  | yes                                     |
| TAG_MESSAGE_ROUTERS                                                        |             |             | optional <sup>\$</sup>                  | yes                                     |
| TAG_OTTS_POLICY                                                            |             |             | optional <sup>\$</sup>                  | yes                                     |



Table 13-2 Feature Support Tied to Minor GIOP Version Number (Continued)

| Feature                                      | Version 1.0 | Version 1.1 | Version 1.2              | Version 1.3 |
|----------------------------------------------|-------------|-------------|--------------------------|-------------|
| TAG_INV_POLICY                               |             |             | optional <sup>\$</sup>   | yes         |
| TAG_INET_SEC_TRANS                           |             |             | optional <sup>\$</sup>   | yes         |
| Extended IDL data types                      |             | yes         | yes                      | yes         |
| Bi-Directional GIOP Features                 |             |             | yes                      | yes         |
| Value types and Abstract Interfaces          |             |             | yes                      | yes         |
| TAG_CSI_SEC_MECH_LIST                        |             |             | optional <sup>\$\$</sup> | yes         |
| TAG_NULL_TAG                                 |             |             | optional <sup>\$\$</sup> | yes         |
| TAG_SECIOP_SEC_TRANS                         |             |             | optional <sup>\$\$</sup> | yes         |
| TAG_TLS_SEC_TRANS                            |             |             | optional <sup>\$\$</sup> | yes         |
| TAG_ACTIVITY_POLICY                          |             |             | optional <sup>\$\$</sup> | yes         |
| _component                                   |             |             |                          | yes         |
| tk_abstract_interface<br>tk_local_interface1 |             |             | optional <sup>\$\$</sup> | yes         |
| tk_component<br>tk_home<br>tk_event          |             |             |                          | yes         |

**Note** – <sup>\$, \$\$</sup>All features that have been added after CORBA 2.3 have been marked as optional in GIOP 1.2. These features cannot be compulsory in GIOP 1.2 since there is no way to incorporate them in deployed implementations of 1.2. However, in order to have the additional features of CORBA 2.4 work properly these optional features must be supported by the GIOP 1.2 implementation connecting CORBA 2.4<sup>\$</sup> or CORBA 2.5 or 2.6<sup>\$\$</sup> ORBs.

## 13.10 Code Set Conversion

### 13.10.1 Character Processing Terminology

This section introduces a few terms and explains a few concepts to help understand the character processing portions of this document.

#### 13.10.1.1 Character Set

A finite set of different characters used for the representation, organization, or control of data. In this specification, the term “character set” is used without any relationship to code representation or associated encoding. Examples of character sets are the

English alphabet, Kanji or sets of ideographic characters, corporate character sets (commonly used in Japan), and the characters needed to write certain European languages.

### 13.10.1.2 Coded Character Set, or Code Set

A set of unambiguous rules that establishes a character set and the one-to-one relationship between each character of the set and its bit representation or numeric value. In this specification, the term “code set” is used as an abbreviation for the term “coded character set.” Examples include ASCII, ISO 8859-1, JIS X0208 (which includes Roman characters, Japanese hiragana, Greek characters, Japanese kanji, etc.) and Unicode.

### 13.10.1.3 Code Set Classifications

Some language environments distinguish between byte-oriented and “wide characters.” The byte-oriented characters are encoded in one or more 8-bit bytes. A typical single-byte encoding is ASCII as used for western European languages like English. A typical multi-byte encoding which uses from one to three 8-bit bytes for each character is eucJP (Extended UNIX Code - Japan, packed format) as used for Japanese workstations.

Wide characters are a fixed 16 or 32 bits long, and are used for languages like Chinese, Japanese, etc., where the number of combinations offered by 8 bits is insufficient and a fixed-width encoding is needed. A typical example is Unicode (a “universal” character set defined by the The Unicode Consortium, which uses an encoding scheme identical to ISO 10646 UCS-2, or 2-byte Universal Character Set encoding). An extended encoding scheme for Unicode characters is UTF-16 (UCS Transformation Format, 16-bit representations).

The C language has data types `char` for byte-oriented characters and `wchar_t` for wide characters. The language definition for C states that the sizes for these characters are implementation-dependent. Some environments do not distinguish between byte-oriented and wide characters (e.g., Ada and Smalltalk). Here again, the size of a character is implementation-dependent. The following table illustrates code set classifications as used in this document.

Table 13-3 Code Set Classification

| Orientation       | Code Element Encoding | Code Set Examples                                       | C Data Type |
|-------------------|-----------------------|---------------------------------------------------------|-------------|
| byte-oriented     | single-byte           | ASCII, ISO 8859-1 (Latin-1), EBCDIC, ...                | char        |
|                   | multi-byte            | UTF-8, eucJP, Shift-JIS, JIS, Big5, ...                 | char[]      |
| non-byte-oriented | fixed-length          | ISO 10646 UCS-2 (Unicode), ISO 10646 UCS-4, UTF-16, ... | wchar_t     |

#### 13.10.1.4 *Narrow and Wide Characters*

Some language environments distinguish between “narrow” and “wide” characters. Typically the narrow characters are considered to be 8-bit long and are used for western European languages like English, while the wide characters are 16-bit or 32-bit long and are used for languages like Chinese, Japanese, etc., where the number of combinations offered by 8 bits are insufficient. However, as noted above there are common encoding schemes in which Asian characters are encoded using multi-byte code sets and it is incorrect to assume that Asian characters are always encoded as “wide” characters.

Within this specification, the general terms “narrow character” and “wide character” are only used in discussing OMG IDL.

#### 13.10.1.5 *Char Data and Wchar Data*

The phrase “**char** data” in this specification refers to data whose IDL types have been specified as **char** or **string**. Likewise “**wchar** data” refers to data whose IDL types have been specified as **wchar** or **wstring**.

#### 13.10.1.6 *Byte-Oriented Code Set*

An encoding of characters where the numeric code corresponding to a character code element can occupy one or more bytes. A byte as used in this specification is synonymous with octet, which occupies 8 bits.

#### 13.10.1.7 *Multi-Byte Character Strings*

A character string represented in a byte-oriented encoding where each character can occupy one or more bytes is called a multi-byte character string. Typically, wide characters are converted to this form from a (fixed-width) process code set before transmitting the characters outside the process (see below about process code sets). Care must be taken to correctly process the component bytes of a character’s multi-byte representation.

#### 13.10.1.8 *Non-Byte-Oriented Code Set*

An encoding of characters where the numeric code corresponding to a character code element can occupy fixed 16 or 32 bits.

#### 13.10.1.9 *Char and Wchar Transmission Code Set (TCS-C and TCS-W)*

These two terms refer to code sets that are used for transmission between ORBs after negotiation is completed. As the names imply, the first one is used for **char** data and the second one for **wchar** data. Each TCS can be byte-oriented or non-byte oriented.

### 13.10.1.10 Process Code Set and File Code Set

Processes generally represent international characters in an internal fixed-width format which allows for efficient representation and manipulation. This internal format is called a “process code set.” The process code set is irrelevant outside the process, and hence to the interoperation between CORBA clients and servers through their respective ORBs.

When a process needs to write international character information out to a file, or communicate with another process (possibly over a network), it typically uses a different encoding called a “file code set.” In this specification, unless otherwise indicated, all references to a program’s code set refer to the file code set, not the process code set. Even when a client and server are located physically on the same machine, it is possible for them to use different file code sets.

### 13.10.1.11 Native Code Set

A native code set is the code set which a client or a server uses to communicate with its ORB. There might be separate native code sets for **char** and **wchar** data.

### 13.10.1.12 Transmission Code Set

A transmission code set is the commonly agreed upon encoding used for character data transfer between a client’s ORB and a server’s ORB. There are two transmission code sets established per session between a client and its server, one for **char** data (TCS-C) and the other for **wchar** data (TCS-W). Figure 13-6 illustrates these relationships:

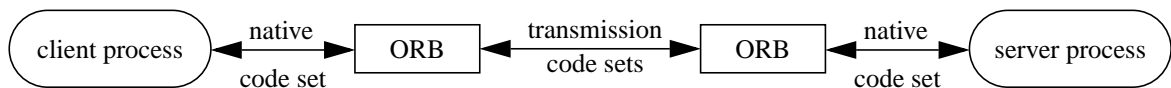

Figure 13-6 Transmission Code Sets

The intent is for TCS-C to be byte-oriented and TCS-W to be non-byte-oriented. However, this specification does allow both types of characters to be transmitted using the same transmission code set. That is, the selection of a transmission code set is orthogonal to the wideness or narrowness of the characters, although a given code set may be better suited for either narrow or wide characters.

### 13.10.1.13 Conversion Code Set (CCS)

With respect to a particular ORB’s native code set, the set of other or target code sets for which an ORB can convert all code points or character encodings between the native code set and that target code set. For each code set in this CCS, the ORB maintains appropriate translation or conversion procedures and advertises the ability to use that code set for transmitted data in addition to the native code set.

## 13.10.2 Code Set Conversion Framework

### 13.10.2.1 Requirements

The file code set that an application uses is often determined by the platform on which it runs. In Japan, for example, Japanese EUC is used on Unix systems, while Shift-JIS is used on PCs. Code set conversion is therefore required to enable interoperability across these platforms. This proposal defines a framework for the automatic conversion of code sets in such situations. The requirements of this framework are:

1. Backward compatibility. In previous CORBA specifications, IDL type **char** was limited to ISO 8859-1. The conversion framework should be compatible with existing clients and servers that use ISO 8859-1 as the code set for **char**.
2. Automatic code set conversion. To facilitate development of CORBA clients and servers, the ORB should perform any necessary code set conversions automatically and efficiently. The IDL type **octet** can be used if necessary to prevent conversions.
3. Locale support. An internationalized application determines the code set in use by examining the LOCALE string (usually found in the LANG environment variable), which may be changed dynamically at run time by the user. Example LOCALE strings are fr\_FR.ISO8859-1 (French, used in France with the ISO 8859-1 code set) and ja\_JP.ujis (Japanese, used in Japan with the EUC code set and X11R5 conventions for LOCALE). The conversion framework should allow applications to use the LOCALE mechanism to indicate supported code sets, and thus select the correct code set from the registry.
4. CMIR and SMIR support. The conversion framework should be flexible enough to allow conversion to be performed either on the client or server side. For example, if a client is running in a memory-constrained environment, then it is desirable for code set converters to reside in the server and for a Server Makes It Right (SMIR) conversion method to be used. On the other hand, if many servers are executed on one server machine, then converters should be placed in each client to reduce the load on the server machine. In this case, the conversion method used is Client Makes It Right (CMIR).

### 13.10.2.2 Overview of the Conversion Framework

Both the client and server indicate a native code set indirectly by specifying a locale. The exact method for doing this is language-specific, such as the XPG4 C/C++ function **setlocale**. The client and server use their native code set to communicate with their ORB. (Note that these native code sets are in general different from process code sets and hence conversions may be required at the client and server ends.)

The conversion framework is illustrated in Figure 13-7. The server-side ORB stores a server's code set information in a component of the IOR multiple-component profile structure (see Section 13.6.2, "Interoperable Object References: IORs" on page 13-14)<sup>1</sup>. The code sets actually used for transmission are carried in the service context field of an IOP (Inter-ORB Protocol) request header (see Section 13.7, "Service

Context” on page 13-28 and Section 13.10.2.5, “GIOP Code Set Service Context” on page 13-44). Recall that there are two code sets (TCS-C and TCS-W) negotiated for each session.

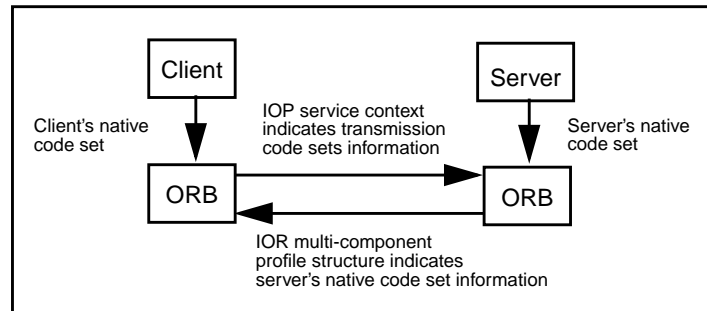

Figure 13-7 Code Set Conversion Framework Overview

If the native code sets used by a client and server are the same, then no conversion is performed. If the native code sets are different and the client-side ORB has an appropriate converter, then the CMIR conversion method is used. In this case, the server’s native code set is used as the transmission code set. If the native code sets are different and the client-side ORB does not have an appropriate converter but the server-side ORB does have one, then the SMIR conversion method is used. In this case, the client’s native code set is used as the transmission code set.

The conversion framework allows clients and servers to specify a native **char** code set and a native **wchar** code set, which determine the local encodings of IDL types **char** and **wchar**, respectively. The conversion process outlined above is executed independently for the **char** code set and the **wchar** code set. In other words, the algorithm that is used to select a transmission code set is run twice, once for **char** data and once for **wchar** data.

The rationale for selecting two transmission code sets rather than one (which is typically inferred from the locale of a process) is to allow efficient data transmission without any conversions when the client and server have identical representations for **char** and/or **wchar** data. For example, when a Windows NT client talks to a Windows NT server and they both use Unicode for wide character data, it becomes possible to transmit wide character data from one to the other without any conversions. Of course, this becomes possible only for those wide character representations that are well-defined, not for any proprietary ones. If a single transmission code set was mandated, it might require unnecessary conversions. (For example, choosing Unicode as the transmission code set would force conversion of all byte-oriented character data to Unicode.)

1. Version 1.1 of the IIOP profile body can also be used to specify the server’s code set information, as this version introduces an extra field that is a sequence of tagged components.

### 13.10.2.3 ORB Databases and Code Set Converters

The conversion framework requires an ORB to be able to determine the native code set for a locale and to convert between code sets as necessary. While the details of exactly how these tasks are accomplished are implementation-dependent, the following databases and code set converters might be used:

- Locale database. This database defines a native code set for a process. This code set could be byte-oriented or non-byte-oriented and could be changed programmatically while the process is running. However, for a given session between a client and a server, it is fixed once the code set information is negotiated at the session's setup time.
- Environment variables or configuration files. Since the locale database can only indicate one code set while the ORB needs to know two code sets, one for **char** data and one for **wchar** data, an implementation can use environment variables or configuration files to contain this information on native code sets.
- Converter database. This database defines, for each code set, the code sets to which it can be converted. From this database, a set of "conversion code sets" (CCS) can be determined for a client and server. For example, if a server's native code set is eucJP, and if the server-side ORB has eucJP-to-JIS and eucJP-to-SJIS bilateral converters, then the server's conversion code sets are JIS and SJIS.
- Code set converters. The ORB has converters which are registered in the converter database.

### 13.10.2.4 CodeSet Component of IOR Multi-Component Profile

The code set component of the IOR multi-component profile structure contains:

- server's native **char** code set and conversion code sets, and
- server's native **wchar** code set and conversion code sets.

Both **char** and **wchar** conversion code sets are listed in order of preference. The code set component is identified by the following tag:

```
const IOP::ComponentID TAG_CODE_SETS = 1;
```

This tag has been assigned by OMG (See Section 13.6.6, "Standard IOR Components" on page 13-19.). The following IDL structure defines the representation of code set information within the component:

```
module CONV_FRAME { // IDL
 typedef unsigned long CodeSetId;
 struct CodeSetComponent {
 CodeSetId native_code_set;
 sequence<CodeSetId> conversion_code_sets;
 };
 struct CodeSetComponentInfo {
```

```

 CodeSetComponent ForCharData;
 CodeSetComponent ForWcharData;
 };
};

```

Code sets are identified by a 32-bit integer id from the OSF Character and Code Set Registry (See Section 13.10.5.1, “Character and Code Set Registry” on page 13-50 for further information). Data within the code set component is represented as a structure of type **CodeSetComponentInfo**, and is encoded as a CDR encapsulation. In other words, the **char** code set information comes first, then the **wchar** information, represented as structures of type **CodeSetComponent**.

A null value should be used in the **native\_code\_set** field if the server desires to indicate no native code set (possibly with the identification of suitable conversion code sets).

If the code set component is not present in a multi-component profile structure, then the default **char** code set is ISO 8859-1 for backward compatibility. However, there is no default **wchar** code set. If a server supports interfaces that use wide character data but does not specify the **wchar** code sets that it supports, client-side ORBs will raise exception **INV\_OBJREF**, with standard minor code 1.

If a client application invokes an operation which results in an attempt by the client ORB to marshal **wchar** or **wstring** data for an in parameter (or to unmarshal **wchar** or **wstring** data for an in/out parameter, out parameter or the return value), and the associated Object Reference does not include a codeset component, then the client ORB shall raise the **INV\_OBJREF** standard system exception with standard minor code 2 as a response to the operation invocation.

### 13.10.2.5 GIOP Code Set Service Context

The code set GIOP service context contains:

- **char** transmission code set, and
- **wchar** transmission code set

in the form of a code set service. This service is identified by:

```
const IOP::ServiceID CodeSets = 1;
```

The following IDL structure defines the representation of code set service information:

```

module CONV_FRAME { // IDL
 typedef unsigned long CodeSetId;
 struct CodeSetContext {
 CodeSetId char_data;
 CodeSetId wchar_data;
 };
};

```



Code sets are identified by a 32-bit integer id from the OSF Character and Code Set Registry (See Section 13.10.5.1, “Character and Code Set Registry” on page 13-50 for further information).

**Note** – A server’s **char** and **wchar** Code set components are usually different, but under some special circumstances they can be the same. That is, one could use the same code set for both **char** data and **wchar** data. Likewise the **CodesetIds** in the service context don’t have to be different.

### 13.10.2.6 Code Set Negotiation

The client-side ORB determines a server’s native and conversion code sets from the code set component in an IOR multi-component profile structure, and it determines a client’s native and conversion code sets from the locale setting (and/or environment variables/configuration files) and the converters that are available on the client. From this information, the client-side ORB chooses **char** and **wchar** transmission code sets (TCS-C and TCS-W). For both requests and replies, the **char** TCS-C determines the encoding of **char** and **string** data, and the **wchar** TCS-W determines the encoding of **wchar** and **wstring** data.

Code set negotiation is not performed on a per-request basis, but only when a client initially connects to a server. All text data communicated on a connection are encoded as defined by the TCSs selected when the connection is established.

Figure 13-8 illustrates, there are two channels for character data flowing between the client and the server. The first, TCS-C, is used for **char** data and the second, TCS-W, is used for **wchar** data. Also note that two native code sets, one for each type of data, could be used by the client and server to talk to their respective ORBs (as noted earlier, the selection of the particular native code set used at any particular point is done via **setlocale** or some other implementation-dependent method).

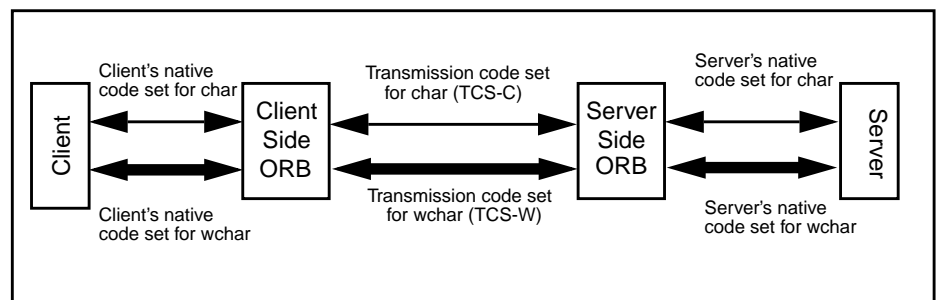

Figure 13-8 Transmission Code Set Use

Let us look at an example. Assume that the code set information for a client and server is as shown in the table below. (Note that this example concerns only **char** code sets and is applicable only for data described as **chars** in the IDL.)

|                       | <b>Client</b> | <b>Server</b> |
|-----------------------|---------------|---------------|
| Native code set:      | SJIS          | eucJP         |
| Conversion code sets: | eucJP, JIS    | SJIS, JIS     |

The client-side ORB first compares the native code sets of the client and server. If they are identical, then the transmission and native code sets are the same and no conversion is required. In this example, they are different, so code set conversion is necessary. Next, the client-side ORB checks to see if the server's native code set, eucJP, is one of the conversion code sets supported by the client. It is, so eucJP is selected as the transmission code set, with the client (i.e., its ORB) performing conversion to and from its native code set, SJIS, to eucJP. Note that the client may first have to convert all its data described as **chars** (and possibly **wchar\_ts**) from process codes to SJIS first.

Now let us look at the general algorithm for determining a transmission code set and where conversions are performed. First, we introduce the following abbreviations:

- CNCS - Client Native Code Set;
- CCCS - Client Conversion Code Sets;
- SNCS - Server Native Code Set;
- SCCS - Server Conversion Code Sets; and
- TCS - Transmission Code Set.

The algorithm is as follows:

```

if (CNCS==SNCS)
 TCS = CNCS; // no conversion required
else {
 if (elementOf(SNCS,CCCS))
 TCS = SNCS; // client converts to server's native code set
 else if (elementOf(CNCS,SCCS))
 TCS = CNCS; // server converts from client's native code set
 else if (intersection(CCCS,SCCS) != emptySet) {
 TCS = oneOf(intersection(CCCS,SCCS));
 // client chooses TCS, from intersection(CCCS,SCCS), that is
 // most preferable to server;
 // client converts from CNCS to TCS and server
 // from TCS to SNCS
 else if (compatible(CNCS,SNCS))
 TCS = fallbackCS; // fallbacks are UTF-8 (for char data) and
 // UTF-16 (for wchar data)
 else
 raise CODESET_INCOMPATIBLE exception;
 }

```

The algorithm first checks to see if the client and server native code sets are the same. If they are, then the native code set is used for transmission and no conversion is required. If the native code sets are not the same, then the conversion code sets are examined to see if

1. the client can convert from its native code set to the server's native code set,
2. the server can convert from the client's native code set to its native code set, or
3. transmission through an intermediate conversion code set is possible.

If the third option is selected and there is more than one possible intermediate conversion code set (i.e., the intersection of CCCS and SCCS contains more than one code set), then the one most preferable to the server is selected.<sup>2</sup>

If none of these conversions is possible, then the fallback code set (UTF-8 for **char** data and UTF-16 for **wchar** data— see below) is used. However, before selecting the fallback code set, a compatibility test is performed. This test looks at the character sets encoded by the client and server native code sets. If they are different (e.g., Korean and French), then meaningful communication between the client and server is not possible and a `CODESET_INCOMPATIBLE` exception is raised. This test is similar to the DCE compatibility test and is intended to catch those cases where conversion from the client native code set to the fallback, and the fallback to the server native code set would result in massive data loss. (See Section 13.10.5, "Relevant OSFM Registry Interfaces" on page 13-50 for the relevant OSF registry interfaces that could be used for determining compatibility.)

A `DATA_CONVERSION` exception is raised when a client or server attempts to transmit a character that does not map into the negotiated transmission code set. For example, not all characters in Taiwan Chinese map into Unicode. When an attempt is made to transmit one of these characters via Unicode, an ORB is required to raise a `DATA_CONVERSION` exception, with standard minor code 1.

In summary, the fallback code set is UTF-8 for **char** data (identified in the Registry as 0x05010001, "X/Open UTF-8; UCS Transformation Format 8 (UTF-8)"), and UTF-16 for **wchar** data (identified in the Registry as 0x00010109, "ISO/IEC 10646-1:1993; UTF-16, UCS Transformation Format 16-bit form"). As mentioned above the fallback code set is meaningful only when the client and server character sets are compatible, and the fallback code set is distinguished from a default code set used for backward compatibility.

If a server's native **char** code set is not specified in the IOR multi-component profile, then it is considered to be ISO 8859-1 for backward compatibility. However, a server that supports interfaces that use wide character data is required to specify its native **wchar** code set; if one is not specified, then the client-side ORB raises exception `INV_OBJREF`, with standard minor code set to 1.

---

2. Recall that server conversion code sets are listed in order of preference.

Similarly, if no **char** transmission code set is specified in the code set service context, then the **char** transmission code set is considered to be ISO 8859-1 for backward compatibility. If a client transmits wide character data and does not specify its **wchar** transmission code set in the service context, then the server-side ORB raises exception **BAD\_PARAM**, with standard minor code set to 23.

To guarantee “out-of-the-box” interoperability, clients and servers must be able to convert between their native **char** code set and UTF-8 and their native **wchar** code set (if specified) and Unicode. Note that this does not require that all server native code sets be mappable to Unicode, but only those that are exported as native in the IOR. The server may have other native code sets that aren’t mappable to Unicode and those can be exported as SCCSs (but not SNCSs). This is done to guarantee out-of-the-box interoperability and to reduce the number of code set converters that a CORBA-compliant ORB must provide.

ORB implementations are strongly encouraged to use widely-used code sets for each regional market. For example, in the Japanese marketplace, all ORB implementations should support Japanese EUC, JIS and Shift JIS to be compatible with existing business practices.

### *13.10.3 Mapping to Generic Character Environments*

Certain language environments do not distinguish between byte-oriented and wide characters. In such environments both **char** and **wchar** are mapped to the same “generic” character representation of the language. **String** and **wstring** are likewise mapped to generic strings in such environments. Examples of language environments that provide generic character support are Smalltalk and Ada.

Even while using languages that do distinguish between wide and byte-oriented characters (e.g., C and C++), it is possible to mimic some generic behavior by the use of suitable macros and support libraries. For example, developers of Windows NT and Windows 95 applications can write portable code between NT (which uses Unicode strings) and Windows 95 (which uses byte-oriented character strings) by using a set of macros for declaring and manipulating characters and character strings. Appendix A in this chapter shows how to map wide and byte-oriented characters to these generic macros.

Another way to achieve generic manipulation of characters and strings is by treating them as abstract data types (ADTs). For example, if strings were treated as abstract data types and the programmers are required to create, destroy, and manipulate strings only through the operations in the ADT interface, then it becomes possible to write code that is representation-independent. This approach has an advantage over the macro-based approach in that it provides portability between byte-oriented and wide character environments even without recompilation (at runtime the string function calls are bound to the appropriate byte-oriented/wide library). Another way of looking at it is that the macro-based genericity gives compile-time flexibility, while ADT-based genericity gives runtime flexibility.

Yet another way to achieve generic manipulation of character data is through the ANSI C++ Strings library defined as a template that can be parameterized by **char**, **wchar\_t**, or other integer types.

Given that there can be several ways of treating characters and character strings in a generic way, this standard cannot, and therefore does not, specify the mapping of **char**, **wchar**, **string**, and **wstring** to all of them. It only specifies the following normative requirements which are applicable to generic character environments:

- **wchar** must be mapped to the generic character type in a generic character environment.
- **wstring** must be mapped to a string of such generic characters in a generic character environment.
- The language binding files (i.e., stubs) generated for these generic environments must ensure that the generic type representation is converted to the appropriate code sets (i.e., CNCS on the client side and SNCS on the server side) before character data is given to the ORB runtime for transmission.

### 13.10.3.1 Describing Generic Interfaces

To describe generic interfaces in IDL we recommend using **wchar** and **wstring**. These can be mapped to generic character types in environments where they do exist and to wide characters where they do not. Either way interoperability between generic and non-generic character type environments is achieved because of the code set conversion framework.

### 13.10.3.2 Interoperation

Let us consider an example to see how a generic environment can interoperate with a non-generic environment. Let us say there is an IDL interface with both **char** and **wchar** parameters on the operations, and let us say the client of the interface is in a generic environment while the server is in a non-generic environment (for example the client is written in Smalltalk and the server is written in C++).

Assume that the server's (byte-oriented) native **char** code set (SNCS) is eucJP and the client's native **char** code set (CNCS) is SJIS. Further assume that the code set negotiation led to the decision to use eucJP as the **char** TCS-C and Unicode as the **wchar** TCS-W.

As per the above normative requirements for mapping to a generic environment, the client's Smalltalk stubs are responsible for converting all **char** data (however they are represented inside Smalltalk) to SJIS and all **wchar** data to the client's **wchar** code set before passing the data to the client-side ORB. Note that this conversion could be an identity mapping if the internal representation of narrow and wide characters is the same as that of the native code set(s). The client-side ORB now converts all **char** data from SJIS to eucJP and all **wchar** data from the client's **wchar** code set to Unicode, and then transmits to the server side.

The server side ORB and stubs convert the eucJP data and Unicode data into C++'s internal representation for **chars** and **wchars** as dictated by the IDL operation signatures. Notice that when the data arrives at the server side it does not look any different from data arriving from a non-generic environment (e.g., that is just like the server itself). In other words, the mappings to generic character environments do not affect the code set conversion framework.

### 13.10.4 Example of Generic Environment Mapping

This section shows how **char**, **wchar**, **string**, and **wchar** can be mapped to the generic C/C++ macros of the Windows environment. This is merely to illustrate one possibility. This section is not normative and is applicable only in generic environments. See Section 13.10.3, "Mapping to Generic Character Environments" on page 13-48.

#### 13.10.4.1 Generic Mappings

**Char** and **string** are mapped to C/C++ **char** and **char\*** as per the standard C/C++ mappings. **wchar** is mapped to the **TCHAR** macro which expands to either **char** or **wchar\_t** depending on whether **\_UNICODE** is defined. **wstring** is mapped to pointers to **TCHAR** as well as to the string class **CORBA::Wstring\_var**. Literal strings in IDL are mapped to the **\_TEXT** macro as in **\_TEXT(<literal>)**.

#### 13.10.4.2 Interoperation and Generic Mappings

We now illustrate how the interoperation works with the above generic mapping. Consider an IDL interface operation with a **wstring** parameter, a client for the operation which is compiled and run on a Windows 95 machine, and a server for the operation which is compiled and run on a Windows NT machine. Assume that the locale (and/or the environment variables for CNCS for **wchar** representation) on the Windows 95 client indicates the client's native code set to be SJIS, and that the corresponding server's native code set is Unicode. The code set negotiation in this case will probably choose Unicode as the TCS-W.

Both the client and server sides will be compiled with **\_UNICODE** defined. The IDL type **wstring** will be represented as a string of **wchar\_t** on the client. However, since the client's locale or environment indicates that the CNCS for wide characters is SJIS, the client side ORB will get the **wstring** parameter encoded as a SJIS multi-byte string (since that is the client's native code set), which it will then convert to Unicode before transmitting to the server. On the server side the ORB has no conversions to do since the TCS-W matches the server's native code set for wide characters.

We therefore notice that the code set conversion framework handles the necessary translations between byte-oriented and wide forms.

## 13.10.5 Relevant OSFM Registry Interfaces

### 13.10.5.1 Character and Code Set Registry

The OSF character and code set registry is defined in *OSF Character and Code Set Registry* (see References in the Preface) and current registry contents may be obtained directly from the Open Software Foundation (obtain via anonymous ftp to [ftp.opengroup.org/pub/code\\_set\\_registry](ftp.opengroup.org/pub/code_set_registry)). This registry contains two parts: character sets and code sets. For each listed code set, the set of character sets encoded by this code set is shown.

Each 32-bit code set value consists of a high-order 16-bit organization number and a 16-bit identification of the code set within that organization. As the numbering of organizations starts with 0x0001, a code set null value (0x00000000) may be used to indicate an unknown code set.

When associating character sets and code sets, OSF uses the concept of “fuzzy equality,” meaning that a code set is shown as encoding a particular character set if the code set can encode “most” of the characters.

“Compatibility” is determined with respect to two code sets by examining their entries in the registry, paying special attention to the character sets encoded by each code set. For each of the two code sets, an attempt is made to see if there is at least one (fuzzy-defined) character set in common, and if such a character set is found, then the assumption is made that these code sets are “compatible.” Obviously, applications which exploit parts of a character set not properly encoded in this scheme will suffer information loss when communicating with another application in this “fuzzy” scheme.

The ORB is responsible for accessing the OSF registry and determining “compatibility” based on the information returned.

OSF members and other organizations can request additions to both the character set and code set registries by email to [cs-registry@opengroup.org](mailto:cs-registry@opengroup.org); in particular, one range of the code set registry (0xf5000000 through 0xffffffff) is reserved for organizations to use in identifying sets which are not registered with the OSF (although such use would not facilitate interoperability without registration).

### 13.10.5.2 Access Routines

The following routines are for accessing the OSF character and code set registry. These routines map a code set string name to code set id and vice versa. They also help in determining character set compatibility. These routine interfaces, their semantics and their actual implementation are not normative (i.e., ORB vendors do not have to bundle the OSF registry implementation with their products for compliance).

The following routines are adopted from *RPC Runtime Support For I18N Characters - Functional Specification* (see References in the Preface).

### *dce\_cs\_loc\_to\_rgy*

Maps a local system-specific string name for a code set to a numeric code set value specified in the code set registry.

#### *Synopsis*

```
void dce_cs_loc_to_rgy(
 idl_char *local_code_set_name,
 unsigned32 *rgy_code_set_value,
 unsigned16 *rgy_char_sets_number,
 unsigned16 **rgy_char_sets_value,
 error_status_t *status);
```

#### *Parameters*

##### *Input*

**local\_code\_set\_name** - A string that specifies the name that the local host's locale environment uses to refer to the code set. The string is a maximum of 32 bytes: 31 data bytes plus a terminating NULL character.

##### *Output*

**rgy\_code\_set\_value 0** - The registered integer value that uniquely identifies the code set specified by local\_code\_set\_name.

**rgy\_char\_sets\_number** - The number of character sets that the specified code set encodes. Specifying NULL prevents this routine from returning this parameter.

**rgy\_char\_sets\_value** - A pointer to an array of registered integer values that uniquely identify the character set(s) that the specified code set encodes. Specifying NULL prevents this routine from returning this parameter. The routine dynamically allocates this value.

**status** - Returns the status code from this routine. This status code indicates whether the routine completed successfully or, if not, why not.

The possible status codes and their meanings are as follows:

- dce\_cs\_c\_ok – Code set registry access operation succeeded.
- dce\_cs\_c\_cannot\_allocate\_memory – Cannot allocate memory for code set info.
- dce\_cs\_c\_unknown – No code set value was not found in the registry which corresponds to the code set name specified.
- dce\_cs\_c\_notfound – No local code set name was found in the registry which corresponds to the name specified.

#### *Description*

The dce\_cs\_loc\_to\_rgy() routine maps operating system-specific names for character/code set encodings to their unique identifiers in the code set registry.



The `dce_cs_loc_to_rgy()` routine takes as input a string that holds the host-specific “local name” of a code set and returns the corresponding integer value that uniquely identifies that code set, as registered in the host's code set registry. If the integer value does not exist in the registry, the routine returns the status `dce_cs_c_unknown`.

The routine also returns the number of character sets that the code set encodes and the registered integer values that uniquely identify those character sets. Specifying `NULL` in the `rgy_char_sets_number` and `rgy_char_sets_value[]` parameters prevents the routine from performing the additional search for these values. Applications that want only to obtain a code set value from the code set registry can specify `NULL` for these parameters in order to improve the routine's performance. If the value is returned from the routine, application developers should free the array after it is used, since the array is dynamically allocated.

### ***dce\_cs\_rgy\_to\_loc***

Maps a numeric code set value contained in the code set registry to the local system-specific name for a code set.

#### *Synopsis*

```
void dce_cs_rgy_to_loc(
 unsigned32 *rgy_code_set_value,
 idl_char **local_code_set_name,
 unsigned16 *rgy_char_sets_number,
 unsigned16 **rgy_char_sets_value,
 error_status_t *status);
```

#### *Parameters*

##### *Input*

**rgy\_code\_set\_value** - The registered hexadecimal value that uniquely identifies the code set.

##### *Output*

**local\_code\_set\_name** - A string that specifies the name that the local host's locale environment uses to refer to the code set. The string is a maximum of 32 bytes: 31 data bytes and a terminating `NULL` character.

**rgy\_char\_sets\_number** - The number of character sets that the specified code set encodes. Specifying `NULL` in this parameter prevents the routine from returning this value.

**rgy\_char\_sets\_value** - A pointer to an array of registered integer values that uniquely identify the character set(s) that the specified code set encodes. Specifying `NULL` in this parameter prevents the routine from returning this value. The routine dynamically allocates this value.

**status** - Returns the status code from this routine. This status code indicates whether the routine completed successfully or, if not, why not.

The possible status codes and their meanings are as follows:

- `dce_cs_c_ok` – Code set registry access operation succeeded.
- `dce_cs_c_cannot_allocate_memory` – Cannot allocate memory for code set info.
- `dce_cs_c_unknown` – The requested code set value was not found in the code set registry.
- `dce_cs_c_notfound` – No local code set name was found in the registry which corresponds to the specific code set registry ID value. This implies that the code set is not supported in the local system environment.

#### *Description*

The `dce_cs_rgy_to_loc()` routine maps a unique identifier for a code set in the code set registry to the operating system-specific string name for the code set, if it exists in the code set registry.

The `dce_cs_rgy_to_loc()` routine takes as input a registered integer value of a code set and returns a string that holds the operating system-specific, or local name, of the code set.

If the code set identifier does not exist in the registry, the routine returns the status `dce_cs_c_unknown` and returns an undefined string.

The routine also returns the number of character sets that the code set encodes and the registered integer values that uniquely identify those character sets. Specifying `NULL` in the `rgy_char_sets_number` and `rgy_char_sets_value[]` parameters prevents the routine from performing the additional search for these values. Applications that want only to obtain a local code set name from the code set registry can specify `NULL` for these parameters in order to improve the routine's performance. If the value is returned from the routine, application developers should free the `rgy_char_sets_value` array after it is used.

#### ***rpc\_cs\_char\_set\_compat\_check***

Evaluates character set compatibility between a client and a server.

#### *Synopsis*

```
void rpc_cs_char_set_compat_check(
 unsigned32 client_rgy_code_set_value,
 unsigned32 server_rgy_code_set_value,
 error_status_t *status);
```

#### *Parameters*

##### *Input*

**client\_rgy\_code\_set\_value** - The registered hexadecimal value that uniquely identifies the code set that the client is using as its local code set.

**server\_rgy\_code\_set\_value** - The registered hexadecimal value that uniquely identifies the code set that the server is using as its local code set.

##### *Output*

**status** - Returns the status code from this routine. This status code indicates whether the routine completed successfully or, if not, why not.

The possible status codes and their meanings are as follows:

- `rpc_s_ok` – Successful status.
- `rpc_s_ss_no_compat_charsets` – No compatible code set found. The client and server do not have a common encoding that both could recognize and convert.
- The routine can also return status codes from the `dce_cs_rgy_to_loc()` routine.

#### *Description*

The `rpc_cs_char_set_compat_check()` routine provides a method for determining character set compatibility between a client and a server; if the server's character set is incompatible with that of the client, then connecting to that server is most likely not acceptable, since massive data loss would result from such a connection.

The routine takes the registered integer values that represent the code sets that the client and server are currently using and calls the code set registry to obtain the registered values that represent the character set(s) that the specified code sets support. If both client and server support just one character set, the routine compares client and server registered character set values to determine whether or not the sets are compatible. If they are not, the routine returns the status message `rpc_s_ss_no_compat_charsets`.

If the client and server support multiple character sets, the routine determines whether at least two of the sets are compatible. If two or more sets match, the routine considers the character sets compatible, and returns a success status code to the caller.

#### *rpc\_rgy\_get\_max\_bytes*

Gets the maximum number of bytes that a code set uses to encode one character from the code set registry on a host

#### *Synopsis*

```
void rpc_rgy_get_max_bytes(
 unsigned32 rgy_code_set_value,
 unsigned16 *rgy_max_bytes,
 error_status_t *status);
```

#### *Parameters*

##### *Input*

**rgy\_code\_set\_value** - The registered hexadecimal value that uniquely identifies the code set.

##### *Output*

**rgy\_max\_bytes** - The registered decimal value that indicates the number of bytes this code set uses to encode one character.

**status** - Returns the status code from this routine. This status code indicates whether the routine completed successfully or, if not, why not.

The possible status codes and their meanings are as follows:

- `rpc_s_ok` – Operation succeeded.
- `dce_cs_c_cannot_allocate_memory` – Cannot allocate memory for code set info.
- `dce_cs_c_unknown` – No code set value was not found in the registry which corresponds to the code set value specified.
- `dce_cs_c_notfound` – No local code set name was found in the registry which corresponds to the value specified.

*Description*

The `rpc_rgy_get_max_bytes()` routine reads the code set registry on the local host. It takes the specified registered code set value, uses it as an index into the registry, and returns the decimal value that indicates the number of bytes that the code set uses to encode one character.

This information can be used for buffer sizing as part of the procedure to determine whether additional storage needs to be allocated for conversion between local and network code sets.

## Contents

This chapter contains the following sections.

| Section Title                                    | Page |
|--------------------------------------------------|------|
| “Introduction”                                   | 14-1 |
| “In-Line and Request-Level Bridging”             | 14-2 |
| “Proxy Creation and Management”                  | 14-5 |
| “Interface-specific Bridges and Generic Bridges” | 14-6 |
| “Building Generic Request-Level Bridges”         | 14-6 |
| “Bridging Non-Referencing Domains”               | 14-7 |
| “Bootstrapping Bridges”                          | 14-7 |

## 14.1 Introduction

This chapter provides an implementation-oriented conceptual framework for the construction of bridges to provide interoperability between ORBs. It focuses on the layered *request level bridges* that the CORBA Core specifications facilitate, although ORBs may always be internally modified to support bridges.

Key feature of the specifications for inter-ORB bridges are as follows:

- Enables requests from one ORB to be translated to requests on another.
- Provides support for managing tables keyed by object references.

The OMG IDL specification for interoperable object references, which are important to inter-ORB bridging, is shown in Section 13.6.2, “Interoperable Object References: IORs,” on page 13-14.

## 14.2 *In-Line and Request-Level Bridging*

Bridging of an invocation between a client in one domain and a server object in another domain can be mediated through a standardized mechanism, or done immediately using nonstandard ones.

The question of how this bridging is constructed is broadly independent of whether the bridging uses a standardized mechanism. There are two possible options for where the bridge components are located:

1. Code inside the ORB may perform the necessary translation or mappings; this is termed *in-line bridging*.
2. Application style code outside the ORB can perform the translation or mappings; this is termed *request-level bridging*.

Request-level bridges that mediate through a common protocol (using networking, shared memory, or some other IPC provided by the host operating system) between distinct execution environments will involve components, one in each ORB, known as “half bridges.”

When that mediation is purely internal to one execution environment, using a shared programming environment’s binary interfaces to CORBA- and OMG-IDL-defined data types, this is known as a “full bridge”<sup>1</sup>. From outside the execution environment this will appear identical to some kinds of in-line bridging, since only that environment knows the construction techniques used. However, full bridges more easily support portable policy mediation components, because of their use of only standard CORBA programming interfaces.

Network protocols may be used immediately “in-line,” or to mediate between request-level half bridges. The General Inter-ORB Protocol can be used in either manner. In addition, this specification provides for Environment Specific Inter-ORB Protocols (ESIOP), allowing for alternative mediation mechanisms.

Note that mediated, request-level half-bridges can be built by anyone who has access to an ORB, without needing information about the internal construction of that ORB. Immediate-mode request-level half-bridges (i.e., ones using nonstandard mediation mechanisms) can be built similarly without needing information about ORB internals. Only in-line bridges (using either standard or nonstandard mediation mechanisms) need potentially proprietary information about ORB internals.

---

1. Special initialization supporting object referencing domains (e.g., two protocols) to be exposed to application programmers to support construction of this style bridge.

### 14.2.1 In-line Bridging

In-line bridging is in general the most direct method of bridging between ORBs. It is structurally similar to the engineering commonly used to bridge between systems within a single ORB (e.g., mediating using some common inter-process communications scheme, such as a network protocol). This means that implementing in-line bridges involves as fundamental a set of changes to an ORB as adding a new inter-process communications scheme. (Some ORBs may be designed to facilitate such modifications, though.)

In this approach, the required bridging functionality can be provided by a combination of software components at various levels:

- As additional or alternative services provided by the underlying ORBs
- As additional or alternative stub and skeleton code.

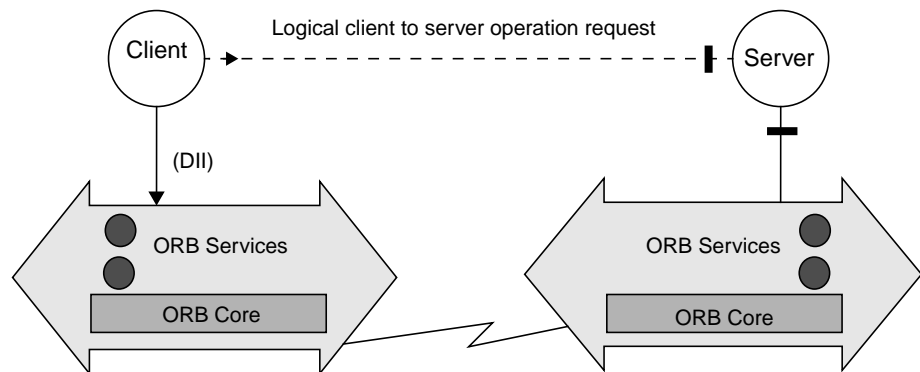

Figure 14-1 In-Line bridges are built using ORB internal APIs.

### 14.2.2 Request-level Bridging

The general principle of request-level bridging is as follows:

1. The original request is passed to a proxy object in the client ORB.
2. The proxy object translates the request contents (including the target object reference) to a form that will be understood by the server ORB.
3. The proxy invokes the required operation on the apparent server object.
4. Any operation result is passed back to the client via a complementary route.

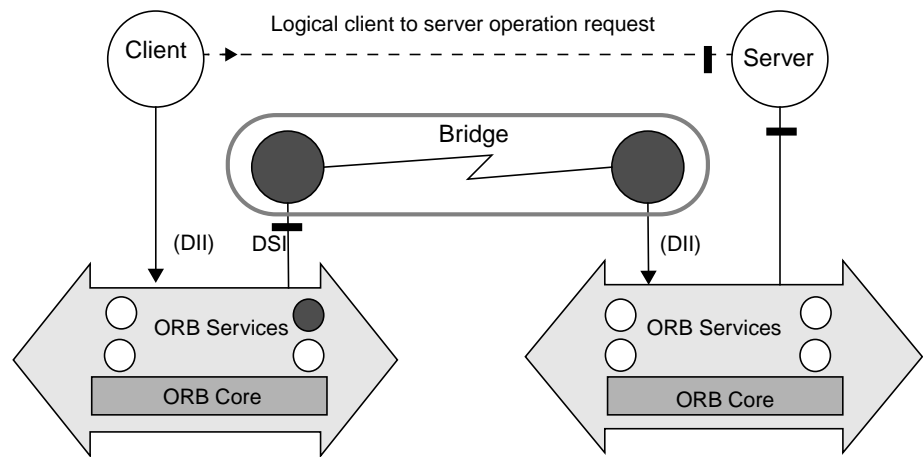

Figure 14-2 Request-Level bridges are built using *public ORB APIs*.

The request translation involves performing object reference mapping for all object references involved in the request (the target, explicit parameters, and perhaps implicit ones such as transaction context). As elaborated later, this translation may also involve mappings for other domains: the security domain of **CORBA::Principal** parameters, type identifiers, and so on.

It is a language mapping requirement of the CORBA Core specification that all dynamic typing APIs (e.g., **Any**, **NamedValue**) support such manipulation of parameters even when the bridge was not created with compile-time knowledge of the data types involved.

### 14.2.3 Collocated ORBs

In the case of immediate bridging (i.e., not via a standardized, external protocol) the means of communication between the client-side bridge component and that on the server-side is an entirely private matter. One possible engineering technique optimizes this communication by coalescing the two components into the same system or even the same address space. In the latter case, accommodations must be made by both ORBs to allow them to share the same execution environment.



Similar observations apply to request-level bridges, which in the case of collocated ORBs use a common binary interface to all OMG IDL-defined data as their mediating data format.

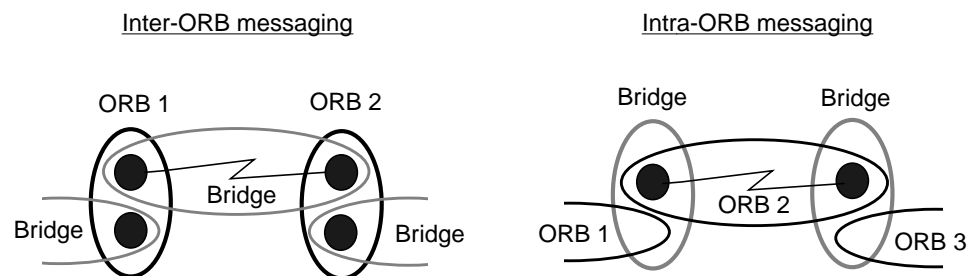

Figure 14-3 When the two ORBs are collocated in a bridge execution environment, network communications will be purely intra-ORB. If the ORBs are not collocated, such communications must go between ORBs.

An advantage of using bridges spanning collocated ORBs is that all external messaging can be arranged to be intra-ORB, using whatever message-passing mechanisms each ORB uses to achieve distribution within a single ORB, multiple machine system. That is, for bridges between networked ORBs such a bridge would add only a single “hop,” a cost analogous to normal routing.

### 14.3 Proxy Creation and Management

Bridges need to support arbitrary numbers of proxy objects, because of the (bidirectional) object reference mappings required. The key schemes for creating and managing proxies are *reference translation* and *reference encapsulation*, as discussed in Section 13.5.2, “Handling of Referencing Between Domains,” on page 13-12.

- Reference translation approaches are possible with CORBA V2.0 Core APIs. Proxies themselves can be created as normal objects using the Basic Object Adapter (BOA) and the Dynamic Skeleton Interface (DSI).
- Reference Encapsulation is not supported by the BOA, since it would call for knowledge of more than one ORB. Some ORBs could provide other object adapters that support such encapsulation.

Note that from the perspective of clients, they only deal with local objects; clients do not need to distinguish between proxies and other objects. Accordingly, all CORBA operations supported by the local ORB are also supported through a bridge. The ORB used by the client might, however, be able to recognize that encapsulation is in use, depending on how the ORB is implemented.

Also, note that the **CORBA::InterfaceDef** used when creating proxies (e.g., the one passed to **CORBA::BOA::create**) could be either a proxy to one in the target ORB, or could be an equivalent local one. When the domains being bridged include a type domain, then the **InterfaceDef** objects cannot be proxies since type descriptions will not have the same information. When bridging CORBA-compliant ORBs, type domains by definition do not need to be bridged.

## 14.4 Interface-specific Bridges and Generic Bridges

Request-level bridges may be:

- *Interface-specific*: they support predetermined IDL interfaces only, and are built using IDL-compiler generated stub and skeleton interfaces.
- *Generic*: capable of bridging requests to server objects of arbitrary IDL interfaces, using the interface repository and other dynamic invocation support (DII and DSI).

Interface-specific bridges may be more efficient in some cases (a generic bridge could conceivably create the same stubs and skeletons using the interface repository), but the requirement for prior compilation means that this approach offers less flexibility than using generic bridges.

## 14.5 Building Generic Request-Level Bridges

The CORBA Core specifications define the following interfaces. These interfaces are of particular significance when building a generic request-level bridge:

- ***Dynamic Invocation Interface (DII)*** lets the bridge make arbitrary invocations on object references whose types may not have been known when the bridge was developed or deployed.
- ***Dynamic Skeleton Interface (DSI)*** lets the bridge handle invocations on proxy object references that it implements, even when their types may not have been known when the bridge was developed or deployed.
- ***Interface Repositories*** are consulted by the bridge to acquire the information used to drive DII and DSI, such as the type codes for operation parameters, return values, and exceptions.
- ***Object Adapters*** (such as the Basic Object Adapter) are used to create proxy object references both when bootstrapping the bridge and when mapping object references, which are dynamically passed from one ORB to the other.
- ***CORBA Object References*** support operations to fully describe their interfaces and to create tables mapping object references to their proxies (and vice versa).

Interface repositories accessed on either side of a half bridge need not have the same information, though of course the information associated with any given repository ID (e.g., an interface type ID, exception ID) or operation ID must be the same.

Using these interfaces and an interface to some common transport mechanism such as TCP, portable request-level half bridges connected to an ORB can:

- Use DSI to translate all CORBA invocations on proxy objects to the form used by some mediating protocol such as IIOP (see the *General Inter-ORB Protocol* chapter).
- Translate requests made using such a mediating protocol into DII requests on objects in the ORB.

As noted in Section 14.2, “In-Line and Request-Level Bridging,” on page 14-2, translating requests and responses (including exceptional responses) involves mapping object references (and other explicit and implicit parameter data) from the form used by the ORB to the form used by the mediating protocol, and vice versa. Explicit parameters, which are defined by an operation’s OMG-IDL definition, are presented through DII or DSI and are listed in the Interface Repository entry for any particular operation.

Operations on object references such as **hash()** and **is\_equivalent()** may be used to maintain tables that support such mappings. When such a mapping does not exist, an object adapter is used to create ORB-specific proxy object references, and bridge-internal interfaces are used to create the analogous data structure for the mediating protocol.

## 14.6 *Bridging Non-Referencing Domains*

In the simplest form of request-level bridging, the bridge operates only on IDL-defined data, and bridges only object reference domains. In this case, a proxy object in the client ORB acts as a representative of the target object and is, in almost any practical sense, indistinguishable from the target server object - indeed, even the client ORB will not be aware of the distinction.

However, as alluded to above, there may be multiple domains that need simultaneous bridging. The transformation and encapsulation schemes described above may not apply in the same way to Principal or type identifiers. Request-level bridges may need to translate such identifiers, in addition to object references, as they are passed as explicit operation parameters.

Moreover, there is an emerging class of “implicit context” information that ORBs may need to convey with any particular request, such as transaction and security context information. Such parameters are not defined as part of an operation’s OMG-IDL signature, hence are “implicit” in the invocation context. Bridging the domains of such implicit parameters could involve additional kinds of work, needing to mediate more policies than bridging the object reference, Principal, and type domains directly addressed by CORBA.

CORBA does not yet have a generic way (including support for both static and dynamic invocations) to expose such implicit context information.

## 14.7 *Bootstrapping Bridges*

A particularly useful policy for setting up bridges is to create a pair of proxies for two Naming Service naming contexts (one in each ORB) and then install those proxies as naming contexts in the other ORB’s naming service. (The Naming Service is described in the Naming Service specification.) This will allow clients in either ORB to transparently perform naming context lookup operations on the other ORB, retrieving (proxy) object references for other objects in that ORB. In this way, users can access

facilities that have been selectively exported from another ORB, through a naming context, with no administrative action beyond exporting those initial contexts. (See Section 4.7, “Current Object,” on page 4-36 for additional information).

This same approach may be taken with other discovery services, such as a trading service or any kind of object that could provide object references as operation results (and in “out” parameters). While bridges can be established that only pass a predefined set of object references, this kind of minimal connectivity policy is not always desirable.

This chapter specifies a General Inter-ORB Protocol (GIOP) for ORB interoperability, which can be mapped onto any connection-oriented transport protocol that meets a minimal set of assumptions. This chapter also defines a specific mapping of the GIOP, which runs directly over TCP/IP connections, called the Internet Inter-ORB Protocol (IIOP). The IIOP must be supported by conforming networked ORB products regardless of other aspects of their implementation. Such support does not require using it internally; conforming ORBs may also provide bridges to this protocol.

## Contents

This chapter contains the following sections.

| Section Title                             | Page  |
|-------------------------------------------|-------|
| “Goals of the General Inter-ORB Protocol” | 15-2  |
| “GIOP Overview”                           | 15-2  |
| “CDR Transfer Syntax”                     | 15-4  |
| “GIOP Message Formats”                    | 15-30 |
| “GIOP Message Transport”                  | 15-46 |
| “Object Location”                         | 15-49 |
| “Internet Inter-ORB Protocol (IIOP)”      | 15-51 |
| “Bi-Directional GIOP”                     | 15-56 |
| “Bi-directional GIOP policy”              | 15-60 |
| “OMG IDL”                                 | 15-60 |

## 15.1 Goals of the General Inter-ORB Protocol

The GIOP and IIOP support protocol-level ORB interoperability in a general, low-cost manner. The following objectives were pursued vigorously in the GIOP design:

- **Widest possible availability** - The GIOP and IIOP are based on the most widely-used and flexible communications transport mechanism available (TCP/IP), and defines the minimum additional protocol layers necessary to transfer CORBA requests between ORBs.
- **Simplicity** - The GIOP is intended to be as simple as possible, while meeting other design goals. Simplicity is deemed the best approach to ensure a variety of independent, compatible implementations.
- **Scalability** - The GIOP/IIOP protocol should support ORBs, and networks of bridged ORBs, to the size of today's Internet, and beyond.
- **Low cost** - Adding support for GIOP/IIOP to an existing or new ORB design should require small engineering investment. Moreover, the run-time costs required to support IIOP in deployed ORBs should be minimal.
- **Generality** - While the IIOP is initially defined for TCP/IP, GIOP message formats are designed to be used with any transport layer that meets a minimal set of assumptions; specifically, the GIOP is designed to be implemented on other connection-oriented transport protocols.
- **Architectural neutrality** - The GIOP specification makes minimal assumptions about the architecture of agents that will support it. The GIOP specification treats ORBs as opaque entities with unknown architectures.

The approach a particular ORB takes to providing support for the GIOP/IIOP is undefined. For example, an ORB could choose to use the IIOP as its internal protocol, it could choose to externalize IIOP as much as possible by implementing it in a half-bridge, or it could choose a strategy between these two extremes. All that is required of a conforming ORB is that some entity or entities in, or associated with, the ORB be able to send and receive IIOP messages.

## 15.2 GIOP Overview

The GIOP specification consists of the following elements:

- **The Common Data Representation (CDR) definition.** CDR is a transfer syntax mapping OMG IDL data types into a bicanonical low-level representation for "on-the-wire" transfer between ORBs and Inter-ORB bridges (agents).
- **GIOP Message Formats.** GIOP messages are exchanged between agents to facilitate object requests, locate object implementations, and manage communication channels.
- **GIOP Transport Assumptions.** The GIOP specification describes general assumptions made concerning any network transport layer that may be used to transfer GIOP messages. The specification also describes how connections may be managed, and constraints on GIOP message ordering.

The IIOP specification adds the following element to the GIOP specification:

- *Internet IOP Message Transport.* The IIOP specification describes how agents open TCP/IP connections and use them to transfer GIOP messages.

The IIOP is not a separate specification; it is a specialization, or mapping, of the GIOP to a specific transport (TCP/IP). The GIOP specification (without the transport-specific IIOP element) may be considered as a separate conformance point for future mappings to other transport layers.

The complete OMG IDL specifications for the GIOP and IIOP are shown in Section 15.10, “OMG IDL,” on page 15-60. Fragments of the specification are used throughout this chapter as necessary.

### 15.2.1 Common Data Representation (CDR)

CDR is a transfer syntax, mapping from data types defined in OMG IDL to a bicononical, low-level representation for transfer between agents. CDR has the following features:

- *Variable byte ordering* - Machines with a common byte order may exchange messages without byte swapping. When communicating machines have different byte order, the message originator determines the message byte order, and the receiver is responsible for swapping bytes to match its native ordering. Each GIOP message (and CDR encapsulation) contains a flag that indicates the appropriate byte order.
- *Aligned primitive types* - Primitive OMG IDL data types are aligned on their natural boundaries within GIOP messages, permitting data to be handled efficiently by architectures that enforce data alignment in memory.
- *Complete OMG IDL Mapping* - CDR describes representations for all OMG IDL data types, including transferable pseudo-objects such as TypeCodes. Where necessary, CDR defines representations for data types whose representations are undefined or implementation-dependent in the CORBA Core specifications.

### 15.2.2 GIOP Message Overview

The GIOP specifies formats for messages that are exchanged between inter-operating ORBs. GIOP message formats have the following features:

- *Few, simple messages.* With only seven message formats, the GIOP supports full CORBA functionality between ORBs, with extended capabilities supporting object location services, dynamic migration, and efficient management of communication resources. GIOP semantics require no format or binding negotiations. In most cases, clients can send requests to objects immediately upon opening a connection.
- *Dynamic object location.* Many ORBs’ architectures allow an object implementation to be activated at different locations during its lifetime, and may allow objects to migrate dynamically. GIOP messages provide support for object location and migration, without requiring ORBs to implement such mechanisms when unnecessary or inappropriate to an ORB’s architecture.

- **Full CORBA support** - GIOP messages directly support all functions and behaviors required by CORBA, including exception reporting, passing operation context, and remote object reference operations (such as **CORBA::Object::get\_interface**).

GIOP also supports passing service-specific context, such as the transaction context defined by the Transaction Service (the Transaction Service is described in *CORBA services: Common Object Service Specifications*). This mechanism is designed to support any service that requires service related context to be implicitly passed with requests.

### 15.2.3 GIOP Message Transfer

The GIOP specification is designed to operate over any connection-oriented transport protocol that meets a minimal set of assumptions (described in Section 15.5, “GIOP Message Transport,” on page 15-46). GIOP uses underlying transport connections in the following ways:

- **Asymmetrical connection usage** - The GIOP defines two distinct roles with respect to connections, client, and server. The client side of a connection originates the connection, and sends object requests over the connection. In GIOP versions 1.0 and 1.1, the server side receives requests and sends replies. The server side of a connection may not send object requests. This restriction, which was included to make GIOP 1.0 and 1.1 much simpler and avoid certain race conditions, has been relaxed for GIOP version 1.2 and 1.3, as specified in the BiDirectional GIOP specification, see Section 15.8, “Bi-Directional GIOP,” on page 15-56.
- **Request multiplexing** - If desirable, multiple clients within an ORB may share a connection to send requests to a particular ORB or server. Each request uniquely identifies its target object. Multiple independent requests for different objects, or a single object, may be sent on the same connection.
- **Overlapping requests** - In general, GIOP message ordering constraints are minimal. GIOP is designed to allow overlapping asynchronous requests; it does not dictate the relative ordering of requests or replies. Unique request/reply identifiers provide proper correlation of related messages. Implementations are free to impose any internal message ordering constraints required by their ORB architectures.
- **Connection management** - GIOP defines messages for request cancellation and orderly connection shutdown. These features allow ORBs to reclaim and reuse idle connection resources.

## 15.3 CDR Transfer Syntax

The Common Data Representation (CDR) transfer syntax is the format in which the GIOP represents OMG IDL data types in an octet stream.

An octet stream is an abstract notion that typically corresponds to a memory buffer that is to be sent to another process or machine over some IPC mechanism or network transport. For the purposes of this discussion, an octet stream is an arbitrarily long (but finite) sequence of eight-bit values (octets) with a well-defined beginning. The octets in



the stream are numbered from  $0$  to  $n-1$ , where  $n$  is the size of the stream. The numeric position of an octet in the stream is called its *index*. Octet indices are used to calculate alignment boundaries, as described in Section 15.3.1.1, “Alignment,” on page 15-5.

GIOP defines two distinct kinds of octet streams, messages and encapsulations. Messages are the basic units of information exchange in GIOP, described in detail in Section 15.4, “GIOP Message Formats,” on page 15-30.

Encapsulations are octet streams into which OMG IDL data structures may be marshaled independently, apart from any particular message context. Once a data structure has been encapsulated, the **octet** stream can be represented as the OMG IDL opaque data type **sequence<octet>**, which can be marshaled subsequently into a message or another encapsulation. Encapsulations allow complex constants (such as TypeCodes) to be pre-marshaled; they also allow certain message components to be handled without requiring full unmarshaling. Whenever encapsulations are used in CDR or the GIOP, they are clearly noted.

### 15.3.1 Primitive Types

Primitive data types are specified for both big-endian and little-endian orderings. The message formats (see Section 15.4, “GIOP Message Formats,” on page 15-30) include tags in message headers that indicate the byte ordering in the message. Encapsulations include an initial flag that indicates the byte ordering within the encapsulation, described in Section 15.3.3, “Encapsulation,” on page 15-14. The byte ordering of any encapsulation may be different from the message or encapsulation within which it is nested. It is the responsibility of the message recipient to translate byte ordering if necessary. Primitive data types are encoded in multiples of octets. An **octet** is an 8-bit value.

#### 15.3.1.1 Alignment

In order to allow primitive data to be moved into and out of octet streams with instructions specifically designed for those primitive data types, in CDR all primitive data types must be aligned on their natural boundaries (i.e., the alignment boundary of a primitive datum is equal to the size of the datum in **octets**). Any primitive of size  $n$  octets must start at an octet stream index that is a multiple of  $n$ . In CDR,  $n$  is one of 1, 2, 4, or 8.

Where necessary, an alignment gap precedes the representation of a primitive datum. The value of **octets** in alignment gaps is undefined. A gap must be the minimum size necessary to align the following primitive. Table 15-1 gives alignment boundaries for CDR/OMG-IDL primitive types.

Table 15-1 Alignment requirements for OMG IDL primitive data types

| TYPE               | OCTET ALIGNMENT                                    |
|--------------------|----------------------------------------------------|
| char               | 1                                                  |
| wchar              | 1, 2 or 4 for GIOP 1.1  <br>1 for GIOP 1.2 and 1.3 |
| octet              | 1                                                  |
| short              | 2                                                  |
| unsigned short     | 2                                                  |
| long               | 4                                                  |
| unsigned long      | 4                                                  |
| long long          | 8                                                  |
| unsigned long long | 8                                                  |
| float              | 4                                                  |
| double             | 8                                                  |
| long double        | 8                                                  |
| boolean            | 1                                                  |
| enum               | 4                                                  |

Alignment is defined above as being relative to the beginning of an octet stream. The first octet of the stream is octet index zero (0); any data type may be stored starting at this index. Such octet streams begin at the start of a GIOP message header (see Section 15.4.1, “GIOP Message Header,” on page 15-31) and at the beginning of an encapsulation, even if the encapsulation itself is nested in another encapsulation. (See Section 15.3.3, “Encapsulation,” on page 15-14).

### 15.3.1.2 Integer Data Types

Figure 15-1 on page 15-7 illustrates the representations for OMG IDL integer data types, including the following data types:

- **short**
- **unsigned short**
- **long**
- **unsigned long**
- **long long**
- **unsigned long long**

The figure illustrates bit ordering and size. Signed types (**short**, **long**, and **long long**) are represented as two's complement numbers; unsigned versions of these types are represented as unsigned binary numbers.

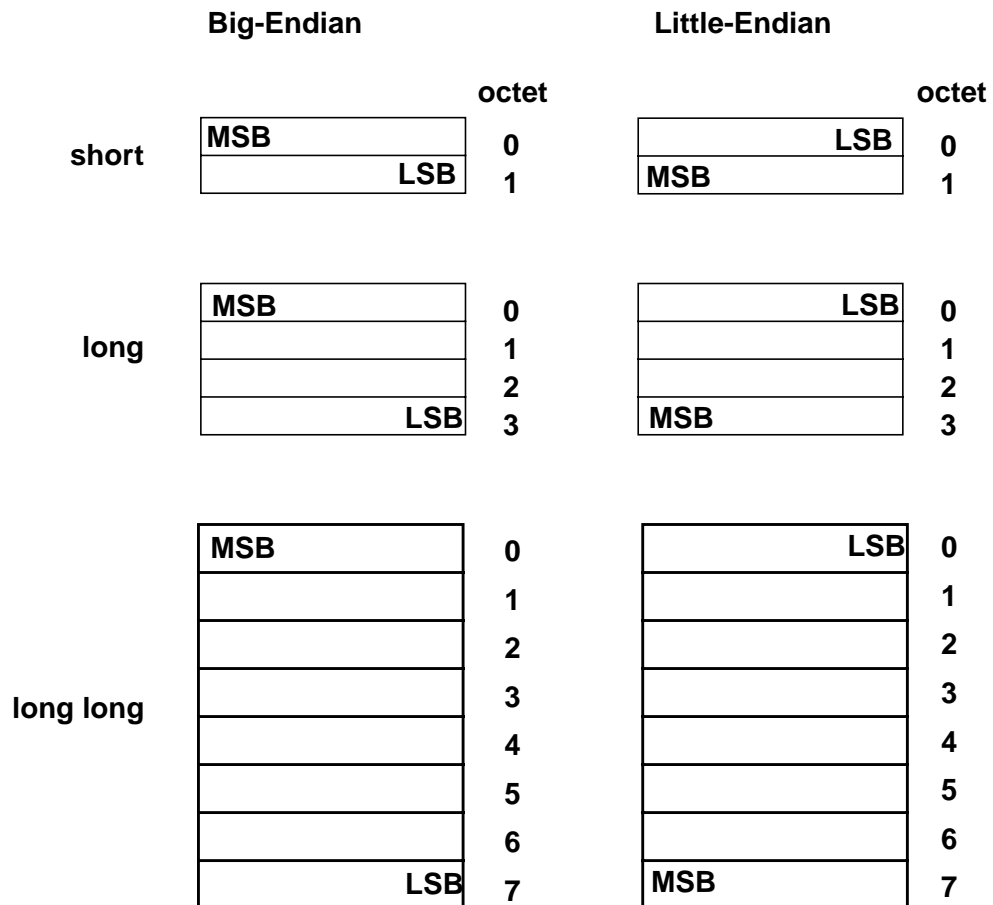

Figure 15-1 Sizes and bit ordering in big-endian and little-endian encodings of OMG IDL integer data types, both signed and unsigned.

### 15.3.1.3 Floating Point Data Types

Figure 15-2 on page 15-9 illustrates the representation of floating point numbers. These exactly follow the IEEE standard formats for floating point numbers<sup>1</sup>, selected parts of which are abstracted here for explanatory purposes. The diagram shows three different components for floating points numbers, the sign bit (s), the exponent (e) and the fractional part (f) of the mantissa. The sign bit has values of 0 or 1, representing positive and negative numbers, respectively.

1. "IEEE Standard for Binary Floating-Point Arithmetic," ANSI/IEEE Standard 754-1985, Institute of Electrical and Electronics Engineers, August 1985.

For single-precision float values the exponent is 8 bits long, comprising e1 and e2 in the figure, where the 7 bits in e1 are most significant. The exponent is represented as excess 127. The fractional mantissa (f1 - f3) is a 23-bit value f where  $1.0 \leq f < 2.0$ , f1 being most significant and f3 being least significant. The value of a normalized number is described by:

$$-1^{sign} \times 2^{(exponent - 127)} \times (1 + fraction)$$

For double-precision values the exponent is 11 bits long, comprising e1 and e2 in the figure, where the 7 bits in e1 are most significant. The exponent is represented as excess 1023. The fractional mantissa (f1 - f7) is a 52-bit value m where  $1.0 \leq m < 2.0$ , f1 being most significant and f7 being least significant. The value of a normalized number is described by:

$$-1^{sign} \times 2^{(exponent - 1023)} \times (1 + fraction)$$

For double-extended floating-point values the exponent is 15 bits long, comprising e1 and e2 in the figure, where the 7 bits in e1 are the most significant. The fractional mantissa (f1 through f14) is 112 bits long, with f1 being the most significant. The value of a **long double** is determined by:

$$-1^{sign} \times 2^{(exponent - 16383)} \times (1 + fraction)$$

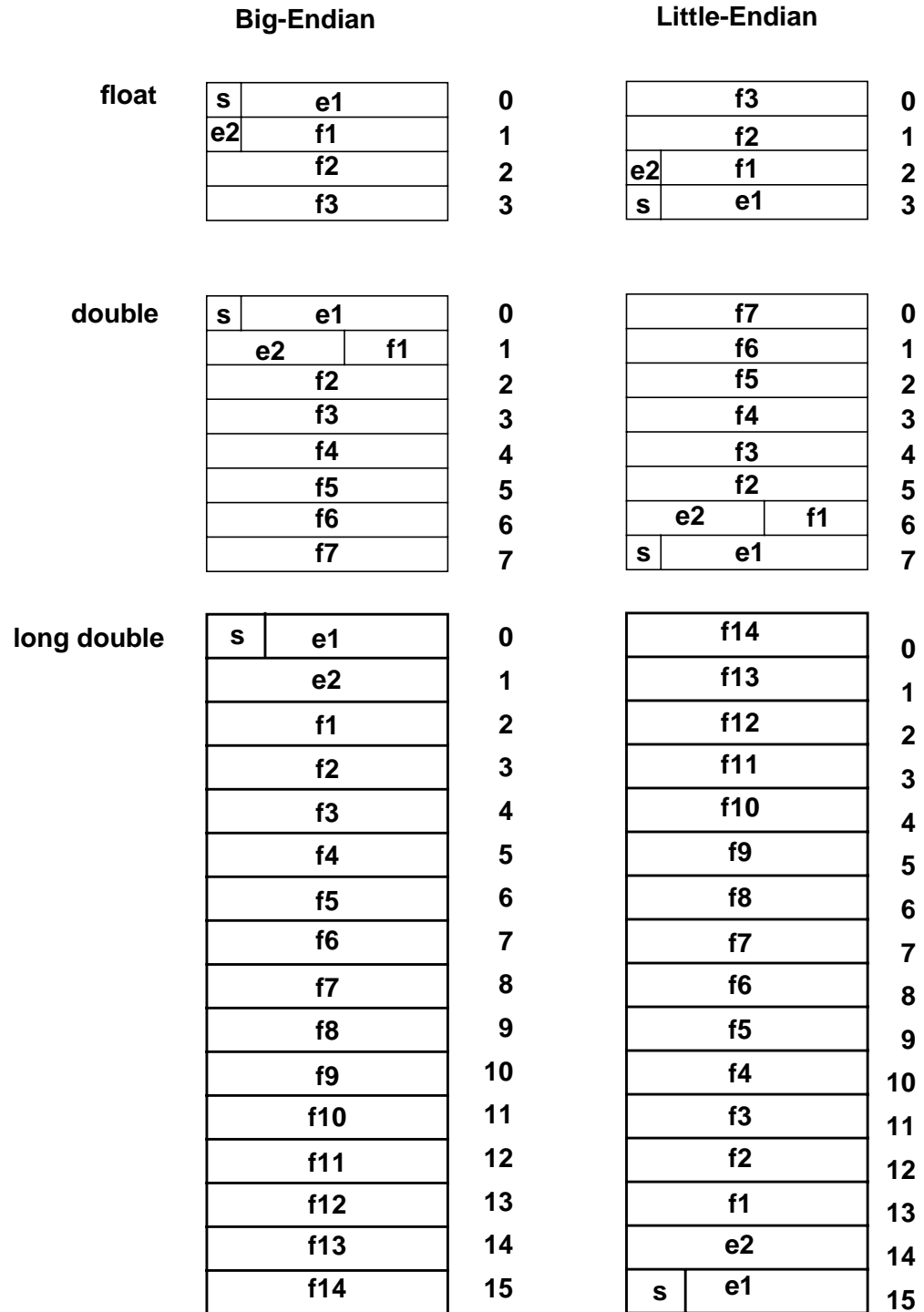

Figure 15-2 Sizes and bit ordering in big-endian and little-endian representations of OMG IDL single, double precision, and double extended floating point numbers.

#### 15.3.1.4 *Octet*

**Octets** are uninterpreted 8-bit values whose contents are guaranteed not to undergo any conversion during transmission. For the purposes of describing possible **octet** values in this specification, octets may be considered as unsigned 8-bit integer values.

#### 15.3.1.5 *Boolean*

**Boolean** values are encoded as single octets, where **TRUE** is the value 1, and **FALSE** as 0.

#### 15.3.1.6 *Character Types*

An IDL character is represented as a single octet; the code set used for transmission of character data (e.g., TCS-C) between a particular client and server ORBs is determined via the process described in Section 13.10, “Code Set Conversion,” on page 13-37. In the case of multi-byte encodings of characters, a single instance of the **char** type may only hold one octet of any multi-byte character encoding.

---

**Note** – Full representation of multi-byte characters will require the use of an array of IDL **char** variables.

---

For GIOP version 1.1, the transfer syntax for an IDL wide character depends on whether the transmission code set (TCS-W, which is determined via the process described in Section 13.10, “Code Set Conversion,” on page 13-37) is byte-oriented or non-byte-oriented:

- Byte-oriented (e.g., SJIS). Each wide character is represented as one or more octets, as defined by the selected TCS-W.
- Non-byte-oriented (e.g., Unicode UTF-16). Each wide character is represented as one or more codepoints. A codepoint is the same as “Coded-Character data element,” or “CC data element” in ISO terminology. Each codepoint is encoded using a fixed number of bits as determined by the selected TCS-W. The OSF Character and Code Set Registry may be examined using the interfaces in Section 13.10.5, “Relevant OSFM Registry Interfaces,” on page 13-50 to determine the maximum length (`max_bytes`) of any character codepoint. For example, if the TCS-W is ISO 10646 UCS-2 (Universal Character Set containing 2 bytes), then wide characters are represented as **unsigned shorts**. For ISO 10646 UCS-4, they are represented as **unsigned longs**.

For GIOP version 1.2, and 1.3 **wchar** is encoded as an unsigned binary octet value, followed by the elements of the octet sequence representing the encoded value of the **wchar**. The initial octet contains a count of the number of elements in the sequence, and the elements of the sequence of octets represent the **wchar**, using the negotiated wide character encoding.

---

**Note** – The GIOP 1.2 and 1.3 encoding of **wchar** is similar to the encoding of an octet sequence, except for its use of a single octet to encode the value of the length.

---

For GIOP versions prior to 1.2 and 1.3, interoperability for **wchar** is limited to the use of two- octet fixed-length encoding.

**Wchar** values in encapsulations are assumed to be encoded using GIOP version 1.2 and 1.3 CDR.

If UTF-16 is selected as the TCS-W the CDR encoding purposes can be big endian or little endian, but defaults to big endian. By placing a BOM (byte order marker) at the front of the **wstring** or **wchar** encoding, it can be sent either big-endian or little-endian. In particular, the CDR rules for endian-ness of UTF-16 encoded **wstring** or **wchar** values are as follows:

- If the first two bytes (after the length indication) are FE FF, it's big-endian.
- If the first two bytes (after the length indication) are FF FE, it's little-endian.
- If the first two bytes (after the length indication) are neither, it's big-endian.

If an ORB decides to use BOM to indicate endianness, it shall add the BOM to the beginning of **wchar** or **wstring** values when encoding the value, since it is not present in **wchar** or **wstring** values passed by the user.

If a BOM is present at the beginning of a **wchar** or **wstring** received in a GIOP message, the ORB shall remove the BOM before passing the value to the user.

If a client orb erroneously sends **wchar** or **wstring** data in a GIOP 1.0 message, the server shall generate a **MARSHAL** standard system exception, with standard minor code 5.

If a server erroneously sends **wchar** data in a GIOP 1.0 response, the client ORB shall raise a **MARSHAL** exception to the client application with standard minor code 6.

## 15.3.2 *OMG IDL Constructed Types*

Constructed types are built from OMG IDL's data types using facilities defined by the OMG IDL language.

### 15.3.2.1 *Alignment*

Constructed types have no alignment restrictions beyond those of their primitive components. The alignment of those primitive types is not intended to support use of marshaling buffers as equivalent to the implementation of constructed data types within any particular language environment. GIOP assumes that agents will usually construct structured data types by copying primitive data between the marshaled buffer and the appropriate in-memory data structure layout for the language mapping implementation involved.

### 15.3.2.2 *Struct*

The components of a structure are encoded in the order of their declaration in the structure. Each component is encoded as defined for its data type.

### 15.3.2.3 *Union*

Unions are encoded as the discriminant tag of the type specified in the union declaration, followed by the representation of any selected member, encoded as its type indicates.

### 15.3.2.4 *Array*

Arrays are encoded as the array elements in sequence. As the array length is fixed, no length values are encoded. Each element is encoded as defined for the type of the array. In multidimensional arrays, the elements are ordered so the index of the first dimension varies most slowly, and the index of the last dimension varies most quickly.

### 15.3.2.5 *Sequence*

Sequences are encoded as an unsigned long value, followed by the elements of the sequence. The initial unsigned long contains the number of elements in the sequence. The elements of the sequence are encoded as specified for their type.

### 15.3.2.6 *Enum*

Enum values are encoded as unsigned longs. The numeric values associated with enum identifiers are determined by the order in which the identifiers appear in the enum declaration. The first enum identifier has the numeric value zero (0). Successive enum identifiers take ascending numeric values, in order of declaration from left to right.

### 15.3.2.7 *Strings and Wide Strings*

A string is encoded as an **unsigned long** indicating the length of the string in octets, followed by the string value in single- or multi-byte form represented as a sequence of octets. The string contents include a single terminating null character. The string length includes the null character, so an empty string has a length of 1.

For GIOP version 1.1, 1.2, and 1.3, when encoding a string, always encode the length as the total number of bytes used by the encoding string, regardless of whether the encoding is byte-oriented or not.

For GIOP version 1.1, a wide string is encoded as an **unsigned long** indicating the length of the string in octets or unsigned integers (determined by the transfer syntax for wchar) followed by the individual wide characters. The string contents include a single terminating null character. The string length includes the null character. The terminating null character for a wstring is also a wide character.



For GIOP version 1.2 and 1.3, when encoding a **wstring**, always encode the length as the total number of octets used by the encoded value, regardless of whether the encoding is byte-oriented or not. For GIOP version 1.2 and 1.3 a **wstring** is not terminated by a null character. In particular, in GIOP version 1.2 and 1.3 a length of 0 is legal for **wstring**.

---

**Note** – For GIOP versions prior to 1.2 and 1.3, interoperability for **wstring** is limited to the use of two-octet fixed-length encoding.

---

**Wstring** values in encapsulations are assumed to be encoded using GIOP version 1.2 and 1.3 CDR.

### 15.3.2.8 Fixed-Point Decimal Type

The IDL **fixed** type has no alignment restrictions, and is represented as shown in Table 15-4 on page 15-14. Each **octet** contains (up to) two decimal digits. If the **fixed** type has an odd number of decimal digits, then the representation begins with the first (most significant) digit — d0 in the figure. Otherwise, this first half-octet is all zero, and the first digit is in the second half-octet — d1 in the figure. The sign configuration, in the last half-octet of the representation, is 0xD for negative numbers and 0xC for positive and zero values.

The number of digits present must equal the number of significant digits specified in the IDL definition for the fixed type being marshalled, with the exception of the inclusion of a leading 0x0 half octet when there are an even number of significant digits.

Decimal digits are encoded as hexadecimal values in each half-octet as follows:

| Decimal Digit | Half-Octet Value |
|---------------|------------------|
| 0             | 0x0              |
| 1             | 0x1              |
| 2             | 0x2              |
| ...           | ...              |
| 9             | 0x9              |

Figure 15-3 Decimal Digit Encoding for Fixed Type

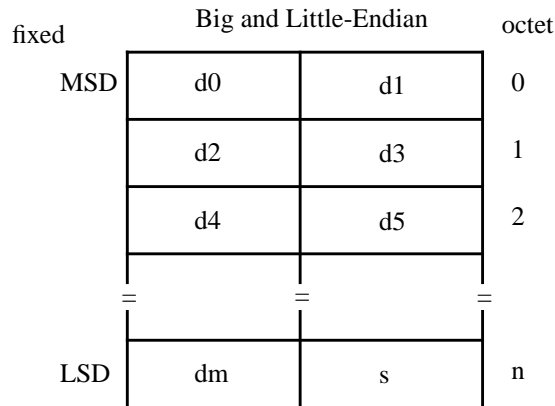

Figure 15-4 IDL Fixed Type Representation

### 15.3.3 Encapsulation

As described above, OMG IDL data types may be independently marshaled into encapsulation octet streams. The octet stream is represented as the OMG IDL type **sequence<octet>**, which may be subsequently included in a GIOP message or nested in another encapsulation.

The GIOP and IOP explicitly use encapsulations in three places: *TypeCodes* (see Section 15.3.5.1, “TypeCode,” on page 15-23), the IOP protocol profile inside an IOR (see Section 15.3.6, “Object References,” on page 15-30), and in service-specific context (see Section 13.7, “Service Context,” on page 13-28). In addition, some ORBs may choose to use an encapsulation to hold the **object\_key** (see Section 15.7.2, “IOP IOR Profiles,” on page 15-52), or in other places that a **sequence<octet>** data type is in use.

When encapsulating OMG IDL data types, the first octet in the stream (index 0) contains a boolean value indicating the byte ordering of the encapsulated data. If the value is **FALSE** (0), the encapsulated data is encoded in big-endian order; if **TRUE** (1), the data is encoded in little-endian order, exactly like the byte order flag in GIOP message headers (see Section 15.4.1, “GIOP Message Header,” on page 15-31). This value is not part of the data being encapsulated, but is part of the octet stream holding the encapsulation. Following the byte order flag, the data to be encapsulated is marshaled into the buffer as defined by CDR encoding rules. Marshaled data are aligned relative to the beginning of the octet stream (the first octet of which is occupied by the byte order flag).

When the encapsulation is encoded as type **sequence<octet>** for subsequent marshaling, an unsigned long value containing the sequence length is prefixed to the octet stream, as prescribed for sequences (see Section 15.3.2.5, “Sequence,” on page 15-12). The length value is not part of the encapsulation’s octet stream, and does not affect alignment of data within the encapsulation.

Note that this guarantees a four-octet alignment of the start of all encapsulated data within GIOP messages and nested encapsulations.<sup>2</sup>

Whenever the use of an encapsulation is specified, the GIOP version to use for encoding the encapsulation, if different than GIOP version 1.0, shall be explicitly defined (i.e., the default is GIOP 1.0).

If a parameter with IDL char or string type is defined to be carried in an encapsulation using GIOP version greater than 1.0, the transmission Code Set for characters (TCS-C), to be used when encoding the encapsulation, shall also be explicitly defined.

If a parameter with IDL wchar or wstring type is defined to be carried in an encapsulation using GIOP version greater than 1.0, the transmission Code Set for wide characters (TCS-W), to be used when encoding the encapsulation shall also be explicitly defined.

### 15.3.4 Value Types

Value types are built from OMG IDL's value type definitions. Their representation and encoding is defined in this section.

Value types may be used to transmit and encode complex state. The general approach is to support the transmission of the data (state) and type information encoded as **RepositoryIDs**.

The loading (and possible transmission) of code is outside of the scope of the GIOP definition, but enough information is carried to support it, via the CodeBase object.

The format makes a provision for the support of custom marshaling (i.e., the encoding and transmission of state using application-defined code). Consistency between custom encoders and decoders is not ensured by the protocol

The encoding supports all of the features of value types as well as supporting the "chunking" of value types. It does so in a compact way.

At a high level the format can be described as the linearization of a graph. The graph is the depth-first exploration of the transitive closure that starts at the top-level value object and follows its "reference to value objects" fields (an ordinary remote reference is just written as an IOR). It is a recursive encoding similar to the one used for TypeCodes. An indirection is used to point to a value that has already been encoded.

The data members are written beginning with the highest possible base type to the most derived type in the order of their declaration.

---

2. Accordingly, in cases where encapsulated data holds data with natural alignment of greater than four octets, some processors may need to copy the octet data before removing it from the encapsulation. For example, an appropriate way to deal with long long discriminator type in an encapsulation for a union TypeCode is to encode the body of the encapsulation as if it was aligned at the 8 byte boundary, and then copy the encoded value into the encapsulation. This may result in long long data values inside the encapsulation being aligned on only a 4 byte boundary when viewed from outside the encapsulation.

### 15.3.4.1 Partial Type Information and Versioning

The format provides support for partial type information and versioning issues in the receiving context. However the encoding has been designed so that this information is only required when “advanced features” such as truncation are used.

The presence (or absence) of type information and codebase URL information is indicated by flags within the <value\_tag>, which is a **long** in the range between **0x7fffff00** and **0x7fffffff** inclusive. The last octet of this tag is interpreted as follows:

- The least significant bit (<value\_tag> & **0x00000001**) is the value **1** if a <codebase\_URL> is present. If this bit is **0**, no <codebase\_URL> follows in the encoding. The <codebase\_URL> is a blank-separated list of one or more URLs.
- The second and third least significant bits (<value\_tag> & **0x00000006**) are:
  - the value **0** if no type information is present in the encoding. This indicates the actual parameter is the same type as the formal argument.
  - the value **2** if only a single repository id is present in the encoding, which indicates the most derived type of the actual parameter (which may be either the same type as the formal argument or one of its derived types).
  - the value **6** if the partial type information list of repository ids is present in the encoding as a list of repository ids.

When a list of **RepositoryIDs** is present, the encoding is a **long** specifying the number of **RepositoryIDs**, followed by the **RepositoryIDs**. The first **RepositoryID** is the id for the most derived type of the value. If this type has any base types, the sending context is responsible for listing the **RepositoryIDs** for all the base types to which it is safe to truncate the value passed. These truncatable base types are listed in order, going up the derivation hierarchy. The sending context may choose to (but need not) terminate the list at any point after it has sent a **RepositoryID** for a type well-known to the receiving context. A well-known type is any of the following:

- a type that is a formal parameter, result of the method call, or exception, for which this GIOP message is being marshaled
- a base type of a well-known type
- a member type of a well-known type
- an element type of a well known type

For value types that have an RMI: **RepositoryId**, ORBs must include at least the most derived **RepositoryId**, in the value type encoding.

For value types marshaled as abstract interfaces (see Section 15.3.7, “Abstract Interfaces,” on page 15-30), **RepositoryId** information must be included in the value type encoding.

If the receiving context needs more typing information than is contained in a GIOP message that contains a codebase URL information, it can go back to the sending context and perform a lookup based on that **RepositoryID** to retrieve more typing information (e.g., the type graph).

CORBA **RepositoryIDs** may contain standard version identification (major and minor version numbers or a hash code information). The ORB run time may use this information to check whether the version of the value being transmitted is compatible with the version expected. In the event of a version mismatch, the ORB may apply product-specific truncation/conversion rules (with the help of a local interface repository or the **SendingContext::RunTime** service). For example, the Java serialization model of truncation/conversion across versions can be supported. See the JDK 1.1 documentation for a detailed specification of this model.

### 15.3.4.2 Example

The following examples demonstrate legal combinations of truncatability, actual parameter types and GIOP encodings. This is not intended to be an exhaustive list of legal possibilities.

The following example uses valuetypes **animal** and **horse**, where **horse** is derived from **animal**. The actual parameters passed to the specified operations are **an\_animal** of runtime type **animal** and **a\_horse** of runtime type **horse**.

The following combinations of truncatability, actual parameter types and GIOP encodings are legal.

1. If there is a single operation:

**op1(in animal a);**

- a) If the type **horse** cannot be truncated to **animal** (i.e., **horse** is declared):

**valuetype horse: animal ...**

then the encoding is as shown below:

| Actual Invocation   | Legal Encoding |
|---------------------|----------------|
| <b>op1(a_horse)</b> | 2 horse        |
|                     | 6 1 horse      |

Note that if the type **horse** is not available to the receiver, then the receiver throws a demarshaling exception.

- b). If the type **horse** can be truncated to **animal** (i.e., **horse** is declared):

**valuetype horse: truncatable animal ...**

then the encoding is as shown below

| Actual Invocation   | Legal Encoding   |
|---------------------|------------------|
| <b>op1(a_horse)</b> | 6 2 horse animal |

Note that if the type `horse` is not available to the receiver, then the receiver tries to truncate to `animal`.

c) Regardless of the truncation relationships, when the exact type of the formal argument is sent, then the encoding is as shown below:

| <b>Actual Invocation</b> | <b>Legal Encoding</b> |
|--------------------------|-----------------------|
| <b>op1(an_animal)</b>    | 0                     |
|                          | 2 animal              |
|                          | 6 1 animal            |

2. Given the additional operation:

**op2(in horse h);**

(i.e., the sender knows that both types `horse` and `animal` and their derivation relationship are known to the receiver)

a). If the type `horse` cannot be truncated to `animal` (i.e., `horse` is declared):

**valuetype horse: animal ...**

then the encoding is as shown below:

| <b>Actual Invocation</b> | <b>Legal Encoding</b> |
|--------------------------|-----------------------|
| <b>op2(a_horse)</b>      | 2 horse               |
|                          | 6 1 horse             |

Note that the demarshaling exception of case 1 will not occur, since `horse` is available to the receiver.

b). If the type `horse` can be truncated to `animal` (i.e., `horse` is declared):

**valuetype horse: truncatable animal ...**

then the encoding is as shown below:

| <b>Actual Invocation</b> | <b>Legal Encoding</b> |
|--------------------------|-----------------------|
| <b>op2 (a_horse)</b>     | 2 horse               |
|                          | 6 1 horse             |
|                          | 6 2 horse animal      |

Note that truncation will not occur, since `horse` is available to the receiver.

### 15.3.4.3 *Scope of the Indirections*

The special value **0xffffffff** introduces an indirection (i.e., it directs the decoder to go somewhere else in the marshaling buffer to find what it is looking for). This can be codebase URL information that has already been encoded, a **RepositoryID** that has already been encoded, a list of repository IDs that has already been encoded, or another value object that is shared in a graph. **0xffffffff** is always followed by a **long** indicating where to go in the buffer. A repositoryID or URL, which is the target of an indirection used for encoding a valuetype must have been introduced as the type or codebase information for a valuetype.

It is not permissible for a repositoryID marshalled for some purpose other than as the type information of a valuetype to use indirection to reference a previously marshaled value. The encoding used to indicate an indirection is the same as that used for recursive TypeCodes (i.e., a **0xffffffff** indirection marker followed by a **long** offset (in units of **octets**) from the beginning of the long offset). As an example, this means that an offset of negative four (-4) is illegal, because it is self-indirecting to its indirection marker. Indirections may refer to any preceding location in the GIOP message, including previous fragments if fragmentation is used. This includes any previously marshaled parameters. Non-negative offsets are reserved for future use. Indirections may not cross encapsulation boundaries.

Fragmentation support in GIOP versions 1.1, 1.2, and 1.3 introduces the possibility of a header for a **FragmentMessage** being marshaled between the target of an indirection and the start of the encapsulation containing the indirection. The octets occupied by any such headers are not included in the calculation of the offset value.

### 15.3.4.4 *Null Values*

All value types have a distinguished “null.” All null values are encoded by the `<null_tag>` (0x0). The CDR encoding of null values includes no type information.

### 15.3.4.5 *Other Encoding Information*

A “new” value is coded as a value header followed by the value’s state. The header contains a tag and codebase URL information if appropriate, followed by the **RepositoryID** and an octet flag of bits. Because the same **RepositoryID** (and codebase URL information) could be repeated many times in a single request when sending a complex graph, they are encoded as a regular string the first time they appear, and use an indirection for later occurrences.

### 15.3.4.6 *Fragmentation*

It is anticipated that value types may be rather large, particularly when a graph is being transmitted. Hence the encoding supports the breaking up of the serialization into an arbitrary number of chunks in order to facilitate incremental processing.

Values with truncatable base types need a length indication in case the receiver needs to truncate them to a base type. Value types that are custom marshaled also need a length indication so that the ORB run time can know exactly where they end in the stream without relying on user-defined code. This allows the ORB to maintain consistency and ensure the integrity of the GIOP stream when the user-written custom marshaling and demarshaling does not marshal the entire value state. For simplicity of encoding, we use a length indication for all values whether or not they have a truncatable base type or use custom marshaling.

If limited space is available for marshaling, it may be necessary for the ORB to send the contents of a marshaling buffer containing a partially marshaled value as a GIOP fragment. At that point in the marshaling, the length of the entire value being marshaled may not be known. Calculating this length may require processing as costly as marshaling the entire value. It is therefore desirable to allow the value to be encoded as multiple chunks, each with its own length. This allows the portion of a value that occupies a marshaling buffer to be sent as a chunk of known length with no need for additional length calculation processing.

The data may be split into multiple chunks at arbitrary points except within primitive CDR types, arrays of primitive types, strings, and wstrings, or between the tag and offset of indirections. It is never necessary to end a chunk within one of these types as the length of these types is known before starting to marshal them so they can be added to the length of the currently open chunk. It is the responsibility of the CDR stream to hide the chunking from the marshaling code.

The presence (or absence) of chunking is indicated by flags within the `<value_tag>`. The fourth least significant bit (`<value_tag> & 0x00000008`) is the value 1 if a chunked encoding is used for the value's state. The chunked encoding is required for custom marshaling and truncation. If this bit is 0, the state is encoded as `<octets>`.

Each chunk is preceded by a positive long, which specifies the number of octets in the chunk.

A chunked value is terminated by an end tag that is a non-positive long so the start of the next value can be differentiated from the start of another chunk. In the case of values that contain other values (e.g., a linked list) the "nested" value is started without there being an end tag. The absolute value of an end tag (when it finally appears) indicates the nesting level of the value being terminated. A single end tag can be used to terminate multiple nested values. The detailed rules are as follows:

- End tags, chunk size tags, and value tags are encoded using non-overlapping ranges so that the unmarshaling code can tell after reading each chunk whether:
  - another chunk follows (positive tag).
  - one or multiple value types are ending at a given point in the stream (negative tag).
  - a nested value follows (special large positive tag).
- The end tag is a negative long whose value is the negation of the absolute nesting depth of the value type ending at this point in the CDR stream. Any value types that have not already been ended and whose nesting depth is greater than the depth indicated by the end tag are also implicitly ended. The end tag value **0** is reserved



for future use (e.g., supporting a nesting depth of more than  $2^{31}$ ). The outermost value type will always be terminated by an end tag with a value of **-1**. Enclosing non-chunked valuetypes are not considered when determining the nesting depth.

The following example describes how end tags may be used. Consider a valuetype declaration that contains two member values:

```
// IDL
 valuetype simpleNode{ ... };
 valuetype node truncatable simpleNode {
 public node node1;
 public node node2;
 };
```

When an instance of type **'node'** is passed as a parameter of type **'simpleNode'** a chunked encoding is used. In all cases, the outermost value is terminated with an end tag with a value of **-1**. The nested value **'node1'** is terminated with an end tag with a value of **-2** since only the second-level value **'node1'** ends at that point. Since the nested value **'node2'** coterminates with the outermost value, either of the following end tag layouts is legal:

- A single end tag with a value of **-1** marks the termination of the outermost value, implying the termination of the nested value, **'node2'** as well. This is the most compact marshaling.
- An end tag with a value of **-2** marks the termination of the nested value, **'node2.'** This is then followed by an end tag with a value of **-1** to mark the termination of the outermost value.

Because data members are encoded in their declaration order, declaring a value type data member of a value type last is likely to result in more compact encoding on the wire because it maximizes the number of values ending at the same place and so allows a single end tag to be used for multiple values. The canonical example for that is a linked list.

- For the purposes of chunking, values encoded as indirections or null are treated as non-value data.
- Chunks are never nested. When a value is nested within another value, the outer value's chunk ends at the place in the stream where the inner value starts. If the outer value has non-value data to be marshaled following the inner value, the end tag for the inner value is followed by a continuation chunk for the remainder of the outer value.
- Regardless of the above rules, any value nested within a chunked value is always chunked. Furthermore, any such nested value that is truncatable must encode its type information as a list of **RepositoryIDs** (see Section 15.3.4.1, "Partial Type Information and Versioning," on page 15-16).

Truncating a value type in the receiving context may require keeping track of unused nested values (only during unmarshaling) in case further indirection tags point back to them. These values can be held in their "raw" GIOP form, as fully unmarshaled value objects, or in any other product-specific form.

Value types that are custom marshaled are encoded as chunks in order to let the ORB run-time know exactly where they end in the stream without relying on user-defined code.

#### 15.3.4.7 Notation

The on-the-wire format is described by a BNF grammar with conventions similar to the ones used to define IDL syntax. *The terminals of the grammar are to be interpreted differently.* We are describing a protocol format. Although the terminals have the same names as IDL tokens they represent either:

- constant tags, or
- the GIOP CDR encoding of the corresponding IDL construct.

For example, **long** is a shorthand for the GIOP encoding of the IDL **long** data type - with all the GIOP alignment rules. Similarly **struct** is a shorthand for the GIOP CDR encoding of a **struct**.

A **(type) constant** means that an instance of the given type having the given value is encoded according to the rules for that type. So that **(long) 0** means that a CDR encoding for a long having the value **0** appears at that location.

#### 15.3.4.8 The Format

- |      |                                      |                                                                                                                                                                         |
|------|--------------------------------------|-------------------------------------------------------------------------------------------------------------------------------------------------------------------------|
| (1)  | <code>&lt;value&gt;</code>           | <code>::= &lt;value_tag&gt; [ &lt;codebase_URL&gt; ]</code><br><code>          [ &lt;type_info&gt; ] &lt;state&gt;</code><br><code>            &lt;value_ref&gt;</code> |
| (2)  | <code>&lt;value_ref&gt;</code>       | <code>::= &lt;indirection_tag&gt; &lt;indirection&gt;   &lt;null_tag&gt;</code>                                                                                         |
| (3)  | <code>&lt;value_tag&gt;</code>       | <code>::= long// 0x7fffff00 &lt;= value_tag &lt;= 0x7fffff</code>                                                                                                       |
| (4)  | <code>&lt;type_info&gt;</code>       | <code>::= &lt;rep_ids&gt;   &lt;repository_id&gt;</code>                                                                                                                |
| (5)  | <code>&lt;state&gt;</code>           | <code>::= &lt;octets&gt;   &lt;value_data&gt;* [ &lt;end_tag&gt; ]</code>                                                                                               |
| (6)  | <code>&lt;value_data&gt;</code>      | <code>::= &lt;value_chunk&gt;   &lt;value&gt;</code>                                                                                                                    |
| (7)  | <code>&lt;rep_ids&gt;</code>         | <code>::= long &lt;repository_id&gt;+</code><br><code>        &lt;indirection_tag&gt; &lt;indirection&gt;</code>                                                        |
| (8)  | <code>&lt;repository_id&gt;</code>   | <code>::= string   &lt;indirection_tag&gt; &lt;indirection&gt;</code>                                                                                                   |
| (9)  | <code>&lt;value_chunk&gt;</code>     | <code>::= &lt;chunk_size_tag&gt; &lt;octets&gt;</code>                                                                                                                  |
| (10) | <code>&lt;null_tag&gt;</code>        | <code>::= (long) 0</code>                                                                                                                                               |
| (11) | <code>&lt;indirection_tag&gt;</code> | <code>::= (long) 0xffffffff</code>                                                                                                                                      |
| (12) | <code>&lt;codebase_URL&gt;</code>    | <code>::= string   &lt;indirection_tag&gt; &lt;indirection&gt;</code>                                                                                                   |
| (13) | <code>&lt;chunk_size_tag&gt;</code>  | <code>::= long</code><br><code>      // 0 &lt; chunk_size_tag &lt; 2^31-256 (0x7fffff00)</code>                                                                         |
| (14) | <code>&lt;end_tag&gt;</code>         | <code>::= long    // -2^31 &lt; end_tag &lt; 0</code>                                                                                                                   |
| (15) | <code>&lt;indirection&gt;</code>     | <code>::= long    // -2^31 &lt; indirection &lt; 0</code>                                                                                                               |
| (16) | <code>&lt;octets&gt;</code>          | <code>::= octet   octet &lt;octets&gt;</code>                                                                                                                           |

The concatenated octets of consecutive value chunks within a value encode state members for the value according to the following grammar:

```

(1) <state members> ::= <state_member>
 | <state_member> <state members>
(2) <state_member> ::= <value_ref>
 // All legal IDL types should be here
 |
 | octet
 | boolean
 | char
 | short
 | unsigned short
 | long
 | unsigned long
 | float
 | wchar
 | wstring
 | string
 | struct
 | union
 | sequence
 | array
 | Object
 | any
 | long long
 | unsigned long long
 | double
 | long double
 | fixed

```

### 15.3.5 Pseudo-Object Types

CORBA defines some kinds of entities that are neither primitive types (integral or floating point) nor constructed ones.

#### 15.3.5.1 TypeCode

In general, TypeCodes are encoded as the **TCKind** enum value, potentially followed by values that represent the TypeCode parameters. Unfortunately, **TypeCodes** cannot be expressed simply in OMG IDL, since their definitions are recursive. The basic TypeCode representations are given in Table 15-2 on page 15-25. The *integer value* column of this table gives the **TCKind** enum value corresponding to the given TypeCode, and lists the parameters associated with such a TypeCode. The rest of this section presents the details of the encoding.

##### **Basic TypeCode Encoding Framework**

The encoding of a TypeCode is the **TCKind** enum value (encoded, like all **enum** values, using four octets), followed by zero or more parameter values. The encodings of the parameter lists fall into three general categories, and differ in order to conserve space and to support efficient traversal of the binary representation:

- Typecodes with an *empty parameter list* are encoded simply as the corresponding **TCKind** enum value.
- Typecodes with *simple parameter lists* are encoded as the **TCKind** enum value followed by the parameter value(s), encoded as indicated in Table 15-2. A “simple” parameter list has a fixed number of fixed length entries, or a single parameter that has its length encoded first.
- All other typecodes have *complex parameter lists*, which are encoded as the **TCKind** enum value followed by a CDR encapsulation octet sequence (see Section 15.3.3, “Encapsulation,” on page 15-14) containing the encapsulated, marshaled parameters. The order of these parameters is shown in the fourth column of Table 15-2.

The third column of Table 15-2 shows whether each parameter list is *empty*, *simple*, or *complex*. Also, note that an internal indirection facility is needed to represent some kinds of typecodes; this is explained in “Indirection: Recursive and Repeated TypeCodes” on page 15-28. This indirection does not need to be exposed to application programmers.

### **TypeCode Parameter Notation**

TypeCode parameters are specified in the fourth column of Table 15-2 on page 15-25. The ordering and meaning of parameters is a superset of those given in Section 4.11, “TypeCodes,” on page 4-52; more information is needed by CDR’s representation in order to provide the full semantics of TypeCodes as shown by the API.

- Each parameter is written in the form *type (name)*, where *type* describes the parameter’s type, and *name* describes the parameter’s meaning.
- The encoding of some parameter lists (specifically, **tk\_struct**, **tk\_union**, **tk\_enum**, and **tk\_except**) contain a counted sequence of tuples.

Such counted tuple sequences are written in the form *count {parameters}*, where *count* is the number of tuples in the encoded form, and the *parameters* enclosed in braces are available in each tuple instance. First the *count*, which is an unsigned long, and then each *parameter* in each tuple (using the noted type), is encoded in the CDR representation of the typecode. Each tuple is encoded, first parameter followed by second, before the next tuple is encoded (first, then second, etc.).

Note that the tuples identifying **struct**, **union**, **exception**, and **enum** members must be in the order defined in the OMG IDL definition text. Also, that the types of discriminant values in encoded **tk\_union** TypeCodes are established by the second encoded parameter (*discriminant type*), and cannot be specified except with reference to a specific OMG IDL definition.<sup>3</sup>

---

3. This means that, for example, two OMG IDL unions that are textually equivalent, except that one uses a “char” discriminant, and the other uses a “long” one, would have different size encoded TypeCodes.

Table 15-2 TypeCode enum values, parameter list types, and parameters

| <b>TCKind</b>       | <b>Integer Value</b> | <b>Type</b> | <b>Parameters</b>                                                                                                                                                                                                                |
|---------------------|----------------------|-------------|----------------------------------------------------------------------------------------------------------------------------------------------------------------------------------------------------------------------------------|
| <b>tk_null</b>      | 0                    | empty       | – none –                                                                                                                                                                                                                         |
| <b>tk_void</b>      | 1                    | empty       | – none –                                                                                                                                                                                                                         |
| <b>tk_short</b>     | 2                    | empty       | – none –                                                                                                                                                                                                                         |
| <b>tk_long</b>      | 3                    | empty       | – none –                                                                                                                                                                                                                         |
| <b>tk_ushort</b>    | 4                    | empty       | – none –                                                                                                                                                                                                                         |
| <b>tk_ulong</b>     | 5                    | empty       | – none –                                                                                                                                                                                                                         |
| <b>tk_float</b>     | 6                    | empty       | – none –                                                                                                                                                                                                                         |
| <b>tk_double</b>    | 7                    | empty       | – none –                                                                                                                                                                                                                         |
| <b>tk_boolean</b>   | 8                    | empty       | – none –                                                                                                                                                                                                                         |
| <b>tk_char</b>      | 9                    | empty       | – none –                                                                                                                                                                                                                         |
| <b>tk_octet</b>     | 10                   | empty       | – none –                                                                                                                                                                                                                         |
| <b>tk_any</b>       | 11                   | empty       | – none –                                                                                                                                                                                                                         |
| <b>tk_TypeCode</b>  | 12                   | empty       | – none –                                                                                                                                                                                                                         |
| <b>tk_Principal</b> | 13                   | empty       | – none –                                                                                                                                                                                                                         |
| <b>tk_objref</b>    | 14                   | complex     | string (repository ID), string(name)                                                                                                                                                                                             |
| <b>tk_struct</b>    | 15                   | complex     | string (repository ID),<br>string (name),<br>ulong (count)<br>{string (member name),<br>TypeCode (member type)}                                                                                                                  |
| <b>tk_union</b>     | 16                   | complex     | string (repository ID),<br>string(name),<br>TypeCode (discriminant type),<br>long (default used),<br>ulong (count)<br>{ <i>discriminant type</i> <sup>1</sup> (label value),<br>string (member name),<br>TypeCode (member type)} |
| <b>tk_enum</b>      | 17                   | complex     | string (repository ID),<br>string (name),<br>ulong (count)<br>{string (member name)}                                                                                                                                             |

Table 15-2 TypeCode enum values, parameter list types, and parameters

| <b>TCKind</b>                | <b>Integer Value</b> | <b>Type</b> | <b>Parameters</b>                                                                                                                                                                                                          |
|------------------------------|----------------------|-------------|----------------------------------------------------------------------------------------------------------------------------------------------------------------------------------------------------------------------------|
| <b>tk_string</b>             | 18                   | simple      | ulong (max length <sup>2</sup> )                                                                                                                                                                                           |
| <b>tk_sequence</b>           | 19                   | complex     | TypeCode (element type),<br>ulong (max length <sup>3</sup> )                                                                                                                                                               |
| <b>tk_array</b>              | 20                   | complex     | TypeCode (element type),<br>ulong (length)                                                                                                                                                                                 |
| <b>tk_alias</b>              | 21                   | complex     | string (repository ID),<br>string (name),<br>TypeCode                                                                                                                                                                      |
| <b>tk_except</b>             | 22                   | complex     | string (repository ID),<br>string (name),<br>ulong (count)<br>{string (member name),<br>TypeCode (member type)}                                                                                                            |
| <b>tk_longlong</b>           | 23                   | empty       | – none –                                                                                                                                                                                                                   |
| <b>tk_ulonglong</b>          | 24                   | empty       | – none –                                                                                                                                                                                                                   |
| <b>tk_longdouble</b>         | 25                   | empty       | – none –                                                                                                                                                                                                                   |
| <b>tk_wchar</b>              | 26                   | empty       | – none –                                                                                                                                                                                                                   |
| <b>tk_wstring</b>            | 27                   | simple      | ulong(max length or zero if<br>unbounded)                                                                                                                                                                                  |
| <b>tk_fixed</b>              | 28                   | simple      | ushort(digits), short(scale)                                                                                                                                                                                               |
| <b>tk_value</b>              | 29                   | complex     | string (repository ID),<br>string (name, may be empty),<br>short(ValueModifier),<br>TypeCode(of concrete base) <sup>4</sup> ,<br>ulong (count),<br>{string (member name),<br>TypeCode (member type),<br>short(Visibility)} |
| <b>tk_value_box</b>          | 30                   | complex     | string (repository ID),<br>string(name),<br>TypeCode                                                                                                                                                                       |
| <b>tk_native</b>             | 31                   | complex     | string (repository ID), string(name)                                                                                                                                                                                       |
| <b>tk_abstract_interface</b> | 32                   | complex     | string(RepositoryId), string(name)                                                                                                                                                                                         |
| <b>tk_local_interface</b>    | 33                   | complex     | string(RepositoryId), string(name)                                                                                                                                                                                         |

Table 15-2 TypeCode enum values, parameter list types, and parameters

| <b>TCKind</b>       | <b>Integer Value</b> | <b>Type</b> | <b>Parameters</b>                                                                                                                                                                                                          |
|---------------------|----------------------|-------------|----------------------------------------------------------------------------------------------------------------------------------------------------------------------------------------------------------------------------|
| <b>tk_component</b> | 34                   | complex     | string (repository ID), string(name)                                                                                                                                                                                       |
| <b>tk_home</b>      | 35                   | complex     | string (repository ID), string(name)                                                                                                                                                                                       |
| <b>tk_event</b>     | 36                   | complex     | string (repository ID),<br>string (name, may be empty),<br>short(ValueModifier),<br>TypeCode(of concrete base) <sup>5</sup> ,<br>ulong (count),<br>{string (member name),<br>TypeCode (member type),<br>short(Visibility)} |
| <b>– none –</b>     | 0xffffffff           | simple      | long (indirection <sup>6</sup> )                                                                                                                                                                                           |

1. The type of union label values is determined by the second parameter, discriminant type.
2. For unbounded strings, this value is zero.
3. For unbounded sequences, this value is zero.
4. Should be **tk\_null** if there is no concrete base.
5. Should be **tk\_null** if there is no concrete base.
6. See “Indirection: Recursive and Repeated TypeCodes” on page 15-28.

### *Encoded Identifiers and Names*

The Repository ID parameters in **tk\_objref**, **tk\_struct**, **tk\_union**, **tk\_enum**, **tk\_alias**, **tk\_except**, **tk\_native**, **tk\_value**, **tk\_value\_box** and **tk\_abstract\_interface** TypeCodes are Interface Repository **RepositoryId** values, whose format is described in the specification of the Interface Repository.

For GIOP 1.2 onwards, repositoryID values are required to be sent, if known by the ORB<sup>4</sup>. For GIOP 1.2 and 1.3 an empty repositoryID string is only allowed if a repositoryID value is not available to the ORB sending the type code.

For GIOP 1.0 and 1.1, **RepositoryId** values are required for **tk\_objref** and **tk\_except** TypeCodes; for **tk\_struct**, **tk\_union**, **tk\_enum**, and **tk\_alias** TypeCodes **RepositoryIds** are optional and encoded as empty strings if omitted.

- 
4. A type code passed via a GIOP 1.2 connection shall contain non-empty repositoryID strings, unless a repositoryID value is not available to the sending ORB for a specific type code. This situation can arise, for example, if an ORB receives a type code containing empty repository IDs via a GIOP 1.0 or 1.1 connection and passes that type code on via a GIOP 1.2 connection).

The name parameters in **tk\_objref**, **tk\_struct**, **tk\_union**, **tk\_enum**, **tk\_alias**, **tk\_value**, **tk\_value\_box**, **tk\_abstract\_interface**, **tk\_native** and **tk\_except** TypeCodes and the member name parameters in **tk\_struct**, **tk\_union**, **tk\_enum**, **tk\_value** and **tk\_except** TypeCodes are not specified by (or significant in) GIOP. Agents should not make assumptions about type equivalence based on these name values; only the structural information (including **RepositoryId** values, if provided) is significant. If provided, the strings should be the simple, unscoped names supplied in the OMG IDL definition text. If omitted, they are encoded as empty strings.

When a reference to a base **Object** is encoded, there are two allowed encodings for the Repository ID: either "IDL:omg.org/CORBA/Object:1.0" or "" may be used.

### *Encoding the tk\_union Default Case*

In **tk\_union** TypeCodes, the **long** default used value is used to indicate which tuple in the sequence describes the union's default case. If this value is less than zero, then the union contains no default case. Otherwise, the value contains the zero-based index of the default case in the sequence of tuples describing union members.

The discriminant value used in the actual typecode parameter associated with the default member position in the list, may be any valid value of the discriminant type, and has no semantic significance (i.e., it should be ignored and is only included for syntactic completeness of union type code marshaling).

### *TypeCodes for Multi-Dimensional Arrays*

The **tk\_array** TypeCode only describes a single dimension of any array. TypeCodes for multi-dimensional arrays are constructed by nesting **tk\_array** TypeCodes within other **tk\_array** TypeCodes, one per array dimension. The outermost (or top-level) **tk\_array** TypeCode describes the leftmost array index of the array as defined in IDL; the innermost nested **tk\_array** TypeCode describes the rightmost index.

### *Indirection: Recursive and Repeated TypeCodes*

The typecode representation of OMG IDL data types that can indirectly contain instances of themselves (e.g., **struct foo {sequence <foo> bar;}**) must also contain an indirection. Such an indirection is also useful to reduce the size of encodings; for example, unions with many cases sharing the same value.

CDR provides a constrained indirection to resolve this problem:

- The indirection applies only to TypeCodes nested within some "top-level" TypeCode. Indirected TypeCodes are not "freestanding," but only exist inside some other encoded TypeCode.
- Only the second (and subsequent) references to a TypeCode in that scope may use the indirection facility. The first reference to that TypeCode must be encoded using the normal rules. In the case of a recursive TypeCode, this means that the first instance will not have been fully encoded before a second one must be completely encoded.



The indirection is a numeric octet offset within the scope of the “top-level” TypeCode and points to the **TCKind** value for the typecode. (Note that the byte order of the **TCKind** value can be determined by its encoded value.) This indirection may well cross encapsulation boundaries, but this is not problematic because of the first constraint identified above. Because of the second constraint, the value of the offset will always be negative.

Fragmentation support in GIOP versions 1.1, 1.2, and 1.3 introduces the possibility of a header for a **FragmentMessage** being marshaled between the target of an indirection and the start of the encapsulation containing the indirection. The octets occupied by any such headers are not included in the calculation of the offset value.

The encoding of such an indirection is as a TypeCode with a “**TCKind** value” that has the special value  $2^{32}-1$  (**0xffffffff**, all ones). Such typecodes have a single (simple) parameter, which is the **long** offset (in units of octets) from the simple parameter. (This means that an offset of negative four (-4) is illegal because it will be self-indirecting.)

#### 15.3.5.2 *Any*

**Any** values are encoded as a TypeCode (encoded as described above) followed by the encoded value. For **Any** values containing a **tk\_null** or **tk\_void TypeCode**, the encoded value shall have zero length (i.e., shall be absent).

#### 15.3.5.3 *Principal*

**Principal** pseudo objects are encoded as **sequence<octet>**. In the absence of a Security service specification, **Principal** values have no standard format or interpretation, beyond serving to identify callers (and potential callers). This specification does not prescribe any usage of **Principal** values.

By representing **Principal** values as **sequence<octet>**, GIOP guarantees that ORBs may use domain-specific principal identification schemes; such values undergo no translation or interpretation during transmission. This allows bridges to translate or interpret these identifiers as needed when forwarding requests between different security domains.

#### 15.3.5.4 *Context*

**Context** pseudo objects are encoded as **sequence<string>**. The strings occur in pairs. The first string in each pair is the context property name, and the second string in each pair is the associated value. If an operation has an IDL context clause but the client does not supply any properties matching the context clause at run time, an empty sequence is marshaled.

### 15.3.5.5 Exception

Exceptions are encoded as a string followed by exception members, if any. The string contains the RepositoryId for the exception, as defined in the Interface Repository chapter. Exception members (if any) are encoded in the same manner as a struct.

If an ORB receives a non-standard system exception that it does not support, or a user exception that is not defined as part of the operation's definition, the exception shall be mapped to **UNKNOWN**, with standard minor code set to 2 for a system exception, or set to 1 for a user exception.

### 15.3.6 Object References

Object references are encoded in OMG IDL (as described in Section 13.5, "Object Addressing," on page 13-11). IOR profiles contain transport-specific addressing information, so there is no general-purpose IOR profile format defined for GIOP. Instead, this specification describes the general information model for GIOP profiles and provides a specific format for the IIOP (see "IIOP IOR Profiles" on page 15-52).

In general, GIOP profiles include at least these three elements:

1. The version number of the transport-specific protocol specification that the server supports.
2. The address of an endpoint for the transport protocol being used.
3. An opaque datum (an **object\_key**, in the form of an octet sequence) used exclusively by the agent at the specified endpoint address to identify the object.

### 15.3.7 Abstract Interfaces

Abstract interfaces are encoded as a union with a **boolean** discriminator. The **union** has an *object reference* (see Section 15.3.6, "Object References," on page 15-30) if the discriminator is **TRUE**, and a *value type* (see Section 15.3.4, "Value Types," on page 15-15) if the discriminator is **FALSE**. The encoding of value types marshaled as abstract interfaces always includes **RepositoryId** information. If there is no indication whether a nil abstract interface represents a nil object reference or a null valuetype, it shall be encoded as a null valuetype.

## 15.4 GIOP Message Formats

GIOP has restriction on client and server roles with respect to initiating and receiving messages. For the purpose of GIOP versions 1.0 and 1.1, a client is the agent that opens a connection (see more details in Section 15.5.1, "Connection Management," on page 15-47) and originates requests. Likewise, for GIOP versions 1.0 and 1.1, a server is an agent that accepts connections and receives requests. When Bidirectional GIOP is in use for GIOP protocol version 1.2 and 1.3, either side may originate messages, as specified in Section 15.8, "Bi-Directional GIOP," on page 15-56.

GIOP message types are summarized in Table 15-3, which lists the message type names, whether the message is originated by client, server, or both, and the value used to identify the message type in GIOP message headers.

Table 15-3 GIOP Message Types and Originators

| Message Type    | Originator | Value | GIOP Versions                                             |
|-----------------|------------|-------|-----------------------------------------------------------|
| Request         | Client     | 0     | 1.0, 1.1, 1.2, 1.3                                        |
| Request         | Both       | 0     | 1.2 with BiDir GIOP in use,<br>1.3 with BiDir GIOP in use |
| Reply           | Server     | 1     | 1.0, 1.1, 1.2, 1.3                                        |
| Reply           | Both       | 1     | 1.2 with BiDir GIOP in use,<br>1.3 with BiDir GIOP in use |
| CancelRequest   | Client     | 2     | 1.0, 1.1, 1.2, 1.3                                        |
| CancelRequest   | Both       | 2     | 1.2 with BiDir GIOP in use,<br>1.3 with BiDir GIOP in use |
| LocateRequest   | Client     | 3     | 1.0, 1.1, 1.2, 1.3                                        |
| LocateRequest   | Both       | 3     | 1.2 with BiDir GIOP in use,<br>1.3 with BiDir GIOP in use |
| LocateReply     | Server     | 4     | 1.0, 1.1, 1.2, 1.3                                        |
| LocateReply     | Both       | 4     | 1.2 with BiDir GIOP in use,<br>1.3 with BiDir GIOP in use |
| CloseConnection | Server     | 5     | 1.0, 1.1, 1.2, 1.3                                        |
| CloseConnection | Both       | 5     | 1.2, 1.3                                                  |
| MessageError    | Both       | 6     | 1.0, 1.1, 1.2, 1.3                                        |
| Fragment        | Both       | 7     | 1.1, 1.2, 1.3                                             |

### 15.4.1 GIOP Message Header

All GIOP messages begin with the following header, defined in OMG IDL:

```

module GIOP { // IDL extended for version 1.1, 1.2, and 1.3
 struct Version {
 octet major;
 octet minor;
 };

 #ifndef GIOP_1_1
 // GIOP 1.0
 enum MsgType_1_0 { // Renamed from MsgType

```

```

 Request, Reply, CancelRequest,
 LocateRequest, LocateReply,
 CloseConnection, MessageError
 };

#else
 // GIOP 1.1
 enum MsgType_1_1 {
 Request, Reply, CancelRequest,
 LocateRequest, LocateReply,
 CloseConnection, MessageError,
 Fragment // GIOP 1.1 addition
 };
#endif // GIOP_1_1

// GIOP 1.0
struct MessageHeader_1_0 { // Renamed from MessageHeader
 char magic [4];
 Version GIOP_version;
 boolean byte_order;
 octet message_type;
 unsigned long message_size;
};

// GIOP 1.1
struct MessageHeader_1_1 {
 char magic [4];
 Version GIOP_version;
 octet flags; // GIOP 1.1 change
 octet message_type;
 unsigned long message_size;
};

// GIOP 1.2, 1.3
typedef MessageHeader_1_1 MessageHeader_1_2;
typedef MessageHeader_1_1 MessageHeader_1_3;
};

```

The message header clearly identifies GIOP messages and their byte-ordering. The header is independent of byte ordering except for the field encoding message size.

- **magic** identifies GIOP messages. The value of this member is always the four (upper case) characters “GIOP,” encoded in ISO Latin-1 (8859.1).
- **GIOP\_version** contains the version number of the GIOP protocol being used in the message. The version number applies to the transport-independent elements of this specification (i.e., the CDR and message formats) that constitute the GIOP. This is not equivalent to the IIOP version number (as described in Section 15.3.6, “Object References,” on page 15-30) though it has the same structure. The major GIOP version number of this specification is one (1); the minor versions are zero (0), one (1), and two (2).

A server implementation supporting a minor GIOP protocol version 1.n (with  $n > 0$  and  $n < 3$ ), must also be able to process GIOP messages having minor protocol version 1.m, with m less than n. A GIOP server, which receives a request having a greater minor version number than it supports, should respond with an error message having the highest minor version number that that server supports, and then close the connection.

A client should not send a GIOP message having a higher minor version number than that published by the server in the tag Internet IOP Profile body of an IOR.

- **byte\_order** (in GIOP 1.0 only) indicates the byte ordering used in subsequent elements of the message (including **message\_size**). A value of **FALSE** (0) indicates big-endian byte ordering, and **TRUE** (1) indicates little-endian byte ordering.
- **flags** (in GIOP 1.1, 1.2, and 1.3) is an 8-bit octet. The least significant bit indicates the byte ordering used in subsequent elements of the message (including **message\_size**). A value of **FALSE** (0) indicates big-endian byte ordering, and **TRUE** (1) indicates little-endian byte ordering. The byte order for fragment messages must match the byte order of the initial message that the fragment extends.

The second least significant bit indicates whether or not more fragments follow. A value of **FALSE** (0) indicates this message is the last fragment, and **TRUE** (1) indicates more fragments follow this message.

The most significant 6 bits are reserved. These 6 bits must have value 0 for GIOP version 1.1, 1.2, and 1.3.

- **message\_type** indicates the type of the message, according to Table 15-3; these correspond to enum values of type **MsgType**.
- **message\_size** contains the number of octets in the message following the message header, encoded using the byte order specified in the byte order bit (the least significant bit) in the **flags** field (or using the **byte\_order** field in GIOP 1.0). It refers to the size of the message body, not including the 12-byte message header. This count includes any alignment gaps and must match the size of the actual request parameters (plus any final padding bytes that may follow the parameters to have a fragment message terminate on an 8-byte boundary).

A MARSHAL exception with minor code 7 indicates that fewer bytes were present in a message than indicated by the count. (This condition can arise if the sender sends a message in fragments, and the receiver detects that the final fragment was received but contained insufficient data for all parameters to be unmarshaled.)

A MARSHAL exception with minor code 8 indicates that more bytes were present in a message than indicated by the count. Depending on the ORB implementation, this condition may be reported for the current message or the next message that is processed (when the receiver detects that the previous message is not immediately followed by the GIOP magic number).

The use of a message size of 0 with a **Request**, **LocateRequest**, **Reply**, or **LocateReply** message is reserved for future use.

For GIOP version 1.2, and 1.3, if the second least significant bit of **Flags** is 1, the sum of the **message\_size** value and 12 must be evenly divisible by 8.

Messages with different GIOP minor versions may be mixed on the same underlying transport connection.

## 15.4.2 Request Message

Request messages encode CORBA object invocations, including attribute accessor operations, and **CORBA::Object** operations **get\_interface** and **get\_implementation**. Requests flow from client to server.

*Request* messages have three elements, encoded in this order:

- A GIOP message header
- A Request Header
- The Request Body

### 15.4.2.1 Request Header

The request header is specified as follows:

```

module GIOP {// IDL extended for version 1.1, 1.2, and 1.3

 // GIOP 1.0
 struct RequestHeader_1_0 {// Renamed from RequestHeader
 IOP::ServiceContextList service_context;
 unsigned long request_id;
 boolean response_expected;
 sequence <octet> object_key;
 string operation;
 CORBA::OctetSeq requesting_principal;
 };

 // GIOP 1.1
 struct RequestHeader_1_1 {
 IOP::ServiceContextList service_context;
 unsigned long request_id;
 boolean response_expected;
 octet reserved[3]; // Added in GIOP 1.1
 sequence <octet> object_key;
 string operation;
 CORBA::OctetSeq requesting_principal;
 };

 // GIOP 1.2, 1.3

```

```

typedef short AddressingDisposition;
const short KeyAddr = 0;
const short ProfileAddr = 1;
const short ReferenceAddr = 2;

struct IORAddressingInfo {
 unsigned long selected_profile_index;
 IOP::IOR ior;
};

union TargetAddress switch (AddressingDisposition) {
 case KeyAddr: sequence <octet> object_key;
 case ProfileAddr: IOP::TaggedProfile profile;
 case ReferenceAddr: IORAddressingInfo ior;
};

struct RequestHeader_1_2 {
 unsigned long request_id;
 octet response_flags;
 octet reserved[3];
 TargetAddress target;
 string operation;
 IOP::ServiceContextList service_context;
 // requesting_principal not in GIOP 1.2 and 1.3
};
typedef RequestHeader_1_2 RequestHeader_1_3;
};

```

The members have the following definitions:

- **request\_id** is used to associate reply messages with request messages (including **LocateRequest** messages). The client (requester) is responsible for generating values so that ambiguity is eliminated; specifically, a client must not re-use **request\_id** values during a connection if: (a) the previous request containing that ID is still pending, or (b) if the previous request containing that ID was canceled and no reply was received. (See the semantics of the Section 15.4.4, “CancelRequest Message,” on page 15-41).
  - **response\_flags** is set to 0x0 for a **SyncScope** of **NONE** and **WITH\_TRANSPORT**. The flag is set to 0x1 for a **SyncScope** of **WITH\_SERVER**. A non-exception reply to a request message containing a **response\_flags** value of 0x1 should contain an empty body, i.e. the equivalent of a void operation with no out/inout parameters. The flag is set to 0x3 for a **SyncScope** of **WITH\_TARGET**. These values ensure interworking compatibility between this and previous versions of **GIOP**.
- For GIOP 1.0 and 1.1 a **response\_expected** value of **TRUE** is treated like a **response\_flags** value of \x03, and a **response\_expected** value of **FALSE** is treated like a **response\_flags** value of \x00.
- **reserved** is always set to **0** in GIOP 1.1. These three octets are reserved for future use.

- For GIOP 1.0 and 1.1, **object\_key** identifies the object that is the target of the invocation. It is the **object\_key** field from the transport-specific GIOP profile (e.g., from the encapsulated IIOP profile of the IOR for the target object). This value is only meaningful to the server and is not interpreted or modified by the client.
- For GIOP 1.2, 1.3, **target** identifies the object that is the target of the invocation. The possible values of the union are:
  - **KeyAddr** is the **object\_key** field from the transport-specific GIOP profile (e.g., from the encapsulated IIOP profile of the IOR for the target object). This value is only meaningful to the server and is not interpreted or modified by the client.
  - **ProfileAddr** is the transport-specific GIOP profile selected for the target's IOR by the client ORB.
  - **IORAddressingInfo** is the full IOR of the target object. The **selected\_profile\_index** indicates the transport-specific GIOP profile that was selected by the client ORB. The first profile has an index of zero.
- **operation** is the IDL identifier naming, within the context of the interface (not a fully qualified scoped name), the operation being invoked. In the case of attribute accessors, the names are **\_get\_<attribute>** and **\_set\_<attribute>**. The case of the operation or attribute name must match the case of the operation name specified in the OMG IDL source for the interface being used.

In the case of **CORBA::Object** operations that are defined in the CORBA Core (Section 4.3, "Object Reference Operations," on page 4-12) and that correspond to GIOP request messages, the operation names are **\_interface**, **\_is\_a**, **\_non\_existent**, **\_domain\_managers**, and **\_component**.

---

**Note** – The name **\_get\_domain\_managers** is not used, to avoid conflict with a get operation invoked on a user defined attribute with name **domain\_managers**.

---

For GIOP 1.2 and later versions, only the operation name **\_non\_existent** shall be used.

The correct operation name to use for GIOP 1.0 and 1.1 is **\_non\_existent**. Due to a typographical error in CORBA 2.0, 2.1, and 2.2, some legacy implementations of GIOP 1.0 and 1.1 respond to the operation name **\_not\_existent**. For maximum interoperability with such legacy implementations, new implementations of GIOP 1.0 and 1.1 may wish to respond to both operation names, **\_non\_existent** and **\_not\_existent**.

- **service\_context** contains ORB service data being passed from the client to the server, encoded as described in Section 13.7, "Service Context," on page 13-28.
- **requesting\_principal** contains a value identifying the requesting principal. It is provided to support the **BOA::get\_principal** operation. The usage of the **requesting\_principal** field is deprecated for GIOP versions 1.0 and 1.1. The field is not present in the request header for GIOP version 1.2, 1.3.

There is no padding after the request header when an unfragmented request message body is empty.



### 15.4.2.2 Request Body

In GIOP versions 1.0 and 1.1, request bodies are marshaled into the CDR encapsulation of the containing Message immediately following the Request Header. In GIOP version 1.2 and 1.3, the Request Body is always aligned on an 8-octet boundary. The fact that GIOP specifies the maximum alignment for any primitive type is 8 guarantees that the Request Body will not require remarshaling if the Message or Request header are modified. The data for the request body includes the following items encoded in this order:

- All **in** and **inout** parameters, in the order in which they are specified in the operation's OMG IDL definition, from left to right.
- An optional **Context** pseudo object, encoded as described in Section 15.3.5.4, "Context," on page 15-29. This item is only included if the operation's OMG IDL definition includes a context expression, and only includes context members as defined in that expression.

For example, the request body for the following OMG IDL operation

**double example (in short m, out string str, inout long p);**

would be equivalent to this structure:

```
struct example_body {
 short m; // leftmost in or inout parameter
 long p; // ... to the rightmost
};
```

### 15.4.3 Reply Message

**Reply** messages are sent in response to **Request** messages if and only if the response expected flag in the request is set to **TRUE**. Replies include inout and out parameters, operation results, and may include exception values. In addition, Reply messages may provide object location information. In GIOP versions 1.0 and 1.1, replies flow only from server to client.

*Reply* messages have three elements, encoded in this order:

- A GIOP message header
- A *ReplyHeader structure*
- The reply body

#### 15.4.3.1 Reply Header

The reply header is defined as follows:

```
module GIOP { // IDL extended for 1.2 and 1.3
#ifndef GIOP_1_2
```

```

// GIOP 1.0 and 1.1
enum ReplyStatusType_1_0 { // Renamed from ReplyStatusType
 NO_EXCEPTION,
 USER_EXCEPTION,
 SYSTEM_EXCEPTION,
 LOCATION_FORWARD
};

// GIOP 1.0
struct ReplyHeader_1_0 { // Renamed from ReplyHeader
 IOP::ServiceContextList service_context;
 unsigned long request_id;
 ReplyStatusType_1_0 reply_status;
};

// GIOP 1.1
typedef ReplyHeader_1_0 ReplyHeader_1_1;
// Same Header contents for 1.0 and 1.1

#else
// GIOP 1.2, 1.3
enum ReplyStatusType_1_2 {
 NO_EXCEPTION,
 USER_EXCEPTION,
 SYSTEM_EXCEPTION,
 LOCATION_FORWARD,
 LOCATION_FORWARD_PERM, // new value for 1.2
 NEEDS_ADDRESSING_MODE // new value for 1.2
};

struct ReplyHeader_1_2 {
 unsigned long request_id;
 ReplyStatusType_1_2 reply_status;
 IOP::ServiceContextList service_context;
};
typedef ReplyHeader_1_2 ReplyHeader_1_3;
#endif // GIOP_1_2
};

```

The members have the following definitions:

- **request\_id** is used to associate replies with requests. It contains the same **request\_id** value as the corresponding request.
- **reply\_status** indicates the completion status of the associated request, and also determines part of the reply body contents. If no exception occurred and the operation completed successfully, the value is **NO\_EXCEPTION** and the body contains return values. Otherwise the body
  - contains an exception, or
  - directs the client to reissue the request to an object at some other location, or
  - directs the client to supply more addressing information.

- **service\_context** contains ORB service data being passed from the server to the client, encoded as described in Section 15.2.3, “GIOP Message Transfer,” on page 15-4.

There is no padding after the reply header when an unfragmented reply message body is empty.

### 15.4.3.2 Reply Body

In GIOP version 1.0 and 1.1, reply bodies are marshaled into the CDR encapsulation of the containing Message immediately following the Reply Header. In GIOP version 1.2 and 1.3, the Reply Body is always aligned on an 8-octet boundary. The fact that GIOP specifies the maximum alignment for any primitive type is 8 guarantees that the ReplyBody will not require remarshaling if the Message or the Reply Header are modified. The data for the reply body is determined by the value of **reply\_status**. There are the following types of reply body:

- If the **reply\_status** value is **NO\_EXCEPTION**, the body is encoded as if it were a structure holding first any operation return value, then any **inout** and **out** parameters in the order in which they appear in the operation’s OMG IDL definition, from left to right. (That structure could be empty.)
- If the **reply\_status** value is **USER\_EXCEPTION** or **SYSTEM\_EXCEPTION**, then the body contains the exception that was raised by the operation, encoded as described in Section 15.3.5.5, “Exception,” on page 15-30. (Only the user-defined exceptions listed in the operation’s OMG IDL definition may be raised.)

When a GIOP Reply message contains a **reply\_status** value of **SYSTEM\_EXCEPTION**, the body of the Reply message conforms to the following structure:

```

module GIOP { // IDL
 struct SystemExceptionReplyBody {
 string exception_id;
 unsigned long minor_code_value;
 unsigned long completion_status;
 };
};

```

The high-order 20 bits of **minor\_code\_value** contain a 20-bit “Vendor Minor Codeset ID” (**VMCID**); the low-order 12 bits contain a minor code. A vendor (or group of vendors) wishing to define a specific set of system exception minor codes should obtain a unique **VMCID** from the OMG, and then use those 4096 minor codes as they see fit; for example, defining up to 4096 minor codes for each system exception. Any vendor may use the special **VMCID** of zero (0) without previous reservation, but minor code assignments in this codeset may conflict with other vendor’s assignments, and use of the zero **VMCID** is officially deprecated.

---

**Note** – OMG standard minor codes are identified with the 20 bit **VMCID \x4f4d0**. This appears as the characters ‘O’ followed by the character ‘M’ on the wire, which is defined as a 32-bit constant called **OMGVMCID \x4f4d0000** (see Section 4.12.4, “Standard Minor Exception Codes,” on page 4-72) so that allocated minor code numbers can be or-ed with it to obtain the **minor\_code\_value**.

---

- If the **reply\_status** value is **LOCATION\_FORWARD**, then the body contains an object reference (IOR) encoded as described in Section 15.3.6, “Object References,” on page 15-30. The client ORB is responsible for re-sending the original request to that (different) object. This resending is transparent to the client program making the request.
- The usage of the **reply\_status** value **LOCATION\_FORWARD\_PERM** behaves like the usage of **LOCATION\_FORWARD**, but when used by a server it also provides an indication to the client that it may replace the old IOR with the new IOR. Both the old IOR and the new IOR are valid, but the new IOR is preferred for future use.
- If the **reply\_status** value is **NEEDS\_ADDRESSING\_MODE** then the body contains a **GIOP::AddressingDisposition**. The client ORB is responsible for re-sending the original request using the requested addressing mode. The resending is transparent to the client program making the request.

---

**Note** – Usage of **LOCATATION\_FORWARD\_PERM** is now deprecated, due to problems it causes with the semantics of the **Object::hash()** operation. **LOCATATION\_FORWARD\_PERM** features could be removed from some future GIOP versions if solutions to these problems are not provided.

---

For example, the reply body for a successful response (the value of **reply\_status** is **NO\_EXCEPTION**) to the *Request* example shown on page 15-37 would be equivalent to the following structure:

```

struct example_reply {
 double return_value; // return value
 string str;
 long p; // ... to the rightmost
};

```

Note that the **object\_key** field in any specific GIOP profile is server-relative, not absolute. Specifically, when a new object reference is received in a **LOCATION\_FORWARD Reply** or in a **LocateReply** message, the **object\_key** field embedded in the new object reference’s GIOP profile may not have the same value as the **object\_key** in the GIOP profile of the original object reference. For details on location forwarding, see Section 15.6, “Object Location,” on page 15-49.

### 15.4.4 *CancelRequest Message*

**CancelRequest** messages may be sent, in GIOP versions 1.0 and 1.1, only from clients to servers. **CancelRequest** messages notify a server that the client is no longer expecting a reply for a specified pending **Request** or **LocateRequest** message.

**CancelRequest** messages have two elements, encoded in this order:

- A GIOP message header
- A **CancelRequestHeader**

#### 15.4.4.1 *Cancel Request Header*

The cancel request header is defined as follows:

```
module GIOP { // IDL
 struct CancelRequestHeader {
 unsigned long request_id;
 };
};
```

The **request\_id** member identifies the **Request** or **LocateRequest** message to which the cancel applies. This value is the same as the **request\_id** value specified in the original **Request** or **LocateRequest** message.

When a client issues a cancel request message, it serves in an advisory capacity only. The server is not required to acknowledge the cancellation, and may subsequently send the corresponding reply. The client should have no expectation about whether a reply (including an exceptional one) arrives.

### 15.4.5 *LocateRequest Message*

**LocateRequest** messages may be sent from a client to a server to determine the following regarding a specified object reference:

- whether the current server is capable of directly receiving requests for the object reference, and if not,
- to what address requests for the object reference should be sent.

Note that this information is also provided through the **Request** message, but that some clients might prefer not to support retransmission of potentially large messages that might be implied by a **LOCATION\_FORWARD** status in a **Reply** message. That is, client use of this represents a potential optimization.

**LocateRequest** messages have two elements, encoded in this order:

- A GIOP message header
- A **LocateRequestHeader**

### 15.4.5.1 *LocateRequest Header.*

The **LocateRequest** header is defined as follows:

```

module GIOP { // IDL extended for version 1.2 and 1.3

// GIOP 1.0
 struct LocateRequestHeader_1_0 {
 // Renamed LocationRequestHeader
 unsigned long request_id;
 sequence <octet> object_key;
 };

// GIOP 1.1
 typedef LocateRequestHeader_1_0 LocateRequestHeader_1_1;
 // Same Header contents for 1.0 and 1.1

// GIOP 1.2, 1.3
 struct LocateRequestHeader_1_2 {
 unsigned long request_id;
 TargetAddress target;
 };
 typedef LocateRequestHeader_1_2 LocateRequestHeader_1_3;
};

```

The members are defined as follows:

- **request\_id** is used to associate **LocateReply** messages with **LocateRequest** ones. The client (requester) is responsible for generating values; see Section 15.4.2, “Request Message,” on page 15-34 for the applicable rules.
- For GIOP 1.0 and 1.1, **object\_key** identifies the object being located. In an IIOP context, this value is obtained from the **object\_key** field from the encapsulated **IIOP::ProfileBody** in the IIOP profile of the IOR for the target object. When GIOP is mapped to other transports, their IOR profiles must also contain an appropriate corresponding value. This value is only meaningful to the server and is not interpreted or modified by the client.
- For GIOP 1.2, 1.3, target identifies the object being located. The possible values of this union are:
  - **KeyAddr** is the **object\_key** field from the transport-specific GIOP profile (e.g., from the encapsulated IIOP profile of the IOR for the target object). This value is only meaningful to the server and is not interpreted or modified by the client.
  - **ProfileAddr** is the transport-specific GIOP profile selected for the target’s IOR by the client ORB.
  - **IORAddressingInfo** is the full IOR of the target object. The **selected\_profile\_index** indicates the transport-specific GIOP profile that was selected by the client ORB.

See Section 15.6, “Object Location,” on page 15-49 for details on the use of **LocateRequest**.

## 15.4.6 LocateReply Message

**LocateReply** messages are sent from servers to clients in response to **LocateRequest** messages. In GIOP versions 1.0 and 1.1 the **LocateReply** message is only sent from the server to the client.

A **LocateReply** message has three elements, encoded in this order:

1. A GIOP message header
2. A **LocateReplyHeader**
3. The locate reply body

### 15.4.6.1 Locate Reply Header

The locate reply header is defined as follows:

```

module GIOP { // IDL extended for GIOP 1.2 and 1.3
#ifdef GIOP_1_2
 // GIOP 1.0 and 1.1
 enum LocateStatusType_1_0 { // Renamed from LocateStatusType
 UNKNOWN_OBJECT,
 OBJECT_HERE,
 OBJECT_FORWARD
 };

 // GIOP 1.0
 struct LocateReplyHeader_1_0 { // Renamed from LocateReplyHeader
 unsigned long request_id;
 LocateStatusType_1_0 locate_status;
 };

 // GIOP 1.1
 typedef LocateReplyHeader_1_0 LocateReplyHeader_1_1;
 // same Header contents for 1.0 and 1.1

#else
 // GIOP 1.2, 1.3
 enum LocateStatusType_1_2 {
 UNKNOWN_OBJECT,
 OBJECT_HERE,
 OBJECT_FORWARD,
 OBJECT_FORWARD_PERM, // new value for GIOP 1.2
 LOC_SYSTEM_EXCEPTION, // new value for GIOP 1.2
 LOC_NEEDS_ADDRESSING_MODE // new value for GIOP 1.2
 };

 struct LocateReplyHeader_1_2 {
 unsigned long request_id;
 LocateStatusType_1_2 locate_status;
 };

```

```

};
typedef LocateReplyHeader_1_2 LocateReplyHeader_1_3;
#endif // GIOP_1_2
};

```

The members have the following definitions:

- **request\_id** - is used to associate replies with requests. This member contains the same **request\_id** value as the corresponding **LocateRequest** message.
- **locate\_status** - the value of this member is used to determine whether a **LocateReply** body exists. Values are:
  - **UNKNOWN\_OBJECT** - the object specified in the corresponding **LocateRequest** message is unknown to the server; no body exists.
  - **OBJECT\_HERE** - this server (the originator of the **LocateReply** message) can directly receive requests for the specified object; no body exists.
  - **OBJECT\_FORWARD** and **OBJECT\_FORWARD\_PERM** - a **LocateReply** body exists.
  - **LOC\_SYSTEM\_EXCEPTION** - a **LocateReply** body exists.
  - **LOC\_NEEDS\_ADDRESSING\_MODE** - a **LocateReply** body exists.

#### 15.4.6.2 *LocateReply Body*

The body is empty, except for the following cases:

- If the **LocateStatus** value is **OBJECT\_FORWARD** or **OBJECT\_FORWARD\_PERM**, the body contains an object reference (IOR) that may be used as the target for requests to the object specified in the **LocateRequest** message. The usage of **OBJECT\_FORWARD\_PERM** behaves like the usage of **OBJECT\_FORWARD**, but when used by the server it also provides an indication to the client that it may replace the old IOR with the new IOR. When using **OBJECT\_FORWARD\_PERM**, both the old IOR and the new IOR are valid, but the new IOR is preferred for future use.
- If the **LocateStatus** value is **LOC\_SYSTEM\_EXCEPTION**, the body contains a marshaled **GIOP::SystemExceptionReplyBody**.
- If the **LocateStatus** value is **LOC\_NEEDS\_ADDRESSING\_MODE**, then the body contains a **GIOP::AddressingDisposition**. The client ORB is responsible for re-sending the **LocateRequest** using the requested addressing mode.

---

**Note** – Usage of **OBJECT\_FORWARD\_PERM** is now deprecated, due to problems it causes with the semantics of the **Object::hash** operation.

**OBJECT\_FORWARD\_PERM** features could be removed from some future GIOP versions if solutions to these problems are not provided.

---

**LocateReply** bodies are marshaled immediately following the **LocateReply** header.



### 15.4.6.3 Handling ForwardRequest Exception from ServantLocator

If the **ServantLocator** in a POA raises a **ForwardRequest** exception the ORB shall send a **LocateReply** message to the client with **locate\_status** set to **OBJECT\_FORWARD**, and with the body containing the object reference from the **ForwardRequest** exception's **forward\_reference** field.

### 15.4.7 CloseConnection Message

**CloseConnection** messages are sent only by servers in GIOP protocol versions 1.0 and 1.1. They inform clients that the server intends to close the connection and must not be expected to provide further responses. Moreover, clients know that any requests for which they are awaiting replies will never be processed, and may safely be reissued (on another connection). In GIOP version 1.2 and 1.3 both sides of the connection may send the **CloseConnection** message.

The **CloseConnection** message consists only of the GIOP message header, identifying the message type.

For details on the usage of **CloseConnection** messages, see Section 15.5.1, “Connection Management,” on page 15-47.

### 15.4.8 MessageError Message

The **MessageError** message is sent in response to any GIOP message whose version number or message type is unknown to the recipient or any message received whose header is not properly formed (e.g., has the wrong magic value). Error handling is context-specific.

The **MessageError** message consists only of the GIOP message header, identifying the message type.

### 15.4.9 Fragment Message

This message is added in GIOP 1.1.

The **Fragment** message is sent following a previous request or response message that has the more fragments bit set to **TRUE** in the **flags** field.

All of the GIOP messages begin with a GIOP header. One of the fields of this header is the **message\_size** field, a 32-bit unsigned number giving the number of bytes in the message following the header. Unfortunately, when actually constructing a GIOP **Request** or **Reply** message, it is sometimes impractical or undesirable to ascertain the total size of the message at the stage of message construction where the message header has to be written. GIOP 1.1 provides an alternative indication of the size of the message, for use in those cases.

In GIOP 1.1, a **Request** or **Reply** message can be broken into multiple fragments. In GIOP 1.2 and 1.3, a **Request**, **Reply**, **LocateRequest**, or **LocateReply** message can be broken into multiple fragment. The first fragment is a regular message (e.g.,

**Request** or **Reply**) with the **more** fragments bit in the **flags** field set to **TRUE**. This initial fragment can be followed by one or more messages using the fragment messages. The last fragment shall have the more fragment bit in the flag field set to **FALSE**.

A **CancelRequest** message may be sent by the client before the final fragment of the message being sent. In this case, the server should assume no more fragments will follow.

---

**Note** – A GIOP client that fragments the header of a **Request** message before sending the request ID may not send a **CancelRequest** message pertaining to that request ID and may not send another **Request** message until after the request ID is sent.

---

A primitive data type of 8 bytes or smaller should never be broken across two fragments.

In GIOP 1.1, the data in a fragment is marshaled with alignment relative to its position in the fragment, not relative to its position in the whole unfragmented message.

For GIOP version 1.2 and 1.3, the total length (including the message header) of a fragment other than the final fragment of a fragmented message are required to be a multiple of 8 bytes in length, allowing bridges to defragment and/or refragment messages without having to remarshal the encoded data to insert or remove padding.

For GIOP version 1.2 and 1.3, a fragment header is included in the message, immediately after the GIOP message header and before the fragment data. The request ID, in the fragment header, has the same value as that used in the original message associated with the fragment.

The byte order and GIOP protocol version of a fragment shall be the same as that of the message it continues.

```

module GIOP // IDL extension for GIOP 1.2 and 1.3
 // GIOP 1.2, 1.3
 struct FragmentHeader_1_2 {
 unsigned long request_id;
 };
 typedef FragmentHeader_1_2 FragmentHeader_1_3;
};

```

## 15.5 GIOP Message Transport

The GIOP is designed to be implementable on a wide range of transport protocols. The GIOP definition makes the following assumptions regarding transport behavior:

- The transport is connection-oriented. GIOP uses connections to define the scope and extent of request IDs.
- The transport is reliable. Specifically, the transport guarantees that bytes are delivered in the order they are sent, at most once, and that some positive acknowledgment of delivery is available.

- The transport can be viewed as a byte stream. No arbitrary message size limitations, fragmentation, or alignments are enforced.
- The transport provides some reasonable notification of disorderly connection loss. If the peer process aborts, the peer host crashes, or network connectivity is lost, a connection owner should receive some notification of this condition.
- The transport's model for initiating connections can be mapped onto the general connection model of TCP/IP. Specifically, an agent (described herein as a server) publishes a known network address in an IOR, which is used by the client when initiating a connection.

The server does not actively initiate connections, but is prepared to accept requests to connect (i.e., it *listens* for connections in TCP/IP terms). Another agent that knows the address (called a client) can attempt to initiate connections by sending *connect* requests to the address. The listening server may *accept* the request, forming a new, unique connection with the client, or it may *reject* the request (e.g., due to lack of resources). Once a connection is open, either side may *close* the connection. (See Section 15.5.1, "Connection Management," on page 15-47 for semantic issues related to connection closure.) A candidate transport might not directly support this specific connection model; it is only necessary that the transport's model can be mapped onto this view.

### 15.5.1 Connection Management

For the purposes of this discussion, the roles client and server are defined as follows:

- A client initiates the connection, presumably using addressing information found in an object reference (IOR) for an object to which it intends to send requests.
- A server accepts connections, but does not initiate them.

These terms only denote roles with respect to a connection. They do not have any implications for ORB or application architectures.

In GIOP protocol versions 1.0 and 1.1, connections are not symmetrical. Only clients can send **Request**, **LocateRequest**, and **CancelRequest** messages over a connection, in GIOP 1.0 and 1.1. In all GIOP versions, a server can send **Reply**, **LocateReply**, and **CloseConnection** messages over a connection; however, in GIOP 1.2, 1.3 the client can send them as well. Either client or server can send **MessageError** messages, in GIOP 1.0 and 1.1.

If multiple GIOP versions are used on an underlying transport connection, the highest GIOP version used on the connection can be used for handling the close. A **CloseConnection** message sent using any GIOP version applies to all GIOP versions used on the connection (i.e., the underlying transport connection is closed for all GIOP versions). In particular, if GIOP version 1.2 or higher has been used on the connection, the client can send the **CloseConnection** message by using the highest GIOP version in use.

Only GIOP messages are sent over GIOP connections.

Request IDs must unambiguously associate replies with requests within the scope and lifetime of a connection. Request IDs may be re-used if there is no possibility that the previous request using the ID may still have a pending reply. Note that cancellation does not guarantee no reply will be sent. It is the responsibility of the client to generate and assign request IDs. Request IDs must be unique among both **Request** and **LocateRequest** messages.

### 15.5.1.1 Connection Closure

Connections can be closed in two ways: orderly shutdown, or abortive disconnect.

For GIOP versions 1.0, and 1.1:

- Orderly shutdown is initiated by servers sending a **CloseConnection** message, or by clients just closing down a connection.
- Orderly shutdown may be initiated by the client at any time.
- A server may not initiate shutdown if it has begun processing any requests for which it has not either received a **CancelRequest** or sent a corresponding reply.
- If a client detects connection closure without receiving a **CloseConnection** message, it must assume an abortive disconnect has occurred, and treat the condition as an error.

For GIOP Version 1.2, 1.3:

- Orderly shutdown is initiated by either the originating client ORB (connection initiator) or by the server ORB (connection responder) sending a **CloseConnection** message
- If the ORB sending the **CloseConnection** is a server, or bidirectional GIOP is in use, the sending ORB must not currently be processing any Requests from the other side.
- The ORB that sends the **CloseConnection** must not send any messages after the **CloseConnection**.
- If either ORB detects connection closure without receiving a **CloseConnection** message, it must assume an abortive disconnect has occurred, and treat the condition as an error.
- If bidirectional GIOP is in use, the conditions of Section 15.8, “Bi-Directional GIOP,” on page 15-56 apply.

For all uses of **CloseConnection** (for GIOP versions 1.0, 1.1, 1.2, and 1.3):

- If there are any pending non-oneway requests, which were initiated on a connection by the ORB shutting down that connection, the connection-peer ORB should consider them as canceled.
- If an ORB receives a **CloseConnection** message from its connection-peer ORB, it should assume that any outstanding messages (i.e., without replies) were received after the connection-peer ORB sent the **CloseConnection** message, were not processed, and may be safely re-sent on a new connection.

- After issuing a **CloseConnection** message, the issuing ORB may close the connection. Some transport protocols (not including TCP) do not provide an “orderly disconnect” capability, guaranteeing reliable delivery of the last message sent. When GIOP is used with such protocols, an additional handshake needs to be provided as part of the mapping to that protocol's connection mechanisms, to guarantee that both ends of the connection understand the disposition of any outstanding GIOP requests.

### 15.5.1.2 *Multiplexing Connections*

A client, if it chooses, may send requests to multiple target objects over the same connection, provided that the connection's server side is capable of responding to requests for the objects. It is the responsibility of the client to optimize resource usage by reusing connections, if it wishes. If not, the client may open a new connection for each active object supported by the server, although this behavior should be avoided.

### 15.5.2 *Message Ordering*

Only the client (connection originator) may send **Request**, **LocateRequest**, and **CancelRequest** messages, if Bi-Directional GIOP is not in use.

Clients may have multiple pending requests. A client need not wait for a reply from a previous request before sending another request.

Servers may reply to pending requests in any order. **Reply** messages are not required to be in the same order as the corresponding **Requests**.

The ordering restrictions regarding connection closure mentioned in Connection Management, above, are also noted here. Servers may only issue **CloseConnection** messages when **Reply** messages have been sent in response to all received **Request** messages that require replies.

## 15.6 *Object Location*

The GIOP is defined to support object migration and location services without dictating the existence of specific ORB architectures or features. The protocol features are based on the following observations:

A given transport address does not necessarily correspond to any specific ORB architectural component (such as an *object adapter*, *object server process*, *Inter-ORB bridge*, and so forth). It merely implies the existence of some agent with which a connection may be opened, and to which requests may be sent.

The “agent” (owner of the server side of a connection) may have one of the following roles with respect to a particular object reference:

- The agent may be able to accept object requests directly for the object and return replies. The agent may or may not own the actual object implementation; it may be an Inter-ORB bridge that transforms the request and passes it on to another process or ORB. From GIOP's perspective, it is only important that requests can be sent directly to the agent.
- The agent may not be able to accept direct requests for any objects, but acts instead as a location service. Any **Request** messages sent to the agent would result in either exceptions or replies with **LOCATION\_FORWARD** status, providing new addresses to which requests may be sent. Such agents would also respond to **LocateRequest** messages with appropriate **LocateReply** messages.
- The agent may directly respond to some requests (for certain objects) and provide forwarding locations for other objects.
- The agent may directly respond to requests for a particular object at one point in time, and provide a forwarding location at a later time (perhaps during the same connection).

Agents are not required to implement location forwarding mechanisms. An agent can be implemented with the policy that a connection either supports direct access to an object, or returns exceptions. Such an ORB (or inter-ORB bridge) always return **LocateReply** messages with either **OBJECT\_HERE** or **UNKNOWN\_OBJECT** status, and never **OBJECT\_FORWARD** status.

Clients must, however, be able to accept and process **Reply** messages with **LOCATION\_FORWARD** status, since any ORB may choose to implement a location service. Whether a client chooses to send **LocateRequest** messages is at the discretion of the client. For example, if the client routinely expected to see **LOCATION\_FORWARD** replies when using the address in an object reference, it might always send **LocateRequest** messages to objects for which it has no recorded forwarding address. If a client sends **LocateRequest** messages, it should be prepared to accept **LocateReply** messages.

A client shall not make any assumptions about the longevity of object addresses returned by **LOCATION\_FORWARD (OBJECT\_FORWARD)** mechanisms. Once a connection based on location-forwarding information is closed, a client can attempt to reuse the forwarding information it has, but, if that fails, it shall restart the location process using the original address specified in the initial object reference.

For GIOP version 1.2 and 1.3, the usage of **LOCATION\_FORWARD\_PERM (OBJECT\_FORWARD\_PERM)** behaves like the usage of **LOCATION\_FORWARD (OBJECT\_FORWARD)**, but when used by the server it also provides an indication to the client that it may replace the old IOR with the new IOR. When using **LOCATION\_FORWARD\_PERM (OBJECT\_FORWARD\_PERM)**, both the old IOR and the new IOR are valid, but the new IOR is preferred for future use.

---

**Note** – Usage of **LOCATION\_FORWARD\_PERM** and **OBJECT\_FORWARD\_PERM** is now deprecated, due to problems it causes with the semantics of the **Object::hash** operation. **LOCATION\_FORWARD\_PERM** and **OBJECT\_FORWARD\_PERM** features could be removed from some future GIOP versions if solutions to these problems are not provided.

---

Even after performing successful invocations using an address, a client should be prepared to be forwarded. The only object address that a client should expect to continue working reliably is the one in the initial object reference. If an invocation using that address returns **UNKNOWN\_OBJECT**, the object should be deemed non-existent.

In general, the implementation of location forwarding mechanisms is at the discretion of ORBs, available to be used for optimization and to support flexible object location and migration behaviors.

## 15.7 Internet Inter-ORB Protocol (IIOP)

The baseline transport specified for GIOP is TCP/IP<sup>5</sup>. Specific APIs for libraries supporting TCP/IP may vary, so this discussion is limited to an abstract view of TCP/IP and management of its connections. The mapping of GIOP message transfer to TCP/IP connections is called the Internet Inter-ORB Protocol (IIOP).

IIOP 1.0 is based on GIOP 1.0.

IIOP 1.1 can be based on either GIOP 1.0 or 1.1. An IIOP 1.1 client must support GIOP 1.1, and may also support GIOP 1.0. An IIOP 1.1 server must support processing both GIOP 1.0 and GIOP 1.1 messages.

IIOP 1.2 can be based on any of the GIOP minor versions 1.0, 1.1, or 1.2. An IIOP 1.2 client must support GIOP 1.2, and may also support lesser GIOP minor versions. An IIOP 1.2 server must also support processing messages with all lesser GIOP versions.

IIOP 1.3 can be based on any of the GIOP minor versions 1.0, 1.1, 1.2, or 1.3. An IIOP 1.3 client must support GIOP 1.3, and may also support lesser GIOP minor versions. An IIOP 1.3 server must also support processing messages with all lesser GIOP versions.

Conformance to IIOP versions 1.1, 1.2, and 1.3 requires support of Limited-Profile IOR conformance (see Section 13.6.2, “Interoperable Object References: IORs,” on page 13-14), specifically for the IIOP IOR Profile. As of CORBA 2.4, this limited IOR conformance is deprecated, and ORBs implementing IIOP are strongly recommended to support Full IOR conformance. Some future IIOP versions could require support of Full IOR conformance.

---

5. Postel, J., “Transmission Control Protocol – DARPA Internet Program Protocol Specification,” RFC-793, Information Sciences Institute, September 1981

### 15.7.1 TCP/IP Connection Usage

Agents that are capable of accepting object requests or providing locations for objects (i.e., servers) publish TCP/IP addresses in IORs, as described in Section 15.7.2, “IIOP IOR Profiles,” on page 15-52. A TCP/IP address consists of an IP host address, typically represented by a host name, and a TCP port number. Servers must listen for connection requests.

A client needing an object’s services must initiate a connection with the address specified in the IOR, with a connect request.

The listening server may accept or reject the connection. In general, servers should accept connection requests if possible, but ORBs are free to establish any desired policy for connection acceptance (e.g., to enforce fairness or optimize resource usage).

Once a connection is accepted, the client may send **Request**, **LocateRequest**, or **CancelRequest** messages by writing to the TCP/IP socket it owns for the connection. The server may send **Reply**, **LocateReply**, and **CloseConnection** messages by writing to its TCP/IP connection. In GIOP 1.2, and 1.3, the client may send the **CloseConnection** message, and if BiDirectional GIOP is in use, the client may also send **Reply** and **LocateReply** messages.

After receiving a **CloseConnection** message, an ORB must close the TCP/IP connection. After sending a **CloseConnection**, an ORB may close the TCP/IP connection immediately, or may delay closing the connection until it receives an indication that the other side has closed the connection. For maximum interoperability with ORBs using TCP implementations that do not properly implement orderly shutdown, an ORB may wish to only shutdown the sending side of the connection, and then read any incoming data until it receives an indication that the other side has also shutdown, at which point the TCP connection can be closed completely.

Given TCP/IP’s flow control mechanism, it is possible to create deadlock situations between clients and servers if both sides of a connection send large amounts of data on a connection (or two different connections between the same processes) and do not read incoming data. Both processes may block on write operations, and never resume. It is the responsibility of both clients and servers to avoid creating deadlock by reading incoming messages and avoiding blocking when writing messages, by providing separate threads for reading and writing, or any other workable approach. ORBs are free to adopt any desired implementation strategy, but should provide robust behavior.

### 15.7.2 IIOP IOR Profiles

IIOP profiles, identifying individual objects accessible through the Internet Inter-ORB Protocol, have the following form:

```

module IIOP { // IDL extended for version 1.1, 1.2, and 1.3
 struct Version {
 octet major;
 octet minor;
 };
}

```



```

struct ProfileBody_1_0 // renamed from ProfileBody
 Version iiop_version;
 string host;
 unsigned short port;
 sequence <octet> object_key;
};

struct ProfileBody_1_1 // also used for 1.2 and 1.3
 Version iiop_version;
 string host;
 unsigned short port;
 sequence <octet> object_key;

 // Added in 1.1 unchanged for 1.2 and 1.3
 sequence <IOP::TaggedComponent> components;
};

```

IOP Profile version number:

- Indicates the IOP protocol version.
- Major number can stay the same if the new changes are backward compatible.
- Clients with lower minor version can attempt to invoke objects with higher minor version number by using only the information defined in the lower minor version protocol (ignore the extra information).

Profiles supporting only IOP version 1.0 use the **ProfileBody\_1\_0** structure, while those supporting IOP version 1.1 or 1.2 or 1.3 use the **ProfileBody\_1\_1** structure. An instance of one of these structure types is marshaled into an encapsulation octet stream. This encapsulation (a **sequence <octet>**) becomes the **profile\_data** member of the **IOP::TaggedProfile** structure representing the IOP profile in an IOR, and the tag has the value **TAG\_INTERNET\_IOP** (as defined earlier).

The version number published in the Tag Internet IOP Profile body signals the highest GIOP minor version number that the server supports at the time of publication of the IOR.

If the major revision number is 1, and the minor revision number is greater than 0, then the length of the encapsulated profile may exceed the total size of components defined in this specification for profiles with minor revision number 0. ORBs that support only revision 1.0 IOP profiles must ignore any data in the profile that occurs after the **object\_key**. If the revision of the profile is 1.0, there shall be no extra data in the profile (i.e., the length of the encapsulated profile must agree with the total size of components defined for version 1.0).

For Version 1.2 and 1.3 of IOP, no order of use is prescribed in the case where more than one TAG Internet IOP Profile is present in an IOR.

The members of **IOP::ProfileBody\_1\_0** and **IOP::ProfileBody\_1\_1** are defined as follows:

- **iiop\_version** describes the version of IIOP that the agent at the specified address is prepared to receive. When an agent generates IIOP profiles specifying a particular version, it must be able to accept messages complying with the specified version or any previous minor version (i.e., any smaller version number). The major version number of this specification is 1; the minor versions defined to date are 0, 1, and 2. Compliant ORBs must generate version 1.1 profiles, and must accept any profile with a major version of 1, regardless of the minor version number. If the minor version number is 0, the encapsulation is fully described by the **ProfileBody\_1\_0** structure. If the minor version number is 1 or 2, the encapsulation is fully described by the **ProfileBody\_1\_1** structure. If the minor version number is greater than 2, then the length of the encapsulated profile may exceed the total size of components defined in this specification for profiles with minor version number 1 or 2. ORBs that support only version 1.1 or 1.2 IIOP profiles must ignore, but preserve, any data in the profile that occurs after the **components** member, for IIOP profiles with minor version greater than 1.2.

---

**Note** – As of version 1.2 of GIOP and IIOP and minor versions beyond, the minor version in the **TAG\_INTERNET\_IOP** profile signals the highest minor revision of GIOP supported by the server at the time of publication of the IOR.

---

- **host** identifies the Internet host to which GIOP messages for the specified object may be sent. In order to promote a very large (Internet-wide) scope for the object reference, this will typically be the fully qualified domain name of the host, rather than an unqualified (or partially qualified) name. However, per Internet standards, the host string may also contain a host address expressed in standard “dotted decimal” form (e.g., “192.231.79.52”).
- **port** contains the TCP/IP port number (at the specified host) where the target agent is listening for connection requests. The agent must be ready to process IIOP messages on connections accepted at this port.
- **object\_key** is an opaque value supplied by the agent producing the IOR. This value will be used in request messages to identify the object to which the request is directed. An agent that generates an object key value must be able to map the value unambiguously onto the corresponding object when routing requests internally.
- **components** is a sequence of **TaggedComponent**, which contains additional information that may be used in making invocations on the object described by this profile. **TaggedComponents** that apply to IIOP 1.2 are described below in Section 15.7.3, “IIOP IOR Profile Components,” on page 15-55. Other components may be included to support enhanced versions of IIOP, to support ORB services such as security, and to support other GIOPs, ESIOPs, and proprietary protocols. If an implementation puts a non-standard component in an IOR, it cannot be assured that any or all non-standard components will remain in the IOR.

The relationship between the IIOP protocol version and component support conformance requirements is as follows:

- Each IOP version specifies a set of standard components and the conformance rules for that version. These rules specify which components are mandatory and which are optional. A conformant implementation has to conform to these rules, and is not required to conform to more than these rules.
- New components can be added, but they do not become part of the versions conformance rules.
- When there is a need to specify conformance rules that include the new components, there will be a need to create a new IOP version.

Note that host addresses are restricted in this version of IOP to be Class A, B, or C Internet addresses. That is, Class D (multi-cast) addresses are not allowed. Such addresses are reserved for use in future versions of IOP.

Agents may freely choose TCP port numbers for communication; IOP supports multiple agents per host.

### *15.7.3 IOP IOR Profile Components*

The following components are part of IOP 1.1, 1.2, and 1.3 conformance. All these components are optional.

- **TAG\_ORB\_TYPE**
- **TAG\_CODE\_SETS**
- **TAG\_SEC\_NAME**
- **TAG\_ASSOCIATION\_OPTIONS**
- **TAG\_GENERIC\_SEC\_MECH**
- **TAG\_SSL\_SEC\_TRANS**
- **TAG\_SPKM\_1\_SEC\_MECH**
- **TAG\_SPKM\_2\_SEC\_MECH**
- **TAG\_KerberosV5\_SEC\_MECH**
- **TAG\_CSI\_ECMA\_Secret\_SEC\_MECH**
- **TAG\_CSI\_ECMA\_Hybrid\_SEC\_MECH**
- **TAG\_SSL\_SEC\_TRANS**
- **TAG\_CSI\_ECMA\_Public\_SEC\_MECH**
- **TAG\_FIREWALL\_TRANS**
- **TAG\_JAVA\_CODEBASE**
- **TAG\_TRANSACTION\_POLICY**
- **TAG\_MESSAGE\_ROUTERS**
- **TAG\_INET\_SEC\_TRANS**

The following components are part of IOP 1.2, and 1.3 conformance. All these components are optional.

- TAG\_ALTERNATE\_IOP\_ADDRESS
- TAG\_POLICIES
- TAG\_DCE\_STRING\_BINDING
- TAG\_DCE\_BINDING\_NAME
- TAG\_DCE\_NO\_PIPES
- TAG\_DCE\_MECH
- TAG\_COMPLETE\_OBJECT\_KEY
- TAG\_ENDPOINT\_ID\_POSITION
- TAG\_LOCATION\_POLICY
- TAG\_OTS\_POLICY
- TAG\_INV\_POLICY
- TAG\_CSI\_SEC\_MECH\_LIST
- TAG\_NULL\_TAG
- TAG\_SECIOP\_SEC\_TRANS
- TAG\_TLS\_SEC\_TRANS
- TAG\_ACTIVITY\_POLICY

## 15.8 *Bi-Directional GIOP*

The specification of GIOP connection management, in GIOP minor versions 1.0 and 1.1, states that connections are not symmetrical. For example, only clients that initialize connections can send requests, and only servers that accept connections can receive them.

This GIOP 1.0 and 1.1 restriction gives rise to significant difficulties when operating across firewalls. It is common for firewalls not to allow incoming connections, except to certain well-known and carefully configured hosts, such as dedicated HTTP or FTP servers. For most CORBA-over-the-internet applications it is not practicable to require that all potential client firewalls install GIOP proxies to allow incoming connections, or that any entities receiving callbacks will require prior configuration of the firewall proxy.

An applet, for example, downloaded to a host inside such a firewall will be restricted in that it cannot receive requests from outside the firewall on any object it creates, as no host outside the firewall will be able to connect to the applet through the client's firewall, even though the applet in question would typically only expect callbacks from the server it initially registered with.

In order to circumvent this unnecessary restriction, GIOP minor protocol version 1.2 or 1.3 specifies that the asymmetry stipulation above be relaxed in cases where the client and the server agree on it. In these cases, the client (the applet in the above case) would still initiate the connection to the server, but any requests from the server on any objects.

The client creates an object for exporting to a server, and arranges that the server receive an IOR for the object. The most common use case would be for the client to pass the IOR as a parameter in a GIOP request, but other mechanisms are possible, such as the use of a Name Service. If the client ORB policy permits bi-directional use of a connection, a Request message should contain an **IOP::ServiceContext** structure in its Request header, which indicates that this GIOP connection is bi-directional. The service context may provide additional information that the server may need to invoke the callback object. To determine whether an ORB may support bi-directional GIOP new policies has been defined (Section 15.9, “Bi-directional GIOP policy,” on page 15-60).

Each mapping of GIOP to a particular transport should define a transport-specific bi-directional service context, and have an **IOP::ServiceId** allocated by the OMG. It is recommended that names for this service context follows the pattern *BiDir<protocolname>*, where <protocol name> identifies a mapping of GIOP to a transport protocol (e.g., for IIOP the name is **BiDirIIOP**). The service context for bi-directional IIOP is defined in Section 15.8.1, “Bi-Directional IIOP,” on page 15-58.

The server receives the Request, which contains a bi-directional **IOP::ServiceContext**. If the server supports bi-directional connections for that protocol, it may now send invocations along the same connection to any object that supports the particular protocol and matches the particular location information found in the bi-directional service context. If the server does not support bi-directional connections for that protocol, the service context can be ignored.

The data encapsulated in the **BiDirIIOPServiceContext** structure (see below), which is identified by the **ServiceId BI\_DIR\_IIO** as defined in Section 13.7, “Service Context,” on page 13-28, allows the ORB to determine whether it needs to open a new connection in order to invoke on an object. If a host and port pair in a *listen\_point* list matches a host and port of an object to which it does not yet have a connection (a callback object newly received, for instance), rather than open a new connection, the server may re-use any of the connections on which the *listen\_point* data was received.

A server talking to a client on a bi-directional GIOP connection can use any message type traditionally used by clients only, so it can use **Request**, **LocateRequest**, **CancelRequest**, **MessageError**, and **Fragment** (for a **Request** or **LocateRequest**). Similarly the client can use message types traditionally used only by servers: **Reply**, **LocateReply**, **MessageError**, **CloseConnection**, and **Fragment** (for a **Reply** or **LocateReply**).

**CloseConnection** messages are a special case however. Either ORB may send a **CloseConnection** message, but the conditions in Section 15.5.1, “Connection Management,” on page 15-47 apply.

Bi-directional GIOP connections modify the behavior of Request IDs. In the GIOP specification, Section 15.5.1, “Connection Management,” on page 15-47, it is noted that “Request IDs must unambiguously associate replies with requests within the scope and lifetime of a connection.” This property of unambiguous association of requests and replies must be preserved while permitting each end to generate Request IDs for new requests independently. To ensure this, on a connection that is used bi-directionally in GIOP 1.2, and 1.3, the connection originator shall assign only even valued Request IDs and the other side of the connection shall assign only odd valued Request IDs. This requirement applies to the full lifetime of the connection, even before a **BiDirIIOPServiceContext** is transmitted. A connection on which this regime of Request ID assignment is not used, shall never be used to transmit bi-directional GIOP 1.2, or 1.3 messages.

It should be noted that a single-threaded ORB needs to perform event checking on the connection, in case a **Request** from the other endpoint arrives in the window between it sending its own **Request** and receiving the corresponding reply; otherwise a client and server could send **Requests** simultaneously, resulting in deadlock. If the client cannot support event checking, it must not indicate that bi-directionality is supported. If the server cannot support event checking, it must not make callbacks along the same connection even if the connection indicates it is supported.

A server making a callback to a client cannot specify its own bi-directional service context – only the client can announce the connection's bi-directionality.

An important security issue should be observed in the use of bi-directional GIOP. In the absence of other security mechanisms, a malicious client may claim that its connection is Bi-Directional for use with any host and port it chooses. In particular it may specify the host and port of security sensitive objects not even resident on its host. All the client has to do is pass the host and port in the listen data service context and the server may then invoke a masquerading object instead. In general, and in the absence of other security mechanisms, a server that has accepted an incoming connection has no way to discover the identity or verify the integrity of the client that initiated the connection. If the server has doubts in the integrity of the client, it is recommended that bi-directional GIOP is not used.

### 15.8.1 Bi-Directional IIOP

The **IOP::ServiceContext** used to support bi-directional IIOP contains a **BiDirIIOPServiceContext** structure as defined below:

```
// IDL
module IOP {

 struct ListenPoint {
 string host;
 unsigned short port;
 };

 typedef sequence<ListenPoint> ListenPointList;
}
```

```

 struct BiDirIOPServiceContext {
 ListenPointList listen_points;
 };
};

```

The data encapsulated in the **BiDirIOPServiceContext** structure, which is identified by the ServiceId **BI\_DIR\_IOP** as defined in Section 13.7, “Service Context,” on page 13-28, allows the ORB, which intends to open a new connection in order to invoke on an object, to look up its list of active client-initiated connections and examine the structures associated with them, if any. If a **host** and **port** pair in a **listen\_points** list matches a host and port, which the ORB intends to open a connection to, rather than open a new connection to that **listen\_point**, the server may re-use any of the connections that were initiated by the client on which the listen point data was received.

The **host** element of the structure should contain whatever values the client may use in the IORs it creates. The rules for **host** and **port** are identical to the rules for the IOP IOR **ProfileBody\_1\_1 host** and **port** elements; see Section 15.7.2, “IOP IOR Profiles,” on page 15-52. Note that if the server wishes to make a callback connection to the client in the standard way, it must use the values from the client object's IOR, not the values from this **BiDirIOPServiceContext** structure; these values are only to be used for bi-directional GIOP support.

The **BI\_DIR\_IOP** service context may be sent by a client at any point in a connection's lifetime. The **listen\_points** specified therein must supplement any **listen\_points** already sent on the connection, rather than replacing the existing points.

If a client supports a secure connection mechanism, such as SECIOP or IOP/SSL, and sends a **BI\_DIR\_IOP** service context over an insecure connection, the **host** and **port** endpoints listed in the **BI\_DIR\_IOP** should not contain the details of the secure connection mechanism if insecure callbacks to the client's secure objects would be a violation of the client's security policy.

It is the ORB's responsibility to ensure that an IOR contains an appropriate address.

### 15.8.1.1 IOP/SSL considerations

Bi-directional IOP can operate over IOP/SSL (*see CORBAServices Chapter 15*) without defining any additions to the IOP/SSL or the bi-directional GIOP mechanisms. However, if the client wants to authenticate the server when the client receives a callback this cannot be done unless the client has already authenticated the server. This has to be performed during the initial SSL handshake. It is not possible to do this at any point after the initial handshake without establishing a new SSL connection (which defeats the purpose of the bi-directional connections).

## 15.9 Bi-directional GIOP policy

In GIOP protocol versions 1.0 and 1.1, there are strict rules on which side of a connection can issue what type of messages (for example version 1.0 and 1.1 clients can not issue GIOP reply messages). However, as documented above, it is sensible to relax this restriction if the ORB supports this functionality and policies dictate that bi-directional connection are allowed. To indicate a bi-directional policy, the following is defined.

**// Self contained module for Bi-directional GIOP policy**

```

module BiDirPolicy {

 typedef unsigned short BidirectionalPolicyValue;
 const BidirectionalPolicyValue NORMAL = 0;
 const BidirectionalPolicyValue BOTH = 1;

 const CORBA::PolicyType BIDIRECTIONAL_POLICY_TYPE = 37;

 interface BidirectionalPolicy : CORBA::Policy {
 readonly attribute BidirectionalPolicyValue value;
 };
};

```

A **BidirectionalPolicyValue** of **NORMAL** states that the usual GIOP restrictions of who can send what GIOP messages apply (i.e., bi-directional connections are not allowed). A value of **BOTH** indicates that there is a relaxation in what party can issue what GIOP messages (i.e., bi-directional connections are supported). The default value of a **BidirectionalPolicy** is **NORMAL**.

In the absence of a **BidirectionalPolicy** being passed in the **PortableServer::POA::create\_POA** operation, a **POA** will assume a policy value of **NORMAL**.

A client and a server **ORB** must each have a **BidirectionalPolicy** with a value of **BOTH** for bi-directional communication to take place.

To create a **BidirectionalPolicy**, the **ORB::create\_policy** operation is used.

## 15.10 OMG IDL

This section contains the OMG IDL for the GIOP and IIOP modules.

### 15.10.1 GIOP Module

```

module GIOP { // IDL extended for version 1.1, 1.2, and 1.3

 struct Version {
 octet major;
 octet minor;
 };

```



```

};

#ifndef GIOP_1_1
// GIOP 1.0
enum MsgType_1_0{ // rename from MsgType
 Request, Reply, CancelRequest,
 LocateRequest, LocateReply,
 CloseConnection, MessageError
};

#else
// GIOP 1.1
enum MsgType_1_1{
 Request, Reply, CancelRequest,
 LocateRequest, LocateReply,
 CloseConnection, MessageError,
 Fragment // GIOP 1.1 addition
};
#endif

// GIOP 1.0
struct MessageHeader_1_0 { // Renamed from MessageHeader
 char magic [4];
 Version GIOP_version;
 boolean byte_order;
 octet message_type;
 unsigned long message_size;
};

// GIOP 1.1
struct MessageHeader_1_1 {
 char magic [4];
 Version GIOP_version;
 octet flags; // GIOP 1.1 change
 octet message_type;
 unsigned long message_size;
};

// GIOP 1.2 and 1.3
typedef MessageHeader_1_1 MessageHeader_1_2;
typedef MessageHeader_1_1 MessageHeader_1_3;

// GIOP 1.0
struct RequestHeader_1_0 {
 IOP::ServiceContextList service_context;
 unsigned long request_id;
 boolean response_expected;
 sequence <octet> object_key;
 string operation;
 CORBA::OctetSeq requesting_principal;
};

```

```

// GIOP 1.1
struct RequestHeader_1_1 {
 IOP::ServiceContextList service_context;
 unsigned long request_id;
 boolean response_expected;
 octet reserved[3]; // Added in GIOP 1.1
 sequence <octet> object_key;
 string operation;
 CORBA::OctetSeq requesting_principal;
};

// GIOP 1.2, and 1.3
typedef short AddressingDisposition;
const short KeyAddr = 0;
const short ProfileAddr = 1;
const short ReferenceAddr = 2;

struct IORAddressingInfo {
 unsigned long selected_profile_index;
 IOP::IOR ior;
};

union TargetAddress switch (AddressingDisposition) {
 case KeyAddr: sequence <octet> object_key;
 case ProfileAddr: IOP::TaggedProfile profile;
 case ReferenceAddr: IORAddressingInfo ior;
};

struct RequestHeader_1_2 {
 unsigned long request_id;
 octet response_flags;
 octet reserved[3];
 TargetAddress target;
 string operation;
 // requesting_principal not in GIOP 1.2 and 1.3
 IOP::ServiceContextList service_context; // 1.2 change
};

#ifndef GIOP_1_2
// GIOP 1.0 and 1.1
enum ReplyStatusType_1_0 { // Renamed from ReplyStatusType
 NO_EXCEPTION,
 USER_EXCEPTION,
 SYSTEM_EXCEPTION,
 LOCATION_FORWARD
};

// GIOP 1.0
struct ReplyHeader_1_0 { // Renamed from ReplyHeader
 IOP::ServiceContextList service_context;
 unsigned long request_id;
};

```

```

 ReplyStatusType_1_0 reply_status;
 };

 // GIOP 1.1
 typedef ReplyHeader_1_0 ReplyHeader_1_1;
 // Same Header contents for 1.0 and 1.1

#else
 // GIOP 1.2, and 1.3
 enum ReplyStatusType_1_2 {
 NO_EXCEPTION,
 USER_EXCEPTION,
 SYSTEM_EXCEPTION,
 LOCATION_FORWARD,
 LOCATION_FORWARD_PERM, // new value for 1.2
 NEEDS_ADDRESSING_MODE // new value for 1.2
 };

 struct ReplyHeader_1_2 {
 unsigned long request_id;
 ReplyStatusType_1_2 reply_status;
 IOP::ServiceContextList service_context; // 1.2 change
 };
 typedef ReplyHeader_1_2 ReplyHeader_1_3;

#endif // GIOP_1_2
 struct SystemExceptionReplyBody {
 string exception_id;
 unsigned long minor_code_value;
 unsigned long completion_status;
 };

 struct CancelRequestHeader {
 unsigned long request_id;
 };

 // GIOP 1.0
 struct LocateRequestHeader_1_0 {
 // Renamed LocationRequestHeader
 unsigned long request_id;
 sequence <octet> object_key;
 };

 // GIOP 1.1
 typedef LocateRequestHeader_1_0 LocateRequestHeader_1_1;
 // Same Header contents for 1.0 and 1.1

 // GIOP 1.2 and 1.3
 struct LocateRequestHeader_1_2 {
 unsigned long request_id;
 TargetAddress target;
 };

```

```

};
typedef LocateRequestHeader_1_2 LocateRequestHeader_1_3;

#ifndef GIOP_1_2
// GIOP 1.0 and 1.1
enum LocateStatusType_1_0 { // Renamed from LocateStatusType
 UNKNOWN_OBJECT,
 OBJECT_HERE,
 OBJECT_FORWARD
};

// GIOP 1.0
struct LocateReplyHeader_1_0 {
 // Renamed from LocateReplyHeader
 unsigned long request_id;
 LocateStatusType_1_0 locate_status;
};

// GIOP 1.1
typedef LocateReplyHeader_1_0 LocateReplyHeader_1_1;
// same Header contents for 1.0 and 1.1

#else
// GIOP 1.2, and 1.3
enum LocateStatusType_1_2 {
 UNKNOWN_OBJECT,
 OBJECT_HERE,
 OBJECT_FORWARD,
 OBJECT_FORWARD_PERM, // new value for GIOP 1.2
 LOC_SYSTEM_EXCEPTION, // new value for GIOP 1.2
 LOC_NEEDS_ADDRESSING_MODE // new value for GIOP 1.2
};

struct LocateReplyHeader_1_2 {
 unsigned long request_id;
 LocateStatusType_1_2 locate_status;
};
typedef LocateReplyHeader_1_2 LocateReplyHeader_1_3;
#endif // GIOP_1_2

// GIOP 1.2, and 1.3
struct FragmentHeader_1_2 {
 unsigned long request_id;
};
typedef FragmentHeader_1_2 FragmentHeader_1_3;
};

```

### 15.10.2 IIOP Module

```

module IIOP { // IDL extended for version 1.1, 1.2, and 1.3

```

```

struct Version {
 octet major;
 octet minor;
};

struct ProfileBody_1_0 { // renamed from ProfileBody
 Version iiop_version;
 string host;
 unsigned short port;
 sequence <octet> object_key;
};

struct ProfileBody_1_1 { // also used for 1.2, and 1.3
 Version iiop_version;
 string host;
 unsigned short port;
 sequence <octet> object_key;

 // Added in 1.1 unchanged for 1.2, and 1.3
 sequence <IOP::TaggedComponent> components;
};

struct ListenPoint {
 string host;
 unsigned short port;
};

typedef sequence<ListenPoint> ListenPointList;

struct BiDirIOPServiceContext { // BI_DIR_IOP Service Context
 ListenPointList listen_points;
};
};

```

### 15.10.3 BiDirPolicy Module

```

// Self contained module for Bi-directional GIOP policy

module BiDirPolicy {

 typedef unsigned short BidirectionalPolicyValue;
 const BidirectionalPolicyValue NORMAL = 0;
 const BidirectionalPolicyValue BOTH = 1;

 const CORBA::PolicyType BIDIRECTIONAL_POLICY_TYPE = 37;

 interface BidirectionalPolicy : CORBA::Policy {
 readonly attribute BidirectionalPolicyValue value;
 };
};

```



This chapter specifies an Environment-Specific Inter-ORB Protocol (ESIOP) for the OSF DCE environment, the DCE Common Inter-ORB Protocol (DCE-CIOP).

## *Contents*

This chapter contains the following sections.

| <b>Section Title</b>                         | <b>Page</b> |
|----------------------------------------------|-------------|
| “Goals of the DCE Common Inter-ORB Protocol” | 16-1        |
| “DCE Common Inter-ORB Protocol Overview”     | 16-2        |
| “DCE-CIOP Message Transport”                 | 16-5        |
| “DCE-CIOP Message Formats”                   | 16-11       |
| “DCE-CIOP Object References”                 | 16-16       |
| “DCE-CIOP Object Location”                   | 16-21       |
| “OMG IDL for the DCE CIOP Module”            | 16-25       |
| “References for this Chapter”                | 16-26       |

## *16.1 Goals of the DCE Common Inter-ORB Protocol*

DCE CIOP was designed to meet the following goals:

- Support multi-vendor, mission-critical, enterprise-wide, ORB-based applications.
- Leverage services provided by DCE wherever appropriate.
- Allow efficient and straightforward implementation using public DCE APIs.
- Preserve ORB implementation freedom.

DCE CIOP achieves these goals by using DCE-RPC to provide message transport, while leaving the ORB responsible for message formatting, data marshaling, and operation dispatch.

## 16.2 DCE Common Inter-ORB Protocol Overview

The DCE Common Inter-ORB Protocol uses the wire format and RPC packet formats defined by DCE-RPC to enable independently implemented ORBs to communicate. It defines the message formats that are exchanged using DCE-RPC, and specifies how information in object references is used to establish communication between client and server processes.

The full OMG IDL for the DCE ESIOP specification is shown in Section 16.7, “OMG IDL for the DCE CIOP Module,” on page 16-25. Fragments are used throughout this chapter as necessary.

### 16.2.1 DCE-CIOP RPC

DCE-CIOP requires an RPC, which is interoperable with the DCE connection-oriented and/or connectionless protocols as specified in the *X/Open CAE Specification C309* and the *OSF AES/Distributed Computing RPC Volume*. Some of the features of the DCE-RPC are as follows:

- Defines connection-oriented and connectionless protocols for establishing the communication between a client and server.
- Supports multiple underlying transport protocols including TCP/IP.
- Supports multiple outstanding requests to multiple CORBA objects over the same connection.
- Supports fragmentation of messages. This provides for buffer management by ORBs of CORBA requests, which contain a large amount of marshaled data.

All interactions between ORBs take the form of remote procedure calls on one of two well-known DCE-RPC interfaces. Two DCE operations are provided in each interface:

- *invoke* - for invoking CORBA operation requests, and
- *locate* - for locating server processes.

Each DCE operation is a synchronous remote procedure call<sup>1,2</sup>, consisting of a request message being transmitted from the client to the server, followed by a response message being transmitted from the server to the client.

---

1. DCE *maybe* operation semantics cannot be used for CORBA *oneway* operations because they are idempotent as opposed to at-most-once.

2. The deferred synchronous DII API can be implemented on top of synchronous RPCs by using threads.



Using one of the DCE-RPC interfaces, the messages are transmitted as pipes of uninterpreted bytes. By transmitting messages via DCE pipes, the following characteristics are achieved:

- Large amounts of data can be transmitted efficiently.
- Buffering of complete messages is not required.
- Marshaling and demarshaling can take place concurrently with message transmission.
- Encoding of messages and marshaling of data is completely under the control of the ORB.
- DCE client and server stubs can be used to implement DCE-CIOP.

Using the other DCE-RPC interface, the messages are transmitted as conformant arrays of uninterpreted bytes. This interface does not offer all the advantages of the pipe-based interface, but is provided to enable interoperability with ORBs using DCE-RPC implementations that do not adequately support pipes.

### 16.2.2 DCE-CIOP Data Representation

DCE-CIOP messages represent OMG IDL types by using the CDR transfer syntax, which is defined in Section 15.2.1, “Common Data Representation (CDR),” on page 15-3. DCE-CIOP message headers and bodies are specified as OMG IDL types. These are encoded using CDR, and the resulting messages are passed between client and server processes via DCE-RPC pipes or conformant arrays.

NDR is the transfer syntax used by DCE-RPC for operations defined in DCE IDL. CDR, used to represent messages defined in OMG IDL on top of DCE RPCs, represents the OMG IDL primitive types identically to the NDR representation of corresponding DCE IDL primitive types.

The corresponding OMG IDL and DCE IDL primitive types are shown in Table 16-1.

Table 16-1 Relationship between CDR and NDR primitive data types

| OMG IDL type   | DCE IDL type with NDR representation equivalent to CDR representation of OMG IDL type |
|----------------|---------------------------------------------------------------------------------------|
| char           | byte                                                                                  |
| wchar          | byte, unsigned short, or unsigned long, depending on transmission code set            |
| octet          | byte                                                                                  |
| short          | short                                                                                 |
| unsigned short | unsigned short                                                                        |
| long           | long                                                                                  |
| unsigned long  | unsigned long                                                                         |

Table 16-1 Relationship between CDR and NDR primitive data types

| OMG IDL type       | DCE IDL type with NDR representation equivalent to CDR representation of OMG IDL type |
|--------------------|---------------------------------------------------------------------------------------|
| long long          | hyper                                                                                 |
| unsigned long long | unsigned hyper                                                                        |
| float              | float <sup>1</sup>                                                                    |
| double             | double <sup>2</sup>                                                                   |
| long double        | long double <sup>3</sup>                                                              |
| boolean            | byte <sup>4</sup>                                                                     |

1. Restricted to IEEE format.
2. Restricted to IEEE format.
3. Restricted to IEEE format.
4. Values restricted to 0 and 1.

The CDR representation of OMG IDL constructed types and pseudo-object types does not correspond to the NDR representation of types describable in DCE IDL.

A wide string is encoded as a unidimensional conformant array of octets in DCE 1.1 NDR. This consists of an unsigned long of four octets, specifying the number of octets in the array, followed by that number of octets, with no null terminator.

The NDR representation of OMG IDL fixed-point type, **fixed**, will be proposed as an addition to the set of DCE IDL types.

As new data types are added to OMG IDL, NDR can be used as a model for their CDR representations.

### 16.2.3 DCE-CIOP Messages

The following request and response messages are exchanged between ORB clients and servers via the `invoke` and `locate` RPCs:

- *Invoke Request* identifies the target object and the operation and contains the principal, the operation context, a **ServiceContext**, and the **in** and **inout** parameter values.
- *Invoke Response* indicates whether the operation succeeded, failed, or needs to be reinvoked at another location, and returns a **ServiceContext**. If the operation succeeded, the result and the **out** and **inout** parameter values are returned. If it failed, an exception is returned. If the object is at another location, new RPC binding information is returned.

- *Locate Request* identifies the target object and the operation.
- *Locate Response* indicates whether the location is in the current process, is elsewhere, or is unknown. If the object is at another location, new RPC binding information is returned.

All message formats begin with a field that indicates the byte order used in the CDR encoding of the remainder of the message. The CDR byte order of a message is required to match the NDR byte order used by DCE-RPC to transmit the message.

#### 16.2.4 Interoperable Object Reference (IOR)

For DCE-CIOP to be used to invoke operations on an object, the information necessary to reference an object via DCE-CIOP must be included in an IOR. This information can coexist with the information needed for other protocols such as IIOP. DCE-CIOP information is stored in an IOR as a set of components in a profile identified by either **TAG\_INTERNET\_IOP** or **TAG\_MULTIPLE\_COMPONENTS**. Components are defined for the following purposes:

- To identify a server process via a DCE string binding, which can be either fully or partially bound. This process may be a server process implementing the object, or it may be an agent capable of locating the object implementation.
- To identify a server process via a name that can be resolved using a DCE nameservice. Again, this process may implement the object or may be an agent capable of locating it.
- In the **TAG\_MULTIPLE\_COMPONENTS** profile, to identify the target object when request messages are sent to the server. In the **TAG\_INTERNET\_IOP** profile, the **object\_key** profile member is used instead.
- To enable a DCE-CIOP client to recognize objects that share an endpoint.
- To indicate whether a DCE-CIOP client should send a locate message or an invoke message.
- To indicate if the pipe-based DCE-RPC interface is not available.

The IOR is created by the server ORB to provide the information necessary to reference the CORBA object.

### 16.3 DCE-CIOP Message Transport

DCE-CIOP defines two DCE-RPC interfaces for the transport of messages between client ORBs and server ORBs<sup>3</sup>. One interface uses pipes to convey the messages, while the other uses conformant arrays.

The pipe-based interface is the preferred interface, since it allows messages to be transmitted without precomputing the message length. But not all DCE-RPC implementations adequately support pipes, so this interface is optional. All client and server ORBs implementing DCE-CIOP must support the array-based interface<sup>4</sup>.

While server ORBs may provide both interfaces or just the array-based interface, it is up to the client ORB to decide which to use for an invocation. If a client ORB tries to use the pipe-based interface and receives an `rpc_s_unknown_if` error, it should fall back to the array-based interface.

### 16.3.1 Pipe-based Interface

The `dce_ciop_pipe` interface is defined by the DCE IDL specification shown below:

```

[/* DCE IDL */
uuid(d7d99f66-97ee-11cf-b1a0-0800090b5d3e),/* 2nd revision
*/
version(1.0)
]
interface dce_ciop_pipe
{
typedef pipe byte message_type;
 void invoke ([in] handle_t binding_handle,
 [in] message_type *request_message,
 [out] message_type *response_message);
 void locate ([in] handle_t binding_handle,
 [in] message_type *request_message,
 [out] message_type *response_message);
}

```

ORBs can implement the `dce_ciop_pipe` interface by using DCE stubs generated from this IDL specification, or by using lower-level APIs provided by a particular DCE-RPC implementation.

The `dce_ciop_pipe` interface is identified by the UUID and version number shown. To provide maximal performance, all server ORBs and location agents implementing DCE-CIOP should listen for and handle requests made to this interface. To maximize the chances of interoperating with any DCE-CIOP client, servers should listen for requests arriving via all available DCE protocol sequences.

Client ORBs can invoke OMG IDL operations over DCE-CIOP by performing DCE RPCs on the `dce_ciop_pipe` interface. The `dce_ciop_pipe` interface is made up of two DCE-RPC operations, `invoke` and `locate`. The first parameter of each of these RPCs is a DCE binding handle, which identifies the server process on which to

- 
3. Previous DCE-CIOP revisions used different DCE RPC interface UUIDs and had incompatible message formats. These previous revisions are deprecated, but implementations can continue to support them in conjunction with the current interface UUIDs and message formats.
  4. A future DCE-CIOP revision may eliminate the array-based interface and require support of the pipe-based interface.

perform the RPC. See “DCE-CIOP String Binding Component” on page 16-17, “DCE-CIOP Binding Name Component” on page 16-18, and “DCE-CIOP Object Location” on page 16-21 for discussion of how these binding handles are obtained. The remaining parameters of the `dce_ciop_pipe` RPCs are pipes of uninterpreted bytes. These pipes are used to convey messages encoded using CDR. The `request_message` input parameters send a request message from the client to the server, while the `response_message` output parameters return a response message from the server to the client.

Figure 16-1 illustrates the layering of DCE-CIOP messages on the DCE-RPC protocol as NDR pipes:

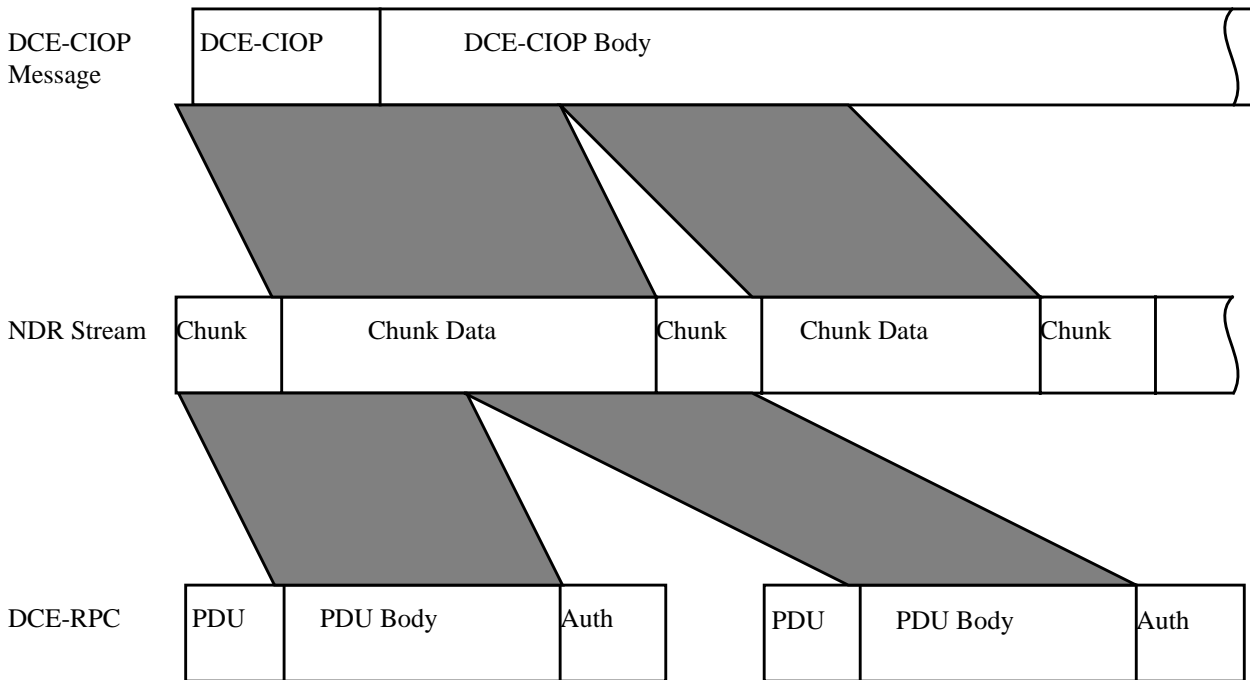

Figure 16-1 Pipe-based Interface Protocol Layering

The DCE-RPC protocol data unit (PDU) bodies, after any appropriate authentication is performed, are concatenated by the DCE-RPC run-time to form an NDR stream. This stream is then interpreted as the NDR representation of a DCE IDL pipe.

A pipe is made up of chunks, where each chunk consists of a chunk length and chunk data. The chunk length is an unsigned long indicating the number of pipe elements that make up the chunk data. The pipe elements are DCE IDL bytes, which are uninterpreted by NDR. A pipe is terminated by a chunk length of zero. The pipe chunks are concatenated to form a DCE-CIOP message.

### 16.3.1.1 Invoke

The **invoke** RPC is used by a DCE-CIOP client process to attempt to invoke a CORBA operation in the server process identified by the **binding\_handle** parameter. The **request\_message** pipe transmits a DCE-CIOP invoke request message, encoded using CDR, from the client to the server. See Section 16.4.1, “DCE\_CIOP Invoke Request Message,” on page 16-11 for a description of its format. The **response\_message** pipe transmits a DCE-CIOP invoke response message, also encoded using CDR, from the server to the client. See Section 16.4.2, “DCE-CIOP Invoke Response Message,” on page 16-12 for a description of the response format.

### 16.3.1.2 Locate

The **locate** RPC is used by a DCE-CIOP client process to query the server process identified by the **binding\_handle** parameter for the location of the server process where requests should be sent. The **request\_message** and **response\_message** parameters are used similarly to the parameters of the **invoke** RPC. See Section 16.4.3, “DCE-CIOP Locate Request Message,” on page 16-14 and Section 16.4.4, “DCE-CIOP Locate Response Message,” on page 16-15 for descriptions of their formats. Use of the **locate** RPC is described in detail in Section 16.6, “DCE-CIOP Object Location,” on page 16-21.

## 16.3.2 Array-based Interface

The **dce\_ciop\_array** interface is defined by the DCE IDL specification shown below:

```
[/* DCE IDL */
uuid(09f9ffb8-97ef-11cf-9c96-0800090b5d3e), /* 2nd revision
*/
version(1.0)
]
interface dce_ciop_array
{
 typedef struct {
 unsigned long length;
 [size_is(length),ptr] byte *data;
 } message_type;

 void invoke ([in] handle_t binding_handle,
 [in] message_type *request_message,
 [out] message_type *response_message);

 void locate ([in] handle_t binding_handle,
 [in] message_type *request_message,
 [out] message_type *response_message);
}
```

ORBs can implement the **dce\_ciop\_array** interface, identified by the UUID and version number shown, by using DCE stubs generated from this IDL specification, or by using lower-level APIs provided by a particular DCE-RPC implementation.

All server ORBs and location agents implementing DCE-CIOP must listen for and handle requests made to the **dce\_ciop\_array** interface, and to maximize interoperability, should listen for requests arriving via all available DCE protocol sequences.

Client ORBs can invoke OMG IDL operations over DCE-CIOP by performing **locate** and **invoke** RPCs on the **dce\_ciop\_array** interface.

As with the **dce\_ciop\_pipe** interface, the first parameter of each **dce\_ciop\_array** RPC is a DCE binding handle that identifies the server process on which to perform the RPC. The remaining parameters are structures containing CDR-encoded messages. The **request\_message** input parameters send a request message from the client to the server, while the **response\_message** output parameters return a response message from the server to the client.

The **message\_type** structure used to convey messages is made up of a **length** member and a **data** member:

- *length* - This member indicates the number of bytes in the message.
- *data* - This member is a full pointer to the first byte of the conformant array containing the message.

The layering of DCE-CIOP messages on DCE-RPC using NDR arrays is illustrated in Figure 16-2:

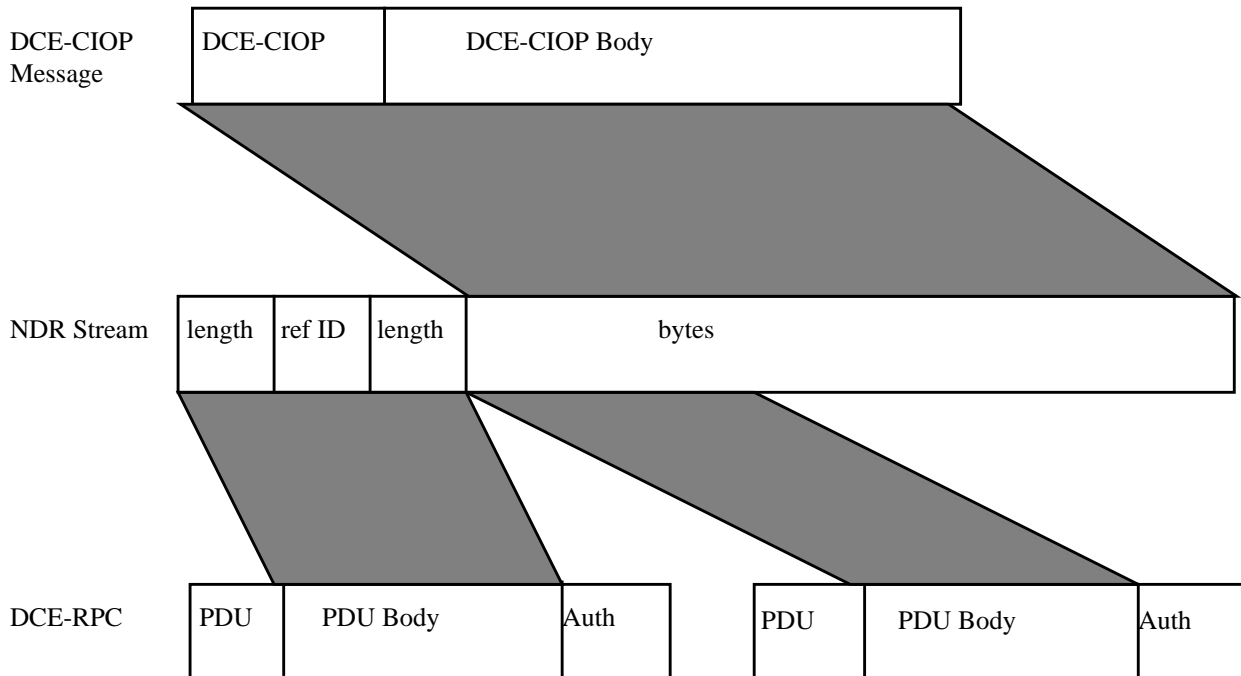

Figure 16-2 Array-based Interface Protocol Layering

The NDR stream, formed by concatenating the PDU bodies, is interpreted as the NDR representation of the DCE IDL `message_type` structure. The `length` member is encoded first, followed by the `data` member. The `data` member is a full pointer, which is represented in NDR as a referent ID. In this case, this non-NULL pointer is the first (and only) pointer to the referent, so the referent ID is 1 and it is followed by the representation of the referent. The referent is a conformant array of bytes, which is represented in NDR as an unsigned long indicating the length, followed by that number of bytes. The bytes form the DCE-CIOP message.

### 16.3.2.1 Invoke

The `invoke` RPC is used by a DCE-CIOP client process to attempt to invoke a CORBA operation in the server process identified by the `binding_handle` parameter. The `request_message` input parameter contains a DCE-CIOP invoke request message. The `response_message` output parameter returns a DCE-CIOP invoke response message from the server to the client.



### 16.3.2.2 *Locate*

The **locate** RPC is used by a DCE-CIOP client process to query the server process identified by the **binding\_handle** parameter for the location of the server process where requests should be sent. The **request\_message** and **response\_message** parameters are used similarly to the parameters of the **invoke** RPC.

## 16.4 *DCE-CIOP Message Formats*

This section defines the message formats used by DCE-CIOP. These message formats are specified in OMG IDL, are encoded using CDR, and are transmitted over DCE-RPC as either pipes or arrays of bytes as described in Section 16.3, “DCE-CIOP Message Transport,” on page 16-5.

### 16.4.1 *DCE\_CIOP Invoke Request Message*

DCE-CIOP invoke request messages encode CORBA object requests, including attribute accessor operations and **CORBA::Object** operations such as **get\_interface** and **get\_implementation**. Invoke requests are passed from client to server as the **request\_message** parameter of an **invoke** RPC.

A DCE-CIOP invoke request message is made up of a header and a body. The header has a fixed format, while the format of the body is determined by the operation’s IDL definition.

#### 16.4.1.1 *Invoke request header*

DCE-CIOP request headers have the following structure:

```

module DCE_CIOP {
 struct InvokeRequestHeader {
 boolean byte_order;
 IOP::ServiceContextList service_context;
 sequence <octet> object_key;
 string operation;
 CORBA::Principal principal;

 // in and inout parameters follow
 };
};

```

The members have the following definitions:

- **byte\_order** indicates the byte ordering used in the representation of the remainder of the message. A value of FALSE indicates big-endian byte ordering, and TRUE indicates little-endian byte ordering.
- **service\_context** contains any ORB service data that needs to be sent from the client to the server.

- **object\_key** contains opaque data used to identify the object that is the target of the operation<sup>5</sup>. Its value is obtained from the **object\_key** field of the **TAG\_INTERNET\_IOP** profile or the **TAG\_COMPLETE\_OBJECT\_KEY** component of the **TAG\_MULTIPLE\_COMPONENTS** profile.
- **operation** contains the name of the CORBA operation being invoked. The case of the operation name must match the case of the operation name specified in the OMG IDL source for the interface being used.

Attribute accessors have names as follows:

- Attribute selector: operation name is “\_get\_<attribute>”
- Attribute mutator: operation name is “\_set\_<attribute>”

**CORBA::Object** pseudo-operations have operation names as follows:

- **get\_interface** – operation name is “\_interface”
- **get\_implementation** – operation name is “\_implementation”
- **is\_a** – operation name is “\_is\_a”
- **non\_existent** – operation name is “\_non\_existent”
- **Principal** contains a value identifying the requesting principal. No particular meaning or semantics are associated with this value. It is provided to support the **BOA::get\_principal** operation.

#### 16.4.1.2 Invoke request body

The invoke request body contains the following items encoded in this order:

- All **in** and **inout** parameters, in the order in which they are specified in the operation’s OMG IDL definition, from left to right.
- An optional Context pseudo object, encoded as described in Section 15.3.5.4, “Context,” on page 15-30<sup>6</sup>. This item is only included if the operation’s OMG IDL definition includes a context expression, and only includes context members as defined in that expression.

### 16.4.2 DCE-CIOP Invoke Response Message

Invoke response messages are returned from servers to clients as the **response\_message** parameter of an **invoke** RPC.

---

5. Previous revisions of DCE-CIOP included an `endpoint_id` member, obtained from an optional `TAG_ENDPOINT_ID` component, as part of the object identity. The endpoint ID, if used, is now contained within the object key, and its position is specified by the optional `TAG_ENDPOINT_ID_POSITION` component.

6. Previous revisions of DCE-CIOP encoded the Context in the `InvokeRequestHeader`. It has been moved to the body for consistency with GIOP.

Like invoke request messages, an invoke response message is made up of a header and a body. The header has a fixed format, while the format of the body depends on the operation's OMG IDL definition and the outcome of the invocation.

### 16.4.2.1 Invoke response header

DCE-CIOP invoke response headers have the following structure:

```

module DCE_CIOP { // IDL
 enum InvokeResponseStatus {
 INVOKE_NO_EXCEPTION,
 INVOKE_USER_EXCEPTION,
 INVOKE_SYSTEM_EXCEPTION,
 INVOKE_LOCATION_FORWARD,
 INVOKE_TRY_AGAIN
 };

 struct InvokeResponseHeader {
 boolean byte_order;
 IOP::ServiceContextList service_context;
 InvokeResponseStatus status;

 // if status = INVOKE_NO_EXCEPTION,
 // result then inouts and outs follow

 // if status = INVOKE_USER_EXCEPTION or
 // INVOKE_SYSTEM_EXCEPTION, an exception follows

 // if status = INVOKE_LOCATION_FORWARD, an
 // IOP::IOR follows
 };
};

```

The members have the following definitions:

- **byte\_order** indicates the byte ordering used in the representation of the remainder of the message. A value of FALSE indicates big-endian byte ordering, and TRUE indicates little-endian byte ordering.
- **service\_context** contains any ORB service data that needs to be sent from the client to the server.
- **status** indicates the completion status of the associated request, and also determines the contents of the body.

### 16.4.2.2 Invoke Response Body

The contents of the invoke response body depends on the value of the **status** member of the invoke response header, as well as the OMG IDL definition of the operation being invoked. Its format is one of the following:

- If the **status** value is **INVOKE\_NO\_EXCEPTION**, then the body contains the operation result value (if any), followed by all inout and out parameters, in the order in which they appear in the operation signature, from left to right.
- If the **status** value is **INVOKE\_USER\_EXCEPTION** or **INVOKE\_SYSTEM\_EXCEPTION**, then the body contains the exception, encoded as in GIOP.
- If the **status** value is **INVOKE\_LOCATION\_FORWARD**, then the body contains a new IOR containing a **TAG\_INTERNET\_IOP** or **TAG\_MULTIPLE\_COMPONENTS** profile whose components can be used to communicate with the object specified in the invoke request message<sup>7</sup>. This profile must provide at least one new DCE-CIOP binding component. The client ORB is responsible for resending the request to the server identified by the new profile. This operation should be transparent to the client program making the request. See “DCE-CIOP Object Location” on page 16-21 for more details.
- If the **status** value is **INVOKE\_TRY\_AGAIN**, then the body is empty and the client should reissue the **invoke** RPC, possibly after a short delay<sup>8</sup>.

### 16.4.3 DCE-CIOP Locate Request Message

Locate request messages may be sent from a client to a server, as the **request\_message** parameter of a **locate** RPC, to determine the following regarding a specified object reference:

- Whether the object reference is valid.
- Whether the current server is capable of directly receiving requests for the object reference.
- If not capable, to solicit an address to which requests for the object reference should be sent.

For details on the usage of the **locate** RPC, see Section 16.6, “DCE-CIOP Object Location,” on page 16-21.

Locate request messages contain a fixed-format header, but no body.

#### 16.4.3.1 Locate Request Header

DCE-CIOP locate request headers have the following format:

```
module DCE_CIOP { // IDL
 struct LocateRequestHeader {
 boolean byte_order;
```

<sup>7</sup>Previous revisions of DCE-CIOP returned a MultipleComponentProfile structure. An IOR is now returned to allow either a TAG\_INTERNET\_IOP or a TAG\_MULTIPLE\_COMPONENTS profile to be used.

<sup>8</sup>An exponential back-off algorithm is recommended, but not required.

```

 sequence <octet> object_key;
 string operation;

 // no body follows
 };
};

```

The members have the following definitions:

- **byte\_order** indicates the byte ordering used in the representation of the remainder of the message. A value of FALSE indicates big-endian byte ordering, and TRUE indicates little-endian byte ordering.
- **object\_key** contains opaque data used to identify the object that is the target of the operation. Its value is obtained from the **object\_key** field of the **TAG\_INTERNET\_IOP** profile or the **TAG\_COMPLETE\_OBJECT\_KEY** component of the **TAG\_MULTIPLE\_COMPONENTS** profile.
- **operation** contains the name of the CORBA operation being invoked. It is encoded as in the invoke request header.

#### 16.4.4 DCE-CIOP Locate Response Message

Locate response messages are sent from servers to clients as the **response\_message** parameter of a **locate** RPC. They consist of a fixed-format header, and a body whose format depends on information in the header.

##### 16.4.4.1 Locate Response Header

DCE-CIOP locate response headers have the following format:

```

module DCE_CIOP {
 enum LocateResponseStatus {
 LOCATE_UNKNOWN_OBJECT,
 LOCATE_OBJECT_HERE,
 LOCATE_LOCATION_FORWARD,
 LOCATE_TRY_AGAIN
 };
 struct LocateResponseHeader {
 boolean byte_order;
 LocateResponseStatus status;

 // if status = LOCATE_LOCATION_FORWARD, an
 // IOP::IOR follows
 };
};

```

The members have the following definitions:

- **byte\_order** indicates the byte ordering used in the representation of the remainder of the message. A value of FALSE indicates big-endian byte ordering, and TRUE indicates little-endian byte ordering.

- **status** indicates whether the object is valid and whether it is located in this server. It determines the contents of the body.

#### 16.4.4.2 *Locate Response Body*

The contents of the locate response body depends on the value of the **status** member of the locate response header. Its format is one of the following:

- If the **status** value is `LOCATE_UNKNOWN_OBJECT`, then the object specified in the corresponding locate request message is unknown to the server. The locate reply body is empty in this case.
- If the **status** value is `LOCATE_OBJECT_HERE`, then this server (the originator of the locate response message) can directly receive requests for the specified object. The locate response body is also empty in this case.
- If the **status** value is `LOCATE_LOCATION_FORWARD`, then the locate response body contains a new IOR containing a **TAG\_INTERNET\_IOP** or **TAG\_MULTIPLE\_COMPONENTS** profile whose components can be used to communicate with the object specified in the locate request message. This profile must provide at least one new DCE-CIOP binding component.
- If the status value is `LOCATE_TRY_AGAIN`, the locate response body is empty and the client should reissue the **locate** RPC, possibly after a short delay<sup>9</sup>.

### 16.5 *DCE-CIOP Object References*

The information necessary to invoke operations on objects using DCE-CIOP is encoded in an IOR in a profile identified either by **TAG\_INTERNET\_IOP** or by **TAG\_MULTIPLE\_COMPONENTS**. The **profile\_data** for the **TAG\_INTERNET\_IOP** profile is a CDR encapsulation of the **IIOP::ProfileBody\_1\_1** type, described in Section 15.7.2, “IIOP IOR Profiles,” on page 15-52. The **profile\_data** for the **TAG\_MULTIPLE\_COMPONENTS** profile is a CDR encapsulation of the **MultipleComponentProfile** type, which is a sequence of **TaggedComponent** structures, described in Section 13.6, “An Information Model for Object References,” on page 13-14.

DCE-CIOP defines a number of IOR components that can be included in either profile. Each is identified by a unique tag, and the encoding and semantics of the associated **component\_data** are specified.

Either IOR profile can contain components for other protocols in addition to DCE-CIOP, and can contain components used by other kinds of ORB services. For example, an ORB vendor can define its own private components within this profile to support the vendor’s native protocol. Several of the components defined for DCE-CIOP may be of use to other protocols as well. The following component descriptions will note whether

---

<sup>9</sup>.An exponential back-off algorithm is recommended, but not required.

the component is intended solely for DCE-CIOP or can be used by other protocols, whether the component is required or optional for DCE-CIOP, and whether more than one instance of the component can be included in a profile.

A conforming implementation of DCE-CIOP is only required to generate and recognize the components defined here. Unrecognized components should be preserved but ignored. Implementations should also be prepared to encounter profiles identified by **TAG\_INTERNET\_IOP** or by **TAG\_MULTIPLE\_COMPONENTS** that do not support DCE-CIOP.

### 16.5.1 DCE-CIOP String Binding Component

A DCE-CIOP string binding component, identified by **TAG\_DCE\_STRING\_BINDING**, contains a fully or partially bound string binding. A string binding provides the information necessary for DCE-RPC to establish communication with a server process that can either service the client's requests itself, or provide the location of another process that can. The DCE API routine **rpc\_binding\_from\_string\_binding** can be used to convert a string binding to the DCE binding handle required to communicate with a server as described in Section 16.3, "DCE-CIOP Message Transport," on page 16-5.

This component is intended to be used only by DCE-CIOP. At least one string binding or binding name component must be present for an IOR profile to support DCE-CIOP.

Multiple string binding components can be included in a profile to define endpoints for different DCE protocols, or to identify multiple servers or agents capable of servicing the request.

The string binding component is defined as follows:

```

module DCE_CIOP { \\ IDL
 const IOP::ComponentId TAG_DCE_STRING_BINDING = 100;
};

```

A **TaggedComponent** structure is built for the string binding component by setting the tag member to **TAG\_DCE\_STRING\_BINDING** and setting the **component\_data** member to the value of a DCE string binding. The string is represented directly in the sequence of octets, including the terminating NUL, without further encoding.

The format of a string binding is defined in Chapter 3 of the OSF *AES/Distributed Computing RPC Volume*. The DCE API function **rpc\_binding\_from\_string\_binding** converts a string binding into a binding handle that can be used by a client ORB as the first parameter to the **invoke** and **locate** RPCs.

A string binding contains:

- A protocol sequence
- A network address
- An optional endpoint

- An optional object UUID

DCE object UUIDs are used to identify server process endpoints, which can each support any number of CORBA objects. DCE object UUIDs do not necessarily correspond to individual CORBA objects.

A partially bound string binding does not contain an endpoint. Since the DCE-RPC run-time uses an endpoint mapper to complete a partial binding, and multiple ORB servers might be located on the same host, partially bound string bindings must contain object UUIDs to distinguish different endpoints at the same network address.

### 16.5.2 DCE-CIOP Binding Name Component

A DCE-CIOP binding name component is identified by **TAG\_DCE\_BINDING\_NAME**. It contains a name that can be used with a DCE nameservice such as CDS or GDS to obtain the binding handle needed to communicate with a server process.

This component is intended for use only by DCE-CIOP. Multiple binding name components can be included to identify multiple servers or agents capable of handling a request. At least one binding name or string binding component must be present for a profile to support DCE-CIOP.

The binding name component is defined by the following OMG IDL:

```

module DCE_CIOP {
 const IOP::ComponentId TAG_DCE_BINDING_NAME = 101;

 struct BindingNameComponent {
 unsigned long entry_name_syntax;
 string entry_name;
 string object_uuid;
 };
};

```

A **TaggedComponent** structure is built for the binding name component by setting the tag member to **TAG\_DCE\_BINDING\_NAME** and setting the **component\_data member** to a CDR encapsulation of a **BindingNameComponent** structure.

#### 16.5.2.1 BindingNameComponent

The **BindingNameComponent** structure contains the information necessary to query a DCE nameservice such as CDS. A client ORB can use the **entry\_name\_syntax**, **entry\_name**, and **object\_uuid** members of the **BindingName** structure with the **rpc\_ns\_binding\_import\_\*** or **rpc\_ns\_binding\_lookup\_\*** families of DCE API routines to obtain binding handles to communicate with a server. If the **object\_uuid** member is an empty string, a nil object UUID should be passed to these DCE API routines.



### 16.5.3 DCE-CIOP No Pipes Component

The optional component identified by **TAG\_DCE\_NO\_PIPES** indicates to an ORB client that the server does not support the **dce\_ciop\_pipe** DCE-RPC interface. It is only a hint, and can be safely ignored. As described in Section 16.3, “DCE-CIOP Message Transport,” on page 16-5, the client must fall back to the array-based interface if the pipe-based interface is not available in the server.

```
module DCE_CIOP {
 const IOP::ComponentId TAG_DCE_NO_PIPES = 102;
};
```

A **TaggedComponent** structure with a **tag** member of **TAG\_DCE\_NO\_PIPES** must have an empty **component\_data** member.

This component is intended for use only by DCE-CIOP, and a profile should not contain more than one component with this tag.

### 16.5.4 Complete Object Key Component

An IOR profile supporting DCE-CIOP must include an object key that identifies the object the IOR represents. The object key is an opaque sequence of octets used as the **object\_key** member in invoke and locate request message headers. In a **TAG\_INTERNET\_IOP** profile, the **object\_key** member of the **IOP::ProfileBody\_1\_1** structure is used. In a **TAG\_MULTIPLE\_COMPONENTS** profile supporting DCE-CIOP<sup>10</sup>, a single **TAG\_COMPLETE\_OBJECT\_KEY** component must be included to identify the object.

The **TAG\_COMPLETE\_OBJECT\_KEY** component is available for use by all protocols that use the **TAG\_MULTIPLE\_COMPONENTS** profile. By sharing this component, protocols can avoid duplicating object identity information. This component should never be included in a **TAG\_INTERNET\_IOP** profile.

```
module IOP {
 const ComponentId TAG_COMPLETE_OBJECT_KEY = 5;
}; // IDL
```

The sequence of octets comprising the **component\_data** of this component is not interpreted by the client process. Its format only needs to be understood by the server process and any location agent that it uses.

---

<sup>10</sup>.Previous DCE-CIOP revisions used a different component.

### 16.5.5 Endpoint ID Position Component

An optional endpoint ID position component can be included in IOR profiles to enable client ORBs to minimize resource utilization and to avoid redundant locate messages. It can be used by other protocols as well as by DCE-CIOP. No more than one endpoint ID position component can be included in a profile.

```

module IOP { // IDL
 const ComponentId TAG_ENDPOINT_ID_POSITION = 6;

 struct EndpointIdPositionComponent {
 unsigned short begin;
 unsigned short end;
 };
};

```

An endpoint ID position component, identified by **TAG\_ENDPOINT\_ID\_POSITION**, indicates the portion of the profile's object key that identifies the endpoint at which operations on an object can be invoked. The **component\_data** is a CDR encapsulation of an **EndpointIdPositionComponent** structure. The **begin** member of this structure specifies the index in the object key of the first octet of the endpoint ID. The **end** member specifies the index of the last octet of the endpoint ID. An index value of zero specifies the first octet of the object key. The value of **end** must be greater than the value of **begin**, but less than the total number of octets in the object key. The endpoint ID is made up of the octets located between these two indices inclusively.

The endpoint ID should be unique within the domain of interoperability. A binary or stringified UUID is recommended.

If multiple objects have the same endpoint ID, they can be messaged to at a single endpoint, avoiding the need to locate each object individually. DCE-CIOP clients can use a single binding handle to invoke requests on all of the objects with a common endpoint ID. See Section 16.6.4, "Use of the Location Policy and the Endpoint ID," on page 16-24.

### 16.5.6 Location Policy Component

An optional location policy component can be included in IOR profiles to specify when a DCE-CIOP client ORB should perform a **locate** RPC before attempting to perform an **invoke** RPC. No more than one location policy component should be included in a profile, and it can be used by other protocols that have location algorithms similar to DCE-CIOP.

```

module IOP { // IDL
 const ComponentId TAG_LOCATION_POLICY = 12;

 // IDL does not support octet constants
 #define LOCATE_NEVER = 0
 #define LOCATE_OBJECT = 1

```

```

#define LOCATE_OPERATION = 2
#define LOCATE_ALWAYS = 3
};

```

A **TaggedComponent** structure for a location policy component is built by setting the tag member to **TAG\_LOCATION\_POLICY** and setting the **component\_data** member to a sequence containing a single octet, whose value is **LOCATE\_NEVER**, **LOCATE\_OBJECT**, **LOCATE\_OPERATION**, or **LOCATE\_ALWAYS**.

If a location policy component is not present in a profile, the client should assume a location policy of **LOCATE\_OBJECT**.

A client should interpret the location policy as follows:

- **LOCATE\_NEVER** - Perform only the **invoke** RPC. No **locate** RPC is necessary.
- **LOCATE\_OBJECT** - Perform a **locate** RPC once per object. The **operation** member of the locate request message will be ignored.
- **LOCATE\_OPERATION** - Perform a separate **locate** RPC for each distinct operation on the object. This policy can be used when different methods of an object are located in different processes.
- **LOCATE\_ALWAYS** - Perform a separate **locate** RPC for each invocation on the object. This policy can be used to support server-per-method activation.

The location policy is a hint that enables a client to avoid unnecessary **locate** RPCs and to avoid **invoke** RPCs that return **INVOKE\_LOCATION\_FORWARD** status. It is not needed to provide correct semantics, and can be ignored. Even when this hint is utilized, an **invoke** RPC might result in an **INVOKE\_LOCATION\_FORWARD** response. See Section 16.6, “DCE-CIOP Object Location,” on page 16-21 for more details.

A client does not need to implement all location policies to make use of this hint. A location policy with a higher value can be substituted for one with a lower value. For instance, a client might treat **LOCATE\_OPERATION** as **LOCATE\_ALWAYS** to avoid having to keep track of binding information for each operation on an object.

When combined with an endpoint ID component, a location policy of **LOCATE\_OBJECT** indicates that the client should perform a **locate** RPC for the first object with a particular endpoint ID, and then just perform an **invoke** RPC for other objects with the same endpoint ID. When a location policy of **LOCATE\_NEVER** is combined with an endpoint ID component, only **invoke** RPCs need be performed. The **LOCATE\_ALWAYS** and **LOCATE\_OPERATION** policies should not be combined with an endpoint ID component in a profile.

## 16.6 DCE-CIOP Object Location

This section describes how DCE-CIOP client ORBs locate the server ORBs that can perform operations on an object via the **invoke** RPC.

### 16.6.1 Location Mechanism Overview

DCE-CIOP is defined to support object migration and location services without dictating the existence of specific ORB architectures or features. The protocol features are based on the following observations:

- A given transport address does not necessarily correspond to any specific ORB architectural component (such as an object adapter, server process, ORB process, locator, etc.). It merely implies the existence of some agent to which requests may be sent.
- The “agent” (receiver of an RPC) may have one of the following roles with respect to a particular object reference:
  - The agent may be able to accept object requests directly for the object and return replies. The agent may or may not own the actual object implementation; it may be a gateway that transforms the request and passes it on to another process or ORB. From DCE-CIOP’s perspective, it is only important that invoke request messages can be sent directly to the agent.
  - The agent may not be able to accept direct requests for any objects, but acts instead as a location service. Any invoke request messages sent to the agent would result in either exceptions or replies with **INVOKE\_LOCATION\_FORWARD** status, providing new addresses to which requests may be sent. Such agents would also respond to locate request messages with appropriate locate response messages.
  - The agent may directly respond to some requests (for certain objects) and provide forwarding locations for other objects.
  - The agent may directly respond to requests for a particular object at one point in time, and provide a forwarding location at a later time.
- Server ORBs are not required to implement location forwarding mechanisms. An ORB can be implemented with the policy that servers either support direct access to an object, or return exceptions. Such a server ORB would always return locate response messages with either **LOCATE\_OBJECT\_HERE** or **LOCATE\_UNKNOWN\_OBJECT** status, and never **LOCATE\_LOCATION\_FORWARD** status. It would also never return invoke response messages with **INVOKE\_LOCATION\_FORWARD** status.
- Client ORBs must, however, be able to accept and process invoke response messages with **INVOKE\_LOCATION\_FORWARD** status, since any server ORB may choose to implement a location service. Whether a client ORB chooses to send locate request messages is at the discretion of the client.
- Client ORBs that send locate request messages can use the location policy component found in DCE-CIOP IOR profiles to decide whether to send a locate request message before sending an invoke request message. See Section 16.5.6, “Location Policy Component,” on page 16-20. This hint can be safely ignored by a client ORB.

- A client should not make any assumptions about the longevity of addresses returned by location forwarding mechanisms. If a binding handle based on location forwarding information is used successfully, but then fails, subsequent attempts to send requests to the same object should start with the original address specified in the object reference.

In general, the use of location forwarding mechanisms is at the discretion of ORBs, available to be used for optimization and to support flexible object location and migration behaviors.

### 16.6.2 Activation

Activation of ORB servers is transparent to ORB clients using DCE-CIOP. Unless an IOR refers to a transient object, the agent addressed by the IOR profile should either be permanently active, or should be activated on demand by DCE's endpoint mapper.

The current DCE endpoint mapper, `rpcd`, does not provide activation. In ORB server environments using `rpcd`, the agent addressed by an IOR must not only be capable of locating the object, it must also be able to activate it if necessary. A future DCE endpoint mapper may provide automatic activation, but client ORB implementations do not need to be aware of this distinction.

### 16.6.3 Basic Location Algorithm

ORB clients can use the following algorithm to locate the server capable of handling the **invoke** RPC for a particular operation:

1. Pick a profile with **TAG\_INTERNET\_IOP** or **TAG\_MULTIPLE\_COMPONENTS** from the IOR. Make this the *original* profile and the *current* profile. If no profiles with either tag are available, operations cannot be invoked using DCE-CIOP with this IOR.
2. Get a binding handle to try from the *current* profile. See Section 16.5.1, "DCE-CIOP String Binding Component," on page 16-17 and Section 16.5.2, "DCE-CIOP Binding Name Component," on page 16-18. If no binding handles can be obtained, the server cannot be located using the *current* profile, so go to step 1.
3. Perform either a **locate** or **invoke** RPC using the object key from the *current* profile.
  - If the RPC fails, go to step 2 to try a different binding handle.
  - If the RPC returns **INVOKE\_TRY\_AGAIN** or **LOCATE\_TRY\_AGAIN**, try the same RPC again, possibly after a delay.
  - If the RPC returns either **INVOKE\_LOCATION\_FORWARD** or **LOCATE\_LOCATION\_FORWARD**, make the new IOR profile returned in the response message body the *current* profile and go to step 2.
  - If the RPC returns **LOCATE\_UNKNOWN\_OBJECT**, and the *original* profile was used, the object no longer exists.
  - Otherwise, the server has been successfully located.

Any **invoke** RPC might return **INVOKE\_LOCATION\_FORWARD**, in which case the client ORB should make the returned profile the *current* profile, and re-enter the location algorithm at step 2.

If an RPC on a binding handle fails after it has been used successfully, the client ORB should start over at step 1.

#### 16.6.4 Use of the Location Policy and the Endpoint ID

The algorithm above will allow a client ORB to successfully locate a server ORB, if possible, so that operations can be invoked using DCE-CIOP. But unnecessary **locate** RPCs may be performed, and **invoke** RPCs may be performed when **locate** RPCs would be more efficient. The optional location policy and endpoint ID position components can be used by the client ORB, if present in the IOR profile, to optimize this algorithm.

##### 16.6.4.1 Current location policy

The client ORB can decide whether to perform a **locate** RPC or an **invoke** RPC in step 3 based on the location policy of the *current* IOR profile. If the *current* profile has a **TAG\_LOCATION\_POLICY** component with a value of **LOCATE\_NEVER**, the client should perform an **invoke** RPC. Otherwise, it should perform a **locate** RPC.

##### 16.6.4.2 Original location policy

The client ORB can use the location policy of the *original* IOR profile as follows to determine whether it is necessary to perform the location algorithm for a particular invocation:

- **LOCATE\_OBJECT** or **LOCATE\_NEVER** - A binding handle previously used successfully to invoke an operation on an object can be reused for all operations on the same object. The client only needs to perform the location algorithm once per object.
- **LOCATE\_OPERATION** - A binding handle previously used successfully to invoke an operation on an object can be reused for that same operation on the same object. The client only needs to perform the location algorithm once per operation.
- **LOCATE\_ALWAYS** - Binding handles should not be reused. The client needs to perform the location algorithm once per invocation.

##### 16.6.4.3 Original Endpoint ID

If a component with **TAG\_ENDPOINT\_ID\_POSITION** is present in the *original* IOR profile, the client ORB can reuse a binding handle that was successfully used to perform an operation on another object with the same endpoint ID. The client only needs to perform the location algorithm once per endpoint.

An endpoint ID position component should never be combined in the same profile with a location policy of **LOCATE\_OPERATION** or **LOCATE\_ALWAYS**.

## 16.7 *OMG IDL for the DCE CIOP Module*

This section shows the **DCE\_CIOP** module and **DCE\_CIOP** additions to the **IOP** module.

```

module DCE_CIOP {
 struct InvokeRequestHeader {
 boolean byte_order;
 IOP::ServiceContextList service_context;
 sequence <octet> object_key;
 string operation;
 CORBA::Principal principal;

 // in and inout parameters follow
 };

 enum InvokeResponseStatus {
 INVOKE_NO_EXCEPTION,
 INVOKE_USER_EXCEPTION,
 INVOKE_SYSTEM_EXCEPTION,
 INVOKE_LOCATION_FORWARD,
 INVOKE_TRY_AGAIN
 };
 struct InvokeResponseHeader {
 boolean byte_order;
 IOP::ServiceContextList service_context;
 InvokeResponseStatus status;

 // if status = INVOKE_NO_EXCEPTION,
 // result then inouts and outs follow

 // if status = INVOKE_USER_EXCEPTION or
 // INVOKE_SYSTEM_EXCEPTION, an exception follows

 // if status = INVOKE_LOCATION_FORWARD, an
 // IOP::IOR follows
 };
 struct LocateRequestHeader {
 boolean byte_order;
 sequence <octet> object_key;
 string operation;

 // no body follows
 };

 enum LocateResponseStatus {
 LOCATE_UNKNOWN_OBJECT,
 LOCATE_OBJECT_HERE,
 LOCATE_LOCATION_FORWARD,
 LOCATE_TRY_AGAIN
 };

```

```
};
struct LocateResponseHeader {
 boolean byte_order;
 LocateResponseStatus status;

 // if status = LOCATE_LOCATION_FORWARD, an
 // IOP::IOR follows
};

const IOP::ComponentId TAG_DCE_STRING_BINDING = 100;

const IOP::ComponentId TAG_DCE_BINDING_NAME = 101;

struct BindingNameComponent {
 unsigned long entry_name_syntax;
 string entry_name;
 string object_uuid;
};

 const IOP::ComponentId TAG_DCE_NO_PIPES = 102;
};

module IOP {
 const ComponentId TAG_COMPLETE_OBJECT_KEY = 5;

 const ComponentId TAG_ENDPOINT_ID_POSITION = 6;

 struct EndpointIdPositionComponent {
 unsigned short begin;
 unsigned short end;
 };

 const ComponentId TAG_LOCATION_POLICY = 12;

 // IDL does not support octet constants
 #define LOCATE_NEVER 0
 #define LOCATE_OBJECT 1
 #define LOCATE_OPERATION 2
 #define LOCATE_ALWAYS 3
};
```

## 16.8 References for this Chapter

*AES/Distributed Computing RPC Volume*, P T R Prentice Hall, Englewood Cliffs, New Jersey, 1994

*CAE Specification C309 X/Open DCE: Remote Procedure Call*, X/Open Company Limited, Reading, UK



The Interworking chapters describe a specification for communication between two similar but very distinct object management systems: Microsoft's COM (including OLE) and the OMG's CORBA. An optimal specification would allow objects from either system to make their key functionality visible to clients using the other system as transparently as possible. The architecture for Interworking is designed to meet this goal.

## *Contents*

This chapter contains the following sections.

| <b>Section Title</b>                       | <b>Page</b> |
|--------------------------------------------|-------------|
| "Purpose of the Interworking Architecture" | 17-2        |
| "Interworking Object Model"                | 17-3        |
| "Interworking Mapping Issues"              | 17-8        |
| "Interface Mapping"                        | 17-8        |
| "Interface Composition Mappings"           | 17-11       |
| "Object Identity, Binding, and Life Cycle" | 17-18       |
| "Interworking Interfaces"                  | 17-23       |
| "Distribution"                             | 17-32       |
| "Interworking Targets"                     | 17-34       |
| "Compliance to COM/CORBA Interworking"     | 17-34       |

## 17.1 *Purpose of the Interworking Architecture*

The purpose of the Interworking architecture is to specify support for two-way communication between CORBA objects and COM objects. The goal is that objects from one object model should be able to be viewed as if they existed in the other object model. For example, a client working in a CORBA model should be able to view a COM object as if it were a CORBA object. Likewise, a client working in a COM object model should be able to view a CORBA object as if it were a COM object.

There are many similarities between the two systems. In particular, both are centered around the idea that an object is a discrete unit of functionality that presents its behavior through a set of fully-described interfaces. Each system hides the details of implementation from its clients. To a large extent COM and CORBA are semantically isomorphic. Much of the COM/CORBA Interworking specification simply involves a mapping of the syntax, structure and facilities of each to the other — a straightforward task.

There are, however, differences in the CORBA and COM object models. COM and CORBA each have a different way of describing what an object is, how it is typically used, and how the components of the object model are organized. Even among largely isomorphic elements, these differences raise a number of issues as to how to provide the most transparent mapping.

### 17.1.1 *Comparing COM Objects to CORBA Objects*

From a COM point of view, an object is typically a subcomponent of an application, which represents a point of exposure to other parts of the application, or to other applications. Many OLE objects are document-centric and are often (though certainly not exclusively) tied to some visual presentation metaphor. Historically, the typical domain of a COM object is a single-user, multitasking visual desktop such as a Microsoft Windows desktop. Currently, the main goal of COM and OLE is to expedite collaboration- and information-sharing among applications using the same desktop, largely through user manipulation of visual elements (for example, drag-and-drop, cut-and-paste).

From a CORBA point of view, an object is an independent component providing a related set of behaviors. An object is expected to be available transparently to any CORBA client regardless of the location (or implementation) of either the object or the client. Most CORBA objects focus on distributed control in a heterogeneous environment. Historically, the typical domain of a CORBA object is an arbitrarily scalable distributed network. In its current form, the main goal of CORBA is to allow these independent components to be shared among a wide variety of applications (and other objects), any of which may be otherwise unrelated.

Of course, CORBA is already used to define desktop objects, and COM can be extended to work over a network. Also, both models are growing and evolving, and will probably overlap in functionality in the future. Therefore, a good interworking model must map the functionality of two systems to each other while preserving the flavor of each system as it is typically presented to a developer.

The most obvious similarity between these two systems is that they are both based architecturally on *objects*. The Interworking Object Model describes the overlap between the features of the CORBA and COM object models, and how the common features map between the two models.

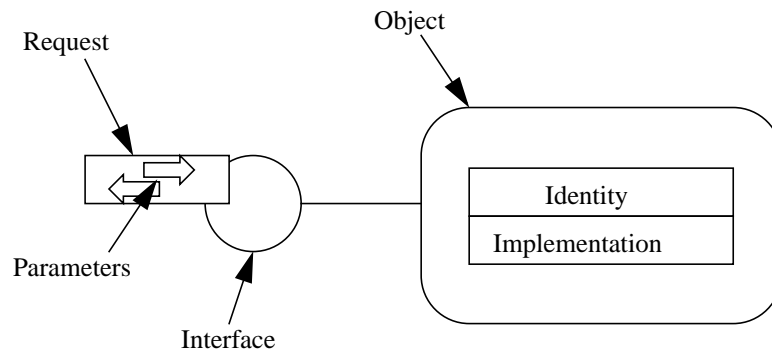

Figure 17-1 Interworking Object Model

## 17.2 Interworking Object Model

### 17.2.1 Relationship to CORBA Object Model

In the Interworking Object Model, each object is simply a discrete unit of functionality that presents itself through a published interface described in terms of a well-known, fully described set of interface semantics. An interface (and its underlying functionality) is accessed through at least one well-known, fully described form of request. Each request in turn targets a specific object—an object instance—based on a reference to its identity. That target object is then expected to service the request by invoking the expected behavior in its own particular implementation. Request parameters are object references or nonobject data values described in the object model's data type system. Interfaces may be composed by combining other interfaces according to some well-defined composition rules. In each object system, interfaces are described in a specialized language or can be represented in some repository or library.

In CORBA, the Interworking Object Model is mapped to an architectural abstraction known as the Object Request Broker (ORB). Functionally, an ORB provides for the registration of the following:

- Types and their interfaces, as described in the OMG Interface Definition Language (OMG IDL).
- Instance identities, from which the ORB can then construct appropriate references to each object for interested clients.

A CORBA object may thereafter receive requests from interested clients that hold its object reference and have the necessary information to make a properly formed request on the object's interface. This request can be statically defined at compile time or dynamically created at run-time based upon type information available through an interface type repository.

While CORBA specifies the existence of an implementation type description called `ImplementationDef` (and an `Implementation Repository`, which contains these type descriptions), CORBA does not specify the interface or characteristics of the `Implementation Repository` or the `ImplementationDef`. As such, implementation typing and descriptions vary from ORB to ORB and are not part of this specification.

### *17.2.2 Relationship to the OLE/COM Model*

In OLE, the Interworking Object Model is principally mapped to the architectural abstraction known as the Component Object Model (COM). Functionally, COM allows an object to expose its interfaces in a well-defined binary form (that is, a virtual function table) so that clients with static compile-time knowledge of the interface's structure, and with a reference to an instance offering that interface, can send it appropriate requests. Most COM interfaces are described in Microsoft Interface Definition Language (MIDL).

COM supports an implementation typing mechanism centered around the concept of a COM class. A COM class has a well-defined identity and there is a repository (known as the system registry) that maps implementations (identified by class IDs) to specific executable code units that embody the corresponding implementation realizations.

COM also provides an extension called Automation. Interfaces that are Automation-compatible can be described in Object Definition Language (ODL) and can optionally be registered in a binary Type Library. Automation interfaces can be invoked dynamically by a client having no compile-time interface knowledge through a special COM interface (`IDispatch`). Run-time type checking on invocations can be implemented when a Type Library is supplied. Automation interfaces have properties and methods, whereas COM interfaces have only methods. The data types that may be used for properties and as method parameters comprise a subset of the types supported in COM. Automation, for example, does not support user-defined constructed types such as structs or unions.

Thus, use of and interoperating with objects exposing Automation interfaces is considerably different from other COM objects. Although Automation is implemented through COM, for the purposes of this document, Automation and COM are considered to be distinct object models. Interworking between CORBA and Automation will be described separately from interworking with the basic COM model.

### *17.2.3 Basic Description of the Interworking Model*

Viewed at this very high level, Microsoft's COM and OMG's CORBA appear quite similar. Roughly speaking, COM interfaces (including Automation interfaces) are equivalent to CORBA interfaces. In addition, COM interface pointers are very roughly

equivalent to CORBA object references. Assuming that lower-level design details (calling conventions, data types, and so forth) are more or less semantically isomorphic, a reasonable level of interworking is probably possible between the two systems through straightforward mappings.

How such interworking can be practically achieved is illustrated in an Interworking Model, shown in Figure 17-2. It shows how an object in Object System B can be mapped and represented to a client in Object System A. From now on, this will be called a B/A mapping. For example, mapping a CORBA object to be visible to a COM client is a CORBA/COM mapping.

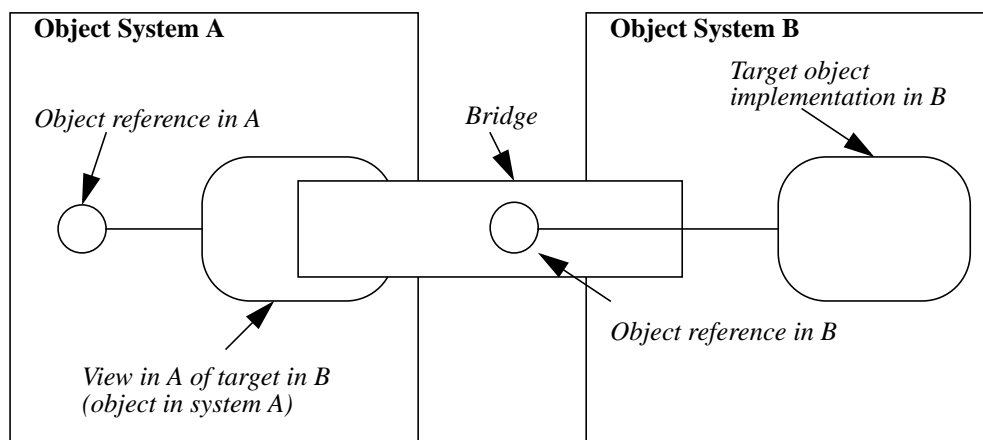

Figure 17-2 B/A Interworking Model

On the left is a client in object system A, that wants to send a request to a target object in system B, on the right. We refer to the entire conceptual entity that provides the mapping as a bridge. The goal is to map and deliver any request from the client transparently to the target.

To do so, we first provide an object in system A called a View. The View is an object in system A that presents the identity and interface of the target in system B mapped to the vernacular of system A, and is described as an A View of a B target.

The View exposes an interface, called the View Interface, which is isomorphic to the target's interface in system B. The methods of the View Interface convert requests from system A clients into requests on the target's interface in system B. The View is a component of the bridge. A bridge may be composed of many Views.

The bridge maps interface and identify forms between different object systems. Conceptually, the bridge holds a reference in B for the target (although this is not physically required). The bridge must provide a point of rendezvous between A and B, and may be implemented using any mechanism that permits communication between the two systems (IPC, RPC, network, shared memory, and so forth) sufficient to preserve all relevant object semantics.

The client treats the View as though it is the real object in system A, and makes the request in the vernacular request form of system A. The request is translated into the vernacular of object system B, and delivered to the target object. The net effect is that a request made on an interface in A is transparently delivered to the intended instance in B.

The Interworking Model works in either direction. For example, if system A is COM, and system B is CORBA, then the View is called the COM View of the CORBA target. The COM View presents the target's interface to the COM client. Similarly if system A is CORBA and system B is COM, then the View is called the *CORBA View* of the COM target. The CORBA View presents the target's interface to the CORBA client.

Figure 17-3 shows the interworking mappings discussed in the Interworking chapters. They represent the following:

- The mapping providing a COM View of a CORBA target
- The mapping providing a CORBA View of a COM target
- The mapping providing an Automation View of a CORBA target
- The mapping providing a CORBA View of an Automation target

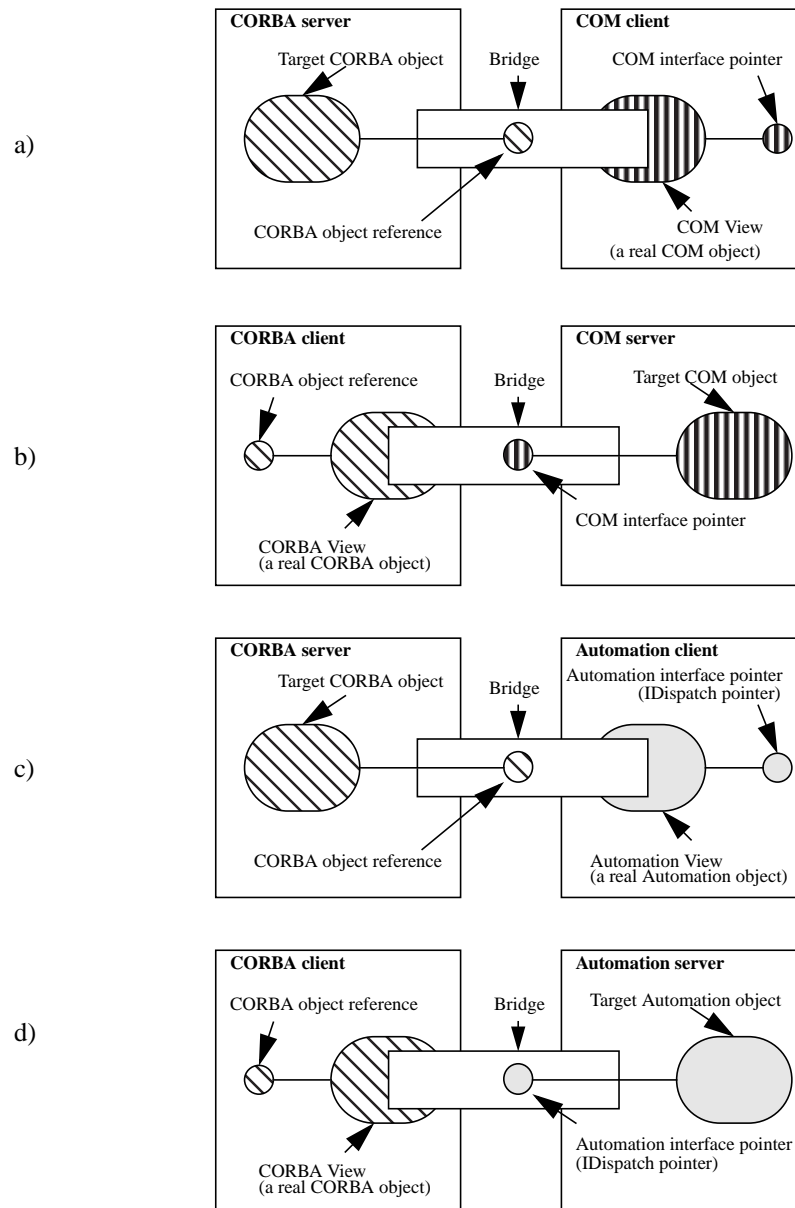

Figure 17-3 Interworking Mapping

Note that the division of the mapping process into these architectural components does not infer any particular design or implementation strategy. For example, a COM View and its encapsulated CORBA reference could be implemented in COM as a single component or as a system of communicating components on different hosts.

Likewise, Figure 17-3 does not define any particular location of the bridge. The bridge is conceptually between the two object models. The implementation of the bridge may be located on the client or the server or on an intermediate machine.

The architecture allows for a range of implementation strategies, including, but not limited to generic and interface-specific mapping.

- **Generic Mapping** assumes that all interfaces can be mapped through a dynamic mechanism supplied at run-time by a single set of bridge components. This allows automatic access to new interfaces as soon as they are registered with the target system. This approach generally simplifies installation and change management, but may incur the run-time performance penalties normally associated with dynamic mapping.
- **Interface-Specific Mapping** assumes that separate bridge components are generated for each interface or for a limited set of related interfaces (for example, by a compiler). This approach generally improves performance by “precompiling” request mappings, but may create installation and change management problems.

### 17.3 Interworking Mapping Issues

The goal of the Interworking specification is to achieve a straightforward two-way (COM/CORBA and CORBA/COM) mapping in conformance with the previously described Interworking Model. However, despite many similarities, there are some significant differences between CORBA and COM that complicate achieving this goal. The most important areas involve:

- **Interface Mapping.** A CORBA interface must be mapped to and from two distinct forms of interfaces, Automation and COM.
- **Interface Composition Mapping.** CORBA multiple inheritance must be mapped to COM single inheritance/aggregation. COM interface aggregation must be mapped to the CORBA multiple inheritance model.
- **Identity Mapping.** The explicit notion of an instance identity in CORBA must be mapped to the more implicit notion of instance identity in COM.
- **Mapping Invertibility.** It may be desirable for the object model mappings to be invertible, but the Interworking specification does not guarantee invertibility in all situations.

### 17.4 Interface Mapping

The CORBA standard for describing interfaces is OMG IDL. It describes the requests that an object supports. OLE provides two distinct and somewhat disjointed interface models: COM and Automation. Each has its own respective request form, interface semantics, and interface syntax.

Therefore, we must consider the problems and benefits of four distinct mappings:

- CORBA/COM
- CORBA/Automation
- COM/CORBA
- Automation/CORBA



We must also consider the bidirectional impact of a third, hybrid form of interface, the Dual Interface, which supports both an Automation and a COM-like interface. The succeeding sections summarize the main issues facing each of these mappings.

### 17.4.1 CORBA/COM

There is a reasonably good mapping from CORBA objects to COM Interfaces; for instance:

- OMG IDL primitives map closely to COM primitives.
- Constructed data types (structs, unions, arrays, strings, and enums) also map closely.
- CORBA object references map closely to COM interface pointers.
- Inherited CORBA interfaces may be represented as multiple COM interfaces.
- CORBA attributes may be mapped to get and set operations in COM interfaces.

This mapping is perhaps the most natural way to represent the interfaces of CORBA objects in the COM environment. In practice, however, many COM clients can only bind to Automation Interfaces and cannot bind to the more general COM Interfaces. Therefore, providing only a mapping of CORBA to the COM Interfaces would not satisfy many COM/OLE clients.

### 17.4.2 CORBA/Automation

There is a limited fit between Automation objects and CORBA objects:

- Some OMG IDL primitives map directly to Automation primitives. However, there are primitives in both systems (for example, the OLE CURRENCY type and the CORBA unsigned integral types) that must be mapped as special cases (possibly with loss of range or precision).
- OMG IDL constructed types do not map naturally to any Automation constructs. Since such constructed types cannot be passed as argument parameters in Automation interfaces, these must be simulated by providing specially constructed interfaces (for example, viewing a struct as an OLE object with its own interface).
- CORBA Interface Repositories can be mapped dynamically to Automation Type Libraries.
- CORBA object references map to Automation interface pointers.
- There is no clean mapping for multiple inheritance to Automation interfaces. All methods of the multiply-inherited interfaces could be expanded to a single Automation interface; however, this approach would require a total ordering over the methods if [dual] interfaces are to be supported. An alternative approach would be to map multiple inheritance to multiple Automation interfaces. This mapping, however, would require that an interface navigation mechanism be exposed to Automation controllers. Currently Automation does not provide a canonical way for clients (such as Visual Basic) to navigate between multiple interfaces.

- CORBA attributes may be mapped to get and put properties in Automation interfaces.

This form of interface mapping will place some restrictions on the types of argument passing that can be mapped, and/or the cost (in terms of run-time translations) incurred in those mappings. Nevertheless, it is likely to be the most popular form of CORBA-to-COM interworking, since it will provide dynamic access to CORBA objects from Visual Basic and other Automation client development environments.

### 17.4.3 COM/CORBA

This mapping is similar to CORBA/COM, except for the following:

- Some COM primitive data types (for example, UNICODE long, unsigned long long, and wide char) and constructed types (for example, wide string) are not currently supported by OMG IDL. (These data types may be added to OMG IDL in the future.)
- Some unions, pointer types and the SAFEARRAY type require special handling.

The COM/CORBA mapping is somewhat further complicated, by the following issues:

- Though it is less common, COM objects may be built directly in C and C++ (without exposing an interface specification) by providing custom marshaling implementations. If the interface can be expressed precisely in some COM formalism (MIDL, ODL, or a Type Library), it must first be hand-translated to such a form before any formal mapping can be constructed. If not, the interworking mechanism (such as the View, request transformation, and so forth) must be custom-built.
- MIDL, ODL, and Type Libraries are somewhat different, and some are not supported on certain Windows platforms; for example, MIDL is not available on Win16 platforms.

### 17.4.4 Automation/CORBA

The Automation interface model and type system are designed for dynamic scripting. The type system is a reduced set of the COM type system designed such that custom marshaling and demarshaling code is not necessary for invoking operations on interfaces.

- Automation interfaces and references (IDispatch pointers) map directly to CORBA interfaces and object references.
- Automation request signatures map directly into CORBA request signatures.
- Most of the Automation data types map directly to CORBA data types. Certain Automation types (for example, CURRENCY) do not have corresponding predefined CORBA types, but can easily be mapped onto isomorphic constructed types.
- Automation properties map to CORBA attributes.

## 17.5 Interface Composition Mappings

CORBA provides a multiple inheritance model for aggregating and extending object interfaces. Resulting CORBA interfaces are, essentially, statically defined either in OMG IDL files or in the Interface Repository. Run-time interface evolution is possible by deriving new interfaces from existing ones. Any given CORBA object reference refers to a CORBA object that exposes, at any point in time, a single most-derived interface in which all ancestral interfaces are joined. The CORBA object model does not support objects with multiple, disjoint interfaces.<sup>1</sup>

In contrast, COM objects expose aggregated interfaces by providing a uniform mechanism for navigating among the interfaces that a single object supports (that is, the `QueryInterface` method). In addition, COM anticipates that the set of interfaces that an object supports will vary at run-time. The only way to know if an object supports an interface at a particular instant is to ask the object.

Automation objects typically provide all Automation operations in a single “flattened” `IDispatch` interface. While an analogous mechanism to `QueryInterface` could be supported in Automation as a standard method, it is not the current use model for OLE Automation services.<sup>2</sup>

### 17.5.1 CORBA/COM

CORBA multiple inheritance maps into COM interfaces with some difficulty. Examination of object-oriented design practice indicates two common uses of interface inheritance, extending and mixing in. Inheritance may be used to extend an interface linearly, creating a specialization or new version of the inherited interface. Inheritance (particularly multiple inheritance) is also commonly used to mix in a new capability (such as the ability to be stored or displayed) that may be orthogonal to the object’s basic application function.

Ideally, extension maps well into a single inheritance model, producing a single linear connection of interface elements. This usage of CORBA inheritance for specialization maps directly to COM; a unique CORBA interface inheritance path maps to a single COM interface vtable that includes all of the elements of the CORBA interfaces in the inheritance path.<sup>3</sup> The use of inheritance to mix in an interface maps well into COM’s aggregation mechanism; each mixed-in inherited interface (or interface graph) maps to a separate COM interface, which can be acquired by invoking `QueryInterface` with the interface’s specific UUID.

- 
1. This is established in the CORBA specification, Chapter 1, Interfaces Section, and in the Object Management Architecture Guide, Section 4.4.7.
  2. One can use [dual] interfaces to expose multiple `IDispatch` interfaces for a given COM co-class. The “Dim A as new Z” statement in Visual Basic 4.0 can be used to invoke a `QueryInterface` for the Z interface. Many Automation controllers, however, do not use the dual interface mechanism.

Unfortunately, with CORBA multiple inheritance there is no syntactic way to determine whether a particular inherited interface is being extended or being mixed in (or used with some other possible design intent). Therefore it is not possible to make ideal mappings mechanically from CORBA multiply-inherited interfaces to collections of COM interfaces without some additional annotation that describes the intended design. Since extending OMG IDL (and the CORBA object model) to support distinctions between different uses of inheritance is undesirable, alternative mappings require arbitrary decisions about which nodes in a CORBA inheritance graph map to which aggregated COM interfaces, and/or an arbitrary ordering mechanism. The mapping described in Section 17.5.2, “Detailed Mapping Rules,” on page 17-13 for the CORBA->MIDL Transformation, describes a compromise that balances the need to preserve linear interface extensions with the need to keep the number of resulting COM interfaces manageably small. It satisfies the primary requirement for interworking in that it describes a uniform, deterministic mapping from any CORBA inheritance graph to a composite set of COM interfaces.

### *17.5.1.1 COM/CORBA*

The features of COM’s interface aggregation model can be preserved in CORBA by providing a set of CORBA interfaces that can be used to manage a collection of multiple CORBA objects with different disjoint interfaces as a single composite unit. The mechanism described in OMG IDL in Section 17.4, “Interface Mapping,” on page 17-8, is sufficiently isomorphic to allow composite COM interfaces to be uniformly mapped into composite OMG IDL interfaces with no loss of capability.

### *17.5.1.2 CORBA/Automation*

OLE Automation (as exposed through the IDispatch interface) does not rely on ordering in a virtual function table. The target object implements the IDispatch interface as a mini interpreter and exposes what amounts to a flattened single interface for all operations exposed by the object. The object is not required to define an ordering of the operations it supports.

An ordering problem still exists, however, for dual interfaces. Dual interfaces are COM interfaces whose operations are restricted to the Automation data types. Since these are COM interfaces, the client can elect to call the operations directly by mapping the operation to a predetermined position in a function dispatch table. Since the interpreter is being bypassed, the same ordering problems discussed in the previous section apply for OLE Automation dual interfaces.

- 
3. An ordering is needed over the CORBA operations in an interface to provide a deterministic mapping from the OMG IDL interface to a COM vtable. The current ordering is to sort the operations based on the byte-by-byte comparison of the ISO-Latin-1 encoding values of their respective names (e.g., operation ‘A’ comes before operation ‘B’).

### 17.5.1.3 Automation/CORBA

Automation interfaces are simple collections of operations, with no inheritance or aggregation issues. Each IDispatch interface maps directly to an equivalent OMG IDL-described interface.

## 17.5.2 Detailed Mapping Rules

### 17.5.2.1 Ordering Rules for the CORBA->MIDL Transformation

- Each OMG IDL interface that does not have a parent is mapped to an MIDL interface deriving from IUnknown.
- Each OMG IDL interface that inherits from a single parent interface is mapped to an MIDL interface that derives from the mapping for the parent interface.
- Each OMG IDL interface that inherits from multiple parent interfaces is mapped to an MIDL interface deriving from IUnknown.
- For each CORBA interface, the mapping for operations precede the mapping for attributes.
- The resulting mapping of operations within an interface are ordered based upon the operation name. The current ordering is to sort the operations based on the byte-by-byte comparison of the ISO-Latin-1 encoding values of their respective names (e.g., operation 'A' comes before operation 'B.')
- Similarly, the resulting mapping of attributes within an interface are ordered based upon the ISO-Latin-1 encoding of attribute name. If the attribute is not read-only, the get <attribute name> method immediately precedes the set <attribute name> method.

### 17.5.2.2 Ordering Rules for the CORBA->Automation Transformation

- Each OMG IDL interface that does not have a parent is mapped to an ODL interface deriving from IDispatch.
- Each OMG IDL interface that inherits from a single parent interface is mapped to an ODL interface that derives from the mapping for the parent interface.
- Each OMG IDL interface that inherits from multiple parent interfaces is mapped to an ODL interface, which derives using single inheritance from the mapping for the first parent interface. The first parent interface is defined as the first interface when the immediate parent interfaces are sorted based upon interface idname. The names are put in ascending order based upon the byte-by-byte comparison of ISO-Latin-1 encoding values of the interface names (for example, interface 'AZ' comes before interface 'BA').
- Within an interface, the mapping for operations precede the mapping for attributes.
- An OMG IDL interface's operations are ordered in the resulting mapping based upon the operation name. The operations are put in ascending order based upon the ISO-Latin-1 encoding values of the operation names.

- Similarly, the mapping of an OMG IDL interface's attributes are ordered in the resulting mapping based upon the byte-by-byte comparison of the ISO-Latin-1 encoding of the attribute name. For non-read-only attributes, the [propget] method immediately precedes the [propput] method.
- For OMG IDL interfaces that multiply inherit from parent interfaces, the new interface is mapped as deriving from the mapping of its first parent.
  - Then for each subsequent parent interface, the new interface will repeat the mapping of all operations and attributes of that parent excluding any operations or attributes that have already been mapped; that is, these operations/attributes are grouped per interface and each group is internally ordered using the rules described above.
  - After all the parent interfaces are mapped, the new operations and attributes that were introduced in the new interface are then mapped using the ordering rules for operations and attributes.

### 17.5.3 Example of Applying Ordering Rules

Consider the OMG IDL description shown in Figure 17-4.

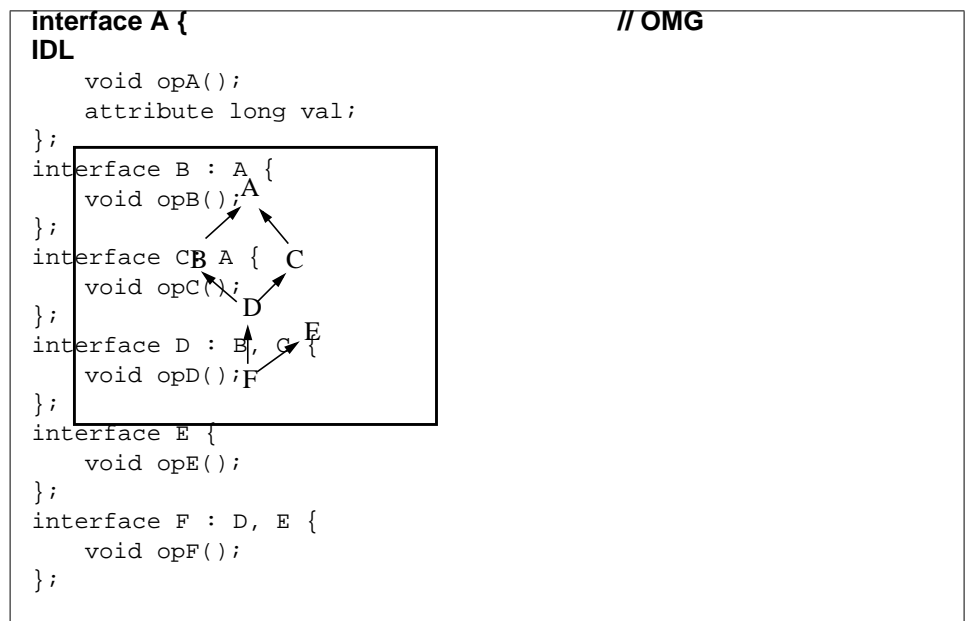

Figure 17-4 OMG IDL Description with Multiple Inheritance

Following the rules in Section 17.5.2, “Detailed Mapping Rules,” on page 17-13 the interface description would map to the Microsoft MIDL definition shown in Figure 17-5 and would map to the ODL definition shown in Figure 17-6.

```

[object, uuid(7fc56270-e7a7-0fa8-1d59-35b72eacbe29)]
interface IA : IUnknown{ // Microsoft MIDL
 HRESULT opA();
 HRESULT get_val([out] long * val);
 HRESULT set_val([in] long val);
};
[object, uuid(9d5ed678-fe57-bcca-1d41-40957afab571)]
interface IB : IA {
 HRESULT opB();
};
[object, uuid(0d61f837-0cad-1d41-1d40-b84d143e1257)]
interface IC: IA {
 HRESULT opC();
};
[object, uuid(f623e75a-f30e-62bb-1d7d-6df5b50bb7b5)]
interface ID : IUnknown {
 HRESULT opD();
};
[object, uuid(3a3ea00c-fc35-332c-1d76-e5e9a32e94da)]
interface IE : IUnknown{
 HRESULT opE();
};
[object, uuid(80061894-3025-315f-1d5e-4e1f09471012)]
interface IF : IUnknown {
 HRESULT opF();
};

```

```

IU IU IU IU IU
↑ ↑ ↑ ↑ ↑
A A D E F
↑ ↑
B C

```

Figure 17-5 MIDL Description

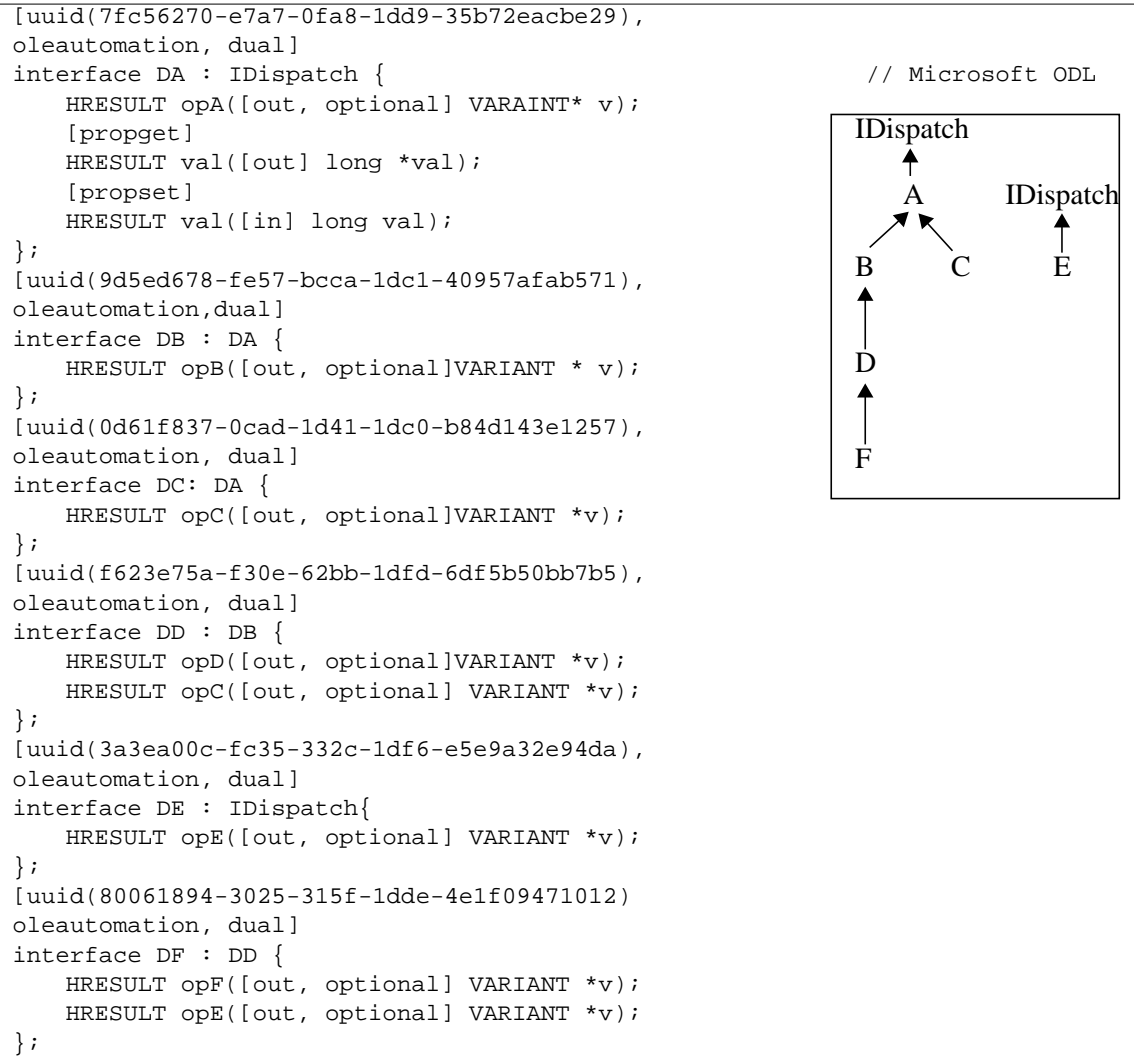

Figure 17-6 Example: ODL Mapping for Multiple Inheritance

#### 17.5.4 Mapping Interface Identity

This specification enables interworking solutions from different vendors to interoperate across client/server boundaries (for example, a COM View created by product A can invoke a CORBA server created with product B, given that they both share the same IDL interface). To interoperate in this way, all COM Views mapped from a particular CORBA interface must share the same COM Interface IDs. This section describes a uniform mapping from CORBA Interface Repository IDs to COM Interface IDs.



### 17.5.4.1 Mapping Interface Repository IDs to COM IIDs

A CORBA Repository ID is mapped to a corresponding COM Interface ID using a derivative of the RSA Data Security, Inc. MD5 Message-Digest algorithm.<sup>4,5</sup> The repository ID of the CORBA interface is fed into the MD5 algorithm to produce a 128-bit hash identifier. The least significant byte is byte 0 and the most significant byte is byte 8. The resulting 128 bits are modified as follows.

---

**Note** – The DCE UUID space is currently divided into four main groups:

byte 8 = 0xxxxxxx (the NCS1.4 name space)

10xxxxxx (A DCE 1.0 UUID name space)

110xxxxx (used by Microsoft)

1111xxxx (Unspecified)

---

For NCS1.5, the other bits in byte 8 specify a particular family. Family 29 will be assigned to ensure that the autogenerated IIDs do not interfere with other UUID generation techniques.

The upper two bits of byte 9 will be defined as follows.

**00 unspecified**

**01 generated COM IID**

**10 generated Automation IID**

**11 generated dual interface Automation ID**

---

**Note** – These bits should never be used to determine the type of interface. They are used only to avoid collisions in the name spaces when generating IIDs for multiple types of interfaces — dual, COM, or Automation.

---

The other bits in the resulting key are taken from the MD5 message digest (stored in the UUID with little endian ordering).

The IID generated from the CORBA repository ID will be used for a COM view of a CORBA interface except when the repository ID is a DCE UUID and the IID being generated is for a COM interface (not Automation or dual). In this case, the DCE UUID will be used as the IID instead of the IID generated from the repository ID (this is done to allow CORBA server developers to implement existing COM interfaces).

This mechanism requires no change to IDL. However, there is an implicit assumption that repository IDs should be unique across ORBs for different interfaces and identical across ORBs for the same interface.

---

**Note** – This assumption is also necessary for IIOP to function correctly across ORBs.

---



---

4. Rivest, R. "The MD5 Message-Digest Algorithm," RFC 1321, MIT and RSA Data Security, Inc., April 1992.

#### 17.5.4.2 Mapping COM IIDs to CORBA Interface IDs

The mapping of a COM IID to the CORBA interface ID is vendor-specific. However, the mapping should be the same as if the CORBA mapping of the COM interface were defined with the #pragma ID <interface\_name> = "DCE:...".

Thus, the MIDL definition

```
[uuid(f4f2f07c-3a95-11cf-affb-08000970dac7), object]
interface A: IUnknown {
 ...
}
```

maps to this OMG IDL definition:

```
interface A {
#pragma ID A="DCE:f4f2f07c-3a95-11cf-affb-08000970dac7"
...
};
```

### 17.6 Object Identity, Binding, and Life Cycle

The interworking model illustrated in Figure 17-2 on page 17-5 and Figure 17-3 on page 17-7 maps a View in one object system to a reference in the other system. This relationship raises questions:

- How do the concepts of object identity and object life cycle in different object models correspond, and to the extent that they differ, how can they be appropriately mapped?
- How is a View in one system bound to an object reference (and its referent object) in the other system?

- 
5. MD5 was chosen as the hash algorithm because of its uniformity of distribution of bits in the hash value and its popularity for creating unique keys for input text. The algorithm is designed such that on average, half of the output bits change for each bit change in the input. The original algorithm provides a key with uniform distribution in 128 bits. The modification used in this specification selects 118 bits. With a uniform distribution, the probability of drawing  $k$  distinct keys (using  $k$  distinct inputs) is  $n!/((n-k)!*n^k)$ , where  $n$  is the number of distinct key values (i.e.,  $n=2^{118}$ ). If a million (i.e.,  $k=10^6$ ) distinct interface repository IDs are passed through the algorithm, the probability of a collision in any of the keys is less than 1 in  $10^{23}$ .

## 17.6.1 Object Identity Issues

COM and CORBA have different notions of what object identity means. The impact of the differences between the two object models affects the transparency of presenting CORBA objects as COM objects or COM objects as CORBA objects. The following sections discuss the issues involved in mapping identities from one system to another. They also describe the architectural mechanics of identity mapping and binding.

### 17.6.1.1 CORBA Object Identity and Reference Properties

CORBA defines an object as a combination of state and a set of methods that explicitly embodies an abstraction characterized by the behavior of relevant requests. An object reference is defined as a name that reliably and consistently denotes a particular object. A useful description of a particular object in CORBA terms is an entity that exhibits a consistency of interface, behavior, and state over its lifetime. This description may fail in many boundary cases, but seems to be a reasonable statement of a common intuitive notion of object identity.

Other important properties of CORBA objects include the following:

- Objects have opaque identities that are encapsulated in object references.
- Object identities are unique within some definable reference domain, which is at least as large as the space spanned by an ORB instance.
- Object references reliably denote a particular object; that is, they can be used to identify and locate a particular object for the purposes of sending a request.
- Identities are immutable, and persist for the lifetime of the denoted object.
- Object references can be used as request targets irrespective of the denoted object's state or location; if an object is passively stored when a client makes a request on a reference to the object, the ORB is responsible for transparently locating and activating the object.
- There is no notion of "connectedness" between object reference and object, nor is there any notion of reference counting.
- Object references may be externalized as strings and reinternalized anywhere within the ORB's reference domain.
- Two object references may be tested for equivalence (that is, to determine whether both references identify the same object instance), although only a result of TRUE for the test is guaranteed to be reliable.

### 17.6.1.2 COM Object Identity and Reference Properties

The notion of what it means to be "a particular COM object" is somewhat less clearly defined than under CORBA. In practice, this notion typically corresponds to an active instance of an implementation, but not a particular persistent state. A COM instance can be most precisely defined as "the entity whose interface (or rather, one of whose interfaces) is returned by an invocation of `IClassFactory::CreateInstance`."

The following observations may be made regarding COM instances:

- COM instances are either initialized with a default “empty” state (for example, a document or drawing with no contents), or they are initialized to arbitrary states; **IClassFactory::CreateInstance** has no parameters for describing initial state.
- The only inherently available identity or reference for a COM instance is its Unknown pointer. COM specifies an invariant that two interface references refer to the same object if QueryInterface (IID IUnknown) returns the same pointer when applied to both interfaces.<sup>6</sup> Individual COM class types may establish a strong notion of persistent identity (for example, through the use of Monikers), but this is not the responsibility of the COM model itself.
- The identity and management of state are generally independent of the identity and life cycle of COM class instances. Files that contain document state are persistent, and are identified within the file system’s name space. A single COM instance of a document type may load, manipulate, and store several different document files during its lifetime; a single document file may be loaded and used by multiple COM class instances, possibly of different types. Any relationship between a COM instance and a state vector is either an artifact of a particular class’s implementation, or the user’s imagination.

## 17.6.2 Binding and Life Cycle

The identity-related issues previously discussed emerge as practical problems in defining binding and life cycle management mechanisms in the Interworking models. Binding refers to the way in which an existing object in one system can be located by clients in the other system and associated with an appropriate View. Life cycle, in this context, refers to the way objects in one system are created and destroyed by clients in the other system.

### 17.6.2.1 Lifetime Comparison

The in-memory lifetime of COM (including Automation) objects is bounded by the lifetimes of its clients. That is, in COM, when there are no more clients attached to an object, it is destroyed. COM objects are reference-counted and as such are susceptible to certain problems: most notably, circular reference counts (where two objects hold references to each other and thus neither can die) and dangling servers (where a client has crashed without releasing its references).

Detecting circular reference counts is not handled by COM and is currently left up to the application code. To help detect dangling servers, COM has added support in the infrastructure for client machines to ping server machines. If the ping is not received by the server within a negotiated time period, the client will be assumed dead and its references released.

---

6. This invariant appears to be true in DCOM as well as COM. A combination of IPID and OXID is used to create a unique identity for remote IUnknown pointers.

The CORBA Life Cycle model decouples the lifetime of the clients from the lifetime of the active (in-memory) representation of the persistent server object. The CORBA model allows clients to maintain references to CORBA server objects even when the clients are no longer running. Server objects can deactivate and remove themselves from memory whenever they become idle. This behavior allows resources (such as memory and networking addresses) to be released from active use for long-lived (but generally idle) services. The advantage of this model is that it does not require pinging or maintaining reference counts. The disadvantage is that it requires the application to explicitly decide when an object has been made obsolete and its references should become invalid. Activation and deactivation in COM can, to some degree, be accomplished using Monikers (persistent interface references). However, unlike CORBA, the client must be programmed to explicitly use this alternate form of binding to allow the server the opportunity to pacify its state.

In both the COM and CORBA lifecycle models, it is possible for a client to have an invalid reference to a server object. This can occur in COM because a server has crashed, or in CORBA because the target of the reference was explicitly destroyed. Thus, in both models, applications should be written to check for error codes indicating invalid references.

### 17.6.2.2 *Binding Existing CORBA Objects to COM Views*

COM and Automation have limited mechanisms for registering and accessing active objects. A single instance of a COM class can be registered in the active object registry. COM or Automation clients can obtain an IUnknown pointer for an active object with the COM GetActiveObject function or the Automation GetObject function. The most natural way for COM or Automation clients to access existing CORBA objects is through this (or some similar) mechanism.

Interworking solutions can, if desirable, create COM Views for any CORBA object and place them in the active object registry, so that the View (and thus, the object) can be accessed through GetActiveObject or GetObject.

The resources associated with the system registry are limited; some interworking solutions will not be able to map objects efficiently through the registry. This specification defines an interface, ICORBAFactory, which allows interworking solutions to provide alternate location and registration mechanisms<sup>7</sup> through which CORBA objects can be made available to COM and Automation clients in a way that is similar to OLE's native mechanism (GetObject). This interface is described fully in Section 17.7.3, "ICORBAFactory Interface," on page 17-24.

---

7. For example, using ICORBAFactory, an interworking solution can provide an active object registry that is distributed, federated, and fault-tolerant.

### 17.6.2.3 *Binding COM Objects to CORBA Views*

As described in Section 17.6.1, “Object Identity Issues,” on page 17-19, COM class instances are inherently transient. Clients typically manage COM and Automation objects by creating new class instances and subsequently associating them with a desired stored state. Thus, COM objects are made available through factories. The SimpleFactory OMG IDL interface (described in Section 17.7.1, “SimpleFactory Interface,” on page 17-23) is designed to map onto COM class factories, allowing CORBA clients to create (and bind to) COM objects. A single CORBA SimpleFactory maps to a single COM class factory. The manner in which a particular interworking solution maps SimpleFactories to COM class factories is not specified. Moreover, the manner in which mapped SimpleFactory objects are presented to CORBA clients is not specified.

### 17.6.2.4 *COM View of CORBA Life Cycle*

The SimpleFactory interface (Section 17.7.1, “SimpleFactory Interface,” on page 17-23) provides a create operation without parameters. CORBA SimpleFactory objects can be wrapped with COM IClassFactory interfaces and registered in the Windows registry. The process of building, defining, and registering the factory is implementation-specific.

To allow COM and Automation developers to benefit from the robust CORBA lifecycle model, the following rules apply to COM and Automation Views of CORBA objects. When a COM or Automation View of a CORBA object is dereferenced and there are no longer any clients for the View, the View may delete itself. It should not, however, delete the CORBA object that it refers to. The client of the View may call the **LifeCycleObject::remove** operation (if the interface is supported) on the CORBA object to remove it. Otherwise, the lifetime of the CORBA object is controlled by the implementation-specific lifetime management process.

COM currently provides a mechanism for client-controlled persistence of COM objects (equivalent to CORBA externalization). However, unlike CORBA, COM currently provides no general-purpose mechanism for clients to deal with server objects, such as databases, which are inherently persistent; that is, they store their own state -- their state is not stored through an outside interface such as IPersistStorage. COM does provide monikers, which are conceptually equivalent to CORBA persistent object references. However, monikers are currently only used for OLE graphical linking. To enable COM developers to use CORBA objects to their fullest extent, the specification defines a mechanism that allows monikers to be used as persistent references to CORBA objects, and a new COM interface, IMonikerProvider, that allows clients to obtain an IMoniker interface pointer from COM and Automation Views. The resulting moniker encapsulates, stores, and loads the externalized string representation of the CORBA reference managed by the View from which the moniker was obtained. The IMonikerProvider interface and details of object reference monikers are described in Section 17.7.2, “IMonikerProvider Interface and Moniker Use,” on page 17-23.

### 17.6.2.5 CORBA View of COM/Automation Life Cycle

Initial references to COM and Automation objects can be obtained in the following way: COM IClassFactories can be wrapped with CORBA SimpleFactory interfaces. These SimpleFactory Views of COM IClassFactories can then be installed in the naming service or used via factory finders. The mechanisms used to register or dynamically look up these factories is beyond the scope of this specification.

All CORBA Views for COM and Automation objects support the LifecycleObject interface. In order to destroy a View for a COM or Automation object, the remove method of the LifecycleObject interface must be called. Once a CORBA View is instantiated, it must remain active (in memory) for the lifetime of the View unless the COM or Automation objects supports the IMonikerProvider interface. If the COM or Automation object supports the IMonikerProvider interface, then the CORBA View can safely be deactivated and reactivated provided it stores the object's moniker in persistent storage between activations. Interworking solutions are not required to support deactivation and activation of CORBA View objects, but are enabled to do so by the IMonikerProvider interface.

## 17.7 Interworking Interfaces

### 17.7.1 SimpleFactory Interface

Although a general instance factory interface can be defined in either COM or CORBA, it is the common practice in COM to have factories, which support only the **IClassFactory** or **ICoassfactory2** interfaces. These interfaces only support parameterless object constructors; that is, the **CreateInstance()** operation takes no parameters. To allow CORBA objects to be created under this factory model in COM, the **SimpleFactory** interface is defined. The **SimpleFactory** interface is supported by all CORBA Views of COM class factories.

```

module CosLifecycle
{
 interface SimpleFactory
 {
 Object create_object();
 };
};

```

**SimpleFactory** provides a generic object constructor for creating instances with no initial state. CORBA objects that can be created with no initial state should provide factories that implement the **SimpleFactory** interface.

### 17.7.2 IMonikerProvider Interface and Moniker Use

COM or Automation Views for CORBA objects may support the **IMonikerProvider** interface. COM clients may use QueryInterface for this interface.

```
[object, uuid(ecce76fe-39ce-11cf-8e92-08000970dac7)] // MIDL
interface IMonikerProvider: IUnknown {
 HRESULT get_moniker([out] IMoniker ** val);
}
```

This allows COM clients to persistently save the object reference for later use without needing to keep the View in memory. The moniker returned by **IMonikerProvider** must support at least the **IMoniker** and **IPersistStorage** interfaces. To allow CORBA object reference monikers to be created with one COM/CORBA interworking solution and later restored using another, **IPersist::GetClassID** must return the following CLSID:

```
{a936c802-33fb-11cf-a9d1-00401c606e79}
```

In addition, the data stored by the moniker's **IPersistStorage** interface must be four 0 (null) bytes followed by the length in bytes of the stringified IOR (stored as a little endian 4-byte unsigned integer value) followed by the stringified IOR itself (without null terminator).

### 17.7.3 ICORBAFactory Interface

All interworking solutions that expose COM Views of CORBA objects shall expose the **ICORBAFactory** interface. This interface is designed to support general, simple mechanisms for creating new CORBA object instances and binding to existing CORBA object references by name.

```
interface ICORBAFactory: IUnknown
{
 HRESULT CreateObject([in] LPWSTR factoryName,
 [out, retval] IUnknown ** val);
 HRESULT GetObject([in] LPWSTR objectName,
 [out, retval] IUnknown ** val);
}
```

The UUID for the **ICORBAFactory** interface is:

```
{204F6240-3AEC-11cf-BBFC-444553540000}
```

A COM class implementing **ICORBAFactory** must be registered in the Windows System Registry on the client machine using the following class id, class id tag, and Program Id respectively:

```
{913D82C0-3B00-11cf-BBFC-444553540000}
DEFINE_GUID(IID_ICORBAFactory,
0x913d82c0, 0x3b00, 0x11cf, 0xbb, 0xfc, 0x44, 0x45, 0x53,
0x54, 0x0, 0x0);
"CORBA.Factory.COM"
```

The CORBA factory object may be implemented as a singleton object (i.e., subsequent calls to create the object may return the same interface pointer).



We define a similar interface, **DICORBAFactory**, that supports creating new CORBA object instances and binding to existing CORBA objects for Automation clients. **DICORBAFactory** is an Automation Dual Interface. (For an explanation of Automation Dual interfaces, see the *Mapping: Automation and CORBA* chapter.)

```
interface DICORBAFactory: IDispatch
{
 HRESULT CreateObject([in] BSTR factoryName,
 [out,retval] IDispatch ** val);
 HRESULT GetObject([in] BSTR objectName, [out, retval]
 IDispatch ** val);
}
```

The UUID for the **DICORBAFactory** interface is:

```
{204F6241-3AEC-11cf-BBFC-444553540000}
```

An instance of this class must be registered in the Windows System Registry by calling on the client machine using the Program Id “CORBA.Factory.”

The **CreateObject** and **GetObject** methods are intended to approximate the usage model and behavior of the Visual Basic CreateObject and GetObject functions.

The first method, **CreateObject**, causes the following actions:

- A COM View is created. The specific mechanism by which it is created is undefined. We note here that one possible (and likely) implementation is that the View delegates the creation to a registered COM class factory.
- A CORBA object is created and bound to the View. The argument, **factoryName**, identifies the type of CORBA object to be created. Since the **CreateObject** method does not accept any parameters, the CORBA object must either be created by a null factory (a factory whose creation method requires no parameters), or the View must supply its own factory parameters internally.
- The bound View is returned to the caller.

The **factoryName** parameter identifies the type of CORBA object to be created, and thus implicitly identifies (directly or indirectly) the interface supported by the View. In general, the **factoryName** string takes the form of a sequence of identifiers separated by period characters (“.”), such as “personnel.record.person.” The intent of this name form is to provide a mechanism that is familiar and natural for COM and Automation programmers by duplicating the form of OLE ProgIDs. The specific semantics of name resolution are determined by the implementation of the interworking solution. The following examples illustrate possible implementations:

- The **factoryName** sequence could be interpreted as a key to a CosNameService-based factory finder. The CORBA object would be created by invoking the factory create method. Internally, the interworking solution would map the **factoryName** onto the appropriate COM class ID for the View, create the View, and bind it to the CORBA object.

- The creation could be delegated directly to a COM class factory by interpreting the **factoryName** as a COM ProgID. The ProgID would map to a class factory for the COM View, and the View's implementation would invoke the appropriate CORBA factory to create the CORBA server object.

The **GetObject** method has the following behavior:

- The **objectName** parameter is mapped by the interworking solution onto a CORBA object reference. The specific mechanism for associating names with references is not specified. In order to appear familiar to COM and Automation users, this parameter shall take the form of a sequence of identifiers separated by periods (.), in the same manner as the parameter to **CreateObject**. An implementation could, for example, choose to map the **objectName** parameter to a name in the OMG Naming Service implementation. Alternatively, an interworking solution could choose to put precreated COM Views bound to specific CORBA object references in the active object registry, and simply delegate **GetObject** calls to the registry.
- The object reference is bound to an appropriate COM or Automation View and returned to the caller.

Another name form that is specialized to CORBA is a single name with a preceding period, such as “.NameService”. When the name takes this form, the Interworking solution shall interpret the identifier (without the preceding period) as a name in the ORB Initialization interface. Specifically, the name shall be used as the parameter to an invocation of the **CORBA::ORB::ResolveInitialReferences** method on the ORB pseudo-object associated with the ICORBAFactory. The resulting object reference is bound to an appropriate COM or Automation View, which is returned to the caller.

#### 17.7.4 IForeignObject Interface

As object references are passed back and forth between two different object models through a bridge, and the references are mapped through Views (as is the case in this specification), the potential exists for the creation of indefinitely long chains of Views that delegate to other Views, which in turn delegate to other Views, and so on. To avoid this, the Views of at least one object system must be able to expose the reference for the “foreign” object managed by the View. This exposure allows other Views to determine whether an incoming object reference parameter is itself a View and, if so, obtain the “foreign” reference that it manages. By passing the foreign reference directly into the foreign object system, the bridge can avoid creating View chains.

This problem potentially exists for any View representing an object in a foreign object system. The IForeignObject interface is specified to provide bridges access to object references from foreign object systems that are encapsulated in proxies.

```
typedef struct {
 unsigned long cbMaxSize;
 unsigned long cbLengthUsed;
 [size_is(cbMaxSize), length_is(cbLengthUsed), unique]
 long *pValue;
```

```

} objSystemIDs;
interface IForeignObject : IUnknown {
 HRESULT GetForeignReference([in] objSystemIDs systemIDs,
 [out] long *systemID,
 [out] LPSTR* objRef);
 HRESULT GetUniqueId([out] LPSTR *id

```

The UUID for **IForeignObject** is:

```
{204F6242-3AEC-11cf-BBFC-444553540000}
```

The first parameter (**systemIDs**) is an array of long values that correspond to specific object systems. These values must be positive, unique, and publicly known. The OMG will manage the allocation of identifier values in this space to guarantee uniqueness. The value for the CORBA object system is the long value 1. The **systemIDs** array contains a list of IDs for object systems for which the caller is interested in obtaining a reference. The order of IDs in the list indicates the caller's order of preference. If the View can produce a reference for at least one of the specified object systems, then the second parameter (**systemID**) is the ID of the first object system in the incoming array that it can satisfy. The **objRef** out parameter will contain the object reference converted to a string form. Each object system is responsible for providing a mechanism to convert its references to strings, and back into references. For the CORBA object system, the string contains the IOR string form returned by **CORBA::ORB::object\_to\_string**, as defined in the CORBA specification.

The choice of object reference strings is motivated by the following observations:

- Language mappings for object references do not prescribe the representation of object references. Therefore, it is impossible to reliably map any given ORB's object references onto a fixed Automation parameter type.
- The object reference being returned from **GetForeignObject** may be from a different ORB than the caller. IORs in string form are the only externalized standard form of object reference supported by CORBA.

The purpose of the **GetRepositoryID** method is to support the ability of **DICORBAAny** (see Section 19.8.4, "Mapping for anys," on page 19-24) when it wraps an object reference, to produce a type code for the object when asked to do so via **DICORBAAny**'s readonly **typeCode** property.

It is not possible to provide a similar inverse interface exposing COM references to CORBA clients through CORBA Views because of limitations imposed by COM's View of object identity and use of interface pointer as references.

### 17.7.5 ICORBAObject Interface

The **ICORBAObject** interface is a COM interface that is exposed by COM Views, allowing COM clients to have access to operations on the CORBA object references, defined on the **CORBA::Object** pseudo-interface. The **ICORBAObject** interface can be obtained by COM clients through **QueryInterface**. **ICORBAObject** is defined as follows:

```

interface ICORBAObject: IUnknown
{
 HRESULT GetInterface([out] IUnknown ** val);
 HRESULT GetImplementation([out] IUnknown ** val);
 HRESULT IsA([in] LPTSTR repositoryID,
 [out] boolean *val);
 HRESULT IsNil([out] boolean *val);
 HRESULT IsEquivalent([in] IUnknown* obj,
 [out] boolean * val);
 HRESULT NonExistent([out] boolean *val);
 HRESULT Hash([out] long *val);
}

```

The UUID for **ICORBAObject** is:

```
{204F6243-3AEC-11cf-BBFC-444553540000}
```

Automation controllers gain access to operations on the CORBA object reference interface through the Dual Interface **DIORBObject::GetCORBAObject** method described next.

```

interface DICORBAObject: IDispatch
{
 HRESULT GetInterface([out, retval] IDispatch ** val);
 HRESULT GetImplementation([out, retval] IDispatch **
 val);
 HRESULT IsA([in] BSTR repositoryID, [out, retval]
 VARIANT BOOL *val);
 HRESULT IsNil([out, retval] VARIANT BOOL *val);
 HRESULT IsEquivalent([in] IDispatch* obj,[out,retval]
 VARIANT BOOL * val);
 HRESULT NonExistent([out,retval] VARIANT BOOL *val);
 HRESULT Hash([out, retval] long *val);
};

```

The UUID for **DICORBAObject** is:

```
{204F6244-3AEC-11cf-BBFC-444553540000}
```

The UUID for **DCORBAObject** is:

```
{7271ff40-21f6-11d1-9d47-00a024a73e4f}
```

### 17.7.6 *ICORBAObject2*

**ICORBAObject 2** is the direct mapping following the COM mapping rules for the **CORBA::Object** interface.

### 17.7.7 *IORBObject Interface*

The **IORBObject** interface provides Automation and COM clients with access to the operations on the ORB pseudo-object.

The **IORBObject** is defined as follows:

```
typedef struct {
 unsigned long cbMaxSize;
 unsigned long cbLengthUsed;
 [size_is(cbMaxSize), length_is(cbLengthUsed), unique]
 LPSTR *pValue;
} CORBA_ORBObjectIdList;
interface IORBObject : IUnknown
 HRESULT ObjectToString([in] IUnknown* obj,
 [out] LPSTR *val);
 HRESULT StringToObject([in] LPTSTR ref,
 [out] IUnknown *val);
 HRESULT GetInitialReferences(
 [out], CORBA_ORBObjectIdList *val);
 HRESULT ResolveInitialReference([in] LPTSTR name,
 [out] IUnknown ** val));
}
```

The UUID for **IORBObject** is:

```
{204F6245-3AEC-11cf-BBFC-444553540000}
```

A reference to this interface is obtained by calling  
**ICORBAFactory::GetObject("CORBA.ORB.2")**.

The methods of **DIORBObject** delegate their function to the similarly-named operations on the ORB pseudo-object associated with the **IORBObject**.

Automation clients access operations on the ORB via the following Dual Interface:

```
interface DIORBObject: IDispatch {
 HRESULT ObjectToString([in] IDispatch* obj,
 [out,retval] BSTR *val);
 HRESULT StringToObject([in] BSTR ref,[out,retval]
 IDispatch * val);
 HRESULT GetInitialReferences([out, retval] VARIANT *val);
 HRESULT ResolveInitialReference ([in] BSTR name,
 [out retval] IDispatch * val);
 HRESULT GetCORBAObject ([in] IDispatch* obj,
 [out, retval] DICORBAObject ** val);
}
```

A reference to this interface is obtained by calling  
**DICORBAFactory::GetObject("CORBA.ORB.2")**.

This interface is very similar to **IORBObject**, except for the additional method **GetCORBAObject**. This method returns an **IDispatch** pointer to the **DICORBAObject** interface associated with the parameter Object. This operation is primarily provided to allow Automation controllers (i.e., Automation clients) that cannot invoke **QueryInterface** on the **View** object to obtain the **ICORBAObject** interface.

The UUID for **DIORBObject** is:

```
{204F6246-3AEC-11cf-BBFC-444553540000}
```

The UUID for **DORBObject** is:

```
{adff0da0-21f6-11d1-9d47-00a024a73e4f}
```

## 17.7.8 Naming Conventions for View Components

### 17.7.8.1 Naming the COM View Interface

The default name for the COM View's Interface should be:

```
I<module name>_<interface name>
```

For example, if the module name is "**MyModule**" and the interface name is "**MyInterface**," then the default name should be:

```
IMyModule_MyInterface
```

If the module containing the interface is itself nested within other modules, the default name should be:

```
I<module name>_<module name>_...<module name>_<interface name>
```

where the module names read from outermost on the left to innermost on the right. Extending our example, if module "**MyModule**" were nested within module "**OuterModule**," then the default name shall be:

```
IOuterModule_MyModule_MyInterface
```

### 17.7.8.2 Tag for the Automation Interface Id

No standard tag is required for Automation and Dual Interface IDs because client programs written in Automation controller environments such as Visual Basic are not expected to explicitly use the UUID value.

### 17.7.8.3 Naming the Automation View Dispatch Interface

The default name of the Automation View's Interface should be:

```
D<module name>_<interface name>
```

For example, if the module name is "**MyModule**" and the interface name is "**MyInterface**," then the default name should be:

**DMyModule\_MyInterface**

If the module containing the interface is itself nested within other modules, the default name should be:

**D<module name>\_<module name>\_...<module name>\_<interface name>**

where the module names read from outermost on the left to innermost on the right. Extending our example, if module “**MyModule**” were nested within module “**OuterModule**,” then the default name shall be:

**DOuterModule\_MyModule\_MyInterface**

*17.7.8.4 Naming the Automation View Dual Interface*

The default name of the Automation Dual View’s Interface should be:

**DI<module name>\_<interface name>**

For example, if the module name is “**MyModule**” and the interface name is “**MyInterface**,” then the default name should be:

**DIMyModule\_MyInterface**

If the module containing the interface is itself nested within other modules, the default name should be:

**DI<module name>\_<module name>\_...<module name>\_<interface name>**

where the module names read from outermost on the left to innermost on the right. Extending our example, if module “**MyModule**” were nested within module “**OuterModule**,” then the default name will be:

**DIOuterModule\_MyModule\_MyInterface**

*17.7.8.5 Naming the Program Id for the COM Class*

If a separate COM class is registered for each View Interface, then the default Program Id for that class will be:

**<module name> “.“ <module name> “.“ ...<module name> “.“ <interface name>**

where the module names read from outermost on the left to innermost on the right. In our example, the default Program Id will be:

**"OuterModule.MyModule.MyInterface"**

#### *17.7.8.6 Naming the Class Id for the COM Class*

If a separate COM co-class is registered for each Automation View Interface, then the default tag for the COM Class Id (CLSID) for that class should be:

**CLSID\_<module name>\_<module name>\_...<module name>\_  
<interface name>**

where the module names read from outermost on the left to innermost on the right. In our example, the default CLSID tag should be:

**CLSID\_OuterModule\_MyModule\_MyInterface**

### *17.8 Distribution*

The version of COM (and OLE) that is addressed in this specification (OLE 2.0 in its currently released form) does not include any mechanism for distribution. CORBA specifications define a distribution architecture, including a standard protocol (IIOP) for request messaging. Consequently, the CORBA architecture, specifications, and protocols shall be used for distribution.

#### *17.8.1 Bridge Locality*

One of the goals of this specification is to allow any compliant interworking mechanism delivered on a COM client node to interoperate correctly with any CORBA-compliant components that use the same interface specifications. Compliant interworking solutions must appear, for all intents and purposes, to be CORBA object implementations and/or clients to other CORBA clients, objects, and services on an attached network.



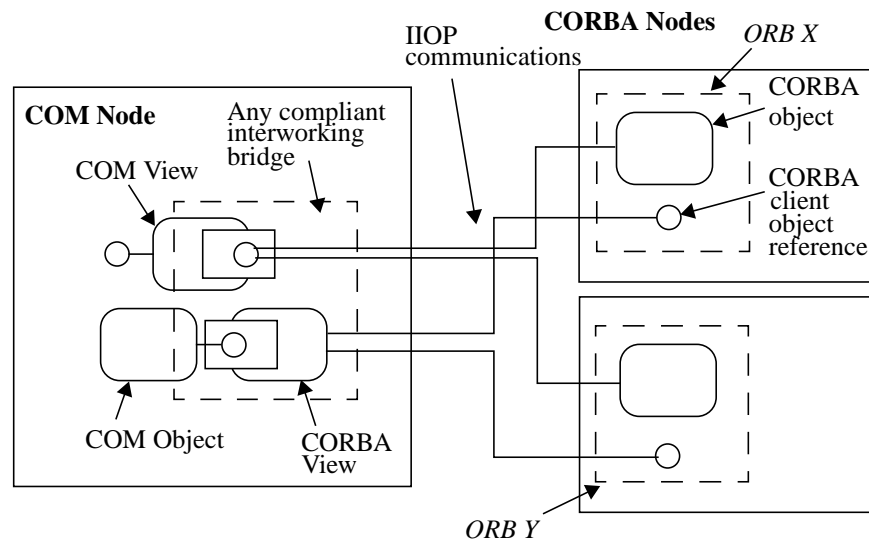

Figure 17-7 Bridge Locality

Figure 17-7 illustrates the required locality for interworking components. All of the transformations between CORBA interfaces and COM interfaces described in this specification will take place on the node executing the COM environment. Mapping agents (COM views, CORBA views, and bridging elements) will reside and execute on the COM client node. This requirement allows compliant interworking solutions to be localized to a COM client node, and to interoperate with any CORBA-compliant networking ORB that shares the same view of interfaces with the interworking solution.

### 17.8.2 Distribution Architecture

External communications between COM client machines, and between COM client machines and machines executing CORBA environments and services, will follow specifications contained in *CORBA*. Figure 17-7 on page 17-33 illustrates the required distribution architecture. The following statements articulate the responsibilities of compliant solutions.

- All externalized CORBA object references will follow *CORBA* specifications for Interoperable Object References (IORs). Any IORs generated by components performing mapping functions must include a valid IOP profile.
- The mechanisms for negotiating protocols and binding references to remote objects will follow the architectural model described in *CORBA*.
- A product component acting as a CORBA client may bind to an object by using any profile contained in the object's IOR. The client must, however, be capable of binding with an IOP profile.
- Any components that implement CORBA interfaces for remote use must support the IOP.

## 17.9 Interworking Targets

This specification is targeted specifically at interworking between the following systems and versions:

- CORBA as described in *CORBA: Common Object Request Broker Architecture and Specification*.
- OLE as embodied in version 2.03 of the OLE run-time libraries.
- Microsoft Object Description Language (ODL) as supported by MKTYPELIB version 2.03.3023.
- Microsoft Interface Description Language (MIDL) as supported by the MIDL Compiler version 2.00.0102.

In determining which features of Automation to support, the expected usage model for Automation Views follows the Automation controller behavior established by Visual Basic 4.0.

## 17.10 Compliance to COM/CORBA Interworking

This section explains which software products are subject to compliance to the Interworking specification, and provides compliance points. For general information about compliance to *CORBA* specifications, refer to the *Preface, Definition of CORBA Compliance*.

### 17.10.1 Products Subject to Compliance

COM/CORBA interworking covers a wide variety of software activities and a wide range of products. This specification is not intended to cover all possible products that facilitate or use COM and CORBA mechanisms together. This Interworking specification defines three distinct categories of software products, each of which are subject to a distinct form of compliance. The categories are:

- Interworking Solutions
- Mapping Solutions
- Mapped Components

#### 17.10.1.1 Interworking solutions

Products that facilitate the development of software that will bidirectionally transform COM and/or Automation invocations into isomorphic CORBA invocations (and vice versa) in a generic way are Interworking Solutions. An example of this kind of software would be a language processor that parses OMG IDL specifications and automatically generates code for libraries that map the OMG IDL interfaces into Automation interfaces and which also parses Automation ODL and automatically generates code for libraries that map the OLE Automation interfaces into CORBA

interfaces. Another example would be a generic bridging component that, based on run-time interface descriptions, interpretively maps both COM and CORBA invocations onto CORBA and COM objects (respectively).

A product of this type is a compliant Interworking Solution if the resulting mapped interfaces are transformed as described in this specification, and if the mapped interfaces support all of the features and interface components required by this specification.

A compliant Interworking Solution must designate whether it is a compliant COM/CORBA Interworking Solution and/or a compliant Automation/CORBA Interworking Solution.

### 17.10.1.2 *Mapping solutions*

Products that facilitate the development of software that will unidirectionally transform COM and/or Automation invocations into isomorphic CORBA invocations (and vice versa) in a generic way are described as *Mapping Solutions*. An example of this kind of software would be a language processor that parses OMG IDL specifications and automatically generates code for libraries that map the OMG IDL interfaces into Automation interfaces. Another example would be a generic bridging component that interpretively maps Automation invocations onto CORBA objects based on run-time interface descriptions.

A product of this type will be considered a compliant Mapping Solution if the resulting mapped interfaces are transformed as described in this specification, and if the mapped interfaces support all of the features and interface components required in this specification.

A compliant Mapping Solution must designate whether it is a compliant COM to CORBA Mapping Solution, a compliant Automation to CORBA Mapping Solution, a compliant CORBA to COM Mapping Solution, and/or a compliant CORBA to Automation Mapping Solution.

### 17.10.1.3 *Mapped components*

Applications, components or libraries that expose a specific, fixed set of interfaces mapped from CORBA to COM or Automation (and/or vice versa) are described as Mapped Components. An example of this kind of product would be a set of business objects defined and implemented in CORBA that also expose isomorphic Automation interfaces.

This type of product will be considered a compliant Mapped Component if the interfaces it exposes are mapped as described in this specification, and if the mapped interfaces support all of the features and interface components required in this specification.

### 17.10.2 Compliance Points

The intent of this specification is to allow the construction of implementations that fit in the design space described in Section 17.2, “Interworking Object Model,” on page 17-3, and yet guarantee interface uniformity among implementations with similar or overlapping design centers. This goal is achieved by the following compliance statements:

- When a product offers the mapping of CORBA interfaces onto isomorphic COM and/or Automation interfaces, the mapping of COM and/or Automation interfaces onto isomorphic CORBA interfaces, or when a product offers the ability to automatically generate components that perform such mappings, then the product must use the interface mappings defined in this specification. Note that products may offer custom, nonisomorphic interfaces that delegate some or all of their behavior to CORBA, COM, or Automation objects. These interfaces are not in the scope of this specification, and are neither compliant nor noncompliant.
- Interworking solutions that expose COM Views of CORBA objects are required to expose the CORBA-specific COM interfaces ICORBAObject and IORBObject, defined in Section 17.7.5, “ICORBAObject Interface,” on page 17-27 and Section 17.7.7, “IORBObject Interface,” on page 17-28, respectively.
- Interworking solutions that expose Automation Views of CORBA objects are required to expose the CORBA-specific Automation Dual interfaces DICORBAObject and DIORBObject, defined in Section 17.7.5, “ICORBAObject Interface,” on page 17-27 and Section 17.7.7, “IORBObject Interface,” on page 17-28, respectively.
- OMG IDL interfaces exposed as COM or Automation Views are not required to provide type library and registration information in the COM client environment where the interface is to be used. If such information is provided; however, then it must be provided in the prescribed manner.
- Each COM and Automation View must map onto one and only one CORBA object reference, and must also expose the IForeignObject interface, described in Section 17.7.4, “IForeignObject Interface,” on page 17-26. This constraint guarantees the ability to obtain an unambiguous CORBA object reference from any COM or Automation View via the IForeignObject interface.
- If COM or Automation Views expose the IMonikerProvider interface, they shall do so as specified in Section 17.7.2, “IMonikerProvider Interface and Moniker Use,” on page 17-23.
- All COM interfaces specified in this specification have associated COM Interface IDs. Compliant interworking solutions must use the IIDs specified herein, to allow interoperability between interworking solutions.
- All compliant products that support distributed interworking must support the CORBA Internet Inter-ORB Protocol (IIOP), and use the interoperability architecture described in CORBA in the manner prescribed in Section 17.8, “Distribution,” on page 17-32. Interworking solutions are free to use any additional proprietary or public protocols desired.

- 
- Interworking solutions that expose COM Views of CORBA objects are required to provide the ICORBAFactory object as defined in Section 17.7.3, “ICORBAFactory Interface,” on page 17-24.
  - Interworking solutions that expose Automation Views of CORBA objects are required to provide the DICORBAFactory object as defined in Section 17.7.3, “ICORBAFactory Interface,” on page 17-24.
  - Interworking solutions that expose CORBA Views of COM or Automation objects are required to derive the CORBA View interfaces from **CosLifeCycle::LifeCycleObject** as described in CORBA View of COM/Automation Life Cycle, as described under Section 17.6.2, “Binding and Life Cycle,” on page 17-20.



This chapter describes the data type and interface mapping between COM and CORBA. The mappings are described in the context of both Win16 and Win32 COM due to the differences between the versions of COM and between the automated tools available to COM developers under these environments. The mapping is designed to be fully implemented by automated interworking tools.

## Contents

This chapter contains the following sections.

| Section Title                    | Page  |
|----------------------------------|-------|
| “Data Type Mapping”              | 18-1  |
| “CORBA to COM Data Type Mapping” | 18-2  |
| “COM to CORBA Data Type Mapping” | 18-33 |

## 18.1 Data Type Mapping

The data type model used in this mapping for Win32 COM is derived from MIDL (a derivative of DCE IDL). COM interfaces using “custom marshaling” must be hand-coded and require special treatment to interoperate with CORBA using automated tools. This specification does not address interworking between CORBA and custom-marshaled COM interfaces.

The data type model used in this mapping for Win16 COM is derived from ODL since Microsoft RPC and the Microsoft MIDL compiler are not available for Win16. The ODL data type model was chosen since it is the only standard, high-level representation available to COM object developers on Win16.

Note that although the MIDL and ODL data type models are used as the reference for the data model mapping, there is no requirement that either MIDL or ODL be used to implement a COM/CORBA interworking solution.

In many cases, there is a one-to-one mapping between COM and CORBA data types. However, in cases without exact mappings, run-time conversion errors may occur. Conversion errors will be discussed in Mapping for Exception Types under Section 18.2.10, “Interface Mapping,” on page 18-11.

## 18.2 CORBA to COM Data Type Mapping

### 18.2.1 Mapping for Basic Data Types

The basic data types available in OMG IDL map to the corresponding data types available in Microsoft IDL as shown in Table 18-1.

Table 18-1 OMG IDL to MIDL Intrinsic Data Type Mappings

| OMG IDL        | Microsoft IDL  | Microsoft ODL  | Description                                                                                       |
|----------------|----------------|----------------|---------------------------------------------------------------------------------------------------|
| short          | short          | short          | Signed integer with a range of $-2^{15} \dots 2^{15} - 1$                                         |
| long           | long           | long           | Signed integer with a range of $-2^{31} \dots 2^{31} - 1$                                         |
| unsigned short | unsigned short | unsigned short | Unsigned integer with a range of $0 \dots 2^{16} - 1$                                             |
| unsigned long  | unsigned long  | unsigned long  | Unsigned integer with a range of $0 \dots 2^{32} - 1$                                             |
| float          | float          | float          | IEEE single-precision floating point number                                                       |
| double         | double         | double         | IEEE double-precision floating point number                                                       |
| char           | char           | char           | 8-bit quantity limited to the ISO Latin-1 character set                                           |
| wchar          | WCHAR          | WCHAR          | wide character                                                                                    |
| boolean        | boolean        | boolean        | 8-bit quantity that is limited to 1 and 0                                                         |
| octet          | byte           | unsigned char  | 8-bit opaque data type, guaranteed to not undergo any conversion during transfer between systems. |

---

**Note** – midl and mktyplib disagree about the size of boolean when used in an ODL specification. To avoid this ambiguity, we make the mapping explicit and use the VARIANT BOOL type instead of the built-in boolean type.

---

### 18.2.2 Mapping for Constants

The mapping of the OMG IDL keyword **const** to Microsoft IDL and ODL is almost exactly the same. The following are the OMG IDL definitions for constants:



```

// OMG IDL
 const short S = ...;
 const long L = ...;
 const unsigned short US = ...;
 const unsigned long UL = ...;
 const float F = ...;
 const char C = ...;
 const boolean B = ...;
 const string STR = "...";

```

that map to the following Microsoft IDL and ODL definitions for constants:

```

// Microsoft IDL and ODL
 const short S = ...;
 const long L = ...;
 const unsigned short US = ...;
 const unsigned long UL = ...;
 const float F = ...;
 const char C = ...;
 const boolean B = ...;
 const string STR = "...";

```

### 18.2.3 Mapping for Enumerators

CORBA has enumerators that are not explicitly tagged with values. Microsoft IDL and ODL support enumerators that are explicitly tagged with values. The constraint is that any language mapping that permits two enumerators to be compared or defines successor or predecessor functions on enumerators must conform to the ordering of the enumerators as specified in the OMG IDL.

```

// OMG IDL
interface MyInft {
 enum A_or_B_or_C {A, B, C};
};

```

CORBA enumerators are mapped to COM enumerations directly according to CORBA C language binding. The Microsoft IDL keyword `v1_enum` is required in order for an enumeration to be transmitted as 32-bit values. Microsoft recommends that this keyword be used on 32-bit platforms, since it increases the efficiency of marshalling and unmarshalling data when such an enumerator is embedded in a structure or union.

```

// Microsoft IDL and ODL
uuid(...),
interface IMyIntf {
 typedef [v1_enum]
 enum tagA or B or C {MyIntf A = 0,
 MyInft B,
 MyIntf C }
}

```

```

 MyIntf A or B or C;
};

```

A maximum of  $2^{32}$  identifiers may be specified in an enumeration in CORBA. Enumerators in Microsoft IDL and ODL will only support  $2^{16}$  identifiers, and therefore, truncation may result.

### 18.2.4 Mapping for String Types

CORBA currently defines the data type **string** to represent strings that consist of 8-bit quantities, which are NULL-terminated.

Microsoft IDL and ODL define a number of different data types, which are used to represent both 8-bit character strings and strings containing wide characters based on Unicode.

Table 18-2 illustrates how to map the string data types in OMG IDL to their corresponding data types in both Microsoft IDL and ODL.

Table 18-2 OMG IDL to Microsoft IDL/ODL String Mappings

| OMG IDL | Microsoft IDL                          | Microsoft ODL | Description                            |
|---------|----------------------------------------|---------------|----------------------------------------|
| string  | LPSTR<br>[string,unique]<br>char *     | LPSTR         | Null-terminated 8-bit character string |
| wstring | LPWSTR<br>[string,unique]<br>wchar t * | LPWSTR        | Null-terminated Unicode string         |

OMG IDL supports two different types of strings: *bounded* and *unbounded*. Bounded strings are defined as strings that have a maximum length specified; whereas, unbounded strings do not have a maximum length specified.

#### 18.2.4.1 Mapping for Unbounded String Types

The definition of an unbounded string limited to 8-bit quantities in OMG IDL

```

// OMG IDL
typedef string UNBOUNDED_STRING;

```

is mapped to the following syntax in Microsoft IDL and ODL, which denotes the type of a “stringified unique pointer to character.”

```

// Microsoft IDL and ODL
typedef [string, unique] char * UNBOUNDED_STRING;

```

In other words, a value of type **UNBOUNDED\_STRING** is a non-NULL pointer to a one-dimensional null-terminated character array whose extent and number of valid elements can vary at run-time.

### 18.2.4.2 Mapping for Bounded String Types

Bounded strings have a slightly different mapping between OMG IDL and Microsoft IDL and ODL. The following OMG IDL definition for a bounded string:

```
// OMG IDL
const long N = ...;
typedef string<N> BOUNDED_STRING;
```

maps to the following syntax in Microsoft IDL and ODL for a “stringified non-conformant array.”

```
// Microsoft IDL and ODL
const long N = ... ;
typedef [string, unique] char (* BOUNDED_STRING) [N];
```

In other words, the encoding for a value of type **BOUNDED\_STRING** is that of a null-terminated array of characters whose extent is known at compile time, and the number of valid characters can vary at run-time.

### 18.2.5 Mapping for Struct Types

OMG IDL uses the keyword **struct** to define a record type, consisting of an ordered set of name-value pairs representing the member types and names. A structure defined in OMG IDL maps bidirectionally to Microsoft IDL and ODL structures. Each member of the structure is mapped according to the mapping rules for that data type.

An OMG IDL struct type with members of types T0, T1, T2, and so on

```
// OMG IDL
typedef ... T0
typedef ... T1;
typedef ... T2;
...
typedef ... Tn;
struct STRUCTURE
{
 T0 m0;
 T1 m1;
 T2 m2;
...
 Tn mN;
};
```

has an encoding equivalent to a Microsoft IDL and ODL structure definition, as follows.

```
// Microsoft IDL and ODL
typedef ... T0;
typedef ... T1;
typedef ... T2;
```

```

...
typedef ... Tn;
typedef struct
{
 T0 m0;
 T1 m1;
 T2 m2;
 ...
 TN mN;
} STRUCTURE;

```

Self-referential data types are expanded in the same manner. For example,

```

struct A { // OMG IDL
 sequence<A> v1;
};

```

is mapped as

```

typedef struct A {
 struct { // MIDL
 unsigned long cbMaxSize;
 unsigned long cbLengthUsed;
 [size_is(cbMaxSize), length_is(cbLengthUsed), unique]
 struct A * pValue;
 } v1;
} A;

```

### 18.2.6 Mapping for Union Types

OMG IDL defines unions to be encapsulated discriminated unions: the discriminator itself must be encapsulated within the union.

In addition, the OMG IDL union discriminants must be constant expressions. The discriminator tag must be a previously defined **long**, **short**, **unsigned long**, **unsigned short**, **char**, **boolean**, or **enum** constant. The default case can appear at most once in the definition of a discriminated union, and case labels must match or be automatically castable to the defined type of the discriminator.

The following definition for a discriminated union in OMG IDL

```
// OMG IDL
enum UNION_DISCRIMINATOR
{
 dChar=0,
 dShort,
 dLong,
 dFloat,
 dDouble
};

union UNION_OF_CHAR_AND_ARITHMETIC
switch(UNION_DISCRIMINATOR)
{
 case dChar: char c;
 case dShort: short s;
 case dLong: long l;
 case dFloat: float f;
 case dDouble: double d;
 default: octet v[8];
};
```

is mapped into encapsulated unions in Microsoft IDL as follows:

```
// Microsoft IDL
typedef enum [v1 enum]
{
 dchar=0,
 dShort,
 dLong,
 dFloat,
 dDouble
} UNION_DISCRIMINATOR;

typedef union switch (UNION_DISCRIMINATOR DCE_d)
{
 case dChar: char c;
 case dShort: short s;
 case dLong: long l;
 case dFloat: float f;
 case dDouble: double d;
 default: byte v[8];
}UNION_OF_CHAR_AND_ARITH
```

## 18.2.7 Mapping for Sequence Types

OMG IDL defines the keyword **sequence** to be a one-dimensional array with two characteristics: an optional maximum size that is fixed at compile time, and a length that is determined at run-time. Like the definition of strings, OMG IDL allows sequences to be defined in one of two ways: bounded and unbounded. A sequence is bounded if a maximum size is specified, else it is considered unbounded.

### 18.2.7.1 Mapping for Unbounded Sequence Types

The mapping of the following OMG IDL syntax for the unbounded sequence of type **T**

```
// OMG IDL for T
typedef ... T;
typedef sequence<T> UNBOUNDED_SEQUENCE;
```

maps to the following Microsoft IDL and ODL syntax:

```
// Microsoft IDL or ODL
typedef ... U;
typedef struct
{
 unsigned long cbMaxSize;
 unsigned long cbLengthUsed;
 [size_is(cbMaxSize), length_is(cbLengthUsed), unique]
 U * pValue;
 } UNBOUNDED_SEQUENCE;
```

The encoding for an unbounded OMG IDL sequence of type **T** is that of a Microsoft IDL or ODL struct containing a unique pointer to a conformant array of type **U**, where **U** is the Microsoft IDL or ODL mapping of **T**. The enclosing struct in the Microsoft IDL/ODL mapping is necessary to provide a scope in which extent and data bounds can be defined.

### 18.2.7.2 Mapping for Bounded Sequence Types

The mapping for the following OMG IDL syntax for the bounded sequence of type **T** that can grow to be **N** size:

```
// OMG IDL for T
const long N = ...;
typedef ...T;
typedef sequence<T,N> BOUNDED_SEQUENCE_OF_N;
```

maps to the following Microsoft IDL or ODL syntax:

```
// Microsoft IDL or ODL
const long N = ...;
typedef ...U;
```

```
typedef struct
{
 unsigned long reserved;
 unsigned long cbLengthUsed;
 [length_is(cbLengthUsed)] U Value[N];
} BOUNDED_SEQUENCE_OF_N;
```

---

**Note** – The maximum size of the bounded sequence is declared in the declaration of the array and therefore a [size is ()] attribute is not needed.

---

### 18.2.8 Mapping for Array Types

OMG IDL arrays are fixed length multidimensional arrays. Both Microsoft IDL and ODL also support fixed length multidimensional arrays. Arrays defined in OMG IDL map bidirectionally to COM fixed length arrays. The type of the array elements is mapped according to the data type mapping rules.

The mapping for an OMG IDL array of some type T is that of an array of the type U as defined in Microsoft IDL and ODL, where U is the result of mapping the OMG IDL T into Microsoft IDL or ODL.

```
// OMG IDL for T
const long N = ...;
typedef ... T;
typedef T ARRAY_OF_T[N];

// Microsoft IDL or ODL for T
const long N = ...;
typedef ... U;
typedef U ARRAY_OF_U[N];
```

In Microsoft IDL and ODL, the name **ARRAY\_OF\_U** denotes the type of a “one-dimensional nonconformant and nonvarying array of U.” The value N can be of any integral type, and const means (as in OMG IDL) that the value of N is fixed and known at IDL compilation time. The generalization to multidimensional arrays follows the obvious mapping of syntax.

Note that if the ellipsis were **octet** in the OMG IDL, then the ellipsis would have to be **byte** in Microsoft IDL or ODL. That is why the types of the array elements have different names in the two texts.

### 18.2.9 Mapping for the *any* Type

The CORBA **any** type permits the specification of values that can express any OMG IDL data type. There is no direct or simple mapping of this type into COM, thus we map it to the following interface definition:

```
// Microsoft IDL
typedef [v1_enum] enum CORBAAnyDataTagEnum {
```

```

 anySimpleValTag,
 anyAnyValTag,
 anySeqValTag,
 anyStructValTag,
 anyUnionValTag
 } CORBAAnyDataTag;

typedef union CORBAAnyDataUnion switch(CORBAAnyDataTag
 whichOne){
 case anyAnyValTag:
 ICORBA_Any *anyVal;
 case anySeqValTag:
 case anyStructValTag:
 struct {
 [string, unique] char * repositoryId;
 unsigned long cbMaxSize;
 unsigned long cbLengthUsed;
 [size_is(cbMaxSize), length_is(cbLengthUsed),
 unique]
 union CORBAAnyDataUnion *pVal;
 } multiVal;
 case anyUnionValTag:
 struct {
 [string, unique] char * repositoryId;
 long disc;
 union CORBAAnyDataUnion *value;
 } unionVal;
 case anyObjectValTag:
 struct {
 [string, unique] char * repositoryId;
 VARIANT val;
 } objectVal;
 case anySimpleValTag: // All other types
 VARIANT simpleVal;
 } CORBAAnyData;

.... uuid(74105F50-3C68-11cf-9588-AA0004004A09)]
interface ICORBA_Any: IUnknown
{
 HRESULT _get_value([out] VARIANT * val);
 HRESULT _put_value([in] VARIANT val);
 HRESULT _get_CORBAAnyData([out] CORBAAnyData* val);
 HRESULT _put_CORBAAnyData([in] CORBAAnyData val);
 HRESULT _get_typeCode([out] ICORBA_TypeCode ** tc);
}

```

In most cases, a COM client can use the `_get_value()` or `_put_value()` method to set and get the value of a CORBA **any**. However, the data types supported by a VARIANT are too restrictive to support all values representable in an **any**, such as structs and unions. In cases where the data types can be represented in a VARIANT, they will be; in other cases, they will optionally be returned as an **IStream** pointer



in the VARIANT. An implementation may choose not to represent these types as an **IStream**, in which case an SCODE value of E\_DATA\_CONVERSION is returned when the VARIANT is requested.

## 18.2.10 Interface Mapping

### 18.2.10.1 Mapping for interface identifiers

Interface identifiers are used in both CORBA and COM to uniquely identify interfaces. These allow the client code to retrieve information about, or to inquire about, other interfaces of an object.

CORBA identifies interfaces using the RepositoryId. The RepositoryId is a unique identifier for, among other things, an interface. COM identifies interfaces using a structure similar to the DCE UUID (in fact, identical to a DCE UUID on Win32) known as an IID. As with CORBA, COM specifies that the textual names of interfaces are only for convenience and need not be globally unique.

The CORBA RepositoryId is mapped, bidirectionally, to the COM IID. The algorithm for creating the mapping is detailed in Section 17.5.4, “Mapping Interface Identity,” on page 17-16.

### 18.2.10.2 Mapping for exception types

The CORBA object model uses the concept of exceptions to report error information. Additional, exception-specification information may accompany the exception. The exception-specific information is a specialized form of a record. Because it is defined as a record, the additional information may consist of any of the basic data types or a complex data type constructed from one or more basic data types. Exceptions are classified into two types: System (Standard) Exceptions and User Exceptions.

COM provides error information to clients only if an operation uses a return result of type HRESULT. A COM HRESULT with a value of zero indicates success. The HRESULT then can be converted into an SCODE (the SCODE is explicitly specified as being the same as the HRESULT on Win32 platforms). The SCODE can then be examined to determine whether the call succeeded or failed. The error or success code, also contained within the SCODE, is composed of a “facility” major code (13 bits on Win32 and 4 bits on Win16) and a 16-bit minor code.

Unlike CORBA, COM provides no standard way to return user-defined exception data to the client. Also, there is no standard mechanism in COM to specify the completion status of an invocation. In addition, it is not possible to predetermine what set of errors a COM interface might return based on the definition of the interface as specified in Microsoft IDL, ODL, or in a type library. Although the set of status codes that can be returned from a COM operation must be fixed when the operation is defined, there is currently no machine-readable way to discover the set of valid codes.

Since the CORBA exception model is significantly richer than the COM exception model, mapping CORBA exceptions to COM requires an additional protocol to be defined for COM. However, this protocol does not violate backwards compatibility, nor does it require any changes to COM. To return the User Exception data to a COM client, an optional parameter is added to the end of a COM operation signature when mapping CORBA operations, which raise User Exceptions. System exception information is returned in a standard OLE Error Object.

### ***Mapping for System Exceptions***

System exceptions are standard exception types, which are defined by the CORBA specification and are used by the Object Request Broker (ORB) and object adapters (OA). Standard exceptions may be returned as a result of any operation invocation, regardless of the interface on which the requested operation was attempted.

There are two aspects to the mapping of System Exceptions. One aspect is generating an appropriate HRESULT for the operation to return. The other aspect is conveying System Exception information via a standard OLE Error Object.

The following table shows the HRESULT, which must be returned by the COM View when a CORBA System Exception is raised. Each of the CORBA System Exceptions is assigned a 16-bit numerical ID starting at 0x200 to be used as the code (lower 16 bits) of the HRESULT. Because these errors are interface-specific, the COM facility code FACILITY\_ITF is used as the facility code in the HRESULT.

Bits 12-13 of the HRESULT contain a bit mask, which indicates the completion status of the CORBA request. The bit value 00 indicates that the operation did not complete, a bit value of 01 indicates that the operation did complete, and a bit value of 02 indicates that the operation may have completed. Table 18-3 lists the HRESULT constants and their values.

*Table 18-3* Standard Exception to SCODE Mapping

| <b>HRESULT Constant</b> | <b>HRESULT Value</b> |
|-------------------------|----------------------|
| ITF_E_UNKNOWN_NO        | 0x40200              |
| ITF_E_UNKNOWN_YES       | 0x41200              |
| ITF_E_UNKNOWN_MAYBE     | 0x42200              |
| ITF_E_BAD_PARAM_NO      | 0x40201              |
| ITF_E_BAD_PARAM_YES     | 0x41201              |
| ITF_E_BAD_PARAM_MAYBE   | 0x42201              |
| ITF_E_NO_MEMORY_NO      | 0x40202              |
| ITF_E_NO_MEMORY_YES     | 0x41202              |
| ITF_E_NO_MEMORY_MAYBE   | 0x42202              |
| ITF_E_IMP_LIMIT_NO      | 0x40203              |

Table 18-3 Standard Exception to SCODE Mapping (Continued)

|                           |         |
|---------------------------|---------|
| ITF_E_IMP_LIMIT_YES       | 0x41203 |
| ITF_E_IMP_LIMIT_MAYBE     | 0x42203 |
| ITF_E_COMM_FAILURE_NO     | 0x40204 |
| ITF_E_COMM_FAILURE_YES    | 0x41204 |
| ITF_E_COMM_FAILURE_MAYBE  | 0x42204 |
| ITF_E_INV_OBJREF_NO       | 0x40205 |
| ITF_E_INV_OBJREF_YES      | 0x41205 |
| ITF_E_INV_OBJREF_MAYBE    | 0x42205 |
| ITF_E_NO_PERMISSION_NO    | 0x40206 |
| ITF_E_NO_PERMISSION_YES   | 0x41206 |
| ITF_E_NO_PERMISSION_MAYBE | 0x42206 |
| ITF_E_INTERNAL_NO         | 0x40207 |
| ITF_E_INTERNAL_YES        | 0x41207 |
| ITF_E_INTERNAL_MAYBE      | 0x42207 |
| ITF_E_MARSHAL_NO          | 0x40208 |
| ITF_E_MARSHAL_YES         | 0x41208 |
| ITF_E_MARSHAL_MAYBE       | 0x42208 |
| ITF_E_INITIALIZE_NO       | 0x40209 |
| ITF_E_INITIALIZE_YES      | 0x41209 |
| ITF_E_INITIALIZE_MAYBE    | 0x42209 |
| ITF_E_NO_IMPLEMENT_NO     | 0x4020A |
| ITF_E_NO_IMPLEMENT_YES    | 0x4120A |
| ITF_E_NO_IMPLEMENT_MAYBE  | 0x4220A |
| ITF_E_BAD_TYPECODE_NO     | 0x4020B |
| ITF_E_BAD_TYPECODE_YES    | 0x4120B |
| ITF_E_BAD_TYPECODE_MAYBE  | 0x4220B |
| ITF_E_BAD_OPERATION_NO    | 0x4020C |
| ITF_E_BAD_OPERATION_YES   | 0x4120C |
| ITF_E_BAD_OPERATION_MAYBE | 0x4220C |

Table 18-3 Standard Exception to SCODE Mapping (Continued)

|                           |         |
|---------------------------|---------|
| ITF_E_NO_RESOURCES_NO     | 0x4020D |
| ITF_E_NO_RESOURCES_YES    | 0x4120D |
| ITF_E_NO_RESOURCES_MAYBE  | 0x4220D |
| ITF_E_NO_RESPONSE_NO      | 0x4020E |
| ITF_E_NO_RESPONSE_YES     | 0x4120E |
| ITF_E_NO_RESPONSE_MAYBE   | 0x4220E |
| ITF_E_PERSIST_STORE_NO    | 0x4020F |
| ITF_E_PERSIST_STORE_YES   | 0x4120F |
| ITF_E_PERSIST_STORE_MAYBE | 0x4220F |
| ITF_E_BAD_INV_ORDER_NO    | 0x40210 |
| ITF_E_BAD_INV_ORDER_YES   | 0x41210 |
| ITF_E_BAD_INV_ORDER_MAYBE | 0x42210 |
| ITF_E_TRANSIENT_NO        | 0x40211 |
| ITF_E_TRANSIENT_YES       | 0x41211 |
| ITF_E_TRANSIENT_MAYBE     | 0x42211 |
| ITF_E_FREE_MEM_NO         | 0x40212 |
| ITF_E_FREE_MEM_YES        | 0x41212 |
| ITF_E_FREE_MEM_MAYBE      | 0x42212 |
| ITF_E_INV_IDENT_NO        | 0x40213 |
| ITF_E_INV_IDENT_YES       | 0x41213 |
| ITF_E_INV_IDENT_MAYBE     | 0x42213 |
| ITF_E_INV_FLAG_NO         | 0x40214 |
| ITF_E_INV_FLAG_YES        | 0x41214 |
| ITF_E_INV_FLAG_MAYBE      | 0x42214 |
| ITF_E_INTF_REPOS_NO       | 0x40215 |
| ITF_E_INTF_REPOS_YES      | 0x41215 |
| ITF_E_INTF_REPOS_MAYBE    | 0x42215 |
| ITF_E_BAD_CONTEXT_NO      | 0x40216 |
| ITF_E_BAD_CONTEXT_YES     | 0x41216 |

Table 18-3 Standard Exception to SCODE Mapping (Continued)

|                                    |         |
|------------------------------------|---------|
| ITF_E_BAD_CONTEXT_MAYBE            | 0x42216 |
| ITF_E_OBJ_ADAPTER_NO               | 0x40217 |
| ITF_E_OBJ_ADAPTER_YES              | 0x41217 |
| ITF_E_OBJ_ADAPTER_MAYBE            | 0x42217 |
| ITF_E_DATA_CONVERSION_NO           | 0x40218 |
| ITF_E_DATA_CONVERSION_YES          | 0x41218 |
| ITF_E_DATA_CONVERSION_MAYBE        | 0x42218 |
| ITF_E_OBJ_NOT_EXIST_NO             | 0X40219 |
| ITF_E_OBJ_NOT_EXIST_MAYBE          | 0X41219 |
| ITF_E_OBJ_NOT_EXIST_YES            | 0X42219 |
| ITF_E_TRANSACTION_REQUIRED_NO      | 0x40220 |
| ITF_E_TRANSACTION_REQUIRED_MAYBE   | 0x41220 |
| ITF_E_TRANSACTION_REQUIRED_YES     | 0x42220 |
| ITF_E_TRANSACTION_ROLLEDBACK_NO    | 0x40221 |
| ITF_E_TRANSACTION_ROLLEDBACK_MAYBE | 0x41221 |
| ITF_E_TRANSACTION_ROLLEDBACK_YES   | 0x42221 |
| ITF_E_INVALID_TRANSACTION_NO       | 0x40222 |
| ITF_E_INVALID_TRANSACTION_MAYBE    | 0x41222 |
| ITF_E_INVALID_TRANSACTION_YES      | 0x42222 |

It is not possible to map a System Exception's minor code and RepositoryId into the HRESULT. Therefore, OLE Error Objects may be used to convey these data. Writing the exception information to an OLE Error Object is optional. However, if the Error Object is used for this purpose, it must be done according to the following specifications.

- The COM View must implement the standard COM interface ISupportErrorInfo such that the View can respond affirmatively to an inquiry from the client as to whether Error Objects are supported by the View Interface.
- The COM View must call SetErrorInfo with a NULL value for the IErrorInfo pointer parameter when the mapped CORBA operation is completed without an exception being raised. Calling **SetErrorInfo** in this fashion assures that the Error Object on that thread is thoroughly destroyed.

The properties of the OLE Error Object must be set according to Table 18-4.

Table 18-4 Error Object Usage for CORBA System Exceptions

| Property        | Description                                                                                                                                                                                                                                                                                                                                                                                           |
|-----------------|-------------------------------------------------------------------------------------------------------------------------------------------------------------------------------------------------------------------------------------------------------------------------------------------------------------------------------------------------------------------------------------------------------|
| bstrSource      | <interface name>.<operation name><br>where the interface and operation names are those of the CORBA interface that this Automation View is representing.                                                                                                                                                                                                                                              |
| bstrDescription | CORBA System Exception: [<exception repository id> minor code [<minor code>][<completion status>]<br>where the <exception repository id> and <minor code> are those of the CORBA system exception. <completion status> is “YES,” “NO,” or “MAYBE” based upon the value of the system exception’s CORBA completion status. Spaces and square brackets are literals and must be included in the string. |
| bstrHelpFile    | Unspecified                                                                                                                                                                                                                                                                                                                                                                                           |
| dwHelpContext   | Unspecified                                                                                                                                                                                                                                                                                                                                                                                           |
| GUID            | The IID of the COM View Interface                                                                                                                                                                                                                                                                                                                                                                     |

A COM View supporting error objects would have code, which approximates the following C++ example.

```
SetErrorInfo(OL,NULL); // Initialize the thread-local error
object
try
{
 // Call the CORBA operation
}
catch(...)
{
 ...

 CreateErrorInfo(&pICreateErrorInfo);
 pICreateErrorInfo->SetSource(...);
 pICreateErrorInfo->SetDescription(...);
 pICreateErrorInfo->SetGUID(...);
 pICreateErrorInfo
->QueryInterface(IID_IErrorInfo,&pIErrorInfo);
 pICreateErrorInfo->SetErrorInfo(OL,pIErrorInfo);
 pIErrorInfo->Release();
 pICreateErrorInfo->Release();

 ...
}
```

A client to a COM View would access the OLE Error Object with code approximating the following.

```

// After obtaining a pointer to an interface on
// the COM View, the
// client does the following one time

pIMyMappedInterface->QueryInterface(IID_ISupportErrorInfo,
 &pISupportErrorInfo);

hr = pISupportErrorInfo
 ->InterfaceSupportsError-
Info(IID_MyMappedInterface);
BOOL bSupportsErrorInfo = (hr == NOERROR ? TRUE : FALSE);
...
// Call to the COM operation...
HRESULT hrOperation = pIMyMappedInterface->...

if (bSupportsErrorInfo)
{
 HRESULT hr = GetErrorInfo(0,&pIErrorInfo);

 // S_FALSE means that error data is not available,
 NO_ERROR
 // means it is
 if (hr == NO_ERROR)
 {
 pIErrorInfo->GetSource(...);

 // Has repository id & minor code. hrOperation
(above) // has the completion status encoded into it.
 pIErrorInfo->GetDescription(...);
 }
}

```

### *Mapping for User Exception Types*

User exceptions are defined by users in OMG IDL and used by the methods in an object server to report operation-specific errors. The definition of a User Exception is identified in an OMG IDL file with the keyword `exception`. The body of a User Exception is described using the syntax for describing a structure in OMG IDL.

When CORBA User Exceptions are mapped into COM, a structure is used to describe various information about the exception — hereafter called an Exception structure. The structure contains members, which indicate the type of the CORBA exception, the identifier of the exception definition in a CORBA Interface Repository, and interface pointers to User Exceptions. If an interface raises a user exception, a structure is constructed whose name is the interface name [fully scoped] followed by “Exceptions.” For example, if an operation in **MyModule:MyInterface** raises a user exception, then there will be a structure created named **MyModule\_MyInterfaceExceptions**.

A template illustrating this naming convention is as follows.

```

// Microsoft IDL and ODL
typedef enum { NO_EXCEPTION, USER_EXCEPTION}
 ExceptionType;

typedef struct
{
 ExceptionType type;
 LPTSTR repositoryId;
 I<ModuleName_InterfaceName>UserException
 *...piUserException;
} <ModuleName_InterfaceName>Exceptions;

```

The Exceptions structure is specified as an output parameter, which appears as the last parameter of any operation mapped from OMG IDL to Microsoft IDL, which raises a User Exception. The Exceptions structure is always passed by indirect reference. Because of the memory management rules of COM, passing the Exceptions structure as an output parameter by indirect reference allows the parameter to be treated as optional by the callee<sup>1</sup>. The following example illustrates this point.

```

// Microsoft IDL
interface IBANKAccount
{
 HRESULT Withdraw([in] float fAmount,
 [out] float pfNewBalance,
 [out] BANK_AccountExceptions
 ** pException);
};

```

The caller can indicate that no exception information should be returned, if an exception occurs, by specifying NULL as the value for the Exceptions parameter of the operation. If the caller expects to receive exception information, it must pass the address of a pointer to the memory in which the exception information is to be placed. COM's memory management rules state that it is the responsibility of the caller to release this memory when it is no longer required.

If the caller provides a non-NULL value for the Exceptions parameter and the callee is to return exception information, the callee is responsible for allocating any memory used to hold the exception information being returned. If no exception is to be returned, the callee need do nothing with the parameter value.

If a CORBA exception is not raised, then S\_OK must be returned as the value of the HRESULT to the callee, indicating the operation succeeded. The value of the HRESULT returned to the callee when a CORBA exception has been raised depends upon the type of exception being raised and whether an Exception structure was specified by the caller.

---

1. Vendors that map the MIDL definition directly to C++ should map the exception struct parameter as defaulting to a NULL pointer.



The following OMG IDL statements show the definition of the format used to represent User Exceptions.

```
// OMG IDL
module BANK
{
 ...
 exception InsufFunds { float balance };
 exception InvalidAmount { float amount };
 ...
 interface Account
 {
 exception NotAuthorized { };
 float Deposit(in float Amount)
 raises(InvalidAmount);
 float Withdraw(in float Amount)
 raises(InvalidAmount, NotAuthorized);
 };
};
```

and map to the following statements in Microsoft IDL and ODL.

```
// Microsoft IDL and ODL
struct Bank_InsufFunds
{
 float balance;
};

struct Bank_InvalidAmount
{
 float amount;
};

struct BANK_Account_NotAuthorized
{
};

interface IBANK_AccountUserExceptions : IUnknown
{
 HRESULT _get_InsufFunds([out] BANK_InsufFunds
 * exceptionBody);
 HRESULT _get_InvalidAmount([out] BANK_InvalidAmount
 * exceptionBody);
 HRESULT _get_NotAuthorized([out]
 BANK_Account_NotAuthorized
 * exceptionBody);
};

typedef struct
{
```

```

 ExceptionType type;
 LPTSTR repositoryId;
 IBANK_AccountUserExceptions * piUserException;
 } BANK_AccountExceptions;

```

User exceptions are mapped to a COM interface and a structure that describes the body of information to be returned for the User Exception. A COM interface is defined for each CORBA interface containing an operation that raises a User Exception. The name of the interface defined for accessing User Exception information is constructed from the fully scoped name of the CORBA interface on which the exception is raised. A structure is defined for each User Exception, which contains the body of information to be returned as part of that exception. The name of the structure follows the naming conventions used to map CORBA structure definitions.

Each User Exception that can be raised by an operation defined for a CORBA interface is mapped into an operation on the Exception interface. The name of the operation is constructed by prefixing the name of the exception with the string “\_get\_”. Each accessor operation defined takes one output parameter in which to return the body of information defined for the User Exception. The data type of the output parameter is a structure that is defined for the exception. The operation is defined to return an HRESULT value.

If a CORBA User Exception is to be raised, the value of the HRESULT returned to the caller is E\_FAIL.

If the caller specified a non-NULL value for the Exceptions structure parameter, the callee must allocate the memory to hold the exception information and fill in the Exceptions structure as in Table 18-5.

Table 18-5 User Exceptions Structure

| Member          | Description                                                                              |
|-----------------|------------------------------------------------------------------------------------------|
| type            | Indicates the type of CORBA exception that is being raised. Must be USER_EXCEPTION.      |
| repositoryId    | Indicates the repository identifier for the exception definition.                        |
| piUserException | Points to an interface with which to obtain information about the User Exception raised. |

When data conversion errors occur while mapping the data types between object models (during a call from a COM client to a CORBA server), an HRESULT with the code E\_DATA\_CONVERSION and the facility value FACILITY\_NULL is returned to the client.

### ***Mapping User Exceptions: A Special Case***

If a CORBA operation raises only one (COM\_ERROR or COM\_ERRorex) user exception (defined under Section 18.3.10.2, “Mapping for COM Errors,” on page 18-44), then the mapped COM operation should not have the additional parameter

for exceptions. This proviso enables a CORBA implementation of a preexisting COM interface to be mapped back to COM without altering the COM operation's original signature.

COM\_ERROR (and COM\_ERROREX) is defined as part of the CORBA to COM mapping. However, this special rule in effect means that a COM\_ERROR raises clause can be added to an operation specifically to indicate that the operation was originally defined as a COM operation.

### 18.2.10.3 Mapping for Nested Types

OMG IDL and Microsoft MIDL/ODL do not agree on the scoping level of types declared within interfaces. Microsoft, for example, considers all types in a MIDL or ODL file to be declared at global scope. OMG IDL considers a type to be scoped within its enclosing module or interface. This means that to prevent accidental name collisions, types declared within OMG IDL modules and OMG IDL interfaces must be fully qualified in Microsoft IDL or ODL.

The OMG IDL construct:

```
Module BANK{
 interface ATM {
 enum type {CHECKS, CASH};
 Struct DepositRecord {
 string account;
 float amount;
 type kind;
 };
 void deposit (in DepositRecord val);
 };
};
```

Must be mapped in Microsoft MIDL as:

```
[uuid(...), object]
interface IBANK ATM : IUnknown {
 typedef [v1 enum] enum
 {BANK ATM CHECKS,
 BANK ATM CASH} BANK ATM type;
 typedef struct {
 LPSTR account;
 BANK ATM type kind;
 } BANK ATM DepositRecord;
 HRESULT deposit (in BANK ATM DepositRecord *val);
};
```

and to Microsoft ODL as:

```
[uuid(...)]
library BANK {
 ...
 [uuid(...), object]
```

```

interface IBANK ATM : IUnknown {
 typedef enum { BANK ATM CHECKS,
 {BANK ATM CASH} BANK ATM type;
 typedef struct {
 LPSTR struct;
 float amount;
 BANK ATM type kind;
 } BANK ATM DepositRecord;
 HRESULT deposit (in BANK ATM DepositRecord *val);
};

```

#### 18.2.10.4 Mapping for Operations

Operations defined for an interface are defined in OMG IDL within interface definitions. The definition of an operation constitutes the operations signature. An operation signature consists of the operation's name, parameters (if any), and return value. Optionally, OMG IDL allows the operation definition to indicate exceptions that can be raised, and the context to be passed to the object as implicit arguments, both of which are considered part of the operation.

OMG IDL parameter directional attributes **in**, **out**, **inout** map directly to Microsoft IDL and ODL parameter direction attributes [**in**], [**out**], [**in,out**]. Operation request parameters are represented as the values of **in** or **inout** parameters in OMG IDL, and operation response parameters are represented as the values of **inout** or **out** parameters. An operation return result can be any type that can be defined in OMG IDL, or void if a result is not returned.

The OMG IDL sample (shown below) illustrates the definition of two operations on the Bank interface. The names of the operations are bolded to make them stand out. Operations can return various types of data as results, including nothing at all. The operation **Bank::Transfer** is an example of an operation that does not return a value. The operation **Bank::Open Account** returns an object as a result of the operation.

```

// OMG IDL
#pragma ID::BANK::Bank"IDL:BANK/Bank:1,2"
interface Bank
{
 Account OpenAccount(in float StartingBalance,
 in AccountTypes Account(Type);
 void Transfer(in Account Account1,
 in Account Account2,
 in float Account)
 raises(InSufFunds);
};

```

The operations defined in the preceding OMG IDL code are mapped to the following lines of Microsoft IDL code:

```

// Microsoft IDL
[object, uuid(682d22fb-78ac-0000-0c03-4d0000000000),
 pointer_default(unique)]

```

```

interface IBANK Teller: IUnknown
{
 HRESULT OpenAccount(
 [in] float StartingBalance,
 [in] BANK_AccountTypes AccountType,
 [out] IBANK_Account ** ppiNewAccount);
 HRESULT Transfer(
 [in] IBANK_Account * Account1,
 [in] IBANK_Account * Account2,
 [in] float Amount,
 [out] BANK_TellerExceptions
 ** ppException);
};

```

and to the following statements in Microsoft ODL

```

// Microsoft ODL
[uuid(682d22fb-78ac-0000-0c03-4d0000000000) odl]
interface IBANK_Teller: IUnknown
{
 HRESULT OpenAccount(
 [in] float StartingBalance,
 [in] BANK_AccountTypes AccountType,
 [out, retval] IBANK_Account
 ** ppiNewAccount);
 HRESULT Transfer(
 [in] IBANK_Account * Account1,
 [in] IBANK_Account * Account2,
 [in] float Amount,
 [out]BANK_TellerExceptions
 ** ppException);
};

```

The ordering and names of parameters in the Microsoft IDL and ODL mapping is identical to the order in which parameters are specified in the text of the operation definition in OMG IDL. The COM mapping of all CORBA operations must obey the COM memory ownership and allocation rules specified.

It is important to note that the signature of the operation as written in OMG IDL is different from the signature of the same operation in Microsoft IDL or ODL. In particular, the result value returned by an operation defined in OMG IDL will be mapped as an output argument at the end of the signature when specified in Microsoft IDL or ODL. This allows the signature of the operation to be natural to the COM developer. When a result value is mapped as an output argument, the result value becomes an HRESULT. Without an HRESULT return value, there would be no way for COM to signal errors to clients when the client and server are not collocated. The value of the HRESULT is determined based on a mapping of the CORBA exception, if any, that was raised.

It is also important to note that if any user's exception information is defined for the operation, an additional parameter is added as the last argument of the operation signature. The user exception parameter follows the return value parameter, if both exist. See Section 18.2.10.2, "Mapping for exception types," on page 18-11 for further details.

### 18.2.10.5 *Mapping for Oneway Operations*

OMG IDL allows an operation's definition to indicate the invocation semantics the communication service must provide for an operation. This indication is done through the use of an operation attribute. Currently, the only operation attribute defined by CORBA is the oneway attribute.

The oneway attribute specifies that the invocation semantics are best-effort, which does not guarantee delivery of the request. Best-effort implies that the operation will be invoked, at most, once. Along with the invocation semantics, the use of the oneway operation attribute restricts an operation from having output parameters, must have no result value returned, and cannot raise any user-defined exceptions.

It may seem that the Microsoft IDL **maybe** operation attribute provides a closer match since the caller of an operation does not expect any response. However, Microsoft RPC maybe does not guarantee at most once semantics, and therefore is not sufficient. Because of this, the mapping of an operation defined in OMG IDL with the oneway operation attribute maps the same as an operation that has no output arguments.

### 18.2.10.6 *Mapping for Attributes*

OMG IDL allows the definition of attributes for an interface. Attributes are essentially a short-hand for a pair of accessor functions to an object's data; one to retrieve the value and possibly one to set the value of the attribute. The definition of an attribute must be contained within an interface definition and can indicate whether the value of the attribute can be modified or just read. In the example OMG IDL next, the attribute Profile is defined for the Customer interface and the read-only attribute is Balance-defined for the Account interface. The keyword attribute is used by OMG IDL to indicate that the statement is defining an attribute of an interface.

The definition of attributes in OMG IDL are restricted from raising any user-defined exceptions. Because of this, the implementation of an attribute's accessor function is limited to only raising system exceptions. The value of the HRESULT is determined based on a mapping of the CORBA exception, if any, that was raised.

```
// OMG IDL
struct CustomerData
{
 CustomerId Id;
 string Name;
 string SurName;
};
```

```
#pragma ID::BANK::Account "IDL:BANK/Account:3.1"
```

```
interface Account
```

```
{
 readonly attribute float Balance;
 float Deposit(in float amount) raises(InvalidAmount);
 float Withdrawal(in float amount) raises(InsufFunds, InvalidAmount);
 float Close();
};
```

```
#pragma ID::BANK::Customer "IDL:BANK/Customer:1.2"
```

```
interface Customer
```

```
{
 attribute CustomerData Profile;
};
```

When mapping attribute statements in OMG IDL to Microsoft IDL or ODL, the name of the get accessor is the same as the name of the attribute prefixed with `_get_` in Microsoft IDL and contains the operation attribute [`propget`] in Microsoft ODL. The name of the put accessor is the same as the name of the attribute prefixed with `_put_` in Microsoft IDL and contains the operation attribute [`propput`] in Microsoft ODL.

### *Mapping for Read-Write Attributes*

In OMG IDL, attributes are defined as supporting a pair of accessor functions: one to retrieve the value and one to set the value of the attribute, unless the keyword `readonly` precedes the attribute keyword. In the preceding example, the attribute `Profile` is mapped to the following statements in Microsoft IDL.

```
// Microsoft IDL
[object, uuid(682d22fb-78ac-0000-0c03-4d0000000000),
 pointer_default(unique)]
interface ICustomer : IUnknown
{
 HRESULT _get_Profile([out] CustomerData * Profile);
 HRESULT _put_Profile([in] CustomerData * Profile);
};
```

`Profile` is mapped to these statements in Microsoft ODL.

```
// Microsoft ODL
[uuid(682d22fb-78ac-0000-0c03-4d0000000000)]
interface IBANK_Customer : IUnknown
{
 [propget] HRESULT Profile(
 [out] BANK_CustomerData * val);
 [propput] HRESULT Profile(
 [in] BANK_CustomerData * val);
};
```

---

**Note** – The attribute is actually mapped as two different operations in both Microsoft IDL and ODL. The `IBANK_Customer::get_profile` operation (in Microsoft IDL) and the `[propget]` Profile operation (in Microsoft ODL) are used to retrieve the value of the attribute. The `IBANK_Customer::put_profile` operation is used to set the value of the attribute.

---

### *Mapping for Read-Only Attributes*

In OMG IDL, an attribute preceded by the keyword `readonly` is interpreted as only supporting a single accessor function used to retrieve the value of the attribute. In the previous example, the mapping of the attribute `Balance` is mapped to the following statements in Microsoft IDL.

```
// Microsoft IDL
[object, uuid(682d22fb-78ac-0000-0c03-4d0000000000)]
interface IAccount: IUnknown
{
 HRESULT _get_Balance([out] float Balance);
};
```

and the following statements in Microsoft ODL.

```
// Microsoft ODL
[uuid(682d22fb-78ac-0000-0c03-4d0000000000)]
interface IAccount: IUnknown
{
 [propget] HRESULT Balance([out] float *val);
};
```

Note that only a single operation was defined since the attribute was defined to be read-only.

### *18.2.10.7 Indirection Levels for Operation Parameters*

- For integral types (such as long, enum, char,...) these are passed by value as [in] parameters and by reference as out parameters.
- string/wstring parameters are passed as LPSTR/LPWSTR as an in parameter and LPSTR\*/LPWSTR\* as an out parameter.
- composite types (such as unions, structures, exceptions) are passed by reference for both [in] and [out] parameters.
- optional parameters are passed using double indirection (e.g., `IntfException ** val`).

### *18.2.11 Inheritance Mapping*

Both CORBA and COM have similar models for individual interfaces. However, the models for inheritance and multiple interfaces are different.



In CORBA, an interface can singly or multiply inherit from other interfaces. In language bindings supporting typed object references, widening and narrowing support convert object references as allowed by the true type of that object.

However, there is no built-in mechanism in CORBA to access interfaces without an inheritance relationship. The run-time interfaces of an object, as defined in CORBA (for example, `CORBA::Object::is_a`, `CORBA::Object::get_interface`) use a description of the object's principle type, which is defined in OMG IDL. CORBA allows many ways in which implementations of interfaces can be structured, including using implementation inheritance.

In COM V2.0, interfaces can have single inheritance. However, as opposed to CORBA, there is a standard mechanism by which an object can have multiple interfaces (without an inheritance relationship between those interfaces) and by which clients can query for these at run-time. (It defines no common way to determine if two interface references refer to the same object, or to enumerate all the interfaces supported by an entity.)

An observation about COM is that some COM objects have a required minimum set of interfaces, which they must support. This type of statically defined interface relation is conceptually equivalent to multiple inheritance; however, discovering this relationship is only possible if ODL or type libraries are always available for an object.

COM describes two main implementation techniques: aggregation and delegation. C++ style implementation inheritance is not possible.

The mapping for CORBA interfaces into COM is more complicated than COM interfaces into CORBA, since CORBA interfaces might be multiply-inherited and COM does not support multiple interface inheritance.

If a CORBA interface is singly inherited, this maps directly to single inheritance of interfaces in COM. The base interface for all CORBA inheritance trees is `IUnknown`. Note that the `Object` interface is not surfaced in COM. For single inheritance, although the most derived interface can be queried using `IUnknown::QueryInterface`, each individual interface in the inheritance hierarchy can also be queried separately.

The following rules apply to mapping CORBA to COM inheritance.

- Each OMG IDL interface that does not have a parent is mapped to an MIDL interface deriving from `IUnknown`.
- Each OMG IDL interface that inherits from a single parent interface is mapped to an MIDL interface that derives from the mapping for the parent interface.
- Each OMG IDL interface that inherits from multiple parent interfaces is mapped to an MIDL interface deriving from `IUnknown`.
- For each CORBA interface, the mapping for operations precede the mapping for attributes.
- Operations are sorted in ascending order based upon the ISO Latin-1 encoding values of the respective operation names.

- The resulting mapping of attributes within an interface are ordered based upon the attribute name. The attributes are similarly sorted in ascending order based upon the ISO-Latin-1 encoding values of the respective attribute names. If the attribute is not readonly, the get\_<attribute name> method immediately precedes the set\_<attribute name> method.

## CORBA Interface Inheritance

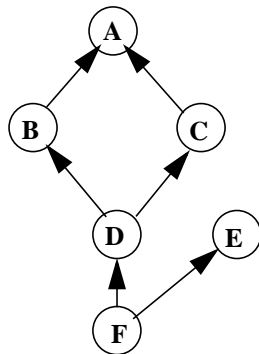

## COM Interface Inheritance

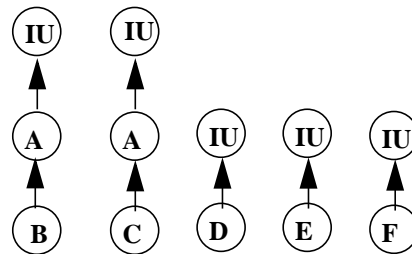

Figure 18-1 CORBA Interface Inheritance to COM Interface Inheritance Mapping

```

//OMG IDL
//
interface A {
 void opA();
 attribute long val;
};
interface B : A {
 void opB();
};
interface C : A {
 void opC();
};
interface D : B, C {
 void opD();
};
interface E {
 void opE();
};
interface F : D, E {
 void opF();
};

//Microsoft MIDL
//
[object, uuid(b97267fa-7855-e044-71fb-12fa8a4c516f)]
interface IA: IUnknown{
 HRESULT opA();
};

```

```

 HRESULT get_val([out] long * val);
 HRESULT set_val([in] long val);
 };
 [object, uuid(fa2452c3-88ed-1c0d-f4d2-fcf91ac4c8c6)]
 interface IB: IA {
 HRESULT opB();
 };
 [object, uuid(dc3a6c32-f5a8-d1f8-f8e2-64566f815ed7)]
 interface IC: IA {
 HRESULT opC();
 };
 [object, uuid(b718adec-73e0-4ce3-fc72-0dd11a06a308)]
 interface ID: IUnknown {
 HRESULT opD();
 };
 [object, uuid(d2cb7bbc-0d23-f34c-7255-d924076e902f)]
 interface IE: IUnknown{
 HRESULT opE();
 };
 [object, uuid(de6ee2b5-d856-295a-fd4d-5e3631fbfb93)]
 interface IF: IUnknown {
 HRESULT opF();
 };
};

```

Note that the **co-class** statement in Microsoft ODL allows the definition of an object class that allows QueryInterface between a set of interfaces.

Also note that when the interface defined in OMG IDL is mapped to its corresponding statements in Microsoft IDL, the name of the interface is preceded by the letter I to indicate that the name represents the name of an interface. This also makes the mapping more natural to the COM programmer, since the naming conventions used follow those suggested by Microsoft.

### 18.2.12 Mapping for Pseudo-Objects

CORBA defines a number of different kinds of pseudo-objects. Pseudo-objects differ from other objects in that they cannot be invoked with the Dynamic Invocation Interface (DII) and do not have object references. Most pseudo-objects cannot be used as general arguments. Currently, only the TypeCode and Principal pseudo-objects can be used as general arguments to a request in CORBA.

The CORBA NamedValue and NVList are not mapped into COM as arguments to COM operation signatures.

#### 18.2.12.1 Mapping for TypeCode pseudo-object

CORBA TypeCodes represent the types of arguments or attributes and are typically retrieved from the interface repository. The mapping of the CORBA TypeCode interface follows the same rules as mapping any other CORBA interface to COM. The result of this mapping is as follows.

```

// Microsoft IDL or ODL
typedef struct { } TypeCodeBounds;
typedef struct { } TypeCodeBadKind;

[uuid(9556EA20-3889-11cf-9586-AA0004004A09), object,
 pointer_default(unique)]

interface ICORBA_TypeCodeUserExceptions : IUnknown
{
 HRESULT _get_Bounds([out] TypeCodeBounds *pExceptionBody);
 HRESULT _get_BadKind([out] TypeCodeBadKind * pExceptionBody);
};

typedef struct
{
 ExceptionType type;
 LPTSTR repositoryId;
 long minorCode;
 CompletionStatus completionStatus;
 ICORBA_SystemException * pSystemException;
 ICORBA_TypeCodeExceptions * pUserException;
} CORBA_TypeCodeExceptions;

typedef LPTSTR RepositoryId;
typedef LPTSTR Identifier;

typedef [v1_enum]
enum tagTCKind { tk_null = 0, tk_void, tk_short,
 tk_long, tk_ushort, tk_ulong,
 tk_float, tk_double, tk_octet,
 tk_any, tk_TypeCode,
 tk_principal, tk_objref,
 tk_struct, tk_union, tk_enum,
 tk_string, tk_sequence,
 tk_array, tk_alias, tk_except
} CORBA_TCKind;

[uuid(9556EA21-3889-11cf-9586-AA0004004A09), object,
 pointer_default(unique)]

interface ICORBA_TypeCode : IUnknown
{
 HRESULT equal(
 [in] ICORBA_TypeCode * piTc,
 [out] boolean * pbRetVal,
 [out] CORBA_TypeCodeExceptions** ppUserExceptions);
 HRESULT kind(
 [out] TCKind * pRetVal,
 [out] CORBA_TypeCodeExceptions ** ppUserExceptions);
 HRESULT id(
 [out] RepositoryId * pszRetVal,
 [out] CORBA_TypeCodeExceptions ** ppUserExceptions);
 HRESULT name(
 [out] Identifier * pszRetVal,

```

```

 [out] CORBA_TypeCodeExceptions ** ppUserExceptions);
HRESULT member_count(
 [out] unsigned long * pulRetVal,
 [out] CORBA_TypeCodeExceptions ** ppUserExceptions);
HRESULT member_name(
 [in] unsigned long ulIndex,
 [out] Identifier * pszRetVal,
 [out] CORBA_TypeCodeExceptions ** ppUserExceptions);
HRESULT member_type(
 [in] unsigned long ulIndex,
 [out] ICORBA_TypeCode ** ppRetVal,
 [out] CORBA_TypeCodeExceptions ** ppUserExceptions);
HRESULT member_label(
 [in] unsigned long ulIndex,
 [out] ICORBA_Any ** ppRetVal,
 [out] CORBA_TypeCodeExceptions ** ppUserExceptions);
HRESULT discriminator_type(
 [out] ICORBA_TypeCode ** ppRetVal,
 [out] CORBA_TypeCodeExceptions ** ppUserExceptions);
HRESULT default_index(
 [out] long * plRetVal,
 [out] CORBA_TypeCodeExceptions ** ppUserExceptions);
HRESULT length(
 [out] unsigned long * pulRetVal,
 [out] CORBA_TypeCodeExceptions ** ppUserExceptions);
HRESULT content_type(
 [out] ICORBA_TypeCode ** ppRetVal,
 [out] CORBA_TypeCodeExceptions ** ppUserExceptions);
HRESULT param_count(
 [out] long * plRetVal,
 [out] CORBA_TypeCodeExceptions ** ppUserExceptions);
HRESULT parameter(
 [in] long lIndex,
 [out] ICORBA_Any ** ppRetVal,
 [out] CORBA_TypeCodeExceptions ** ppUserExceptions
);
}

```

---

**Note** – Use of the methods `param_count()` and `parameter()` is deprecated.

---

### 18.2.12.2 Mapping for context pseudo-object

This specification provides no mapping for CORBA's Context pseudo-object into COM. Implementations that choose to provide support for Context could do so in the following way. Context pseudo-objects should be accessed through the **ICORBA Context** interface. This would allow clients (if they are aware that the object they are dealing with is a CORBA object) to set a single Context pseudo-object to be used for all subsequent invocations on the CORBA object from the client process space until such time as the **ICORBA\_Context** interface is released.

```

// Microsoft IDL and ODL
typedef struct

```

```

 {
 unsigned long cbMaxSize;
 unsigned long cbLengthUsed;
 [size_is(cbMaxSize), length_is(cbLengthUsed), unique]
 LPTSTR * pszValue;
 } ContextPropertyValue;

[object, uuid(74105F51-3C68-11cf-9588-AA0004004A09),
 pointer_default(unique)]
interface ICORBA_Context: IUnknown
{
 HRESULT GetProperty([in]LPTSTR Name,
 [out] ContextPropertyValue
 ** pValues);

 HRESULT SetProperty([in] LPTSTR,
 [in] ContextPropertyValue
 * pValues);
};

```

If a COM client application knows it is using a CORBA object, the client application can use **QueryInterface** to obtain an interface pointer to the **ICORBA\_Context** interface. Obtaining the interface pointer results in a CORBA context pseudo-object being created in the View, which is used with any CORBA request operation that requires a reference to a CORBA context object. The context pseudo-object should be destroyed when the reference count on the **ICORBA\_Context** interface reaches zero.

This interface should only be generated for CORBA interfaces that have operations defined with the context clause.

### 18.2.12.3 Mapping for principal pseudo-object

The CORBA Principal is not currently mapped into COM. As both the COM and CORBA security mechanisms solidify, security interworking will need to be defined between the two object models.

### 18.2.13 Interface Repository Mapping

Name spaces within the CORBA interface repository are conceptually similar to COM type libraries. However, the CORBA interface repository looks, to the client, to be one unified service. Type libraries, on the other hand, are each stored in a separate file. Clients do not have a unified, hierarchical interface to type libraries.

Table 18-6 defines the mapping between equivalent CORBA and COM interface description concepts. Where there is no equivalent, the field is left blank.

Table 18-6 CORBA Interface Repository to OLE Type Library Mappings

| TypeCode     | TYPEDESC  |
|--------------|-----------|
| Repository   |           |
| ModuleDef    | ITypeLib  |
| InterfaceDef | ITypeInfo |
| AttributeDef | VARDESC   |
| OperationDef | FUNCDESC  |
| ParameterDef | ELEMDESC  |
| TypeDef      | ITypeInfo |
| ConstantDef  | VARDESC   |
| ExceptionDef |           |

Using this mapping, implementations must provide the ability to call **Object::get\_interface** on CORBA object references to COM objects to retrieve an InterfaceDef. When CORBA objects are accessed from COM, implementations may provide the ability to retrieve the ITypeInfo for a CORBA object interface using the IProvideClassInfo COM interface.

## 18.3 COM to CORBA Data Type Mapping

### 18.3.1 Mapping for Basic Data Types

The basic data types available in Microsoft IDL and ODL map to the corresponding data types available in OMG IDL as shown in Table 18-7.

Table 18-7 Microsoft IDL and ODL to OMG IDL Intrinsic Data Type Mappings

| Microsoft IDL  | Microsoft ODL  | OMG IDL        | Description                                               |
|----------------|----------------|----------------|-----------------------------------------------------------|
| short          | short          | short          | Signed integer with a range of $-2^{15} \dots 2^{15} - 1$ |
| long           | long           | long           | Signed integer with a range of $-2^{31} \dots 2^{31} - 1$ |
| unsigned short | unsigned short | unsigned short | Unsigned integer with a range of $0 \dots 2^{16} - 1$     |
| unsigned long  | unsigned long  | unsigned long  | Unsigned integer with a range of $0 \dots 2^{32} - 1$     |
| float          | float          | float          | IEEE single -precision floating point number              |
| double         | double         | double         | IEEE double-precision floating point number               |

Table 18-7 Microsoft IDL and ODL to OMG IDL Intrinsic Data Type Mappings (Continued)

|         |               |         |                                                                                                  |
|---------|---------------|---------|--------------------------------------------------------------------------------------------------|
| char    | char          | char    | 8-bit quantity limited to the ISO Latin-1 character set                                          |
| boolean | boolean       | boolean | 8-bit quantity, which is limited to 1 and 0                                                      |
| byte    | unsigned char | octet   | 8-bit opaque data type, guaranteed to not undergo any conversion during transfer between systems |

### 18.3.2 Mapping for Constants

The mapping of the Microsoft IDL keyword `const` to OMG IDL `const` is almost exactly the same. The following Microsoft IDL definitions for constants:

```
// Microsoft IDL
const short S = ...;
const long L = ...;
const unsigned short US = ...;
const unsigned long UL = ...;
const float F = ...;
const double D = ...;
const char C = ...;
const boolean B = ...;
const string STR = "...";
```

map to the following OMG IDL definitions for constants.

```
// OMG IDL
const short S = ...;
const long L = ...;
const unsigned short US = ...;
const unsigned long UL = ...;
const float F = ...;
const double D = ...;
const char C = ...;
const boolean B = ...;
const string STR = "...";
```

### 18.3.3 Mapping for Enumerators

COM enumerations can have enumerators explicitly tagged with values. When COM enumerations are mapped into CORBA, the enumerators are presented in CORBA in increasing order according to their tagged values.

The Microsoft IDL or ODL specification:



```
// Microsoft IDL or ODL
typedef [v1_enum] enum tagA_or_B_orC { A = 0, B, C }
A_or_B_or_C;
```

would be represented as the following statements in OMG IDL:

```
// OMG IDL
enum A_or_B_or_C {B, C, A};
```

In this manner, the precedence relationship is maintained in the OMG system such that B is less than C is less than A.

OMG IDL does not support enumerators defined with explicit tagged values. The CORBA view of a COM object, therefore, is responsible for maintaining the correct tagged value of the mapped enumerators as they cross the view.

### 18.3.4 Mapping for String Types

COM support for strings includes the concepts of bounded and unbounded strings. Bounded strings are defined as strings that have a maximum length specified, whereas unbounded strings do not have a maximum length specified. COM also supports Unicode strings where the characters are wider than 8 bits. As in OMG IDL, non-Unicode strings in COM are NULL-terminated. The mapping of COM definitions for bounded and unbounded strings differs from that specified in OMG IDL.

Table 18-8 illustrates how to map the string data types in OMG IDL to their corresponding data types in both Microsoft IDL and ODL.

Table 18-8 Microsoft IDL/ODL to OMG IDL String Mappings

| Microsoft IDL                       | Microsoft ODL | OMG IDL | Description                             |
|-------------------------------------|---------------|---------|-----------------------------------------|
| LPSTR<br>[string,unique]<br>char *  | LPSTR,        | string  | Null-terminated 8-bit character string  |
| BSTR                                | BSTR          | wstring | Null-terminated 16-bit character string |
| LPWSTR<br>[string,unique]<br>char * | LPWSTR        | wstring | Null-terminated Unicode string          |

If a COM Server returns a BSTR containing embedded nulls to a CORBA client, a `E_DATA_CONVERSION` exception will be raised.

#### 18.3.4.1 Mapping for unbounded string types

The definition of an unbounded string in Microsoft IDL and ODL denotes the unbounded string as a stringified unique pointer to a character. The following Microsoft IDL statement

```
// Microsoft IDL
typedef [string, unique] char * UNBOUNDED_STRING;
```

is mapped to the following syntax in OMG IDL.

```
// OMG IDL
typedef string UNBOUNDED_STRING;
```

In other words, a value of type **UNBOUNDED\_STRING** is a non-NULL pointer to a one-dimensional null-terminated character array whose extent and number of valid elements can vary at run-time.

#### 18.3.4.2 Mapping for bounded string types

Bounded strings have a slightly different mapping between OMG IDL and Microsoft IDL. Bounded strings are expressed in Microsoft IDL as a “stringified nonconformant array.” The following Microsoft IDL and ODL definition for a bounded string:

```
// Microsoft IDL and ODL
const long N = ...;
typedef [string, unique] char (* BOUNDED_STRING) [N];
```

maps to the following syntax in OMG IDL.

```
// OMG IDL
const long N = ...;
typedef string<N> BOUNDED_STRING;
```

In other words, the encoding for a value of type **BOUNDED\_STRING** is that of a null-terminated array of characters whose extent is known at compile time, and whose number of valid characters can vary at run-time.

#### 18.3.4.3 Mapping for Unicode Unbounded String Types

The mapping for a Unicode unbounded string type in Microsoft IDL or ODL is no different from that used for ANSI string types. The following Microsoft IDL and ODL statement

```
// Microsoft IDL and ODL
typedef [string, unique] LPWSTR
UNBOUNDED_UNICODE_STRING;
```

is mapped to the following syntax in OMG IDL.

```
// OMG IDL
typedef wstring UNBOUNDED_UNICODE_STRING;
```

It is the responsibility of the mapping implementation to perform the conversions between ANSI and Unicode formats when dealing with strings.

#### 18.3.4.4 Mapping for unicode bound string types

The mapping for a Unicode bounded string type in Microsoft IDL or ODL is no different from that used for ANSI string types. The following Microsoft IDL and ODL statements

```
// Microsoft IDL and ODL
const long N = ...;
typedef [string, unique] wchar t(*
BOUNDED_UNICODE_STRING) [N];
```

map to the following syntax in OMG IDL.

```
// OMG IDL
const long N = ...;
typedef wstring<N> BOUNDED_UNICODE_STRING;
```

It is the responsibility of the mapping implementation to perform the conversions between ANSI and Unicode formats when dealing with strings.

#### 18.3.5 Mapping for Structure Types

Support for structures in Microsoft IDL and ODL maps bidirectionally to OMG IDL. Each structure member is mapped according to the mapping rules for that data type. The structure definition in Microsoft IDL or ODL is as follows.

```
// Microsoft IDL and ODL
typedef ... T0;
typedef ... T1;
...
typedef ...TN;
typedef struct
{
 T0 m0;
 T1 m1;
 ...
 TN mN;
} STRUCTURE;
```

The structure has an equivalent mapping in OMG IDL, as follows:

```

// OMG IDL
typedef ... T0
typedef ... T1;
...
typedef ... TN;
struct STRUCTURE
{
 T0 m0;
 T1 m1;
 ...
 Tn mn;
};

```

### 18.3.6 Mapping for Union Types

ODL unions are not discriminated unions and must be custom marshaled in any interfaces that use them. For this reason, this specification does not provide any mapping for ODL unions to CORBA unions.

MIDL unions, while always discriminated, are not required to be encapsulated. The discriminator for a nonencapsulated MIDL union could, for example, be another argument to the operation. The discriminants for MIDL unions are not required to be constant expressions.

#### 18.3.6.1 Mapping for Encapsulated Unions

When mapping from Microsoft IDL to OMG IDL, Microsoft IDL encapsulated unions having constant discriminators are mapped to OMG IDL unions as shown next.

```

// Microsoft IDL
typedef enum
{
 dchar,
 dShort,
 dLong,
 dFloat,
 dDouble
} UNION_DISCRIMINATOR;

typedef union switch (UNION_DISCRIMINATOR _d)
{
 case dChar: char c;
 case dShort: short s;
 case dLong: long l;
 case dFloat: float f;
 case dDouble: double d;
 default: byte v[8];
}UNION_OF_CHAR_AND_ARITHMETIC;

```

The OMG IDL definition is as follows.

```

// OMG IDL
enum UNION_DISCRIMINATOR
{
 dChar,
 dShort,
 dLong,
 dFloat,
 dDouble
};

union UNION_OF_CHAR_AND_ARITHMETIC
switch(UNION_DISCRIMINATOR)
{
 case dChar: char c;
 case dShort: short s;
 case dLong: long l;
 case dFloat: float f;
 case dDouble: double d;
 default: octet v[8];
};

```

### 18.3.6.2 Mapping for nonencapsulated unions

Microsoft IDL nonencapsulated unions and Microsoft IDL encapsulated unions with nonconstant discriminators are mapped to an **any** in OMG IDL. The type of the **any** is determined at run-time during conversion of the Microsoft IDL union.

```

// Microsoft IDL
typedef [switch_type(short)] union
tagUNION_OF_CHAR_AND_ARITHMETIC
{
 [case(0)] char c;
 [case(1)] short s;
 [case(2)] long l;
 [case(3)] float f;
 [case(4)] double d;
 [default] byte v[8];
} UNION_OF_CHAR_AND_ARITHMETIC;

```

The corresponding OMG IDL syntax is as follows.

```

// OMG IDL
typedef any UNION_OF_CHAR_AND_ARITHMETIC;

```

### 18.3.7 Mapping for Array Types

COM supports fixed-length arrays, just as in CORBA. As in the mapping from OMG IDL to Microsoft IDL, the arrays can be mapped bidirectionally. The type of the array elements is mapped according to the data type mapping rules. The following statements in Microsoft IDL and ODL describe a nonconformant and nonvarying array of U.

```
// Microsoft IDL for T
const long N = ...;
typedef ... U;
typedef U ARRAY_OF_N[N];
typedef float DTYPE[0..10]; // Equivalent to [11]
```

The value N can be of any integral type, and const means (as in OMG IDL) that the value of N is fixed and known at compilation time. The generalization to multidimensional arrays follows the obvious trivial mapping of syntax.

The corresponding OMG IDL syntax is as follows.

```
// OMG IDL for T
const long N = ...;
typedef ... T;
typedef T ARRAY_OF_N[N];
typedef float DTYPE[11];
```

#### 18.3.7.1 Mapping for nonfixed arrays

In addition to fixed length arrays, as well as conformant arrays, COM supports varying arrays, and conformant varying arrays. These are arrays whose bounds and size can be determined at run-time. Nonfixed length arrays in Microsoft IDL and ODL are mapped to sequence in OMG IDL, as shown in the following statements.

```
// Microsoft IDL
typedef short BTYPE[]; // Equivalent to [*];
typedef char CTYPE[*];
```

The corresponding OMG IDL syntax is as follows.

```
// OMG IDL
typedef sequence<short> BTYPE;
typedef sequence<char> CTYPE;
```

#### 18.3.7.2 Mapping for SAFEARRAY

Microsoft ODL also defines SAFEARRAY as a variable length, variable dimension array. Both the number of dimensions and the bounds of the dimensions are determined at run-time. Only the element type is predefined. A SAFEARRAY in Microsoft ODL is mapped to a CORBA sequence, as shown in the following statements.

```
// Microsoft ODL
SAFEARRAY(element-type) * ArrayName;
```

```
// OMG IDL
typedef sequence<element-type> SequenceName;
```

If a COM server returns a multidimensional SAFEARRAY to a CORBA client, an E\_DATA\_CONVERSION exception will be raised.

### 18.3.8 Mapping for VARIANT

The COM VARIANT provides semantically similar functionality to the CORBA **any**. However, its allowable set of data types are currently limited to the data types supported by Automation. VARTYPE is an enumeration type used in the VARIANT structure. The structure member *vt* is defined using the data type VARTYPE. Its value acts as the discriminator for the embedded union and governs the interpretation of the union. The list of valid values for the data type VARTYPE are listed in Table 18-9, along with a description of how to use them to represent the OMG IDL **any** data type.

Table 18-9 Valid OLE VARIANT Data Types

| Value               | Description                                                                                                                                                                         |
|---------------------|-------------------------------------------------------------------------------------------------------------------------------------------------------------------------------------|
| VT_EMPTY            | No value was specified. If an argument is left blank, you should <b>not</b> return VT_EMPTY for the argument. Instead, you should return the VT_ERROR value: DISP_E_MEMBERNOTFOUND. |
| VT_EMPTY   VT_BYREF | Illegal.                                                                                                                                                                            |
| VT_UI1              | An unsigned 1-byte character is stored in <i>bVal</i> .                                                                                                                             |
| VT_UI1   VT_BYREF   | A reference to an unsigned 1-byte character was passed; a pointer to the value is in <i>pbVal</i> .                                                                                 |
| VT_I2               | A 2-byte integer value is stored in <i>iVal</i> .                                                                                                                                   |
| VT_I2   VT_BYREF    | A reference to a 2-byte integer was passed; a pointer to the value is in <i>piVal</i> .                                                                                             |
| VT_I4               | A 4-byte integer value is stored in <i>lVal</i> .                                                                                                                                   |
| VT_I4   VT_BYREF    | A reference to a 4-byte integer was passed; a pointer to the value is in <i>plVal</i> .                                                                                             |
| VT_R4               | An IEEE 4-byte real value is stored in <i>fltVal</i> .                                                                                                                              |
| VT_R4   VT_BYREF    | A reference to an IEEE 4-byte real was passed; a pointer to the value is in <i>pfltVal</i> .                                                                                        |
| VT_R8               | An 8-byte IEEE real value is stored in <i>dblVal</i> .                                                                                                                              |
| VT_R8   VT_BYREF    | A reference to an 8-byte IEEE real was passed; a pointer to its value is in <i>pdblVal</i> .                                                                                        |

Table 18-9 Valid OLE VARIANT Data Types (Continued)

|                     |                                                                                                                                                                                                                                                                                                                                                                                                                                                                                                      |
|---------------------|------------------------------------------------------------------------------------------------------------------------------------------------------------------------------------------------------------------------------------------------------------------------------------------------------------------------------------------------------------------------------------------------------------------------------------------------------------------------------------------------------|
| VT_CY               | A currency value was specified. A currency number is stored as an 8-byte, two's complement integer, scaled by 10,000 to give a fixed-point number with 15 digits to the left of the decimal point and 4 digits to the right. The value is in <i>cyVal</i> .                                                                                                                                                                                                                                          |
| VT_CY   VT_BYREF    | A reference to a currency value was passed; a pointer to the value is in <i>pcyVal</i> .                                                                                                                                                                                                                                                                                                                                                                                                             |
| VT_BSTR             | A string was passed; it is stored in <i>bstrVal</i> . This pointer must be obtained and freed via the BSTR functions.                                                                                                                                                                                                                                                                                                                                                                                |
| VT_BSTR   VT_BYREF  | A reference to a string was passed. A BSTR*, which points to a BSTR, is in <i>pbstrVal</i> . The referenced pointer must be obtained or freed via the BSTR functions.                                                                                                                                                                                                                                                                                                                                |
| VT_NULL             | A propagating NULL value was specified. This should not be confused with the NULL pointer. The NULL value is used for tri-state logic as with SQL.                                                                                                                                                                                                                                                                                                                                                   |
| VT_NULL   VT_BYREF  | Illegal.                                                                                                                                                                                                                                                                                                                                                                                                                                                                                             |
| VT_ERROR            | An SCODE was specified. The type of error is specified in <i>code</i> . Generally, operations on error values should raise an exception or propagate the error to the return value, as appropriate.                                                                                                                                                                                                                                                                                                  |
| VT_ERROR   VT_BYREF | A reference to an SCODE was passed. A pointer to the value is in <i>pocode</i> .                                                                                                                                                                                                                                                                                                                                                                                                                     |
| VT_BOOL             | A Boolean (True/False) value was specified. A value of 0xFFFF (all bits one) indicates True; a value of 0 (all bits zero) indicates False. No other values are legal.                                                                                                                                                                                                                                                                                                                                |
| VT_BOOL   VT_BYREF  | A reference to a Boolean value. A pointer to the Boolean value is in <i>pbool</i> .                                                                                                                                                                                                                                                                                                                                                                                                                  |
| VT_DATE             | A value denoting a date and time was specified. Dates are represented as double-precision numbers, where midnight, January 1, 1900 is 2.0, January 2, 1900 is 3.0, and so on. The value is passed in <i>date</i> .<br><br>This is the same numbering system used by most spreadsheet programs, although some incorrectly believe that February 29, 1900 existed, and thus set January 1, 1900 to 1.0. The date can be converted to and from an MS-DOS representation using VariantTimeToDosDateTime. |
| VT_DATE   VT_BYREF  | A reference to a date was passed. A pointer to the value is in <i>pdate</i> .                                                                                                                                                                                                                                                                                                                                                                                                                        |



Table 18-9 Valid OLE VARIANT Data Types (Continued)

|                        |                                                                                                                                                                                                                                                                                                                                                              |
|------------------------|--------------------------------------------------------------------------------------------------------------------------------------------------------------------------------------------------------------------------------------------------------------------------------------------------------------------------------------------------------------|
| VT_DISPATCH            | A pointer to an object was specified. The pointer is in <i>pdispVal</i> . This object is only known to implement IDispatch; the object can be queried as to whether it supports any other desired interface by calling QueryInterface on the object. Objects that do not implement IDispatch should be passed using VT_UNKNOWN.                              |
| VT_DISPATCH   VT_BYREF | A pointer to a pointer to an object was specified. The pointer to the object is stored in the location referred to by <i>ppdispVal</i> .                                                                                                                                                                                                                     |
| VT_VARIANT             | Illegal. VARIANTARGs must be passed by reference.                                                                                                                                                                                                                                                                                                            |
| VT_VARIANT   VT_BYREF  | A pointer to another VARIANTARG is passed in <i>pvarVal</i> . This referenced VARIANTARG will never have the VT_BYREF bit set in <i>vt</i> , so only one level of indirection can ever be present. This value can be used to support languages that allow functions to change the types of variables passed by reference.                                    |
| VT_UNKNOWN             | A pointer to an object that implements the IUnknown interface is passed in <i>punkVal</i> .                                                                                                                                                                                                                                                                  |
| VT_UNKNOWN   VT_BYREF  | A pointer to a pointer to the IUnknown interface is passed in <i>ppunkVal</i> . The pointer to the interface is stored in the location referred to by <i>ppunkVal</i> .                                                                                                                                                                                      |
| VT_ARRAY   <anything>  | An array of data type <anything> was passed. (VT_EMPTY and VT_NULL are illegal types to combine with VT_ARRAY.) The pointer in <i>pByrefVal</i> points to an array descriptor, which describes the dimensions, size, and in-memory location of the array. The array descriptor is never accessed directly, but instead is read and modified using functions. |

A COM VARIANT is mapped to the CORBA **any** without loss. If at run-time a CORBA client passes an inconvertible **any** to a COM server, a DATA\_CONVERSION exception is raised.

### 18.3.9 Mapping for Pointers

MIDL supports three types of pointers:

- Reference pointer; a non-null pointer to a single item. The pointer cannot represent a data structure with cycles or aliasing (two pointers to the same address).
- Unique pointer; a (possibly null) pointer to a single item. The pointer cannot represent a data structure with cycles or aliasing.
- Full pointer; a (possibly null) pointer to a single item. Full pointers can be used for data structures, which form cycles or have aliases.

A reference pointer is mapped to a CORBA sequence containing one element. Unique pointers and full pointers with no aliases or cycles are mapped to a CORBA sequence containing zero or one elements. If at run-time a COM client passes a full pointer containing aliases or cycles to a CORBA server, `E_DATA_CONVERSION` is returned to the COM client. If a COM server attempts to return a full pointer containing aliases or cycles to a CORBA client, a `DATA_CONVERSION` exception is raised.

### *18.3.10 Interface Mapping*

COM is a binary standard based upon standard machine calling conventions. Although interfaces can be expressed in Microsoft IDL, Microsoft ODL, or C++, the following interface mappings between COM and CORBA will use Microsoft ODL as the language of expression for COM constructs.

COM interface pointers bidirectionally map to CORBA Object references with the appropriate mapping of Microsoft IDL and ODL interfaces to OMG IDL interfaces.

#### *18.3.10.1 Mapping for Interface Identifiers*

Interface identifiers are used in both CORBA and COM to uniquely identify interfaces. These allow the client code to retrieve information about, or to inquire about other interfaces of an object.

COM identifies interfaces using a structure similar to the DCE UUID (in fact, identical to a DCE UUID on Win32) known as an IID. As with CORBA, COM specifies that the textual names of interfaces are only for convenience and need not be globally unique.

The COM interface identifier (IID and CLSID) are bidirectionally mapped to the CORBA `RepositoryId`.

#### *18.3.10.2 Mapping for COM Errors*

COM will provide error information to clients only if an operation uses a return result of type `HRESULT`. The COM `HRESULT`, if zero, indicates success. The `HRESULT`, if nonzero, can be converted into an `SCODE` (the `SCODE` is explicitly specified as being the same as the `HRESULT` on Win32). The `SCODE` can then be examined to determine whether the call succeeded or failed. The error or success code, also contained within the `SCODE`, is composed of a “facility” major code (13 bits on Win32 and 4 bits on Win16) and a 16-bit minor code.

COM object developers are expected to use one of the predefined `SCODE` values, or use the facility `FACILITY_ITF` and an interface-specific minor code. `SCODE` values can indicate either success codes or error codes. A typical use is to overload the `SCODE` with a boolean value, using `S_OK` and `S_FALSE` success codes to indicate a true or false return. If the COM server returns `S_OK` or `S_FALSE`, a CORBA exception will not be raised and the value of the `SCODE` will be mapped as the return value. This is because COM operations, which are defined to return an `HRESULT`, are mapped to CORBA as returning an `HRESULT`.

Unlike CORBA, COM provides no standard way to return user-defined exception data to the client. Also, there is no standard mechanism in COM to specify the completion status of an invocation. In addition, it is not possible to predetermine what set of errors a COM interface might return. Although the set of success codes that can be returned from a COM operation must be fixed when the operation is defined, there is currently no machine-readable way to discover what the set of valid success codes are.

COM exceptions have a straightforward mapping into CORBA. COM system error codes are mapped to the CORBA standard exceptions. COM user-defined error codes are mapped to CORBA user exceptions.

COM system error codes are defined with the FACILITY\_NULL and FACILITY\_RPC facility codes. All FACILITY\_NULL and FACILITY\_RPC COM errors are mapped to CORBA standard exceptions. Table 18-10 lists the mapping from COM FACILITY\_NULL exceptions to CORBA standard exceptions.

*Table 18-10* Mapping from COM FACILITY\_NULL Error Codes to CORBA Standard (System) Exceptions

| COM            | CORBA         |
|----------------|---------------|
| E_OUTOFMEMORY  | NO_MEMORY     |
| E_INVALIDARG   | BAD_PARAM     |
| E_NOTIMPL      | NO_IMPLEMENT  |
| E_FAIL         | UNKNOWN       |
| E_ACCESSDENIED | NO_PERMISSION |
| E_UNEXPECTED   | UNKNOWN       |
| E_ABORT        | UNKNOWN       |
| E_POINTER      | BAD_PARAM     |
| E_HANDLE       | BAD_PARAM     |

Table 18-11 lists the mapping from COM FACILITY\_RPC exceptions to CORBA standard exceptions. All FACILITY\_RPC exceptions not listed in this table are mapped to the new CORBA standard exception COM.

*Table 18-11* Mapping from COM FACILITY\_RPC Error Codes to CORBA Standard (System) Exceptions

| COM                              | CORBA        |
|----------------------------------|--------------|
| RPC_E_CALL_CANCELED              | TRANSIENT    |
| RPC_E_CANTPOST_INSENDCALL        | COMM_FAILURE |
| RPC_E_CANTCALLOUT_INEXTERNALCALL | COMM_FAILURE |
| RPC_E_CONNECTION_TERMINATED      | NV_OBJREF    |

Table 18-11 Mapping from COM FACILITY\_RPC Error Codes to CORBA Standard (System) Exceptions (Continued)

|                                 |              |
|---------------------------------|--------------|
| RPC_E_SERVER_DIED               | INV_OBJREF   |
| RPC_E_SERVER_DIED_DNE           | INV_OBJREF   |
| RPC_E_INVALID_DATAPACKET        | COMM_FAILURE |
| RPC_E_CANTTRANSMIT_CALL         | TRANSIENT    |
| RPC_E_CLIENT_CANTMARSHAL_DATA   | MARSHAL      |
| RPC_E_CLIENT_CANTUNMARSHAL_DATA | MARSHAL      |
| RPC_E_SERVER_CANTMARSHAL_DATA   | MARSHAL      |
| RPC_E_SERVER_CANTUNMARSHAL_DATA | MARSHAL      |
| RPC_E_INVALID_DATA              | COMM_FAILURE |
| RPC_E_INVALID_PARAMETER         | BAD_PARAM    |
| RPC_E_CANTCALLOUT_AGAIN         | COMM_FAILURE |
| RPC_E_SYS_CALL_FAILED           | NO_RESOURCES |
| RPC_E_OUT_OF_RESOURCES          | NO_RESOURCES |
| RPC_E_NOT_REGISTERED            | NO_IMPLEMENT |
| RPC_E_DISCONNECTED              | INV_OBJREF   |
| RPC_E_RETRY                     | TRANSIENT    |
| RPC_E_SERVERCALL_REJECTED       | TRANSIENT    |
| RPC_E_NOT_REGISTERED            | NO_IMPLEMENT |

COM SCODEs, other than those previously listed, are mapped into CORBA user exceptions and will require the use of the raises clause in OMG IDL. Since the OMG IDL mapping from the Microsoft IDL and ODL is likely to be generated, this is not a burden to the average programmer. The following OMG IDL illustrates such a user exception.

```
// OMG IDL
exception COM_ERROREX
{
 long hresult;
 Any info;
};
```

The **COM\_ERROREX** extension is designed to allow exposure of exceptions passed using the per-thread ErrorObject. The Any contained in the **COM\_ERROREX** is defined to hold a CORBA object reference that supports the OMG IDL mapping for the **IErrorInfo** interface.

### 18.3.10.3 Mapping of Nested Data Types

Microsoft MIDL (and ODL) consider all definitions to be at global (or library) scope regardless of position in the file. This can lead to name collisions in datatypes across interfaces. Operations or types later in the file can refer to a datatype without fully qualifying the name even if the type is nested within another interface.

For purposes of mapping MIDL/ODL to OMG IDL, we treat nested datatypes as if they had been prepended with the name of the scoping level. Thus:

```
interface IA : IUnknown
{
 typedef enum {ONE, TWO, THREE} Count;
 HRESULT f([in] Count val);
}
```

is mapped as if it were defined as:

```
typedef enum {A_ONE, A_TWO, A_THREE} A_Count;
interface IA : IUnknown
{
 HRESULT f([in] A_Count val);
}
```

### 18.3.10.4 Mapping of Names

Microsoft MIDL and ODL support prefixing types/names with leading underscores. When mapping from Microsoft MIDL or ODL to OMG IDL, the leading underscores are removed.

---

**Note** – This simple rule is not sufficient to avoid all name collisions (such as MIDL types that clash with OMG IDL reserved names or situations where two operation names differ only in the leading underscore). However, this rule will cover many common cases and leads to a more natural mapping than prepending a character before the underscore.

---

### 18.3.10.5 Mapping for Operations

Operations defined for an interface are defined in Microsoft IDL and ODL within interface definitions. The definition of an operation constitutes the operations signature. An operation signature consists of the operation's name, parameters (if any), and return value. Unlike OMG IDL, Microsoft IDL and ODL does not allow the operation definition to indicate the error information that can be returned.

Microsoft IDL and ODL parameter directional attributes (**[in]**, **[out]**, **[in, out]**) map directly to OMG IDL (**in**, **out**, **inout**). Operation request parameters are represented as the values of **[in]** or **[inout]** parameters in Microsoft IDL, and operation response parameters are represented as the values of **[inout]** or **[out]** parameters. An

operation return result can be any type that can be defined in Microsoft IDL/ODL, or void if a result is not returned. By convention, most operations are defined to return an HRESULT. This provides a consistent way to return operation status information.

When Microsoft ODL methods are mapped to OMG IDL, they undergo the following transformations. First, if the last parameter is tagged with the Microsoft ODL keyword **retval**, that argument will be used as the return type of the operation. If the last parameter is not tagged with **retval**, then the signature is mapped directly to OMG IDL following the mapping rules for the data types of the arguments. Some example mappings from COM methods to OMG IDL operations are shown in the following code.

```
// Microsoft ODL
interface IFoo: IUnknown
{
 HRESULT stringify([in] VARIANT value,
 [out, retval] LPSTR * pszValue);

 HRESULT permute([inout] short * value);

 HRESULT tryPermute([inout] short * value,
 [out] long newValue);
};
```

In OMG IDL this becomes:

```
typedef long HRESULT;
interface IFoo: CORBA::Composite, CosLifeCycle::LifeCycleObject
{
 string stringify(in any value) raises (COM_ERROR),
 COM_ERROREX);
 HRESULT permute(inout short value);

 HRESULT tryPermute(inout short value, out long newValue)
};
```

### 18.3.10.6 Mapping for Properties

In COM, only Microsoft ODL and OLE Type Libraries provide support for describing properties. Microsoft IDL does not support this capability. Any operations that can be determined to be either a put/set or get accessor are mapped to an attribute in OMG IDL. Because Microsoft IDL does not provide a means to indicate that something is a property, a mapping from Microsoft IDL to OMG IDL will not contain mappings to the attribute statement in OMG IDL.

When mapping between Microsoft ODL or OLE Type Libraries, properties in COM are mapped in a similar fashion to that used to map attributes in OMG IDL to COM. For example, the following Microsoft ODL statements define the attribute Profile for

the ICustomer interface and the read-only attribute Balance for the IAccount interface. The keywords [**propput**] and [**propget**] are used by Microsoft ODL to indicate that the statement is defining a property of an interface.

```
// Microsoft ODL
interface IAccount
{
 [propget] HRESULT Balance([out, retval] float
 * pfBalance);
 ...
};

interface ICustomer
{
 [propget] HRESULT Profile([out] CustomerData * Profile);
 [propput] HRESULT Profile([in] CustomerData * Profile);
};
```

The definition of attributes in OMG IDL are restricted from raising any user-defined exceptions. Because of this, the implementation of an attribute's accessor function is limited to raising system exceptions. The value of the HRESULT is determined by a mapping of the CORBA exception, if any, that was raised.

### 18.3.11 Mapping for Read-Only Attributes

In Microsoft ODL, an attribute preceded by the keyword [**propget**] is interpreted as only supporting an accessor function, which is used to retrieve the value of the attribute. In the example above, the mapping of the attribute Balance is mapped to the following statements in OMG IDL.

```
// OMG IDL
interface Account
{
 readonly attribute float Balance;
 ...
};
```

### 18.3.12 Mapping for Read-Write Attributes

In Microsoft ODL, an attribute preceded by the keyword [**propput**] is interpreted as only supporting an accessor function that is used to set the value of the attribute. In the previous example, the attribute Profile is mapped to the following statements in OMG IDL.

```
// OMG IDL
struct CustomerData
{
 CustomerId Id;
 string Name;
```

```
 string SurName;
};

interface Customer
{
 attribute CustomerData Profile;
 ...
};
```

Since CORBA does not have the concept of write-only attributes, the mapping must assume that a property that has the keyword [**propput**] is mapped to a single read-write attribute, even if there is no associated [**propget**] method defined.

### 18.3.12.1 *Inheritance Mapping*

Both CORBA and COM have similar models for individual interfaces. However, the models for inheritance and multiple interfaces are different.

In CORBA, an interface can singly or multiply inherit from other interfaces, and in language bindings supporting typed object references, widening and narrowing support convert object references as allowed by the true type of that object.

However, there is no built-in mechanism in CORBA to access interfaces without an inheritance relationship. The run-time interfaces of an object (for example, **CORBA::Object::is\_a**, **CORBA::Object::get\_interface**) use a description of the object's principle type, which is defined in OMG IDL. In terms of implementation, CORBA allows many ways in which implementations of interfaces can be structured, including using implementation inheritance.

In COM V2.0, interfaces can have single inheritance. However, as opposed to CORBA, there is a standard mechanism by which an object can have multiple interfaces (without an inheritance relationship between those interfaces) and by which clients can query for these at run-time. (It defines no common way to determine if two interface references refer to the same object, or to enumerate all the interfaces supported by an entity.)

An observation about COM is that some COM objects have a required minimum set of interfaces that they must support. This type of statically-defined interface relation is conceptually equivalent to multiple inheritance; however, discovering this relationship is only possible if ODL or type libraries are always available for an object.

COM describes two main implementation techniques: aggregation and delegation. C++ style implementation inheritance is not possible.

When COM interfaces are mapped into CORBA, their inheritance hierarchy (which can only consist of single inheritance) is directly mapped into the equivalent OMG IDL inheritance hierarchy.<sup>2</sup>

---

2. This mapping fails in some cases, for example, if operation names are the same.



Note that although it is possible, using Microsoft ODL to map multiple COM interfaces in a class to OMG IDL multiple inheritance, the necessary information is not available for interfaces defined in Microsoft IDL. As such, this specification does not define a multiple COM interface to OMG IDL multiple inheritance mapping. It is assumed that future versions of COM will merge Microsoft ODL and Microsoft IDL, at which time the mapping can be extended to allow for multiple COM interfaces to be mapped to OMG IDL multiple inheritance.

**CORBA::Composite** is a general-purpose interface used to provide a standard mechanism for accessing multiple interfaces from a client, even though those interfaces are not related by inheritance. Any existing ORB can support this interface, although in some cases a specialized implementation framework may be desired to take advantage of this interface.

```

module CORBA // PIDL
{
 interface Composite
 {
 Object query_interface(in RepositoryId whichOne);
 };
 interface Composable:Composite
 {
 Composite primary_interface();
 };
};

```

The root of a COM interface inheritance tree, when mapped to CORBA, is multiply-inherited from **CORBA::Composable** and **CosLifeCycle::LifecycleObject**. Note that the **IUnknown** interface is not surfaced in OMG IDL. Any COM method parameters that require **IUnknown** interfaces as arguments are mapped, in OMG IDL, to object references of type **CORBA::Object**.

```

// Microsoft IDL or ODL
interface IFoo: IUnknown
{
 HRESULT inquire([in] IUnknown *obj);
};

```

In OMG IDL, this becomes:

```

interface IFoo: CORBA::Composable, CosLifeCycle::LifecycleObject
{
 void inquire(in Object obj);
};

```

### 18.3.12.2 Type Library Mapping

Name spaces within the OLE Type Library are conceptually similar to CORBA interface repositories. However, the CORBA interface repository looks, to the client, to be one unified service. Type libraries, on the other hand, are each stored in a separate file. Clients do not have a unified, hierarchical interface to type libraries.

The following table defines the mapping between equivalent CORBA and COM interface description concepts. Where there is no equivalent, the field is left blank.

Table 18-12CORBA Interface Repository to OLE Type Library Mappings

| CORBA        | COM       |
|--------------|-----------|
| TypeCode     | TYPEDESC  |
| Repository   |           |
| ModuleDef    | ITypeLib  |
| InterfaceDef | ITypeInfo |
| AttributeDef | VARDESC   |
| OperationDef | FUNCDESC  |
| ParameterDef | ELEMDESC  |
| TypeDef      | ITypeInfo |
| ConstantDef  | VARDESC   |
| ExceptionDef |           |

Using this mapping, implementations must provide the ability to call **Object::get\_interface** on CORBA object references to COM objects to retrieve an **InterfaceDef**. When CORBA objects are accessed from COM, implementations may provide the ability to retrieve the **ITypeInfo** for CORBA object interface using the **IProvideClassInfo** COM interface.

This chapter describes the bidirectional data type and interface mapping between Automation and CORBA.

Microsoft's Object Description Language (ODL) is used to describe Automation object model constructs. However, many constructs supported by ODL are not supported by Automation. Therefore, this specification is confined to the Automation-compatible ODL constructs.

As described in the *Interworking Architecture* chapter, many implementation choices are open to the vendor in building these mappings. One valid approach is to generate and compile mapping code, an essentially static approach. Another is to map objects dynamically.

Although some features of the CORBA-Automation mappings address the issue of inverting a mapping back to its original platform, this specification does not assume the requirement for a totally invertible mapping between Automation and CORBA.

## Contents

This chapter contains the following sections.

| Section Title                         | Page  |
|---------------------------------------|-------|
| "Mapping CORBA Objects to Automation" | 19-2  |
| "Mapping for Interfaces"              | 19-3  |
| "Mapping for Basic Data Types"        | 19-9  |
| "IDL to ODL Mapping"                  | 19-12 |
| "Mapping for Object References"       | 19-15 |
| "Mapping for Enumerated Types"        | 19-17 |

| Section Title                                 | Page  |
|-----------------------------------------------|-------|
| “Mapping for Arrays and Sequences”            | 19-18 |
| “Mapping for CORBA Complex Types”             | 19-19 |
| “Mapping Automation Objects as CORBA Objects” | 19-38 |
| “Older Automation Controllers”                | 19-49 |
| “Example Mappings”                            | 19-51 |

## 19.1 Mapping CORBA Objects to Automation

### 19.1.1 Architectural Overview

There are seven main pieces involved in the invocation of a method on a remote CORBA object: the OLE Automation Controller; the COM Communication Infrastructure; the OLE system registry; the client-side Automation View; the operation’s type information; the Object Request Broker; and the CORBA object’s implementation. These are illustrated in Figure 19-1 (the call to the Automation View could be a call in the same process).

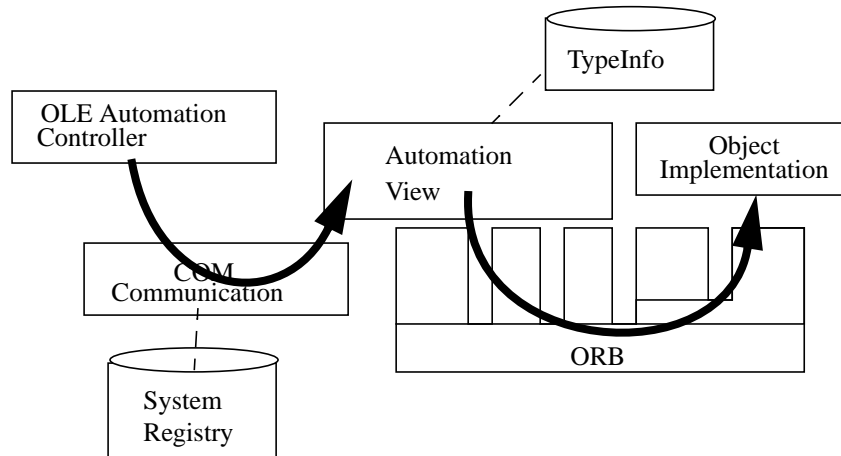

Figure 19-1 CORBA Object Architectural Overview

The Automation View is an Automation server with a dispatch interface that is isomorphic to the mapped OMG IDL interface. We call this dispatch interface an Automation View Interface. The Automation server encapsulates a CORBA object reference and maps incoming OLE Automation invocations into CORBA invocations on the encapsulated reference. The creation and storage of the type information is not specified.

There is a one-to-one correspondence between the methods of the Automation View Interface and operations in the CORBA interface. The Automation View Interface's methods translate parameters bidirectionally between a CORBA reference and an OLE reference.

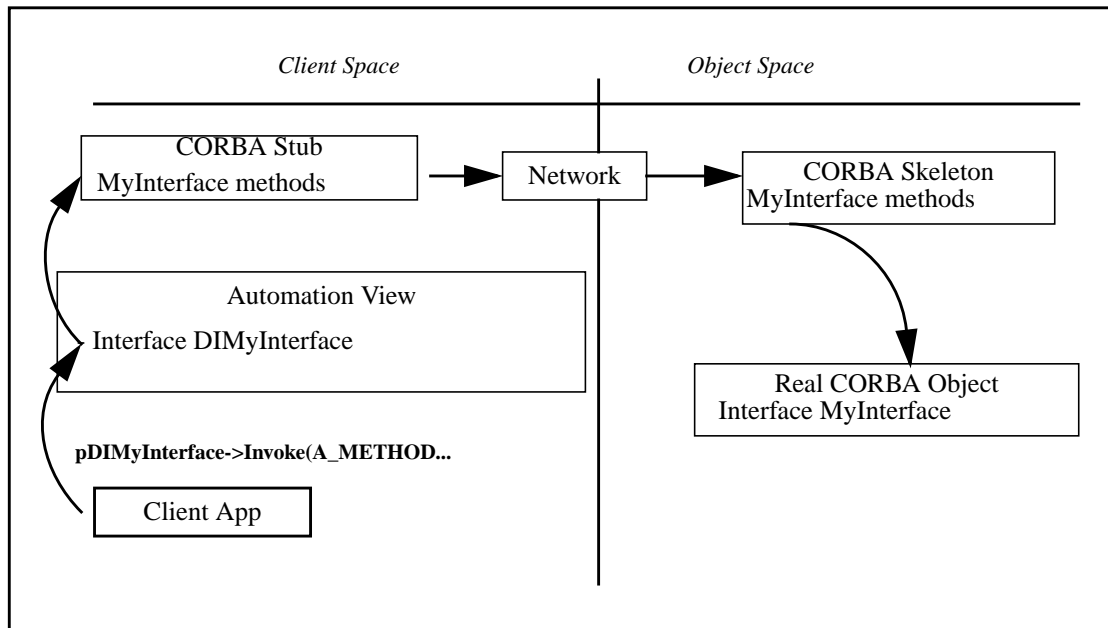

Figure 19-2 Methods of the Automation View Interface Delegate to the CORBA Stub

### 19.1.2 Main Features of the Mapping

- OMG IDL attributes and operations map to Automation properties and methods respectively.
- OMG IDL interfaces map to Automation interfaces.
- The OMG IDL basic types map to corresponding basic types in Automation where possible. Since Automation supports a limited set of data types, some OMG IDL types cannot be mapped directly. Specifically:
  - OMG IDL constructed types such as structs and unions map to Automation interfaces with appropriate attributes and operations. User exceptions are mapped in the same way.
  - OMG IDL unsigned types map as closely as possible to Automation types, and overflow conditions are identified.
- OMG IDL sequences and arrays map to VARIANTS containing an Automation Safearray.

## 19.2 Mapping for Interfaces

A CORBA interface maps in a straightforward fashion to an Automation View Interface. For example, the following CORBA interface

```

module MyModule // OMG IDL
 {
 interface MyInterface
 {
 // Attributes and operations;
 ...
 };
 };

```

maps to the following Automation View Interface:

```

[odl, dual, uuid(...)]
interface DIMyModule_MyInterface: IDispatch
{
 // Properties and methods;
 ...
};

```

The interface **DIMyModule\_account** is an Automation Dual Interface. A Dual Interface is a COM vtable-based interface, which derives from **IDispatch**, meaning that its methods can be late-bound via **IDispatch::Invoke** or early-bound through the vtable portion of the interface. Thus, **DIMyModule\_account** contains the methods of **IDispatch** as well as separate vtable-entries for its operations and property get/set methods.

### 19.2.1 Mapping for Attributes and Operations

An OMG IDL operation maps to an isomorphic Automation operation. An OMG IDL attribute maps to an ODL property, which has one method to *get* and one to *set* the value of the property. An OMG IDL readonly attribute maps to an OLE property, which has a single method to get the value of the property.

The order of the property and method declarations in the mapped Automation interface follows the rules described in “Ordering Rules for the CORBA->OLE Automation Transformation” part of Section 17.5.2, “Detailed Mapping Rules,” on page 17-13.

For example, given the following CORBA interface,

```

interface account // OMG IDL
{
 attribute float balance;
 readonly attribute string owner;
 void makeLodgement(in float amount, out float balance);
 void makeWithdrawal(in float amount, out float balance);
};

```

the corresponding Automation View Interface is:

```

[odl, dual, uuid(...)]
interface DIaccount: IDispatch
{
 // ODL

```

```

HRESULT makeLodgement([in] float amount,
 [out] float * balance,
 [optional, out] VARIANT * excep_OBJ);
HRESULT makeWithdrawal([in] float amount,
 [out] float * balance,
 [optional, out] VARIANT * excep_OBJ);
[propget] HRESULT balance([retval,out] float * val);
[propput] HRESULT balance([in] float balance);
[propget] HRESULT owner([retval,out] BSTR * val);
}

```

OMG IDL **in**, **out**, and **inout** parameters map to ODL **[in]**, **[out]**, and **[in,out]** parameters, respectively. Section 19.3, “Mapping for Basic Data Types,” on page 19-9, explains the mapping for basic data types. The mapping for CORBA oneway operations is the same as for normal operations.

An operation of a Dual Interface always returns HRESULT, but the last argument in the operation’s signature may be tagged **[retval,out]**. An argument tagged in this fashion is considered syntactically to be a return value. Automation controller macro languages map this special argument to a return value in their language syntax. Thus, a CORBA operation’s return value is mapped to the last argument in the corresponding operation of the Automation View Interface.

### *Additional, Optional Parameter*

All operations on the Automation View Interface have an optional **out** parameter of type VARIANT. The optional parameter returns explicit exception information in the context of each property set/get or method invocation. See Section 19.8.9, “Mapping CORBA Exceptions to Automation Exceptions,” on page 19-30 for a detailed discussion of how this mechanism works.

If the CORBA operation has no return value, then the optional parameter is the last parameter in the corresponding Automation operation. If the CORBA operation does have a return value, then the optional parameter appears directly before the return value in the corresponding Automation operation, since the return value must always be the last parameter.

## *19.2.2 Mapping for OMG IDL Single Inheritance*

A hierarchy of singly-inherited OMG IDL interfaces maps to an identical hierarchy of Automation View Interfaces.

For example, given the interface **account** and its derived interface **checkingAccount** defined as follows,

```

module MyModule { // OMG IDL
 interface account {
 attribute float balance;
 readonly attributestring owner;
 void makeLodgement (in float amount, out float
 balance);
 }
}

```

```

 void makeWithdrawal (in float amount, out float
 theBalance);
};
interface checkingAccount: account {
 readonly attribute float overdraftLimit;
 boolean orderChequeBook ();
};
};

```

the corresponding Automation View Interfaces are as follows

```

// ODL
[odl, dual, uuid(20c31e22-dcb2-aa79-1dc4-34a4ad297579)]
interface DIMyModule_account: IDispatch {
 HRESULT makeLodgement([in] float amount,
 [out] float * balance,
 [optional, out] VARIANT * excep_OBJ);
 HRESULT makeWithdrawal([in] float amount,
 [out] float * balance,
 [optional, out] VARIANT * excep_OBJ);
 [propget] HRESULT balance([retval,out] float * val);
 [propput] HRESULT balance([in] float balance);
 [propget] HRESULT owner([retval,out] BSTR * val);
};

[odl, dual, uuid(ffe752b2-a73f-2a28-1de4-21754778ab4b)]
interface DIMyModule_checkingAccount: IMyModule_account {
 HRESULT orderChequeBook(
 [optional, out] VARIANT * excep_OBJ,
 [retval,out] short * val);
 [propget] HRESULT overdraftLimit (
 [retval,out] short * val);
};

```

### 19.2.3 Mapping of OMG IDL Multiple Inheritance

Automation does not support multiple inheritance; therefore, a direct mapping of a CORBA inheritance hierarchy using multiple inheritance is not possible. This mapping splits such a hierarchy, at the points of multiple inheritance, into multiple singly-inherited strands.

The mechanism for determining which interfaces appear on which strands is based on a left branch traversal of the inheritance tree. At points of multiple inheritance, the interface that is first in an ordering of the parent interfaces is included in what we call



the main strand, and other interfaces are assigned to other, secondary strands. (The ordering of parent interfaces is explained later in this section.) For example, consider the CORBA interface hierarchy, shown in Figure 19-3.

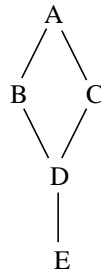

Figure 19-3 A CORBA Interface Hierarchy Using Multiple Inheritance

We read this hierarchy as follows:

- B and C derive from A
- D derives from B and C
- E derives from D

This CORBA hierarchy maps to the following two Automation single inheritance hierarchies, shown in Figure 19-4.

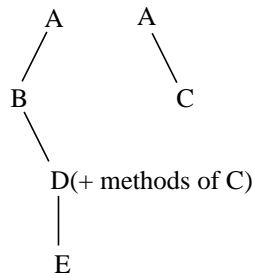

Figure 19-4 The Mapped Automation Hierarchy Splits at the Point of Multiple Inheritance

Consider the multiple inheritance point D, which inherits from B and C. Following the left strand B at this point, our main strand is A-B-D and our secondary strand is A-C. However, to access all of the object's methods, a controller would have to navigate among these disjoint strands via `QueryInterface`. While such navigation is expected of COM clients and might be an acceptable requirement of C++ automation controllers, many Automation controller environments do not support such navigation.

To accommodate such controllers, at points of multiple inheritance we aggregate the operations of the secondary strands into the interface of the main strand. In our example, we add the operations of C to D (A's operations are not added because they already exist in the main strand). Thus, D has all the methods of the hierarchy and, more important, an Automation controller holding a reference to D can access all of the methods of the hierarchy without calling **`QueryInterface`**.

In order to have a reliable, deterministic, portable way to determine the inheritance chain at points of multiple inheritance, an explicit ordering model must be used. Furthermore, to achieve interoperability of virtual function tables for dual interfaces, a precise model for ordering operations and attributes within an interface must be specified.

Within an interface, attributes should appear after operations and both should be ordered in ascending order based upon the operation/attribute names. The ordering is based on a byte-by-byte comparison of the ISO-Latin-1 encoding values of the operation names going from first character to last. For non-readonly attributes, the `[propget]` method immediately precedes the `[propput]` method. This ordering determines the position of the vtable portion of a Dual Interface. At points of multiple inheritance, the base interfaces should be ordered from left to right in all cases, the ordering is based on ISO Latin-1. Thus, the leftmost branch at a point of multiple inheritance is the one ordered first among the base classes, not necessarily the one listed first in the inheritance declaration.

Continuing with the example, the following OMG IDL code expresses a hierarchy conforming to Figure 19-3 on page 19-7.

```
// OMG IDL
module MyModule {
 interface A {
 void aOp1();
 void zOp1();

 interface B: A{
 void aOp2();
 void zOp2();
 };
 interface C: A {
 void aOp3();
 void zOp3();
 };
 interface D: C, B{
 void aOp4();
 void zOp4();
 };
};
```

The OMG IDL maps to the following two Automation View hierarchies. Note that the ordering of the base interfaces for D has been changed based on our ISO Latin-1 alphabetic ordering model and that operations from C are added to interface D.

```
// ODL
// strand 1: A-B-D
[odl, dual, uuid(8db15b54-c647-553b-1dc9-6d098ec49328)]
interface DIMyModule_A: IDispatch {
 HRESULT aOp1([optional,out] VARIANT * excep_OBJ);
 HRESULT zOp1([optional,out] VARIANT * excep_OBJ);}
```

```

[odl, dual, uuid(ef8943b0-cef8-21a5-1dc0-37261e082e51)]
interface DIMyModule_B: DIMyModule_A {
 HRESULT aOp2([optional,out] VARIANT * excep_OBJ);
 HRESULT zOp2([optional,out] VARIANT * excep_OBJ);}
[odl, dual, uuid(67528a67-2cfd-e5e3-1de2-d59a444fe593)]
interface DIMyModule_D: DIMyModule_B {
 // C's aggregated operations
 HRESULT aOp3([optional,out] VARIANT * excep_OBJ);
 HRESULT zOp3([optional,out] VARIANT * excep_OBJ);
 // D's normal operations
 HRESULT aOp4([optional,out] VARIANT * excep_OBJ);
 HRESULT zOp4([optional,out] VARIANT * excep_OBJ);}

// strand 2: A-C
[odl, dual, uuid(327885f8-ae9e-19c0-1dd5-d1ea05bcaae5)]
interface DIMyModule_C: DIMyModule_A {
 HRESULT aOp3([optional,out] VARIANT * excep_OBJ);
 HRESULT zOp3([optional,out] VARIANT * excep_OBJ);
}

```

Also note that the repeated operations of the aggregated strands are listed before D's operations. The ordering of these operations obeys the rules for operations within C and is independent of the ordering within D.

## 19.3 Mapping for Basic Data Types

### 19.3.1 Basic Automation Types

Table 19-1 lists the basic data types supported by Automation. The table contains fewer data types than those allowed by ODL because not all types recognized by ODL can be handled by the marshaling of **IDispatch** interfaces and by the implementation of **ITypeInfo::Invoke**. Arguments and return values of operations and properties are restricted to these basic types.

Table 19-1 Automation Basic Types

| Type    | Description                                                                                              |
|---------|----------------------------------------------------------------------------------------------------------|
| boolean | True = -1, False = 0.                                                                                    |
| double  | 64-bit IEEE floating-point number.                                                                       |
| float   | 32-bit IEEE floating-point number.                                                                       |
| long    | 32-bit signed integer.                                                                                   |
| short   | 16-bit signed integer.                                                                                   |
| void    | Allowed only as a return type for a function, or in a function parameter list to indicate no parameters. |
| BSTR    | Length-prefixed string. Prefix is an integer.                                                            |

| Type        | Description                                                                                                               |
|-------------|---------------------------------------------------------------------------------------------------------------------------|
| CURRENCY    | 8-byte fixed-point number.                                                                                                |
| DATE        | 64-bit floating-point fractional number of days since December 30, 1899.                                                  |
| SCODE       | Built-in error type. In Win16, does not include additional data contained in an HRESULT. In Win32, identical to HRESULT.  |
| IDispatch * | Pointer to IDispatch interface. From the viewpoint of the mapping, an IDispatch pointer parameter is an object reference. |
| IUnknown *  | Pointer to IUnknown interface. (Any OLE interface can be represented by its IUnknown interface.)                          |

The formal mapping of CORBA types to Automation types is shown in Table 19-2.

Table 19-2 OMG CORBA to Automation Data Type Mappings

| CORBA Type     | OLE Automation Type |
|----------------|---------------------|
| boolean        | VARIANT_BOOL        |
| char           | UI1                 |
| double         | double              |
| float          | float               |
| long           | long                |
| octet          | short               |
| short          | short               |
| unsigned long  | long                |
| unsigned short | long                |

### 19.3.2 Special Cases of Basic Data Type Mapping

An operation of an Automation View Interface must perform bidirectional translation of the Automation and CORBA parameters and return types. It must map from Automation to CORBA for **in** parameters and from CORBA to Automation for **out** parameters. The translation logic must handle the special conditions described in the following sections.

#### 19.3.2.1 Converting Automation long to CORBA unsigned long

If the Automation long parameter is a negative number, then the View operation should return the HRESULT DISP\_E\_OVERFLOW.

### 19.3.2.2 Demoting CORBA unsigned long to Automation long

If the **CORBA::ULong** parameter is greater than the maximum value of an Automation long, then the View operation should return the HRESULT `DISP_E_OVERFLOW`.

### 19.3.2.3 Demoting Automation long to CORBA unsigned short

If the Automation long parameter is negative or is greater than the maximum value of a **CORBA::UShort**, then the View operation should return the HRESULT `DISP_E_OVERFLOW`.

### 19.3.2.4 Converting Automation boolean to CORBA boolean and CORBA boolean to Automation boolean

True and false values for CORBA boolean are, respectively, one (1) and zero (0). True and false values for Automation boolean are, respectively, negative one (-1) and zero (0). Therefore, true values need to be adjusted accordingly.

## 19.3.3 Mapping for Strings

An OMG IDL bounded or unbounded string maps to an OLE BSTR. For example, given the OMG IDL definitions,

```
// OMG IDL
string sortCode<20>;
string name;
```

the corresponding ODL code is

```
// ODL
BSTR sortCode;
BSTR name;
```

On Win32 platforms, a BSTR maps to a Unicode string. The use of BSTR is the only support for internationalization of strings defined at this time.

When mapping a fixed length string, the Automation view is required to raise the exception `DISP_E_OVERFLOW` if a BSTR is longer than the maximum size.

## 19.4 IDL to ODL Mapping

### 19.4.1 A Complete IDL to ODL Mapping for the Basic Data Types

There is no requirement that the OMG IDL code expressing the mapped CORBA interface actually exists. Other equivalent expressions of CORBA interfaces, such as the contents of an Interface Repository, may be used. Moreover, there is no requirement that ODL code corresponding to the CORBA interface be generated.

However, OMG IDL is the appropriate medium for describing a CORBA interface and ODL is the appropriate medium for describing an Automation View Interface. Therefore, the following OMG IDL code describes a CORBA interface that exercises all of the CORBA base data types in the roles of attribute, operation **in** parameter, operation **out** parameter, operation **inout** parameter, and return value. The OMG IDL code is followed by ODL code describing the Automation View Interface that would result from a conformant mapping.

```

module MyModule // OMG IDL
{
 interface TypesTest
 {
 attribute boolean boolTest;
 attribute char charTest;
 attribute double doubleTest;
 attribute float floatTest;
 attribute long longTest;
 attribute octet octetTest;
 attribute short shortTest;
 attribute string stringTest;
 attribute string<10>stringnTest;
 attribute unsigned long ulongTest;
 attribute unsigned short ushortTest;

 readonly attribute short readonlyShortTest;

 // Sets all the attributes
 boolean setAll (
 in boolean boolTest,
 in char charTest,
 in double doubleTest,
 in float floatTest,
 in long longTest,
 in octet octetTest,
 in short shortTest,
 in string stringTest,
 in string<10>stringnTest,
 in unsigned long ulongTest,
 in unsigned short ushortTest);

 // Gets all the attributes
 }
}

```

```

 boolean getAll (
 out boolean boolTest,
 out char charTest,
 out double doubleTest,
 out float floatTest,
 out long longTest,
 out octet octetTest,
 out short shortTest,
 out string stringTest,
 out string<10> stringnTest,
 out unsigned long ulongTest,
 out unsigned short ushortTest);

 boolean setAndIncrement (
 inout boolean boolTest,
 inout char charTest,
 inout double doubleTest,
 inout float floatTest,
 inout long longTest,
 inout octet octetTest,
 inout short shortTest,
 inout string stringTest,
 inout string<10> stringnTest,
 inout unsigned long ulongTest,
 inout unsigned short ushortTest);

 boolean boolReturn ();
 char charReturn ();
 double doubleReturn();
 float floatReturn();
 long longReturn ();
 octet octetReturn();
 short shortReturn ();
 string stringReturn();
 string<10> stringnReturn();
 unsigned long ulongReturn ();
 unsigned short ushortReturn();

 }; // End of Interface TypesTest

}; // End of Module MyModule

```

The corresponding ODL code is as follows.

```

[odl, dual, uuid(180d4c5a-17d2-ala8-1de1-82e7a9a4f93b)]
interface DIMyModule_TypesTest: IDispatch {
 HRESULT boolReturn ([optional,out] VARIANT * excep_OBJ,
 [retval,out] short *val);
 HRESULT charReturn ([optional,out] VARIANT * excep_OBJ,
 [retval,out] short *val);
 HRESULT doubleReturn ([optional,out] VARIANT * excep_OBJ,
 [retval,out] double *val);
}

```

```
HRESULT floatReturn ([optional,out] VARIANT * excep_OBJ,
 [retval,out] float *val);
HRESULT getAll ([out] short *boolTest,
 [out] short *charTest,
 [out] double *doubleTest,
 [out] float *floatTest,
 [out] long *longTest,
 [out] short *octetTest,
 [out] short *shortTest,
 [out] BSTR stringTest,
 [out] BSTR *stringnTest,
 [out] long *ulongTest,
 [out] long *ushortTest,
 [optional,out] VARIANT * excep_OBJ,
 [retval,out] short * val);
HRESULT longReturn ([optional,out] VARIANT * excep_OBJ,
 [retval,out] long *val);
HRESULT octetReturn ([optional,out] VARIANT * excep_OBJ,
 [retval,out] short *val);
HRESULT setAll ([in] short boolTest,
 [in] short charTest,
 [in] double doubleTest,
 [in] float floatTest,
 [in] long longTest,
 [in] short octetTest,
 [in] short shortTest,
 [in] BSTR stringTest,
 [in] BSTR stringnTest,
 [in] long ulongTest,
 [in] long ushortTest,
 [optional,out] VARIANT * excep_OBJ,
 [retval,out] short * val);
HRESULT setAndIncrement ([in,out] short *boolTest,
 [in,out] short *charTest,
 [in,out] double *doubleTest,
 [in,out] float *floatTest,
 [in,out] long *longTest,
 [in,out] short *octetTest,
 [in,out] short *shortTest,
 [in,out] BSTR *stringTest,
 [in,out] BSTR *stringnTest,
 [in,out] long *ulongTest,
 [in,out] long *ushortTest,
 [optional,out] VARIANT * excep_OBJ,
 [retval,out] short *val);
HRESULT shortReturn ([optional,out] VARIANT * excep_OBJ,
 [retval,out] short *val);
HRESULT stringReturn ([optional,out] VARIANT * excep_OBJ,
 [retval,out] BSTR *val);
HRESULT stringnReturn ([optional,out] VARIANT * excep_OBJ,
 [retval,out] BSTR *val);
HRESULT ulongReturn ([optional,out] VARIANT * excep_OBJ,
 [retval,out] long *val);
HRESULT ushortReturn ([optional,out] VARIANT * excep_OBJ,
 [retval,out] long *val);
```



```

[propget] HRESULT boolTest([retval,out] short *val);
[propput] HRESULT boolTest([in] short boolTest);
[propget] HRESULT charTest([retval,out] short *val);
[propput] HRESULT charTest([in] short charTest);
[propget] HRESULT doubleTest([retval,out] double *val);
[propput] HRESULT doubleTest([in] double doubleTest);
[propget] HRESULT floatTest([retval,out] float *val);
[propput] HRESULT floatTest([in] float floatTest);
[propget] HRESULT longTest([retval,out] long *val);
[propput] HRESULT longTest([in] long longTest);
[propget] HRESULT octetTest([retval,out] short *val);
[propput] HRESULT octetTest([in] short octetTest);
[propget] HRESULT readonlyShortTest([retval,out] short *val);
[propget] HRESULT shortTest([retval,out] short *val);
[propput] HRESULT shortTest([in] short shortTest);
[propget] HRESULT stringTest([retval,out] BSTR *val);
[propput] HRESULT stringTest([in] BSTR stringTest);
[propget] HRESULT stringnTest([retval,out] BSTR *val);
[propput] HRESULT stringnTest([in] BSTR stringnTest);
[propget] HRESULT ulongTest([retval,out] long *val);
[propput] HRESULT ulongTest([in] long ulongTest);
[propget] HRESULT ushortTest([retval,out] long *val);
[propput] HRESULT ushortTest([in] long ushortTest);
}

```

## 19.5 Mapping for Object References

### 19.5.1 Type Mapping

The mapping of an object reference as a parameter or return value can be fully expressed by the following OMG IDL and ODL code. The OMG IDL code defines an interface `Simple` and another interface that references `Simple` as an **in** parameter, as an **out** parameter, as an **inout** parameter, and as a return value. The ODL code describes the Automation View Interface that results from an accurate mapping.

```

module MyModule // OMG IDL
{
 // A simple object we can use for testing object references
 interface Simple
 {
 attribute short shortTest;
 };

 interface ObjRefTest
 {
 attribute Simple simpleTest;
 Simple simpleOp(in Simple inTest,
 out Simple outTest,
 inout Simple inoutTest);
 };
}

```

```
}; // End of Module MyModule
```

The ODL code for the Automation View Dispatch Interface follows.

```
[odl, dual, uuid(c166a426-89d4-f515-1dfe-87b88727b4ea)]
interface DIMyModule_Simple: IDispatch
{
 [propget] HRESULT shortTest([retval, out] short *val);
 [propput] HRESULT shortTest([in] short shortTest);
}

[odl, dual, uuid(04843769-120e-e003-1dfd-6b75107d01dd)]
interface DIMyModule_ObjRefTest: IDispatch
{
 HRESULT simpleOp([in]DIMyModule_Simple *inTest,
 [out] DIMyModule_Simple **outTest,
 [in,out] DIMyModule_Simple **inoutTest,
 [optional, out] VARIANT * excep_OBJ,
 [retval, out] DIMyModule_Simple ** val);

 [propget] HRESULT simpleTest([retval, out]
 DIMyModule_Simple **val);
 [propput] HRESULT simpleTest([in] DIMyModule_Simple
 *simpleTest);
}
}
```

### 19.5.2 Object Reference Parameters and IForeignObject

As described in the Interworking Architecture chapter, Automation and COM Views must expose the **IForeignObject** interface in addition to the interface that is isomorphic to the mapped CORBA interface. **IForeignObject** provides a mechanism to extract a valid CORBA object reference from a View object.

Consider an Automation View object B, which is passed as an **in** parameter to an operation M in View A. Operation M must somehow convert View B to a valid CORBA object reference.

In Figure 19-5, Automation Views expose **IForeignObject**, as required of all Views.

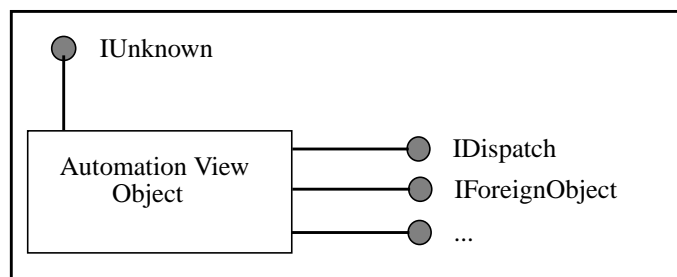

Figure 19-5 Partial Picture of the Automation View

The sequence of events involving **IForeignObject::GetForeignReference** is as follows:

- The client calls **Automation-View-A::M**, passing an IDispatch-derived pointer to Automation-View-B.
- Automation-View-A::M calls **IDispatch::QueryInterface** for IForeignObject.
- Automation-View-A::M calls **IForeignObject::GetForeignReference** to get the reference to the CORBA object of type B.
- Automation-View-A::M calls **CORBA-Stub-A::M** with the reference, narrowed to interface type B, as the object reference **in** parameter.

## 19.6 Mapping for Enumerated Types

CORBA enums map to Automation enums. Consider the following example

```
// OMG IDL
module MyModule {
 enum color {red, green, blue};
 interface foo {
 void op1(in color col);
 };
};
```

which maps to the following ODL:

```
// ODL
typedef enum {MyModule_red, MyModule_green, MyModule_blue}
MyModule_color;

[odl,dual,uuid(7d1951f2-b5d3-8b7c-1dc3-aa0d5b3d6a2b)]
interface DIMyModule_foo: IDispatch {
 HRESULT op1([in] MyModule_color col, [optional,out]
 VARIANT * excep_OBJ);
}
```

Internally, Automation maps enum parameters to the platform's integer type. (For Win32, the integer type is equivalent to a long.) If the number of elements in the CORBA enum exceeds the maximum value of an integer, the condition should be trapped at some point during static or dynamic construction of the Automation View Interface corresponding to the CORBA interface in which the enum type appears as a parameter. If the overflow is detected at run-time, the Automation View operation should return the HRESULT DISP\_E\_OVERFLOW.

If an actual parameter applied to the mapped parameter in the Automation View Interface exceeds the maximum value of the enum, the View operation should return the HRESULT DISP\_E\_OVERFLOW.

Since all Automation controllers do not promote the ODL definition of enums into the controller scripting language context, vendors may wish to generate a header file containing an appropriate enum declaration or a set of constant declarations for the

client language. Since the method for doing so is an implementation detail, it is not specified here. However, it should be noted that some languages type enums other than as longs, introducing the possibility of conversion errors or faults. If such problems arise, it is best to use a series of constant declarations rather than an enumerated type declaration in the client header file.

For example, the following **enum** declaration

```
enum color {red, green, blue, yellow, white};// OMG IDL
```

could be translated to the following Visual Basic code:

```
' Visual Basic
Global const color_red = 0
Global const color_green = 1
Global const color_blue = 2
Global const color_yellow = 3
Global const color_white = 4
```

In this case the default naming rules for the enum values should follow those for interfaces. That is, the name should be fully scoped with the names of enclosing modules or interfaces. (See Section 17.7.8, “Naming Conventions for View Components,” on page 17-30.)

If the enum is declared at global OMG IDL scope, as in the previous example, then the name of the enum should also be included in the constant name.

## 19.7 Mapping for Arrays and Sequences

OMG IDL Arrays and Sequences are mapped as a VARIANT containing an Automation SAFEARRAY. SAFEARRAYs are one- or multi-dimensional arrays whose elements are of any of the basic Automation types. The following ODL syntax describes an array parameter:

### **SAFEARRAY (elementtype) arrayname**

Safearrays have a header that describes certain characteristics of the array including bounding information, and are thus relatively safe for marshaling. Note that the ODL declaration of Safearrays does not include bound specifiers. OLE provides an API for allocating and manipulating Safearrays, includes a procedure for resizing the array.

For bounded Sequence, Safearray will grow dynamically up to the specified bounded size and maintain information on its current length. Unbounded OMG IDL sequences are mapped to VARIANTS containing a Safearray with some default bound. Attempts to access past the boundary result in a resizing of the Safearray.

Since ODL Safearray declarations contain no boundary specifiers, the bounding knowledge is contained in the Automation View. A method of the Automation View Interface, which has the VARIANT containing the Safearray as a parameter, has the intelligence to handle the parameter properly. When the VARIANT is submitted as **in** parameters, the View method uses the Safearray API to dynamically repackage the Safearray as a CORBA array, bounded sequence, or unbounded sequence. When the

VARIANT containing the Safearray is an **out** parameter, the View method uses the Safearray API to dynamically repack the CORBA array or sequence as a Safearray. When an unbounded sequence grows beyond the current boundary of the corresponding Safearray, the View's method uses the Safearray API to increase the size of the array by one allocation unit. The size of an allocation unit is unspecified. If a Safearray is mapped from a bounded sequence and a client of the View attempts to write to the Safearray past the maximum element of the bounded sequence, the View operation considers this a run-time error and returns the HRESULT `DISP_E_OVERFLOW`.

Multidimensional OMG IDL arrays map to VARIANTs containing multidimensional Safearrays. The order of dimensions in the OMG IDL array from left to right corresponds to ascending order of dimensions in the Safearray. If the number of dimensions of an input SAFEARRAY does not match the CORBA type, the Automation view will generate the HRESULT `DISP_E_TYEMISMATCH`.

## 19.8 Mapping for CORBA Complex Types

CORBA constructed types—Structs, Unions, and Exceptions—cannot be mapped directly to ODL constructed types, as Automation does not support them as valid parameter types. Instead, constructed types are mapped to Pseudo-Automation Interfaces. The objects that implement Pseudo-Automation Interfaces are called pseudo-objects. Pseudo-objects do not expose the **IForeignObject** interface.

Pseudo-Automation Interfaces are Dual Interfaces, but do not derive directly from **IDispatch** as do Automation View Interfaces. Instead, they derive from **DIForeignComplexType**:

```
// ODL
[odl, dual, uuid(...)]
interface DIForeignComplexType: IDispatch
{
 [propget] HRESULT ([retval,out]
 BSTR *val);
 HRESULT ([in] IDispatch *pDispatch,
 [out, retval] IDispatch **val);
}
```

The UUID for **DIForeignComplexType** is:

```
{A8B553C0-3B72-11cf-BBFC-444553540000}
```

This interface can also be implemented as a generic (nondual) Automation Interface, in which case it is named **DForeignComplexType** and its UUID is:

```
{E977F900-3B75-11cf-BBFC-444553540000}
```

The direct use of the `INSTANCE repositoryID ()` is deprecated. The approved way to retrieve the repositoryId is through the `DIOBJECTINFO::unique id ()` method.

The direct use of the `INSTANCE clone ()` method is deprecated. The approved way to clone the data referred to by a reference is to use the `DIOBJECTINFO::clone ()` method.

### 19.8.1 Mapping for Structure Types

CORBA structures are mapped to a Pseudo-Struct, which is a Pseudo-Automation Interface containing properties corresponding to the members of the struct. The names of a Pseudo-Struct's properties are identical to the names of the corresponding CORBA struct members.

A Pseudo-Struct derives from `DICORBAstruct` which, in turn, derives from `DIForeignComplexType`:

```
// ODL
[odl, dual, uuid(...)]
interface DICORBAstruct: DIForeignComplexType
{
}
```

The GUID for `DICORBAstruct` is:

```
{A8B553C1-3B72-11cf-BBFC-444553540000}
```

This interface can also be implemented as generic (nondual) Automation Interface, in which case it is named `DCORBAstruct` and its UUID is:

```
{E977F901-3B75-11cf-BBFC-444553540000}
```

The purpose of the methodless `DICORBAstruct` interface is to mark the interface as having its origin in the mapping of a CORBA struct. This information, which can be stored in a type library, is essential for the task of mapping the type back to CORBA in the event of an inverse mapping.

An example of mapping a CORBA struct to a Pseudo-Struct follows. The struct

```
struct S// IDL
{
 long l;
 double d;
 float f;
};
```

maps to Automation as follows, except that the mapped Automation Dual Interface derives from `DICORBAstruct`.

```
// IDL
interface S
{
 attribute long l;
 attribute double d;
```

```

 attribute float f;
};

```

### 19.8.2 Mapping for Union Types

CORBA unions are mapped to a Pseudo-Automation Interface called a Pseudo-Union. A Pseudo-Union contains properties that correspond to the members of the union, with the addition of a discriminator property. The discriminator property's name is **UNION\_d**, and its type is the Automation type that corresponds to the OMG IDL union discriminant.

If a union element is accessed from the Pseudo-Union, and the current value of the discriminant does not match the property being requested, then the operation of the Pseudo-Union returns **DISP\_E\_TYPERMISMATCH**. Whenever an element is set, the discriminant's value is set to the value that corresponds to that element.

A Pseudo-Union derives from the methodless interface **DICORBAUnion** which, in turn, derives from **DIForeignComplexType**:

```

// ODL
[odl, dual, uuid(...)]
interface DICORBAUnion: DIForeignComplexType // ODL
{
 [hidden] HRESULT repositoryID ([out] BSTR * val);
}

```

The UUID for **DICORBAUnion** is:

```
{A8B553C2-3B72-11cf-BBFC-444553540000}
```

This interface can also be implemented as generic (nondual) Automation Interface, in which case it is named **DCORBAUnion** and its UUID is:

```
{E977F902-3B75-11cf-BBFC-444553540000}
```

To support OMG IDL described unions that support multiple case labels per union branch, the **DICORBAUnion2** interface is defined in a way to provide two additional accessors.

```

// ODL
[odl, dual, uuid(...)]
interface DICORBAUnion2 : DICORBAUnion
{
 HRESULT SetValue([in] long disc, [in] VARIANT val);
 [propget, id(-4)]
}

```

```

 HRESULT CurrentValue([out, retval] VARIANT * val);
};

```

The **SetValue** method can be used to set the discriminant and value simultaneously. The **CurrentValue** method will use the current discriminant value to initialize the VARIANT with the union element. All mapped unions should support the **DICORBAUnion2** interface.

The uuid for the **DICORBAUnion2** interface is:

```
{1a2face0-2199-11d1-9d47-00a024a73e4f}
```

The uuid for the **DCORBAUnion2** interface is:

```
{5d4b8bc0-2199-11d1-9d47-00a024a73e4f}
```

An example of mapping a CORBA union to a Pseudo-Union follows. The union

```

interface A; // IDL

union U switch(long)
{
 case 1: long l;
 case 2: float f;
 default: A obj;
};

```

maps to Automation as if it were defined as follows, except that the mapped Automation Dual Interface derives from **DICORBAUnion2**.

```

interface A; // IDL

interface U
{
 // Switch discriminant
 readonly attribute long UNION_d;

 attribute long l;
 attribute float f;
 attribute A obj;
};

```

---

**Note** – The mapping for the OMG IDL default label will be ignored if the cases are exhaustive over the permissible cases (for example, if the switch type is boolean and a case TRUE and case FALSE are both defined).

---

### 19.8.3 Mapping for TypeCodes

The OMG IDL TypeCode data type maps to the **DICORBATypeCode** interface. The **DICORBATypeCode** interface is defined as follows.



```

// ODL
typedef enum {
 tk_null = 0, tk_void, tk_short, tk_long, tk_ushort,
 tk_ulong, tk_float, tk_double, tk_boolean, tk_char,
 tk_octet, tk_any, tk_TypeCode, tk_Principal, tk_objref,
 tk_struct, tk_union, tk_enum, tk_string,
 tk_sequence, tk_array, tk_alias, tk_except
} CORBATCKind;

[odl, dual, uuid(...)]
interface DICORBATypeCode: DIForeignComplexType {
 [propget] HRESULT kind([retval,out] TCKind * val);

 // for tk_objref, tk_struct, tk_union, tk_alias,
 tk_except
 [propget] HRESULT id([retval,out] BSTR *val);
 [propget] HRESULT name([retval,out] BSTR * val);

//tk_struct,tk_union,tk_enum,tk_except
 [propget] HRESULT
member_count([retval,out]
 long * val);
 HRESULT member_name([in] long index,[retval,out]
 BSTR * val);
 HRESULT member_type([in] long index,
 [retval,out] DICORBATypeCode ** val),

// tk_union
 HRESULT member_label([in] long index,[retval,out]
 VARIANT * val);
 [propget] HRESULT discriminator_type([retval,out]
 IDispatch ** val);
 [propget] HRESULT default_index([retval,out]
 long * val);

// tk_string, tk_array, tk_sequence
 [propget] HRESULT length([retval,out] long * val);

// tk_sequence, tk_array, tk_alias
 [propget] HRESULT content_type([retval,out]
 IDispatch ** val);
}

```

The UUID for DICORBATypeCode is:

```
{A8B553C3-3B72-11cf-BBFC-444553540000}
```

This interface can also be implemented as generic (nondual) Automation Interface, in which case it is named DCORBATypeCode and its UUID is:

```
{E977F903-3B75-11cf-BBFC-444553540000}
```

When generating Visual Basic constants corresponding to the values of the **CORBA\_TCKind** enumeration, the constants should be declared as follows.

```
Global const CORBATCKind_tk_null = 0
Global const CORBATCKind_tk_void = 1
. . .
```

Since **DICORBATypeCode** derives from **DIForeignComplexType**, objects that implement it are, in effect, pseudo-objects. See Section 19.8, “Mapping for CORBA Complex Types,” on page 19-19 for a description of the **DIForeignComplexType** interface.

#### 19.8.4 Mapping for *anys*

The OMG IDL **any** data type maps to the **DICORBAAny** interface, which is declared as:

```
//ODL
[odl, dual, uuid(...)]
interface DICORBAAny: DIForeignComplexType
{
 [propget] HRESULT value([retval,out]
 VARIANT * val);
 [propput] HRESULT value([in] VARIANT val);
 [propget] HRESULT typeCode([retval,out]
 DICORBATypeCode ** val);
}
```

The UUID for **DICORBAAny** is:

```
{A8B553C4-3B72-11cf-BBFC-444553540000}
```

This interface can also be implemented as generic (nondual) Automation Interface, in which case it is named **DCORBAAny** and its UUID is:

```
{E977F904-3B75-11cf-BBFC-444553540000}
```

Since **DICORBAAny** derives from **DIForeignComplexType**, objects that implement it are, in effect, pseudo-objects. See Section 19.8, “Mapping for CORBA Complex Types,” on page 19-19 for a description of the **DIForeignComplexType** interface.

Note that the **VARIANT** value property of **DICORBAAny** can represent a Safearray or can represent a pointer to a **DICORBAStruct** or **DICORBAUnion** interface. Therefore, the mapping for **any** is valid for an **any** that represents a CORBA array, sequence, structure, or union.

### 19.8.5 Mapping for Typedefs

The mapping of OMG IDL **typedef** definitions to OLE depends on the OMG IDL type for which the **typedef** is defined. No mapping is provided for **typedef** definitions for the basic types: float, double, long, short, unsigned long, unsigned short, char, boolean, and octet. Hence, a Visual Basic programmer cannot make use of these **typedef** definitions.

```
// OMG IDL
module MyModule {
 module Module2 {
 module Module3 {
 interface foo {};
 };
 };
};
typedef MyModule::Module2::Module3::foo bar;
```

For complex types, the mapping creates an alias for the pseudo-object. For interfaces, the mapping creates an alias for the Automation View object. A conforming implementation may register these aliases in the Windows System Registry.

Creating a View for this interface would require something like the following:

```
` in Visual Basic
Dim a as Object
Set a = theOrb.GetObject("MyModule.Module2.Module3.foo")
` Release the object
Set a = Nothing
` Create the object using a typedef alias
Set a = theOrb.GetObject("bar")
```

### 19.8.6 Mapping for Constants

The notion of a constant does not exist in Automation; therefore, no mapping is prescribed for a CORBA constant.

As with the mapping for enums, some vendors may wish to generate a header file containing an appropriate constant declaration for the client language. For example, the following OMG IDL declaration

```
// OMG IDL
const long Max = 1000;
```

could be translated to the following in Visual Basic:

```
' Visual Basic
Global Const Max = 1000
```

The naming rules for these constants should follow that of enums.

### 19.8.7 Getting Initial CORBA Object References

The **DICORBAFactory** interface, described in Section 17.7.3, “ICORBAFactory Interface,” on page 17-24, provides a mechanism that is more suitable for the typical programmer in an Automation controller environment such as Visual Basic.

The implementation of the **DICORBAFactory** interface is not prescribed, but possible options include delegating to the OMG Naming Service and using the Windows System Registry<sup>1</sup>.

The use of this interface from Visual Basic would appear as:

```
Dim theORBfactory as Object
Dim Target as Object
Set theORBfactory=CreateObject ("CORBA.Factory")
Set Target=theORBfactory.GetObject
 ("software.sales.accounts")
```

In Visual Basic 4.0 projects that have preloaded the standard CORBA Type Library, the code could appear as follows:

```
Dim Target as Object
Set Target=theORBfactory.GetObject ("soft-
ware.sales.accounts")
```

The stringified name used to identify the desired target object should follow the rules for arguments to **DICORBAFactory::GetObject** described in Section 17.7.3, “ICORBAFactory Interface,” on page 17-24.

A special name space for names with a period in the first position can be used to resolve an initial reference to the OMG Object Services (for example, the Naming Service, the Life Cycle Service, and so forth). For example, a reference for the Naming Service can be found using:

```
Dim NameContext as Object
Set NameContext=theORBfactory.GetObject (".NameService")
```

Generally the **GetObject** method will be used to retrieve object references from the Registry/Naming Service. The **CreateObject** method is really just a shorthand notation for **GetObject** (“someName”).create. It is intended to be used for object references to objects supporting a CORBAServices Factory interface.

---

1. It is always permissible to directly register a CORBA Automation bridging object directly with the Windows Registry. The administration and assignment of ProgIds for direct registration should follow the naming rules described in the *Interworking Architecture* chapter.

### 19.8.8 Creating Initial in Parameters for Complex Types

Although CORBA complex types are represented by Automation Dual Interfaces, creating an instance of a mapped CORBA complex type is not the same as creating an instance of a mapped CORBA interface. The main difference lies in the fact that the name space for CORBA complex types differs fundamentally from the CORBA object and factory name spaces.

To support creation of instances of Automation objects exposing Pseudo-Automation Interfaces, we define a new interface, derived from DICORBAFactory (see Section 17.7.3, “ICORBAFactory Interface,” on page 17-24 for a description of DICORBAFactory).

```
// ODL
[odl, dual, uuid(...)]
interface DICORBAFactoryEx: DICORBAFactory
{
 HRESULT CreateType([in] IDispatch *scopingObject,
 [in] BSTR typeName,
 [retval,out] VARIANT *val);
 HRESULT CreateTypeById([in] IDispatch *scopingObject,
 [in] BSTR repositoryId,
 [retval,out] VARIANT *val);
}
```

The UUID for **DICORBAFactoryEx** is:

```
{A8B553C5-3B72-11cf-BBFC-444553540000}
```

This interface can also be implemented as generic (nondual) Automation Interface, in which case it is named **DCORBAFactoryEx** and its UUID is:

```
{E977F905-3B75-11cf-BBFC-444553540000}
```

The CreateType method creates an Automation object that has been mapped from a CORBA complex type. The parameters are used to determine the specific type of object returned.

The first parameter, scopingObject, is a pointer to an Automation View Interface. The most derived interface type of the CORBA object bound to the View identifies the scope within which the second parameter, typeName, is interpreted. For example, assume the following CORBA interface exists:

```
// OMG IDL
module A {
 module B {
 interface C {
 struct S {
 // ...
 }
 }
 }
}
```

```

 void op(in S s);
 //
 }
}
}

```

The following Visual Basic example illustrates the primary use of CreateType:

```

` Visual Basic
Dim myC as Object
Dim myS as Object
Dim myCORBAFactory as Object
Set myCORBAFactory = CreateObject("CORBA.Factory")
Set myC = myCORBAFactory.CreateObject("... ")

` creates Automation View of the CORBA object
 supporting interface ` A::B::C
Set myS = myCORBAFactory.CreateType(myC, "S")
myC.op(myS)

```

The following rules apply to CreateType:

- The typeName parameter can contain a fully-scoped name (i.e., the name begins with a double colon "::"). If so, then the first parameter defines the type name space within which the fully scoped name will be resolved.
- If the scopingObject parameter does not point to a valid Automation View Interface, then CreateObject returns the HRESULT DISP\_E\_UNKNOWNINTERFACE.
- If the typeName parameter does not identify a valid type in the name space associated with the scopingObject parameter, then CreateObject returns the HRESULT TYPE\_E\_UNDEFINEDTYPE.

The **CreateTypeById** method accomplishes the same general goal of CreateType, the creation of Automation objects that are mapped from CORBA-constructed types. The second parameter, repositoryID, is a string containing the CORBA Interface Repository ID of the CORBA type whose mapped Automation Object is to be created. The Interface Repository associated with the CORBA object identified by the scopingObject parameter defines the repository within which the ID will be resolved.

The following rules apply to **CreateTypeById**:

- If the scopingObject parameter does not point to a valid Automation View Interface, then CreateObject returns the HRESULT DISP\_E\_UNKNOWNINTERFACE.
- If the repositoryID parameter does not identify a valid type in the Interface Repository associated with the scopingObject parameter, then CreateObject returns the HRESULT TYPE\_E\_UNDEFINEDTYPE.

### 19.8.8.1 *ITypeFactory Interface*

The **DICORBAFactoryEx** interface delegates its `CreateType` and `CreateTypeById` methods to an **ITypeFactory** interface on the scoping object. **ITypeFactory** is defined as a COM interface because it is not intended to be exposed to Automation controllers. Every Automation View object must support the **ITypeFactory** interface:

```
//MIDL
interface ITypeFactory: IUnknown
{
 HRESULT CreateType([in] LPWSTR typeName, [out] VARIANT
 *val);
 HRESULT CreateTypeById([in] RepositoryId repositoryID,
 [out] VARIANT *val);
}
```

The UUID for **ITypeFactory** is:

```
{A8B553C6-3B72-11cf-BBFC-444553540000}
```

The methods on **ITypeFactory** provide the behaviors previously described for the corresponding **DICORBAFactoryEx** methods.

### 19.8.8.2 *DIOBJECTINFO Interface*

The **DIOBJECTINFO** interface provides helper functions for retrieving information about a composite data type (such as a union, structure, exception, ...), which is held as an **IDISPATCH** pointer.

```
// ODL
[odl, dual, uuid(...)]
interface DIOBJECTINFO: DICORBAFactoryEx
{
 HRESULT type_name([in] IDISPATCH *target,
 [out, optional] VARIANT *except_obj,
 [out, retval] BSTR *typeName);
 HRESULT scoped_name([in] IDISPATCH *target,
 [out, optional] VARIANT *except_obj,
 [out, retval] BSTR *repositoryId);
 HRESULT unique_id([in] IDISPATCH *target,
 [out, optional] VARIANT *except_obj,
 [out, retval] BSTR *repositoryId);
}
```

The UUID for **DIOBJECTINFO** is:

```
{6dd1b940-21a0-11d1-9d47-00a024a73e4f}
```

This interface can also be implemented as generic (nondual) Automation Interface, in which case it is named **DOBJECTINFO** and its UUID is:

{8fbbf980-21a0-11d1-9d47-00a024a73e4f}

The Automation object having the ProgId “**CORBA.Factory**” exposes **DIOBJECTINFO**.

## 19.8.9 Mapping CORBA Exceptions to Automation Exceptions

### 19.8.9.1 Overview of Automation Exception Handling

Automation’s notion of exceptions does not resemble true exception handling as defined in C++ and CORBA. Automation methods are invoked with a call to **IDispatch::Invoke** or to a vtable method on a Dual Interface. These methods return a 32-bit HRESULT, as do almost all COM methods. HRESULT values, which have the *severity* bit (bit 31 being the high bit) set, indicate that an error occurred during the call, and thus are considered to be error codes. (In Win16, an SCODE was defined as the lower 31 bits of an HRESULT, whereas in Win32 and for our purposes HRESULT and SCODE are identical.) HRESULTs also have a multibit field called the facility. One of the predefined values for this field is FACILITY\_DISPATCH. Visual Basic 4.0 examines the return HRESULT. If the severity bit is set and the facility field has the value FACILITY\_DISPATCH, then Visual Basic executes a built-in error handling routine, which pops up a message box and describes the error.

Invoke has among its parameters one of type EXCEPINFO\*. The caller can choose to pass a pointer to an EXCEPINFO structure in this parameter or to pass NULL. If a non-NULL pointer is passed, the callee can choose to handle an error condition by returning the HRESULT DISP\_E\_EXCEPTION and by filling in the EXCEPINFO structure.

OLE also provides Error Objects, which are task local objects containing similar information to that contained in the EXCEPINFO structure. Error objects provide a way for Dual Interfaces to set detailed exception information.

Visual Basic allows the programmer to set up error traps, which are automatically fired when an invocation returns an HRESULT with the severity bit set. If the HRESULT is DISP\_E\_EXCEPTION, or if a Dual Interface has filled an Error Object, the data in the EXCEPINFO structure or in the Error Object can be extracted in the error handling routine.

### 19.8.9.2 CORBA Exceptions

CORBA exceptions provide data not directly supported by the Automation error handling model. Therefore, all methods of Automation View Interfaces have an additional, optional **out** parameter of type VARIANT, which is filled in by the View when a CORBA exception is detected.

Both CORBA System exceptions and User exceptions map to Pseudo-Automation Interfaces called pseudo-exceptions. Pseudo-exceptions derive from **IForeignException**, which in turn derives from **IForeignComplexType**:



```
//ODL
[odl, dual, uuid(...)]
interface DIForeignException: DIForeignComplexType
{
 [propget] HRESULT EX_majorCode([retval,out] long *val);
 [propget] HRESULT EX_repositoryID([retval,out] BSTR *val);
};
```

The **EX\_Id()** method will return the name of the exception. For CORBA exceptions, this will be the unscoped name of the exception. Additional accessors are available on the **DIOBJECTINFO** interface for returning the scoped name and repository id for CORBA exceptions.

---

**Note** – Renaming **EX\_RepositoryId** to **EX\_Id** does break backwards compatibility, but should simplify the use of exceptions from VB.

---

The UUID for **DIForeignException** is:

```
{A8B553C7-3B72-11cf-BBFC-444553540000}
```

This interface can also be implemented as generic (nondual) Automation Interface, in which case it is named **DForeignException** and its UUID is:

```
{E977F907-3B75-11cf-BBFC-444553540000}
```

The attribute **EX\_majorCode** defines the broad category of exceptions raised, and has one of the following numeric values:

```
NO_EXCEPTION = 0
SYSTEM_EXCEPTION = 1
USER_EXCEPTION = 2
```

These values may be specified as an enum in the typelibrary information:

```
typedef enum {NO_EXCEPTION,
 SYSTEM_EXCEPTION,
 USER_EXCEPTION } CORBA_ExceptionType;
```

The attribute **EX\_repositoryID** is a unique string that identifies the exception. It is the exception type's repository ID from the CORBA Interface Repository.

### 19.8.9.3 CORBA User Exceptions

A CORBA user exception is mapped to a properties-only pseudo-exception whose properties correspond one-to-one with the attributes of the CORBA user exception, and which derives from the methodless interface **DICORBAUserException**:

```
//ODL
[odl, dual, uuid(...)]
interface DICORBAUserException: DIForeignException
{
}
```

The UUID for **DICORBAUserException** is:

```
{A8B553C8-3B72-11cf-BBFC-444553540000}
```

This interface can also be implemented as generic (nondual) Automation Interface, in which case it is named **DCORBAUserException** and its UUID is:

```
{E977F908-3B75-11cf-BBFC-444553540000}
```

Thus, an OMG IDL exception declaration is mapped to an OLE definition as though it were defined as an interface. The declaration

```
// OMG IDL
exception reject
{
 string reason;
};
```

maps to the following ODL:

```
//ODL
[odl, dual, uuid(6bfaf02d-9f3b-1658-1dfb-7f056665a6bd)]
interface DReject: DICORBAUserException
{
 [propget] HRESULT reason([retval,out] BSTR reason);
}
```

#### 19.8.9.4 Operations that Raise User Exceptions

If the optional exception parameter is supplied by the caller and a User Exception occurs, the parameter is filled in with an IDispatch pointer to an exception Pseudo-Automation Interface, and the operation on the Pseudo-Interface returns the HRESULT S\_FALSE. S\_FALSE does not have the severity bit set, so that returning it from the operation prevents an active Visual Basic Error Trap from being fired, allowing the caller to retrieve the exception parameter in the context of the invoked method. The View fills in the VARIANT by setting its *vt* field to VT\_DISPATCH and setting the *pdispval* field to point to the pseudo-exception. If no exception occurs, the optional parameter is filled with an IForeignException pointer on a pseudo-exception object whose EX\_majorCode property is set to NO\_EXCEPTION.

If the optional parameter is not supplied and an exception occurs, and

- If the operation was invoked via **IDispatch::Invoke**, then
  - The operation returns DISP\_E\_EXCEPTION.
  - If the caller provided an EXCEPINFO, then it is filled by the View.

- If the method was called via the vtable portion of a Dual Interface, then the OLE Error Object is filled by the View.

Note that in order to support Error Objects, Automation Views must implement the standard OLE interface ISupportErrorInfo.

Table 19-3 EXCEPINFO Usage for CORBA User Exceptions

| Field             | Description                                                                                                                                                       |
|-------------------|-------------------------------------------------------------------------------------------------------------------------------------------------------------------|
| wCode             | Must be zero.                                                                                                                                                     |
| bstrSource        | <interface name>.<operation name><br><i>where the interface and operation names are those of the CORBA interface, which this Automation View is representing.</i> |
| bstrDescription   | CORBA User Exception [<exception repository id>]<br><i>where the repository id is that of the CORBA user exception.</i>                                           |
| bstrHelpFile      | Unspecified                                                                                                                                                       |
| dwHelpContext     | Unspecified                                                                                                                                                       |
| pfnDeferredFillIn | NULL                                                                                                                                                              |
| scode             | DISP_E_EXCEPTION                                                                                                                                                  |

Table 19-4 ErrorObject Usage for CORBA User Exceptions

| Property        | Description                                                                                                                                                       |
|-----------------|-------------------------------------------------------------------------------------------------------------------------------------------------------------------|
| bstrSource      | <interface name>.<operation name><br><i>where the interface and operation names are those of the CORBA interface, which this Automation View is representing.</i> |
| bstrDescription | CORBA User Exception: [<exception repository id>]<br><i>where the repository id is that of the CORBA user exception.</i>                                          |
| bstrHelpFile    | Unspecified                                                                                                                                                       |
| dwHelpContext   | Unspecified                                                                                                                                                       |
| GUID            | The IID of the Automation View Interface.                                                                                                                         |

### 19.8.9.5 CORBA System Exceptions

A CORBA System Exception is mapped to the Pseudo-Exception **DICORBASystemException**, which derives from **DIForeignException**:

```
// ODL
[odl, dual, uuid(...)]
interface DICORBASystemException: DIForeignException
{
```

```

 [propget] HRESULT EX_minorCode([retval,out] long *val);
 [propget] HRESULT EX_completionStatus([retval,out] long
*val);
 }

```

The UUID for **DICORBASystemException** is:

```
{1E5FFCA0-563B-11cf-B8FD-444553540000}
```

This interface can also be implemented as generic (nondual) Automation Interface, in which case it is named **DCORBASystemException** and its UUID is:

```
{1E5FFCA1-563B-11cf-B8FD-444553540000}
```

The attribute **EX\_minorCode** defines the type of system exception raised, while **EX\_completionStatus** has one of the following numeric values:

```

COMPLETION_YES = 0
COMPLETION_NO = 1
COMPLETION_MAYBE =

```

These values may be specified as an enum in the typelibrary information:

```

typedef enum {COMPLETION_YES,
 COMPLETION_NO,
 COMPLETION_MAYBE }
CORBA_CompletionStatus;

```

### 19.8.9.6 Operations that raise system exceptions

As is the case for UserExceptions, system exceptions can be returned to the caller using the optional last parameter, which is present on all mapped methods.

If the optional parameter is supplied and a system exception occurs, the optional parameter is filled in with an **IForeignException** pointer to the pseudo-exception, and the automation return value is **S\_FALSE**. If no exception occurs, the optional parameter is filled with an **IForeignException** pointer whose **EX\_majorCode** property is set to **NO\_EXCEPTION**.

If the optional parameter is not supplied and a system exception occurs, the exception is looked up in Table 19-5. This table maps a subset of the CORBA system exceptions to semantically equivalent **FACILITY\_DISPATCH** **HRESULT** values. If the exception is on the table, the equivalent **HRESULT** is returned. If the exception is not on the table, that is, if there is no semantically equivalent **FACILITY\_DISPATCH** **HRESULT**, then the exception is mapped to an **HRESULT** according to Table 19-5 on page 19-35. This new **HRESULT** is used as follows.

- If the operation was invoked via **IDispatch::Invoke**:
  - The operation returns **DISP\_E\_EXCEPTION**.
  - If the caller provided an **EXCEPINFO**, then it is filled with the **scode** field set to the new **HRESULT** value.

- If the method was called via the vtable portion of a Dual Interface:
  - The OLE Error Object is filled.
  - The method returns the new HRESULT

Table 19-5 CORBA Exception to COM Error Codes

| CORBA Exception | COM Error Codes       |
|-----------------|-----------------------|
| BAD_OPERATION   | DISP_E_MEMBERNOTFOUND |
| NO_RESPONSE     | DISP_E_PARAMNOTFOUND  |
| BAD_INV_ORDER   | DISP_E_BADINDEX       |
| INV_IDENT       | DISP_E_UNKNOWNNAME    |
| INV_FLAG        | DISP_E_PARAMNOTFOUND  |
| DATA_CONVERSION | DISP_E_OVERFLOW       |

Table 19-6 EXCEPINFO Usage for CORBA System Exceptions

| Field             | Description                                                                                                                                                                                                                                                                                                                                                                                             |
|-------------------|---------------------------------------------------------------------------------------------------------------------------------------------------------------------------------------------------------------------------------------------------------------------------------------------------------------------------------------------------------------------------------------------------------|
| wCode             | Must be zero.                                                                                                                                                                                                                                                                                                                                                                                           |
| bstrSource        | <interface name>.<operation name><br>where the interface and operation names are those of the CORBA interface, which this Automation View is representing.                                                                                                                                                                                                                                              |
| bstrDescription   | CORBA System Exception: [<exception repository id>] minor code [<minor code>][<completion status>]<br>where the <exception repository id> and <minor code> are those of the CORBA system exception. <completion status> is "YES," "NO," or "MAYBE" based upon the value of the system exceptions's CORBA completion status. Spaces and square brackets are literals and must be included in the string. |
| bstrHelpFile      | Unspecified                                                                                                                                                                                                                                                                                                                                                                                             |
| dwHelpContext     | Unspecified                                                                                                                                                                                                                                                                                                                                                                                             |
| pfnDeferredFillIn | NULL                                                                                                                                                                                                                                                                                                                                                                                                    |
| scode             | Mapped COM error code from Table 18-3 on page 18-12.                                                                                                                                                                                                                                                                                                                                                    |

Table 19-7 ErrorObject Usage for CORBA System Exceptions

| Property        | Description                                                                                                                                                                                                                                                                                                                                                                                             |
|-----------------|---------------------------------------------------------------------------------------------------------------------------------------------------------------------------------------------------------------------------------------------------------------------------------------------------------------------------------------------------------------------------------------------------------|
| bstrSource      | <interface name>.<operation name><br>where the interface and operation names are those of the CORBA interface, which this Automation View is representing.                                                                                                                                                                                                                                              |
| bstrDescription | CORBA System Exception: [<exception repository id>] minor code [<minor code>][<completion status>]<br>where the <exception repository id> and <minor code> are those of the CORBA system exception. <completion status> is "YES," "NO," or "MAYBE" based upon the value of the system exceptions's CORBA completion status. Spaces and square brackets are literals and must be included in the string. |
| bstrHelpFile    | Unspecified                                                                                                                                                                                                                                                                                                                                                                                             |
| dwHelpContext   | Unspecified                                                                                                                                                                                                                                                                                                                                                                                             |
| GUID            | The IID of the Automation View Interface.                                                                                                                                                                                                                                                                                                                                                               |

### 19.8.10 Conventions for Naming Components of the Automation View

The conventions for naming components of the Automation View are detailed in Section 17.7.8, "Naming Conventions for View Components," on page 17-30.

### 19.8.11 Naming Conventions for Pseudo-Structs, Pseudo-Unions, and Pseudo-Exceptions

The formulas used to name components of the Automation View (see Section 17.7.8, "Naming Conventions for View Components," on page 17-30) are also used to name components Pseudo-Structs, Pseudo-Unions, and Pseudo-Exceptions. The CORBA type name is used as input to the formulas, just as the CORBA interface name is used as input to the formulas when mapping interfaces.

These formulas apply to the name and IID of the Pseudo-Automation Interface, and to the Program Id and Class Id of an object implementing the Pseudo-Automation Interface if it is registered in the Windows System Registry.

### 19.8.12 Automation View Interface as a Dispatch Interface (Nondual)

In addition to implementing the Automation View Interface as an Automation Dual Interface, it is also acceptable to map it as a generic Dispatch Interface.

---

**Note** – All views that expose the dual interface must respond to QueryInterface for both the dual interface IID as well as for the non-dual interface IID.

---

In this case, the normal methods and attribute accessor/assign methods are not required to have HRESULT return values. Instead, an additional “dispinterface” is defined, which can use the standard OLE dispatcher to dispatch invocations.

For example, a method declared in a dual interface in ODL as follows:

```
HRESULT aMethod([in] <type1> arg1, [out] <type2> arg2,
 [retval, out] <return type> *val)
```

would be declared in ODL in a dispatch interface in the following form:

```
<return type> aMethod([in] <type1> arg1, [out] <type2> arg2)
```

Using the example from Section 19.2, “Mapping for Interfaces,” on page 19-3:

```
interface account
// OMG IDL
 attribute float balance;
 readonly attribute string owner;
 void makeLodgement (in float amount, out float
balance);
 void makeWithdrawal (in float amount, out float
balance);
};
```

the corresponding Iaccount interfaces are defined as follows.

```
[uuid(e268443e-43d9-3dab-1dbe-f303bbe9642f), oleautomation]
dispinterface Daccount: IUnknown { // ODL
 properties:
 [id(0)] float balance;
 [id(i), readonly] BSTR owner;
 methods:
 [id(2)] void makeLodgement([in] float amount,
 [out] float *balance,
 [out, optional]VARIANT OBJ);
 [id(3)] void makeWithdrawal ([in] float amount,
 [out] float *balance,
 [out, optional]VARIANT *excep OBJ);
};
```

The dispatch interface is Daccount. In the example used for mapping object references in Section 19.5, “Mapping for Object References,” on page 19-15, the reference to the Simple interface in the OMG IDL would map to a reference to

**DMyModule\_Simple** rather than **DIMyModule\_Simple**. The naming conventions for Dispatch Interfaces (and for their IIDs) exposed by the View are slightly different from Dual Interfaces. See Section 17.7.8, “Naming Conventions for View Components,” on page 17-30 for details.

The Automation View Interface must correctly respond to a QueryInterface for the specific Dispatch Interface Id (DIID) for that View. By conforming to this requirement, the Automation View can be strongly type-checked. For example,

**TypeInfo::Invoke**, when handling a parameter that is typed as a pointer to a specific DIID, calls QueryInterface on the object for that DIID to make sure the object is of the required type.

Pseudo-Automation Interfaces representing CORBA complex types such as structs, unions, exceptions and the other noninterface constructs mapped to dispatch interfaces can also be exposed as nondual dispatch interfaces.

### *19.8.13 Aggregation of Automation Views*

COM's implementation reuse mechanism is aggregation. Automation View objects must either be capable of being aggregated in the standard COM fashion or must follow COM rules to indicate their inability or unwillingness to be aggregated.

The same rule applies to pseudo-objects.

### *19.8.14 DII and DSI*

Automation interfaces are inherently self-describing and may be invoked dynamically. There is no utility in providing a mapping of the DII interfaces and related pseudo-objects into OLE Automation interfaces.

## *19.9 Mapping Automation Objects as CORBA Objects*

This problem is the reverse of exposing CORBA objects as Automation objects. It is best to solve this problem in a manner similar to the approach for exposing CORBA objects as Automation objects.

### *19.9.1 Architectural Overview*

We begin with ODL or type information for an Automation object, which implements one or more dispatch interfaces and whose server application exposes a class factory for its COM class.

We then create a CORBA View object, which provides skeletal implementations of the operations of each of those interfaces. The CORBA View object is in every way a legal CORBA object. It is not an Automation object. The skeleton is placed on the machine where the real Automation object lives.

The CORBA View is not fully analogous to the Automation View, which as previously explained, is used to represent a CORBA object as an Automation object. The Automation View has to reside on the client side because COM is not distributable. A copy of the Automation View needs to be available on every client machine.



The CORBA View, however, can live in the real CORBA object's space and can be represented on the client side by the CORBA system's stub because CORBA is distributable. Thus, only one copy of this View is required.

**Note** – Throughout this section, the term *CORBA View* is distinct from CORBA stubs and skeletons, COM proxies and stubs, and Automation Views.

The CORBA View is an Automation client. Its implementations of the CORBA operations translate parameter types and delegate to the corresponding methods of the real Automation object. When a CORBA client wishes to instantiate the real Automation object, it instantiates the CORBA View.

Thus, from the point of view of the client, it is interacting with a CORBA object, which may be a remote object. CORBA handles all of the interprocess communication and marshaling. No COM proxies or stubs are created.

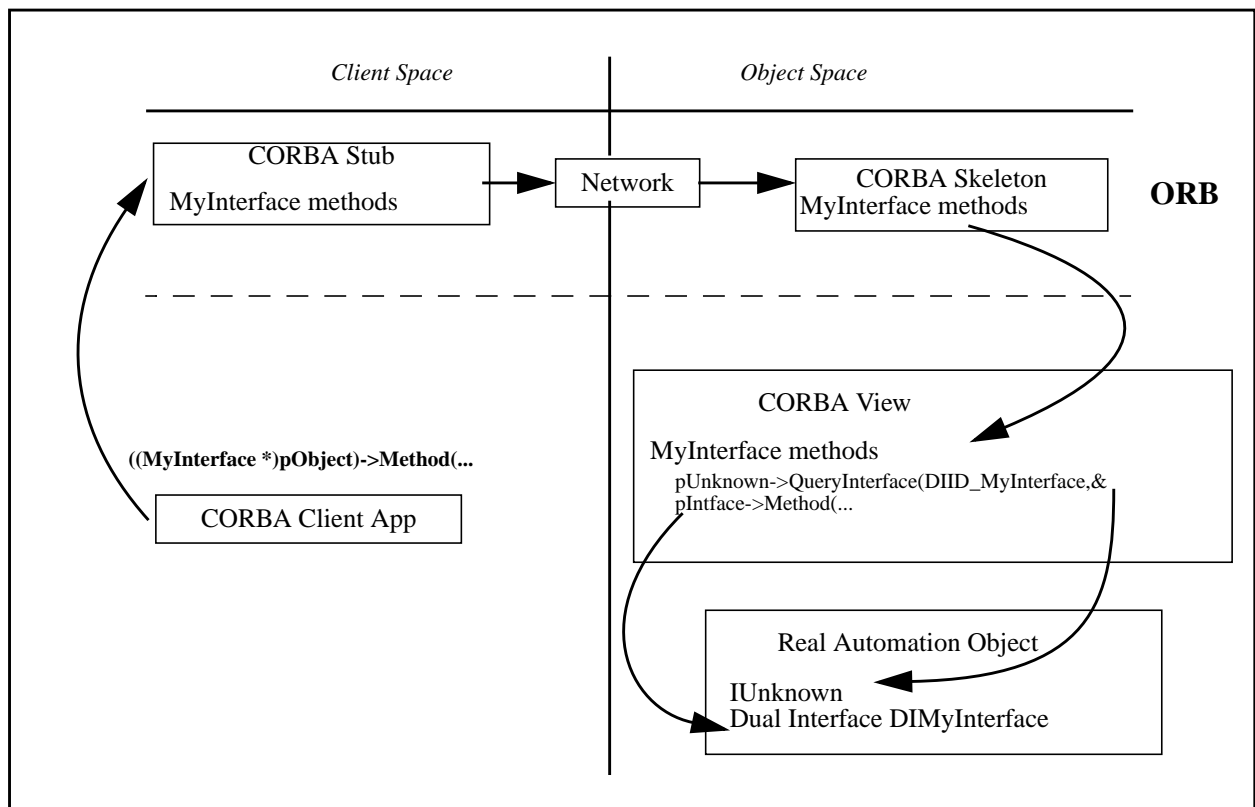

Figure 19-6 The CORBA View: a CORBA Object, which is a Client of a COM Object

### 19.9.2 Main Features of the Mapping

- ODL or type library information can form the input for the mapping.
- Automation properties and methods map to OMG IDL attributes and operations, respectively.

- Automation interfaces map to OMG IDL interfaces.
- Automation basic types map to corresponding OMG IDL basic types where possible.
- Automation errors are mapped similarly to COM errors.

### 19.9.3 Getting Initial Object References

The OMG Naming Service can be used to get initial references to the CORBA View Interfaces. These interfaces may be registered as normal CORBA objects on the remote machine.

### 19.9.4 Mapping for Interfaces

The mapping for an ODL interface to a CORBA View interface is straightforward. Each interface maps to an OMG IDL interface. In general, we map all methods and properties with the exception of the IUnknown and IDispatch methods.

For example, given the ODL interface **IMyModule\_account**,

```
[odl, dual, uuid(...)]
interface DIMyModule_account: IDispatch
{
 [propget] HRESULT balance([retval,out] float * ret);
};
```

the following is the OMG IDL equivalent:

```
// OMG IDL
interface MyModule_account
{
 readonly attribute float balance;
};
```

If the ODL interface does not have a parameter with the **[retval,out]** attributes, its return type is mapped to long. This allows COM SCODE values to be passed through to the CORBA client.

### 19.9.5 Mapping for Inheritance

A hierarchy of Automation interfaces is mapped to an identical hierarchy of CORBA View Interfaces.

For example, given the interface “account” and its derived interface “checkingAccount” defined next,

```
// ODL
[odl, dual, uuid(...)]
interface DIMyModule_account: IDispatch {
 [propput] HRESULT balance([in] float balance);
```

```

 [propget] HRESULT balance([retval,out] float * ret);
 [propget] HRESULT owner([retval,out] BSTR * ret);
 HRESULT makeLodgement([in] float amount,
 [out] float * balance);
 HRESULT makeWithdrawal([in] float amount,
 [out] float * balance);
};
interface DIMyModule_checkingAccount: DIMyModule_account {
 [propget] HRESULT overdraftLimit ([retval,out]
 short * ret);
 HRESULT orderChequeBook([retval,out] short * ret);
};

```

the corresponding CORBA View Interfaces are:

```

// OMG IDL
interface MyModule_account {
 attribute float balance;
 readonly attribute string owner;
 long makeLodgement (in float amount, out float
 balance);
 long makeWithdrawal (in float amount, out float
 theBalance);
};
interface MyModule_checkingAccount: MyModule_account {
 readonly attributeshort overdraftLimit;
 short orderChequeBook ();
};

```

### 19.9.6 Mapping for ODL Properties and Methods

An ODL property has either a get/set pair or just a set method is mapped to an OMG IDL attribute. An ODL property with just a get accessor is mapped to an OMG IDL readonly attribute.

Given the ODL interface definition

```

// ODL
[odl, dual, uuid(...)]
interface DIaccount: IDispatch {
 [propput] HRESULT balance ([in] float balance,
 [propget] HRESULT balance ([retval,out] float * ret);
 [propget] HRESULT owner ([retval,out] BSTR * ret);
 HRESULT makeLodgement([in] float amount,
 [out] float * balance,
 [optional, out] VARIANT * excep_OBJ);
 HRESULT makeWithdrawal([in] float amount,
 [out] float * balance,
 [optional, out] VARIANT * excep_OBJ);
}

```

the corresponding OMG IDL interface is:

```
// OMG IDL
interface account {
attribute float balance;
 readonly attribute string owner;
 long makeLodgement(in float amount, out float balance);
 long makeWithdrawal(in float amount, out float balance);
};
```

ODL **[in]**, **[out]**, and **[in,out]** parameters map to OMG IDL **in**, **out**, and **inout** parameters, respectively. Section 19.3, “Mapping for Basic Data Types,” on page 19-9 explains the mapping for basic types.

## 19.9.7 Mapping for Automation Basic Data Types

### 19.9.7.1 Basic automation types

The basic data types allowed by Automation as parameters and return values are detailed in Section 19.3, “Mapping for Basic Data Types,” on page 19-9.

The formal mapping of CORBA types to Automation types is shown in Table 19-8.

Table 19-8 Mapping of Automation Types to OMG IDL Types

| <b>OLE Automation Type</b> | <b>OMG IDL Type</b> |
|----------------------------|---------------------|
| boolean                    | boolean             |
| short                      | short               |
| double                     | double              |
| float                      | float               |
| long                       | long                |
| BSTR                       | string              |
| CURRENCY                   | COM::Currency       |
| DATE                       | double              |
| SCODE                      | long                |

---

**Note** – The mapping of BSTR to WString breaks backwards compatibility where BSTR was mapped to string.

---

The Automation CURRENCY type is a 64-bit integer scaled by 10,000, giving a fixed point number with 15 digits left of the decimal point and 4 digits to the right. The **COM::Currency** type is thus defined as follows:

```

module COM
{
 struct Currency
 {
 unsigned long lower;
 long upper;
 }
}

```

This mapping of the CURRENCY type is transitional and should be revised when the extended data types revisions to OMG IDL are adopted. These revisions are slated to include a 64-bit integer.

The Automation DATE type is an IEEE 64-bit floating-point number representing the number of days since December 30, 1899.

### *19.9.8 Conversion Errors*

An operation of a CORBA View Interface must perform bidirectional translation of the Automation and CORBA parameters and return types. It must map from CORBA to Automation for “in” parameters and from Automation to CORBA for “out” parameters.

When the CORBA View encounters an error condition while translating between CORBA and Automation data types, it raises the CORBA system exception `DATA_CONVERSION`.

### *19.9.9 Special Cases of Data Type Conversion*

#### *19.9.9.1 Translating `COM::Currency` to Automation `CURRENCY`*

If the supplied `COM::Currency` value does not translate to a meaningful Automation `CURRENCY` value, then the CORBA View should raise the CORBA System Exception `DATA_CONVERSION`.

#### *19.9.9.2 Translating CORBA double to Automation DATE*

If the CORBA double value is negative or converts to an impossible date, then the CORBA View should raise the CORBA System Exception `DATA_CONVERSION`.

#### *19.9.9.3 Translating CORBA boolean to Automation boolean and Automation boolean to CORBA boolean*

True and false values for CORBA boolean are, respectively, one and zero. True and false values for Automation boolean are, respectively, negative one (-1) and zero. Therefore, true values need to be adjusted accordingly.

### 19.9.10 A Complete OMG IDL to ODL Mapping for the Basic Data Types

As previously stated, there is no requirement that the ODL code expressing the mapped Automation interface actually exist. Other equivalent expressions of Automation interfaces, such as the contents of a Type Library, may be used. Moreover, there is no requirement that OMG IDL code corresponding to the CORBA View Interface be generated.

However, ODL is the appropriate medium for describing an Automation interface, and OMG IDL is the appropriate medium for describing a CORBA View Interface. Therefore, we provide the following ODL code to describe an Automation interface, that exercises all of the Automation base data types in the roles of properties, method [in] parameter, method [out] parameter, method [inout] parameter, and return value. The ODL code is followed by OMG IDL code describing the CORBA View Interface, which would result from a conformant mapping.

```
// ODL
[odl, dual, uuid(...)]
interface DIMyModule_TypesTest: IForeignObject {
 [propput] HRESULT boolTest([in] VARIANT BOOL boolTest);
 [propget] HRESULT boolTest([retval,out] short *val);
 [propput] HRESULT doubleTest([in] double doubleTest);
 [propget] HRESULT doubleTest([retval,out] double *val);
 [propput] HRESULT floatTest([in] float floatTest);
 [propget] HRESULT floatTest([retval,out] float *val);
 [propput] HRESULT longTest([in] long longTest);
 [propget] HRESULT longTest([retval,out] long *val);
 [propput] HRESULT shortTest([in] short shortTest);
 [propget] HRESULT shortTest([retval,out] short *val);
 [propput] HRESULT stringTest([in] BSTR stringTest);
 [propget] HRESULT stringTest([retval,out] BSTR *val);
 [propput] HRESULT dateTest([in] DATE stringTest);
 [propget] HRESULT dateTest([retval,out] DATE *val);
 [propput] HRESULT currencyTest([in] CURRENCY stringTest);
 [propget] HRESULT currencyTest([retval,out] CURRENCY *val);
 [propget] HRESULT readonlyShortTest([retval,out] short
 *val);
 HRESULT setAll(
 [in] VARIANT BOOL boolTest,
 [in] double doubleTest,
 [in] float floatTest,
 [in] long longTest,
 [in] short shortTest,
 [in] BSTR stringTest,
 [in] DATE dateTest,
 [in] CURRENCY currencyTest,
 [retval,out] short * val);
 HRESULT getAll(
 [out] VARIANT BOOL *boolTest,
 [out] double *doubleTest,
 [out] float *floatTest,
 [out] long *longTest,
 [out] short *shortTest,
 [out] BSTR stringTest,
 [out] DATE * dateTest,
 [out] CURRENCY *currencyTest,
```

```

 [retval,out] short * val);
HRESULT setAndIncrement([in,out] VARIANT BOOL *boolTest,
 [in,out] double *doubleTest,
 [in,out] float *floatTest,
 [in,out] long *longTest,
 [in,out] short *shortTest,
 [in,out] BSTR *stringTest,
 [in,out] DATE * dateTest,
 [in,out] CURRENCY * currencyTest,
 [retval,out] short *val);
HRESULT boolReturn([retval,out] VARIANT BOOL *val);
HRESULT doubleReturn([retval,out] double *val);
HRESULT floatReturn([retval,out] float *val);
HRESULT longReturn([retval,out] long *val);
HRESULT shortReturn([retval,out] short *val);
HRESULT stringReturn([retval,out] BSTR *val);
HRESULT octetReturn([retval,out] DATE *val);
HRESULT currencyReturn([retval,out] CURRENCY *val);
}

```

The corresponding OMG IDL is as follows.

```

// OMG IDL
interface MyModule_TypesTest
{
 attribute boolean boolTest;
 attribute double doubleTest;
 attribute float floatTest;
 attribute long longTest;
 attribute short shortTest;
 attribute string stringTest;
 attribute double dateTest;
 attribute COM::Currency currencyTest;

 readonly attribute short readonlyShortTest;

 // Sets all the attributes
 boolean setAll (in boolean boolTest,
 in double doubleTest,
 in float floatTest,
 in long longTest,
 in short shortTest,
 in string stringTest,
 in double dateTest,
 in COM::Currency currencyTest);

 // Gets all the attributes
 boolean getAll (out boolean boolTest,
 out double doubleTest,
 out float floatTest,
 out long longTest,

```

```

 out short shortTest,
 out string stringTest,
 out double dateTest,
 out COM::Currency currencyTest);

 boolean setAndIncrement (
 inout boolean boolTest,
 inout double doubleTest,
 inout float floatTest,
 inout long longTest,
 inout short shortTest,
 inout string stringTest,
 inout double dateTest,
 inout COM::Currency currencyTest);

 boolean boolReturn ();
 double doubleReturn();
 float floatReturn();
 long longReturn ();
 short shortReturn ();
 string stringReturn();
 double dateReturn ();
 COM::Currency currencyReturn();

}; // End of Interface TypesTest

```

### 19.9.11 Mapping for Object References

The mapping of an object reference as a parameter or return value can be fully expressed by the following OMG IDL and ODL code. The ODL code defines an interface “Simple” and another interface that references Simple as an “in” parameter, an “out” parameter, an “inout” parameter, and as a return value. The OMG IDL code describes the CORBA View Interface that results from a proper mapping.

```

// ODL
[odl, dual, uuid(...)]
interface DIMyModule_Simple: IDispatch
{
 [propget] HRESULT shortTest([retval, out]
 short * val);
 [propput] HRESULT shortTest([in] short sshortTest);
}

[odl, dual, uuid(...)]
interface DIMyModule_ObjRefTest: IDispatch
{
 [propget] HRESULT simpleTest([retval, out]
 DIMyModule_Simple ** val);
 [propput] HRESULT simpleTest([in] DIMyModule_Simple
 *pSimpleTest);
}

```



```

 HRESULT simpleOp([in] DIMyModule_Simple *inTest,
 [out] DIMyModule_Simple **outTest,
 [in,out]DIMyModule_Simple **inoutTest,
 [retval, out] DIMyModule_Simple **val);
 }

```

The OMG IDL code for the CORBA View Dispatch Interface is as follows.

```

// OMG IDL
// A simple object we can use for testing object references
interface MyModule_Simple
{
 attribute short shortTest;
};

interface MyModule_ObjRefTest
{
 attribute MyModule_Simple simpleTest;
 MyModule_Simple simpleOp(in MyModule_Simple inTest,
 out MyModule_Simple outTest,
 inout MyModule_Simple inoutTest);
};

```

### 19.9.12 Mapping for Enumerated Types

ODL enumerated types are mapped to OMG IDL enums; for example:

```

// ODL
typedef enum MyModule_color {red, green, blue};

[odl,dual,uuid(...)]
interface DIMyModule_foo: IDispatch {
 HRESULT op1([in] MyModule_color col);
}

// OMG IDL
 enum MyModule_color {red, green, blue};
 interface foo: COM::CORBA_View {
 long op1(in MyModule_color col);
 };
};

```

---

**Note** – An ODL enumeration is mapped to OMG IDL such that the enumerators in the enumeration are ordered according to the ascending order of the value of the enumerators. Because OMG IDL does not support explicitly tagged enumerators, the CORBA view of an automation/dual object must maintain the mapping of the values of the enumeration.

---

### 19.9.13 Mapping for SafeArrays

Automation SafeArrays should be mapped to CORBA unbounded sequences.

A method of the CORBA View Interface, which has a SafeArray as a parameter, will have the knowledge to handle the parameter properly.

When SafeArrays are “in” parameters, the View method uses the Safearray API to dynamically repackage the SafeArray as a CORBA sequence. When arrays are “out” parameters, the View method uses the Safearray API to dynamically repackage the CORBA sequence as a SafeArray.

#### 19.9.13.1 Multidimensional SafeArrays

SafeArrays are allowed to have more than one dimension. However, the bounding information for each dimension, and indeed the number of dimensions, is not available in the static typelibrary information or ODL definition. It is only available at run-time.

For this reason, SafeArrays, which have more than one dimension, are mapped to an identical linear format and then to a sequence in the normal way.

This linearization of the multidimensional SafeArray should be carried out as follows:

- The number of elements in the linear sequence is the product of the dimensions.
- The position of each element is deterministic; for a SafeArray with dimensions  $d_0$ ,  $d_1$ ,  $d_2$ , the location of an element  $[p_0][p_1][p_2]$  is defined as:

$$\text{pos}[p_0][p_1][p_2] = p_0 * d_1 * d_2 + p_1 * d_2 + p_2$$

Consider the following example: SafeArray with dimensions 5, 8, 9.

This maps to a linear sequence with a run-time bound of  $5 * 8 * 9 = 360$ . This gives us valid offsets 0-359. In this example, the real offset to the element at location  $[4][5][1]$  is  $4 * 8 * 9 + 5 * 9 + 1 = 334$ .

### 19.9.14 Mapping for Typedefs

ODL typedefs map directly to OMG IDL typedefs. The only exception to this is the case of an ODL enum, which is required to be a typedef. In this case the mapping is done according to Section 19.6, “Mapping for Enumerated Types,” on page 19-17.

### 19.9.15 Mapping for VARIANTs

The VARIANT data type maps to a CORBA “any.” If the VARIANT contains a DATE or CURRENCY element, these are mapped as per Section 19.9.7, “Mapping for Automation Basic Data Types,” on page 19-42.

### 19.9.16 Mapping Automation Exceptions to CORBA

There are several ways in which an HRESULT (or SCODE) can be obtained by an Automation client such as the CORBA View. These ways differ based on the signature of the method and the behavior of the server. For example, for vtable invocations on dual interfaces, the HRESULT is the return value of the method. For **IDispatch::Invoke** invocations, the significant HRESULT may be the return value from Invoke, or may be in the EXCEPINFO parameter's SCODE field.

Regardless of how the HRESULT is obtained by the CORBA View, the mapping of the HRESULT is exactly the same as for COM to CORBA (see Section 18.3.10.2, "Mapping for COM Errors," on page 18-44). The View raises either a standard CORBA system exception or the **COM\_HRESULT** user exception.

CORBA Views must supply an EXCEPINFO parameter when making **IDispatch::Invoke** invocations to take advantage of servers using EXCEPINFO. Servers do not use the EXCEPINFO parameter if it is passed to Invoke as NULL.

An Automation method with an HRESULT return value and an argument marked as a **[retval]** maps to an IDL method whose return value is mapped from the **[retval]** argument. This situation is common in dual interfaces and means that there is no HRESULT available to the CORBA client. It would seem that there is a problem mapping S\_FALSE scodes in this case because the fact that no system exception was generated means that the HRESULT on the vtable method could have been either S\_OK or S\_FALSE. However, this should not be a problem. A method in a dual interface should never attach semantic meaning to the distinction between S\_OK and S\_FALSE because a Visual Basic program acting as a client would never be able to determine whether the return value from the actual method was S\_OK or S\_FALSE.

An Automation method with an HRESULT return value and no argument marked as **[retval]** maps to a CORBA interface with a long return value. The long HRESULT returned by the original Automation operation is passed back as the long return value from the CORBA operation.

## 19.10 Older Automation Controllers

This section provides some solutions that vendors might implement to support existing and older Automation controllers. These solutions are suggestions; they are strictly optional.

### 19.10.1 Mapping for OMG IDL Arrays and Sequences to Collections

Some Automation controllers do not support the use of SAFEARRAYs. For this reason, arrays and sequences can also be mapped to OLE collection objects.

A collection object allows generic iteration over its elements. While there is no explicit ICollection type interface, OLE does specify guidelines on the properties and methods a collection interface should export.

```
// ODL
[odl, dual, uuid(...)]
interface DICollection: IDispatch {
 [propget] HRESULT Count([retval,out] long * count);
 [propget, id(DISPID_VALUE)] HRESULT Item([in] long index,
 [retval,out] VARIANT * val);
 [propput, id(DISPID_VALUE)] HRESULT Item([in] long index,
 [in] VARIANT val);
 [propget, id(NEW_ENUM)] HRESULT _NewEnum(
 [retval, out] IEnumVARIANT * newEnum);
}
```

The UUID for **DICollection** is:

```
{A8B553C9-3B72-11cf-BBFC-444553540000}
```

This interface can also be implemented as generic (nondual) Automation Interface, in which case it is named **DCollection** and its UUID is:

```
{E977F909-3B75-11cf-BBFC-444553540000}
```

In controller scripting languages such as VBA in MS-Excel, the FOR...EACH language construct can automatically iterate over a collection object such as that previously described.

```
` Visual Basic:
Dim doc as Object
For Each doc in DocumentCollection
doc.Visible = False
Next doc
```

The specification of DISPID\_VALUE as the id() for the Item property means that access code like the following is possible.

```
` Visual Basic:
Dim docs as Object
Set docs = SomeCollection

docs(4).Visible = False
```

Multidimensional arrays can be mapped to collections of collections with access code similar to the following.

```
` Visual Basic
Set docs = SomeCollection

docs.Item(4).Item(5).Visible = False
```

If the Collection mapping for OMG IDL Arrays and Sequences is chosen, then the signatures for operations accepting SAFEARRAYs should be modified to accept a VARIANT instead. In addition, the implementation code for the View wrapper method should detect the kind of object being passed.

## 19.11 Example Mappings

### 19.11.1 Mapping the OMG Naming Service to Automation

This section provides an example of how a standard OMG Object Service, the Naming Service, would be mapped according to the Interworking specification.

The Naming Service provides a standard service for CORBA applications to obtain object references. The reference for the Naming Service is found by using the **resolve\_initial\_references** method provided on the ORB pseudo-interface:

```
CORBA::ORB_ptr theORB = CORBA::ORB_init(argc, argv, CORBA::ORBid, ev)
CORBA::Object_var obj =
 theORB->resolve_initial_references("NameService", ev);
CosNaming::NamingContext_var initial_nc_ref =
CosNaming::NamingContext::_narrow(obj, ev);
CosNaming::Name factory_name;
factory_name.length(1);
factory_name[0].id = "myFactory";
factory_name[0].kind = "";
CORBA::Object_var objref = initial_nc_ref->resolve(factory_name, ev);
```

The Naming Service interface can be directly mapped to an equivalent Automation interface using the mapping rules contained in the rest of this section. A direct mapping would result in code from VisualBasic that appears as follows.

```
Dim CORBA as Object
Dim ORB as Object
Dim NamingContext as Object
Dim NameSequence as Object
Dim Target as Object

Set CORBA=GetObject("CORBA.ORB")
Set ORB=CORBA.init("default")
Set NamingContext = ORB.resolve_initial_reference("NamingService")
Set NameSequence=NamingContext.create_type("Name")
ReDim NameSequence as Object(1)
NameSequence[0].name = "myFactory"
NameSequence[0].kind = ""
Set Target=NamingContext.resolve(NameSequence)
```

### 19.11.2 Mapping a COM Service to OMG IDL

This section provides an example of mapping a Microsoft IDL-described set of interfaces to an equivalent set of OMG IDL-described interfaces. The interface is mapped according to the rules provided in Section 18.3, "COM to CORBA Data Type Mapping," on page 18-33. The example chosen is the COM ConnectionPoint set of interfaces. The ConnectionPoint service is commonly used for supporting event notification in OLE custom controls (OCXs). The service is a more general version of the **IDataObject/IAdviseSink** interfaces.

The ConnectionPoint service is defined by four interfaces, described in Table 19-9.

Table 19-9 Interfaces of the ConnectionPoint Service

|                           |                                                                                               |
|---------------------------|-----------------------------------------------------------------------------------------------|
| IConnectionPointContainer | Used by a client to acquire a reference to one or more of an object's notification interfaces |
| IConnectionPoint          | Used to establish and maintain notification connections                                       |
| IEnumConnectionPoints     | An iterator over a set of IConnectionPoint references                                         |
| IEnumConnections          | Used to iterate over the connections currently associated with a ConnectionPoint              |

For purposes of this example, we describe these interfaces in Microsoft IDL. The **IConnectionPointContainer** interface is shown next.

```
// Microsoft IDL
interface IConnectionPoint;
interface IEnumConnectionPoints;
typedef struct {
 unsigned long Data1;
 unsigned short Data2;
 unsigned short Data3;
 unsigned char Data4[8];
} REFIID;
[object, uuid(B196B284-BAB4-101A-B69C-00AA00241D07),
 pointer_default(unique)]
interface IConnectionPointContainer: IUnknown
{
 HRESULT EnumConnectionPoints ([out] IEnumConnectionPoints
 **pEnum);
 HRESULT FindConnectionPoint([in] REFIID iid, [out]
 IConnectionPoint **cp);
};
MIDL definition for IConnectionPointContainer
```

This **IConnectionPointContainer** interface would correspond to the OMG IDL interface shown next.

```
// OMG IDL
interface IConnectionPoint;
interface IEnumConnectionPoints;
struct REFIID {
 unsigned long Data1;
 unsigned short Data2;
 unsigned short Data3;
 unsigned char Data4[8];
};
interface IConnectionPointContainer: CORBA::Composite,
```

```

CosLifeCycle::LifeCycleObject
{
 HRESULT EnumConnectionPoints (out IEnumConnectionPoints
 pEnum) raises (COM_HRESULT);
 HRESULT FindConnectionPoint(in REFIID iid, out
 IConnectionPoint cp) raises (COM_HRESULT);
 #pragma ID IConnectionPointContainer = "DCE:B196B284-BAB4-
 101A-B69C-00AA00241D07";
};

```

Similarly, the forward-declared ConnectionPoint interface shown next is remapped to the OMG IDL definition shown in the second following example.

```

// Microsoft IDL
interface IEnumConnections;
[object, uuid(B196B286-BAB4-101A-B69C-00AA00241D07),
 pointer_default(unique)]
interface IConnectionPoint: IUnknown
{
 HRESULT GetConnectionInterface([out] IID *pIID);
 HRESULT GetConnectionPointContainer([out]
 IConnectionPointContainer **ppCPC);
 HRESULT Advise([in] IUnknown *pUnkSink, [out] DWORD
 *pdwCookie);
 HRESULT Unadvise(in DWORD dwCookie);
 HRESULT EnumConnections([out] IEnumConnections
 **ppEnum);
};

// OMG IDL
interface IEnumConnections;
interface IConnectionPoint:: CORBA::Composite,
 CosLifeCycle::LifeCycleObject
{
 HRESULT GetConnectionInterface(out IID pIID)
 raises (COM_HRESULT);
 HRESULT GetConnectionPointContainer
 (out IConnectionPointContainer pCPC)
 raises (COM_HRESULT);
 HRESULT Advise(in IUnknown pUnkSink, out DWORD pdwCookie)
 raises (COM_HRESULT);
 HRESULT Unadvise(in DWORD dwCookie)
 raises (COM_HRESULT);

 HRESULT EnumConnections(out IEnumConnections ppEnum)
 raises (COM_HRESULT);
 #pragma ID IConnectionPoint = "DCE:B196B286-BAB4-101A-B69C-00AA00241D07";
};

```

Finally, the MIDL definition for **IEnumConnectionPoints** and **IEnumConnections** interfaces are shown next.

```

typedef struct tagCONNECTDATA {
 IUnknown * pUnk;
 DWORD dwCookie;
} CONNECTDATA;

[object, uuid(B196B285-BAB4-101A-B69C-00AA00241D07),
 pointer_default(unique)]
interface IEnumConnectionPoints: IUnknown
{
 HRESULT Next([in] unsigned long cConnections,
 [out] IConnectionPoint **rcpcn,
 [out] unsigned long *lpcFetched);
 HRESULT Skip([in] unsigned long cConnections);
 HRESULT Reset();
 HRESULT Clone([out] IEnumConnectionPoints **pEnumval);
};

[object, uuid(B196B287-BAB4-101A-B69C-00AA00241D07),
 pointer_default(unique)]
interface IEnumConnections: IUnknown
{
 HRESULT Next([in] unsigned long cConnections,
 [out] IConnectionData **rcpcn,
 [out] unsigned long *lpcFetched);
 HRESULT Skip([in] unsigned long cConnections);
 HRESULT Reset();
 HRESULT Clone([out] IEnumConnections **pEnumval);
};

```

The corresponding OMG IDL definition for **EnumConnectionPoints** and **EnumConnections** is shown next:

```

struct CONNECTDATA {
 IUnknown * pUnk; DWORD dwCookie;
};
interface IEnumConnectionPoints: CORBA::Composite,
CosLifeCycle::LifeCycleObject
{
 HRESULT Next(in unsigned long cConnections,
 out IConnectionPoint rcpcn,
 out unsigned long lpcFetched) raises (COM_HRESULT);
 HRESULT Skip(in unsigned long cConnections) raises
(COM_HRESULT);
 HRESULT Reset() raises (COM_HRESULT);
 HRESULT Clone(out IEnumConnectionPoints pEnumval)
 raises(COM_HRESULT)
#pragma ID IEnumConnectionPoints =
 "DCE:B196B285-BAB4-101A-B69C-00AA00241D07";
};

interface IEnumConnections: CORBA::Composite,
CosLifeCycle::LifeCycleObject
{

```



```

HRESULT Next(in unsigned long cConnections,
 out IConnectData rgcd,
 out unsigned long lpcFetched) raises (COM_HRESULT);
HRESULT Skip(in unsigned long cConnections) raises
 (COM_HRESULT);
HRESULT Reset() raises (COM_HRESULT);
HRESULT Clone(out IEnumConnectionPoints pEnumVal) raises
 (COM_HRESULT);
#pragma ID IEnumConnections =
 "DCE:B196B287-BAB4-101A-B69C-00AA00241D07";
};

```

### 19.11.3 Mapping an OMG Object Service to Automation

This section provides an example of mapping an OMG-defined interface to an equivalent Automation interface. This example is based on the OMG Naming Service and follows the mapping rules from the *Mapping: Automation and CORBA* chapter. The Naming Service is defined by two interfaces and some associated types, which are scoped in the *OMG IDL CosNaming* module.

Table 19-10 Interfaces of the OMG Naming Service

| Interface                  | Description                                                                                                                                                                                                |
|----------------------------|------------------------------------------------------------------------------------------------------------------------------------------------------------------------------------------------------------|
| CosNaming::NamingContext   | Used by a client to establish the name space in which new associations between names and object references can be created, and to retrieve an object reference that has been associated with a given name. |
| CosNaming::BindingIterator | Used by a client to establish a list of registered names that exist within a naming context.                                                                                                               |

Microsoft ODL does not explicitly support the notions of modules or scoping domains. To avoid name conflicts, all types defined in the scoping space of *CosNaming* are expanded to global names.

The data type portion (interfaces excluded) of the **CosNaming** interface is shown next.

```

// OMG IDL
module CosNaming{
 typedef string lstring;
 struct NameComponent {
 lstring id;
 lstring kind;
 };
 typedef sequence <NameComponent> Name;
 enum BindingType { nobject, ncontext };
 struct Binding {
 Name binding_name;
 BindingType binding_type;
 };
};

```

```

};
typedef sequence <Binding> BindingList;
interface BindingIterator;
interface NamingContext;
// ...
}

```

The corresponding portion (interfaces excluded) of the Microsoft ODL interface is shown next.

```

[uuid(a1789c86-1b2c-11cf-9884-08000970dac7)] // from COMID associa-
tion
library CosNaming
{
 importlib("stdole32.tlb");
 importlib("corba.tlb"); / for standard CORBA types
 typedef CORBA_string CosNaming_IString;
 [uuid((04b8a791-338c-afcf-1dec-cf2733995279), help-
string("struct NameComponent"),
 oleautomation, dual]
 interface CosNaming_NameComponent: ICORBAstruct {
 [propget] HRESULT id([out, retval]CosNaming_IString **val);
 [propput] HRESULT id([in]CosNaming_IString* val);
 [propget] HRESULT kind([out, retval]CosNaming_IString
** val);
 [propget] HRESULT kind([in]CosNaming_IString *val);
 };
define Name SAFEARRAY(CosNaming_NameComponent *)
// typedef doesn't work
typedef enum { [helpstring("nobject")]nobject,
 [helpstring("ncontext")]ncontext
} CosNaming_BindingType;
#define CosNaming_BindingList SAFEARRAY(CosNaming_Binding *)
[uuid(58fbc618-2d20-d19f-1dc2-560cc6195add),
 helpstring("struct Binding"),
 oleautomation, dual]
interface DICosNaming_Binding: ICORBAstruct {
 [propget] HRESULT binding_name([retval, out]
 CosNaming_IString ** val);
 [propput] HRESULT binding_name([in]
 CosNaming_IString * vall);
 [propget] HRESULT binding_type([retval, out]
 CosNaming_BindingType *val);
 [propset] HRESULT binding_type([in]
 CosNaming_BindingType val);
};
define CosNaming_BindingList SAFEAR-
RAY(CosNaming_Binding)
interface DICosNaming_BindingIterator;
interface DICosNaming_NamingContext;
// ...
};

```

The types scoped in an OMG IDL interface are also expanded using the notation [`<modulename>_*`][`<interfacename>_*`]`typename`. Thus the types defined within the **CosNaming::NamingContext** interface (shown next) are expanded in Microsoft ODL as shown in the second following example.

```

module CosNaming{
 // ...
 interface NamingContext
 {
 enum NotFoundReason { missing_node, not_context,
 not_object };
 exception NotFound {
 NotFoundReason why;
 Name rest_of_name;
 };
 exception CannotProceed {
 NamingContext cxt;
 Name rest_of_name;
 };
 exception InvalidName {};
 exception AlreadyBound {};
 exception NotEmpty {};
 void bind(in Name n, in Object obj)
 raises(NotFound, CannotProceed, InvalidName,
 AlreadyBound);
 void rebind(in Name n, in Object obj)
 raises(NotFound, CannotProceed, InvalidName);
 void bind_context(in Name n, in NamingContext nc)
 raises(NotFound, CannotProceed, InvalidName,
 AlreadyBound);
 void rebind_context(in Name n, in NamingContext nc)
 raises(NotFound, CannotProceed, InvalidName);
 Object resolve(in Name n)
 raises(NotFound, CannotProceed, InvalidName);
 void unbind(in Name n)
 raises(NotFound, CannotProceed, InvalidName);
 NamingContext new_context();
 NamingContext bind_new_context(in Name n)
 raises(NotFound, AlreadyBound, CannotProceed, InvalidName
);
 void destroy()
 raises(NotEmpty);
 void list(in unsigned long how_many,
 out BindingList bl, out BindingIterator bi);
 };
 // ...
};

[uuid(d5991293-3e9f-0e16-1d72-7858c85798d1)]
library CosNaming

```

```

{ // ...
interface DICosNaming_NamingContext;
[uuid(311089b4-8f88-30f6-1dfb-9ae72ca5b337),
 helpstring("exception NotFound"),
 oleautomation, dual]
interface DICosNaming_NamingContext_NotFound:
ICORBAException {
[proppget] HRESULT why([out, retval] long* _val);
[propput] HRESULT why([in] long _val);
[proppget] HRESULT rest_of_name([out, retval] CosNaming_Name ** _val);
[propput] HRESULT rest_of_name([in] CosNaming_Name * _val);
};
[uuid(d2fc8748-3650-ceed-1df6-026237b92940),
 helpstring("exception CannotProceed"),
 oleautomation, dual]
interface DICosNaming_NamingContext_CannotProceed:
DICORBAException{
[proppget] HRESULT cxt([out, retval] DICosNaming_NamingContext ** _val);
[propput] HRESULT cxt([in] DICosNaming_NamingContext * _val);
[proppget] HRESULT rest_of_name([out, retval] CosNaming_Name ** _val);
[propput] HRESULT rest_of_name([in] CosNaming_Name * _val);
};
[uuid(7edaca7a-c123-42a1-1dca-a7e317aafe69),
 helpstring("exception InvalidName"),
 oleautomation, dual]
interface DICosNaming_NamingContext_InvalidName:
DICORBAException {};
[uuid(fee85a90-1f6b-c47a-1dd0-f1a2fc1ab67f),
 helpstring("exception AlreadyBound"),
 oleautomation, dual]
interface DICosNaming_NamingContext_AlreadyBound:
DICORBAException {};
[uuid(8129b3e1-16cf-86fc-1de4-b3080e6184c3),
 helpstring("exception NotEmpty"),
 oleautomation, dual]
interface CosNaming_NamingContext_NotEmpty:
DICORBAException {};
typedef enum {[helpstring("missing_node")]
NamingContext_missing_node,
 [helpstring("not_context") NamingContext_not_context,
 [helpstring("not_object") NamingContext_not_object
} CosNaming_NamingContext_NotFoundReason;
[uuid(4bc122ed-f9a8-60d4-1dfb-0ff1dc65b39a),
 helpstring("NamingContext"),
 oleautomation, dual]
interface DICosNaming_NamingContext {
HRESULT bind([in] CosNaming_Name * n, [in] IDispatch * obj,
 [out, optional] VARIANT * _user_exception);
HRESULT rebind([in] CosNaming_Name * n, in] IDispatch * obj,
 [out, optional] VARIANT * _user_exception);
HRESULT bind_context([in] CosNaming_Name * n,

```

```

 [in] DICosNaming_NamingContext * nc,
 [out, optional] VARIANT * _user_exception);
HRESULT rebind_context([in] CosNaming_Name * n,
 [in] DICosNaming_NamingContext * nc,
 [out, optional] VARIANT * _user_exception);
HRESULT resolve([in] CosNaming_Name * n,
 [out, retval] IDispatch** pResult,
 [out, optional] VARIANT * _user_exception)
HRESULT unbind([in] CosNaming_Name * n,
 [out, optional] VARIANT * _user_exception);
HRESULT new_context([out, retval] DICosNaming_NamingContext ** pResult);
HRESULT bind_new_context([in] CosNaming_Name * n,
 [out, retval] DICosNaming_NamingContext ** pResult,
 [out, optional] VARIANT * _user_exception);
HRESULT destroy([out, optional] VARIANT* _user_exception);
HRESULT list([in] unsigned long how_many, [out]
 CosNaming_BindingList ** bl,
 [out] DICosNaming_BindingIterator ** bi);
};
};
};

```

The **BindingIterator** interface is mapped in a similar manner, as shown in the next two examples.

```

module CosNaming {
 //...
 interface BindingIterator {
 boolean next_one(out Binding b);
 boolean next_n(in unsigned long how_many,
 out BindingList bl);
 void destroy();
 };
};

[uuid(a1789c86-1b2c-11cf-9884-08000970dac7)]
library CosNaming
{ // ...
 [uuid(5fb41e3b-652b-0b24-1dcc-a05c95edf9d3),
 help string("BindingIterator"),
 helpcontext(1), oleautomation, dual]
 interface DICosNaming_IBindingIterator: IDispatch {
 HRESULT next_one([out] DICosNaming_Binding ** b,
 [out, retval] boolean* pResult);
 HRESULT next_n([in] unsigned long how_many,
 [out] CosNaming_BindingList ** bl,
 [out, retval] boolean* pResult);
 HRESULT destroy();
 };
}
}

```



# *Interoperability with non-CORBA Systems*

## *Contents*

This chapter contains the following sections.

| <b>Section Title</b>             | <b>Page</b> |
|----------------------------------|-------------|
| “Introduction”                   | 20-1        |
| “Conformance Issues”             | 20-2        |
| “Locality of the Bridge”         | 20-4        |
| “Extent Definition”              | 20-5        |
| “Request/Reply Extent Semantics” | 20-8        |
| “Consistency”                    | 20-9        |
| “DCOM Value Objects”             | 20-11       |
| “Chain Avoidance”                | 20-16       |
| “Chain Bypass”                   | 20-19       |
| “Thread Identification”          | 20-21       |

## *20.1 Introduction*

The primary goal of this specification is to allow effective access to CORBA servers through DCOM and the reverse. To reduce the total cost of ownership of CORBA applications that are built with COM or Automation clients for CORBA servers, COM or Automation clients on machines with no ORB or interworking mechanism should be able to act as clients to CORBA servers through DCOM. In addition, a CORBA client could, through a CORBA view, access a DCOM server that is not co-located with the

view with no additional interworking support on the DCOM server's machine. These scenarios help to reduce installation and maintenance costs through the lifetime of applications, which span multiple object systems.

---

**Note** – This specification refers to COM/CORBA Part A and COM/CORBA Part B. The Interworking Architecture, Mapping: COM and CORBA, and Mapping Automation and CORBA chapters comprise the COM/CORBA Part A and this specification comprises the COM/CORBA Part B.

---

Converting a COM or Automation client to contact a server through DCOM is relatively easy and requires no application changes to the server. Thus, applications that use existing Part A compliant solutions could, today, have remote DCOM clients access the COM or Automation views of the CORBA servers and CORBA clients could access (through a view) DCOM or DCOM Automation servers. However, allowing CORBA access to CORBA views that are not co-located with the COM or Automation servers or allowing DCOM access to remote views of CORBA servers introduces a number of issues in terms of performance and scalability that will be discussed below.

### *20.1.1 COM/CORBA Part A*

The COM/CORBA Part A specifications (see the Interworking Architecture chapter, Mapping: COM and CORBA chapter, and Mapping Automation and CORBA chapter) address most of the requirements of this Part B specification. The basic architecture and approach is sound. And, in general DCOM requires few changes to existing COM programs. With appropriate changes in the COM Registry, legacy COM client and server applications can operate unchanged in a DCOM environment. However, due to limitations of DCOM and DCOM Automation, a number of performance and scalability issues arise when interworking with CORBA using only the COM/CORBA Part A specification. The primary purpose of this specification is to address these issues; in particular this specification focuses on addressing the issues related to using native DCOM and DCOM Automation clients with CORBA servers. Note that readers are expected to be familiar with the terminology used in the other COM/CORBA specifications.

## *20.2 Conformance Issues*

This specification, as a whole, is optional and is not required for COM/CORBA interworking compliance.

Solutions that choose to implement this specification must, in order to be conformant, implement the DCOM extent and all defined interfaces. There are no optional compliance points. Solutions that conform to this specification may label themselves as supporting “Advanced DCOM Interworking.”



### 20.2.1 Performance Issues

When accessing DCOM views of CORBA servers through DCOM (i.e., the DCOM client and DCOM view are not co-located), major performance issues arise for two primary reasons:

1. Pseudo objects are specific to CORBA and are thus not available in DCOM.
2. Automation does not support complex types such as structs and unions.

The COM/CORBA Part A specification maps CORBA pseudo objects into regular COM and Automation objects since there is no equivalent to pseudo objects in COM or Automation. In the Automation mapping, structs and unions are also mapped to objects since there is no Automation equivalent construct (essentially structs and unions are also handled as pseudo objects). When these pseudo objects are passed to a remote DCOM client that uses standard DCOM marshaling, all access to all members require a remote call. For example, a DCOM Automation client accessing the members of a structure would make one remote call for each get or set of a structure member. This, of course, introduces a significant performance bottleneck.

### 20.2.2 Scalability Issues

A scalability issue known as *proxy explosion* arises when passing object references among clients and servers across object systems. For example, an object reference is received from a CORBA server and is encapsulated in a DCOM view. This view is passed to a different DCOM server. This server then attempts to pass the object to a CORBA server. Without prior knowledge that the object was originally a CORBA object, a CORBA view would be built for what appeared to be a DCOM object (but which was really a view). This means that when the CORBA server attempts to call an operation on this object, it passes through a chain of views until the request is delivered to the real implementation instead of the call being direct CORBA to CORBA. In order to resolve the proxy explosion view chain problem, an efficient mechanism must be provided for interworking solutions to determine whether any object is a view or a native object and, if the object is a view, what is the original object behind the view. The problem or proxy explosion is not specific to COM/CORBA interworking. Instead, it can occur between CORBA and any other system where bidirectional interworking is supported.

The COM/CORBA Part A specification defines a mechanism to help avoid proxy chains using **IForeignObject::GetForeignReference**. However, calling this operation remotely on each object reference to avoid proxy chains would have introduced a significant performance problem.

### 20.2.3 CORBA Clients for DCOM Servers

In cases where CORBA clients need to access DCOM servers, the performance issues that occur in the other direction are not applicable since native DCOM servers do not have pseudo objects (since there is no such concept in COM or Automation) and since native Automation servers do not use structures or unions (since these constructs do not exist). However, the scalability issue remains.

### 20.3 Locality of the Bridge

The COM/CORBA Part A specification states that the interworking be performed local to the COM or Automation client or server since, at the time, COM objects could only communicate within the same machine. Thus, the possibility for the location of the view was limited to those in Figure 20-1.

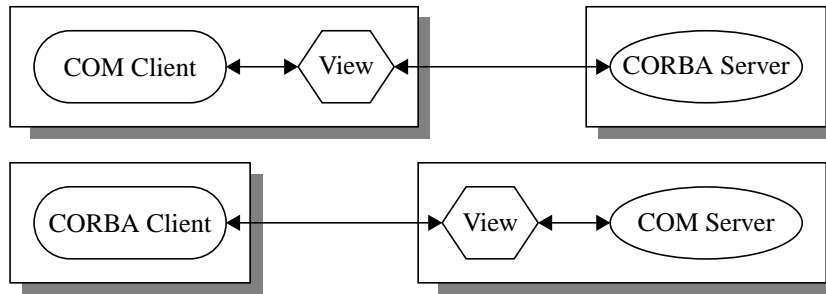

Figure 20-1 COM/CORBA Part A Configurations

The addition of support for DCOM removes the requirement that the interworking occur in the COM environment. The use of DCOM adds four possibilities for the location of the view (see Figure 20-2 on page 20-5). Note that the communications between the view and the CORBA server or client is still performed as per existing OMG specifications.

The performance issues described above relate, in particular, to the first and third configuration shown in Figure 20-2. The scalability issues can affect any of these configurations provided that objects are being passed through multiple different bridges or through an intermediate object system.

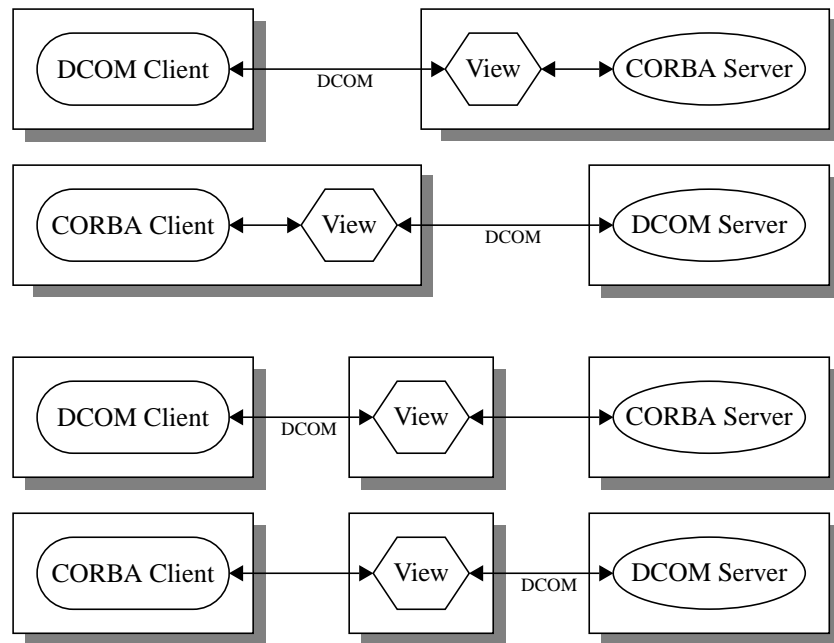

Figure 20-2 COM/CORBA Part B Additional Configurations

## 20.4 Extent Definition

The ideal solution to the performance issues would be to have DCOM able to pass CORBA pseudo objects with similar semantics to CORBA, and to have Automation support structs and unions natively. However, this is not likely to occur and cannot be implemented adequately using DCOM standard marshaling. In addition, since Part B is not required to be implemented, COM/CORBA Part A compliant solutions must still interoperate with solutions that also support the COM/CORBA Part B extensions. Thus, another mechanism needs to be defined in order to avoid the performance and scalability problems while still maintaining compatibility.

To handle all of these cases using a standard mechanism, a category of DCOM objects called “DCOM value objects” was defined. DCOM value objects are DCOM objects that have little or no behavior other than accessors for their underlying data. Proxies for DCOM value objects act as local caches for the information in the original object. The Automation and COM views of CORBA pseudo objects, as well as the Automation views of CORBA structs and unions, are all DCOM value objects.

---

**Note** – CORBA objects-by-value will be able to be viewed in DCOM as DCOM value objects.

---

When DCOM value objects are passed across DCOM systems the data of the DCOM value object (called the “value data”) is also passed. Systems that support DCOM value objects can use the passed data to improve performance. However, when a

DCOM value object is passed to a system that does not support it as a value object, then the DCOM value object is accessed remotely just as any other DCOM object would be. There are two types of DCOM value objects to support these semantics:

- A “primary DCOM value object,” which is the real; that is, original instance of the value object, and
- “Local DCOM value objects,” which are the local proxies for the primary value object and caches for the values data of the primary value object.

Note that the local DCOM value objects are essentially DCOM proxies with some methods (the ones that access the value data) implemented locally.

To implement DCOM value objects while still providing compatibility with systems that do not support DCOM value objects, the value data needs to be passed as, essentially “out-of-band” data. DCOM allows out-of-band data to be passed with requests in DCOM extents. DCOM extents are a standard DCOM feature used to pass additional data with a request. On the receiving end, if a handler is not available for the extent, it is ignored. Extents are similar to CORBA service contexts except that they are not propagated through a chain of calls.

DCOM value objects are passed in a DCOM extent. Receivers that recognize the extent can take advantage of the data it provides. Receivers that do not recognize the extent safely ignore it. This occurs with no changes at all to the standard marshaling packet. This allows DCOM developers to use standard DCOM tools and services instead of entirely custom special purpose solutions.

### *20.4.1 Marshaling Constraints*

The layout of the marshaling packet is significant in matching marshaled data to a proxy on the receiving side. If the receiving side supports DCOM value objects for all passed value data, then the unmarshal process is simple: the first subset of value data goes to the first proxy (local DCOM value object) created by standard marshaling and so on. DCOM, however, allows for proxies in any given client process to be provided by different vendors. Thus, no assurance can be made that all DCOM value objects marshaled into the extent can have their value data unmarshaled on the receiving end. Thus, the value data in the extent is organized in a tree structure in order to be able to skip information that cannot be decoded.

### *20.4.2 Marshaling Key*

The interface ID corresponds to the interface used to encapsulate the unmarshaled data. It must provide accessors for all the members that are being marshaled, in the order that they are marshaled. This interface ID may be different than the interface ID actually marshaled in the call, since it reflects the content of an object rather than the interface through which it is used at the time of the call. For instance, a class encapsulating a structure may be marshaled as an **IUnknown**, which will be the class ID in the standard marshaling packet, but this is of no help in unmarshaling the structure. Thus, this identifier is used to describe the marshaled members.

If the object is standard marshaled, the unmarshal class ID field should be **CLSID\_NULL**. However, if an interface pointer is custom marshaled, its marshaling data does not contain a standard OBJREF, which could be used by the proxy to recover the marshaled data (since nothing can be presumed about the way that the proxy will be communicating with its server). In that case, the object's proxy will be different than the regular proxy for this interface, so the correct custom marshaler must be loaded if correct unmarshaling is to be achieved.

### 20.4.3 Extent Format

The marshaling format of the extent is best described using the following C++ structures. Note that the size of the extent is encoded in the extent header maintained by DCOM, so it does not have to be repeated here.

```

struct DVO_EXTENT // DCOM value object extent
{
 HRESULT statusCode; // Status of marshaling
 DVO_IFACE interfaces[]; // Marshaled interfaces
};

struct DVO_IFACE // value data container
 // for 1 interface
{
 unsigned long dataLen; // Total length of packet data
 IID remotedIID; // Remoted interface
 CLSID unmarshalCLSID; // Unmarshal class
 unsigned short cImpl; // Count of Implementations
 DVO_IMPLDATA implData[]; // Marshaled implementations
};

struct DVO_IMPLDATA // Marshaled implementation
{
 unsigned long dataLen; // Length of data
 IID iid; // Implementation interface
 DVO_BLOB data; // Value data
 DVO_IFACE interfaces[]; // Recursive DVO interface
};

struct DVO_BLOB // Opaque type containing
 // marshaled members
{
 unsigned long dataLen; // Length of value data
 byte data[]; // Value data
};

```

### 20.4.3.1 *DVO\_EXTENT*

This structure contains the entire DCOM value object information for a given DCOM call. The size and ID of the extent are specified in the `ORPC_EXTENT` (DCOM defined) structure. The **statusCode** is used to pass error information, which cannot be returned normally between the client and server extent. The interfaces array, **interfaces**, contains the value data for each DCOM value object for the DCOM call.

The DCOM value object extent will be identified with the following GUID:

```
{106454c0-14b2-11d1-8a22-006097cc044d}
```

### 20.4.3.2 *DVO\_IFACE*

This structure contains value data for a single DCOM value object. The **dataLen** member makes it easy to skip this structure; in doing so, one automatically skips any recursively marshaled interfaces. The **remotedIID** member identifies the most derived interface of the DCOM value object itself. The member **unmarshalCLSID** indicates the unmarshal class used in custom marshaling, if any.

The **cImpl** member indicates how many interface DCOM value object interfaces are marshaled. Normally, this member has a value of 1, but it may be necessary to send value data for more than one interface.

The **implData** array contains the blocks of marshaled value data.

### 20.4.3.3 *DVO\_IMPLDATA*

This structure contains the value data of a DCOM value object. The value data corresponds to the DCOM value object identified by the **iid** member of the **DVO\_IMPLDATA** structure. The value data is written to the **data** blob. If any marshaled data is itself a DCOM value object, its marshaling data will be added as an entry in the **interfaces** array.

### 20.4.3.4 *DVO\_BLOB*

This contains the actual value data for the DCOM value object. The data has been marshaled using standard DCOM (NDR) marshaling.

## 20.5 *Request/Reply Extent Semantics*

Clients, which support the extent, add the extent to outgoing requests that have DCOM value objects, which should have their value data transmitted. The **statusCode** member of the extent should be **NO\_ERROR**. Even when the outgoing request does not contain any DCOM value objects, the client must still add the extent (consisting of just the **statusCode** member in this case) if it supports the extent at all.

Servers, which support the extent, can retrieve the information from the extent during unmarshaling to get the value data for the local DCOM value objects (DCOM proxies). If the unmarshaling of the data within the extent fails with an error, this error is returned in a corresponding reply extent containing the error that occurred. If the unmarshaling is successful, the request is processed and an extent is added to the reply. Any out parameter or return DCOM value objects are included in the reply extent. The **statusCode** member should be **NO\_ERROR**. Even when the outgoing request does not contain any DCOM value objects, the callee must still add the extent (consisting of just the **statusCode** member in this case).

If the receiver of a DCOM value object passes a reference to the object to another client/server, the object reference of the primary DCOM value object should be marshaled in the request, not the object reference for the local DCOM value object.

## 20.6 Consistency

If the client supports the DCOM value object semantics for a given object reference, then an in-process copy of the value data is created using the data from the extent, and all read accesses are performed with no network calls.

When all clients and servers support the DCOM value object semantics, changes made to a local copy of the object can then be passed to other clients or servers. However, since the implementation of this specification is optional, it cannot be assumed that all clients and servers support this feature.

If the client of a DCOM value object does not support the extent, or the appropriate support for a given DCOM value object to be unmarshaled locally, then all reads or writes to members of the object are transmitted over the network to the server, which originally provided the object reference.

In cases where the receiver modifies the local copy of the object, these changes must be propagated back to the server to maintain consistency between systems that support the DCOM value object and those that do not.

The interfaces used to manage consistency were designed so that applications on homogenous networks (where every interworking solution supports Part B) can disable the synchronization used to maintain consistency. Applications running on heterogeneous networks can control the synchronization behavior to best suit the needs of the application.

In cases where the receiver modifies the local DCOM value object, these changes must be propagated back to the server to maintain consistency between systems that support DCOM value objects and those that do not. To maintain consistency, three additional DCOM interfaces are defined:

```
[
 object,
 pointer_default(unique),
 uuid(c9362b80-14bd-11d1-8a22-006097cc044d)
]
interface IValueObject : IUnknown
```

```

{
 HRESULT GetValue([out] unsigned long *length,
 [out, size_is(*length)] byte**data);

 HRESULT PutValue([in] unsigned long length,
 [in, size_is(length)] byte *data);
};

typedef enum tagSynchronizeMode
{
 kNeverSync,
 kSyncOnSend,
 kSyncOnChange
} SynchronizeMode;

[
 object,
 pointer_default(unique),
 uuid(c82fb800-14bd-11d1-8a22-006097cc044d)
]
interface ISynchronize : IUnknown
{
 HRESULT get_Mode([out, retval] SynchronizeMode *mode);
 HRESULT put_Mode([in] SynchronizeMode mode);
 HRESULT SyncNow();
 HRESULT ReCopy();
};

[
 odl,
 dual,
 oleautomation,
 uuid(c8c84e80-14bd-11d1-8a22-006097cc044d)
]
interface DISynchronize : IDispatch
{
 [propget] HRESULT Mode([out, retval] SynchronizeMode
*mode);
 [propput] HRESULT Mode([in] SynchronizeMode mode);
 HRESULT SyncNow();
 HRESULT ReCopy();
};

```

### 20.6.1 *IValueObject*

This interface is implemented on the primary DCOM value object. The purpose of this interface is to allow batch updates of the value data of the object. The data contained within the data array for the **GetValue** and **PutValue** methods is a **DVO\_IFACE** marshaled according to Section 20.4, “Extent Definition,” on page 20-5.



Local DCOM value objects that are not primary DCOM value objects are not required to support this interface.

## 20.6.2 *ISynchronize and DISynchronize*

These interfaces are implemented on local DCOM value objects (**ISynchronize** is found on COM proxies, **DISynchronize** is found on Automation proxies). If the interface is available, it means that this is a local DCOM value object, not a regular object or a primary DCOM value object.

### 20.6.2.1 *Mode Property*

The property **Mode** is used to control when synchronization is done. A value of **kNeverSync** means that the local and the primary value objects are never synchronized.

A value of **kSyncOnSend** means that, if the local value object has been changed, the primary value object will be synchronized with the local value object when the local value object is sent to another client/server, which cannot be reliably determined to support the required DCOM value object. Implementations can choose to synchronize using either batch synchronization through a call to **IValueObject**, or through calls for each changed member through the regular remote interface.

A value of **kSyncOnChange** means that, as a member is changed, the update of the member should be propagated to the primary value object as a regular remote call.

### 20.6.2.2 *SyncNow Method*

The **SyncNow** method can be called by application code to force the changes to the local value object to be propagated to the primary value object. Implementations can choose to synchronize using either batch synchronization through a call to **IValueObject**, or through calls for each changed member through the regular remote interface.

### 20.6.2.3 *ReCopy Method*

The **ReCopy** method can be called by application code to retrieve the current value of the primary value object and update the local value object.

## 20.7 *DCOM Value Objects*

### 20.7.1 *Passing Automation Compound Types as DCOM Value Objects*

Compound types such as structures and unions are encapsulated in Automation classes so they may be used by Automation applications. These are DCOM value objects. When a DCOM value object representing a compound type is passed to a remote

client, its interface pointer is marshaled using standard marshaling (as with any DCOM value object), and its value data is forwarded simultaneously using the extent described in Section 20.4, “Extent Definition,” on page 20-5.

### 20.7.2 *Passing CORBA-Defined Pseudo-Objects as DCOM Value Objects*

To handle the DCOM views of CORBA pseudo objects as DCOM value objects, the memory representation of these data types must be defined. The following sections detail the value data that will be passed in the extent.

### 20.7.3 *IForeignObject*

Supporting **IForeignObject**'s as a DCOM value object is required to avoid proxy explosion. The marshaled data for value objects of type **IForeignObject** is described in Section 20.8.2, “COM Chain Avoidance,” on page 20-17.

### 20.7.4 *DIForeignComplexType*

The value data for DCOM value objects of type **DIForeignComplexType** can be represented by the following structure (note that this also includes the state for **DIOBJECTINFO**):

```
struct FOREIGN_COMPLEX
{
 LPSTR name; // Name of type
 LPSTR scopedName; // Scoped name (if available)
 LPSTR repositoryId; // Repository ID of type
};
```

### 20.7.5 *DIForeignException*

The value data for DCOM value objects of type **DIForeignException** can be represented by the following structure:

```
struct FOREIGN_EXCEPTION
{
 FOREIGN_COMPLEX base;
 long majorCode;
};
```

### 20.7.6 *DISystemException*

The value data for DCOM value objects of type **DISystemException** can be represented by the following structure:

```
struct CORBA_SYSTEM_EXCEPTION
{
 FOREIGN_EXCEPTION base;
};
```

```

 long minorCode;
 long completionStatus;
 };

```

### 20.7.7 *DICORBAUserException*

The value data for **DICORBAUserException** is identical to that of **DIForeignException**. Value objects deriving from **DICORBAUserException** are passed as DCOM value objects according to the previously defined format. The value data of exception members must be preceded by the value data of **DIForeignException**.

### 20.7.8 *DICORBAStruct*

The value data for **DICORBAStruct** is identical to that of **DIForeignComplexType**. Value objects deriving from **DICORBAStruct** are passed as DCOM value objects according to the previously defined format. The value data of struct members must be preceded by the value data of **DIForeignComplexType**.

### 20.7.9 *DICORBAUnion*

The value data for **DICORBAUnion** is identical to that of **DIForeignComplexType**. Value objects deriving from **DICORBAUnion** are passed as DCOM value objects according to the previously defined format. The value data of a union must be preceded by the value data of **DIForeignComplexType**. The value data for the union itself is the discriminant followed by the selected member, if any.

### 20.7.10 *DICORBATypeCode and ICORBATypeCode*

The value data for type code DCOM value objects can be represented by the following struct:

```

struct CORBA_TYPECODE
{
 FOREIGN_COMPLEX base;
 TCKind kind; // TypeCode kind

 union TypeSpecific switch(kind)
 {
 case tk_objref:
 LPSTR id;
 LPSTR name;

 case tk_struct:
 case tk_except:
 LPSTR id;
 }
}

```

```

 LPSTR name;
 long member_count;
 [size_is(member_count,)] LPSTR *member_names;
 [size_is(member_count,)] IUnknown**member_types;

 case tk_union:
 LPSTR id;
 LPSTR name;
 long member_count;
 LPSTR member_names[];
 [size_is(member_count,)] IUnknown**member_types;
 [size_is(member_count)] VARIANT *member_labels;
 IUnknown *discriminator_type;
 long default_index;

 case tk_enum:
 long member_count;
 [size_is(member_count,)] LPSTR *member_names;
 [size_is(member_count,)] IUnknown**member_types;

 case tk_string:
 long length;

 case tk_array:
 case tk_sequence:
 long length;
 IUnknown *content_type;

 case tk_alias:
 LPSTR id;
 LPSTR name;
 long length;
 IUnknown *content_type;
 }
};

```

Note that members of type **IUnknown** will actually be **ICORBATypeCode** instances for COM and **DICORBATypeCode** instances for Automation.

### 20.7.11 DICORBAAny

The value data for DCOM value objects of type **DICORBAAny** can be represented by the following structure:

```

struct CORBA_ANY_AUTO
{
 FOREIGN_COMPLEXbase;
 VARIANT value;
 DICORBATypeCode*typeCode;
};

```

### 20.7.12 ICORBAAny

The value data for DCOM value objects of type **ICORBAAny** can be represented by a **CORBAAnyDataUnion** as defined in COM/CORBA Part A.

### 20.7.13 User Exceptions In COM

In COM, all CORBA user exceptions used in an interface are represented by another interface, which contains one method per user exception. The value data for one of these exception interfaces is an encapsulated DCOM union where each member of the union is one of the exception definition structures. The discriminant values are the indices of the corresponding structure retrieval method from the user exception interface.

```

module Bank
{
 ...
 exception InsufFunds { float balance; };
 exception InvalidAmount { float amount; };

 interface Account
 {
 exception NotAuthorized {};

 float Deposit(in float amount)
 raises(InvalidAmount);

 float Withdraw(in float amount)
 raises(InvalidAmount, NotAuthorized);
 };
};

```

Per the COM/CORBA Part A specification, the above IDL results in the following interface used for user exceptions:

```

struct Bank_InsufFunds { float balance; };
struct Bank_InvalidAmount { float amount; };
struct Bank_Account_NotAuthorized {};

interface IBank_AccountUserExceptions : IUnknown
{
 HRESULT get_InsufFunds([out] Bank_InsufFunds *);
 HRESULT get_InvalidAmount([out] Bank_InvalidAmount *);
 HRESULT get_NotAuthorized([out] Bank_Account_NotAuthorized *);
};

```

When this DCOM value object is passed, the value data is marshaled as the following data structure:

```

union Bank_AccountUserExceptionsData switch(unsigned short)
{
 case 0: Bank_InsufFunds m0;
 case 1: Bank_InvalidAmount m1;
 case 2: Bank_Account_NotAuthorized m2;
};

```

## 20.8 Chain Avoidance

To avoid view chaining (and thus proxy explosion), we define a general mechanism to carry chain information along with object references. This mechanism is defined in both COM and in CORBA to allow for bidirectional chain avoidance. Views in either system carry this information along with their object references. For example, the information carried in the object reference to a CORBA view of an Automation object would describe the object referred to by the view; that is, information about the Automation object.

### 20.8.1 CORBA Chain Avoidance

In CORBA, the chain avoidance information is carried as an IOP profile in an object reference that is part of a chain.

```

module CosBridging
{
 typedef sequence<octet> OpaqueRef;
 typedef sequence<octet> OpaqueData;
 typedef unsigned long ObjectSystemID;

 interface Resolver
 {
 OpaqueRef Resolve(in ObjectSystemID objSysID,
 in unsigned long chainDataFormat,
 in octet chainDataVersion,
 in OpaqueData chainData);
 };

 struct ResolvableRef
 {
 Resolver resolver;
 ObjectSystemID objSysID;
 unsigned long chainDataFormat;
 octet chainDataVersion;
 OpaqueData chainData;
 };

 typedef sequence<ResolvableRef> ResolvableChain;

 struct BridgingProfile
 {

```

```

 ResolvableChainchain;
 };
};

```

The content of the profile is defined as a single **BridgingProfile** structure. The ID for this profile will be allocated by the OMG. The profile structure contains a sequence of **ResolvableRef** structures, potentially one for each object system in the chain.

The **ResolvableRef** structure contains a **resolver** CORBA object reference that can be called at runtime through its **Resolve** method to return an opaque (because it is not CORBA) object reference for the specified link in the chain. The link in the chain is identified by the object system ID, **objSysID**.

Currently defined object system IDs are: 1 for CORBA, 2 for Automation, and 3 for COM. IDs in the range from 0 through 100000 are reserved for use by the OMG for future standardization.

The **ResolvableRef** structure also contains information that can be used by the **resolver** as context to find the appropriate information to return. While this chain data is opaque, it is also tagged with a format identifier so that bridges that understand the format can directly interpret the contents of **chainData** instead of making a remote call to **Resolve**. The only currently defined format tag is 0, which is currently defined as “private.” That is, **chainData** tagged as private cannot be directly interpreted and must be passed to the resolver for interpretation. All other format tags are specific to each object system. Format tags in the range of 1 to 100000 are reserved for allocation by the OMG.

The result of calling the **Resolve** method on a COM or Automation **ResolvableRef** is an NDR marshaled DCOM object reference with at least one strong reference.

## 20.8.2 COM Chain Avoidance

A similar approach is adopted to resolve the same chain avoidance issues in COM; however, since DCOM does not support profiles, the implementation is different. The information for chain avoidance (also used by **IForeignObject** and **IForeignObject2**) is provided as DCOM value data associated with each passed view object. This information is represented by a **ResolvableRefChain**.

```

struct OpaqueRef
{
 unsigned long len;
 unsigned long maxlen;
 BYTE [size_is(len)] *data;
};

struct OpaqueData
{
 unsigned long len;
 unsigned long maxlen;
};

```

```

 BYTE [size_is(len)] *data;
 };

typedef unsigned long ObjectSystemID;

struct ResolvableRef
{
 IResolver resolver;
 ObjectSystemID objSysID;
 unsigned long chainDataFormat;
 BYTE chainDataVersion;
 OpaqueData chainData;
};

struct ResolvableRefChain
{
 unsigned long len;
 unsigned long maxlen;
 ResolvableRef [size_is(len,)]**data;
};

[
 object,
 pointer_default(unique),
 uuid(5473e440-20ac-11d1-8a22-006097cc044d)
]
interface IResolver : IUnknown
{
 OpaqueRef Resolve([in] ObjectSystemID objSysID,
 [in] unsigned long chainDataFormat,
 [in] BYTE chainDataVersion,
 [in] OpaqueData chainData);
};

[
 object,
 pointer_default(unique),
 uuid(60674760-20ac-11d1-8a22-006097cc044d)
]
interface IForeignObject2 : IForeignObject
{
 ResolvedRefChain ChainInfo();
};

```

The use semantics of the resolver is identical to the use semantics described in Section 20.8.1, “CORBA Chain Avoidance,” on page 20-16. One format tag with value 1 is defined for a **ResolvableRef** with **objSysID** 1 (CORBA). If the format tag is 1, the **chainDataVersion** must be 0 and the **chainData** contains a (CDR marshaled) byte defining the byte ordering for the rest of the **chainData** (the byte value is identical to that used to encode GIOP messages) followed by a CDR



marshaled object reference. If **Resolve** were called for this **ResolvableRef**, the same value as contained in the **chainData** would be returned by **Resolve** (i.e., a CDR-marshaled object reference).

In addition to this mechanism, the interface **IForeignObject2** is defined on COM or Automation views to return the **ResolvableRefChain** in cases where this information has been lost.

## 20.9 Chain Bypass

Using the chain avoidance technique defined in this specification, the formation of view chains can be avoided. However, there are cases where the chain avoidance information carried with the object references may have been discarded (for instance, as the object reference is passed through a firewall). In this case, chaining of views cannot be avoided without an explicit performance hit, which was deemed unacceptable. However, at the point when the first invocation is performed, information about the current chain can be returned as out-of-band data. This information can then be used on subsequent invocations to bypass as many views as possible in order to avoid the performance hit of multiple view translations.

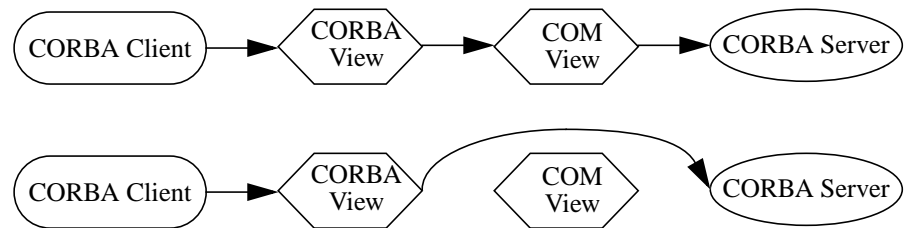

Figure 20-3 Invocation With and Without Chain Bypass

Figure 20-3 shows an example of a call that does not perform chain bypass followed by one that does. Note that chain bypass cannot eliminate all unnecessary calls since the client already has a reference to the view (not to the original object) and thus invokes an operation on the view. It is the responsibility of the view to perform the chain bypass if it so chooses -- in this case the view essentially becomes a rebindable stub.

### 20.9.1 CORBA Chain Bypass

For views to discover the chain information, two service contexts are defined as follows:

```

ChainBypassCheck = 2
ChainBypassInfo = 3

module CosBridging
{
 struct ResolvedRef

```

```

 {
 Resolver resolver;
 ObjectSystemID objSysID;
 unsigned long chainDataFormat;
 octet chainDataVersion;
 OpaqueData chainData;
 OpaqueRef reference;
 };

typedef sequence<ResolvedRef> ResolvedRefChain;

struct ChainBypassCheck // Outgoing service context
{
 Object objectToCheck;
};

struct ChainBypassInfo // Reply service context
{
 ResolvedRefChain chain;
};
};

```

The **ChainBypassCheck** service context is sent out with the first outgoing (non-oneway) request. Since the service context is propagated automatically to subsequent calls, an object is provided in the service context to avoid returning chain information for an incorrect object. For a reply service context to be generated, the object in the service context must match the object (a view) being invoked.

If a reply service context, **ChainBypassInfo**, is received with the reply message, then a view has been detected. The information in the **ResolvedRefChain** can be used to bypass intermediate views. Each **ResolvedRef** is identical to a **ResolvableRef** except that it also contains the result of the resolution -- the **reference** member contains the data that would be returned if **Resolve** were called on the included resolver. If the reference field of **ResolvedRef** is an empty sequence, then the marshaled object reference is assumed to be identical to the **chainData**.

### 20.9.2 COM Chain Bypass

The technique used for COM chain bypass is very similar to the technique used in CORBA. The only difference is the result of the fact that DCOM extents are not propagated into subsequent calls unlike CORBA service contexts.

```

struct ResolvedRef
{
 IResolver resolver;
 ObjectSystemID objSysID;
 unsigned long chainDataFormat;
 BYTE chainDataVersion;
 OpaqueData chainData;
};

```

```

 OpaqueRef reference;
 };

 struct ResolvableRefChain
 {
 unsigned long len;
 unsigned long maxlen;
 ResolvableRef [size_is(len,)]**data;
 };

 struct ChainBypassCheck // Outgoing extent body
 {
 };

 struct ChainBypassInfo // Reply extent body
 {
 ResolvableRefChain chain;
 };

```

The **ChainBypassCheck** extent is sent out with the first outgoing request. If a reply extent, **ChainBypassInfo**, is received with the reply message, then a view has been detected. The information in the **ResolvedRefChain** can be used to bypass intermediate views. Each **ResolvedRef** is identical to a **ResolvableRef** except that it also contains the result of the resolution -- the **reference** member contains the data that would be returned if **Resolve** were called on the included resolver. If the reference field of **ResolvedRef** is an empty sequence, then the marshaled object reference is assumed to be identical to the **chainData**.

The UUID for the request and reply extents are both:

```
1eba96a0-20b1-11d1-8a22-006097cc044d
```

## 20.10 Thread Identification

To correlate incoming requests with previous outgoing requests, DCOM requires a *causality ID*. The identifier is essentially a logical thread ID used to determine whether an incoming request is from an existing logical thread or is a different logical thread of execution. CORBA, on the other hand, does not strictly require a logical thread ID. To maintain the logical thread ID as requests pass through both DCOM and CORBA, we define a general purpose service context, which can be used to maintain logical thread identifiers for any system a thread of execution passes through.

```

module CosBridging
{
 struct OneThreadID
 {
 ObjectSystemID objSysID;
 OpaqueData threadID;
 };
};

```

```

};

typedef sequence<OneThreadID> ThreadIDs;

struct LogicalThreadID // Service context
{
 ThreadIDs IDs;
};
};

```

The logical thread ID information is propagated through a CORBA call chain using a service context (IDs to be assigned by the OMG) containing the **LogicalThreadID** structure.

For future use, a DCOM extent is defined to allow the same logical thread identification information to be passed through a DCOM call chain. If the OMG chooses to standardize a logical thread ID format for CORBA, this can be passed through a DCOM call chain using this extent.

```

struct OneThreadID
{
 ObjectSystemID objSysID;
 OpaqueData threadID;
};

struct ThreadIDs
{
 unsigned long len;
 unsigned long maxlen;
 OneThreadID [size_is(len)] *data;
};

struct LogicalThreadID // DCOM extent
{
 ThreadIDs IDs;
};

```

This extent, used for passing logical thread IDs, is identified by the following UUID:

```
f81f4e20-2234-11d1-8a22-006097cc044d
```

## Contents

This chapter contains the following sections.

| Section Title                  | Page  |
|--------------------------------|-------|
| “Introduction”                 | 21-1  |
| “Interceptor Interface”        | 21-5  |
| “Request Interceptors”         | 21-6  |
| “Portable Interceptor Current” | 21-33 |
| “IOR Interceptor”              | 21-40 |
| “PolicyFactory”                | 21-50 |
| “Registering Interceptors”     | 21-50 |
| “Dynamic Initial References”   | 21-57 |
| “Module Dynamic”               | 21-58 |
| “Consolidated IDL”             | 21-59 |

## 21.1 Introduction

Portable Interceptors are hooks into the ORB through which ORB services can intercept the normal flow of execution of the ORB. The following figures describe the programming model for which portable Interceptors were designed.

### 21.1.1 Object Creation

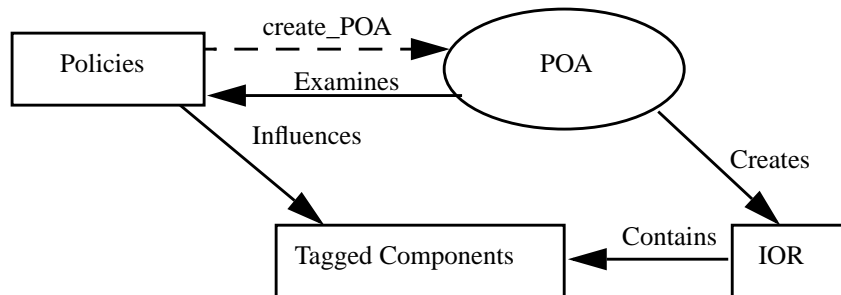

Figure 21-1 Object Creation

Figure 21-1 shows the parts involved in the creation of an object. An object is represented by an IOR created by the POA. A set of policies is used to create a POA which influences the set of tagged components contained within the profiles of any IOR created by that POA. ORB services may have tagged components specific to their service, therefore they require a means to add tagged components to an IOR. ORB services may also introduce new policies; therefore, they require a means to create these new policies.

**Requirement:** Add tagged components

**Satisfied by:** IORInterceptor (see Section 21.5, “IOR Interceptor,” on page 21-40).

**Requirement:** Create policies

**Satisfied by:** PolicyFactory (see Section 21.6, “PolicyFactory,” on page 21-50).

### 21.1.2 Client Sends Request

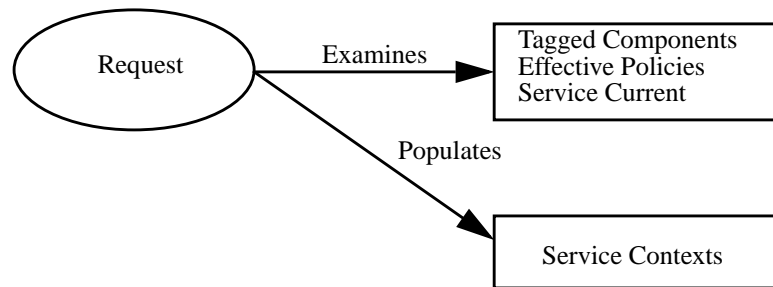

Figure 21-2 Transfer Client's Context to Request's Service Context

Figure 21-2 shows what is needed to transfer a client's context to the service context. Service contexts are populated from information in a service's **Current** object, from the effective policies, and from information in the tagged components on an IOR's profile.

The processing of a request is an integral part of the ORB. Since each ORB service potentially creates its own service context, there must be a means by which each service can get the necessary information during request processing. Since service contexts are defined as a unique identifier and an octet sequence containing a CDR encapsulation there must be a portable method to create such an octet sequence.

- Requirement:** Intercept request processing and access necessary data.
- Satisfied by:** Request Interceptors (see Section 21.3, "Request Interceptors," on page 21-6) and the PortableInterceptor::Current (see Section 21.4, "Portable Interceptor Current," on page 21-33).
- Requirement:** Convert types to octet sequences
- Satisfied by:** Codec (see Section 13.8, "Coder/Decoder Interfaces," on page 13-32).

### 21.1.3 Server Receives Request

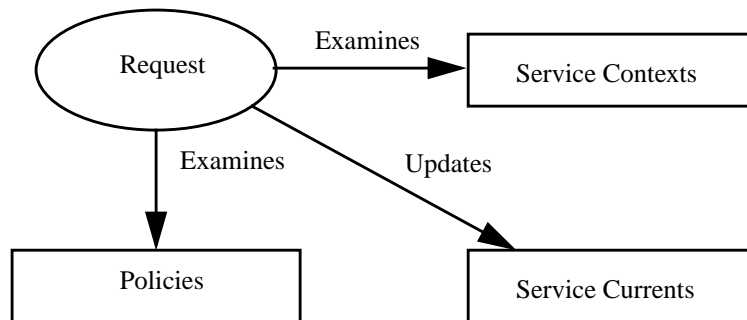

Figure 21-3 Transfer Request's Service Context to Server's Context

On the client, the client's context is transferred to the request's service context. On the server, the opposite must occur: the information in the service context is transferred to the server's context which is then available to the server application. Figure 21-3 shows what is necessary to accomplish this.

The requirements which exist in Section 21.1.2, "Client Sends Request," on page 21-3 also exist here.

### 21.1.4 Server Sends Reply

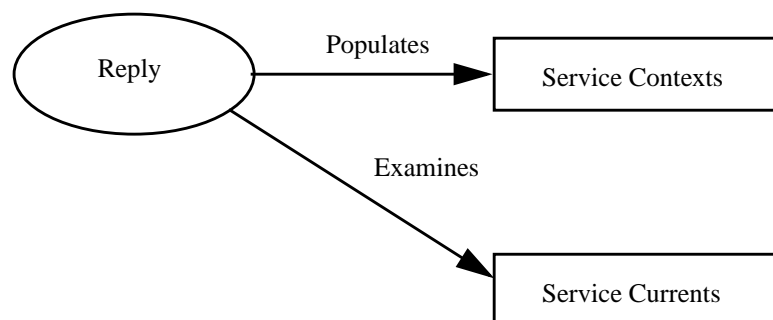

Figure 21-4 Transfer Server's Context to Reply's Service Context

Figure 21-4 shows what is needed to transfer a server's context to a reply's service context. Service contexts are populated from information in a service's **Current** object.

The requirements which exist in Section 21.1.2, "Client Sends Request," on page 21-3 also exist here.



### 21.1.5 Client Receives Reply

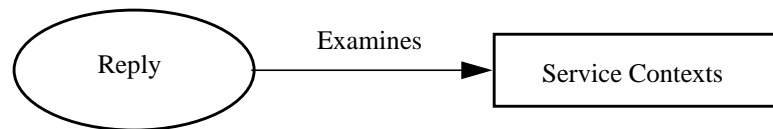

Figure 21-5 View the Service Context on the Client Reply

When processing the client reply, although the client's context cannot be updated by the reply's service context, the service may still wish to query the service context information.

The client's context cannot be updated because such updates would be invalid on asynchronous calls. The client thread may be continually changing its context and if a reply also changed the context at any time, the state of the context at any given time would be indeterminate.

The requirements that exist in Section 21.1.2, "Client Sends Request," on page 21-3 also exist here.

## 21.2 Interceptor Interface

Portable Interceptor interfaces and related type definitions reside in the module **PortableInterceptor**. All portable Interceptors inherit from the local interface **Interceptor**:

```

module PortableInterceptor {
 local interface Interceptor {
 readonly attribute string name;
 void destroy();
 };
};

```

Each Interceptor may have a name that may be used administratively to order the lists of Interceptors. Only one Interceptor of a given name can be registered with the ORB for each Interceptor type. An Interceptor may be anonymous; that is, have an empty string as the name attribute. Any number of anonymous Interceptors may be registered with the ORB.

**Interceptor::destroy** is called during **ORB::destroy**. When an application calls **ORB::destroy**, the ORB:

1. Waits for all requests in progress to complete.
2. Calls the **Interceptor::destroy** operation for each interceptor.
3. Completes destruction of the ORB.

Method invocations from within **Interceptor::destroy** on object references for objects implemented on the ORB being destroyed result in undefined behavior. However, method invocations on objects implemented on an ORB other than the one being destroyed are permitted. (This means that the ORB being destroyed is still capable of acting as a client, but not as a server.)

## 21.3 Request Interceptors

A request Interceptor is designed to intercept the flow of a request/reply sequence through the ORB at specific points so that services can query the request information and manipulate the service contexts that are propagated between clients and servers.

The primary use of request Interceptors is to enable ORB services to transfer context information between clients and servers.

There are two types of request Interceptors: client-side (see Section 21.3.5, “Client-Side Interceptor,” on page 21-9) and server-side (see Section 21.3.8, “Server-Side Interceptor,” on page 21-14).

### 21.3.1 Design Principles

The following points are the principles followed in the design of the portable Interceptor architecture.

1. Interceptors are called on all ORB mediated invocations. The following implicit object operations may or may not be ORB mediated: **get\_interface**, **is\_a**, **non\_existent**, **get\_domain\_managers**, and **get\_component**. When these are ORB mediated, Interceptors are called; when they are not ORB mediated, Interceptors are not called.
2. A request Interceptor can affect the outcome of a request by raising a system exception at any of the interception points. It can stop the request from even reaching the target by raising a system exception in the outbound path. It can alter an outcome specified by the target (exception or non-exception) by raising a system exception in the inbound path.
3. A request Interceptor can affect the outcome of a request by directing a request to a different location at any interception point other than a successful reply. That different location might include a location not otherwise reachable through the original request; that is, a location that might not be discovered by the ORB in the course of a locate request.

4. A request Interceptor cannot affect a request by changing a parameter specified by the client. That is, the Interceptor cannot modify “in” arguments.
5. A request Interceptor cannot affect a non-exception outcome by supplying the response itself. That is, the Interceptor cannot modify “out” arguments or the return value.
6. Request Interceptors are independent of other request Interceptors. That is, a request Interceptor won’t need to know, and won’t even be told, if there are request Interceptors executed before or after it. If a request Interceptor down the line (executed closer to the target than this one) affects the outcome of request, this request Interceptor will not be aware of that fact.  
Corollary: request Interceptors can communicate between themselves to bypass this principle, but that’s outside of the concerns of the model.
7. A request Interceptor may make object invocations itself before allowing the current request to execute.
8. There is no provision for making client implementations aware that any request Interceptor has been or will be called.  
Corollary: A client and a request Interceptor can communicate between themselves to bypass this principle, but that is outside of the concerns of the model.
9. There is no provision for making object implementations aware that any request Interceptor has been or will be called.  
Corollary: An object implementation and a request Interceptor can communicate between themselves to bypass this principle, but that is outside of the concerns of the model.
10. To ensure the integrity of the effect of each request Interceptor, a set of general flow rules are specified that govern the flow of processing through a list of interceptors. See below.

### 21.3.2 General Flow Rules

Both client and server request Interceptors are registered with an ORB (see Section 21.7, “Registering Interceptors,” on page 21-50). The ORB logically maintains an ordered list of these Interceptors.

To accommodate both the client and server request Interceptors, and any future additions to the interception points list, the following general rules apply to the flow of execution of request interception points:

- There is a set of starting interception points. One and only one of these is called on any given request/reply sequence;
- There is a set of ending interception points. One and only one of these is called on any given request/reply sequence;
- There may be any number of intermediate interception points between the start and end interception points which run in sequence;

- On an exception, intermediate interception points may not be called;
- If and only if a starting interception point runs to completion is an ending interception point called.

See Section 21.3.7, “Client-Side Interception Point Flow,” on page 21-11 and Section 21.3.10, “Server-Side Interception Point Flow,” on page 21-17 for details of how these general flow rules apply specifically to the client-side and server-side Interceptors.

### 21.3.3 The Flow Stack Visual Model

To visualize the general flow rules, think of each Interceptor as being put on a Flow Stack when a starting interception point completes successfully. (An ORB need not implement the Flow Stack. It is presented simply as a visual cue.) An ending interception point is called for each Interceptor in the stack. If a starting interception point is called for all Interceptors, then all Interceptors will have an ending interception point called. If one of the Interceptors raises an exception during the invocation of its starting interception point, only those Interceptors on the stack at that point will be popped and have an ending interception point called.

### 21.3.4 The Request Interceptor Points

Each request Interceptor is called at a number of interception points. Figure 21-6 shows the flow of control for a request/reply cycle that is subject to at least one request Interceptor. See Section 21.3.5, “Client-Side Interceptor,” on page 21-9 and Section 21.3.8, “Server-Side Interceptor,” on page 21-14 for descriptions of each of these interception points.

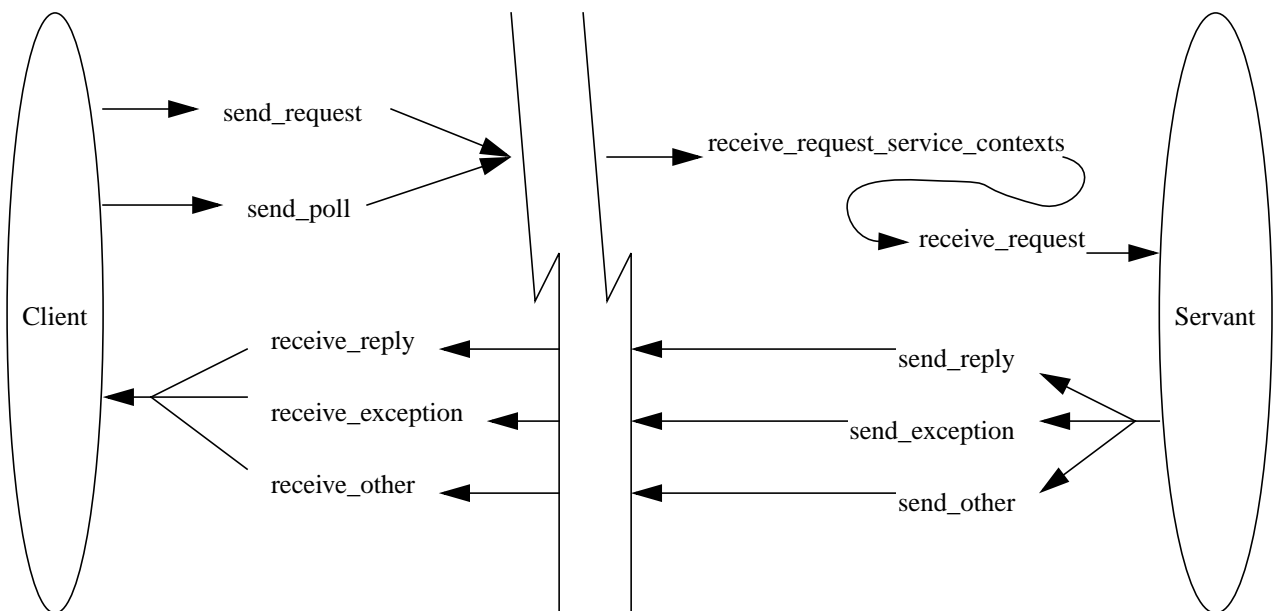

Figure 21-6 Request Interception Points

### 21.3.5 Client-Side Interceptor

To write a client-side Interceptor, the **ClientRequestInterceptor** local interface shall be implemented.

```

local interface ClientRequestInterceptor : Interceptor {
 void send_request (in ClientRequestInfo ri)
 raises (ForwardRequest);
 void send_poll (in ClientRequestInfo ri);
 void receive_reply (in ClientRequestInfo ri);
 void receive_exception (in ClientRequestInfo ri)
 raises (ForwardRequest);
 void receive_other (in ClientRequestInfo ri)
 raises (ForwardRequest);
};

```

### 21.3.6 Client-Side Interception Points

#### 21.3.6.1 *send\_request*

This interception point allows an Interceptor to query request information and modify the service context before the request is sent to the server.

This interception point may raise a system exception. If it does, no other Interceptors' **send\_request** operations are called. Those Interceptors on the Flow Stack are popped and their **receive\_exception** interception points are called.

This interception point may also raise a **ForwardRequest** exception (see Section 21.3.15, "ForwardRequest Exception," on page 21-33 for details of this exception). If an Interceptor raises this exception, no other Interceptors' **send\_request** operations are called. Those Interceptors on the Flow Stack are popped and their **receive\_other** interception points are called.

Compliant Interceptors shall properly follow **completion\_status** semantics if they raise a system exception from this interception point. The **completion\_status** shall be **COMPLETED\_NO**.

#### 21.3.6.2 *send\_poll*

This interception point allows an Interceptor to query information during a Time-Independent Invocation (TII) polling get reply sequence.

With TII, an application may poll for a response to a request sent previously by the polling client or some other client. This poll is reported to Interceptors through the **send\_poll** interception point and the response is returned through the **receive\_reply** or **receive\_exception** interception points. If the response is not available before the poll time-out expires, the system exception **TIMEOUT** is raised and **receive\_exception** is called with this exception.

This interception point may raise a system exception. If it does, no other Interceptors' **send\_poll** operations are called. Those Interceptors on the Flow Stack are popped and their **receive\_exception** interception points are called.

Compliant Interceptors shall properly follow **completion\_status** semantics if they raise a system exception from this interception point. The **completion\_status** shall be **COMPLETED\_NO**.

#### 21.3.6.3 *receive\_reply*

This interception point allows an Interceptor to query the information on a reply after it is returned from the server and before control is returned to the client.

This interception point may raise a system exception. If it does, no other Interceptors' **receive\_reply** operations are called. The remaining Interceptors in the Flow Stack shall have their **receive\_exception** interception point called.

Compliant Interceptors shall properly follow **completion\_status** semantics if they raise a system exception from this interception point. The **completion\_status** shall be **COMPLETED\_YES**.

#### 21.3.6.4 *receive\_exception*

When an exception occurs, this interception point is called. It allows an Interceptor to query the exception's information before it is raised to the client.

This interception point may raise a system exception. This has the effect of changing the exception, which successive Interceptors popped from the Flow Stack receive on their calls to **receive\_exception**. The exception raised to the client will be the last exception raised by an Interceptor, or the original exception if no Interceptor changes the exception.

This interception point may also raise a **ForwardRequest** exception (see Section 21.3.15, "ForwardRequest Exception," on page 21-33 for details on this exception). If an Interceptor raises this exception, no other Interceptors' **receive\_exception** operations are called. The remaining Interceptors in the Flow Stack are popped and have their **receive\_other** interception point called.

If the **completion\_status** of the exception is not **COMPLETED\_NO**, then it is inappropriate for this interception point to raise a **ForwardRequest** exception. The request's at-most-once semantics would be lost.

Compliant Interceptors shall properly follow **completion\_status** semantics if they raise a system exception from this interception point. If the original exception is a system exception, the **completion\_status** of the new exception shall be the same as on the original. If the original exception is a user exception, then the **completion\_status** of the new exception shall be **COMPLETED\_YES**.

Under some conditions, depending on what policies are in effect, an exception (such as **COMM\_FAILURE**) may result in a retry of the request. While this retry is a new request with respect to Interceptors, there is one point of correlation between the

original request and the retry: because control has not returned to the client, the **PortableInterceptor::Current** for both the original request and the retrying request is the same (see Section 21.4, “Portable Interceptor Current,” on page 21-33).

#### 21.3.6.5 *receive\_other*

This interception point allows an Interceptor to query the information available when a request results in something other than a normal reply or an exception. For example, a request could result in a retry (for example, a GIOP Reply with a **LOCATION\_FORWARD** status was received); or on asynchronous calls, the reply does not immediately follow the request, but control shall return to the client and an ending interception point shall be called.

For retries, depending on the policies in effect, a new request may or may not follow when a retry has been indicated. If a new request does follow, while this request is a new request with respect to Interceptors, there is one point of correlation between the original request and the retry. Because control has not returned to the client, the request scoped **PortableInterceptor::Current** for both the original request and the retrying request is the same (see Section 21.4, “Portable Interceptor Current,” on page 21-33).

This interception point may raise a system exception. If it does, no other Interceptors’ **receive\_other** operations are called. The remaining Interceptors in the Flow Stack are popped and have their **receive\_exception** interception point called.

This interception point may also raise a **ForwardRequest** exception (see Section 21.3.15, “ForwardRequest Exception,” on page 21-33 for details on this exception). If an Interceptor raises this exception, successive Interceptors’ **receive\_other** operations are called with the new information provided by the **ForwardRequest** exception.

Compliant Interceptors shall properly follow **completion\_status** semantics if they raise a system exception from this interception point. The **completion\_status** shall be **COMPLETED\_NO**. If the target invocation had completed, this interception point would not be called.

### 21.3.7 *Client-Side Interception Point Flow*

A **ClientRequestInterceptor** instance is registered with the ORB. The ORB logically maintains an ordered list of client-side Interceptors. The Interceptor list is traversed in order on the sending interception points and in reverse order on the receiving interception points.

#### 21.3.7.1 *Client-side Flow Rules*

The client-side flow rules are derived from the general flow rules (see Section 21.3.2, “General Flow Rules,” on page 21-7):

- The set of starting interception points is: **send\_request** and **send\_poll**. One and only one of these is called on any given request/reply sequence.

- The set of ending interception points is: **receive\_reply**, **receive\_exception**, **receive\_other**. One and only one of these is called on any given request/reply sequence.
- There are no intermediate exception points.
- If and only if **send\_request** or **send\_poll** runs to completion is an ending interception point called.

### 21.3.7.2 *Additional Client-side Details*

If, during request processing, a request is canceled because of an ORB shutdown, **receive\_exception** is called with the system exception **BAD\_INV\_ORDER** with a minor code of 4 (ORB has shutdown).

If a request is canceled for any other reason (for example, a GIOP cancel message is sent by the ORB), **receive\_exception** is called with the system exception **TRANSIENT** with a standard minor code of 2.

On oneway requests, returning control to the client may occur immediately or it may return after the target has performed the operation, or somewhere in-between depending on the SyncScope (see Section 21.3.12.9, “sync\_scope,” on page 21-23). Regardless of the SyncScope, if there is no exception, **receive\_other** is called before control is returned to the client.

Asynchronous requests are simply two separate requests. The first request receives no reply. The second receives a normal reply. So the normal (no exceptions) flow is: first request - **send\_request** followed by **receive\_other**; second request - **send\_request** followed by **receive\_reply**.

### 21.3.7.3 *Client-side Flow Examples*

Given the client-side flow rules, here are some concrete examples:

- For successful invocations: **send\_request** is followed by **receive\_reply** - a start point is followed by an end point.
- For retries: **send\_request** is followed by **receive\_other** - a start point is followed by an end point.
- For successful TII polls, **send\_poll** is followed by **receive\_reply** - a start point is followed by an end point.
- For TII polls whose response is unavailable, **send\_poll** is followed by **receive\_exception** - a start point is followed by an end point.

For the following exception scenarios, assume we have Interceptors A, B, and C. On the send interception points they are called in the order A, B, C; on the receive interception points they are called in the order C, B, A.

#### *Scenario*

An exception arrives from the server:



- **A.send\_request** is called;
- **B.send\_request** is called;
- **C.send\_request** is called;
- **C.receive\_exception** is called;
- **B.receive\_exception** is called;
- **A.receive\_exception** is called.

In this scenario you can see that the flow for each Interceptor follows the rules. They are all: **send\_request** followed by **receive\_exception** - a start point is followed by an end point.

#### *Scenario*

**B.send\_request** raises an exception:

- **A.send\_request** is called;
- **B.send\_request** is called and raises an exception
- **A.receive\_exception** is called.

In this scenario you can see that the flow for each Interceptor follows the rules:

- The flow for A is **send\_request** followed by **receive\_exception** - a start point is followed by an end point.
- The flow for B is **send\_request** - a start point did not complete, so no end point was called; B raised the exception, so there is no need to tell it that the exception occurred.
- The flow for C is non-existent since the exception occurred before any of C's interception points was invoked - a start point was not called, so no end point is called.

#### *Scenario*

A reply returns successfully from the server, but **B.receive\_reply** raises an exception:

- **A.send\_request** is called;
- **B.send\_request** is called;
- **C.send\_request** is called;
- **C.receive\_reply** is called;
- **B.receive\_reply** is called and raises an exception;
- **A.receive\_exception** is called.

In this scenario you can see that the flow for each Interceptor follows the rules:

- The flow for A is **send\_request** followed by **receive\_exception** - a start point is followed by an end point.
- The flow for B is **send\_request** followed by **receive\_reply** - a start point is followed by an end point.
- The flow for C is **send\_request** followed by **receive\_reply** - a start point is followed by an end point.

The scenario for B raising an exception at **receive\_other** is similar to the scenario where B raises an exception at **receive\_reply**.

### *Scenario*

An exception X is returned by the server, but **B.receive\_exception** changes the exception to Y:

- **A.send\_request** is called;
- **B.send\_request** is called;
- **C.send\_request** is called;
- **C.receive\_exception** is called with X;
- **B.receive\_exception** is called with X, raises Y;
- **A.receive\_exception** is called with Y.

In this scenario, the flow for all Interceptors is **send\_request** followed by **receive\_exception** - a start point followed by an end point - Interceptor A is handed exception Y while the B and C are handed exception X.

## *21.3.8 Server-Side Interceptor*

To write a server-side Interceptor, the **ServerRequestInterceptor** local interface shall be implemented.

```
local interface ServerRequestInterceptor : Interceptor {
 void receive_request_service_contexts (in ServerRequestInfo ri)
 raises (ForwardRequest);
 void receive_request (in ServerRequestInfo ri)
 raises (ForwardRequest);
 void send_reply (in ServerRequestInfo ri);
 void send_exception (in ServerRequestInfo ri)
 raises (ForwardRequest);
 void send_other (in ServerRequestInfo ri) raises (ForwardRequest);
};
```

## *21.3.9 Server-Side Interception Points*

### *21.3.9.1 receive\_request\_service\_contexts*

At this interception point, Interceptors must get their service context information from the incoming request transfer it to **PortableInterceptor::Current**'s slots (see Section 21.4, "Portable Interceptor Current," on page 21-33 for details on the relationship between **receive\_request\_service\_contexts** and **PortableInterceptor::Current**).

This interception point is called before the servant manager is called. Operation parameters are not yet available at this point. This interception point may or may not execute in the same thread as the target invocation.

This interception point may raise a system exception. If it does, no other Interceptors' **receive\_request\_service\_contexts** operations are called. Those Interceptors on the Flow Stack are popped and their **send\_exception** interception points are called.

This interception point may also raise a **ForwardRequest** exception (see Section 21.3.15, “ForwardRequest Exception,” on page 21-33 for details on this exception). If an Interceptor raises this exception, no other Interceptors’ **receive\_request\_service\_contexts** operations are called. Those Interceptors on the Flow Stack are popped and their **send\_other** interception points are called.

Compliant Interceptors shall properly follow **completion\_status** semantics if they raise a system exception from this interception point. The **completion\_status** shall be **COMPLETED\_NO**.

### 21.3.9.2 *receive\_request*

This interception point allows an Interceptor to query request information after all the information, including operation parameters, are available. This interception point shall execute in the same thread as the target invocation.

In the DSI model, since the parameters are first available when the user code calls **arguments**, **receive\_request** is called from within **arguments**. It is possible that **arguments** is not called in the DSI model. The target may call **set\_exception** before calling **arguments**. The ORB shall guarantee that **receive\_request** is called once, either through **arguments** or through **set\_exception**. If it is called through **set\_exception**, requesting the arguments will result in **NO\_RESOURCES** being raised with a standard minor code of 1.

This interception point may raise a system exception. If it does, no other Interceptors’ **receive\_request** operations are called. Those Interceptors on the Flow Stack are popped and their **send\_exception** interception points are called.

This interception point may also raise a **ForwardRequest** exception (see Section 21.3.15, “ForwardRequest Exception,” on page 21-33 for details on this exception). If an Interceptor raises this exception, no other Interceptors’ **receive\_request** operations are called. Those Interceptors on the Flow Stack are popped and their **send\_other** interception points are called.

Compliant Interceptors shall properly follow **completion\_status** semantics if they raise a system exception from this interception point. The **completion\_status** shall be **COMPLETED\_NO**.

### 21.3.9.3 *send\_reply*

This interception point allows an Interceptor to query reply information and modify the reply service context after the target operation has been invoked and before the reply is returned to the client. This interception point shall execute in the same thread as the target invocation.

This interception point may raise a system exception. If it does, no other Interceptors’ **send\_reply** operations are called. The remaining Interceptors in the Flow Stack shall have their **send\_exception** interception point called.

Compliant Interceptors shall properly follow **completion\_status** semantics if they raise a system exception from this interception point. The **completion\_status** shall be **COMPLETED\_YES**.

#### 21.3.9.4 *send\_exception*

When an exception occurs, this interception point is called. It allows an Interceptor to query the exception information and modify the reply service context before the exception is raised to the client. This interception point shall execute in the same thread as the target invocation.

This interception point may raise a system exception. This has the effect of changing the exception that successive Interceptors popped from the Flow Stack receive on their calls to **send\_exception**. The exception raised to the client will be the last exception raised by an Interceptor, or the original exception if no Interceptor changes the exception.

This interception point may also raise a **ForwardRequest** exception (see Section 21.3.15, “ForwardRequest Exception,” on page 21-33 for details on this exception). If an Interceptor raises this exception, no other Interceptors’ **send\_exception** operations are called. The remaining Interceptors in the Flow Stack shall have their **send\_other** interception points called.

If the **completion\_status** of the exception is not **COMPLETED\_NO**, then it is inappropriate for this interception point to raise a **ForwardRequest** exception. The request’s at-most-once semantics would be lost.

Compliant Interceptors shall properly follow **completion\_status** semantics if they raise a system exception from this interception point. If the original exception is a system exception, the **completion\_status** of the new exception shall be the same as on the original. If the original exception is a user exception, then the **completion\_status** of the new exception shall be **COMPLETED\_YES**.

#### 21.3.9.5 *send\_other*

This interception point allows an Interceptor to query the information available when a request results in something other than a normal reply or an exception. A request could result in a retry (for example, a GIOP Reply with a **LOCATION\_FORWARD** status was received). This interception point shall execute in the same thread as the target invocation.

This interception point may raise a system exception. If it does, no other Interceptors’ **send\_other** operations are called. The remaining Interceptors in the Flow Stack shall have their **send\_exception** interception points called.

This interception point may also raise a **ForwardRequest** exception (see Section 21.3.15, “ForwardRequest Exception,” on page 21-33 for details on this exception). If an Interceptor raises this exception, successive Interceptors’ **send\_other** operations are called with the new information provided by the **ForwardRequest** exception.

Compliant Interceptors shall properly follow **completion\_status** semantics if they raise a system exception from this interception point. The **completion\_status** shall be **COMPLETED\_NO**.

### 21.3.10 Server-Side Interception Point Flow

A **ServerRequestInterceptor** instance is registered with the ORB (see Section 21.7, “Registering Interceptors,” on page 21-50). The ORB logically maintains an ordered list of server-side Interceptors. The Interceptor list is traversed in order on the receiving interception points and in reverse order on the sending interception points.

#### 21.3.10.1 Server-side Flow Rules

The server-side flow rules are derived from the general flow rules (see Section 21.3.2, “General Flow Rules,” on page 21-7).

- The starting interception point is **receive\_request\_service\_contexts**; this interception point is called on any given request/reply sequence.
- The set of ending interception points is **send\_reply**, **send\_exception**, **send\_other**. One and only one of these is called on any given request/reply sequence.
- The intermediate interception point is **receive\_request**, which is called after **receive\_request\_service\_contexts** and before an ending interception point.
- On an exception, **receive\_request** may not be called.
- If and only if **receive\_request\_service\_contexts** runs to completion is an ending interception point called.

#### 21.3.10.2 Additional Server-side Details

If, during request processing, a request is canceled because of an ORB shutdown, **send\_exception** is called with the system exception **BAD\_INV\_ORDER** with a minor code of 4 (ORB has shutdown).

If a request is canceled for any other reason (for example, a GIOP cancel message has been received), **send\_exception** is called with the system exception **TRANSIENT** with a standard minor code of 3.

The following statement is made about the GIOP close connection message (CORBA v2.3 15-45):

“If the ORB sending the **CloseConnection** is a server, or bidirectional GIOP is in use, the sending ORB must not currently be processing any Requests from the other side.”

With respect to portable Interceptors, “...processing any Requests...” means that **receive\_request\_service\_contexts** has been called on any Interceptor and no ending interception point has yet been invoked.

On oneway requests, there is no reply sent to the client; however, the target is called and the server can construct an empty reply. Since closure is necessary, this reply is tracked and **send\_reply** is called (unless an exception occurs, in which case **send\_exception** is called).

Asynchronous requests, from the server's point of view, are just normal synchronous requests. Normal interception point flows are followed.

If a POA and a servant locator are present, the order of their operations and interception points is:

1. **ServerRequestInterceptor.receive\_request\_service\_contexts;**
2. **ServantLocator.preinvoke;**
3. **ServerRequestInterceptor.receive\_request**
4. the operation
5. **ServantLocator.postinvoke;**
6. **ServerRequestInterceptor send\_reply, send\_exception, or send\_other.**

**preinvoke**, the operation, and **postinvoke** are required to execute in the same thread (see Section 11.3.7, "ServantLocator Interface," on page 11-27). Since **receive\_request** occurs within this chain, **receive\_request** shall also execute in the same thread.

**postinvoke** executes in the same thread as **preinvoke** in order for **postinvoke** to perform any necessary closure processing. Likewise, the sending interception points (**send\_reply**, **send\_exception**, or **send\_other**) shall also execute in the same thread.

### 21.3.10.3 *Server-side Flow Examples*

Given the server-side flow rules, here are some concrete examples.

For successful invocations, the chain of interception points, in order, is: **receive\_request\_service\_contexts**, **receive\_request**, **send\_reply** - a start point is followed by an intermediate point, which is followed by an end point.

For the following exception scenarios, assume we have Interceptors A, B, and C. On the receive interception points they are called in the order A, B, C; on the send interception points they are called in the order C, B, A.

#### *Scenario*

An exception is raised by the target:

- **A.receive\_request\_service\_contexts** is called;
- **B.receive\_request\_service\_contexts** is called;
- **C.receive\_request\_service\_contexts** is called;
- **A.receive\_request** is called;
- **B.receive\_request** is called;

- **C.receive\_request** is called;
- **C.send\_exception** is called;
- **B.send\_exception** is called;
- **A.send\_exception** is called.

In this scenario you can see that the flow for each Interceptor follows the rules. The chain for all is: **receive\_request\_service\_contexts**, **receive\_request**, **send\_exception** - a start point is followed by an intermediate point that is followed by an end point.

#### *Scenario*

**B.receive\_request\_service\_contexts** raises an exception:

- **A.receive\_request\_service\_contexts** is called;
- **B.receive\_request\_service\_contexts** is called and raises an exception;
- **A.send\_exception** is called.;

In this scenario you can see that the flow for each Interceptor follows the rules:

- The flow for A is **receive\_request\_service\_contexts** followed by **send\_exception** - a start point followed by an end point, no intermediate points are called.
- The flow for B is **receive\_request\_service\_contexts** - a start point did not complete, so no end point was called; B raised the exception, so there is no need to tell it that the exception occurred.
- The flow for C is non-existent since the exception occurred before any of C's interception points were invoked.

#### *Scenario*

**B.receive\_request** raises an exception:

- **A.receive\_request\_service\_contexts** is called;
- **B.receive\_request\_service\_contexts** is called;
- **C.receive\_request\_service\_contexts** is called;
- **A.receive\_request** is called;
- **B.receive\_request** is called and raises an exception;
- **C.send\_exception** is called;
- **B.send\_exception** is called;
- **A.send\_exception** is called.

In this scenario you can see that the flow for each Interceptor follows the rules:

- Since the **receive\_request\_service\_contexts** starting point ran to completion then, no matter what happens in intermediate points, a “terminating” interception point must be called for all interceptors.

#### *Scenario*

The target invocation returns successfully, but **B.send\_reply** raises an exception:

- **A.receive\_request\_service\_contexts** is called;
- **B.receive\_request\_service\_contexts** is called;

- **C.receive\_request\_service\_contexts** is called;
- **A.receive\_request** is called;
- **B.receive\_request** is called;
- **C.receive\_request** is called;
- **C.send\_reply** is called;
- **B.send\_reply** is called and raises an exception;
- **A.send\_exception** is called.

In this scenario you can see that the flow for each Interceptor follows the rules:

- The flow for A is: **receive\_request\_service\_contexts**, **receive\_request**, **send\_exception** - a start point is followed by an intermediate point that is followed by an end point.
- The flow for B is **receive\_request\_service\_contexts**, **receive\_request**, **send\_reply** - a start point is followed by intermediate point, which is followed by an end point.
- The flow for C is: **receive\_request\_service\_contexts**, **receive\_request**, **send\_reply** - a start point is followed by an intermediate point which is followed by an end point.

The scenario for B raising an exception at **send\_other** is similar to the scenario where B raises an exception at **send\_reply**.

#### *Scenario*

An exception X is raised by the target, but **B.send\_exception** changes the exception to Y:

- **A.receive\_request\_service\_contexts** is called;
- **B.receive\_request\_service\_contexts** is called;
- **C.receive\_request\_service\_contexts** is called;
- **A.receive\_request** is called;
- **B.receive\_request** is called;
- **C.receive\_request** is called;
- **C.send\_exception** is called with X;
- **B.send\_exception** is called with X, raises Y;
- **A.send\_exception** is called with Y.

In this scenario, the flow for all Interceptors is **receive\_request\_service\_contexts**, **receive\_request**, **send\_exception** - a start point is followed by an intermediate point, which is followed by an end point; Interceptor A is handed exception Y while the B and C are handed exception X.

### *21.3.11 Request Information*

Each interception point is given an object through which the Interceptor can access request information. Client-side and server-side interception points are concerned with different information, so there are two information objects: **ClientRequestInfo** is



passed to the client-side interception points and **ServerRequestInfo** is passed to the server-side interception points. But there is information that is common to both, so they both inherit from a common interface: **RequestInfo**.

### 21.3.12 *RequestInfo* Interface

```

local interface RequestInfo {
 readonly attribute unsigned long request_id;
 readonly attribute string operation;
 readonly attribute Dynamic::ParameterList arguments;
 readonly attribute Dynamic::ExceptionList exceptions;
 readonly attribute Dynamic::ContextList contexts;
 readonly attribute Dynamic::RequestContext operation_context;
 readonly attribute any result;
 readonly attribute boolean response_expected;
 readonly attribute Messaging::SyncScope sync_scope;
 readonly attribute ReplyStatus reply_status;
 readonly attribute Object forward_reference;
 any get_slot (in SlotId id) raises (InvalidSlot);
 IOP::ServiceContext get_request_service_context (
 in IOP::ServiceId id);
 IOP::ServiceContext get_reply_service_context (
 in IOP::ServiceId id);
};

```

The details of the attributes and operations on **RequestInfo** follow. Some of these are not valid at all interception points. See Table 21-1 on page 21-26 and Table 21-2 on page 21-29.

#### 21.3.12.1 *request\_id*

This ID uniquely identifies an active request/reply sequence. Once a request/reply sequence is concluded this ID may be reused.

Note that this id is not the same as the GIOP **request\_id**. If GIOP is the transport mechanism used, then these IDs may very well be the same, but this is not guaranteed nor required.

#### 21.3.12.2 *operation*

This attribute is the name of the operation being invoked.

#### 21.3.12.3 *arguments*

This attribute is a **Dynamic::ParameterList** containing the arguments on the operation being invoked (see Section 21.9.1, “NVList PIDL Represented by ParameterList IDL,” on page 21-58). If there are no arguments, this attribute will be a zero length sequence.

Not all environments provide access to the arguments. With the Java portable bindings, for example, the arguments are not available. In these environments, when this attribute is accessed, **NO\_RESOURCES** will be raised with a standard minor code of 1.

#### *21.3.12.4 exceptions*

This attribute is a **Dynamic::ExceptionList** describing the **TypeCodes** of the user exceptions that this operation invocation may raise (see Section 21.9.3, “ExceptionList PIDL Represented by ExceptionList IDL,” on page 21-58). If there are no user exceptions, this attribute will be a zero length sequence.

Not all environments provide access to the exception list. With the Java portable bindings, for example, the exception list is not available. In these environments, when this attribute is accessed, **NO\_RESOURCES** will be raised with a standard minor code of 1.

#### *21.3.12.5 contexts*

This attribute is a **Dynamic::ContextList** describing the contexts that may be passed on this operation invocation (see Section 21.9.2, “ContextList PIDL Represented by ContextList IDL,” on page 21-58). If there are no contexts, this attribute will be a zero length sequence.

Not all environments provide access to the context list. With the Java portable bindings, for example, the context list is not available. In these environments, when this attribute is accessed, **NO\_RESOURCES** will be raised with a standard minor code of 1.

#### *21.3.12.6 operation\_context*

This attribute is a **Dynamic::RequestContext** containing the contexts being sent on the request (see Section 21.9.4, “Context PIDL Represented by RequestContext IDL,” on page 21-59).

Not all environments provide access to the context. With the Java portable bindings, for example, the context is not available. In these environments, when this attribute is accessed, **NO\_RESOURCES** will be raised with standard minor code of 1.

#### *21.3.12.7 result*

This attribute is an **any** containing the result of the operation invocation.

If the operation return type is **void**, this attribute will be an **any** containing a type code with a **TCKind** value of **tk\_void** and no value.

Not all environments provide access to the result. With the Java portable bindings, for example, the result is not available. In these environments, when this attribute is accessed, **NO\_RESOURCES** will be raised with a standard minor code of 1.

### 21.3.12.8 *response\_expected*

This boolean attribute indicates whether a response is expected.

On the client, a reply is not returned when **response\_expected** is false, so **receive\_reply** cannot be called. **receive\_other** is called unless an exception occurs, in which case **receive\_exception** is called.

On the client, within **send\_poll**, this attribute is **true**.

### 21.3.12.9 *sync\_scope*

This attribute, defined in the Messaging specification, is pertinent only when **response\_expected** is false. If **response\_expected** is true, the value of **sync\_scope** is undefined. It defines how far the request shall progress before control is returned to the client. This attribute may have one of the following values:

**Messaging::SYNC\_NONE**  
**Messaging::SYNC\_WITH\_TRANSPORT**  
**Messaging::SYNC\_WITH\_SERVER**  
**Messaging::SYNC\_WITH\_TARGET**

On the server, for all scopes, a reply will be created from the return of the target operation call, but the reply will not return to the client. Although it does not return to the client, it does occur, so the normal server-side interception points are followed; that is, **receive\_request\_service\_contexts**, **receive\_request**, **send\_reply**, or **send\_exception**.

For **SYNC\_WITH\_SERVER** and **SYNC\_WITH\_TARGET**, the server does send an empty reply back to the client before the target is invoked. This reply is not intercepted by server-side Interceptors.

### 21.3.12.10 *reply\_status*

This attribute describes the state of the result of the operation invocation. Its value can be one of the following:

**PortableInterceptor::SUCCESSFUL**  
**PortableInterceptor::SYSTEM\_EXCEPTION**  
**PortableInterceptor::USER\_EXCEPTION**  
**PortableInterceptor::LOCATION\_FORWARD**  
**PortableInterceptor::TRANSPORT\_RETRY**  
**PortableInterceptor::UNKNOWN**

On the client:

- Within the **receive\_reply** interception point, this attribute will only be **SUCCESSFUL**.
- Within the **receive\_exception** interception point, this attribute will be either **SYSTEM\_EXCEPTION** or **USER\_EXCEPTION**.

- Within the `receive_other` interception point, this attribute will be any of: **SUCCESSFUL**, **LOCATION\_FORWARD**, **TRANSPORT\_RETRY**, or **UNKNOWN**. **SUCCESSFUL** means an asynchronous request returned successfully. **LOCATION\_FORWARD** means that a reply came back with **LOCATION\_FORWARD** as its status. **TRANSPORT\_RETRY** means that the transport mechanism indicated a retry - a GIOP reply with a status of **NEEDS\_ADDRESSING\_MODE**, for instance. **UNKNOWN** means that the ORB was unable to determine the correct status. This can occur for example in the Java language mapping when the optimized path for a collocated call is used.

On the server:

- Within the `send_reply` interception point, this attribute will only be **SUCCESSFUL**.
- Within the `send_exception` interception point, this attribute will be either **SYSTEM\_EXCEPTION** or **USER\_EXCEPTION**.
- Within the `send_other` interception point, this attribute will be any of: **SUCCESSFUL**, **LOCATION\_FORWARD**, or **UNKNOWN**. **SUCCESSFUL** means an asynchronous request returned successfully. **LOCATION\_FORWARD** means that a reply came back with **LOCATION\_FORWARD** as its status. **UNKNOWN** means that the ORB was unable to determine the correct status. This can occur for example in the Java language mapping when the optimized path for a collocated call is used.

#### 21.3.12.11 *forward\_reference*

If the `reply_status` attribute is **LOCATION\_FORWARD**, then this attribute will contain the object to which the request will be forwarded. It is indeterminate whether a forwarded request will actually occur.

#### 21.3.12.12 *get\_slot*

This operation returns the data from the given slot of the **PortableInterceptor::Current** that is in the scope of the request.

If the given slot has not been set, then an **any** containing a type code with a **TCKind** value of **tk\_null** is returned.

If the ID does not define an allocated slot, **InvalidSlot** is raised.

See Section 21.4, “Portable Interceptor Current,” on page 21-33 for an explanation of slots and the **PortableInterceptor::Current**.

##### *Parameters*

**id**                                      The SlotId of the slot that is to be returned.

##### *Return Value*

The slot data, in the form of an **any**, obtained with the given identifier.

### 21.3.12.13 *get\_request\_service\_context*

This operation returns a copy of the service context with the given ID that is associated with the request.

If the request's service context does not contain an entry for that ID, `BAD_PARAM` with a standard minor code of 26 is raised.

#### *Parameters*

`id`                      The `IOP::ServiceId` of the service context that is to be returned.

*Return Value*            The `IOP::ServiceContext` obtained with the given identifier.

### 21.3.12.14 *get\_reply\_service\_context*

This operation returns a copy of the service context with the given ID that is associated with the reply.

If the request's service context does not contain an entry for that ID, `BAD_PARAM` with a standard minor code of 26 is raised.

#### *Parameters*

`id`                      The `IOP::ServiceId` of the service context that is to be returned.

*Return Value*            The `IOP::ServiceContext` obtained with the given identifier.

### 21.3.13 *ClientRequestInfo Interface*

```

local interface ClientRequestInfo : RequestInfo {
 readonly attribute Object target;
 readonly attribute Object effective_target;
 readonly attribute IOP::TaggedProfile effective_profile;
 readonly attribute any received_exception;
 readonly attribute CORBA::RepositoryId received_exception_id;
 IOR::TaggedComponent get_effective_component (
 in IOP::ComponentId id);
 IOP::TaggedComponentSeq get_effective_components (
 in IOP::ComponentId id);
 CORBA::Policy get_request_policy (in CORBA::PolicyType type);
 void add_request_service_context (
 in IOP::ServiceContext service_context,
 in boolean replace);
};

```

Some attributes and operations on **ClientRequestInfo** are not valid at all interception points. Table 21-1 shows the validity of each attribute or operation. If it is not valid, attempting to access it will result in a **BAD\_INV\_ORDER** being raised with a standard minor code of 14.

Table 21-1 ClientRequestInfo Validity

|                             | <b>send_request</b> | <b>send_poll</b> | <b>receive_reply</b> | <b>receive_exception</b> | <b>receive_other</b> |
|-----------------------------|---------------------|------------------|----------------------|--------------------------|----------------------|
| request_id                  | yes                 | yes              | yes                  | yes                      | yes                  |
| operation                   | yes                 | yes              | yes                  | yes                      | yes                  |
| arguments                   | yes <sub>1</sub>    | no               | yes                  | no                       | no                   |
| exceptions                  | yes                 | no               | yes                  | yes                      | yes                  |
| contexts                    | yes                 | no               | yes                  | yes                      | yes                  |
| operation_context           | yes                 | no               | yes                  | yes                      | yes                  |
| result                      | no                  | no               | yes                  | no                       | no                   |
| response_expected           | yes                 | yes              | yes                  | yes                      | yes                  |
| sync_scope                  | yes                 | no               | yes                  | yes                      | yes                  |
| reply_status                | no                  | no               | yes                  | yes                      | yes                  |
| forward_reference           | no                  | no               | no                   | no                       | yes <sub>2</sub>     |
| get_slot                    | yes                 | yes              | yes                  | yes                      | yes                  |
| get_request_service_context | yes                 | no               | yes                  | yes                      | yes                  |
| get_reply_service_context   | no                  | no               | yes                  | yes                      | yes                  |
| target                      | yes                 | yes              | yes                  | yes                      | yes                  |
| effective_target            | yes                 | yes              | yes                  | yes                      | yes                  |
| effective_profile           | yes                 | yes              | yes                  | yes                      | yes                  |
| received_exception          | no                  | no               | no                   | yes                      | no                   |
| received_exception_id       | no                  | no               | no                   | yes                      | no                   |
| get_effective_component     | yes                 | no               | yes                  | yes                      | yes                  |
| get_effective_components    | yes                 | no               | yes                  | yes                      | yes                  |
| get_request_policy          | yes                 | no               | yes                  | yes                      | yes                  |
| add_request_service_context | yes                 | no               | no                   | no                       | no                   |

- 1 When **ClientRequestInfo** is passed to **send\_request**, there is an entry in the list for every argument, whether in, inout, or out. But only the in and inout arguments will be available.
- 2 If the **reply\_status** attribute is not **LOCATION\_FORWARD**, accessing this attribute will raise **BAD\_INV\_ORDER** with a standard minor code of 14.

### 21.3.13.1 *target*

This attribute is the object which the client called to perform the operation. See Section 21.3.13.2, “effective\_target,” on page 21-27.

### 21.3.13.2 *effective\_target*

This attribute is the actual object on which the operation will be invoked. If the **reply\_status** is **LOCATION\_FORWARD**, then on subsequent requests, **effective\_target** will contain the forwarded IOR while **target** will remain unchanged.

### 21.3.13.3 *effective\_profile*

This attribute is the profile that will be used to send the request. If a location forward has occurred for this operation’s object and that object’s profile changed accordingly, then this profile will be that located profile.

### 21.3.13.4 *received\_exception*

This attribute is an **any** that contains the exception to be returned to the client.

If the exception is a user exception that cannot be inserted into an any (for example, it is unknown or the bindings don’t provide the **TypeCode**), then this attribute will be an any containing the system exception **UNKNOWN** with a standard minor code of 1. However, the **RepositoryId** of the exception is available in the **received\_exception\_id** attribute.

### 21.3.13.5 *received\_exception\_id*

This attribute is the **CORBA::RepositoryId** of the exception to be returned to the client.

### 21.3.13.6 *get\_effective\_component*

This operation returns the **IOP::TaggedComponent** with the given ID from the profile selected for this request.

If there is more than one component for a given component ID, it is undefined which component this operation returns. If there is more than one component for a given component ID, **get\_effective\_components** should be called instead.

If no component exists for the given component ID, this operation will raise **BAD\_PARAM** with a standard minor code of 28.

**Parameters**

id                      The IOP::ComponentId of the component that is to be returned.

**Return Value**        The IOP::TaggedComponent obtained with the given identifier.

**21.3.13.7 *get\_effective\_components***

This operation returns all the tagged components with the given ID from the profile selected for this request. This sequence is in the form of an **IOP::TaggedComponentSeq**.

If no component exists for the given component ID, this operation will raise **BAD\_PARAM** with a standard minor code of 28.

**Parameters**

id                      The IOP::ComponentId of the components that are to be returned.

**Return Value**        The IOP::TaggedComponentSeq, each component of which contains the given identifier.

**21.3.13.8 *get\_request\_policy***

This operation returns the given policy in effect for this operation.

If the policy type is not valid either because the specified type is not supported by this ORB or because a policy object of that type is not associated with this Object, **INV\_POLICY** with a standard minor code of 2 is raised.

**Parameters**

id                      The CORBA::PolicyType that specifies the policy to be returned.

**Return Value**        The CORBA::Policy obtained with the given type.

**21.3.13.9 *add\_request\_service\_context***

This operation allows Interceptors to add service contexts to the request.



There is no declaration of the order of the service contexts. They may or may not appear in the order that they are added.

#### *Parameters*

|                              |                                                                                                                                                                                                                                                          |
|------------------------------|----------------------------------------------------------------------------------------------------------------------------------------------------------------------------------------------------------------------------------------------------------|
| <code>service_context</code> | The IOP::ServiceContext to be added to the request.                                                                                                                                                                                                      |
| <b>replace</b>               | Indicates the behavior of this operation when a service context already exists with the given ID. If false, then <b>BAD_INV_ORDER</b> with a standard minor code of 15 is raised. If true, then the existing service context is replaced by the new one. |

### 21.3.14 *ServerRequestInfo Interface*

```

local interface ServerRequestInfo : RequestInfo {
 readonly attribute any sending_exception;
 readonly attribute CORBA::OctetSeq object_id;
 readonly attribute CORBA::OctetSeq adapter_id;
 readonly attribute ServerId server_id ;
 readonly attribute ORBId orb_id ;
 readonly attribute AdapterName adapter_name;
 readonly attribute CORBA::RepositoryId
 target_most_derived_interface;
 CORBA::Policy get_server_policy (in CORBA::PolicyType type);
 void set_slot (in SlotId id, in any data) raises (InvalidSlot);
 boolean target_is_a (in CORBA::RepositoryId id);
 void add_reply_service_context (
 in IOP::ServiceContext service_context,
 in boolean replace);
};

```

Some attributes and operations on **ServerRequestInfo** are not valid at all interception points. Table 21-2 shows the validity of each attribute or operation. If it is not valid, attempting to access it will result in a **BAD\_INV\_ORDER** being raised with a standard minor code of 14.

Table 21-2 ServerRequestInfo Validity

|                          | <b>receive_request_service_contexts</b> | <b>receive_request</b> | <b>send_reply</b> | <b>send_exception</b> | <b>send_other</b> |
|--------------------------|-----------------------------------------|------------------------|-------------------|-----------------------|-------------------|
| <b>request_id</b>        | yes                                     | yes                    | yes               | yes                   | yes               |
| <b>operation</b>         | yes                                     | yes                    | yes               | yes                   | yes               |
| <b>arguments</b>         | no                                      | yes <sub>1</sub>       | yes               | no <sub>2</sub>       | no <sub>2</sub>   |
| <b>exceptions</b>        | no                                      | yes                    | yes               | yes                   | yes               |
| <b>contexts</b>          | no                                      | yes                    | yes               | yes                   | yes               |
| <b>operation_context</b> | no                                      | yes                    | yes               | no                    | no                |

Table 21-2 ServerRequestInfo Validity

|                                      | receive_request_service_contexts | receive_request | send_reply      | send_exception   | send_other       |
|--------------------------------------|----------------------------------|-----------------|-----------------|------------------|------------------|
| <b>result</b>                        | no                               | no              | yes             | no               | no               |
| <b>response_expected</b>             | yes                              | yes             | yes             | yes              | yes              |
| <b>sync_scope</b>                    | yes                              | yes             | yes             | yes              | yes              |
| <b>reply_status</b>                  | no                               | no              | yes             | yes              | yes              |
| <b>forward_reference</b>             | no                               | no              | no              | no               | yes <sub>2</sub> |
| <b>get_slot</b>                      | yes                              | yes             | yes             | yes              | yes              |
| <b>get_request_service_context</b>   | yes                              | yes             | yes             | yes              | yes              |
| <b>get_reply_service_context</b>     | no                               | no              | yes             | yes              | yes              |
| <b>sending_exception</b>             | no                               | no              | no              | yes              | no               |
| <b>object_id</b>                     | no                               | yes             | yes             | yes <sub>3</sub> | yes <sub>3</sub> |
| <b>adapter_id</b>                    | no                               | yes             | yes             | yes <sub>3</sub> | yes <sub>3</sub> |
| <b>server_id</b>                     | no                               | yes             | yes             | yes              | yes              |
| <b>orb_id</b>                        | no                               | yes             | yes             | yes              | yes              |
| <b>adapter_name</b>                  | no                               | yes             | yes             | yes              | yes              |
| <b>target_most_derived_interface</b> | no                               | yes             | no <sub>4</sub> | no <sub>4</sub>  | no <sub>4</sub>  |
| <b>get_server_policy</b>             | yes                              | yes             | yes             | yes              | yes              |
| <b>set_slot</b>                      | yes                              | yes             | yes             | yes              | yes              |
| <b>target_is_a</b>                   | no                               | yes             | no <sub>4</sub> | no <sub>4</sub>  | no <sub>4</sub>  |
| <b>add_reply_service_context</b>     | yes                              | yes             | yes             | yes              | yes              |

- 1 When **ServerRequestInfo** is passed to **receive\_request**, there is an entry in the list for every argument, whether in, inout, or out. But only the in and inout arguments will be available.
- 2 If the **reply\_status** attribute is not **LOCATION\_FORWARD**, accessing this attribute will raise **BAD\_INV\_ORDER** with a standard minor code of 14.
- 3 If the servant locator caused a location forward, or raised an exception, this attribute/operation may not be available in this interception point. **NO\_RESOURCES** with a standard minor code of 1 will be raised if it is not available.
- 4 The operation is not available in this interception point because the necessary information requires access to the target object's servant, which may no longer be available to the ORB. For example, if the object's adapter is a POA that uses a **ServantLocator**, then the ORB invokes the interception point after it calls **ServantLocator::postinvoke()**.

#### 21.3.14.1 *sending\_exception*

This attribute is an **any** that contains the exception to be returned to the client.

If the exception is a user exception that cannot be inserted into an any (for example, it is unknown or the bindings don't provide the **TypeCode**), then this attribute will be an any containing the system exception **UNKNOWN** with a standard minor code of 1.

#### 21.3.14.2 *object\_id*

This attribute is the opaque **object\_id** describing the target of the operation invocation.

#### 21.3.14.3 *adapter\_id*

This attribute is the opaque identifier for the object adapter.

#### 21.3.14.4 *server\_id*

The value of the **server\_id** attribute is the value that was passed into the **ORB::init** call (see Section 4.5.1.1, "Server ID," on page 4-26) using the **-ORBServerId** argument when the ORB was created.

#### 21.3.14.5 *orb\_id*

The value of the **orb\_id** attribute is the value that was passed into the **ORB::init** call.

In Java, this is accomplished using the **-ORBid** argument in the **ORB.init** call that created the ORB containing the object adapter that created this template. What happens if the same ORBid is used on multiple **ORB::init** calls in the same server is currently undefined.

#### 21.3.14.6 *adapter\_name*

The **adapter\_name** attribute defines a name for the object adapter that services requests for the invoked object. In the case of the POA, the **adapter\_name** is the sequence of names from the root POA to the POA that services the request. The name of the root POA is the sequence containing only the string "RootPOA".

#### 21.3.14.7 *target\_most\_derived\_interface*

This attribute is the **RepositoryID** for the most derived interface of the servant.

#### 21.3.14.8 *get\_server\_policy*

This operation returns the policy in effect for this operation for the given policy type. The returned **CORBA::Policy** object shall only be a policy whose type was registered via **register\_policy\_factory** (see Section 21.7.2.12, "register\_policy\_factory," on page 21-54).

If a policy for the given type was not registered via **register\_policy\_factory**, this operation will raise **INV\_POLICY** with a standard minor code of 3.

**Parameters**

type                      The CORBA::PolicyType that specifies the policy to be returned.

**Return Value**            The CORBA::Policy obtained with the given policy type.

#### 21.3.14.9 *set\_slot*

This operation allows an Interceptor to set a slot in the **PortableInterceptor::Current** that is in the scope of the request. If data already exists in that slot, it will be overwritten.

If the ID does not define an allocated slot, **InvalidSlot** is raised.

See Section 21.4, “Portable Interceptor Current,” on page 21-33 for an explanation of slots and **PortableInterceptor::Current**.

**Parameters**

id                         The SlotId of the slot.

data                      The data, in the form of an any, to store in that slot.

#### 21.3.14.10 *target\_is\_a*

This operation returns **true** if the servant is the given **RepositoryId**, **false** if it is not.

**Parameters**

id                         The caller wants to know if the servant is this CORBA::RepositoryId.

**Return Value**            Is the servant the given RepositoryId?

#### 21.3.14.11 *add\_reply\_service\_context*

This operation allows Interceptors to add service contexts to the request.

There is no declaration of the order of the service contexts. They may or may not appear in the order that they are added.

#### *Parameters*

|                 |                                                                                                                                                                                                                                                          |
|-----------------|----------------------------------------------------------------------------------------------------------------------------------------------------------------------------------------------------------------------------------------------------------|
| service_context | The IOP::ServiceContext to add to the reply.                                                                                                                                                                                                             |
| replace         | Indicates the behavior of this operation when a service context already exists with the given ID. If false, then <b>BAD_INV_ORDER</b> with a standard minor code of 11 is raised. If true, then the existing service context is replaced by the new one. |

### 21.3.15 *ForwardRequest Exception*

```
exception ForwardRequest {
 Object forward;
};
```

The **ForwardRequest** exception is the means by which an Interceptor can indicate to the ORB that a retry of the request should occur with the new object given in the exception. This behavior of causing a retry only occurs if the ORB receives a **ForwardRequest** from an interceptor. If **ForwardRequest** is raised anywhere else it is passed through the ORB as is normal for a user exception.

If an Interceptor raises a **ForwardRequest** exception in response to a call of an interceptor, no other Interceptors are called for that interception point. The remaining Interceptors in the Flow Stack shall have their appropriate ending interception point called: **receive\_other** on the client, or **send\_other** on the server. The **reply\_status** in the **receive\_other** or **send\_other** shall be **LOCATION\_FORWARD**.

## 21.4 *Portable Interceptor Current*

### 21.4.1 *Overview*

The **PortableInterceptor::Current** object (hereafter referred to as **PICurrent**) is a **Current** object that is used specifically by portable Interceptors to transfer thread context information to a request context. Portable Interceptors are not required to use **PICurrent**. But if information from a client's thread context is required at an Interceptor's interception points, then **PICurrent** can be used to propagate that information. **PICurrent** allows portable service code to be written regardless of an ORB's threading model.

On the client side, this information includes, but is not limited to, thread context information that shall be propagated to the server via a service context.

On the server side, this information includes, but is not limited to, service context information received from the client which is propagated to the target's thread context.

## 21.4.2 Obtaining the Portable Interceptor Current

Before an invocation is made, **PICurrent** is obtained via a call to **ORB::resolve\_initial\_references** (“**PICurrent**”).

From within the interception points, the data on **PICurrent** that has moved from the thread scope to the request scope is available via the **get\_slot** operation on the **RequestInfo** object. A **PICurrent** can still be obtained via **resolve\_initial\_references**, but that is the Interceptor’s thread scope **PICurrent**. See Section 21.4.4.4, “Request Scope vs Thread Scope,” on page 21-38 for a detailed discussion of the scope of **PICurrent**.

## 21.4.3 Portable Interceptor Current Interface

```

module PortableInterceptor {

 typedef unsigned long SlotId;

 exception InvalidSlot {};

 local interface Current : CORBA::Current {
 any get_slot (in SlotId id) raises (InvalidSlot);
 void set_slot (in SlotId id, in any data) raises (InvalidSlot);
 };
};

```

**PICurrent** is merely a slot table, the slots of which are used by each service to transfer their context data between their context and the request’s or reply’s service context. Each service that wishes to use **PICurrent** reserves a slot or slots at initialization time (see Section 21.7.2.11, “allocate\_slot\_id,” on page 21-54) and uses those slots during the processing of requests and replies.

### 21.4.3.1 *get\_slot*

A service can get the slot data it set in **PICurrent** via **get\_slot**. The data is in the form of an **any**.

If the given slot has not been set, an **any** containing a type code with a **TCKind** value of **tk\_null** and no value is returned.

If **get\_slot** is called on a slot that has not been allocated, **InvalidSlot** is raised.



```
PortableInterceptor::SlotId mySlotId =
 orb_init_info.allocate_slot_id ();
```

When a transaction begins, the Transaction's **Current** is called, which can place its context information in a slot on **PICurrent**:

```
any myData = ...; // get data from Transaction's Current
PortableInterceptor::Current pic =
 orb.resolve_initial_references ("PICurrent");
pic.set_slot (mySlotId, myData);
```

When an operation invocation begins, the ORB logically copies **PICurrent** from the thread context to the request context and the slots are available to Interceptors via the **ClientRequestInfo** object. So the transaction service's Interceptor could look like:

```
any myData = info.get_slot (mySlotId);
IOP::ServiceContext sc = ...; // convert myData to a SC
info.add_request_service_context (sc);
```

The request scope **PICurrent** slots are read-only on the client. There is no **set\_slot** on the **ClientRequestInfo** object.

#### 21.4.4.2 Example of PICurrent to Handle Client-side Recursion

If an Interceptor itself makes an operation invocation, it shall have some means of breaking infinite recursion. For example: the client calls operation X; **send\_request** is called, which calls operation Y; **send\_request** is called, which again calls operation Y; and so on unless the implementation of **send\_request** breaks the recursion.

Recursion can be broken using **PICurrent**. If an Interceptor knows it will recurse, it allocates a slot in **PICurrent** in its **ORBInitializer** (see Section 21.7.1, "ORBInitializer Interface," on page 21-51) that it will use for recursion:

```
PortableInterceptor::SlotId recurseId =
 orb_init_info.allocate_slot_id ();
```

At the point at which it recurses, say in **send\_request**, it does so in a manner similar to the following:

```
any recurse = info.get_slot (recurseId);

// if we haven't yet recursed, then the slot will be empty.
if (recurse.type () == tk_null)
{
 // Fill in the recurse slot before making
 // the recursive call.
 any recurseFlag = new any;
 recurseFlag.insert_boolean (true);
 PortableInterceptor::Current pic =
 orb.resolve_initial_references ("PICurrent");
```



```

 pic.set_slot (recurseId, recurseFlag);

 // Now make the recursive call.
 someObject.someOperation ();
 }

```

When a client calls operation X, **send\_request** is invoked for operation X. The recurse slot is empty, so the **if** block is executed: the recurse slot is set to **true** for this thread's **PICurrent** and the recursive call to **someOperation** is made.

**send\_request** is again invoked, this time for **someOperation**. This time the recurse slot is not empty, so the **if** block is not executed and the recursive call is not made, thus breaking the recursion.

### 21.4.4.3 Server-side use of PICurrent

The service contexts associated with the request may be propagated, using **PICurrent**, to the context of the thread that will execute the operation. The request's **PICurrent** is read and written via the **get\_slot** and **set\_slot** operations on **ServerRequestInfo**.

**receive\_request\_service\_contexts** shall populate the slots of the request scope **PICurrent**. The ORB logically copies this **PICurrent** to the thread scope after processing the **receive\_request\_service\_contexts** list.

When the operation invocation completes, the send interception points still have read/write access to the request scope **PICurrent**.

For example, within its **ORBInitializer** (see Section 21.7.1, "ORBInitializer Interface," on page 21-51), the transaction service allocates a slot:

```

PortableInterceptor::SlotId mySlotId =
 orb_init_info.allocate_slot_id ();

```

The Transaction Interceptor can move the transaction information from the service context list to **PICurrent**:

```

IOP::ServiceContext sc =
 info.get_request_service_context (transactionId);
any myData = // convert SC to an any
info.set_slot (mySlotId, myData);

```

Within a server thread, the Transaction service can transfer its information from **PICurrent** to the **TransactionCurrent**:

```

PortableInterceptor::Current pic =
 orb.resolve_initial_references ("PICurrent");
any myData = pic.get_slot (mySlotId);
// Copy myData into the current context.

```

#### 21.4.4.4 *Request Scope vs Thread Scope*

The thread scope **PICurrent** is the **PICurrent** that exists within a thread's context. A request scope **PICurrent** is the **PICurrent** associated with the request. On the client-side, the thread scope **PICurrent** is logically copied to the request scope **PICurrent** from the thread's context when a request begins and is attached to the **ClientRequestInfo** object. On the server-side, the request scope **PICurrent** is attached to the **ServerRequestInfo** and follows the request processing. It is logically copied to the thread scope **PICurrent** after the list of **receive\_request\_service\_contexts** interception points are processed.

#### 21.4.4.5 *Flow of PICurrent between Scopes*

For the following, TSC means Thread Scope **PICurrent**; and RSC means Request Scope **PICurrent**. Refer to Figure 21-7 on page 21-39 for a graphical representation of the following discussion. The numbered points below correspond to the numbers in Figure 21-7.

Before operation invocation, the client thread may read and write the TSC. On an operation invocation, the flow proceeds as follows:

1. The invocation proceeds to the ORB.
2. Before the sending interception points are called, a TSC is logically copied to the request scope.
3. The sending interception points are called. They have read-only access to this RSC. They may add entries to the service context list based on the slot data in the RSC.
4. On the server, an empty RSC is created. Interceptors shall populate this RSC from the service context list in **receive\_request\_service\_contexts**.
5. The ORB logically copies the RSC to the server-side TSC after the **receive\_request\_service\_contexts** points are processed and before the servant manager is called. This TSC is within the context for the **receive\_request** points, the invocation of the servant manager, and the invocation of the target operation. The **receive\_request** points may modify the RSC, but this no longer affects the TSC. The **receive\_request** points are called. These points have access to the RSC - though modifying the RSC at this point has no affect on the TSC. Since these points execute in the same thread as the target operation invocation, these points may modify the server-side TSC.
6. After the **receive\_request** points are called, control transfers to the server threads which may also read and write this server-side TSC.
7. The target operation invocation completes and control returns to the ORB.
8. The TSC from the thread on which the ORB invoked the target operation is copied back to the RSC, overwriting the slots in the RSC.

9. The send interception points have access to this RSC from which they may populate the reply service context list. After the invocation result is sent back to the client, the server-side RSC is logically destroyed.
10. The client receives the reply. The Interceptors may read the service contexts associated with the reply. They also have readonly access to the RSC was seen by the send interception points.
11. The invocation returns to the client. When the request completes, the client-side RSC is logically destroyed.

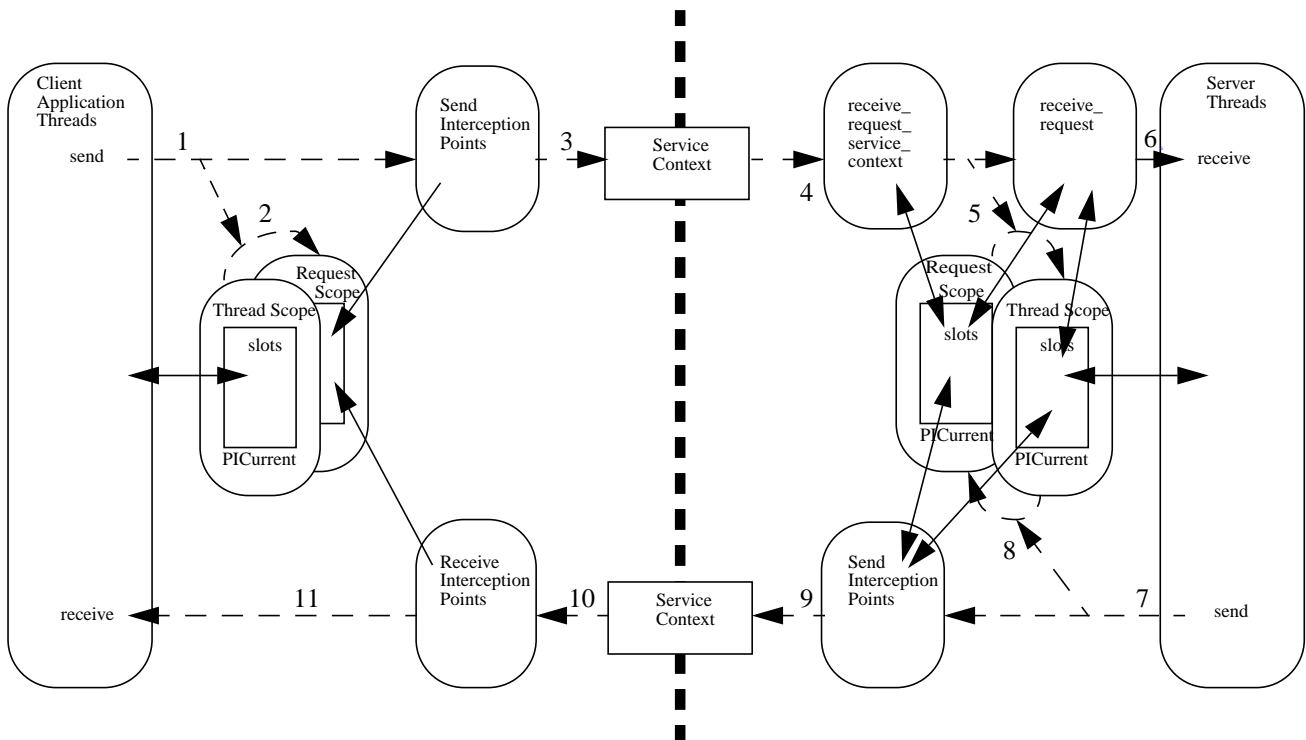

Figure 21-7 Thread Scope vs Request Scope

#### Figure 21-7 Legend

- Dotted Line      Flow of control (between the thread scopes and the request scopes, the dotted arrows indicate a logical copy).
- Solid Line      Access; single arrow is readonly, double arrow is read/write.
- Thick Dotted Line      Boundary between client and server.

#### 21.4.4.6 Notes on PICurrent and Scopes

Since an Interceptor is running in a thread, it is running with a thread context and there is a **PICurrent** on that context. If the Interceptor calls **ORB::resolve\_initial\_references ("PICurrent")**, it gets the **PICurrent** within its thread scope. This **PICurrent** is different than the request scope **PICurrent** that the Interceptor obtains via calls to the **Client-** or **Server- RequestInfo** object. So if an

Interceptor makes an operation call, it is the Interceptor's thread scope **PICurrent** that will be logically copied to the request scope of that operation, not the **PICurrent** from the original operation invocation.

Even if a client-side Interceptor happens to be running in the same thread from which the invocation was made (this is vendor dependent), the request scope **PICurrent** and the thread scope **PICurrent** are still different. The request scope **PICurrent** is a copy of the thread scope **PICurrent** at the point when the invocation began. So even if an Interceptor changed the data in its thread scope **PICurrent**, that does not change the request scope **PICurrent**.

Interceptors shall assume that each client-side interception point logically runs in its own thread, with no context relationship between it and any other thread. While an ORB implementation may not actually behave in this manner, it is up to the ORB implementation to treat **PICurrent** as if it did.

Interceptors shall assume that all server-side interception points except **receive\_request\_service\_contexts** run in the same thread as the target operation invocation, thereby sharing thread context information. **receive\_request\_service\_contexts**, like all client-side interception points, logically runs in its own thread, with no context relationship between it and any other thread.

## 21.5 IOR Interceptor

### 21.5.1 Overview

In some cases, a portable ORB service implementation may need to add information describing the server's or object's ORB service related capabilities to object references in order to enable the ORB service implementation in the client to function properly.

This is supported through the **IORInterceptor** and **IORInfo** interfaces.

The IOR Interceptor is used to establish tagged components in the profiles within an IOR.

### 21.5.2 An Abstract Model for Object Adapters

Using the **IORInterceptor** to support the object reference template imposes certain requirements on Object Adapters. While the **POA** is the only (current) standard object adapter, it is deemed inappropriate to impose the **POA** architecture on all possible proprietary object adapters. Consequently only the abstract properties that are required, and how these map to the particular case of the POA, are presented here.

Object Adapters have the following requirements:

- They have a unique name so that different instances of a particular object adapter may be identified.

- Object adapters typically have some kind of request processing state to indicate whether the adapter is currently accepting, rejecting, or performing some other kind of action on incoming requests. There is some representation of adapter instance state so that a server activation framework built on the object reference template can correctly process requests as the adapter instances states change.
- If an object adapter supports large numbers of adapter instances, reporting state changes that affect a number of adapter instances simultaneously could be expensive in the amount of data required. The POA has the concept of an adapter manager (the **POAManager**) that controls the state of a number of **POA** instances. They must have an abstract adapter manager that can be used for reporting relevant state changes.

### 21.5.2.1 Adapter Names

If an Object Adapter supports multiple adapter instances, there is a need for some kind of adapter name to distinguish the instances. For this purpose, an adapter name is defined as a sequence of strings. Several interpretations of an adapter name are possible:

- If the Object Adapter supports only a single instance, a fixed name can be used.
- If the namespace for an Object Adapter is flat, sequences of length 1 can be used.
- If the namespace is hierarchical (e.g., the POA), a more complex name sequence can be used.

In the case of the POA, the adapter name shall be the sequence of names starting with the root POA that is required to reach the POA using the **find\_POA** call. The name of the root POA is the sequence containing only the string “RootPOA”.

### 21.5.2.2 Adapter States

Object adapters may be in one of several states that describe how the adapter behaves when a new request is dispatched to the adapter:

|                |                                                                                                                                                                                                                                                                                     |
|----------------|-------------------------------------------------------------------------------------------------------------------------------------------------------------------------------------------------------------------------------------------------------------------------------------|
| <b>HOLDING</b> | The request is held off temporarily in response to a transient resource limit or a application program request. An IMR could either choose to forward the request to the server and let the server hold it off, or else to hold off the request at the IMR until the state changes. |
| <b>ACTIVE</b>  | The request is dispatched to the servant and processed. An IMR should forward the request to the server in this case.                                                                                                                                                               |

|                     |                                                                                                                                                                                                                                                                                           |
|---------------------|-------------------------------------------------------------------------------------------------------------------------------------------------------------------------------------------------------------------------------------------------------------------------------------------|
| <b>DISCARDING</b>   | The request is discarded. This is indicated to the client with some kind of error. An IMR could either forward the request to the server, or else reject the request directly. The POA specification requires that a TRANSIENT/1 system exception be returned to the client in this case. |
| <b>INACTIVE</b>     | The request is discarded. The adapter is in the process of shutting down, and will eventually end up in the <b>NON_EXISTENT</b> state. An IMR could reject the request directly, typically with an OBJ_ADAPTER/1 error.                                                                   |
| <b>NON_EXISTENT</b> | The adapter has been destroyed. The IMR should attempt to reactivate the server and adapter as necessary to satisfy the request. The IMR should hold off the request until the adapter becomes active again.                                                                              |

In the case of the **POA**, **HOLDING**, **ACTIVE**, **DISCARDING**, and **INACTIVE** map to the same named states of the POAManager. **NON\_EXISTENT** does not map directly to a particular **POAManager** state, but is used to indicate that a **POA** has been destroyed. A **POA** whose state is **INACTIVE** will transition to state **NON\_EXISTENT** after the destruction process has completed.

While non-POA adapters may have different detailed states than the POA, it should be possible to map other adapter's states onto a subset of the above states.

### 21.5.2.3 Adapter Managers

Some object adapters have a concept of a group of adapters that undergo state transitions together. In such cases it is useful to capture the grouping abstractly. We define the *adapter manager* to represent this grouping. The only standard attribute of the adapter manager is the adapter manager id, which is an opaque id. This ID serves to distinguish different adapter manager instances, and to associate an adapter manager instance with its adapter instances. The adapter manager id is only locally significant within the ORB instance that defines the adapter manager. The id is transient, and can be compared for equality within the defining ORB instance. All adapter instances that share the same adapter manager must have the same adapter manager id.

Use of an adapter manager allows state transitions for all adapters managed by the same adapter manager to be efficiently reported. The only assumption made about the semantics of an adapter manager is that a state change reported for an adapter manager is reflected in all adapter instances managed by the adapter manager.

In the case of the **POA**, the **POAManager** is an adapter manager.

### 21.5.2.4 Adapter State Changes

Some adapters may support mechanisms independent of the adapter manager for changing states. In such cases, a means needs to be provided for reporting the state changes.

In the case of the POA, a subtree of POAs may all transition to the **NON\_EXISTENT** state as a result of the **POA::destroy** call.

### 21.5.3 Object Reference Template

#### 21.5.3.1 Definition

The Object Reference Template is defined in IDL as an abstract valuetype.

An object reference template is associated with an object adapter. Typically the template is created when the object adapter is created, used within the adapter to create object references, and destroyed when the adapter is destroyed. Different adapters may support very different styles of object creation.

The object reference template is defined as follows:

```

module PortableInterceptor {
 typedef string ServerId ;
 typedef string ORBId ;
 typedef CORBA::StringSeq AdapterName ;
 typedef CORBA::OctetSeq ObjectId ;

 abstract valuetype ObjectReferenceFactory {
 boolean equals(in ObjectReferenceFactory other) ;
 Object make_object(in string repositoryId, in ObjectId id) ;
 IOP::TaggedProfileSeq make_profiles(
 in string repository_id,
 in ObjectId id) ;
 };

 abstract valuetype ObjectReferenceTemplate :
 ObjectReferenceFactory {
 readonly attribute ServerId server_id ;
 readonly attribute ORBId orb_id ;
 readonly attribute AdapterName adapter_name;
 };

 typedef sequence<ObjectReferenceTemplate>
 ObjectReferenceTemplateSeq;
};

```

The **ObjectReferenceFactory** valuetype provides the capability to create new object references, while the **ObjectReferenceTemplate** valuetype extends the factory capability with the identity of the template. This division is convenient because the **current\_factory** attribute in IORInfo (see Section 21.5.5, “IORInfo Interface,” on page 21-46) only requires the capability to create an object reference, while the **adapter\_template** attribute (also in Section 21.5.5) also requires identity information.

Concrete definitions and implementations of **ObjectReferenceTemplate** and **ObjectReferenceFactory** are ORB implementation specific and are not defined as they are not expected to be exchanged between ORB implementations.

### 21.5.3.2 *The ObjectReferenceFactory abstract valuetype*

The **ObjectReferenceFactory** provides only the capability to create an object reference. Note that a factory is immutable: after it has been created, it cannot be modified.

Also, note that it is possible to create a concrete valuetype (unknown to the ORB implementation) that subclasses the **ObjectReferenceFactory** valuetype, and to use this factory in the IOR interceptor as **current\_factory** (see Section 21.5.5.7, “current\_factory,” on page 21-49). In such cases, the implementation must either be immutable after it is created, or the implementation must not change the behavior of **make\_object**. Failure to observe this requirement may result in undefined behavior.

### 21.5.3.3 *make\_object*

**make\_object** creates an Object Reference from this factory using the given repository ID and object ID.

### 21.5.3.4 *make\_profiles*

**make\_profiles** returns the sequence of tagged profiles for the IOR that corresponds to the object reference that would be created by a call to **make\_object** with the same arguments.

### 21.5.3.5 *equals*

**equals** satisfies the usual reflexive, symmetric, and transitive properties that equality normally respects. That is, for any **ObjectReferenceFactories X, Y, and Z**:

1. **X.equals( X ) = TRUE**
2. **X.equals( Y ) = Y.equals( X )**
3. if **X.equals( Y ) = TRUE** and **Y.equals( Z ) = TRUE**, then **X.equals( Z ) = TRUE**

If **X** and **Y** are different object adapters, and **Xinfo** and **Yinfo** are the **IORInfo** objects passed to the **IORInterceptor**, then

**Xinfo.adapter\_template().equals(Yinfo.adapter\_template() ) = FALSE.**

An **equals** method on a user defined **ObjectReferenceFactory** must return **FALSE** when passed the value of an **IORInfo.adapter\_template** attribute, unless the user defined **make\_profiles** method returns the same **ProfileSeq** as the **adapter\_template make\_profiles** method when invoked with the same arguments, in which case the user defined **ObjectReferenceFactory equals** method may return **TRUE**.



### 21.5.3.6 *The ObjectReferenceTemplate abstract valuetype*

The **ObjectReferenceTemplate** extends the **ObjectReferenceFactory** with the identity of the object adapter. Note that the template, like the factory, is immutable: after it has been created, it cannot be modified.

### 21.5.3.7 *server\_id*

The value of the **server\_id** attribute is the value that was passed into the **ORB::init** call (see Section 4.5.1.1, “Server ID,” on page 4-26) using the **-ORBServerId** argument when the ORB was created.

### 21.5.3.8 *orb\_id*

The value of the **orb\_id** attribute is the value that was passed into the **ORB::init** call.

In Java, this is accomplished using the **-ORBid** argument in the **ORB.init** call that created the ORB containing the object adapter that created this template. What happens if the same ORBid is used on multiple **ORB::init** calls in the same server is currently undefined.

### 21.5.3.9 *adapter\_name*

The **adapter\_name** attribute defines a name for the object adapter that services requests for the invoked object.

## 21.5.4 *IORInterceptor Interface*

```

local interface IORInterceptor : Interceptor {
 void establish_components (in IORInfo info);
};
local interface IORInterceptor_3_0 : IORInterceptor {
 void components_established(in IORInfo info) ;

 void adapter_manager_state_changed(in AdapterManagerId id,
 in AdapterState state);

 void adapter_state_changed(in ObjectReferenceTemplateSeq
 templates, in AdapterState state) ;
};

```

### 21.5.4.1 *establish\_components*

A server side ORB calls the **establish\_components** operation on all registered **IORInterceptor** instances when it is assembling the list of components that will be included in the profile or profiles of an object reference. This operation is not necessarily called for each individual object reference. In the case of the POA, these calls are made each time **POA::create\_POA** is called. In other adapters, these calls

would typically be made when the adapter is initialized. The adapter template is not available at this stage since information (the components) needed in the adapter template is being constructed.

An implementation of **establish\_components** must not throw exceptions. If it does, the ORB shall ignore the exception and proceed to call the next IOR Interceptor's **establish\_components** operation.

#### *Parameters*

**info**                      The IORInfo instance used by the ORB service to query applicable policies and add components to be included in the generated IORs.

#### *21.5.4.2 components\_established*

After all of the **establish\_components** methods have been called, the **components\_established** methods are called on all registered IORInterceptor\_3\_0 instances. The adapter template is available at this stage. The **current\_factory** attribute may be get or set at this stage.

Any exception that occurs in **components\_established** is returned to the caller of **components\_established**. In the case of the POA, this causes the **create\_POA** call to fail, and an **OBJ\_ADAPTER** exception with a standard minor code of 6 is returned to the invoker of **create\_POA**.

#### *21.5.4.3 adapter\_manager\_state\_changed*

Any time the state of an adapter manager changes, the **adapter\_manager\_state\_changed** method is invoked on all registered IORInterceptor\_3\_0 instances. If a state change is reported through **adapter\_manager\_state\_changed**, it is not reported through **adapter\_state\_changed**.

#### *21.5.4.4 adapter\_state\_changed*

Adapter state changes unrelated to adapter manager state changes are reported by invoking the **adapter\_state\_changed** method on all registered IORInterceptor\_3\_0 instances. The templates argument identifies the object adapters that have changed state by the template ID information. The sequence contains the adapter templates for all object adapters that have made the state transition being reported.

### *21.5.5 IORInfo Interface*

The **IORInfo** interface provides the server-side ORB service with access to the applicable policies during IOR construction and the ability to add components. The ORB passes an instance of its implementation of this interface as a parameter to **IORInterceptor::establish\_components**.

```

typedef string AdapterManagerId;

typedef short AdapterState ;
const AdapterState HOLDING = 0 ;
const AdapterState ACTIVE = 1 ;
const AdapterState DISCARDING = 2 ;
const AdapterState INACTIVE = 3 ;
const AdapterState NON_EXISTENT = 4 ;

local interface IORInfo {
 CORBA::Policy get_effective_policy (in CORBA::PolicyType type);
 void add_ior_component
 (in IOP::TaggedComponent a_component);
 void add_ior_component_to_profile (
 in IOP::TaggedComponent a_component,
 in IOP::ProfileId profile_id);
 readonly attribute AdapterManagerId manager_id;
 readonly attribute AdapterState state;
 readonly attribute ObjectReferenceTemplate adapter_template ;
 attribute ObjectReferenceFactory current_factory ;
};

```

All object adapter implementations provide some mechanism for creating object references. The construction of the object reference is influenced by all of the applicable server-side policies, which are used while assembling the tagged components required for the object reference. The IOR interceptors also influence the tagged components through the **IORInfo::add\_component** and **IORInfo::add\_component\_to\_profile** methods. After all of this construction has completed, the adapter conceptually has a template that can be used to create object references. We will refer to this template as the *adapter template*.

For example, in the POA, after **POA::create\_POA** method has completed, there is a complete template in the POA that will be used to create individual object references when **create\_reference** or any other method is called that needs to create an object reference.

#### 21.5.5.1 *get\_effective\_policy*

An ORB service implementation may determine what server side policy of a particular type is in effect for an IOR being constructed by calling the **get\_effective\_policy** operation. When the IOR being constructed is for an object implemented using a POA, all Policy objects passed to the **PortableServer::POA::create\_POA** call that created that POA are accessible via **get\_effective\_policy**.

If a policy for the given type is not known to the ORB, then this operation will raise **INV\_POLICY** with a standard minor code of 3.

**Parameters**

type                      The CORBA::PolicyType specifying the type of policy to return.

**Return Value**

The effective CORBA::Policy object of the requested type. If the given policy type is known, but no policy of that type is in effect, then this operation will return a nil object reference.

**21.5.5.2 add\_ior\_component**

A portable ORB service implementation calls **add\_ior\_component** from its implementation of **establish\_components** to add a tagged component to the set that will be included when constructing IORs. The components in this set will be included in all profiles.

Any number of components may exist with the same component ID.

**Parameters**

a\_component              The IOP::TaggedComponent to add.

**21.5.5.3 add\_ior\_component\_to\_profile**

A portable ORB service implementation calls **add\_ior\_component\_to\_profile** from its implementation of **establish\_components** to add a tagged component to the set that will be included when constructing IORs. The components in this set will be included in the specified profile.

Any number of components may exist with the same component ID.

If the given profile ID does not define a known profile or it is impossible to add components to that profile, **BAD\_PARAM** is raised with a standard minor code of 29.

| Parameters  | Description                                                              |
|-------------|--------------------------------------------------------------------------|
| a_component | The IOP::TaggedComponent to add.                                         |
| profile_id  | The IOP::ProfileId of the profile to which this component will be added. |

**21.5.5.4 manager\_id**

The **manager\_id** attribute provides an opaque handle to the manager of the adapter. This is used for reporting state changes in adapters managed by the same adapter manager.

### 21.5.5.5 *state*

The **state** attribute returns the current state of the adapter. This must be one of HOLDING, ACTIVE, DISCARDING, INACTIVE, NON\_EXISTENT.

### 21.5.5.6 *adapter\_template*

The **adapter\_template** attribute provides a means to obtain an object reference template whenever an ior interceptor is invoked. There is no standard way to directly create an object reference template. The value of **adapter\_template** is the template created for the adapter policies and IOR interceptor calls to **add\_component** and **add\_component\_to\_profile**. The value of the **adapter\_template** attribute is never changed for the lifetime of the object adapter.

### 21.5.5.7 *current\_factory*

The **current\_factory** attribute provides access to the factory that will be used by the adapter to create object references. **current\_factory** initially has the same value as the **adapter\_template** attribute, but this can be changed by setting **current\_factory** to another factory. All object references created by the object adapter must be created by calling the **make\_object** method on **current\_factory**.

The value of the **current\_factory** attribute that is used by the adapter can only be set during the call to the **components\_established** method.

### 21.5.5.8 *Method Validity*

The following table defines the validity of each attribute or operation in **IORInfo** in the methods defined in the **IORInterceptor**:

Table 21-3 IORInfo validity

|                          | establish_components | components_established |
|--------------------------|----------------------|------------------------|
| get_effective_policy     | yes                  | yes                    |
| add_component            | yes                  | no                     |
| add_component_to_profile | yes                  | no                     |
| read manager_id          | yes                  | yes                    |
| read state               | yes                  | yes                    |
| read adapter_template    | no                   | yes                    |
| read current_factory     | no                   | yes                    |
| write current_factory    | no                   | yes                    |

If an illegal call is made to an attribute or operation in **IORInfo**, the **BAD\_INV\_ORDER** system exception is raised with a standard minor code value of 14.

## 21.6 PolicyFactory

### 21.6.1 PolicyFactory Interface

A portable ORB service implementation registers an instance of the **PolicyFactory** interface during ORB initialization (see Section 21.7.2.12, “register\_policy\_factory,” on page 21-54) in order to enable its policy types to be constructed using **CORBA::ORB::create\_policy**. The POA is required to preserve any policy that is registered with **ORBInitInfo** in this manner.

```

module PortableInterceptor
{
 local interface PolicyFactory {
 CORBA::Policy create_policy (
 in CORBA::PolicyType type,
 in any value)
 raises (CORBA::PolicyError);
 };
};

```

#### 21.6.1.1 create\_policy

The ORB calls **create\_policy** on a registered **PolicyFactory** instance when **CORBA::ORB::create\_policy** is called for the **PolicyType** under which the **PolicyFactory** has been registered. The **create\_policy** operation then returns an instance of the appropriate interface derived from **CORBA::Policy** whose value corresponds to the specified **any**. If it cannot, it shall raise an exception as described for **CORBA::ORB::create\_policy**.

| Parameters          | Description                                                               |
|---------------------|---------------------------------------------------------------------------|
| type                | A <b>CORBA::PolicyType</b> specifying the type of policy being created.   |
| value               | An any containing data with which to construct the <b>CORBA::Policy</b> . |
| <b>Return Value</b> | A <b>CORBA::Policy</b> object of the specified type and value.            |

## 21.7 Registering Interceptors

Interceptors are intended to be a means by which ORB services gain access to ORB processing, effectively becoming part of the ORB. Since Interceptors are part of the ORB, when **ORB\_init** returns an ORB, the Interceptors shall have been registered. Interceptors cannot be registered on an ORB after it has been returned by a call to **ORB\_init**.

### 21.7.1 ORBInitializer Interface

An Interceptor is registered by registering an associated **ORBInitializer** object that implements the **ORBInitializer** interface. When an ORB is initializing, it shall call each registered **ORBInitializer**, passing it an **ORBInitInfo** object, which is used to register its Interceptor.

```
module PortableInterceptor {
 local interface ORBInitializer {
 void pre_init (in ORBInitInfo info);
 void post_init (in ORBInitInfo info);
 };
};
```

#### 21.7.1.1 pre\_init

This operation is called during ORB initialization. If it is expected that initial services registered by an interceptor will be used by other interceptors, then those initial services shall be registered at this point via calls to **ORBInitInfo::register\_initial\_reference**.

| Parameter | Description                                                                                                       |
|-----------|-------------------------------------------------------------------------------------------------------------------|
| info      | See below. This object provides initialization attributes and operations by which Interceptors can be registered. |

#### 21.7.1.2 post\_init

This operation is called during ORB initialization. If a service must resolve initial references as part of its initialization, it can assume that all initial references will be available at this point.

Calling the **post\_init** operations is not the final task of ORB initialization. The final task, following the **post\_init** calls, is attaching the lists of registered interceptors to the ORB. Therefore, the ORB does not contain the interceptors during calls to **post\_init**. If an ORB-mediated call is made from within **post\_init**, no request interceptors will be invoked on that call. Likewise, if an operation is performed that causes an IOR to be created, no IOR interceptors will be invoked.

| Parameters | Description                                                                                                       |
|------------|-------------------------------------------------------------------------------------------------------------------|
| info       | See below. This object provides initialization attributes and operations by which Interceptors can be registered. |

### 21.7.2 ORBInitInfo Interface

```
module PortableInterceptor {
 local interface ORBInitInfo {
 typedef string ObjectId;
```

```
 exception DuplicateName {
 string name;
 };
 exception InvalidName {};

 readonly attribute CORBA::StringSeq arguments;
 readonly attribute string orb_id;
 readonly attribute IOP::CodecFactory codec_factory;

 void register_initial_reference (in ObjectId id, in Object obj)
 raises (InvalidName);
 Object resolve_initial_references (
 in ObjectId id) raises (InvalidName);
 void add_client_request_interceptor (
 in ClientRequestInterceptor interceptor)
 raises (DuplicateName);
 void add_server_request_interceptor (
 in ServerRequestInterceptor interceptor)
 raises (DuplicateName);
 void add_ior_interceptor (in IORInterceptor interceptor)
 raises (DuplicateName);
 SlotId allocate_slot_id ();
 void register_policy_factory (
 in CORBA::PolicyType type,
 in PolicyFactory policy_factory);
};
```

### 21.7.2.1 *DuplicateName Exception*

Only one Interceptor of a given name can be registered with the ORB for each Interceptor type. If an attempt is made to register a second Interceptor with the same name, **DuplicateName** is raised.

An Interceptor may be anonymous; that is, have an empty string as the name attribute. Any number of anonymous Interceptors may be registered with the ORB so, if the Interceptor being registered is anonymous, the registration operation will not raise **DuplicateName**.

### 21.7.2.2 *InvalidName Exception*

This exception is raised by **register\_initial\_reference** and **resolve\_initial\_references**.

**register\_initial\_reference** raises **InvalidName** if:

- this operation is called with an empty string id; or
- this operation is called with an id that is already registered, including the default names defined by OMG.



**resolve\_initial\_references** raises **InvalidName** if the name to be resolved is invalid.

### 21.7.2.3 *arguments*

This attribute contains the arguments passed to **ORB\_init**. They may or may not contain the ORB's arguments.

### 21.7.2.4 *orb\_id*

This attribute is the ID of the ORB being initialized.

### 21.7.2.5 *codec\_factory*

This attribute is the **IOP::CodecFactory**. The **CodecFactory** is normally obtained via a call to **ORB::resolve\_initial\_references ("CodecFactory")**, but since the ORB is not yet available and Interceptors, particularly when processing service contexts, will require a **Codec**, a means of obtaining a **Codec** is necessary during ORB initialization.

### 21.7.2.6 *register\_initial\_reference*

This operation is identical to **ORB::register\_initial\_reference** described there. This same functionality exists here because the ORB, not yet fully initialized, is not yet available but initial references may need to be registered as part of Interceptor registration. The only difference is that the version of this operation on the ORB uses PIDL (**CORBA::ORB::ObjectId** and **CORBA::ORB::InvalidName**) whereas the version in this interface uses IDL defined in this interface; the semantics are identical.

### 21.7.2.7 *resolve\_initial\_references*

See Section 21.7, "Registering Interceptors," on page 21-50. This operation is only valid during **post\_init**. It is identical to **ORB::resolve\_initial\_references**. This same functionality exists here because the ORB, not yet fully initialized, is not yet available but initial references may be required from the ORB as part of Interceptor registration. The only difference is that the version of this operation on the ORB uses PIDL (**CORBA::ORB::ObjectId** and **CORBA::ORB::InvalidName**) whereas the version in this interface uses IDL defined in this interface; the semantics are identical.

### 21.7.2.8 *add\_client\_request\_interceptor*

This operation is used to add a client-side request Interceptor to the list of client-side request Interceptors.

If a client-side request Interceptor has already been registered with this Interceptor's name, **DuplicateName** is raised.

| Parameter   | Description                               |
|-------------|-------------------------------------------|
| interceptor | The ClientRequestInterceptor to be added. |

### 21.7.2.9 *add\_server\_request\_interceptor*

This operation is used to add a server-side request Interceptor to the list of server-side request Interceptors.

If a server-side request Interceptor has already been registered with this Interceptor's name, **DuplicateName** is raised.

| Parameter   | Description                               |
|-------------|-------------------------------------------|
| interceptor | The ServerRequestInterceptor to be added. |

### 21.7.2.10 *add\_ior\_interceptor*

This operation is used to add an IOR Interceptor to the list of IOR Interceptors.

If an IOR Interceptor has already been registered with this Interceptor's name, **DuplicateName** is raised..

| Parameter   | Description                     |
|-------------|---------------------------------|
| interceptor | The IORInterceptor to be added. |

### 21.7.2.11 *allocate\_slot\_id*

A service calls **allocate\_slot\_id** to allocate a slot on **PortableInterceptor::Current**.

Note that while slot ids can be allocated within an ORB initializer, the slots themselves cannot be initialized. Calling **set\_slot** or **get\_slot** on the **PICurrent** (see Section 21.4, "Portable Interceptor Current," on page 21-33) within an ORB initializer shall raise a **BAD\_INV\_ORDER** with a minor code of 14.

| Return Value | Description                                    |
|--------------|------------------------------------------------|
|              | The index to the slot that has been allocated. |

### 21.7.2.12 *register\_policy\_factory*

Register a **PolicyFactory** for the given **PolicyType**.

If a **PolicyFactory** already exists for the given **PolicyType**, **BAD\_INV\_ORDER** is raised with a standard minor code of 16.

| Parameters     | Description                                                |
|----------------|------------------------------------------------------------|
| type           | The CORBA::PolicyType that the given PolicyFactory serves. |
| policy_factory | The factory for the given CORBA::PolicyType.               |

### 21.7.3 *register\_orb\_initializer* Operation

To register an **ORBInitializer**, a new operation is provided: **register\_orb\_initializer**. This operation, like **ORB\_init**, is PIDL and is not part of any interface. It resides in the **PortableInterceptor** module.

```
void register_orb_initializer (in ORBInitializer init);
```

Each service that implements Interceptors will provide an instance of **ORBInitializer**. To use a service, an application would first call **register\_orb\_initializer**, passing in the service's **ORBInitializer**. After this is complete, the application would make an instantiating **ORB\_init** call. (An instantiating **ORB\_init** call is one that produces a new ORB. In other words, one that is not passed the ID of an existing ORB.) This instantiating **ORB\_init** call calls each registered **ORBInitializer**. The returned ORB will contain any Interceptors that the given service requires.

**register\_orb\_initializer** is a global operation. An **ORBInitializer** registered at a given point in time will be called by all instantiating **ORB\_init** calls that occur after that point in time. No ORB instantiated before that point in time will be affected by that **ORBInitializer**. Moreover, if **register\_orb\_initializer** is called from within an initializer, the initializer registered by that call will not be called for the ORB currently being initialized. That initializer will only be invoked on an ORB instantiated at a later time.

#### 21.7.3.1 *Mappings of register\_orb\_initializer*

**C++**

The **register\_orb\_initializer** method is defined in the **PortableInterceptor** name space as:

```
namespace PortableInterceptor {
 static void register_orb_initializer (
 PortableInterceptor::ORBInitializer_ptr init);
};
```

**Java**

The **register\_orb\_initializer** operation, since it is global, would break applet security with respect to the ORB. So, in Java, instead of registering **ORBInitializers** via **register\_orb\_initializer**, **ORBInitializers** are registered via Java ORB properties.

### *New Property Set*

The new property names are of the form:

```
org.omg.PortableInterceptor.ORBInitializerClass.<Service>
```

where <Service> is the string name of a class, which implements

```
org.omg.PortableInterceptor.ORBInitializer.
```

To avoid name collisions, the reverse DNS name convention should be used. For example, if company X has three initializers, it could define the following properties:

```
org.omg.PortableInterceptor.ORBInitializerClass.com.x.Init1
org.omg.PortableInterceptor.ORBInitializerClass.com.x.Init2
org.omg.PortableInterceptor.ORBInitializerClass.com.x.Init3
```

During `ORB.init`, these ORB properties that begin with `org.omg.PortableInterceptor.ORBInitializerClass` shall be collected, the <Service> portion of each property shall be extracted, an object shall be instantiated with the <Service> string as its class name, and the `pre_init` and `post_init` methods shall be called on that object. If there are any exceptions, the ORB shall ignore them and proceed.

### *Example*

A client-side logging service written by company X, for example, may have the following `ORBInitializer` implementation:

```
package com.x.logging;

import org.omg.PortableInterceptor.Interceptor;
import org.omg.PortableInterceptor.ORBInitializer;
import org.omg.PortableInterceptor.ORBInitInfo;

public class LoggingService implements ORBInitializer
{
 void pre_init (ORBInitInfo info)
 {
 // Instantiate the Logging Service's Interceptor.
 Interceptor interceptor = new LoggingInterceptor ();

 // Register the Logging Service's Interceptor.
 info.add_client_request_interceptor (interceptor);
 }

 void post_init (ORBInitInfo info)
 {
 // This service does not need two init points.
 }
}
```

To run a program called **MyApp** using this logging service, the user could type:

```
java
-Dorg.omg.PortableInterceptor.ORBInitializerClass.com.x.
Logging.LoggingService MyApp
```

#### *Ada*

For the Ada mapping, a new child library procedure is defined to register **ORBInitializers**:

```
procedure PortableInterceptor.ORBInitializer.Register
 (Init: in PortableInterceptor.ORBInitializer.Local_Ref);
```

### 21.7.4 Notes about Registering Interceptors

Request Interceptors are registered on a per-ORB basis.

To achieve virtual per-object Interceptors, query the policies on the target from within the interception points to determine whether they should do any work.

To achieve virtual per-POA Interceptors, instantiate each POA with a different ORB.

While Interceptors may be ordered administratively, there is no concept of order with respect to the registration of Interceptors. Request Interceptors are concerned with service contexts. Service contexts have no order, so there is no purpose for request Interceptors to have an order. IOR Interceptors are concerned with tagged components. Tagged components also have no order, so there is no purpose for IOR Interceptors to have an order.

Registration code should avoid using the ORB; that is, calling **ORB\_init** with the provided **orb\_id**. Since registration occurs during ORB initialization, results of invocations on this ORB while it is in this state are undefined.

The **ORBInitInfo** object is only valid during **ORB\_init**. If a service keeps a reference to its **ORBInitInfo** object and tries to use it after **ORB\_init** returns, the object no longer exists and an **OBJECT\_NOT\_EXIST** exception shall be raised.

## 21.8 Dynamic Initial References

There are a set number of objects that a call to **ORB::resolve\_initial\_references** is able to return. However, vendors and applications may wish to add additional initial references. The lifecycle of these additional references coincides with the lifecycle of the ORB.

### 21.8.1 register\_initial\_reference

An operation is available in the ORB interface:

```
void register_initial_reference (in ObjectId id, in Object obj)
```

**raises (InvalidName);**

If this operation is called with an id, “Y”, and an object, YY, then a subsequent call to **ORB::resolve\_initial\_references (“Y”)** will return object YY.

InvalidName is raised if:

- this operation is called with an empty string id; or
- this operation is called with an id that is already registered, including the default names defined by OMG.

If the **Object** parameter is null, **BAD\_PARAM** will be raised with a standard minor code of 27.

| Parameters | Description                                          |
|------------|------------------------------------------------------|
| id         | The ID by which the initial reference will be known. |
| obj        | The initial reference itself.                        |

See also Section 21.7.2.6, “register\_initial\_reference,” on page 21-53.

## 21.9 Module Dynamic

In order to keep the portable Interceptor IDL from becoming PIDL, we provide IDL types that correspond to PIDL types for that subset of PIDL that the portable Interceptors use. We have chosen to place these new types in a module called **Dynamic** since it is the dynamic interface sections that define the PIDL that the portable Interceptors use.

### 21.9.1 NVList PIDL Represented by ParameterList IDL

```

struct Parameter {
 any argument;
 CORBA::ParameterMode mode;
};
typedef sequence<Parameter> ParameterList;

```

### 21.9.2 ContextList PIDL Represented by ContextList IDL

```

typedef CORBA::StringSeq ContextList;

```

### 21.9.3 ExceptionList PIDL Represented by ExceptionList IDL

```

typedef sequence<CORBA::TypeCode> ExceptionList;

```

### 21.9.4 Context PIDL Represented by RequestContext IDL

Context objects are encoded as **sequence<string>**. The strings occur in pairs. The first string in each pair is the context property name and the second string in each pair is the associated value.

```
typedef CORBA::StringSeq RequestContext;
```

## 21.10 Consolidated IDL

### 21.10.1 Dynamic

```
// IDL
// File: Dynamic.idl
#ifndef _DYNAMIC_IDL_
#define _DYNAMIC_IDL_

import ::CORBA;
module Dynamic {
 typeprefix Dynamic "omg.org";

 struct Parameter {
 any argument;
 CORBA::ParameterMode mode;
 };

 typedef sequence<Parameter> ParameterList;

 typedef CORBA::StringSeq ContextList;

 typedef sequence<CORBA::TypeCode> ExceptionList;

 typedef CORBA::StringSeq RequestContext;
};
#endif _DYNAMIC_IDL_
```

### 21.10.2 Portions of IOP Relevant to Portable Interceptor

```
import ::CORBA;

module IOP{
 typeprefix IOP "omg.org";
 typedef sequence<IOP::TaggedComponent> TaggedComponentSeq;

 local interface Codec {
 exception InvalidTypeForEncoding {};
 exception FormatMismatch {};
 exception TypeMismatch {};
 };
};
```

```

CORBA::OctetSeq encode (in any data)
 raises (InvalidTypeForEncoding);
any decode (in CORBA::OctetSeq data)
 raises (FormatMismatch);
CORBA::OctetSeq encode_value (in any data)
 raises (InvalidTypeForEncoding);
any decode_value (
 in CORBA::OctetSeq data,
 in CORBA::TypeCode tc)
 raises (FormatMismatch, TypeMismatch);
};

typedef short EncodingFormat;
const EncodingFormat ENCODING_CDR_ENCAPS = 0;

struct Encoding {
 EncodingFormat format;
 octet major_version;
 octet minor_version;
};

local interface CodecFactory {
 exception UnknownEncoding {};

 Codec create_codec (in Encoding enc) raises (UnknownEncoding);
};
};

```

### 21.10.3 *PortableInterceptor*

```

// IDL
// File: PortableInterceptor.idl
#ifndef _PORTABLE_INTERCEPTOR_IDL_
#define _PORTABLE_INTERCEPTOR_IDL_

import ::CORBA;
import ::IOP;
import ::Messaging;
import ::Dynamic;

module PortableInterceptor {
 typeprefix PortableInterceptor "omg.org";
 local interface Interceptor {
 readonly attribute string name;
 void destroy();
 };

 exception ForwardRequest {
 Object forward;
 };
};

```



```

typedef short ReplyStatus;

// Valid reply_status values:
 const ReplyStatus SUCCESSFUL = 0;
 const ReplyStatus SYSTEM_EXCEPTION = 1;
 const ReplyStatus USER_EXCEPTION = 2;
 const ReplyStatus LOCATION_FORWARD = 3;
 const ReplyStatus TRANSPORT_RETRY = 4;
 const ReplyStatus UNKNOWN = 5;

typedef unsigned long SlotId;

exception InvalidSlot {};

local interface Current : CORBA::Current {
 any get_slot (in SlotId id) raises (InvalidSlot);
 void set_slot (in SlotId id, in any data) raises (InvalidSlot);
};

local interface RequestInfo {
 readonly attribute unsigned long request_id;
 readonly attribute string operation;
 readonly attribute Dynamic::ParameterList arguments;
 readonly attribute Dynamic::ExceptionList exceptions;
 readonly attribute Dynamic::ContextList contexts;
 readonly attribute Dynamic::RequestContext operation_context;
 readonly attribute any result;
 readonly attribute boolean response_expected;
 readonly attribute Messaging::SyncScope sync_scope;
 readonly attribute ReplyStatus reply_status;
 readonly attribute Object forward_reference;
 any get_slot (in SlotId id) raises (InvalidSlot);
 IOP::ServiceContext get_request_service_context (
 in IOP::ServiceId id);
 IOP::ServiceContext get_reply_service_context (
 in IOP::ServiceId id);
};

local interface ClientRequestInfo : RequestInfo {
 readonly attribute Object target;
 readonly attribute Object effective_target;
 readonly attribute IOP::TaggedProfile effective_profile;
 readonly attribute any received_exception;
 readonly attribute CORBA::RepositoryId received_exception_id;
 IOP::TaggedComponent get_effective_component (
 in IOP::ComponentId id);
 IOP::TaggedComponentSeq get_effective_components (
 in IOP::ComponentId id);
 CORBA::Policy get_request_policy (in CORBA::PolicyType type);
 void add_request_service_context (
 in IOP::ServiceContext service_context,

```

```

 in boolean replace);
};

typedef string ServerId ;
typedef string ORBId ;
typedef CORBA::StringSeq AdapterName ;
typedef CORBA::OctetSeq ObjectId;

local interface ServerRequestInfo : RequestInfo {
 readonly attribute any sending_exception;
 readonly attribute ServerId server_id ;
 readonly attribute ORBId orb_id ;
 readonly attribute AdapterName adapter_name ;
 readonly attribute ObjectId object_id;
 readonly attribute CORBA::OctetSeq adapter_id;
 readonly attribute CORBA::RepositoryId
 target_most_derived_interface;
 CORBA::Policy get_server_policy (in CORBA::PolicyType type);
 void set_slot (in SlotId id, in any data) raises (InvalidSlot);
 boolean target_is_a (in CORBA::RepositoryId id);
 void add_reply_service_context (
 in IOP::ServiceContext service_context,
 in boolean replace);
};

local interface ClientRequestInterceptor : Interceptor {
 void send_request (in ClientRequestInfo ri)
 raises (ForwardRequest);
 void send_poll (in ClientRequestInfo ri);
 void receive_reply (in ClientRequestInfo ri);
 void receive_exception (in ClientRequestInfo ri)
 raises (ForwardRequest);
 void receive_other (in ClientRequestInfo ri)
 raises (ForwardRequest);
};

local interface ServerRequestInterceptor : Interceptor {
 void receive_request_service_contexts (in ServerRequestInfo ri)
 raises (ForwardRequest);
 void receive_request (in ServerRequestInfo ri)
 raises (ForwardRequest);
 void send_reply (in ServerRequestInfo ri);
 void send_exception (in ServerRequestInfo ri)
 raises (ForwardRequest);
 void send_other (in ServerRequestInfo ri)
 raises (ForwardRequest);
};

abstract valuetype ObjectReferenceFactory {
 boolean equals(in ObjectReferenceFactory other) ;
 Object make_object(in string repositoryId, in ObjectId id) ;
};

```

```

 IOP::TaggedProfileSeq make_profiles(
 in string repository_id,
 in ObjectId id) ;
};

abstract valuetype ObjectReferenceTemplate :
 ObjectReferenceFactory {
 readonly attribute ServerId server_id ;
 readonly attribute ORBId orb_id ;
 readonly attribute AdapterName adapter_name ;
 };

typedef sequence<ObjectReferenceTemplate>
 ObjectReferenceTemplateSeq;

typedef string AdapterManagerId;

typedef short AdapterState ;

const AdapterState HOLDING = 0 ;
const AdapterState ACTIVE = 1 ;
const AdapterState DISCARDING = 2 ;
const AdapterState INACTIVE = 3 ;
const AdapterState NON_EXISTENT = 4 ;

local interface IORInfo {
 CORBA::Policy get_effective_policy (in CORBA::PolicyType type);
 void add_ior_component (
 in IOP::TaggedComponent a_component);
 void add_ior_component_to_profile (
 in IOP::TaggedComponent a_component,
 in IOP::ProfileId profile_id);
};

local interface IORInterceptor : Interceptor {
 void establish_components (in IORInfo info);
};

local interface IORInterceptor_3_0 : IORInterceptor {
 void components_established(in IORInfo info) ;
 void adapter_manager_state_changed(
 in AdapterManagerId id, in AdapterState state) ;
 void adapter_state_changed(
 in ObjectReferenceTemplateSeq templates,
 in AdapterState state) ;
};

local interface PolicyFactory {
 CORBA::Policy create_policy (
 in CORBA::PolicyType type,
 in any value)
 raises (CORBA::PolicyError);
};

```

```
};

local interface ORBInitInfo {
 typedef string ObjectId;
 exception DuplicateName {
 string name;
 };
 exception InvalidName {};

 readonly attribute CORBA::StringSeq arguments;
 readonly attribute string orb_id;
 readonly attribute IOP::CodecFactory codec_factory;

 void register_initial_reference (in ObjectId id, in Object obj)
 raises (InvalidName);
 Object resolve_initial_references (
 in ObjectId id) raises (InvalidName);
 void add_client_request_interceptor (
 in ClientRequestInterceptor interceptor)
 raises (DuplicateName);
 void add_server_request_interceptor (
 in ServerRequestInterceptor interceptor)
 raises (DuplicateName);
 void add_ior_interceptor (in IORInterceptor interceptor)
 raises (DuplicateName);
 SlotId allocate_slot_id ();
 void register_policy_factory (
 in CORBA::PolicyType type,
 in PolicyFactory policy_factory);
};

local interface ORBInitializer {
 void pre_init (in ORBInitInfo info);
 void post_init (in ORBInitInfo info);
};

#endif _PORTABLE_INTERCEPTOR_IDL_
```

This chapter covers three general topics: Quality of Service, Asynchronous Method Invocations (including Time-Independent or “Persistent” Requests), and the specification of interoperable Routing interfaces to support the transport of requests asynchronously from the handling of their replies.

## Contents

This chapter contains the following topics.

| Topic                                           | Page  |
|-------------------------------------------------|-------|
| <b>Section I - Quality of Service</b>           | 22-2  |
| “Section I - Introduction”                      | 22-2  |
| “Messaging Quality of Service”                  | 22-2  |
| “Propagation of Messaging QoS”                  | 22-12 |
| <b>Section II - Messaging Programming Model</b> | 22-13 |
| “Section II - Introduction”                     | 22-13 |
| “Running Example”                               | 22-15 |
| “Async Operation Mapping”                       | 22-16 |
| “Exception Delivery in the Callback Model”      | 22-20 |
| “Type-Specific ReplyHandler Mapping”            | 22-21 |
| “Generic Poller Value”                          | 22-24 |
| “Type-Specific Poller Mapping”                  | 22-26 |
| “Example Programmer Usage”                      | 22-30 |

| Topic                                                 | Page  |
|-------------------------------------------------------|-------|
| <b>Section III - Message Routing Interoperability</b> | 22-45 |
| “Section III - Introduction”                          | 22-45 |
| “Routing Object References”                           | 22-46 |
| “Message Routing”                                     | 22-46 |
| “Router Administration”                               | 22-59 |
| “CORBA Messaging IDL”                                 | 22-65 |
| Appendix A - “Overall Design Rationale”               | 22-72 |
| Appendix B - “Conformance and Compatibility Issues”   | 22-84 |

## Section I - Quality of Service

Messaging requires clients and servers to have the ability to set the required and supported qualities of service with respect to requests. This specification provides generalized APIs through which such qualities are set in clients and servers. In addition, the set of Messaging-related qualities and the rules for reconciling and using these qualities are defined. Finally, the Messaging-specific IOR Profile Component and Service Context are defined for propagation of QoS information.

### 22.1 Section I - Introduction

This section describes a standard Quality of Service (QoS) framework within which CORBA Services specifications should define their service-specific qualities. In this framework, all QoS settings are interfaces derived from **CORBA::Policy**.

The details of the Policy Management Framework are to be found in the *ORB Interface* chapter.

### 22.2 Messaging Quality of Service

The Messaging module contains the IDL that the programmer uses to define Qualities of Service specific to CORBA messaging.

---

**Note** – Except where defaults are noted, this specification does not state required default values for the following Qualities of Service. Application code must explicitly set its ORB-level Quality of Service to ensure portability across ORB products.

---

```

module Messaging {

 typedef short RebindMode;
 const RebindMode TRANSPARENT = 0;
 const RebindMode NO_REBIND = 1;

```

```

const RebindMode NO_RECONNECT = 2;

typedef short SyncScope;
const SyncScope SYNC_NONE = 0;
const SyncScope SYNC_WITH_TRANSPORT = 1;
const SyncScope SYNC_WITH_SERVER = 2;
const SyncScope SYNC_WITH_TARGET = 3;

typedef short RoutingType;
const RoutingType ROUTE_NONE = 0;
const RoutingType ROUTE_FORWARD = 1;
const RoutingType ROUTE_STORE_AND_FORWARD =2;

typedef short Priority;

typedef unsigned short Ordering;
const Ordering ORDER_ANY = 0x01;
const Ordering ORDER_TEMPORAL = 0x02;
const Ordering ORDER_PRIORITY = 0x04;
const Ordering ORDER_DEADLINE = 0x08;

// Rebind Policy (default = TRANSPARENT)
const CORBA::PolicyType REBIND_POLICY_TYPE = 23;
local interface RebindPolicy : CORBA::Policy {
 readonly attribute RebindMode rebind_mode;
};

// Synchronization Policy (default = SYNC_WITH_TRANSPORT)
const CORBA::PolicyType SYNC_SCOPE_POLICY_TYPE = 24;
local interface SyncScopePolicy : CORBA::Policy {
 readonly attribute SyncScope synchronization;
};

// Priority Policies
const CORBA::PolicyType REQUEST_PRIORITY_POLICY_TYPE = 25;
struct PriorityRange {
 Priority min;
 Priority max;
};

local interface RequestPriorityPolicy : CORBA::Policy {
 readonly attribute PriorityRange priority_range;
};

const CORBA::PolicyType REPLY_PRIORITY_POLICY_TYPE = 26;
local interface ReplyPriorityPolicy : CORBA::Policy {
 readonly attribute PriorityRange priority_range;
};

// Timeout Policies
const CORBA::PolicyType

```

```

 REQUEST_START_TIME_POLICY_TYPE = 27;
local interface RequestStartTimePolicy : CORBA::Policy {
 readonly attribute TimeBase::UtcT start_time;
};
const CORBA::PolicyType REQUEST_END_TIME_POLICY_TYPE = 28;
local interface RequestEndTimePolicy : CORBA::Policy {
 readonly attribute TimeBase::UtcT end_time;
};

const CORBA::PolicyType REPLY_START_TIME_POLICY_TYPE = 29;
local interface ReplyStartTimePolicy : CORBA::Policy {
 readonly attribute TimeBase::UtcT start_time;
};
const CORBA::PolicyType REPLY_END_TIME_POLICY_TYPE = 30;
local interface ReplyEndTimePolicy : CORBA::Policy {
 readonly attribute TimeBase::UtcT end_time;
};

const CORBA::PolicyType
 RELATIVE_REQ_TIMEOUT_POLICY_TYPE = 31;
local interface RelativeRequestTimeoutPolicy : CORBA::Policy {
 readonly attribute TimeBase::TimeT relative_expiry;
};

const CORBA::PolicyType
 RELATIVE_RT_TIMEOUT_POLICY_TYPE = 32;
local interface RelativeRoundtripTimeoutPolicy : CORBA::Policy {
 readonly attribute TimeBase::TimeT relative_expiry;
};

const CORBA::PolicyType ROUTING_POLICY_TYPE = 33;
struct RoutingTypeRange {
 RoutingType min;
 RoutingType max;
};
local interface RoutingPolicy : CORBA::Policy {
 readonly attribute RoutingTypeRange routing_range;
};

const CORBA::PolicyType MAX_HOPS_POLICY_TYPE = 34;
local interface MaxHopsPolicy : CORBA::Policy {
 readonly attribute unsigned short max_hops;
};

// Router Delivery-ordering Policy (default = ORDER_TEMPORAL)
const CORBA::PolicyType QUEUE_ORDER_POLICY_TYPE = 35;
local interface QueueOrderPolicy : CORBA::Policy {
 readonly attribute Ordering allowed_orders;
};
};

```



## 22.2.1 Rebind Support

### 22.2.1.1 *typedef short RebindMode*

Describes the level of transparent rebinding that may occur during the course of an invocation on an Object. Values of type **RebindMode** are used in conjunction with a **RebindPolicy**, as described in Section 22.2.1.2, “interface RebindPolicy,” on page 22-5. All non-negative values are reserved for use in OMG specifications. Any negative value of **RebindMode** is considered a vendor extension.

- **TRANSPARENT** - allows the ORB to silently handle object-forwarding and necessary reconnection during the course of making a remote request. This is equivalent to the only defined *CORBA* ORB behavior.
- **NO\_REBIND** - allows the ORB to silently handle reopening of closed connections while making a remote request, but prevents any transparent object-forwarding that would cause a change in client-visible effective QoS policies. When this policy is in effect, only explicit rebinding (through **CORBA::Object::validate\_connection**) is allowed.
- **NO\_RECONNECT** - prevents the ORB from silently handling object-forwards or the reopening of closed connections. When this policy is in effect, only explicit rebinding and reconnection (through **CORBA::Object::validate\_connection**) is allowed.

### 22.2.1.2 *interface RebindPolicy*

This interface is a local object derived from **CORBA::Policy**. It is used to indicate whether the ORB may transparently rebind once successfully *bound* to a target. For GIOP-based protocols an object reference is considered bound once it is in a state where a **LocateRequest** message would result in a **LocateReply** message with status **OBJECT\_HERE**. If the effective Policy of this type has a **rebind\_mode** value of **TRANSPARENT** (always the default and the only valid value in *CORBA*), the ORB will silently handle any subsequent **LocateReply** messages with **OBJECT\_FORWARD** status or Reply messages with **LOCATION\_FORWARD** status. The effective policies of other types for this object reference may change from invocation to invocation. If the effective Policy of this type has a **rebind\_mode** value of **NO\_REBIND**, the ORB will raise a **REBIND** system exception if any rebind handling would cause a client-visible change in policies. This could happen under the following circumstances:

- The client receives a **LocateReply** message with an **OBJECT\_FORWARD** status and a new IOR that has policy requirements incompatible with the effective policies currently in use.
- The client receives a Reply message with **LOCATION\_FORWARD** status and a new IOR that has policy requirements incompatible with the effective policies currently in use.

If the effective Policy of this type has a **rebind\_mode** value of **NO\_RECONNECT**, the ORB will raise a **REBIND** system exception if any rebind handling would cause a client-visible change in policies, or if a new connection must be opened. This includes the reopening of previously closed connections as well as the opening of new connections if the target address changes (for example, due to a **LOCATION\_FORWARD** reply). For connectionless protocols, the meaning of this effective policy must be specified, or it must be defined that **NO\_RECONNECT** is an equivalent to **NO\_REBIND**. Regardless of the effective **RebindPolicy**, rebind or reconnect can always be explicitly requested through an invocation of **CORBA::Object::validate\_connection**. When instances of **RebindPolicy** are created, a value of type **RebindMode** is passed to **CORBA::ORB::create\_policy**. This policy is only applicable as a client-side override. When an instance of **RebindPolicy** is propagated within a **PolicyValue** in an **INVOCATION\_POLICIES** Service Context, the **ptype** has value **REBIND\_POLICY\_TYPE** and the **pvalue** is a CDR encapsulation containing a **RebindMode**.

## 22.2.2 Synchronization Scope

### 22.2.2.1 *typedef short SyncScope*

Describes the level of synchronization for a request with respect to the target. Values of type **SyncScope** are used in conjunction with a **SyncScopePolicy**, as described in Section 22.2.2.2, “interface SyncScopePolicy,” on page 22-7, to control the behavior of oneway operations. All non-negative values are reserved for use in OMG specifications. Any negative value of **SyncScope** is considered a vendor extension.

- **SYNC\_NONE** - equivalent to one allowable interpretation of *CORBA* oneway operations. The ORB returns control to the client (e.g., returns from the method invocation) before passing the request message to the transport protocol. The client is guaranteed not to block. Since no reply is returned from the server, no location-forwarding can be done with this level of synchronization.
- **SYNC\_WITH\_TRANSPORT** - equivalent to one allowable interpretation of *CORBA* oneway operations. The ORB returns control to the client only after the transport has accepted the request message. This in itself gives no guarantee that the request will be delivered, but in conjunction with knowledge of the characteristics of the transport may provide the client with a useful degree of assurance. For example, for a direct message over TCP, **SYNC\_WITH\_TRANSPORT** is not a stronger guarantee than **SYNC\_NONE**. However, for a store-and-forward transport, this QoS provides a high level of reliability. Since no reply is returned from the server, no location-forwarding can be done with this level of synchronization.
- **SYNC\_WITH\_SERVER** - the server-side ORB sends a reply before invoking the target implementation. If a reply of **NO\_EXCEPTION** is sent, any necessary location-forwarding has already occurred. Upon receipt of this reply, the client-side ORB returns control to the client application. This form of guarantee is useful where the reliability of the network is substantially lower than that of the server.

The client blocks until all location-forwarding has been completed. For a server using a POA, the reply would be sent after invoking any `ServantManager`, but before delivering the request to the target Servant.

- **SYNC\_WITH\_TARGET** - equivalent to a synchronous, non-oneway operation in *CORBA*. The server-side ORB shall only send the reply message after the target has completed the invoked operation. Note that any **LOCATION\_FORWARD** reply will already have been sent prior to invoking the target and that a **SYSTEM\_EXCEPTION** reply may be sent at anytime (depending on the semantics of the exception). Even though it was declared oneway, the operation actually has the behavior of a synchronous operation. This form of synchronization guarantees that the client knows that the target has seen and acted upon a request. As with *CORBA*, only with this highest level of synchronization can the OTS be used. Any operations invoked with lesser synchronization precludes the target from participating in the client's current transaction.

### 22.2.2.2 *interface SyncScopePolicy*

This interface is a local object derived from **CORBA::Policy**. It is applied to oneway operations to indicate the synchronization scope with respect to the target of that operation request. It is ignored when any non-oneway operation is invoked. This policy is also applied when the DII is used with a flag of **INV\_NO\_RESPONSE** since the implementation of the DII is not required to consult an interface definition to determine if an operation is declared oneway. The default value of this Policy is not defined. Applications must explicitly set an ORB-level **SyncScopePolicy** to ensure portability across ORB implementations. When instances of **SyncScopePolicy** are created, a value of type **Messaging::SyncScope** is passed to **CORBA::ORB::create\_policy**. This policy is only applicable as a client-side override. The client's **SyncScopePolicy** is propagated within a request in the RequestHeader's **response\_flags** as described in GIOP Request Header.

### 22.2.3 *Request and Reply Priority*

#### 22.2.3.1 *struct PriorityRange*

This structure describes a range of priorities. A **PriorityRange** with minimum Priority greater than maximum Priority is invalid.

#### 22.2.3.2 *interface RequestPriorityPolicy*

This interface is a local object derived from **CORBA::Policy**. It is used to indicate the valid range of priorities, which may be associated with an operation request. This value is used by Routers when the effective **QueueOrderPolicy** has the value **ORDER\_PRIORITY**. Higher Priority values indicate a higher priority. When instances of **RequestPriorityPolicy** are created, a value of type **Messaging::PriorityRange** is passed to **CORBA::ORB::create\_policy**. An instance of **RequestPriorityPolicy** may be specified when creating a POA (and therefore may be represented in Object references). In addition, an Object reference's

**RequestPriorityPolicy** may be overridden by the client. If set on both the client and server, reconciliation is performed by intersecting the server-specified **RequestPriorityPolicy** range with the range of the client's effective override. When an instance of **RequestPriorityPolicy** is propagated within a **PolicyValue** in a **TAG\_POLICIES** Profile Component or **INVOCATION\_POLICIES** Service Context, the **ptype** has value **REQUEST\_PRIORITY\_POLICY\_TYPE** and the **pvalue** is a CDR encapsulation containing a **Messaging::PriorityRange**.

### 22.2.3.3 *interface ReplyPriorityPolicy*

This interface is a local object derived from **CORBA::Policy**. It is used to indicate the valid range of priorities, which may be associated with the reply to an operation request. This value is used by Routers when the effective **QueueOrderPolicy** has the value **ORDER\_PRIORITY**. Higher Priority values indicate a higher priority. When instances of **ReplyPriorityPolicy** are created, a value of type **Messaging::PriorityRange** is passed to **CORBA::ORB::create\_policy**. An instance of **ReplyPriorityPolicy** may be specified when creating a POA (and therefore may be represented in Object references). In addition, an Object reference's **ReplyPriorityPolicy** may be overridden by the client. If set on both the client and server, reconciliation is performed by intersecting the server-specified **ReplyPriorityPolicy** range with the range of the client's effective override. When an instance of **ReplyPriorityPolicy** is propagated within a **PolicyValue** in a **TAG\_POLICIES** Profile Component or **INVOCATION\_POLICIES** Service Context, the **ptype** has value **REPLY\_PRIORITY\_POLICY\_TYPE** and the **pvalue** is a CDR encapsulation containing a **Messaging::PriorityRange**.

## 22.2.4 *Request and Reply Timeout*

This specification describes the lifetime of requests and replies in terms of the structured type from the CORBA Time Service Specification. This describes time as a 64-bit value, which is the number of 100 nano-seconds from 15 October 1582 00:00, along with inaccuracy and time zone information.

### 22.2.4.1 *interface RequestStartTimePolicy*

This interface is a local object derived from **CORBA::Policy**. It is used to indicate the valid start time after which a request may be delivered to its target, and is applied to both synchronous and asynchronous invocations. When instances of **RequestStartTimePolicy** are created, a value of type **TimeBase::UtcT** is passed to **CORBA::ORB::create\_policy**. This policy is only applicable as a client-side override. When an instance of **RequestStartTimePolicy** is propagated within a **PolicyValue** in an **INVOCATION\_POLICIES** Service Context, the **ptype** has value **REQUEST\_START\_TIME\_POLICY\_TYPE** and the **pvalue** is a CDR encapsulation containing a **TimeBase::UtcT**.

#### 22.2.4.2 *interface RequestEndTimePolicy*

This interface is a local object derived from **CORBA::Policy**. It is used to indicate the time after which a request may no longer be delivered to its target. This policy is applied to both synchronous and asynchronous invocations. When instances of **RequestEndTimePolicy** are created, a value of type **TimeBase::UtcT** is passed to **CORBA::ORB::create\_policy**. This policy is only applicable as a client-side override. When an instance of **RequestEndTimePolicy** is propagated within a **PolicyValue** in an **INVOCATION\_POLICIES** Service Context, the **ptype** has value **REQUEST\_END\_TIME\_POLICY\_TYPE** and the **pvalue** is a CDR encapsulation containing a **TimeBase::UtcT**.

#### 22.2.4.3 *interface ReplyStartTimePolicy*

This interface is a local object derived from **CORBA::Policy**. It is used to indicate the valid start time after which a reply may be delivered to the client. This policy is applied to both synchronous and asynchronous invocations. When instances of **ReplyStartTimePolicy** are created, a value of type **TimeBase::UtcT** is passed to **CORBA::ORB::create\_policy**. This policy is only applicable as a client-side override. When an instance of **ReplyStartTimePolicy** is propagated within a **PolicyValue** in an **INVOCATION\_POLICIES** Service Context, the **ptype** has value **REPLY\_START\_TIME\_POLICY\_TYPE** and the **pvalue** is a CDR encapsulation containing a **TimeBase::UtcT**.

#### 22.2.4.4 *interface ReplyEndTimePolicy*

This interface is a local object derived from **CORBA::Policy**. It is used to indicate the time after which a reply may no longer be obtained or returned to the client. This policy is applied to both synchronous and asynchronous invocations. When instances of **ReplyEndTimePolicy** are created, a value of type **TimeBase::UtcT** is passed to **CORBA::ORB::create\_policy**. This policy is only applicable as a client-side override. When an instance of **ReplyEndTimePolicy** is propagated within a **PolicyValue** in an **INVOCATION\_POLICIES** Service Context, the **ptype** has value **REPLY\_END\_TIME\_POLICY\_TYPE** and the **pvalue** is a CDR encapsulation containing a **TimeBase::UtcT**.

#### 22.2.4.5 *interface RelativeRequestTimeoutPolicy*

This interface is a local object derived from **CORBA::Policy**. It is used to indicate the relative amount of time for which a Request may be delivered. After this amount of time the Request is cancelled. This policy is applied to both synchronous and asynchronous invocations. If asynchronous invocation is used, this policy only limits the amount of time during which the request may be processed. Assuming the request completes within the specified timeout, the reply will never be discarded due to timeout. When instances of **RelativeRequestTimeoutPolicy** are created, a value of type **TimeBase::TimeT** is passed to **CORBA::ORB::create\_policy**. This policy is only applicable as a client-side override. When an instance of **RelativeRequestTimeoutPolicy** is propagated within a **PolicyValue** in an

**INVOCATION\_POLICIES** Service Context, the **ptype** has value **REQUEST\_END\_TIME\_POLICY\_TYPE** and the **pvalue** is a CDR encapsulation containing the **relative\_expiry** converted into a **TimeBase::UtcT** end time (as in the case of **RequestEndTimePolicy**).

#### 22.2.4.6 *interface RelativeRoundtripTimeoutPolicy*

This interface is a local object derived from **CORBA::Policy**. It is used to indicate the relative amount of time for which a Request or its corresponding Reply may be delivered. After this amount of time, the Request is cancelled (if a response has not yet been received from the target) or the Reply is discarded (if the Request had already been delivered and a Reply returned from the target). This policy is applied to both synchronous and asynchronous invocations.

When instances of **RelativeRoundtripTimeoutPolicy** are created, a value of type **TimeBase::TimeT** is passed to **CORBA::ORB::create\_policy**. This policy is only applicable as a client-side override. When an instance of **RelativeRoundtripTimeoutPolicy** is propagated within a **PolicyValue** in an **INVOCATION\_POLICIES** Service Context, the **ptype** has value **REPLY\_END\_TIME\_POLICY\_TYPE** and the **pvalue** is a CDR encapsulation containing the **relative\_expiry** converted into a **TimeBase::UtcT** end time (as in the case of **ReplyEndTimePolicy**).

### 22.2.5 *Routing*

#### 22.2.5.1 *typedef short RoutingType*

Describes the type of Routing to be used for invocations on an Object reference. Values of type **RoutingType** are used in conjunction with a **RoutingPolicy** as described in Section 22.2.5.3, “interface RoutingPolicy,” on page 22-11. All non-negative values are reserved for use in OMG specifications. Any negative value of **RoutingType** is considered a vendor extension.

- **ROUTE\_NONE** - Synchronous or Deferred Synchronous delivery is used. No Routers will be used to aid in the delivery of the request.
- **ROUTE\_FORWARD** - Asynchronous delivery is used. The request is made through the use of a Router and not delivered directly to the target by the client ORB.
- **ROUTE\_STORE\_AND\_FORWARD** - Asynchronous TII is used. The request is made through the use of a Router that persistently stores the request before attempting delivery.

#### 22.2.5.2 *struct RoutingTypeRange*

This structure describes a range of routing types. A **RoutingTypeRange** with minimum **RoutingType** greater than maximum **RoutingType** is invalid.

### 22.2.5.3 *interface RoutingPolicy*

This interface is a local object derived from **CORBA::Policy**. It is used to indicate whether or not the ORB must ensure delivery of a request through the use of queuing. If the effective Policy of this type has a **RoutingTypeRange** with min value of **ROUTE\_FORWARD** or **ROUTE\_STORE\_AND\_FORWARD**, the interoperable Routing protocol described in Section 22.12, “Section III - Introduction,” on page 22-45 is used. This policy does not apply to synchronous invocations. If, for example, the min is **ROUTE\_NONE** and the max is **ROUTE\_FORWARD**, the Routing protocol will normally be used but a direct connection may be used if available. When instances of **RoutingPolicy** are created, a value of type **RoutingTypeRange** is passed to **CORBA::ORB::create\_policy**. An instance of **RoutingPolicy** may be specified when creating a POA (and therefore may be represented in Object references). In addition, a POA’s **RoutingPolicy** is visible to clients through the Object references it creates, and reconciled with the client’s override. If set on both the client and server, reconciliation is performed by intersecting the server-specified **RoutingPolicy** range with the range of the client’s effective override. When an instance of **RoutingPolicy** is propagated within a **PolicyValue** in a **TAG\_POLICIES** Profile Component or **INVOCATION\_POLICIES** Service Context, the **ptype** has value **ROUTING\_POLICY\_TYPE** and the **pvalue** is a CDR encapsulation containing a **Messaging::RoutingTypeRange**.

### 22.2.5.4 *interface MaxHopsPolicy*

This interface is a local object derived from **CORBA::Policy**. It is used to indicate the maximum number of routing hops that can occur when routing a request from the client to the target. When instances of **MaxHopsPolicy** are created, a value of type unsigned short is passed to **CORBA::ORB::create\_policy**. This policy is only applicable as a client-side override. When an instance of **MaxHopsPolicy** is propagated within a **PolicyValue** in an **INVOCATION\_POLICIES** Service Context, the **ptype** has value **MAX\_HOPS\_POLICY\_TYPE** and the **pvalue** is a CDR encapsulation containing an **unsigned short**.

## 22.2.6 *Queue Ordering*

### 22.2.6.1 *typedef short Ordering*

Describes the ordering policy for the consideration of routers that prioritize delivery of requests. Values of type **Ordering** are used in conjunction with a **QueueOrderPolicy** as described in “interface **QueueOrderPolicy**” on page 22-12. This policy is only used if the effective **RoutingType** is at least **ROUTE\_FORWARD** (which implies the use of a **Router**). Support for multiple ordering policies is indicated by “or”-ing together individual values in a combined **Ordering**.

- **ORDER\_ANY** - the client doesn't care in what order its requests are processed.
- **ORDER\_TEMPORAL** - the client wants to be sure that its requests are processed in the order in which they were issued. **ORDER\_TEMPORAL** is the default.



- **ORDER\_PRIORITY** - the client wants its requests processed based on the priority assigned in the QoS structure described below.
- **ORDER\_DEADLINE** - the client wants its requests ordered so that those whose `time_to_live` is about to expire are moved to the front of the queue.

### 22.2.6.2 *interface QueueOrderPolicy*

This interface is a local object derived from **CORBA::Policy**. It is used to indicate the basis upon which a Router orders delivery of requests. When instances of **QueueOrderPolicy** are created, a value of type **Messaging::Ordering** is passed to **CORBA::ORB::create\_policy**. This specified **Ordering** value can be the result of “or”-ing together individual orderings. An instance of **QueueOrderPolicy** may be specified when creating a POA (and therefore may be represented in Object references). In addition, an Object reference’s **QueueOrderPolicy** may be overridden by the client. If set on both the client and server, reconciliation is performed by intersecting the server-specified list of supported Ordering values with the list of values in the client’s effective override. When an instance of **QueueOrderPolicy** is propagated within a **PolicyValue** in a **TAG\_POLICIES** Profile Component or **INVOCATION\_POLICIES** Service Context, the **ptype** has value **QUEUE\_ORDER\_POLICY\_TYPE** and the **pvalue** is a CDR encapsulation containing a **Messaging::Ordering**.

## 22.3 *Propagation of Messaging QoS*

This section defines the profile Component through which QoS requirements are expressed in an object reference, and the Service Context through which QoS requirements are expressed as part of a GIOP request.

```

module Messaging {
 struct PolicyValue {
 CORBA::PolicyType ptype;
 sequence<octet> pvalue;
 };
 typedef sequence<PolicyValue> PolicyValueSeq;

 const IOP::ComponentId TAG_POLICIES = 2;
 const IOP::ServiceId INVOCATION_POLICIES = 7;
};

```

### 22.3.1 *Structures*

#### **PolicyValue**

This structure contains the value corresponding to a Policy of the **PolicyType** indicated by its **ptype**. This representation allows the compact transmission of QoS policies within IORs and Service Contexts. The format of **pvalue** for each type is given in the specification of that Policy.



### 22.3.2 Messaging QoS Profile Component

A new **IOP::TaggedComponent** is defined for transmission of QoS policies within interoperable Object References. The body of this Component is a CDR encapsulation containing a **Messaging::PolicyValueSeq**. When creating Object references, Portable Object Adapters may encode the relevant policies with which it was created in this **TaggedComponent**. POA Policies that are exported in this way are clearly noted as *client-exposed* in their definitions. These policies are reconciled with the effective client-side override when clients invokes operations on that reference. For example, if a POA is created with a **RequestPriorityPolicy** with minimum value 0 and maximum value 10, all Object references created by that POA will have that default **RequestPriorityPolicy** encoded in their IOR. Furthermore, if a client sets an overriding **RequestPriorityPolicy** with both minimum and maximum of 5 (the client requires its requests to have a priority of value 5), the ORB will reconcile the effective Policy for any invocations on this Object reference to have a priority of 5 (since this value is within the range of priorities allowed by the target). On the other hand, if the client set an override with minimum value of 11, any invocation attempts would raise the system exception **INV\_POLICY**.

### 22.3.3 Messaging QoS Service Context

A new **IOP::ServiceContext** is defined for transmission of QoS policies within GIOP requests and replies. The body of this Context is a CDR encapsulation containing a **Messaging::PolicyValueSeq**.

## Section II - Messaging Programming Model

### 22.4 Section II - Introduction

Asynchronous Method Invocations allow clients to make non-blocking requests on a target. The AMI is treated as a client-side language mapping issue only. In most cases, server-side implementations are not required to change as from the server-side programmer's point of view all invocations can be treated identically regardless of their synchronicity characteristics. In certain situations, such as with transactional servers, the asynchrony of a client does matter and requires server-side changes if expected to handle transactional asynchronous requests. This specific issue is addressed in Appendix C, Section B.2.1, "Transaction Service," on page 22-84.

Clients may, at any time, make either asynchronous or synchronous requests on the target. Two models of asynchronous requests are supported: callback and polling. In the *callback* model, the client passes a reference to a reply handler (a client-side CORBA object implementation that handles the reply for a client request), in addition to the normal parameters needed by the request. The reply handler interface defines operations to receive the results of that request (including **inout** and **out** values and possible exceptions). The **ReplyHandler** is a normal CORBA object that is implemented by the programmer as with any object implementation. In the polling

model, the client makes the request passing in all the parameters needed for the invocation, and is returned a Poller object that can be queried to obtain the results of the invocation. This Poller is an instance of a `ValueType`.

AMI may be used in single- and multi-threaded applications. AMI calls may have any legal return type, parameters, and contexts. AMI operations do not raise user exceptions. Rather, user exceptions are passed to the implemented type-specific **ReplyHandler** or returned from the type-specific Poller. If an AMI operation raises a system exception with a completion status of **COMPLETED\_NO**, the request has not been made. This clearly distinguishes exceptions raised by the server (which are returned via the **ReplyHandler** or Poller) from local exceptions that caused the AMI to fail.

This section focuses entirely on the static (typed) asynchronous invocations that are based on the interface that is the target of the operation. This section describes the mapping for the generated asynchronous method signatures. It also describes the generated reply handlers that are passed to those async methods when the callback model is used, and the generated poller values that are returned from those async methods when the polling model is used. The AMI mapping contains an IDL to “implied-IDL” mapping, which defines the new operations and interfaces required to perform asynchronous invocations and obtain the replies to these requests. The new interfaces and values defined in this implied-IDL are considered to be real IDL since they can correspond to entries in the Interface Repository and have behavior consistent with all other definitions in IDL. In several cases, this implied-IDL adds new operations to existing interfaces. These new asynchronous stub interfaces are not considered to be real IDL in that they do not correspond to entries in the Interface Repository. The distinction between these types of implied-IDL is made clear in the rest of this section. In general, the implied-IDL is used to avoid explicitly mapping the AMI API to each of the currently supported languages.

When a messaging-enabled IDL code generator is run on an interface, the following is performed in addition to the processing specified in *CORBA*:

- A Servant mapping is generated for a type-specific **ReplyHandler** from which the client application derives its **ReplyHandler** implementation. No type-specific **ReplyHandler** stubs need be generated, but their absence is not a requirement. The Servant base is generated as if from an IDL interface with a definition as specified in Section 22.8, “Type-Specific ReplyHandler Mapping,” on page 22-21.
- A type-specific **Poller valueType** is generated. The implementation of this **Poller** is provided by the messaging-aware ORB. The language-specific generated code corresponds to a **valueType** as if it were defined in IDL as specified in Section 22.10, “Type-Specific Poller Mapping,” on page 22-26.
- Asynchronous request operations are generated with signatures exactly as if the operations were declared on the original interface. The implied-IDL signature of these operations is specified in Section 22.6, “Async Operation Mapping,” on page 22-16. The implied-IDL is used entirely so that each individual supported language mapping need not be given for the asynchronous request operations.

---

**Note** – These implied-IDL operations are not intended to be seen by the Object implementation and are not implemented by the Servant. They are purely a client-side construct for describing the operation signatures for generated code.

---

- Furthermore, these operations are not part of the interfaces **CORBA::InterfaceDef** and do not correspond to synchronous operations. The generated code for these operations interacts with a messaging-aware ORB in ways outside of the scope of this section. The mechanism of this interaction is specified for interoperability purposes in Section 22.14, “Message Routing,” on page 22-46. An application programmer need not be aware of this mechanism.

## 22.5 *Running Example*

A running example is used throughout this section to clarify the generation of the new typed asynchronous invocation stubs, the new reply handling interfaces for receiving callback responses, and the new poller values for querying the status of an outstanding request. The example features a simple stock portfolio manager interface. Most importantly, the interface includes operations that cover all cases of operation signature:

- attributes
- in arguments
- inout arguments
- out arguments
- return values
- user exceptions

Operations declared oneway are not mapped to asynchronous invocation stubs because they are already asynchronous in nature.

**// Original IDL**

```
exception InvalidStock { string sym; };
```

```
interface StockManager {
 attribute string stock_exchange_name;

 boolean add_stock(in string symbol, in double quote);
 void edit_stock(in string symbol, in double new_quote)
 raises(InvalidStock);
 void remove_stock(in string symbol, out double quote)
 raises(InvalidStock);

 boolean find_closest_symbol(inout string symbol);
 double get_quote(in string symbol) raises(InvalidStock);
};
```

## 22.6 Async Operation Mapping

For each operation in an interface, corresponding callback and polling asynchronous method signatures are generated. These signatures are described in implied-IDL, which is used to generate language-specific operation signatures. The implementation of these methods must generate a method invocation as described in Section 22.14, “Message Routing,” on page 22-46. Note that these generated operations are not included in the interface’s definition (**CORBA::InterfaceDef**). These operations do not raise user exceptions. Just as with the currently specified **CORBA::Request::send operation**, they can (but are not required to) raise system exceptions. For explanatory purposes, the sections below show the Callback and Polling implied-IDL in separate pieces. Logically, the IDL compiler deals with async as if the IDL included all three pieces: the original IDL and the implied IDL for both async models.

### 22.6.1 Callback Model Signatures (*sendc*)

When the callback model is used, the client supplies a reply handler when making the asynchronous invocation. The interface’s operations and attributes are mapped to implied-IDL operations with names prefixed by “**sendc\_**”. If this implied-IDL operation name conflicts with existing operations on the interface or any of the interface’s base interfaces, “**ami\_**” strings are inserted between “**sendc\_**” and the original operation name until the implied-IDL operation name is unique.

#### 22.6.1.1 Implied-IDL for Operations

The signature of the implied-IDL for a given IDL operation is:

- void return type, followed by;
- **sendc\_<opName>** where **opName** is the name of the operation.

The async callback version takes the following arguments in order:

- An object reference to a type-specific **ReplyHandler** as described in Section 22.8, “Type-Specific ReplyHandler Mapping,” on page 22-21, with the parameter name **ami\_handler**. If a nil **ReplyHandler** reference is specified when this operation is invoked, no response will be returned for this invocation. A system exception may be raised by the ORB during evaluation of the request, but once **sendc** returns, no further results of the operation will be made available. This is equivalent to setting the **CORBA::INV\_NO\_RESPONSE** flag when making a DII deferred request.
- Each of the **in** and **inout** arguments in the order that they appeared in the operation’s declaration in IDL, all with a parameter attribute of **in** and with the type specifier and parameter name of the original argument.
- **out** arguments are ignored (i.e., are not part of the async signature).

The implied-IDL operation signature has a context expression identical to the one from the original operation (if any is present).

### 22.6.1.2 *Implied-IDL for Attributes*

The signature of the implied-IDL for the callback model getter and setter operations corresponding to an interface's attribute is as follows.

- Setter operations are only generated for attributes that are not defined readonly
- void return type, followed by the operation name, which to distinguish between the getter and setter operations for the attribute is given by either:
  - **sendc\_get\_<attributeName>** for reading the attribute value, where **attributeName** is the name of the attribute, or
  - **sendc\_set\_<attributeName>** for setting the attribute value, where **attributeName** is the name of the attribute that is not defined readonly.

The callback implied-IDL operations take the following arguments in order:

- An object reference of a type-specific **ReplyHandler** as described in Section 22.8, "Type-Specific ReplyHandler Mapping," on page 22-21, with the parameter name **ami\_handler**.
- The additional arguments for asynchronous implied-IDL operations for **attributes** are as follows:
  - For the attribute's generated **get** operation, there are no additional arguments.
  - For the attribute's generated **set** operation, there is one additional argument, in **<attrType> attr\_<attributeName>**, where **attrType** is the type of the attribute, and **attributeName** is the name of that attribute. The **set** operation is only generated for attributes that are not defined **readonly**.

### 22.6.1.3 *Example*

The following implied-IDL is generated from the interface definitions used in the running example:

```
// AMI implied-IDL including callback operations
// for original example IDL defined in Section 22.5

exception InvalidStock { string sym; };

interface AMI_StockManagerHandler;

interface StockManager {

 // Original operation Declarations
 attribute string stock_exchange_name;
 boolean add_stock(in string symbol, in double quote);
 void edit_stock(in string symbol, in double new_quote)
 raises(InvalidStock);
 void remove_stock(in string symbol, out double quote)
 raises(InvalidStock);
 boolean find_closest_symbol(inout string symbol);
 double get_quote(in string symbol) raises(InvalidStock);
}
```

```

// Async Callback operation Declarations
void sendc_get_stock_exchange_name(
 in AMI_StockManagerHandler ami_handler);
void sendc_set_stock_exchange_name(
 in AMI_StockManagerHandler ami_handler,
 in string attr_stock_exchange_name);

void sendc_add_stock(
 in AMI_StockManagerHandler ami_handler, in string symbol,
 in double quote);
void sendc_edit_stock(
 in AMI_StockManagerHandler ami_handler,
 in string symbol, in double new_quote);
void sendc_remove_stock(
 in AMI_StockManagerHandler ami_handler,
 in string symbol);
void sendc_find_closest_symbol(
 in AMI_StockManagerHandler ami_handler,
 in string symbol);
void sendc_get_quote(
 in AMI_StockManagerHandler ami_handler,
 in string symbol);
};

```

## 22.6.2 Polling Model Signatures (*sendp*)

When the polling model is used, the client is returned a queriable poller when making the asynchronous invocation. The interface's operations and attributes are mapped to implied-IDL operations with names prefixed by **sendp\_**. If this implied-IDL operation name conflicts with existing operations on the interface or any of the interface's base interfaces, **ami\_** strings are inserted between **sendp\_** and the original operation name until the implied-IDL operation name is unique.

### 22.6.2.1 Implied-IDL for Operations

The signature of the implied-IDL for a given IDL operation is:

- A type-specific Poller return type as described in Section 22.10, "Type-Specific Poller Mapping," on page 22-26, followed by **sendp\_<opName>** where **opName** is the name of the operation.

The async polling version takes the following parameters in order:

- Each of the **in** and **inout** arguments in the order that they appeared in the operation's declaration in IDL, all with a parameter attribute of **in** and with the type specifier and parameter name of the original argument.
- **out** arguments are ignored (i.e., are not part of the async signature).

The implied-IDL operation signature has a context expression identical to the one from the original operation (if any is present).

### 22.6.2.2 *Implied-IDL for Attributes*

The signature of the implied-IDL for the polling model getter and setter operations corresponding to an interface's attribute is as follows:

- Setter operations are only generated for attributes that are not defined readonly:
- A type-specific Poller return type as described in Section 22.10, “Type-Specific Poller Mapping,” on page 22-26, followed by the operation name, which to distinguish between the getter and setter operations for the attribute is given by either:
  - **sendp\_get\_<attributeName>** for reading the attribute value, where `attributeName` is the name of the attribute, or
  - **sendp\_set\_<attributeName>** for setting the attribute value, where `attributeName` is the name of the attribute that is not defined readonly.
- Asynchronous implied-IDL operations for attributes have argument lists as follows:
  - For the attribute's generated **get** operation, there are no arguments.
  - For the attribute's generated **set** operation, there is one argument, in **<attrType> attr\_<attributeName>**, where **attrType** is the type of the attribute, and **attributeName** is the name of that attribute. The **set** operation is only generated for attributes that are not defined readonly.

### 22.6.2.3 *Example*

The following implied-IDL is generated from the interface definitions used in the running example:

```
// AMI implied-IDL including polling operations
// for original example IDL defined in Section 22.5
exception InvalidStock { string sym; };

valuetype AMI_StockManagerPoller;

interface StockManager {
 // Original operation Declarations
 attribute string stock_exchange_name;
 boolean add_stock(in string symbol, in double quote);
 void edit_stock(in string symbol, in double new_quote)
 raises(InvalidStock);
 void remove_stock(in string symbol, out double quote)
 raises(InvalidStock);
 boolean find_closest_symbol(inout string symbol);
 double get_quote(in string symbol) raises(InvalidStock);

 // Async Polling operation Declarations
 AMI_StockManagerPoller sendp_get_stock_exchange_name();
 AMI_StockManagerPoller sendp_set_stock_exchange_name(
 in string attr_stock_exchange_name);
 AMI_StockManagerPoller sendp_add_stock(
```

```

 in string symbol,
 in double quote);
AMI_StockManagerPoller sendp_edit_stock(
 in string symbol, in double new_quote);
AMI_StockManagerPoller sendp_remove_stock(
 in string symbol);
AMI_StockManagerPoller sendp_find_closest_symbol(
 in string symbol);
AMI_StockManagerPoller sendp_get_quote(
 in string symbol);
};

```

## 22.7 Exception Delivery in the Callback Model

The **ReplyHandler** interface is expressed in IDL and thus cannot have operations that take exceptions as arguments. Furthermore, the most natural way for a **ReplyHandler** to deal with exceptions is by invoking some operation that raises exceptions, not through inspecting operation parameters. Therefore, exception replies are propagated to the **ReplyHandler** in the form of a type-specific **Messaging::ExceptionHolder** *valuetype* instance that contains the marshaled exception as its state and has **raise\_exception** and **raise\_exception\_with\_list** operations for raising the encapsulated exception.

### 22.7.1 Messaging::ExceptionHolder *valuetype*

The **Messaging::ExceptionHolder** *valuetype* encapsulates the exception data and enough information to turn that data back into a raised exception.

```

// IDL
module Messaging {

 // ... all the other stuff
 native UserExceptionBase;
 valuetype ExceptionHolder {
 void raise_exception() raises (UserExceptionBase);
 void raise_exception_with_list(
 in CORBA::ExceptionList exc_list
) raises (UserExceptionBase);
 private boolean is_system_exception;
 private boolean byte_order;
 private sequence<octet> marshaled_exception;
 };
};

```

- **raise\_exception()** - This method is used by applications to raise exception from the encapsulated **marshaled\_exception** member.
- **raise\_exception\_with\_list()** - If **is\_system\_exception** is true, this function is same as **raise\_exception()**. Otherwise, this method raises an exception from the **marshaled\_exception** using an application provided user exception list. It is



useful and should only be used when the given exception holder is not from a skeleton reply handler's `xxx_except()` method. For instance, it is from a DSI reply handler servant or from another ORB runtime. In these cases, the exception holder may not have an internal user exception list available.

- **UserExceptionBase** - Language mapping of this native type should allow any user exception to be raised from this method. For instance, it is mapped to `CORBA::UserException` in C++ and to `org.omg.CORBA.UserException` in java. As usual, system exceptions do not need to be in the raises clause for raising them from this method.

## 22.8 Type-Specific ReplyHandler Mapping

For each interface, a type-specific reply handler is generated by the IDL compiler. The client application implements and registers a reply handler with each asynchronous request and receives a callback when the reply is returned for that request. The interface name of the type-specific handler is **AMI\_<ifaceName>Handler**, where **ifaceName** is the original unqualified interface name. If the interface **ifaceName** derives from some other IDL interface **baseName**, then the handler for **ifaceName** is derived from **AMI\_<baseName>**, but if it does not, then it is derived from the generic **Messaging::ReplyHandler**. If the interface name **AMI\_<ifaceName>Handler** conflicts with an existing identifier, uniqueness is obtained by inserting additional “AMI\_” prefixes before the **ifaceName** until the generated identifier is unique.

When invoking an async operation, the client first generates an object reference for its **ReplyHandler** and then associates it with the request by passing the reference as an argument to the operation. The reply will be targeted to that **ReplyHandler**. So that a single **ReplyHandler** servant instance can be supplied to multiple requests, the client can assign unique **ObjectIds** for each request if the application code needs to distinguish between each of these requests at a later time. Most commonly, the application needs to access information from the calling scope while in the scope of the callback. That information can be associated with the **ReplyHandler**'s **ObjectId** by the client application at the time of invocation. Obtaining the **ReplyHandler**'s **ObjectId** within the callback implementation allows that implementation to obtain any information previously associated with the original request. Since the assignment and accessing of these **ObjectIds** is fully supported within the Portable Object Adapter defined in *CORBA*, there is no need to specify the notion of unique request ids in this document.

The **ReplyHandler** object reference will be serviced by a servant running under a POA with a particular set of POA policies. These policies are not affected by the fact that it is a **ReplyHandler**, so these Policy values have the same considerations as with any server. The POA **LifeSpanPolicy** will probably be affected depending on whether or not TII is used:

- If TII is not used, the **LifeSpanPolicy** can be either **PERSISTENT** or **TRANSIENT**, depending on the implementation. **LifeSpanPolicy** would likely be **PERSISTENT** if the same **ReplyHandler** implementation is used for replies from multiple clients. It could be **TRANSIENT** if the programmer creates the **ReplyHandler** object reference in the same process as that of the async invocation

and wants the **ReplyHandler** object reference to become invalid when the creating POA terminates. In this case, replies are discarded by the ORB once the client terminates.

- If TII is used, **LifeSpanPolicy** of **PERSISTENT** is almost required since TII means that the **ReplyHandler** can validly be located in a process that can be different than the process of the original client. It is possible for **LifeSpanPolicy** to be **TRANSIENT**, but this would be a rare usage in which the original client obtains the **ReplyHandler** reference from a process other than itself. This usage would allow a **ReplyHandler** to be in effect only for the life of that other process, supporting a rather limited form of TII.

### 22.8.1 *ReplyHandler Operations for NO\_EXCEPTION Replies*

For each operation declared in the interface, an operation with the following signature is defined on the generated reply handler:

- return type void, followed by
- the name of the operation, followed by
- arguments in order (all “in” parameters).
  - If the original operation has a return value, the type returned by the operation declared in IDL with parameter named **ami\_return\_val**.
  - Each inout/out **type** name and **argument** name as they were declared in IDL.

These operations do not raise any exceptions because they are never invoked by a client and have no client to respond to such an exception. Only a system exception could be raised by such operations, and only with the effect of causing a transaction to roll back. See Appendix C, “Changes to Current OTS Behavior” on page 22-85 for a discussion of the Unshared Transaction model in which a **ReplyHandler** may be invoked as part of a transaction.

For an attribute with the name “attributeName,” the following operations are generated on the reply handler: return type void, followed by **get\_<attributeName>** for the getter (or **set\_<attributeName>** for the setter operation if the attribute is not defined to be readonly). For the “get” operation, there is one argument (the setter callback operation takes no arguments): **in <attrType> ami\_return\_val** where the attribute of name **ami\_return\_val** is of type **attrType**.

There are two cases where the above mapping results in an operation with no parameters. The first is for an operation with no return value and either with no parameters or with only **in** parameters. The second is the mapping of a setter on an attribute. In these cases, it is worth noting that the only meaning that can be associated with the operation is that the AMI operation completed successfully. This is significant information, essentially an acknowledgment of completion.

## 22.8.2 ReplyHandler Operations for Exceptional Replies

If the AMI didn't succeed at the target, the exception is delivered via the generated **\_except ReplyHandler** operation corresponding to the operation originally invoked. This section describes the implied-IDL rules for generating these operations on the **ReplyHandler**.

For each operation, **operName**, on the original interface named **ifaceName**, an operation with the following signature is generated on the type-specific **ReplyHandler**:

```
void <operName>_except(
 in Messaging::ExceptionHolder excep_holder);
```

For each attribute, **attrName**, on the original interface named **ifaceName**, an operation with the following signature is generated on the type-specific **ReplyHandler**:

```
void get_<attrName>_except(
 in Messaging::ExceptionHolder excep_holder);
```

For each non-**readonly** attribute, **attrName**, on the original interface named **ifaceName**, an operation with the following signature is generated on the type-specific **ReplyHandler**:

```
void set_<attrName>_except(
 in Messaging::ExceptionHolder excep_holder);
```

If the name generated by the method described above clashes with a name that already exists in the interface, “\_ami” strings are inserted immediately preceding the “\_except” repeatedly, until generated IDL operation name is unique in the interface.

## 22.8.3 Example

The example IDL causes the generation of the following additional IDL when asynchronous operations are to be used. This IDL is “real” in that the interfaces described here are CORBA objects. However, the generation of stubs for these interfaces is not required, as no client ever invokes these operations remotely in this model. The operations are invoked directly by the messaging-aware ORB when a reply becomes available.

```
// AMI implied-IDL of ReplyHandler
// for original example IDL defined in Section 22.5
interface AMI_StockManagerHandler : Messaging::ReplyHandler {

 void get_stock_exchange_name(
 in string ami_return_val);
 void get_stock_exchange_name_except(
 in Messaging::ExceptionHolder excep_holder);
```

```

void set_stock_exchange_name();
void set_stock_exchange_name_except(
 in Messaging::ExceptionHolder excep_holder);

void add_stock(
 in boolean ami_return_val);
void add_stock_except(
 in Messaging::ExceptionHolder excep_holder);
void edit_stock();
void edit_stock_except(
 in Messaging::ExceptionHolder excep_holder);

void remove_stock(
 in double quote);
void remove_stock_except(
 in Messaging::ExceptionHolder excep_holder);

void find_closest_symbol(
 in boolean ami_return_val,
 in string symbol);
void find_closest_symbol_except(
 in Messaging::ExceptionHolder excep_holder);

void get_quote(
 in double ami_return_val);
void get_quote_except(
 in Messaging::ExceptionHolder excep_holder);
};

```

## 22.9 Generic Poller Value

The generic base **Poller valuetype** can be queried to obtain the status of a potentially outstanding request. So that it can be registered in a **CORBA::PollableSet**, it derives from the abstract valuetype **CORBA::Pollable**. The inherited **Pollable is\_ready** returns the value TRUE if and only if a reply is currently available for the outstanding request. If it returns the value FALSE, the reply has not yet been returned from the target. This operation raises the system exception **OBJECT\_NOT\_EXIST** if the reply has already been obtained by some client at the time of the query.

The Poller has the following definition:

```

module Messaging {
 valuetype Poller : CORBA::Pollable {
 readonly attribute Object operation_target;
 readonly attribute string operation_name;

 attribute ReplyHandler associated_handler;
 readonly attribute boolean is_from_poller;

 Object target;
 }
}

```

```

 string op_name;
 };
};

```

### 22.9.1 *operation\_target*

The target of the asynchronous invocation is accessible from any Poller.

### 22.9.2 *operation\_name*

The name of the operation that was invoked asynchronously is accessible from any Poller. The returned string is identical to the operation name from the target interface's **InterfaceDef**.

### 22.9.3 *associated\_handler*

If the **associated\_handler** is set to nil, the polling model is used to obtain the reply to the request. If it is non-nil, the associated **ReplyHandler** is invoked when a reply becomes available.

Switching between the callback and polling models is supported by this specification. The request must be made using the polling model, and thus a Poller is obtained. Through the attribute **associated\_handler**, a **ReplyHandler** may be registered. When the reply is available, the associated **ReplyHandler** will be invoked just as if the callback model had been used to make the original request. By setting the attribute to nil, the **ReplyHandler** can be disassociated at any time to allow the client application to resume use of the Polling model. The Poller implementation is responsible for ensuring that in multi-threaded applications, access to the **associated\_handler** is multi-thread safe.

### 22.9.4 *is\_from\_poller*

As described below, the type-specific pollers are queried to obtain the reply from an asynchronously invoked operation. If the reply is a system exception, it may be important for the client application to distinguish between an exception raised by the poll itself and an exception that is actually the reply for the asynchronous invocation. The **is\_from\_poller** attribute returns the value TRUE if and only if the poller itself has raised a system exception during the invocation of one of the type specific poller operations. If the exception raised from one of the type specific poller operations is the reply for the asynchronous operation, the value FALSE is returned. If the Poller has not yet returned a response to the client, the **BAD\_INV\_ORDER** system exception is raised.

## 22.10 Type-Specific Poller Mapping

The polling model requires usage of generated type-specific **Poller valuetypes**. A **valuetype** is used because all operations are locally implemented. The basic generated Poller encapsulates the operations for obtaining replies to an outstanding asynchronous request. A derived **PersistentPoller valuetype** also adds private state that allows the response to be obtained from a client other than the client that made the request. This private state is used by the **PersistentPoller** implementation in conjunction with the messaging-aware ORB.

### 22.10.1 Basic Type-Specific Poller

For each interface, the IDL compiler generates a type-specific Poller value. A Poller is created by the ORB for each asynchronous invocation that uses the polling model operations. The name of the basic type-specific Poller is **AMI\_<ifaceName>Poller**, where **ifaceName** is the unqualified name of the interface for which the Poller is being generated. If the interface **ifaceName** derives from some other IDL interface **baseName**, then the Poller for **ifaceName** is derived from **AMI\_<baseName>Poller**, but if it does not, then it is derived from **Messaging::Poller**. If this name conflicts with definitions in the original IDL, additional **AMI\_** prefixes are prepended before **<ifaceName>** until a unique **valuetype** name is generated (such as “**AMI\_AMI\_FooPoller**” for interface **Foo**).

#### 22.10.1.1 Poller operations for Interface operations

For each operation declared in the interface, a polling operation with the following signature is declared:

1. Return type void followed by
2. The name of the operation, followed by
3. A first parameter that is in unsigned long timeout indicating for how many milliseconds this call should wait until the response becomes available. If this timeout expires before a reply is available, the operation raises the system exception **CORBA:TIMEOUT**. Any delegated invocations used by the implementation of this polling operation are subject to the single timeout parameter, which supersedes any ORB or thread-level timeout quality of service. Two specific values are of interest:
  - 0 - the call is a non-blocking poll, which raises the exception **CORBA::NO\_RESPONSE** if the reply is not immediately available.
  - 232-1 - the maximum value for unsigned long indicates no timeout should be used. The poll will not return until the reply is available.

The remaining arguments, if any, are in order (all “out” parameters):

1. If the original operation has a return value, the type returned by the operation declared in IDL with parameter named **ami\_return\_val**.

2. Each inout/out type name and argument name as they were declared in IDL raises (<**exceptionList**>, **CORBA::WrongTransaction** where **exceptionList** contains the original operation raises exceptions, each exception from the original raises clause.
3. In addition, if the deferred synchronous model is being used:
  - the poll raises the **CORBA::WrongTransaction** user exception (if the request has an associated transaction context), and
  - the polling thread either has a null transaction context or a non-null transaction context that differs from that of the request.

When a polling call is made, the operation returns in one of the following ways:

1. With the out arguments set - the reply has been returned and future queries will raise the standard exception **OBJECT\_NOT\_EXIST**.
2. By raising the reply's exception - the reply has been returned and future queries will raise the standard exception **OBJECT\_NOT\_EXIST**. The base Poller's **is\_from\_poller** has a value of **FALSE**.
3. By raising a system exception or **CORBA::WrongTransaction** due to a failure in the polling operation. The base Poller's **is\_from\_poller** has a value of **TRUE**. Two specific exceptions are worth noting:
  - **CORBA::TIMEOUT** - If a non-zero timeout value is specified, this system exception is raised to indicate that the specified timeout has expired and the reply has not yet been returned.
  - **CORBA::NO\_RESPONSE** - If a timeout with value 0 is specified, this system exception is raised to indicate that the reply is not available.

### 22.10.1.2 Poller operations for Interface attributes

For each attribute declared in the interface, a polling operation with the following signature is declared. Setter polling operations are only generated for attributes that are not declared readonly: return type void followed by the name of the generated operation, which to distinguish between the getter and setter operations for an attribute is given by (respectively):

- **get\_<attributeName>**, where **attributeName** is the name of the interface's attribute, or
- **set\_<attributeName>**, where **attributeName** is the name of the interface's attribute that was not declared readonly.

A first parameter that is in unsigned long timeout indicating how many milliseconds this call should wait until the response becomes available. If this timeout expires before a reply is available, the operation raises the system exception **CORBA::TIMEOUT**. Any delegated invocations used by the implementation of this polling operation are subject to the single timeout parameter, which supersedes any ORB or thread-level timeout quality of service. Two specific values are of interest:

- 0 - the call is a non-blocking poll, which raises the exception **CORBA::NO\_RESPONSE** if the reply is not immediately available.

- 232-1 - the maximum value for **unsigned long** indicates no timeout should be used. The poll will not return until the reply is available.

#### *For the getter operation only*

An additional argument **out <attrType> ami\_return\_val** where **attrType** is the type of the attribute.

The **set** operation takes no additional arguments.

Raises (**CORBA::WrongTransaction**) - If the deferred synchronous model is being used, the poll raises the **CORBA::WrongTransaction** user exception if the request has an associated transaction context, and the polling thread either has a null transaction context or a non-null transaction context that differs from that of the request.

When a polling call is made, the operation returns in one of the following ways:

- With the out arguments set - the reply has been returned and future queries will raise the standard exception **OBJECT\_NOT\_EXIST**.
- By raising the reply's exception - the reply has been returned and future queries will raise the standard exception **OBJECT\_NOT\_EXIST**. The base Poller's **is\_from\_poller** has a value of **FALSE**.
- By raising a system exception or **CORBA::WrongTransaction** due to a failure in the polling operation. The base Poller's **is\_from\_poller** has a value of **TRUE**. Two specific exceptions are worth noting:
  - **CORBA::TIMEOUT** - If a non-zero timeout value is specified, this system exception is raised to indicate that the specified timeout has expired and the reply has not yet been returned.
  - **CORBA::NO\_RESPONSE** - If a timeout with value 0 is specified, this system exception is raised to indicate that the reply is not available.

### 22.10.2 *Persistent Type-Specific Poller*

When Time-Independent Invocations are made, the reply may be obtained by a different client than the one that made the original request. An instance of persistent poller is returned from such invocations. The **PersistentPoller** contains the state necessary to allow polling to be performed in a client distinct from the one that made the request. This state is used privately by the messaging-aware ORB and is not directly accessible to the application.

The generated **PersistentPoller valuetype** is derived from the basic one. It adds no methods, only one piece of private state. For an interface with the unqualified name **ifaceName** the following **PersistentPoller** is generated:

```
valuetype AMI_<ifaceName>PersistentPoller : AMI_<ifaceName>Poller {
 MessageRouting::PersistentRequest outstanding_request;
};
```



Just as with any CORBA **valuetype** this **PersistentPoller** can be passed as an argument to IDL operations and a copy of the **Poller** will be instantiated local to the callee.

### 22.10.3 Example

The example IDL causes the generation of the following additional IDL when asynchronous polling operations are to be used. This IDL is “real” in that the **valuetypes** described here are normal CORBA **valuetypes**.

```

// AMI implied-IDL of type-specific Poller
// for original example IDL defined in Section 22.5
valuetype AMI_StockManagerPoller : Messaging::Poller {
 void get_stock_exchange_name(
 in unsigned long timeout,
 out string ami_return_val)
 raises (CORBA::WrongTransaction);
 void set_stock_exchange_name(
 in unsigned long timeout)
 raises (CORBA::WrongTransaction);
 void add_stock(
 in unsigned long timeout,
 out boolean ami_return_val)
 raises (CORBA::WrongTransaction);
 void edit_stock(
 in unsigned long timeout)
 raises (InvalidStock, CORBA::WrongTransaction);
 void remove_stock(
 in unsigned long timeout,
 out double quote)
 raises (InvalidStock, CORBA::WrongTransaction);
 void find_closest_symbol(
 in unsigned long timeout,
 out boolean ami_return_val,
 out string symbol)
 raises (CORBA::WrongTransaction);
 void get_quote(
 in unsigned long timeout,
 out double ami_return_val)
 raises (InvalidStock, CORBA::WrongTransaction);

 attribute AMI_StockManagerHandler associated_handler;
};

valuetype AMI_StockManagerPersistentPoller : AMI_StockManagerPoller
{
 MessageRouting::PersistentRequest request;
};

```

## 22.11 Example Programmer Usage

### 22.11.1 Example Programmer Usage (Examples Mapped to C++)

The following is an illustrative example of how the ideas from Section 22.4, “Section II - Introduction,” on page 22-13 and other sections come together from the programmer’s point of view. It contains no new definitions; Section 22.11, “Example Programmer Usage,” on page 22-30 is solely meant to demonstrate an application use of Messaging. Since the example is implemented in C++, the expected C++ mapping of Section 22.4, “Section II - Introduction,” on page 22-13 implied-IDL is shown in Section 22.11, “Example Programmer Usage,” on page 22-30.

### 22.11.2 Client-Side C++ Example for the Asynchronous Method Signatures

This section shows sample C++ that is generated from the implied-IDL of the previous subsections of Section 22.4, “Section II - Introduction,” on page 22-13. The C++ mapping specifies a generated interface class (stub) on which method invocations are translated into operation requests. It is this class on which the function signatures are generated from their operation declarations in IDL. It is in this class that the async functions signatures are also declared (and implemented). Using the IDL from the example in the previous section the stub class **StockManager** is generated following the C++ mapping. The following notes apply to this sample generated C++ code:

- Only the generated synchronous and asynchronous method signatures are shown. Vendor-specific constructors, methods, and members are omitted.
- Although optional according to the IDL to C++ language mapping, method signatures are generated as virtual.
- Since optional according to the IDL to C++ language mapping, exception specifications are not included in generated methods.

```
// Generated file: stockmgr_c.hh (Filename is non-normative)

// C++ - StockManager declaration
class StockManager : public virtual CORBA::Object
{
public:
// ... all the other stuff.
// StockManager SYNCHRONOUS CALLS
virtual void stock_exchange_name(const char * attr);
virtual char * stock_exchange_name();
virtual CORBA::Boolean add_stock(const char* symbol, CORBA::Double q);
virtual void edit_stock(const char* symbol, CORBA::Double q);
virtual void remove_stock(const char* symbol, CORBA::Double_out q);
virtual CORBA::Boolean find_closest_symbol(CORBA::String_out symbol);
virtual CORBA::Double get_quote(const char * symbol);

// ASYNCHRONOUS CALLBACK-MODEL CALLS
virtual void sendc_get_stock_exchange_name(
 AMI_StockManagerHandler_ptr ami_handler);
virtual void sendc_set_stock_exchange_name(
```

```

 AMI_StockManagerHandler_ptr ami_handler,
 const char* attr_stock_exchange_name);
virtual void sendc_addStock(
 AMI_StockManagerHandler_ptr ami_handler,
 const char* symbol, CORBA::Double q);
virtual void sendc_editStock(
 AMI_StockManagerHandler_ptr ami_handler,
 const char* symbol, CORBA::Double q);
virtual void sendc_removeStock(
 AMI_StockManagerHandler_ptr ami_handler,
 const char* symbol);
virtual void sendc_find_closest_symbol(
 AMI_StockManagerHandler_ptr ami_handler,
 const char * symbol);
virtual void sendc_get_quote(
 AMI_StockManagerHandler_ptr ami_handler,
 const char * symbol);

// ASYNCHRONOUS POLLING-MODEL CALLS
virtual AMI_StockManagerPoller* sendp_get_stock_exchange_name();
virtual AMI_StockManagerPoller* sendp_set_stock_exchange_name(
 const char* attr_stock_exchange_name);
virtual AMI_StockManagerPoller* sendp_addStock(
 const char* symbol, CORBA::Double q);
virtual AMI_StockManagerPoller* sendp_editStock(
 const char* symbol, CORBA::Double q);
virtual AMI_StockManagerPoller* sendp_removeStock(
 const char* symbol);
virtual AMI_StockManagerPoller* sendp_find_closest_symbol(
 const char * symbol);
virtual AMI_StockManagerPoller* sendp_get_quote(
 const char * symbol);
};

```

### 22.11.3 Client-Side C++ Example of the Callback Model

#### 22.11.3.1 C++ Example of Generated ReplyHandler

The `ReplyHandler` Servant class generated for the `StockManager` interface is:

```

// Generated file: stockmgr_s.hh (Filename is non-normative)
// C++ - AMI_StockManagerHandler declaration
class POA_AMI_StockManagerHandler
 : public POA_Messaging::ReplyHandler
{
public:
// Programmer must implement the following pure virtuals:

// Mappings for attribute handling functions
virtual void get_stock_exchange_name(
 const char * ami_return_val) = 0;
virtual void get_stock_exchange_name_excep(

```

```

 Messaging::ExceptionHandler_ptr excep_holder) = 0;

virtual void set_stock_exchange_name() = 0;
virtual void set_stock_exchange_name_except(
 Messaging::ExceptionHandler_ptr excep_holder) = 0;

// Mappings for the operation handling functions
virtual void add_stock(CORBA::Boolean ami_return_val) = 0;
virtual void add_stock_except(
 Messaging::ExceptionHandler_ptr excep_holder) = 0;

virtual void edit_stock() = 0; virtual void edit_stock_except(
 Messaging::ExceptionHandler_ptr excep_holder) = 0;

virtual void remove_stock(
 CORBA::Double quote) = 0;
virtual void remove_stock_except(
 Messaging::ExceptionHandler_ptr excep_holder) = 0;

virtual void find_closest_symbol(
 CORBA::Boolean ami_return_val,
 const char * symbol) = 0;
virtual void find_closest_symbol_except(
 Messaging::ExceptionHandler_ptr excep_holder) = 0;

virtual void get_quote(
 CORBA::Double d) = 0;
virtual void get_quote_except(
 Messaging::ExceptionHandler_ptr excep_holder) = 0;
};

```

The programmer must now derive from the generated handler and implement the pure virtual methods. The following points should be considered when implementing these handler-derived reply handlers:

- System and User exceptions are “raised” through invocations of the generated “\_except” operations. If a regular type-specific operation is invoked, the reply was not an exception.
- Any exception raised from a **ReplyHandler** method can only be visible to the messaging-aware ORB that is invoking that **ReplyHandler**. In most cases, this means that exceptions should never be raised. In the case of an Unshared Transaction, the **ReplyHandler** method may invoke **CosTransactions::Current::rollback\_only** or **CosTransactions::coordinator::rollback\_only** and then raise the **CORBA::TRANSACTION\_ROLLEDBACK** system exception to roll back this attempted delivery of the reply.
- All heap-allocated storage associated with any of the arguments to the **ReplyHandler** methods may be owned by the ORB. If so, any data passed into the handler must be copied if the data is to be kept. This corresponds to the usual memory management rules for **in** arguments.

### 22.11.3.2 C++ Example of User -Implemented ReplyHandler

The following code is an example implementation of a user derived and implemented reply handler based on the generated reply handler from Section 22.11.3.1, “C++ Example of Generated ReplyHandler,” on page 22-31. The inherited methods, which were previously declared as pure virtual are declared here as virtual and are implemented as part of this class:

```
// File: AsyncStockHandler.h
// C++ - Declaration in my own header
#include "stockmgr_s.hh"// Include filename non-normative

class AsyncStockHandler : public POA_AMI_StockManagerHandler
{
public:
AsyncStockHandler() { }
virtual ~AsyncStockHandler() {}

// Mappings for attribute handling functions
virtual void get_stock_exchange_name(
 const char * ami_return_val);
virtual void get_stock_exchange_name_except(
 Messaging::ExceptionHolder_ptr excep_holder);

virtual void set_stock_exchange_name();
virtual void set_stock_exchange_name_except(
 Messaging::ExceptionHolder_ptr excep_holder);

// Mappings for the operation handling functions
virtual void add_stock(CORBA::Boolean ami_return_val);
virtual void add_stock_except(
 Messaging::ExceptionHolder_ptr excep_holder);

virtual void edit_stock();
virtual void edit_stock_except(
 Messaging::ExceptionHolder_ptr excep_holder);

virtual void remove_stock(
 CORBA::Double quote);
virtual void remove_stock_except(
 Messaging::ExceptionHolder_ptr excep_holder);

virtual void find_closest_symbol(
 CORBA::Boolean ami_return_val,
 const char * symbol);
virtual void find_closest_symbol_except(
 Messaging::ExceptionHolder_ptr excep_holder);

virtual void get_quote(
 CORBA::Double d);
virtual void get_quote_except(
```

```

 Messaging::ExceptionHandler_ptr excep_holder);
};

```

Each of these callback operations have implementations as in the following. Please note that for the sake of brevity, each pointer is not checked before it is used. This is intentional.

```

// AsyncStockHandler.cpp
#include <AsyncStockHandler.h>

void
AsyncStockHandler::get_stock_exchange_name(
const char * ami_return_val)
{
cout << "Exchange Name = " << ami_return_val << endl;
}
void
AsyncStockHandler::get_stock_exchange_name_excep(
 Messaging::ExceptionHandler_ptr excep_holder);
{
try {
 excep_holder->raise_exception();
}
catch (const CORBA::SystemException& e) {
 cout << "Get stock_exchange_name exception [" << e << "]" << endl;
}
}

void
AsyncStockHandler::set_stock_exchange_name()
{
// No data returned since this was the "set" of the attribute.
cout << "Set stock_exchange_name succeeded!" << endl;
}
void
AsyncStockHandler::set_stock_exchange_name_excep(
 Messaging::ExceptionHandler_ptr excep_holder)
{
try {
 excep_holder->raise_exception();
}
catch (const CORBA::SystemException& e) {
 cout << "Set stock_exchange_name exception [" << e << "]" << endl;
}
}

void
AsyncStockHandler::add_stock()
{
// No data returned but no exception either which is good news.
cout << "Stock was added!" << endl;
}

```

```

}
void
AsyncStockHandler::add_stock_excep(
 Messaging::ExceptionHolder_ptr excep_holder)
{
try {
 excep_holder->raise_exception();
}
catch (const CORBA::SystemException& e) {
 cout << "add_stock exception [" << e << "]" << endl;
}
}

void
AsyncStockHandler::edit_stock()
{
// No return data but no exception either which is good.
cout << "Stock was edited!" << endl;
}
void
AsyncStockHandler::edit_stock_excep(
 Messaging::ExceptionHolder_ptr excep_holder)
{
try {
 excep_holder->raise_exception();
}
catch (const CORBA::SystemException& e) {
 cout << "edit_stock System Exception exception [" << e << "]" <<
 endl;
}
catch (const InvalidStock& e) {
 cout << "edit_stock invalid symbol [" << e.sym << "]" << endl;
}
}

void
AsyncStockHandler::remove_stock(
 CORBA::Double quote)
{
cout << "Stock Removed and quote = " << quote << endl;
}
void
AsyncStockHandler::remove_stock_excep(
 Messaging::ExceptionHolder_ptr excep_holder)
{
try {
 excep_holder->raise_exception();
}
catch (const CORBA::SystemException& e) {
 cout << "remove_stock System Exception exception [" << e << "]" <<
 endl;
}
}

```

```
}
catch (const InvalidStock& e) {
 cout << "remove_stock invalid symbol [" << e.sym << "]" << endl;
}
}

void
AsyncStockHandler::find_closest_symbol(
CORBA::Boolean ami_return_val,
const char* symbol)
{
if (ami_return_val)
 cout << "Closest stock = " << symbol << endl;
else
 cout << "No closest stock could be found!" << endl;
}

void
AsyncStockHandler::find_closest_symbol_except(
 Messaging::ExceptionHolder_ptr excep_holder)
{
try {
 excep_holder->raise_exception();
}
catch (const CORBA::SystemException& e) {
 cout << "find_closest_symbol exception [" << e << "]" << endl;
}
}

void
AsyncStockHandler::get_quote(CORBA::Double quote)
{
cout << "Quote = " << quote << endl;
}

void
AsyncStockHandler::get_quote_except(
 Messaging::ExceptionHolder_ptr excep_holder)
{
try {
 excep_holder->raise_exception();
}
catch (const CORBA::SystemException& e) {
 cout << "get_quote System Exception exception [" << e << "]" <<
 endl;
}
catch (const InvalidStock& e) {
 cout << "get_quote invalid symbol [" << e.sym << "]" << endl;
}
}
}
```



### 22.11.3.3 C++ Example of Callback Client Program

The following code shows how to set QoS at the ORB and object reference scopes (the two most common levels) and make asynchronous invocations using the user-implemented reply handler from the previous section. Again, for the sake of brevity, checking for valid pointers and placing all of the CORBA calls in try blocks has been omitted.

```
// callback_client_main.cpp
#include <AsyncStockHandler.h>
int main(int argc, char ** argv)
{
 // Initialize the ORB
 CORBA::ORB_var orb = CORBA::ORB_init(argc, argv);

 // Initializing objRef for StockManager -- assumes IOR is passed
 // on command-line
 CORBA::Object_var obj = orb->string_to_object(argv[1]);
 StockManager_var stockMgr = StockManager::_narrow(obj);

 // Obtain the ORB's PolicyManager
 CORBA::Object_var orbQosObj =
 orb->resolve_initial_references("ORBPolicyManager");
 CORBA::PolicyManager_var orbQos =
 CORBA::PolicyManager::_narrow(orbQosObj);

 // Create and apply an ORB-wide Routed Delivery QoS
 CORBA::Any routing_val;
 Messaging::RoutingTypeRange routing;
 routing.min = Messaging::FORWARD;
 routing.max = Messaging::STORE_AND_FORWARD;
 routing_val <<= routing;
 CORBA::PolicyList orb_pols(1);
 orb_pols.length(1);
 orb_pols[(CORBA::ULong) 0] =
 orb->create_policy(Messaging::ROUTING_POLICY_TYPE, routing_val);
 orbQos->set_policy_overrides(orb_pols, CORBA::ADD_OVERRIDE);

 // Create and apply an object-reference-specific Priority QoS
 CORBA::Any priority_val;
 Messaging::PriorityRange priority;
 priority.min = 5;
 priority.max = 15;
 priority_val <<= priority;
 CORBA::PolicyList obj_pols(1);
 obj_pols.length(1);
 obj_pols[(CORBA::ULong) 0] =
 orb->create_policy(Messaging::REQUEST_PRIORITY_POLICY_TYPE,
 priority_val);
 stockMgr = stockMgr->set_policy_overrides(obj_pols);
}
```

```

// At this point QoS has been set and a protocol selected.

// Create an async handler for each async function.
// Note that the same handler instance could be used across the board
// if we wanted to only create a new Object Reference for each
// invocation and then correlate the timing data with each ObjectId
// ourselves.
//
// The following code assumes implicit activation of Servants with the
// RootPOA
AsyncStockHandler* handlerImpls[6];
for (int i = 0; i < 6; i++)
 handlerImpls[i] = new AsyncStockHandler();

AMI_StockManagerHandler_var handlerRefs[6];
for (int i=0; i < 6; i++)
 handlerRefs[i] = handlerImpls[i]._this();

// Async Attributes
stockMgr->sendc_set_stock_exchange_name(handlerRefs[0], "NSDQ");
stockMgr->sendc_get_stock_exchange_name(handlerRefs[1]);
// Async Operations
stockMgr->sendc_add_stock(handlerRefs[2], "ACME", 100.5);
stockMgr->sendc_edit_stock(handlerRefs[3], "ACME", 150.4);

// Notice no out param is passed.
stockMgr->sendc_remove_stock(handlerRefs[4], "ABC");

stockMgr->sendc_find_closest_symbol(handlerRefs[5], "ACMA");

// callbacks get invoked during other distributed requests and during
// eventloop processing.
// Assume that done is set by handler implementation when all replies
// have been received or request have timed out.while(!done)
 orb->perform_work();
return 0;
}

```

## 22.11.4 Client-Side C++ Example of the Polling Model

### 22.11.4.1 C++ Example of Generated Poller

The typed **Poller valuetype** class implementation is provided by the messaging-aware ORB. The generated C++ class has the following declaration:

```

// Generated file: stockmgr_c.hh (Filename is non-normative)
class AMI_StockManagerPoller : public Messaging::Poller
{
public:

```

```

virtual void get_stock_exchange_name(
 CORBA::ULong timeout,
 CORBA::String_out ami_return_val);

virtual void set_stock_exchange_name(
 CORBA::ULong timeout);

virtual void add_stock(
 CORBA::ULong timeout,
 CORBA::Boolean_out ami_return_val);

virtual void edit_stock(CORBA::ULong timeout);

virtual void remove_stock(
 CORBA::ULong timeout,
 CORBA::Double_out quote);

virtual void find_closest_symbol(
 CORBA::ULong timeout,
 CORBA::Boolean_out ami_return_val,
 CORBA::String_out symbol);

virtual void get_quote(
 CORBA::ULong timeout,
 CORBA::Double_out ami_return_val);

virtual AMI_StockManagerHandler_ptr associated_handler();
virtual void associated_handler(AMI_StockManagerHandler_ptr _val);
};

```

#### 22.11.4.2 C++ Example of Polling Client Program

The following example client program demonstrates the use of the Polling model. The bulk of the program is exactly the same as the program demonstrated in Section 22.11.3.3, “C++ Example of Callback Client Program,” on page 22-37. Each invocation uses the polling “sendp\_” in this program and the returned Pollers are then sequentially called to obtain the results. The following notes apply to this sample program:

- All polling calls are fully blocking (no timeouts are used).
- Since transactions are not used in this example, the polling program does not catch `CORBA::WrongTransaction` exceptions.

```

// polling_client_main.cpp
#include <stockmgr_c.hh> // include filename is non-normative
int main(int argc, char ** argv)
{
 // Initialize the ORB
 CORBA::ORB_var orb = CORBA::ORB_init(argc, argv);

```

```
// Initializing objRef for StockManager -- assumes IOR is passed
// on command-line
CORBA::Object_var obj = orb->string_to_object(argv[1]);
StockManager_var stockMgr = StockManager::_narrow(obj);

// Obtain the ORB's PolicyManager
CORBA::Object_var orbQosObj =
 orb->resolve_initial_references("ORBPolicyManager");
CORBA::PolicyManager_var orbQos =
 CORBA::PolicyManager::_narrow(orbQosObj);

// Create and apply an ORB-wide Routed Delivery QoS
CORBA::Any routing_val;
Messaging::RoutingTypeRange routing;
routing.min = Messaging::FORWARD;
routing.max = Messaging::STORE_AND_FORWARD;
routing_val <<= routing;
CORBA::PolicyList orb_pols(1);
orb_pols.length(1);
orb_pols[(CORBA::ULong) 0] =
 orb->create_policy(Messaging::ROUTING_POLICY_TYPE, routing_val);
orbQos->set_policy_overrides(orb_pols, CORBA::ADD_OVERRIDE);

// Create and apply an object-reference-specific Priority QoS
CORBA::Any priority_val;
Messaging::PriorityRange priority;
priority.min = 5;
priority.max = 15;
priority_val <<= priority;
CORBA::PolicyList obj_pols(1);
obj_pols.length(1);
obj_pols[(CORBA::ULong) 0] =
 orb->create_policy(Messaging::REQUEST_PRIORITY_POLICY_TYPE,
 priority_val);
stockMgr = stockMgr->set_policy_overrides(obj_pols);

// At this point QoS has been set and a protocol selected.

// Make each invocation and store the returned Pollers
AMI_StockManagerPoller* pollers[6];

// Async Attributes
pollers[0] = stockMgr->sendp_set_stock_exchange_name("NSDQ");
pollers[1] = stockMgr->sendp_get_stock_exchange_name();

// Async Operations
pollers[2] = stockMgr->sendp_add_stock("ACME", 100.5);
pollers[3] = stockMgr->sendp_edit_stock("ACME", 150.4);

// Notice no out param is passed.
pollers[4] = stockMgr->sendp_remove_stock("ABC");
```

```

pollers[5] = stockMgr->sendp_find_closest_symbol("ACMA");

// Now obtain each result
CORBA::ULong max_timeout = (CORBA::ULong) -1;
pollers[0]->set_stock_exchange_name(max_timeout);
cout << "Setting stock exchange name succeeded" << endl;

CORBA::String_var exchange_name;
pollers[1]->get_stock_exchange_name(
 max_timeout,
 exchange_name.out());
cout << "Obtained stock exchange name [" << exchange_name << "]"
 << endl;

CORBA::Boolean stock_added;
pollers[2]->add_stock(
 max_timeout,
 stock_added);
if (stock_added)
 cout << "Stock added successfully" << endl;
else
 cout << "Stock not added" << endl;

try {
 pollers[3]->edit_stock(max_timeout);
 cout << "Edited stock successfully" << endl;
}
catch (const CORBA::Exception& e) {
 cout << "Edit stock failure [" << e << "]" << endl;
}

try {
 CORBA::Double quote;
 pollers[4]->remove_stock(
 max_timeout,
 quote);
 cout << "Removed stock successfully with quote [" << quote << "]"
 << endl;
}
catch (const CORBA::Exception& e) {
 cout << "Remove stock failure [" << e << "]" << endl;
}

CORBA::Boolean closest_found;
CORBA::String_var symbol;
pollers[5]->find_closest_symbol(
 max_timeout,
 closest_found, symbol.out());
if (closest_found)
 cout << "Found closest symbol [" << symbol << "]" << endl;

```

```

cout << "Exiting Polling Client" << endl;
return 0;
}

```

### 22.11.4.3 C++ Example of Using PollableSet in a Client Program

The following example client program demonstrates the use of the `PollableSet` and wait for multiple requests to finish. The program would be exactly the same as that of the previous section, as far as the comment “// **Now obtain each result**”.

In this example, after the `PollableSet::poll` indicates that a particular Poller has finished, the code makes the call on the type-specific poller in a non-blocking manner and doesn't bother checking for completion in the return value. Checking isn't necessary when only a single client is using the Poller, but it is the safe practice if multiple clients are waiting.

```

// Obtain results in any order. First set up
// the PollableSet.
CORBA::PollableSet_var poll_set =
pollers[0]->create_pollable_set();

CORBA::Pollable_var pollables[6];
for (int i=0; i<6, i++) {
 pollables[i] = pollers[i]._this();
 poll_set->add_pollable(pollables[i]);
}

// repeat until all completions have been received
CORBA::ULong max_timeout = (CORBA::ULong) -1;
while (poll_set->number_left() > 0) {
 // wait for a completion
 CORBA::Pollable_ptr pollable = poll_set->poll(max_timeout);
 // the returned Pollable is ready to return its reply
 for (int j=0; j < 6; j++) {
 if (pollables[j]->is_equivalent(pollable)) break;
 }

 switch(j) {
 case 0:
 pollers[0]->set_stock_exchange_name(0UL);
 cout << "Setting stock exchange name succeeded"
 << endl;
 break;

 case 1:
 CORBA::String_var exchange_name;
 pollers[1]->get_stock_exchange_name(0UL, exchange_name.out());
 cout << "Obtained stock exchange name ["
 << exchange_name << "]" << endl;
 break;
 }
}

```

```
case 2:
 CORBA::Boolean stock_added;
 pollers[2]->add_stock(0UL, stock_added);
 if (stock_added)
 cout << "Stock added successfully" << endl;
 else
 cout << "Stock not added" << endl;
 break;

case 3:
 try {
 pollers[3]->edit_stock(0UL);
 cout << "Edited stock successfully" << endl;
 }
 catch (const CORBA::Exception& e) {
 cout << "Edit stock failure [" << e << "]"
 << endl;
 }
 break;

case 4:
 try {
 CORBA::Double quote;
 pollers[4]->remove_stock(0UL, quote);
 cout << "Removed stock successfully with quote ["
 << quote << "]" << endl;
 }
 catch (const CORBA::Exception& e) {
 cout << "Remove stock failure [" << e << "]"
 << endl;
 }
 break;

case 5:
 CORBA::Boolean closest_found;
 CORBA::String_var symbol;
 pollers[5]->find_closest_symbol(0UL, closest_found,
 symbol.out());
 if (closest_found)
 cout << "Found closest symbol [" << symbol
 << "]" << endl;
 break;
}
}

cout << "All replies received. Exiting Polling Client"
 << endl;
return 0;
}
```

### 22.11.5 Server Side

The following example of the **server-side main()** assumes a C++ implementation of the **StockManager** interface called **StockManager\_impl**.

```
#include <StockManagerImpl.h> // Implementation header

int main(int argc, char ** argv)
{
 // Initialize the ORB
 CORBA::ORB_var orb = CORBA::ORB_init(argc, argv);
 // Obtain the POA
 PortableServer::POA_var poa =
 orb->resolve_initial_references("RootPOA");

 // Create a POA that supports Unshared transactions and processes
 // queued requests in priority order
 CORBA::Any policy_val;
 CORBA::PolicyList pols(2);
 pols.length(2);

 policy_val <<= (Messaging::PRIORITY | Messaging::DEADLINE);
 pols[(CORBA::ULong) 0] =
 orb->create_policy(Messaging::QUEUE_ORDER_POLICY_TYPE,
 policy_val);

 policy_val <<= CosTransactions::Allows_either;
 pols[(CORBA::ULong) 1] =
 orb->create_policy(CosTransactions::TRANSACTION_POLICY_TYPE,
 policy_val);
 poa = poa->create_POA(
 "MessagingPOA",
 PortableServer::POAManager::_nil(),
 pols);

 // Instantiate the servant.
 StockManager_impl* stockMgr = new StockManager_impl("NYSE");
 // register the servant for use.
 PortableServer::ObjectId_var servantId =
 poa->activate_object(stockMgr);
 orb->run();
 return 0;
}
```



## Section III - Message Routing Interoperability

### 22.12 Section III - Introduction

Asynchronous method invocation and time-independent delivery of requests and responses cannot be handled in a first-class manner within the synchronous dialog of the GIOP 1.1. The basic requirement for Messaging is that individual request and reply messages (and their components) can be discussed by routing agents. These agents, or *Routers*, explicitly pass messages between them and interact with clients and targets of asynchronous operations. This section describes the interactions between a client and the first Router to handle its request, between successive Routers as the request is passed along the path to the target, and between the target and the Router that actually makes the request on behalf of the original client. This Router closest to the Target then turns the reply into a Request on a **ReplyHandler**, allowing the Reply to be routed using the same mechanism as the original request. The reply is finally delivered to an application's **ReplyHandler** or through an application's use of the Polling APIs.

**Note** – This Introduction specifies Routing interoperability for CORBA Messaging products. The information presented in this section is not required for building applications that make Asynchronous operation invocations.

Throughout this Introduction a configuration is assumed in which the Client is separated from the Target by the Internet. Using this “most complex” scenario, all the details of the Routing procedure are exposed. To help understand this design, consider Figure 22-1.

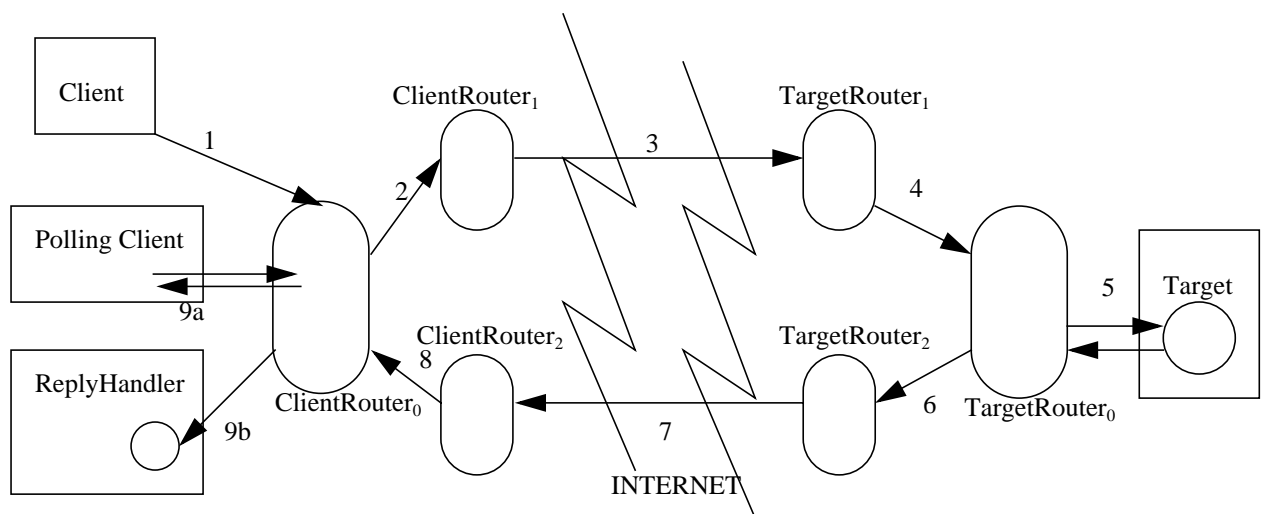

Figure 22-1 Routing Interoperability Overview

### 22.13 Routing Object References

This specification is designed to support scenarios in which a target may be disconnected for a long period of time. It would be inefficient for a client's router to need to monitor the availability of all targets for which it holds outstanding requests. To make this scenario scalable, it is possible for the target to specify a more highly available temporary destination for its asynchronous requests. This destination is a Router, and the natural place for the target to specify this Router's location is within a component of the Target's IOR. For extensibility, this specification defines a **TaggedComponent** that contains a sequence of Router IORs.

```
module MessageRouting {
 const IOP::ComponentId TAG_MESSAGE_ROUTERS = 3;

 interface Router;
 typedef sequence<Router> RouterList;
};
```

A **TaggedComponent** containing Target routing hints is built by setting the tag member to **MessageRouting::TAG\_MESSAGE\_ROUTERS** and the **component\_data** to a CDR encapsulation of a **MessageRouting::RouterList**. This component can appear in **TAG\_INTERNET\_IOP** and **TAG\_MULTIPLE\_COMPONENTS** profiles.

Routers are listed in this sequence in order from most highly available to least highly available. It is expected that the least highly available Router will be "closest" to the Target, whereas the most highly available Target Router will be "closest" to the Internet. For example, the target in the reference example of Section 22.12, "Section III - Introduction," on page 22-45 would have an IOR containing a **TAG\_MESSAGE\_ROUTERS** Component containing a sequence of two Router IORs. The first element in this sequence would be the reference of **TargetRouter1** and the second element would be the reference of **TargetRouter**.

### 22.14 Message Routing

The messaging Routers serve two main purposes:

- forward a message to another Router, and
- synchronously deliver a message to its intended target.

This section explains the interfaces and mechanisms that support these two functions of Routers. The interfaces described here are not exposed to the application programmer in any way. They are intended entirely for use by Messaging vendors to support interoperability between messaging implementations.

The following IDL is used to route asynchronous requests and their corresponding replies:

```
// IDL
module Messaging {
```

```

interface ReplyHandler { };
};

module MessageRouting {

struct MessageBody {
 sequence<octet> body;
 boolean byte_order;
};

struct RequestMessage {
 GIOP::Version giop_version;
 IOP::ServiceContextList service_contexts;
 octet response_flags;
 octet reserved[3];
 sequence<octet> object_key;
 string operation;
 MessageBody body;
};

enum ReplyDisposition { TYPED, UNTYPED };
struct ReplyDestination {
 ReplyDisposition handler_type;
 Messaging::ReplyHandler handler;
};

interface Router;
typedef sequence<Router> RouterList;
struct RequestInfo {
 RouterList visited;
 RouterList to_visit;
 Object target;
 unsigned short profile_index;
 ReplyDestination reply_destination;
 Messaging::PolicyValueSeq selected_qos;
 RequestMessage payload;
};
typedef sequence<RequestInfo> RequestInfoSeq;

interface Router {
 void send_request(in RequestInfo req);
 void send_multiple_requests(in RequestInfoSeq reqSeq);
};

//
// Polling-related interfaces
//

interface UntypedReplyHandler : Messaging::ReplyHandler {
 void reply(
 in string operation_name,

```

```

 in GIOP::ReplyStatusType reply_type,
 in MessageBody reply_body);
};

exception ReplyNotAvailable { };

interface PersistentRequest {
 readonly attribute boolean reply_available;

 GIOP::ReplyStatusType get_reply(
 in boolean blocking,
 in unsigned long timeout,
 out MessageBody reply_body)
 raises (ReplyNotAvailable);

 attribute Messaging::ReplyHandler associated_handler;
};

interface PersistentRequestRouter {
 PersistentRequest create_persistent_request(
 in unsigned short profile_index,
 in RouterList to_visit,
 in Object target,
 in CORBA::PolicyList current_qos,
 in RequestMessage payload);
};
};
};

```

## 22.14.1 Structures

### 22.14.1.1 *MessageBody*

This structure is used to wrap the marshaled GIOP message data (either request arguments or reply data) to support repackaging as the request components around that data (such as service contexts or object key) change due to Routing. Since GIOP 1.2 Request and Reply Bodies are always aligned to an 8-octet boundary, it is necessary to keep track of the

- data and the length of that data as a sequence of octet, and
- the byte order with which that data was originally marshaled.

### 22.14.1.2 *RequestMessage*

This structure explicitly contains all the components of a GIOP request. When the target is actually invoked, its members are used to compose an actual GIOP request.

The **RequestMessage** has the following members:

- **giop\_version** - the version of the GIOP that was used when the message was marshaled.
- **service\_contexts** - the sequence of service contexts selected for this request. Routers must propagate all Service Contexts with unknown tags.
- **response\_flags** - As explained further in the *General Inter-ORB Protocol* chapter, Section 15.4.1, “GIOP Message Header,” on page 15-31, the meaning of the two least significant bits is defined as:
  - the least significant bit (bit-0) indicates whether or not a response may be returned. If this bit is “1”, then the server-side ORB shall always send a **ReplyMessage**. If the bit-0 is “0”, no **ReplyMessage** will be sent. This replicates the function of the **response\_expected** boolean in *CORBA*.
  - Bit-1 is considered if and only if bit-0 is “1.” If bit-1 is “0” the server sends a **ReplyMessage** before invoking the target. If bit-1 is “1” the **ReplyMessage** is sent after the target has completed the invocation.
- **reserved**
- **object\_key** - the opaque object key of the target. This may change if a GIOP object forwarding occurs for this request.
- **operation** - the operation name of the request being made.
- **body** - the CDR stream message payload and marshaling byte order for repackaging within a new GIOP request once the routed message can be synchronously invoked on the target.

### 22.14.1.3 *ReplyDestination*

This structure contains enough information for the response to be returned once the actual invocation has been made on the target.

- **handler\_type** - Either **UNTYPED** or **TYPED** indicating which type of **ReplyHandler** is to receive the response. This flag is necessary to ensure that no **is\_a** must be performed when the Target Router is ready to return the reply as described in Section 22.14.3.5, “Target Router,” on page 22-55.
- **handler** - an Object reference to the **ReplyHandler** that is the destination of the response.

### 22.14.1.4 *RequestInfo*

This structure contains the information required for an intermediate Router to get a request closer to its target and for a target Router to invoke that request on its target.

- **visited** - the sequence of Routers through which the message has been sent already. Each router may add its reference to this sequence before forwarding the request to another Router. This sequence can be used by a Router to detect cycles in a network of Routers, but this is not a requirement step in the Routing protocol.

- **to\_visit** - the suggested sequence of Routers to which the message should be sent if the target is not available. This sequence may be modified as the request is sent from Router to Router.
- **profile\_index** - the index of the profile in the target IOR that is being used for this request. This is necessary so the target router can choose the correct object key when composing the final GIOP request.
- **target** - the full IOR of this message's target.
- **reply\_destination** - a reference to the **ReplyHandler** for this request along with the disposition of that **ReplyHandler**. If the **handler\_type** is **UNYPED**, the destination is an untyped **ReplyHandler** (meaning that it was created when **create\_persistent\_request** was called and is implemented by the **ClientRouter**). If the **handler\_type** is **TYPED**, the reply destination is a type-specific **ReplyHandler** implemented by an application using the callback model. If the reply destination is **nil**, no reply will be sent and the **handler\_type** can be ignored.
- **selected\_qos** - the list of QoS that was selected for the Routing of this message.
- **message** - the payload (arguments, return value, raised exception) for this message, including the byte order with which the message was originally marshaled.

## 22.14.2 Interfaces

### 22.14.2.1 ReplyHandler

The **ReplyHandler** interface is a base interface for all specific **ReplyHandlers** (either type-specific or Generic ones). It is used as the generic **reply\_destination** argument when a request is sent to a Router:

### 22.14.2.2 Router

The **Router** interface is used to pass messages when a request cannot be synchronously invoked on its final target.

### 22.14.2.3 send\_request

The Router is passed all the information necessary to either route the request toward the target by calling **send\_request** on another Router, or to invoke the request on its final target.

### 22.14.2.4 send\_multiple\_requests

The Router is passed a sequence of **RequestInfo** structures, where each **RequestInfo** is a completely self-contained set of information allowing the Router to either route the request toward the target by calling **send\_request** on another Router, or to invoke the request on its final target.

### 22.14.2.5 *UntypedReplyHandler*

This interface is the target of replies when the polling model is used.

### 22.14.2.6 *reply*

The reply operation is invoked when the reply to a **PersistentRequest** becomes available. The operation is invoked with the following arguments:

- **operation\_name** - The string name of the original request operation. This is necessary if the untyped reply must be turned into a callback on a typed **ReplyHandler** (as is the case if the polling client has switched models after making the request and associated a **ReplyHandler** with its Poller).
- **reply\_type** - The status of the Reply (either **NO\_\_EXCEPTION**, **USER\_EXCEPTION**, or **SYSTEM\_EXCEPTION**). **LOCATION\_FORWARD** replies are not invoked on the **ReplyHandler**.
- **reply\_body** - The marshaled data of the reply along with the byte order with which it was marshaled.

### 22.14.2.7 *PersistentRequest*

Instances of this interface are created by the Client Router for polling model invocations, and is queried to obtain the status of a request, including the reply's data if available.

### 22.14.2.8 *readonly attribute reply\_available*

Returns the value **TRUE** if and only if the reply is currently available and has not yet been returned to some caller of **get\_reply**. Returns the value **FALSE** if and only if the reply has not yet been returned to the ClientRouter. This attribute cannot be checked if the response has already been delivered to some caller of **get\_reply**, as the **PersistentRequest** instance will have been deactivated at that time and the ORB will return the system exception **OBJECT\_NOT\_EXIST** on any subsequent invocations on that **PersistentRequest**.

### 22.14.2.9 *get\_reply*

The **get\_reply** operation is invoked to poll or block for a reply to a **PersistentRequest**. The operation returns the status of the reply (either **NO\_EXCEPTION**, **USER\_EXCEPTION**, or **SYSTEM\_EXCEPTION**) or raises the **ReplyNotAvailable** exception if no reply is obtained before the specified timeout occurs. If the response is returned to the caller, the **PersistentRequest** is deactivated so that future invocations of **get\_reply** raise the system exception **OBJECT\_NOT\_EXIST**. The operation takes the following arguments:

- **blocking** - if set, the operation does not return until either a reply can be returned or the **PersistentRequest** becomes invalid (due to an expired time-to-live).

- **timeout** - ignored if blocking is **TRUE**. Otherwise, the request blocks for the specified number of seconds or until a reply is available. If no reply becomes available after the specified timeout has expired, the **ReplyNotAvailable** exception is raised.
- **reply\_body** - the data of the reply as originally marshaled by the target.

#### 22.14.2.10 *attribute associated\_handler*

The possibly **nil ReplyHandler** reference of the type-specific **ReplyHandler** registered to receive a callback reply for this request. This attribute is initially **nil** if the **PersistentRequest** was created for a polling client, and becomes non-**nil** if the client decides to switch from the polling model to the callback model.

#### 22.14.2.11 *PersistentRequestRouter*

This interface is used by the messaging-aware client ORB to create a request that can be queried to obtain its status and reply data (e.g., using the polling model).

#### 22.14.2.12 *create\_persistent\_request*

When a **PersistentRequest** is created for a message, no reply destination is supplied. Instead, the **PersistentRequestRouter** establishes itself as the reply destination and returns to the caller a reference that has operations for obtaining the status and reply for the request. The operation that returns this new **PersistentRequest** takes the following arguments:

- **profile\_index** - the index of the profile in the target IOR that is being used for this request. This is necessary so the target router can choose the correct object key when composing the final GIOP request.
- **to\_visit** - the suggested sequence of Routers to which the message should be sent if the target is not available. This sequence may be modified as the request is sent from Router to Router.
- **target** - the full IOR of this message's target.
- **selected\_qos** - the list of QoS that was selected for this message.
- **message** - the payload (arguments, return value, raised exception) for this message.

### 22.14.3 *Routing Protocol*

Processing of a time-independent invocation involves a series of roles played by various components of the distributed system. These roles include:

- the invoking client
- an initial request router
- intermediate request routers



- a target router
- the target object
- intermediate reply routers
- a final reply router
- the response-receiving client.

Not all of these distinct roles are necessarily involved in every invocation, and more than one role can be played by the same component of the distributed system. A router implementation is likely to be able to serve any of the router roles, and may even serve multiple roles for the same invocation, such as when the initial request router also serves as the target router with no intermediate request routers involved.

Routers can be collocated with client or server ORBs, or can be separate processes. Either way, routers must maintain persistent state with transactional semantics.

### 22.14.3.1 *Invoking Client*

The client application makes an asynchronous invocation either by specifying a **ReplyHandler** object or by using the polling API.

Depending on QoS requirements, the client ORB may try to synchronously invoke the operation on the target object, using IIOP or some other synchronous protocol. This attempt will not be made if the client is part of an active transaction and the target has a **TransactionPolicy** of **Requires\_unshared**.

If the target is unreachable via a synchronous protocol, the client ORB tries to find an initial router to use. If the target IOR has a **TAG\_MESSAGE\_ROUTERS** component, its list of routers may be tried, starting from the one closest to the target, which is the last in the list. If none of these are reachable, or there is no **TAG\_MESSAGE\_ROUTERS** component, then the client ORB's default router closest to the target may be chosen. The order in which the client ORB attempts to contact an initial router is not mandated by this specification. The client ORB may choose to send the request to any Router (such as its own closest Router in all cases) according to implementation-specific configuration. If the client application used the polling interface and a quality of service requiring the request to be persistent, the client ORB attempts to narrow the initial request router to a **PersistentRequestRouter**, and if this fails, a different router must be selected. If no router can be found meeting the required quality of service, the system exception **CORBA::INV\_POLICY** is raised.

Once an initial request router is identified, the client ORB delivers the request to it by invoking **send\_request** if a **ReplyHandler** was specified, or **create\_persistent\_request** if the polling API and persistent QoS was used. The client application's active transaction context, if any, is used for this invocation. Only service context information that is meaningful to the target in a time-independent invocation, such as **CodeSets** (but not **TransactionContext**), is included in the **RequestMessage** argument to **send\_request**. Future ORB service specifications must state whether their service contexts are to be considered end-to-end (and therefore

included within the **RequestMessage**) or are only for a single hop (and therefore used by the ORB when invoking the initial router but not included with the **RequestMessage**).

An empty sequence is passed by the client ORB as the visited parameter. The list of routers from the target IOR's **TAG\_MESSAGE\_ROUTERS** component is used as the **to\_visit** parameter. This list may have additional routers added to it by the client ORB depending on administration of the network of routers. If the callback model is being used, the type-specific **ReplyHandler** is passed as the **reply\_destination**. If the request was originated using **create\_persistent\_request**, the untyped **ReplyHandler** is passed as the **reply\_destination**. For the reply to be able to be delivered asynchronously, these **ReplyHandler** IORs must contain enough routing information (e.g., **TAG\_MESSAGE\_ROUTERS** component).

### 22.14.3.2 *Initial Request Router*

The initial request router's role depends on whether the **ReplyHandler** or polling API was used by the client.

If the client ORB passed the request message, along with a **ReplyHandler** reference, to the initial router using the **send\_request** operation, the initial request router saves the request message to stable storage within the client application's transaction context, and then processes the request using the request routing algorithm described below.

If **create\_persistent\_request** was called, the initial request router must instantiate a **PersistentRequest** object and return its reference to the client ORB, which will return it to the client application. Until the response for the request is delivered to the client, or the request times out, such an initial request router must keep an association between the identity of this **PersistentRequest** object and the state of the request. When routing the request (as described below), this first router passes a **reply\_destination**, which is an **UntypedReplyHandler** implemented by the first router itself. This **UntypedReplyHandler** may be created either before or after the **PersistentRequest** and request state is committed to stable storage. After returning the **PersistentRequest** object and committing the request state to stable storage, all within the transaction context of the client application, the initial router processes the request using the routing algorithm described below. The routing process does not continue until the client's initial transaction has been committed.

### 22.14.3.3 *Request Routing Algorithm*

Any router that has received a request message and committed it to stable storage processes it in the same way. If it can invoke the operation directly on the target object, the router serves as the target router for the invocation, as described below. If not, it tries to deliver the request to another router closer to the target object. If it can't do either of these, it queues the request and tries again later, either after some period of time has elapsed, or in response to an announcement of availability from another router closer to the target as described in Section 22.15, "Router Administration," on page 22-59.

A router typically picks another router closer to the target by selecting from the list of routers passed to it as the **to\_visit** parameter to either **send\_request** or **create\_persistent\_request**. Routers later in the list are given preference as being closer to synchronous connection with the target. The next router can also be selected from some set of known Routers based on an implementation-specific configuration. If QoS attributes of the request message require persistence of requests, a transaction is first initiated. Then **send\_request** is called on the selected router. The **to\_visit** parameter is formed by removing the callee from the **to\_visit** list received with the original request. Any routers further from the target than the callee (earlier in the **to\_visit** list) are also removed. The **target**, **reply\_destination**, **selected\_qos**, and **message** parameters are copied from the received request. After invoking **send\_request**, the router removes the request message from its stable storage, and commits the transaction if it initiated one.

A router must ensure that exactly-once semantics are preserved. If delivering a request message results in an exception with a **CompletionStatus** of **COMPLETED\_NO**, or in a transaction being aborted, it can retry. Since any invocation can raise a system exception, all exception replies with a completion status other than **COMPLETED\_NO** must be reported back to the client via the reply message.

#### 22.14.3.4 *Intermediate Request Router*

An intermediate router is simply a router that accepts a request message via **send\_request** from one router and then, eventually, delivers it to another router, again using **send\_request**. The **send\_multiple\_requests** operation may also be used to allow batching of requests between Routers. The intermediate routers may take a request's **QueueOrderPolicy** (if present) into account when prioritizing the delivery of requests to destination routers, but is not required to do so.

#### 22.14.3.5 *Target Router*

The target router for an invocation is a router that accepts a request message, delivers it to the target object, and, if a response is expected, routes the target's reply back to the client. The target router may have to queue the request message before the invocation and/or may have to queue the response message after the invocation.

The target router may be collocated with the target, or may deliver the request to the target via a synchronous GIOP-based protocol. The target router is responsible for processing any **LOCATION\_FORWARD** replies that may be generated in making the invocation on the target, so only **NO\_EXCEPTION**, **USER\_EXCEPTION**, or **SYSTEM\_EXCEPTION** replies are routed back to the client. When making the synchronous GIOP request on the target, the **TargetRouter** must marshal its request with the same byte order with which the original message body was marshaled. This byte order is recorded in the **MessageBody** structure. No Router is expected to remarshal the request body with a new byte order.

If persistence of requests is required, the target router ensures that the request message is removed from stable storage and the reply message is committed to stable storage within the scope of a single transaction. If the target object's IOR indicates that it

supports time-independent transactions (through a **TransactionPolicy** of **Allows\_unshared**, **Allows\_either**, **Requires\_unshared**, or **Requires\_either**), then that same transaction context is propagated to the server application. Otherwise no transaction context is propagated to the target when the request is invoked.

When guaranteed delivery is required, there may be one, two, or three distinct transactions involved in the target router's processing of the invocation. The target router receives the request message within the context of a transaction initiated by a previous router or possibly the client ORB. If the target is accessible at that time, the operation can be invoked on the target and the reply message either stored or sent back toward the reply destination using the transaction context within which the request was received. If the target is not accessible, the request message is committed to stable storage and queued for later delivery to the target under a second transaction. When the target operation is invoked and its reply is received, the target router may deliver the reply to another router, or possibly to the client ORB. The router may deliver the reply in the same transaction as it invoked the operation, or the router may commit the reply to stable storage and later deliver it in yet another transaction. The completion of the transaction in which the **TargetRouter** actually delivers the request to the target is governed by the following cases:

- A **NO\_EXCEPTION** reply is returned and the transaction commits. This committed reply is the one that will be returned to the client. Since the reply committed, the request is no longer waiting in some queue pending delivery.
- A **NO\_EXCEPTION** reply is returned but the transaction raises **TRANSACTION\_ROLLEDBACK** upon commit. In this case the router must ensure that the request not be considered pending delivery anymore (logically the request must be removed from some queue), and that a suitable reply be generated so that the client knows that the target's transaction rolled back. The router starts a new transaction in which it removes the request from its "to be delivered" queue and generates a reply with the system exception **TRANSACTION\_ROLLEDBACK**. This reply is then committed as the reply for the request.
- A user or system exception is returned. The Router should rollback the transaction so no work has been done in the target server. There are two subcases here:
  - the target was unreachable. In this case, since the transaction has rolled back, the request is still waiting in the Router's queue of pending requests. The retry policy is used to determine when next to attempt delivery.
  - the target was reachable but an exception was raised. As in the **TRANSACTION\_ROLLEDBACK** case above, the Router starts a new transaction to remove the request from the queue of pending requests, and commits the exception reply that it received from the target as the reply for this operation.

If the request has a **QueueOrderPolicy** associated with it, the target router is responsible for making invocations in the proper order. Depending on the Ordering requested (e.g., **PRIORITY**, **TEMPORAL**), the appropriate request is selected for delivery. Note that end-to-end ordering guarantees cannot be made when client and target are decoupled, so this ordering is really only a guideline. If multiple threads are

used in the router for request delivery, it is certainly possible for delivery of requests to be out of order. The specification of **QueueOrderPolicy** does not require a router or server ORB to limit its use of threads in delivering requests.

Regardless of how many transactions, if any, are used, the target router must route the reply back to the reply destination if and only if the **response\_expected** flag was set to a non-zero value in the **RequestMessage**. The reply can take one of two forms depending on whether the **reply\_destination** is a type-specific **ReplyHandler** (the client uses the Callback model) or if the **reply\_destination** is an **UntypedReplyHandler** (a **PersistentRequest** was created such as when the client used the Polling model).

---

**Note** – The type-specific reply handlers and the **UntypedReplyHandler** are both derived from the common base **ReplyHandler** interface, but there is no other inheritance relationship between the **UntypedReplyHandler** and the type-specific reply handlers.

---

Regardless of destination, the new reply must be marshaled with the same byte order used by the target when the reply was originally marshaled. The Target Router is not expected to remarshal the reply body.

#### 22.14.3.6 *Replying to a Type-specific ReplyHandler*

If the client originally supplied a type-specific **ReplyHandler**, the reply must be converted into a typed request invocation on the **ReplyHandler**. The Target Router determines this by verifying that the **handler\_type** disposition of the **reply\_destination** argument has the value **TYPED**. The format of the generated request depends on the **reply\_status**:

- **NO\_EXCEPTION** - the generated reply operation has the same operation name as the request. Its **RequestBody** is exactly the same as the marshaled **ReplyBody** from the target's GIOP reply.
- **SYSTEM\_EXCEPTION** or **USER\_EXCEPTION** - the generated reply operation has the same name as the request operation, with the string **\_excep** appended. The single argument to this request is the **Messaging::ExceptionHolder** valuetype.

A reply with status **LOCATION\_FORWARD** is handled as described below.

#### 22.14.3.7 *Replying to an UntypedReplyHandler*

If the client originally created a **PersistentRequest** (such as by using the Polling model), the reply must be converted into the generic request operation supported by the **UntypedReplyHandler** interface. The Target Router determines this by verifying that the **handler\_type** disposition of the **reply\_destination** argument has the value **UNTYPED**. The generated reply operation has the name "reply" and takes as arguments the original operation name, the **reply\_status** (**NO\_EXCEPTION**, **SYSTEM\_EXCEPTION** or **USER\_EXCEPTION**) and a sequence of octet containing the reply data. The length is set to the size of the marshaled **ReplyBody** and the data is the marshaled body itself.

### 22.14.3.8 *Handling of Service Contexts*

When a **TargetRouter** receives a Reply, it generates a request on some **ReplyTarget** as described previously in this section. If the Reply contains service contexts, the **TargetRouter** must decide whether or not these contexts are to be used in its request on the **ReplyTarget**. End-to-end service contexts, such as the **CodeSets** context, are propagated to the **ReplyTarget**. Single-hop service contexts, such as the **TransactionService** context, are consumed by the **TargetRouter**. Unknown service contexts are propagated from the reply to the generated request on the **ReplyTarget**.

### 22.14.3.9 *Handling LOCATION\_FORWARD Replies*

When a **TargetRouter** receives a Reply with status **LOCATION\_FORWARD**, it must either use the returned reference as the new target for the request, or must return the new reference to the **ReplyTarget**. The Messaging protocol requires that the **TargetRouter** continue processing the request by either directly invoking the new target or routing the request toward the new target as has been described thus far.

### 22.14.3.10 *Routing of Replies*

As described above, the GIOP reply is turned into a request message targeted to the original **reply\_destination**. Since this reply is now a request, it may be sent to its destination using the message routing protocol described in this section. For example, if the **ReplyHandler**'s reference contains Routing information, the **TargetRouter** may invoke the new request using some Router's **send\_request** operation. In this case, the specified routing protocol should be followed for this new request, with the **response\_expected** flags all set to 0 and the **reply\_destination** set to nil.

### 22.14.3.11 *UntypedReplyHandler*

When an **UntypedReplyHandler**'s reply operation is invoked, several things may happen. The specific correlation of a Router's **UntypedReplyHandler** with the **PersistentRequests** it supports is not visible to this interoperability layer, but at a high level one of the following occurs:

- A type-specific **ReplyHandler** has been associated with the corresponding **PersistentRequest**. If a callback has been registered for this reply (the **associated\_handler** is non-nil), the type-specific callback operation may be invoked directly as described in Section 22.14.3.6, "Replying to a Type-specific ReplyHandler," on page 22-57. For persistent delivery of replies, the Router starts a transaction in which the reply is delivered. Once the client returns, the Router commits and the reply is deleted. As with any transactional request, the application's **ReplyHandler** implementation may choose to invoke **CosTransactions::Current::rollback\_only** or **CosTransactions::coordinator::rollback\_only** and then raise the **CORBA::TRANSACTION\_ROLLEDBACK** system exception if it wishes to rollback the Router's transaction.

- A **PersistentRequest::get\_reply** is pending for this request. The reply data may be immediately returned to the waiting client. The reply is returned within the client's transaction context and when that transaction is committed the reply is deleted.
- The reply data may be saved to stable storage (for guaranteed delivery this is made durable when the sending Router commits the transaction in which the reply has been delivered) or recorded in-process (if the reply is not guaranteed). The **UntypedReplyHandler::reply** then returns. The reply is obtained by a client at a later time.

## 22.15 Router Administration

One basic function of a Router is to forward a request to another Router, which is "closer" to the eventual target of a client's original request. In terms of the relationship between these two routers, the first Router can be thought of as the "source Router," and the second can be called the "destination Router." In the case where the network is partitioned or the destination Router has temporarily or permanently become unavailable, the source Router will be unable to forward its message. When this occurs, the Router must determine when and how to retry the request to the destination Router.

To enable scalable networks of routers, a **RouterAdmin** interface has been specified. The interface is defined mainly for the purpose of avoiding the non-scaling scenario where a source Router has no choice but to consume network resources by continuously "pinging" its destination Router.

This problem is analogous to the one faced by the target router when attempting delivery of the request to the message's target. Therefore, the mechanism specified here generically supports registrations of destination routers as well as actual target object references.

```

module MessageRouting {

 typedef short RegistrationState;
 const RegistrationState NOT_REGISTERED = 0;
 const RegistrationState ACTIVE = 1;
 const RegistrationState SUSPENDED = 2;

 exception InvalidState{
 RegistrationState registration_state;
 };

 valuetype RetryPolicy supports CORBA::Policy { };

 const CORBA::PolicyType IMMEDIATE_SUSPEND_POLICY_TYPE = 50;
 valuetype ImmediateSuspend : RetryPolicy { };

 const CORBA::PolicyType UNLIMITED_PING_POLICY_TYPE = 51;
 valuetype UnlimitedPing : RetryPolicy {

```



```

 public short max_backoffs;
 public float backoff_factor;
 public unsigned long base_interval_seconds;
};

const CORBA::PolicyType LIMITED_PING_POLICY_TYPE = 52;
valuetype LimitedPing : UnlimitedPing {
 public unsigned long interval_limit;
};

const CORBA::PolicyType DECAY_POLICY_TYPE = 53;
valuetype DecayPolicy supports CORBA::Policy {
 public unsigned long decay_seconds;
};

const CORBA::PolicyType RESUME_POLICY_TYPE = 54;
valuetype ResumePolicy supports CORBA::Policy {
 public unsigned long resume_seconds;
};

interface RouterAdmin {
 void register_destination(
 in Object dest,
 in boolean is_router,
 in RetryPolicy retry,
 in DecayPolicy decay);

 void suspend_destination(
 in Object dest,
 in ResumePolicy resumption)
 raises (InvalidState);

 void resume_destination(
 in Object dest)
 raises (InvalidState);

 void unregister_destination(
 in Object dest)
 raises (InvalidState);
};

interface Router {
 readonly attribute RouterAdmin admin;
};
};

```

When a request arrives at a Router (source router) that must either be delivered directly to a target, or be forwarded on via another Router (destination router), that source router attempts to send the message. If the message send fails, the source router needs to decide when to retry the send.



The following use of the **RouterAdmin** is intended for router-to-router administration:

1. A source router gets a request that should be sent to a destination router. Since the source router has no registration for that destination router, it attempts to send the message.
2. Upon receipt of the message, the destination router realizes that it has never registered back with the source router and calls back to the source router's **RouterAdmin** (independent of the processing of the message - this is purely an optional administrative request to avoid poor routing behavior in the future). By calling back to the **RouterAdmin**, the destination router registers itself with its desired retry policy and decay policy for future messages. On subsequent messages, the destination router knows that it has already registered and need perform no administrative processing at this step.
3. At some time, the destination router knows it is being separated from the network. This case is termed “graceful disconnection.”
  - The destination router notifies the source router that the registration should be suspended.
  - Upon subsequent requests, the source router consults its list of registrations. Since the destination router is currently **SUSPENDED**, no send is attempted (depending on the **ResumePolicy** at the time of suspension).
  - At some later time, the destination router becomes reconnected. It resumes its registration and can now receive stored (and later) messages.
4. At some time, the destination router becomes disconnected without any advanced warning (it may not know that it is disconnected). This case is termed “unexpected disconnection.”
  - Upon subsequent requests, the source router consults its list of registrations. Since the destination router is currently **ACTIVE**, a send is attempted. When the send fails, the source router follows its **RetryPolicy** and keeps pinging until the **RetryPolicy** indicates the registration should be suspended (immediately if the **RetryPolicy** is **ImmediateSuspend** or never if the **RetryPolicy** is **UnlimitedPing**).
  - At some time, the destination router becomes reconnected. If the source router discovers this due to pinging, the pending requests can now be delivered. If the source router has **SUSPENDED** the registration or is in the midst of the interval between pings when the destination router re-registers itself, the registration can immediately be set to an **ACTIVE** state and pending requests can be sent to the destination router.

The “target router” is the one that synchronously delivers requests to the target. The **RouterAdmin** is also used for the administration of policies that determine when this target router will actually attempt to deliver its request. A target’s use of this interface is very similar to the way it is used for router-to-router administration described above. The analogous scenarios are re-described here for clarity:

1. An object instance is activated with support for TII. Since the target is now ready to receive requests, it is registered with some router's **RouterAdmin** with the target's desired retry policy and decay policy. Typically, a reference to this router will also be contained in a **MessageRouting::TAG\_MESSAGE\_ROUTERS** component of the target's object reference.
2. A router gets a request that it can deliver directly to the target (therefore this router is considered a "target router"). Since the target router has a registration for that object, it attempts to invoke the request.
3. At some time, the target knows it is being separated from the network. This case is termed "graceful disconnection."
  - The target notifies the target router that the registration should be suspended.
  - Upon subsequent requests, the target router consults its list of registrations. Since the target is currently **SUSPENDED**, no invocation is attempted (depending on the **ResumePolicy** at the time of suspension).
  - At some later time, the target becomes reconnected. It resumes its registration and can now receive stored (and later) requests.
4. At some time, the target becomes disconnected without any advanced warning (it may not know that it is disconnected). This case is termed "unexpected disconnection."
  - Upon subsequent requests, the target router consults its list of registrations. Since the target is currently **ACTIVE**, an invocation is attempted. When this invocation fails, the target router follows its **RetryPolicy** and keeps pinging until the **RetryPolicy** indicates the registration should be suspended (immediately if the **RetryPolicy** is **ImmediateSuspend** or never if the **RetryPolicy** is **UnlimitedPing**).
  - At some time, the target once again becomes available. If the target router discovers this due to pinging, the pending requests can now be delivered. If the target router has **SUSPENDED** the registration or is in the midst of the interval between pings when the target re-registers itself, the registration can immediately be set to an **ACTIVE** state and pending requests can be invoked on the target.

### 22.15.1 Constants

#### 22.15.1.1 *typedef short RegistrationState*

The **RegistrationState** indicates the current status of a registration for a particular destination (a router or a target). The possible values are:

- **NOT\_REGISTERED** - The given destination is not registered with this **RouterAdmin**.
- **ACTIVE** - The given destination is currently registered with this **RouterAdmin** and is not in the suspended state.
- **SUSPENDED** - The given destination is currently registered with this **RouterAdmin** and has been set to the Suspended state.

## 22.15.2 Exceptions

### 22.15.2.1 exception *InvalidState*

The attempted operation attempts to affect a registration, which is not in a state with a valid transition to the new state dictated by the operation. The State member contains the current status of the router or target for which the operation was attempted:

- **Suspend** was attempted on a router/target either not registered or already suspended.
- **Resume** was attempted on a router/target either not registered or already active.
- **Unregister** was attempted on a router/target not registered.

## 22.15.3 Valuetypes

### 22.15.3.1 *RetryPolicy*

This **valuetype** is the abstract base from which all retry policies are derived.

### 22.15.3.2 *ImmediateSuspend*

The registered router is placed in the **SUSPENDED** state as soon as a message send fails.

### 22.15.3.3 *UnlimitedPing*

This **valuetype** is used to parameterize a pinging behavior:

- **backoff\_factor** - If **max\_backoffs** is non-zero, the **backoff\_factor** is the number by which the current interval between failed send attempts is multiplied to determine the interval before the next send should be attempted. For example, a **backoff\_factor** of 2 will cause the interval to double between each failed attempt.
- **base\_interval\_seconds** - The base number of seconds between retries.
- **max\_backoffs** - If zero, the same interval is used between each retry (constant interval pinging). If non-zero, the interval between retries is multiplied by the **backoff\_factor** after each failed send attempt until **max\_backoffs** failed attempts have been made. Once **max\_backoffs** have been performed, retry attempts are made at the constant rate of the last interval used. Otherwise, the same interval is used between each retry (linear pinging).

### 22.15.3.4 *LimitedPing*

This **valuetype** is used to parameterize a pinging behavior that should be stopped after a specified number of attempts. It derives from **UnlimitedPing** and adds the following state:

- **interval\_limit** - The number of attempts before the pinging should be stopped.

#### 22.15.3.5 *DecayPolicy*

This **valuetype** indicates how long a given registration is valid. If the **decay\_seconds** are set to the value zero, the registered destination router will only be unregistered with an invocation of **unregister\_router**. Otherwise, the registered destination router will be unregistered after the specified timeout has elapsed.

#### 22.15.3.6 *ResumePolicy*

This **valuetype** indicates when a suspended registration should be resumed. If the **resume\_seconds** are set to the value zero, the registered destination will only become active once explicitly resumed. Otherwise, the suspended destination will be resumed after the specified timeout has passed.

### 22.15.4 *Interfaces*

#### 22.15.4.1 *RouterAdmin*

The **RouterAdmin** interface provides the operations for supporting scalable connection and disconnection between source routers and their destination routers and targets.

#### 22.15.4.2 *register\_destination*

A registration is added for the specified target with the given policies. If the registration is marked as **is\_router**, the destination will receive messages via the Router interface as described in “Intermediate Request Router” on page 22-55. Otherwise, the registration is assumed to be for a target, in which case delivery is made as described in “Target Router” on page 22-55.

#### 22.15.4.3 *suspend\_destination*

The specified registration is suspended. If that target is not in an **ACTIVE** state, an **InvalidState** exception is raised. The suspended destination will be returned to the **ACTIVE** state if an explicit **resume\_destination** or **register\_destination** operation is performed for that destination. If the **resume\_policy** allows for **TimedResume**, this transition will occur in, at most, the specified amount of time (e.g., if an explicit resumption doesn't happen first).

#### 22.15.4.4 *resume\_destination*

Resume the suspended destination. An **InvalidState** exception is raised if the destination is not in the **SUSPENDED** state.

### 22.15.4.5 *unregister\_destination*

Unregister the specified destination. An `InvalidState` exception is raised if the target is not registered.

## 22.16 *CORBA Messaging IDL*

### 22.16.1 *Messaging Module*

The following module has been added by CORBA Messaging:

```

// IDL
// File: Messaging.idl
#ifndef _MESSAGING_IDL_
#define _MESSAGING_IDL_

import ::CORBA;
import ::IOP;
import ::TimeBase;
module Messaging {
 typeprefix Messaging "omg.org";

 //
 // Messaging Quality of Service
 //

 typedef short RebindMode;
 const RebindMode TRANSPARENT = 0;
 const RebindMode NO_REBIND = 1;
 const RebindMode NO_RECONNECT = 2;

 typedef short SyncScope;
 const SyncScope SYNC_NONE = 0;
 const SyncScope SYNC_WITH_TRANSPORT = 1;
 const SyncScope SYNC_WITH_SERVER = 2;
 const SyncScope SYNC_WITH_TARGET = 3;

 typedef short RoutingType;
 const RoutingType ROUTE_NONE = 0;
 const RoutingType ROUTE_FORWARD = 1;
 const RoutingType ROUTE_STORE_AND_FORWARD = 2;

 typedef short Priority;

 typedef unsigned short Ordering;
 const Ordering ORDER_ANY = 0x01;
 const Ordering ORDER_TEMPORAL = 0x02;
 const Ordering ORDER_PRIORITY = 0x04;
 const Ordering ORDER_DEADLINE = 0x08;

```

```
//
// Locally-Constrained Policy Objects
//

// Rebind Policy (default = TRANSPARENT)
const CORBA::PolicyType REBIND_POLICY_TYPE = 23;
interface RebindPolicy : CORBA::Policy {
 readonly attribute RebindMode rebind_mode;
};

// Synchronization Policy (default = SYNC_WITH_TRANSPORT)
const CORBA::PolicyType SYNC_SCOPE_POLICY_TYPE = 24;
interface SyncScopePolicy : CORBA::Policy {
 readonly attribute SyncScope synchronization;
};

// Priority Policies
const CORBA::PolicyType REQUEST_PRIORITY_POLICY_TYPE = 25;
struct PriorityRange {
 Priority min;
 Priority max;
};
interface RequestPriorityPolicy : CORBA::Policy {
 readonly attribute PriorityRange priority_range;
};
const CORBA::PolicyType REPLY_PRIORITY_POLICY_TYPE = 26;
interface ReplyPriorityPolicy : CORBA::Policy {
 readonly attribute PriorityRange priority_range;
};

// Timeout Policies
const CORBA::PolicyType
 REQUEST_START_TIME_POLICY_TYPE = 27;
interface RequestStartTimePolicy : CORBA::Policy {
 readonly attribute TimeBase::UtcT start_time;
};
const CORBA::PolicyType REQUEST_END_TIME_POLICY_TYPE = 28;
interface RequestEndTimePolicy : CORBA::Policy {
 readonly attribute TimeBase::UtcT end_time;
};

const CORBA::PolicyType REPLY_START_TIME_POLICY_TYPE = 29;
interface ReplyStartTimePolicy : CORBA::Policy {
 readonly attribute TimeBase::UtcT start_time;
};
const CORBA::PolicyType REPLY_END_TIME_POLICY_TYPE = 30;
interface ReplyEndTimePolicy : CORBA::Policy {
 readonly attribute TimeBase::UtcT end_time;
};
```

```

const CORBA::PolicyType
 RELATIVE_REQ_TIMEOUT_POLICY_TYPE = 31;
interface RelativeRequestTimeoutPolicy : CORBA::Policy {
 readonly attribute TimeBase::TimeT relative_expiry;
};

const CORBA::PolicyType
 RELATIVE_RT_TIMEOUT_POLICY_TYPE = 32;
interface RelativeRoundtripTimeoutPolicy : CORBA::Policy {
 readonly attribute TimeBase::TimeT relative_expiry;
};

const CORBA::PolicyType ROUTING_POLICY_TYPE = 33;
struct RoutingTypeRange {
 RoutingType min;
 RoutingType max;
};
interface RoutingPolicy : CORBA::Policy {
 readonly attribute RoutingTypeRange routing_range;
};

const CORBA::PolicyType MAX_HOPS_POLICY_TYPE = 34;
interface MaxHopsPolicy : CORBA::Policy {
 readonly attribute unsigned short max_hops;
};

// Router Delivery-ordering Policy (default = ORDER_TEMPORAL)
const CORBA::PolicyType QUEUE_ORDER_POLICY_TYPE = 35;
interface QueueOrderPolicy : CORBA::Policy {
 readonly attribute Ordering allowed_orders;
};

//
// Propagation of QoS Policies
//

struct PolicyValue {
 CORBA::PolicyType ptype;
 sequence<octet> pvalue;
};
typedef sequence<PolicyValue> PolicyValueSeq;

//
// Exception Delivery in the Callback Model
//

native UserExceptionBase;
valuetype ExceptionHolder {
 void raise_exception() raises (UserExceptionBase);
 void raise_exception_with_list(
 in Dynamic::ExceptionList exc_list)
};

```

```

 raises (UserExceptionBase);
 private boolean is_system_exception;
 private boolean byte_order;
 private sequence<octet> marshaled_exception;
 };

 //
 // Base interface for the Callback model
 //

 interface ReplyHandler { };

 //
 // Base value for the Polling model
 //

 valuetype Poller : CORBA::Pollable {
 readonly attribute Object operation_target;
 readonly attribute string operation_name;

 attribute ReplyHandler associated_handler;
 readonly attribute boolean is_from_poller;

 private Object target;
 private string op_name;
 };
};
#endif

```

### 22.16.2 MessageRouting Module

The following module has been added for the CORBA Messaging Interoperable Routing Protocol. These definitions are only required for interoperable support of Time-Independent Invocations:

```

// IDL
// File: MessageRouting.idl
#ifndef _MESSAGE_ROUTING_IDL_
#define _MESSAGE_ROUTING_IDL_

import ::CORBA;
import ::Dynamic;
import ::GIOP;
import ::IOP;
import ::Messaging;
module MessageRouting {
 typeprefix MessageRouting "omg.org";

 //
 // Basic Routing Interoperability

```



```

//

interface Router;
interface RouterAdmin;
typedef sequence<Router> RouterList;

struct MessageBody {
 sequence<octet> body;
 boolean byte_order;
};

struct RequestMessage {
 GIOP::Version giop_version;
 IOP::ServiceContextList service_contexts;
 octet response_flags;
 octet reserved[3];
 sequence<octet> object_key;
 string operation;
 MessageBody body;
};

enum ReplyDisposition { TYPED, UNTYPED };
struct ReplyDestination {
 ReplyDisposition handler_type;
 Messaging::ReplyHandler handler;
};

struct RequestInfo {
 RouterList visited;
 RouterList to_visit;
 Object target;
 unsigned short profile_index;
 ReplyDestination reply_destination;
 Messaging::PolicyValueSeq selected_qos;
 RequestMessage payload;
};
typedef sequence<RequestInfo> RequestInfoSeq;

interface Router {
 void send_request(in RequestInfo req);
 void send_multiple_requests(in RequestInfoSeq reqSeq);

 readonly attribute RouterAdmin admin;
};

//
// Polling-related interfaces
//

interface UntypedReplyHandler : Messaging::ReplyHandler {
 void reply(

```

```

 in string operation_name,
 in GIOP::ReplyStatusType reply_type,
 in MessageBody reply_body);
};

exception ReplyNotAvailable { };

interface PersistentRequest {
 readonly attribute boolean reply_available;

 GIOP::ReplyStatusType get_reply(
 in boolean blocking,
 in unsigned long timeout,
 out MessageBody reply_body)
 raises (ReplyNotAvailable);

 attribute Messaging::ReplyHandler associated_handler;
};

interface PersistentRequestRouter {
 PersistentRequest create_persistent_request(
 in unsigned short profile_index,
 in RouterList to_visit,
 in Object target,
 in CORBA::PolicyList current_qos,
 in RequestMessage payload);
};

//
// Router Administration
//

typedef short RegistrationState;
const RegistrationState NOT_REGISTERED = 0;
const RegistrationState ACTIVE = 1;
const RegistrationState SUSPENDED = 2;

exception InvalidState{
 RegistrationState registration_state;
};

valuetype RetryPolicy supports CORBA::Policy { };

const CORBA::PolicyType IMMEDIATE_SUSPEND_POLICY_TYPE = 50;
valuetype ImmediateSuspend : RetryPolicy { };

const CORBA::PolicyType UNLIMITED_PING_POLICY_TYPE = 51;
valuetype UnlimitedPing : RetryPolicy {
 public short max_backoffs;
 public float backoff_factor;
 public unsigned long base_interval_seconds;
};

```

```
};

const CORBA::PolicyType LIMITED_PING_POLICY_TYPE = 52;
valuetype LimitedPing : UnlimitedPing {
 public unsigned long interval_limit;
};

const CORBA::PolicyType DECAY_POLICY_TYPE = 53;
valuetype DecayPolicy supports CORBA::Policy {
 public unsigned long decay_seconds;
};

const CORBA::PolicyType RESUME_POLICY_TYPE = 54;
valuetype ResumePolicy supports CORBA::Policy {
 public unsigned long resume_seconds;
};

interface RouterAdmin {
 void register_destination(
 in Object dest,
 in boolean is_router,
 in RetryPolicy retry,
 in DecayPolicy decay);

 void suspend_destination(
 in Object dest,
 in ResumePolicy resumption)
 raises (InvalidState);

 void resume_destination(
 in Object dest)
 raises (InvalidState);

 void unregister_destination(
 in Object dest)
 raises (InvalidState);
};
#endif
```

## Appendix A Overall Design Rationale

### A.1 QoS Abstract Model Design

This Appendix describes each of the components in the Quality of Service (QoS) abstract model and their relationships. The specification defines a framework within which current QoS levels are queried and overridden. This framework is intended to be of use for CORBAServices specifiers, as well as for future revisions of CORBA. The Messaging-specific QoS are defined in terms of this framework.

---

**Note** – The QoS definitions specified in this specification are applied to both synchronous as well as asynchronous invocations.

---

### A.2 Model Components

The QoS framework abstract model consists of the following components:

- **Policy** - The base interface from which all QoS objects derive.
- **PolicyList** - A sequence of Policy objects.
- **PolicyManager** - An interface with operations for querying and overriding QoS **Policy** settings.
  - Mechanisms for obtaining **Policy** override management operations at each relevant application scope:
  - The ORB's **PolicyManager** is obtained through invoking **ORB::resolve\_initial\_references** with the **ObjectId** "ORBPolicyManager".
  - A **CORBA::PolicyCurrent** derived from **CORBA::Current** is used for managing the thread's QoS Policies. A reference to this interface is obtained through an invocation of **ORB::resolve\_initial\_references** with the **ObjectId** "PolicyCurrent".
  - Accessor operations on **CORBA::Object** allow querying and overriding of QoS at the object reference scope.
  - The application of QoS on a Portable Object Adapter is done through the currently existing mechanism of passing a **PolicyList** to the **POA::create\_POA** operation.
- Mechanisms for transporting Policy values as part of interoperable object references and within requests:
  - **TAG\_POLICIES** - A Profile Component containing the sequence of QoS policies exported with the object reference by an object adapter.
  - **INVOCATION\_POLICIES** - A Service Context containing a sequence of QoS policies in effect for the invocation.

The Messaging QoS abstract model consists of a number of **CORBA::Policy**-derived interfaces:

- Client-side Policies are applied to control the behavior of requests and replies. These include Priority, RequestEndTime, and Queuing QoS.

- Server-side Policies are applied to control the default behavior of invocations on a target. These include QueueOrder and Transactionality QoS.

### A.2.1 Component Relationships

Programmers set QoS at various levels of scope by creating a Policy-derived Messaging QoS Policy and selecting the interface for the particular scope. It is anticipated that the following is the standard use-case scenario:

- A POA is created with a certain set of QoS. When object references are created by that POA, the required and supported QoS are encoded in that object reference. Such an object reference is then exported for use by a client.
- Within a client, the ORB's **PolicyManager** interface is obtained to set QoS for the entire ORB (for the entire process when only one ORB is present) either programmatically, or administratively. The Policies set here are valid for all invocations in the process. A programmer-constructed **PolicyList** is used with this interface to actually set the QoS.
- Within that same client, the **CORBA::PolicyCurrent** is obtained to set QoS for all invocations in the current thread. This interface is derived from the **PolicyManager** interface, which can be used to change the QoS for each invocation. A programmer-constructed **PolicyList** is used with this interface to actually set the QoS.
- Within that same client, the object reference is obtained and an invocation of its **get\_client\_policy** operation queries the most specific QoS overrides. A programmer-constructed **PolicyList** may be passed to the Object's **set\_policy\_overrides** operation to obtain a new Object reference with revised QoS. Setting the QoS here applies to all invocations using the new Object reference and supersedes (if possible) those set at the ORB and thread (Current) scopes. The current set of overrides can be validated by calling the Object's pseudo-operation **validate\_connection**, which will attempt to locate a target for the object reference if no target has yet been located. At this time, any Policy overrides placed at the Object, Thread or ORB scope will be reconciled with the QoS Policies established for that object reference when it was created by the POA. The current *effective* **Policy** can then be queried by invoking **get\_policy**, which returns the **Policy** value that is in effect.
- Unseen by the application, the ORB (including the protocol engine) modifies its internal behavior in order to realize the quality of service indicated by the client through the first three steps. See the description of the protocol abstract design in Section A.4, "Message Routing Abstract Model Design," on page 22-81.

### A.2.2 Component Design

Design decisions were made with respect to the following components of the QoS framework:

- Each QoS is an interface derived from **CORBA::Policy**. The design trade-offs focused on ease of application interface for setting specific QoS values, extensibility for new QoS types and values, and compactness so the QoS values can be represented efficiently in Service Contexts and IOR Profile Components. Several alternatives were considered as the basic type for each QoS entity before the decision was made to use the **Policy** interface:
  - **CORBA::NamedValue** - A pair of **string** and **any** were considered mainly due to the flexibility afforded by using an **any** to represent QoS values. This design was discounted due to the untyped nature of the **any** and the application development and execution costs of inserting typed data into and extracting typed data from values of type **any**. Furthermore, the presence of a full typecode within an **any** makes the size of such pairs too large for inclusion in compact Service Contexts and Profile Components.
  - Stateful CORBA **valuetype** - Although the **valuetype** does present a typed interface to the application program, including **valuetypes** in Service Contexts and IOR Profile Components is too expensive due to the presence of full repository identifier information when the **valuetype** is marshaled. Furthermore, there are issues associated with potential truncation of such QoS **valuetypes** when passed as formal arguments of their base type.
  - Interfaces derived from **CORBA::Policy** and compact representation. In the model chosen by this specification, the QoS values are accessible through locality-constrained interfaces. Derivation from **CORBA::Policy** allows reuse of existing interfaces and operations for policy management. When certain QoS values must be marshaled in a Service Context or an IOR Profile Component, the most compact format was chosen. The type of QoS **Policy** represented is indicated by a structure containing the integral **PolicyType** and a **sequence of octet** holding the values for that policy.
- A generic factory for creating QoS Policies. In the *POA* specification within *CORBA*, each POA **Policy** is created through an operation on the POA itself. Although this presents a convenient typed interface for the creation of **Policy** objects, it causes serious problems when new POA Policies are introduced. To fit with the current model, operations would have to be added to the POA interface for every new type of POA **Policy**. To address this potential administrative nightmare, this specification introduces a new ORB operation **create\_policy**. Rather than introducing typed operations for creating all of the Messaging QoS Policies discussed in this specification, the generic factory operation is used.
- A **RebindPolicy** client-side QoS **Policy** to ensure deterministic effective QoS. In *CORBA*, *transparent rebinding* of an object reference may take place during any invocation. Rebinding is defined here to mean changing the client-visible QoS as a result of replacing the IOR Profile used by a client's object reference with a new IOR Profile. Transparent rebinding is defined as when this happens without notice to the client application. Typically, this happens within GIOP through the use of location forwarding. The default **RebindPolicy** (and the only *CORBA* behavior) supports this transparent rebind. For an application with rigorous quality of service requirements, such transparent rebinding can cause problems. For instance, unexpected errors may occur if the application sets its QoS Policies appropriately for an object reference, and then the ORB transparently changes the application's assumptions about that reference by obtaining a new IOR. The **RebindPolicy** has

been added so that applications can prevent the ORB from silently changing the IOR Profile (and therefore the server-side QoS) that have been assumed. A more rigorous value of this **Policy** even precludes the ORB from silently closing and opening connections (when IIOP is being used, for example). The specific requirements demanded by an application dictate which level of **RebindPolicy** is necessary.

### A.3 AMI/TII Abstract Model Design

This section describes each of the components in the Asynchronous Method Invocation /Time-Independent Invocation (AMI/TII) abstract model and the relationships between them.

The model supported by Messaging is a specialization of the general object model described in the OMA guide. All of the elements of the CORBA object model are present in the model described here. Some of the names of existing components are defined more precisely than they are in the CORBA object model. In addition, this specification adds some new components to support Messaging.

Some of the components described here have been borrowed from other specifications, which in some cases have yet to be ratified. Where this occurs, it is clearly noted.

#### A.3.1 Asynchronous Method Invocation Components

The abstract model for AMI/TII supported by Messaging adds the following client-side components:

- **ReplyHandler** - A **ReplyHandler** is an Object that encapsulates the functionality for handling an asynchronous reply. It is used for callback model reply handling.
- **Poller** - A Poller is a **valuetype** used by clients to obtain replies to asynchronous invocations. The Poller provides a type-specific wrapping through which a Reply is obtained.
- Asynchronous Method Invocation (AMI) - A remote method invocation that returns immediately and whose reply is handled by a **ReplyHandler**-derived class implemented by the programmer, or whose reply is obtained through a Poller **valuetype**.

#### A.3.2 Time-Independent Invocation Components

The abstract model for AMI/TII supported by Messaging adds the following components to support interoperability of Time-Independent Invocations:

- **PersistentRequest** - A **PersistentRequest** is an Object that encapsulates an outstanding request. It supports operations for asynchronous operations (including polling or blocking until the reply comes). The **PersistentRequest** is not a locality constrained object (as opposed to the **CORBA::Request**).

- **Persistent ReplyHandler** - A **ReplyHandler** whose Object reference is created by a POA with a **PERSISTENT LifeSpan** Policy. The **Persistent ReplyHandler** may be implemented by a process other than the one that issued the request.
- **PersistentPoller** - A Poller with state including a **PersistentRequest** reference. The **PersistentPoller** may be used by a process other than the one that issued the request.
- **Time-Independent Invocation (TII)** - A time-independent invocation is an AMI request whose reply may outlive the client process. This is addressed via the persistent **ReplyHandler** and Poller mechanisms.
- **Router** - A software routing agent that is used when the target objects (either the target of the request or the target of the reply) are not available.
- **Interoperable Routing Protocol** -- An interoperable routing protocol built in terms of GIOP that provides a higher level of Quality of Service with respect to message routing and delivery than is currently supported by IIOP. These extensions allow out-of-the-box interoperability and define interfaces for MOM product plug-ins to support CORBA Messaging with value-added QoS services that the particular MOM vendor brings to the market.

### A.3.3 Component Relationships

Figure 22-2 denotes an abstract view of the general Messaging architecture and is not meant to imply any particular implementation.

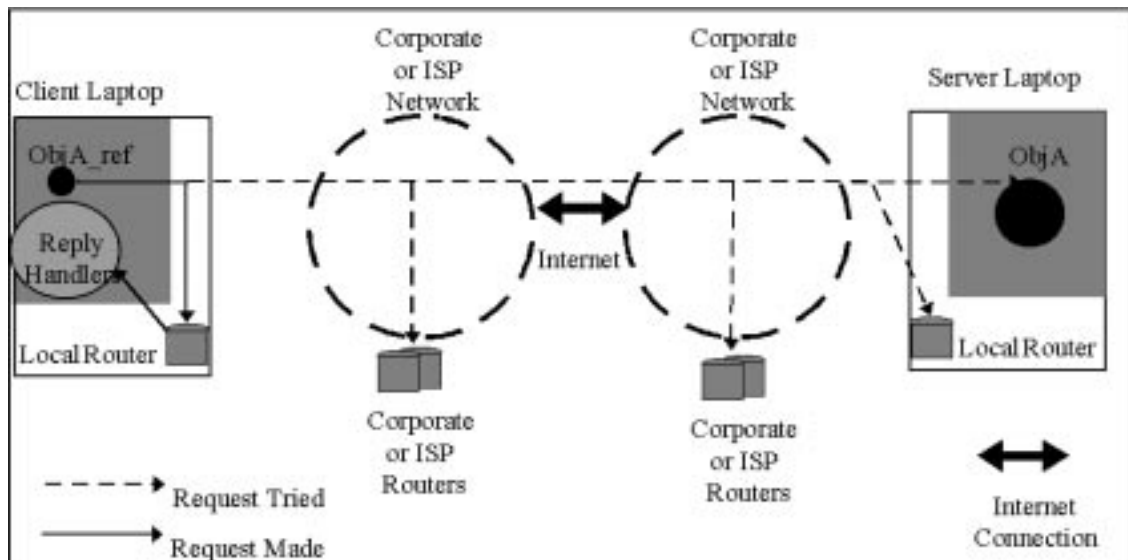

Figure 22-2 TII: No direct connection possible

Figure 22-2 depicts the most general scenario in which a client application residing on a laptop wishes to make an asynchronous method invocation on an object in a server residing on another laptop. Each laptop typically connects to its own corporate or ISP



network. Each of these networks has some set of Request/Reply Routers installed that are meant to be highly available and reliable. These Routers provide store-and-forward capabilities.

In Figure 22-2 neither client nor server laptops are currently connected to their respective networks. In this scenario, the client application makes its requests using the Time-Independent Invocation model. The dashed arrows indicate that the client always tries to make the invocation on the target object or the Request/Reply Router closest to the target. Since the client is not connected, it makes the invocation on the local router (indicated by the solid arrow).

Figure 22-3 depicts an asynchronous invocation in that the replies to the client invoke an operation on a callback object called a **ReplyHandler**. In general, the client may passivate himself, or may die while the request is outstanding. If a persistent delivery quality of service had been specified (with a long enough time-out period) the reply may be delivered when the **ReplyHandler** instance becomes available again. All object adapter features including process activation, Adapter activation and servant activation can be used in ensuring delivery of the reply to a persistent **ReplyHandler**.

Again, Figure 22-3 is meant to depict the most general case.

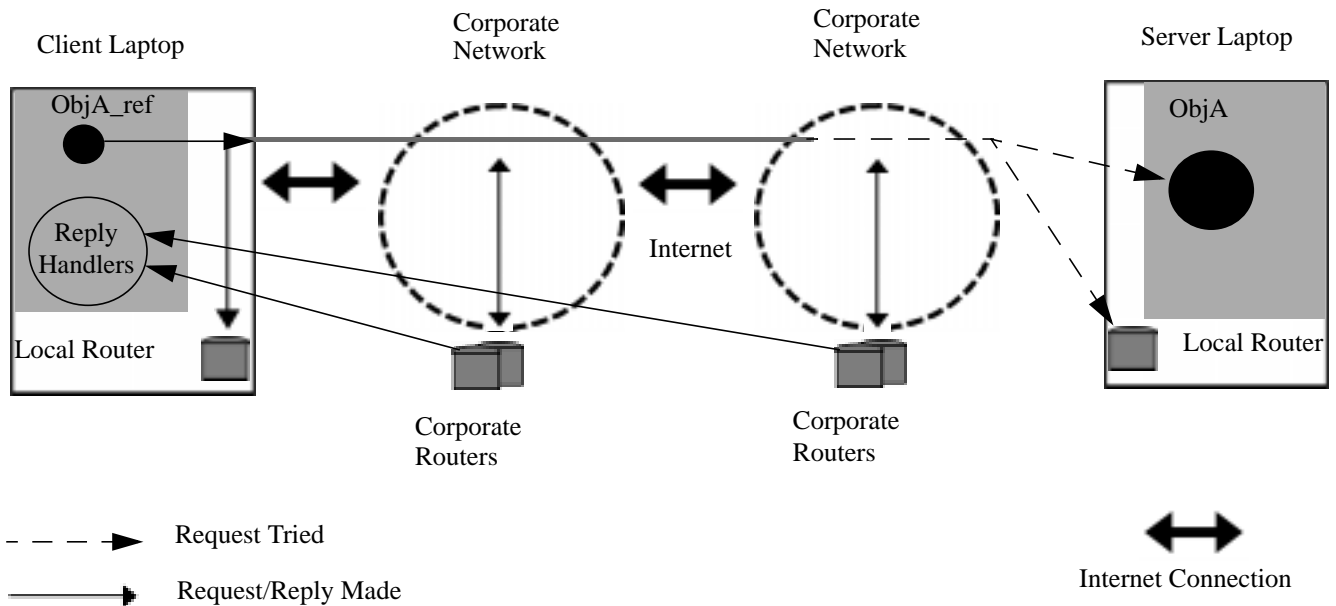

Figure 22-3 TII: Target not available synchronously

Figure 22-4 illustrates the case where the client laptop gains an Internet connection to its corporate network. In this scenario, the Routers that are accessible exchange requests and replies always first trying to contact the target and then sending to the accessible **Router** closest to the target. In Figure 22-3, the server laptop is not accessible so the routers exchange information. Notice that Corporate Routers may have replies to invoke on the client's set of ReplyHandlers now that the client is

reachable. Also, recognize that since the client laptop is now connected, there may be requests and replies for other targets, which are not currently running on the Client Laptop and so are cached in the Client Laptop's **Local Router**.

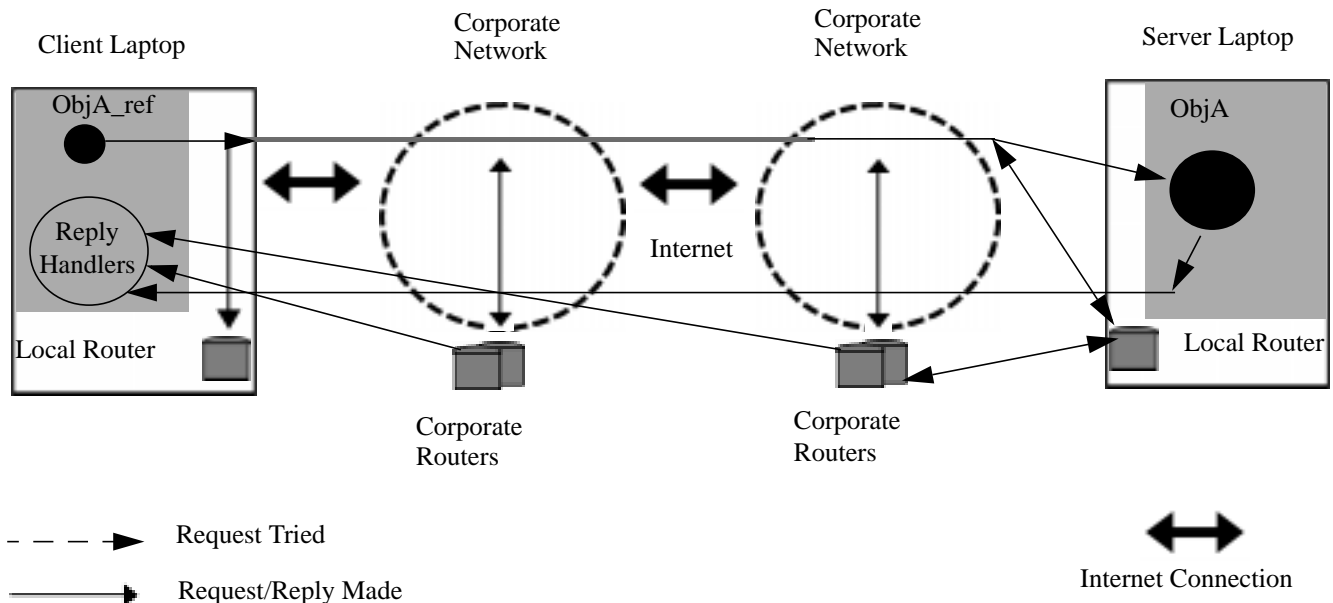

Figure 22-4 Full connectivity available

Finally, Figure 22-4 represents full connectivity. Notice that all of the Request/Reply Routers exchange information to get previously-queued requests/replies closer to their target objects. Since there is full connectivity between the two applications, the client's async invocations can be made on the target object directly and the replies can be sent directly back to make the appropriate invocation on the **ReplyHandler** object.

If the client application has requested queued delivery, a Router is used even in the case depicted in Figure 22-4. Despite the availability of the target, the client ORB sends the request to a Router, which can queue the request prior to attempting the synchronous invocation on the target. As an optimization that limits the request to needing only a single network hop, this Router may be local to the target, but it is still a Router with all the usual responsibilities.

Notice also that since the Server Laptop is connected its Request/Reply Router exchanges information for applications that may or may not be running.

### A.3.4 Callback Model Detailed Design

Several characteristics of the Callback programming model are worth extra attention:

- The **ReplyHandler** is a CORBA object that receives the reply to an AMI. The programmer writes the implementation for a type-specific **ReplyHandler**. A client obtains an object reference for this **ReplyHandler** and passes it as part of the

asynchronous method invocation. When the server completes the request, its reply is delivered as an invocation on the **ReplyHandler** object. This invocation is made on the **ReplyHandler** using the normal POA techniques of servant and object activation. As a result, the callback operation may be handled in a different programming context than that in which the original request was made.

- Exception replies require special handling in the Callback model. Since the **ReplyHandler** implements an IDL interface, all arguments passed to its operations must be defined in IDL as well. However, exceptions cannot be passed as arguments to operations; exceptions can only be raised as part of a reply. To solve this problem, an **ExceptionHandler valuetype** is created to encapsulate the identity and contents of the exception that was raised. An instance of this **ExceptionHandler** is passed as the argument to the **ReplyHandler** operation that indicates an exception was raised by the target. In addition to its exception state, the **ExceptionHandler** also has operations that raise the returned exception, so the **ReplyHandler** implementation can have the returned exception re-raised within its own context.

### *A.3.5 Poller/PersistentRequest Detailed Design*

In the Polling model, the routing relationships are a superset of those seen in the Callback model. The differences in this model appear at both the beginning and end of the request/reply cycle. For Polling, the client application does not establish a Callback **ReplyHandler**. The events that occur when Polling are pictured in Figure 22-5 on page 22-80. The steps are as follows:

1. The client invokes the “sendp” variation of the target object’s operation.
2. The ORB creates a **PersistentRequest** object and associates a reference to it with an invisible **ReplyHandler** that is wrapped in a type-specific Poller value.
3. The ORB returns this Poller to the client.
4. The ORB then proceeds as if the invocation were done with the invisible **ReplyHandler** and sends its request into the network.
5. At the very end, the invisible **ReplyHandler** receives the response and waits for a poll.
6. When the computing context holding the type-specific Poller asks for a response, the Poller obtains the response from the invisible **ReplyHandler** and delivers that response to the caller.

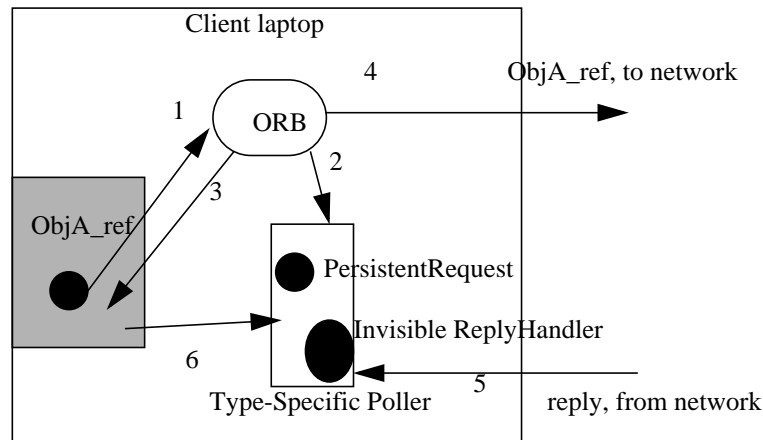

Figure 22-5 Sequence of Steps in Polling

A client uses the **Poller** in a similar fashion as in the DII deferred synchronous model. The programmer can at any time choose to check whether or not the reply has arrived and deal with it in the current programming context. The user may also ask a Poller to block until the reply has arrived. The **PersistentRequest** reference is not visible to the client application, but is specified to enable interoperability between Messaging products.

When a Time-Independent Invocation has been made, it is possible to poll for the reply in a client different from the one that made the initial request. An application takes advantage of this by passing the Poller from the client that made the request to the client that intends to poll for the reply (presumably by way of an Object instance that is collocated with the latter client). Since this Poller is implemented through the use of a **PersistentRequest** object implemented by the Messaging layer, that **PersistentRequest** must be accessible to whichever client uses that Poller. When the TII is used, it is possible for the polling client to obtain the reply after the original invoking client no longer exists. Since the **PersistentRequest** must be implemented in a server that is accessible to the Polling client, that **PersistentRequest** must be external to the original invoking client. A common design might be to have the **PersistentRequest** in this case be implemented by a corporate Router accessible to the invoking client as well as to the client that intends to poll for the response. The creation of **PersistentRequest** objects is discussed in detail in the Section 22.12, “Section III - Introduction,” on page 22-45.

In addition to being able to query the status of an individual Poller, the client can use the **PollableSet** interface to ask about the status of several pollers, as well as the status of any deferred synchronous requests. The client can query to find out if any of a particular set has completed or it can block until one of the set completes.

### *Note on CORBA AMI Support*

Asynchrony is addressed in several places in *CORBA*. These items are taken into consideration by this specification and are modified in the following ways:

- oneway operations - Operations can be defined in IDL to be oneway. Such operations are by their very nature asynchronous, in that no reply is ever received from a oneway operation and no synchrony can be assumed between the client and the target. However, the definition of oneway in the *CORBA* specification does not guarantee a deterministic, portable behavior between compliant ORB products. To address this issue, the *CORBA* Messaging specification introduces a QoS Policy that makes the behavior of oneway operations deterministic. Note that this new Policy addresses the behavior of oneway operations regardless of the use of the new Polling and Callback stubs introduced by this specification.
- DII Deferred Synchronous - Deferred synchronous invocations are supported in *CORBA* only when the DII is used. The *CORBA::Request* pseudo-interface is enhanced by this specification with the additions of TII and the Callback model.

### *Note on Asynchrony and Narrowing of Object References*

Many programming languages map IDL interfaces to programming constructs that support inheritance. In those language mappings (such as C++ and Java) that provide a mechanism for narrowing an Object reference of a base interface to a more derived interface, the act of narrowing may require the full type hierarchy of the target. In this case, the implementation of narrow must either contact an interface repository or the target itself to determine whether or not it is safe to narrow the client's object reference. This requirement is not acceptable when a client is expecting only asynchronous communication with the target. Therefore, for the appropriate languages this specification adds an unchecked narrow operation to the IDL mappings for interface. This unchecked narrow always returns a stub of the requested type without checking that the target really implements that interface. If a client narrows the target to an unsupported interface type, invoking the unsupported operations will raise the system exception *CORBA::BAD\_OPERATION* with standard minor code 2.

## *A.4 Message Routing Abstract Model Design*

This section describes each of the components of the Message Routing abstract model and their relationships.

### *A.4.1 Model Components*

By and large the components of the message routing protocol are the same as those of GIOP. The differences come with respect to two issues:

- TII is essentially a store-and-forwarding mechanism. This implies the use of Request routing agents. The protocol followed by these Routers is defined in Section 22.14, “Message Routing,” on page 22-46, and is intended for insertion into *Common Object Request Broker: Architecture and Specification* as a chapter on Messaging Interoperability.
- Dynamic Protocol Selection based on QoS is reconciled locally via information in the IOR and the local ORB. This implies several newly defined items at the protocol level:
  - Newly defined **IOP::ServiceContext** that contains QoS parameters.
  - Newly defined **IOP::ComponentId** tag for Messaging and a Component consisting of a representation of default QoS parameters.
  - Newly defined **IOP::ComponentId** tag and Component representing the transaction policy.
  - A newly defined **IOP::ComponentId** tag and Component containing a sequence of Request Routers. This sequence of Routers represents the preferred addressing strategy when TIIs are made on an Object.

#### A.4.2 Component Relationships

The relationship between the above described components is based on the following:

- QoS resolution should be performed by the client ORB if possible. Routers and/or Messaging-aware Adapters must ensure that only valid QoS have been selected.
- For efficient use of the Request/Reply Routers, their addressing information needs to be in the IOR.
- Request/Reply Routers re-route request and reply messages by explicitly sending messages between them, and then generating a regular GIOP request (and receiving a regular GIOP reply) when interfacing with the real target. To allow this routing to occur, the Router interface requires an encapsulation of a GIOP request in terms of:
  - Routing information including the message header and pertinent QoS information.
  - Message payload (the marshaled arguments and service contexts from the client).

The routers use the encapsulated QoS & re-routing information to re-route requests and replies and to decide whether to store request/reply information for a specified lifetime. The GIOP must be flexible enough to allow the Router closest to the request’s destination to generate a request that looks like it was marshaled at the original client. This closest Router must be able to handle the full GIOP including the processing of a **LOCATION\_FORWARD** reply without necessitating a return to the original client.

#### A.4.3 Router Administration Design

Several features of the Router administration design are worth note. These fall into two main areas:

- 
- **Static vs. Dynamic Routing** - Routing information for an Object is available to the client ORB through a Profile Component in the object's IOR. This Component contains a sequence of Router references through which Time-Independent requests may pass on the way to the target. Therefore, portably exporting a target's preferred Routers must be done statically, at the time when the target's reference is created. This specification introduces no interfaces that support dynamic routing. It is expected that future work in CORBA Messaging will introduce portable administrative interfaces through which domains of Routers may be connected. Note that since the Router is an Object, the usual CORBA mechanisms for dynamic server relocation can certainly be used to allow migration of Routers and other such dynamic Routing activities.
  - **Minimize administrative traffic** - Administrative interfaces are introduced that will allow a minimal amount of network bandwidth to be consumed when network disconnections occur. Furthermore, these administrative interfaces have been designed so that additional overhead is not consumed when Routers would normally be in an idle state. Administrative communication is only necessary when messages would otherwise have to be sent between Routers.

## Appendix B *Conformance and Compatibility Issues*

This Appendix specifies the points that must be met for a compliant implementation of CORBA Messaging and compatibility issues associated with this specification.

### *B.1 Conformance Issues*

This specification can be separated into several logical components.

In order to be conformant with this specification, the following mappings and features must be supported and implemented using the specified semantics:

- Changes to CORBA and Services. These changes include the modifications to GIOP, OTS, and the **SyncScopePolicy** refinements to **oneway** operations. This component includes the **Policy** management framework for Quality of Service as described in Section 22.1, “Section I - Introduction,” on page 22-2.
- Asynchronous Method Invocation (AMI) interfaces. This component includes the generation of asynchronous stubs (sendc/sendp operations) along with all interfaces and values upon which these stubs rely. All modifications to the DII are also included in this component.
- Quality of Service Policies for Messaging. These new Policies and their possible values are described in Section 22.2, “Messaging Quality of Service,” on page 22-2.

Implementation of the following component is not required to be conformant with this specification:

- Time-Independent Invocations (TII). This component includes the QoS **Policy** that supports TII (**RoutingTypePolicy**), the typed **PersistentPollers** described in Section 22.10.2, “Persistent Type-Specific Poller,” on page 22-28, and all interoperable Routing interfaces described in Section 22.12, “Section III - Introduction,” on page 22-45.

### *B.2 Compatibility Issues*

#### *B.2.1 Transaction Service*

Transaction service compatibility is affected by two factors:

- Changes to existing transaction service behavior introduced as part of this specification.
- New transaction service functions introduced by this specification and the affect on existing implementations.

These are considered separately in each of the following sections.



### B.2.2 Changes to Current OTS Behavior

This specification deprecates the **TransactionalObject** interface defined in the *Transaction Service* specification located in the *CORBAServices* specification. The **TransactionalObject** interface was defined to control propagation of the transaction context between the client and the server. An interface that inherits from **TransactionalObject** will automatically have the client's transaction context established by the server ORB before any operations on that interface are invoked.

A new mechanism for transaction propagation is independent of the use of inheritance from **TransactionalObject**. This mechanism has been defined so that *existing applications will continue to operate correctly without change* so they do not have to remove **TransactionalObject** inheritance from their existing IDL. At most, they will need to ensure that a definition of **CosTransactions::TransactionalObject** continues to be available to the IDL compiler.

The use of **TransactionalObject** inheritance had two other side effects in the *Transaction Service* specification.

- It affected the CORBA type of the interface being defined and thus the RepositoryID in the Interface Repository. This means that once interface inheritance is actually removed, transactional and non-transactional implementations of the same interface will have the same CORBA type.
- It provided for documentation within IDL of interfaces whose implementation was intended to be transactional. This enabled application developers to easily track their use of transactions.

Once **TransactionalObject** is actually removed, these side effects will no longer be present.

#### *Effects of New OTS Functions on Existing OTS Implementations*

This specification introduces new functions and behaviors to the *Transaction Service* to support the global transaction model used by messaging and to encode the transaction model in the object reference using a newly defined **TransactionPolicy**. The default for this new policy has been chosen to be compatible with existing CORBA behavior (i.e., a global transaction is associated with the target object if present) otherwise it is not. Existing applications, which will not create **TransactionPolicy** objects, will get the existing CORBA behavior.

#### *Existing Clients with New Servers*

New server applications can create object references with new **TransactionPolicy** selections that can be exported to existing clients. Depending on the **TransactionPolicy** selected, invoking methods on these objects may succeed transparently to the client or produce failures (in the form of system exceptions) existing clients will not have previously seen.

### *New AMI Clients with Existing Servers*

Existing servers may require analysis of their existing semantics to determine the extent to which they may be able to operate with new clients, especially clients that use the new AMI request invocation model. In general the following are true and existing objects may as a result be usable without change by AMI clients:

- If transactions are not used, existing server objects will interoperate with new AMI clients.
- If transactions are used, AMI invocations will use the new queued transaction model causing invocations on the target object to be rejected with a new system exception.
- Depending on application design, it is possible that some (but not all) of these existing applications can operate successfully with AMI clients. This will require that these server objects be changed to produce new compatible object references.

It is normally true that a server application design, which depends on updating recoverable resources managed by objects at multiple sites cannot support an AMI invocation without producing different behavior. For the cases where this is not a problem the application can take advantage of new AMI clients by changing the object reference at creation time.

### *B.2.3 Security Service*

The issues surrounding Security and Time-Independent Invocations must be addressed in a subsequent RFP. Current CORBA Security does fully support all other aspects of this specification, including typed deferred synchronous invocations.

## *Contents*

This chapter contains the following topics.

| <b>Topic</b>                       | <b>Page</b> |
|------------------------------------|-------------|
| “Fault Tolerant CORBA”             | 23-1        |
| “Basic Fault Tolerance Mechanisms” | 23-12       |
| “Replication Management”           | 23-31       |
| “Fault Management”                 | 23-66       |
| “Logging & Recovery Management”    | 23-81       |
| “Consolidated IDL”                 | 23-88       |
| Appendix A- “Glossary”             | 23-96       |
| Appendix B- “Compliance Points”    | 23-105      |

## *23.1 Fault Tolerant CORBA*

### *23.1.1 Fault Tolerance for Diverse Applications*

Many different kinds of applications, developed by the members of the OMG and the users of CORBA, have a need for fault tolerance. These applications range from very large critical systems (such as air traffic control and defense systems) to smaller critical systems (such as 911 and medical systems) to embedded applications (such as aircraft instrumentation and manufacturing control applications) to communication systems (such as telephony and networking systems) to enterprise applications (such as financial and supply chain applications).

A standard that attempts to meet all of the requirements of this wide spectrum of applications might satisfy many needs only poorly, or might be too complex to implement. This specification therefore represents a number of compromises. In particular, to provide full interoperability between the products of different vendors, substantially more interfaces and protocols would need to be defined than are defined in this specification. Once experience of implementation and use of the specification has been gained, it might be appropriate to extend the specification to provide greater interoperability and fault tolerance. In the meantime, some vendors may choose to offer proprietary extensions to satisfy the fault tolerance needs of specific kinds of applications.

### *23.1.2 Objectives*

The standard for Fault Tolerant CORBA aims to provide robust support for applications that require a high level of reliability, including applications that require more reliability than can be provided by a single backup server. The standard requires that there shall be no single point of failure.

Fault tolerance depends on entity redundancy, fault detection, and recovery. The entity redundancy by which this specification provides fault tolerance is the replication of objects. This strategy allows greater flexibility in configuration management of the number of replicas, and of their assignment to different hosts, compared to server replication. Replicated objects can invoke the methods of other replicated objects without regard to the physical location of those objects. Support for redundancy in time is provided by allowing clients to make repeated requests on the server, using the same or alternative transport paths.

The standard supports a range of fault tolerance strategies, including request retry, redirection to an alternative server, passive (primary/backup) replication, and active replication which provides more rapid recovery from faults. The standard allows the users to define fault tolerance properties for each replicated object (object group).

The standard supports applications that require the Fault Tolerance Infrastructure to control the creation of the application object replicas, as well as applications that control directly the creation of their own object replicas. It supports applications that require the Fault Tolerance Infrastructure to maintain Strong Replica Consistency, both under normal conditions and under fault conditions, as well as applications that provide whatever level of consistency they require.

The standard provides support for fault detection, notification, and analysis for the object replicas. It supports applications that require the Fault Tolerance Infrastructure to provide automatic checkpointing, logging and recovery from faults, as well as applications that handle their own fault recovery.

The standard aims for minimal modifications to the application programs, and for transparency to replication and to faults. It defines minimal modifications to existing ORBs that allow non-replicated clients to derive fault tolerance benefits when they invoke replicated server objects.

### 23.1.3 Basic Concepts

#### 23.1.3.1 Replication and Object Groups

To render an object fault-tolerant, several replicas of the object are created and managed as an *object group*. While each individual replica of an object has its own object reference, an additional *interoperable object group reference (IOGR)* is introduced for the object group as a whole. It is this object group reference that the replicated server publishes for use by the client objects. The client objects invoke methods on the server object group, and the members of the server object group execute the methods and return their responses to the clients, just like a conventional object. Because of the object group abstraction, the client objects are not aware that the server objects are replicated (*replication transparency*) and are not aware of faults in the server replicas or of recovery from faults (*failure transparency*).

#### 23.1.3.2 Fault Tolerance Domains

Many applications that need fault tolerance are quite large and complex. Managing such an application as a single entity is inappropriate. Consequently, this specification defines *fault tolerance domains*, as illustrated in Figure 23-1. Each fault tolerance domain typically contains several hosts and many object groups, and a single host may support several fault tolerance domains. Existing security policies and mechanisms can be maintained by ensuring that a fault tolerance domain is entirely contained within a single security domain. All of the objects groups within a fault tolerance domain are created and managed by a single Replication Manager, but they can invoke and can be invoked by objects within other fault tolerance domains. The concept of fault tolerance domains allows applications to scale to arbitrary sizes, by allowing a smaller number of objects to be managed by each Replication Manager.

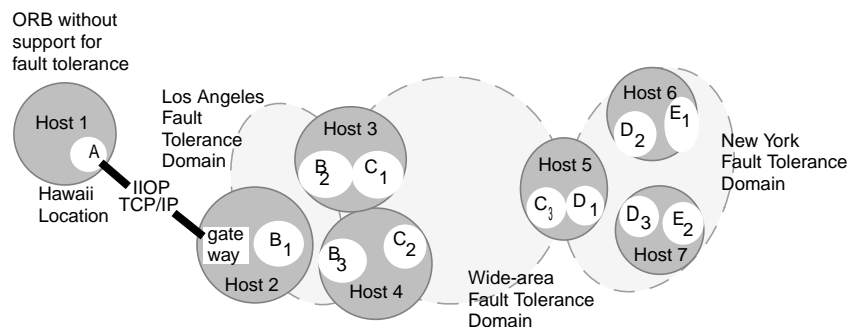

Figure 23-1 Fault tolerance domains are shown lightly shaded, hosts are shown darkly shaded, and members of an object group are shown unshaded. The members of object group B are denoted B<sub>1</sub>, B<sub>2</sub> and B<sub>3</sub>, and similarly for object groups C, D and E.

### 23.1.3.3 *Fault Tolerance Properties*

Each object group has an associated set of fault tolerance properties. Examples of such properties are the **ReplicationStyle** (**COLD\_PASSIVE**, **WARM\_PASSIVE**, **ACTIVE**, etc.), **InitialNumberReplicas**, **MinimumNumberReplicas**, etc. It is possible to define fault tolerance properties that apply to all object groups within a fault tolerance domain or to all object groups of a specific type. It is also possible to set the properties of an object group when it is created, and to change the properties dynamically after the object group is created.

### 23.1.3.4 *Strong Replica Consistency*

Strong replica consistency requires that the states of the members of an object group remain consistent (identical) as methods are invoked on the object group and as faults occur. More specifically, for the **ACTIVE ReplicationStyle**, Strong Replica Consistency means that, at the end of each method invocation on the object group, all of the members of the object group have the same state. For the **COLD\_PASSIVE** and **WARM\_PASSIVE ReplicationStyles**, it means that, at the end of each state transfer, all of the members of the object group have the same state. Strong Replica Consistency requires Strong Group Membership, as well as Uniqueness of the Primary for passive replication. Strong Group Membership means that, for each method invocation on an object group, the Fault Tolerance Infrastructures on all hosts have the same view of the membership of the object group. Uniqueness of the Primary for passive replication means that one and only one member of the object group executes the methods invoked on the object group.

### 23.1.4 *Architectural Overview*

Figure 23-2 presents an architectural overview of a fault-tolerant system, showing an example strategy for implementation of the specifications for Fault Tolerant CORBA. Other implementation strategies are possible.

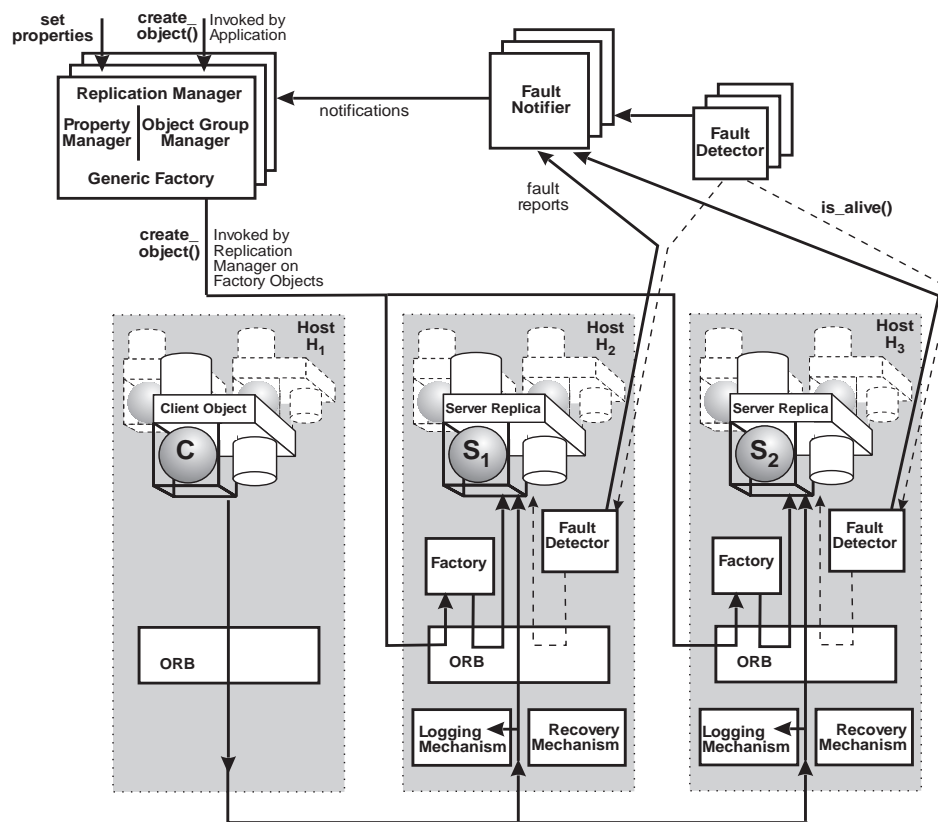

Figure 23-2 Architectural Overview of a Fault-Tolerant System

At the top of the figure are shown several components of the Fault Tolerance Infrastructure (Replication Manager, Fault Notifier, Fault Detector), all of which are implemented as CORBA objects. Logically, there is a single instance of the Replication Manager and Fault Notifier in each fault tolerance domain but, physically, they are replicated to protect against faults, just as are the application objects. The Replication Manager inherits the **PropertyManager**, **ObjectGroupManager**, and **GenericFactory** interfaces.

The bottom of the figure shows three hosts, as follows:

- a client application object C on host H<sub>1</sub> that is invoking a replicated server object with two replicas,
- S<sub>1</sub> on host H<sub>2</sub>, and
- S<sub>2</sub> on host H<sub>3</sub>.

A typical system will contain many such client and server objects.

The figure shows Factory and Fault Detector objects that may be present on each host and are specific to that host. These host-specific objects are not replicated, unlike the service objects shown at the top of the figure, which are replicated objects.

The figure also shows the Message Handler and the Logging and Recovery Mechanisms that are present on each host. These are not CORBA objects but, rather, are a part of the ORB, or are located between the ORB and the operating system.

#### 23.1.4.1 *Fault Tolerance Property Management*

This specification provides a **PropertyManager** interface that allows the user to define fault tolerance properties of object groups. The specification of the **PropertyManager** interface is designed to allow vendors to develop graphical user interfaces and to define additional properties should they so desire.

Two properties of particular relevance are the Membership Style and the Consistency Style. The Membership Style defines whether the membership of an object group is infrastructure-controlled or application-controlled. Similarly, the Consistency Style defines whether the consistency of the states of the members of an object group is infrastructure-controlled or application-controlled. Some components of the Fault Tolerance Infrastructure, such as the Logging and Recovery Mechanisms, are used only for object groups that have the infrastructure-controlled Consistency Style.

#### 23.1.4.2 *Replication Management*

For the infrastructure-controlled (**MEMB\_INF\_CTRL**) Membership Style (Section 23.3.2.2, “MembershipStyle,” on page 23-33) the replication of objects is substantially transparent to the application program, which simplifies the development of new application programs, and allows the continued use of existing application programs.

Using the **create\_object()** operation of the **GenericFactory** interface, the application program requests the creation of a replicated object (object group), just as it would an unreplicated object. This operation is invoked on the Replication Manager, rather than directly on the factory (as it would have been in the unreplicated case). The Replication Manager then invokes the factories, on the different hosts, where a replica is to be created, using the same **create\_object()** operation of the **GenericFactory** interface.

Using the **create\_member()**, **add\_member()**, and **remove\_member()** operations of the **ObjectGroupManager** interface, the application can exercise control over the addition and removal, and location, of members of an object group (violating transparency).

While each individual replica has its own object reference, the object group as a whole has its interoperable object group reference, which is created by the Replication Manager. This object group reference contains a **TAG\_FT\_GROUP** component for the object group within the profiles of the object group reference. The object group reference is returned to the application by the Replication Manager, and is published by the server object. The client objects use the object group reference to invoke methods on the server object group, just as they would have used a conventional object reference for an unreplicated object.



Because of the object group abstraction, the client objects are not aware that the server objects are replicated (client transparency to replication), and are not aware of faults in the server replicas or of the recovery of server replicas when a fault has occurred (client transparency to faults).

### 23.1.4.3 *Fault Detection and Notification*

Fault tolerance requires fault detection, and typical systems contain several fault detection mechanisms to detect host failures, resource exhaustion, etc. This specification defines a simple **PullMonitorable** interface that the application objects inherit. The **PullMonitorable** interface contains the **is\_alive()** operation that a Fault Detector invokes. For efficiency, the Fault Detector that monitors an application object is typically located on the same host as that object, while the local Fault Detectors are monitored by a global Fault Detector that is replicated for fault tolerance.

The Fault Detector, and other kinds of fault detectors in the system, such as those based on the PUSH Monitoring Style and those that detect host or network faults, report faults to the Fault Notifier, which passes fault notifications to the Replication Manager and other objects that have registered for such notifications. An application-specific fault analyzer may register to receive such notifications, and may condense and filter such notifications into further fault reports that it returns to the Fault Notifier.

### 23.1.4.4 *Logging and Recovery*

For the **COLD\_PASSIVE** and **WARM\_PASSIVE** Replication Styles, under fault-free conditions, only one member of an object group, the primary member, executes the requests and generates the replies. If the Fault Detector suspects that the primary member is faulty, the Replication Manager, at its discretion, restarts the current primary member or promotes a backup member to become the new primary member.

For the application-controlled (**CONS\_APP\_CTRL**) Consistency Style, the Replication Manager takes no further recovery action and the new primary member is responsible for the recovery of its own state.

For the infrastructure-controlled (**CONS\_INF\_CTRL**) Consistency Style, the new primary member must start operation with the appropriate state, and must execute the same sequence of requests that were, or should have been, executed by the previous primary member, had it not failed. Thus, each GIOP message is passed to the Logging and Recovery Mechanisms, automatically and invisibly to the application. The Logging Mechanism records the message in a log, from which the Recovery Mechanism can retrieve the message during recovery.

Periodically, the Logging Mechanism invokes the **get\_state()** operation of the **Checkpointable** interface, which must be implemented by every replicated application object, to obtain the state of the object, so that the state can be recorded in a log. During recovery, the Recovery Mechanism invokes the **set\_state()** operation of the **Checkpointable** interface of the new primary to set its state to the state that was recorded in the log.

### 23.1.5 Requirements

The requirements of the Fault Tolerant CORBA specification are stated below.

#### ***CORBA Object Model***

For object groups with the infrastructure-controlled (**CONS\_INF\_CTRL**) Consistency Style (Section 23.3.2.3, “ConsistencyStyle,” on page 23-34), the specification requires that the CORBA object model is preserved. Even though an object is replicated to provide protection against faults, at all times its behavior shall appear to be the behavior of a single object. In particular, a replicated object can act as a client or a server or both, and can invoke another replicated object, regardless of the fault tolerance properties of the two object groups.

#### ***CORBA Object Reference Model***

The specification introduces three new special tagged components into the CORBA object reference model. The object group references that are used for fault tolerance contain multiple profiles that contain these components. Even though an object group reference contains such components in its profiles, an unreplicated object, hosted by an ORB that does not support fault tolerance, can still use the reference to invoke the methods of the replicated object. Similarly, a replicated object can use the object reference of an unreplicated object to invoke the methods of the unreplicated object.

#### ***Transparency to Replication and to Faults***

Creating or deleting an object using a Generic Factory, and invoking a method of an object, appear the same for replicated objects as for unreplicated objects. Similarly, the behavior of a replicated server object when invoked by a client object appears the same whether or not faults occur, except perhaps for a transient delay if the primary member of a passively replicated object becomes faulty.

#### ***No Single Point of Failure***

The specification supports applications that need robust fault tolerance, including applications that require higher reliability than can be provided by a single backup. The specification requires that there shall be no single points of failure.

#### ***Client Redirection***

For a client and a replicated server, the specification defines an interoperable object group reference that allows the client to connect to the server replicas, by connecting to an alternative server or through an alternative network, when a fault in a server replica occurs. It defines an additional service context, in request messages, that allows a server to determine if the object group reference for the server used by a client is obsolete. Transparency to the client application program is provided, with minimal modifications to the client ORB and simple mechanisms in the server ORB. Typical applications include desktop client access to enterprise servers.

### ***Transparent Reinvocation***

The specification introduces an additional service context in Request messages that ensures that, in the presence of faults, a client can reinvoke a request on a replicated server and receive a reply to that request, without risk that the operation will be performed more than once. Typical applications include desktop client access to e-commerce applications.

### ***Infrastructure-Controlled Membership***

The infrastructure-controlled (**MEMB\_INF\_CTRL**) Membership Style allows the application to direct the Replication Manager to create an object group. The Replication Manager then invokes the factories at the different locations to create the object replicas, and then add them to the group. The Replication Manager is responsible for creating the initial number of replicas and for maintaining the minimum number of replicas, as specified by the fault tolerance properties for the group. Typical applications include enterprise server applications, such as supply chain applications, and large-scale critical systems, such as defense applications.

### ***Application-Controlled Membership***

The application-controlled (**MEMB\_APP\_CTRL**) Membership Style allows the application to create the members of an object group and to direct the Replication Manager to add them to the group, or to direct the Replication Manager to create the members of an object group and add them to the group. The application is responsible for maintaining the initial and minimum number of replicas and the locations of the replicas, both initially and after faults. Application-controlled membership is particularly important for applications whose different hosts have different capabilities, such as communication network applications.

### ***Infrastructure-Controlled Consistency***

The infrastructure-controlled (**CONS\_INF\_CTRL**) Consistency Style provides Strong Replica Consistency between the states of the members of an object group. Strong Replica Consistency requires that, even in the presence of faults, as members of an object group execute a sequence of methods invoked on the object group, the behavior is logically equivalent to that of a single fault-free object processing the same sequence of method invocations. The Fault Tolerance Infrastructure provides logging, checkpointing, activation, and recovery mechanisms to achieve Strong Replica Consistency. Strong Replica Consistency is particularly important for financial applications and safety-critical applications, such as industrial process control and aircraft instrumentation.

### ***Application-Controlled Consistency***

The application-controlled (**CONS\_APP\_CTRL**) Consistency Style depends on application-specific mechanisms to ensure whatever consistency is required for the members of an object group. Application-controlled consistency does not depend on the Fault Tolerance Infrastructure to provide logging, checkpointing or recovery, and does not guarantee Strong Replica Consistency. Typical applications might include telecommunications applications, and some embedded and real-time applications.

### ***Passive Replication***

The **COLD\_PASSIVE** or **WARM\_PASSIVE** Replication Styles require that, during fault-free operation, only one member of the object group, the primary member, executes the methods invoked on the group. Periodically, the state of the primary member is recorded in a log, together with the sequence of method invocations. In the presence of a fault, a backup member is promoted to be the new primary member of the group. The state of the new primary is restored to the state of the old primary by reloading its state from the log, followed by reapplying request messages recorded in the log. Passive replication is useful when the cost of executing a method invocation is larger than the cost of transferring a state, and the time for recovery after a fault is not constrained. Typical examples include enterprise inventory, logistics applications, and hospital record keeping.

### ***Active Replication***

The **ACTIVE** Replication Style requires that all of the members of an object group execute each invocation independently but in the same order, so that they maintain exactly the same state and, in the event of a fault in one member, that the application can continue with results from another member without waiting for fault detection and recovery. Even though each of the members of the object group generates each request and each reply, the Message Handling Mechanism detects and suppresses duplicate requests and replies, and delivers a single request or reply to the destination object(s). Active replication is useful when the cost of transferring a state is larger than the cost of executing a method invocation, or when the time available for recovery after a fault is tightly constrained. Typical examples include enterprise electronic trading applications and safety-critical applications, such as hospital patient monitoring.

### ***Fault Detection and Notification***

The Fault Management interfaces allow detection of object crash faults, and provide fault notifications to the entities that have registered for such notifications. Accuracy of fault detection is impossible in an asynchronous fault-tolerant distributed system. Occasional false suspicions cause no harm in a robust fault-tolerant system. If a host crashes or an object hangs, the Fault Detectors are required to detect the fault in a timely manner. However, a Fault Detector must not continuously suspect all members of an object group, unless all of them are indeed faulty. Most fault-tolerant applications will use the Fault Management interfaces, but they are particularly important for telecommunications, electric power distribution and other safety-critical applications.

### ***Logging and Recovery***

The Logging and Recovery Mechanisms and Checkpointable and Updateable interfaces allow an application object to record its state, for use in recovery after a fault or to initialize another replica. Following a fault that damages one or more, but not all, of the members of an object group, recovery is required to ensure that the continued behavior of the replicated object after recovery is the same as it would have been in the absence of the fault. A recovering member executes the same requests in the same order, generates the same replies, invokes the same methods of other objects, and reaches the same internal state, as if no fault had occurred. If a request is partially executed when a fault occurs, that request is fully executed, at the same position in the

sequence of messages, during recovery. If an object invokes a method of another object and then becomes faulty, that method invocation must not be duplicated during recovery. Because some objects may be unreplicated, or may be supported by ORBs that do not provide fault tolerance, or may use different Replication Styles, the recovery of each object must be self-contained and must not depend on the cooperation of any other object. Applications that employ the infrastructure-controlled Consistency Style will use these mechanisms and interfaces.

### 23.1.6 *Limitations*

The limitations of the Fault Tolerant CORBA specification are given below.

#### ***Legacy ORBs***

An unreplicated client hosted by a legacy ORB can invoke methods of a replicated server, supported by the Fault Tolerance Infrastructure. The object group references generated for replicated servers can be used by legacy ORBs, although the full benefits of fault-tolerant operation are not achieved for an unreplicated client. If a legacy ORB has been modified to understand object group references and to retry requests at alternative destinations, the unreplicated client receives the benefits of a higher, but still partial, level of fault tolerance. Special service contexts in the request and reply messages protect an unreplicated client from a replicated server executing its requests multiple times when the client retries those requests at alternative destinations.

#### ***Common Infrastructure***

All of the hosts within a fault tolerance domain must use ORBs from the same vendor and Fault Tolerance Infrastructures from the same vendor to ensure interoperability and full fault tolerance within that domain. Consequently, the members of an object group must be hosted by ORBs from the same vendor and Fault Tolerance Infrastructures from the same vendor. For clients and servers in different fault tolerance domains, both using ORBs and Fault Tolerance Infrastructures from the same vendors, full fault tolerance can be achieved. Otherwise, the specifications provide a useful improvement over no fault tolerance but substantially less than full fault tolerance.

#### ***Deterministic Behavior***

For the infrastructure-controlled Consistency Style, for both active and passive replication, deterministic behavior is required of the application objects, and of the ORBs, to guarantee Strong Replica Consistency. The inputs to the replicas of an object must be consistent (identical); this implies that request and reply messages must be delivered in the same order to each of the replicas of an object. If sources of non-determinism exist, they must be filtered out. Multi-threading in the application or the ORB may be restricted, or transactional abort/rollback mechanisms may be used.

### ***Network Partitioning Faults***

Network partitioning faults separate the hosts of the system into two or more sets, the hosts of each set being able to operate and to communicate within that set but not with hosts of different sets. The current state-of-the-art does not provide an adequate solution to network partitioning faults. Thus, network partitioning faults are not addressed in this specification.

### ***Commission Faults***

A commission fault occurs when an object or host generates incorrect results. A Byzantine fault is a commission fault in which an object or host generates incorrect results maliciously. Algorithms have been devised to detect and protect against a fairly wide range of Byzantine faults but they are complex and expensive in processing and communication. In the current state-of-the-art, Byzantine algorithms are seldom appropriate for fault tolerance but might be appropriate for security, to protect a system after one or more of its hosts have been subverted by intruders. The specification provides an **ACTIVE\_WITH\_VOTING** Replication Style. Voting itself is relatively inexpensive, but the communications infrastructure required to support voting properly is substantially more expensive than that required to tolerate only crash faults.

### ***Correlated Faults***

No protection is provided against design or programming faults, or other correlated faults, that cause the same errors in all replicas of an object, in all ORBs, or in all hosts or their operating systems.

## ***23.2 Basic Fault Tolerance Mechanisms***

### ***23.2.1 Overview***

This section defines basic fault tolerance mechanisms that must be implemented for Fault Tolerant CORBA. The client-side mechanisms are intended to be simple light weight extensions to CORBA that will be easy to implement. These mechanisms enable client-side ORBs to achieve a higher level of reliability by exploiting the fault tolerance mechanisms defined for server-side ORBs.

In particular, this section defines:

- Interoperable object group reference that contains multiple **TAG\_INTERNET\_IOP** profiles, each of which contains the **TAG\_FT\_GROUP** component and one of which may contain a **TAG\_FT\_PRIMARY** component. The interoperable object group reference may contain the **TAG\_MULTIPLE\_COMPONENTS** profile, which may contain the **TAG\_FT\_GROUP** component.
- Failover semantics for Fault Tolerant CORBA that extend the failover semantics for the CORBA core.

- Most recent object group reference for a server object group, using the **FT\_GROUP\_VERSION** service context in a client's request message. The **FT\_GROUP\_VERSION** service context allows the server to determine whether the client is using the most recent object group reference for the server object group.
- Transparent reinvocations of requests, using the **FT\_REQUEST** service context in a client's request messages, the client-side Request Duration Policy and the fault handling semantics of GIOP messages. The **FT\_REQUEST** service context prevents a request from being executed two or more times as a consequence of reinvocation of the request on a backup server after a fault.
- Heartbeating of the server, using the **TAG\_FT\_HEARTBEAT\_ENABLED** component of the **TAG\_INTERNET\_IOP** profile, the client-side Heartbeat Policy and the server-side Heartbeat Enabled Policy. This allows the client to detect failure of the server.

### 23.2.2 Interoperable Object Group References

This section extends the definition of an interoperable object reference (IOR) to encompass references to server object groups. The interoperable object group reference (IOGR) for a server object group is an IOR that contains multiple **TAG\_INTERNET\_IOP** profiles and that may contain a **TAG\_MULTIPLE\_COMPONENTS** profile.

Each of the **TAG\_INTERNET\_IOP** profiles must contain the **TAG\_FT\_GROUP** component, and may contain other components such as **TAG\_IOP\_ALTERNATE\_ADDRESS** components. At most one of the **TAG\_INTERNET\_IOP** profiles may contain the **TAG\_FT\_PRIMARY** component. The **TAG\_MULTIPLE\_COMPONENTS** profile may also contain the **TAG\_FT\_GROUP** component, which must be used for object groups that have no members. An example is shown in Figure 27-3 on page 27-14.

The **TAG\_FT\_GROUP** component and **TAG\_FT\_PRIMARY** component are described in Section 23.2.2.1, "TAG\_FT\_GROUP Component," on page 23-14 and Section 23.2.2.2, "TAG\_FT\_PRIMARY Component," on page 23-16.

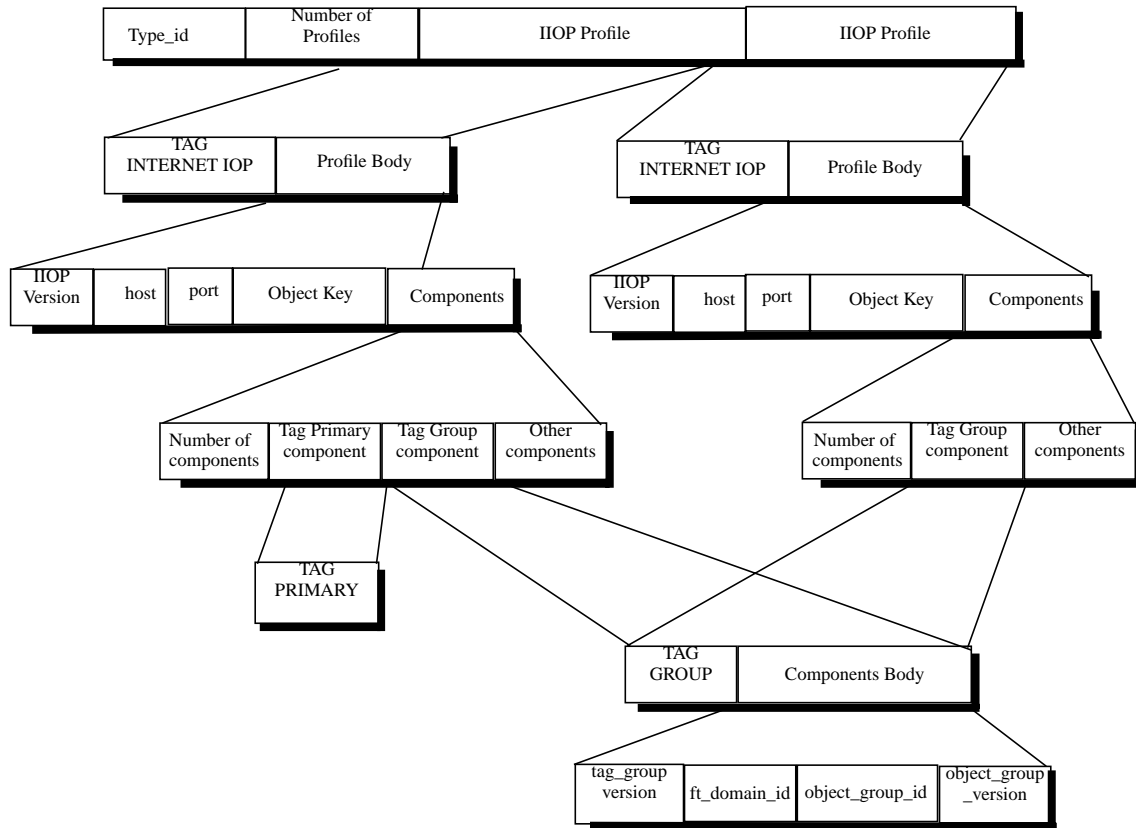

*Figure 23-3* An example of the Interoperable Object Group Reference Used for Fault Tolerance. The reference is an IOR that contains multiple TAG\_INTERNET\_IOP profiles, any of which may be used to reach the server object group. The reference may also contain a TAG\_MULTIPLE\_COMPONENTS profile. The TAG\_FT\_GROUP component is contained in every profile of the reference. The TAG\_FT\_PRIMARY component is contained in at most one TAG\_INTERNET\_IOP profile.

### 23.2.2.1 TAG\_FT\_GROUP Component

The **TAG\_FT\_GROUP** component is contained in the profiles of the interoperable object group reference.

```

module IOP {
 const ComponentId TAG_FT_GROUP = 27;
};

module FT {
 typedef string FTDomainId;
 typedef unsigned long long ObjectGroupId;
 typedef unsigned long ObjectGroupRefVersion;

 struct TagFTGroupTaggedComponent { // tag = TAG_FT_GROUP;

```



```

 GIOP::Version version;
 FTDomainId ft_domain_id;
 ObjectGroupId object_group_id;
 ObjectGroupRefVersion object_group_ref_version;
 };
};

```

Object groups have an identity that persists even as the membership of the object group changes. Thus, an object group requires an identifier that is unique within the context of a fault tolerance domain. Moreover, as the membership of an object group changes, the object group reference may have different versions. To address these concerns, Fault Tolerant CORBA introduces the following types.

```
typedef string FTDomainId;
```

The identifier of a fault tolerance domain.

```
typedef unsigned long long ObjectGroupId;
```

The identifier of an object group.

```
typedef unsigned long ObjectGroupRefVersion;
```

The version number of the object group reference.

The **TAG\_FT\_GROUP** component contains the fault tolerance domain identifier and object group identifier of the server object group, which are used to reach the server object group. It also contains the **object\_group\_ref\_version**, which the client ORB may put in the **FT\_GROUP\_VERSION** service context in the client's request messages, as described in Section 23.2.7.1, "FT\_GROUP\_VERSION Service Context," on page 23-22.

```
const ComponentId TAG_FT_GROUP = 27;
```

A constant that designates the **TAG\_FT\_GROUP** component that is contained in the **TAG\_INTERNET\_IOP** profiles and may be contained in the **TAG\_MULTIPLE\_COMPONENTS** profile.

```

struct TagFTGroupTaggedComponent { // tag = TAG_FT_GROUP;
 GIOP::Version version;
 FTDomainId ft_domain_id;
 ObjectGroupId object_group_id;
 ObjectGroupRefVersion object_group_ref_version;
};

```

The **TAG\_FT\_GROUP** component, within the **TAG\_INTERNET\_IOP** profiles and **TAG\_MULTIPLE\_COMPONENTS** profile, contains the version of the **TAG\_FT\_GROUP** component, the fault tolerance domain identifier, the object group identifier, and the version number of the object group reference for the server object group. For implementations conforming to this version of the specification, the value of `version.major` must be 1 and the value of the `version.minor` must be 0.

### 23.2.2.2 *TAG\_FT\_PRIMARY Component*

The **TAG\_FT\_PRIMARY** component is contained in at most one of the **TAG\_INTERNET\_IOP** profiles of the interoperable object group reference.

```

module IOP {
 const ComponentId TAG_FT_PRIMARY = 28;
};

module FT {
 struct TagFTPPrimaryTaggedComponent { // tag = TAG_FT_PRIMARY;
 boolean primary;
 };
};

```

The profile that contains the **TAG\_FT\_PRIMARY** component is used in preference to other profiles to reach the server object group.

```
const ComponentId TAG_FT_PRIMARY = 28;
```

A constant that designates the **TAG\_FT\_PRIMARY** component that is contained in at most one of the **TAG\_INTERNET\_IOP** profiles.

```
struct TagFTPPrimaryTaggedComponent { // tag = TAG_FT_PRIMARY;
 boolean primary;
};
```

The **TagFTPPrimaryTaggedComponent**, when present in a **TAG\_INTERNET\_IOP** profile, indicates that the profile is to be used in preference to the other **TAG\_INTERNET\_IOP** profiles within the object group reference.

At most one of the profiles in the object group reference contains the **TAG\_FT\_PRIMARY** component. A client-side ORB may use that profile in preference to the other profiles. It is not mandated that the ORB must choose the profile containing the **TAG\_FT\_PRIMARY** component. Moreover, it cannot be guaranteed that the endpoint addressed by the profile containing the **TAG\_FT\_PRIMARY** component is currently the primary endpoint for the object group.

Use of any of the profiles, other than that containing the **TAG\_FT\_PRIMARY** component, may result in one or more **LOCATION\_FORWARDS** and thus reduced efficiency. No requirement is imposed on the particular order in which the other profiles, that do not contain the **TAG\_FT\_PRIMARY** component, must be used.

### 23.2.3 *Interoperable Object Group Reference Operations*

IOGRs are IORs. However, the semantics of several of the operations inherited from **CORBA::Object** must be adjusted to account for the group contents of an IOGR.

### 23.2.3.1 *get\_interface*

Unchanged. The assembly procedure for an object group guarantees that the interfaces supported by the object group are supported by all members of the object group.

### 23.2.3.2 *is\_a*

Unchanged.

### 23.2.3.3 *is\_nil*

Essentially unchanged. True if no profiles are present or if **is\_nil** is true for all of the profiles.

### 23.2.3.4 *non\_existent*

Essentially unchanged. True if the object group does not exist. Note that the object group might exist even if **non\_existent()** is true for all of the profiles of the object group reference or even if there are no IOP profiles in the object group reference. (This occurs when an object group with the application-controlled Membership Style is created with no members so that the members can be added individually by the application.) A server ORB can obtain an authoritative determination of non-existence of the object group from the Replication Manager, using the same mechanisms as are used to obtain the most recent object group reference. The ORB must use those mechanisms to generate a **LOCATION\_FORWARD** reply when the client's request contains an obsolete **object\_group\_ref\_version** field in the **FT\_GROUP\_VERSION** service context.

### 23.2.3.5 *is\_equivalent*

There are three cases to consider for checking equivalence:

1. Two non-object group references. The semantics of the operation are unchanged in this case.
2. An object group reference and a non-object group reference. These references are not equivalent.
3. Two object group references. Section 23.2.2.1, "TAG\_FT\_GROUP Component," on page 23-14 introduces a strong identity for an object group in its **ft\_domain\_id** and **object\_group\_id** fields. Two object group references are equivalent if they have the same **ft\_domain\_id** and the same **object\_group\_id** fields. Note that the **object\_group\_ref\_version** field in the **TAG\_FT\_GROUP** component is ignored.

The analysis of these cases collapses the semantics to the following:

- Non-Fault-Tolerant CORBA implementations are essentially unchanged. These implementations might not recognize certain object group references as representing the same object group. However, that is allowed under the present semantics.

- Fault Tolerant CORBA implementations compare the values of the corresponding **ft\_domain\_id** and **object\_group\_id** fields in the **TAG\_FT\_GROUP** components to determine the equivalence of two object group references. Otherwise, the semantics for **is\_equivalent** are unchanged.

#### 23.2.3.6 *hash*

Follows the semantics for **is\_equivalent()**. An interoperable object group reference contains an object group identifier that is unique and immutable over the lifetime of the object group. For such a reference, the value of **hash()** shall be derived from the object group identifier. For references that are not interoperable object group references, the value of **hash()** continues to be derived as at present.

#### 23.2.3.7 *create\_request*

Unchanged.

#### 23.2.3.8 *get\_policy*

Unchanged.

#### 23.2.3.9 *get\_domain\_managers*

Unchanged.

#### 23.2.3.10 *set\_policy\_overrides*

Unchanged.

### 23.2.4 *Modes of Profile Addressing*

The interoperable object group references contain profiles that address server object groups. This section illustrates the use of these profiles according to one of two modes:

- Profiles that address object group members.
- Profiles that address gateways (technically generic in-line bridges of the type described in the *Building Inter-ORB Bridges* chapter of the CORBA specification).

The choice of addressing mode is influenced by the Replication Style of the object group.

#### 23.2.4.1 *Profiles That Address Object Group Members*

When using profiles that address members of an object group, the object group reference for a server object group contains one **TAG\_INTERNET\_IOP** profile for each member of that group. Each profile contains a member reference that can be used to reach an individual member of the object group.

#### 23.2.4.2 *Profiles That Address Gateways*

When using profiles that address gateways, the object group reference for a server object group contains one **TAG\_INTERNET\_IOP** profile for each of several alternative gateways to that group. Each profile contains a reference to a gateway that can forward messages to all members of the server object group possibly using a proprietary multicast group communication protocol. The group communication protocol may be used for server object groups that support any of the Replication Styles.

#### 23.2.4.3 *Choice of Profile Addressing Mode*

For a server object group having the **STATELESS**, **COLD\_PASSIVE**, or **WARM\_PASSIVE** Replication Styles (Section 23.3, “Replication Management,” on page 23-31), the Fault Tolerance Infrastructure at the server may create either an object group reference that contains member profiles, or alternatively, an object group reference that contains gateway profiles.

For a server object group having the **ACTIVE** and **ACTIVE\_WITH\_VOTING** (Section 23.3.2, “Fault Tolerance Properties,” on page 23-32) Replication Styles, the client must invoke all of the members of the server object group simultaneously so that the members are treated as, and behave as, peers in executing the methods invoked on the object group. Therefore, for the **ACTIVE** and **ACTIVE\_WITH\_VOTING** Replication Styles, the Fault Tolerance Infrastructure at the server can create an object group reference that contains profiles for gateways that multicast the request to all of the members of the object group.

### 23.2.5 *Accessing Server Object Groups*

The interoperable object group references permit alternative implementation strategies for connecting a client to a server object group. This section illustrates some of these strategies:

- Access via IIOP directly to a member of a server object group.
- Access via IIOP and a gateway.
- Access via a proprietary multicast group communication protocol.

The first of these three options, access directly to a member of a server object group, requires the use of the **LOCATION\_FORWARD\_PERM** exception. As object replicas fail and are replaced by new replicas, a stage may be reached at which all of the original replicas, cited in the original interoperable object group reference for the object, are inaccessible. Continued use of the original reference will cause system failure. The **LOCATION\_FORWARD\_PERM** exception allows such a reference to be replaced by an updated reference that contains profiles for the new replacement replicas. Thus, the **LOCATION\_FORWARD\_PERM** exception is not deprecated when it is used to return an interoperable object group reference. The use of the **LOCATION\_FORWARD\_PERM** exception to return a reference that is not an interoperable object group reference continues to be deprecated.

#### 23.2.5.1 *Access via IIOP Directly to the Primary Member*

This strategy may be used to provide access to a fault-tolerant server (server object group) by an unreplicated client or by a client supported by a Fault Tolerance Infrastructure from a vendor different from the vendor that provided the Fault Tolerance Infrastructure for the server. Because the access is directly to the primary member, this strategy may be used only if the server object group has the **STATELESS**, **COLD\_PASSIVE**, or **WARM\_PASSIVE** Replication Style.

The client ORB extracts an IIOP profile from the object group reference, preferably the profile containing the **TAG\_FT\_PRIMARY** component, and establishes a connection to the endpoint addressed by that profile. If the addressed endpoint is the primary member of the object group, it accepts the connection and processes the request. Otherwise, it replies with a **LOCATION\_FORWARD\_PERM** that provides the current object group reference, one profile of which (the one with the **TAG\_FT\_PRIMARY** component) contains a profile that addresses the current primary.

#### 23.2.5.2 *Access via IIOP and a Gateway*

This strategy may be used to provide access to a fault-tolerant server (server object group) by an unreplicated client hosted by a non-fault-tolerant ORB and by a client supported by a Fault Tolerance Infrastructure from a vendor different from the vendor that provided the Fault Tolerance Infrastructure for the server.

The client ORB extracts an IIOP profile from the object group reference and uses that reference to establish a connection to the endpoint addressed by that profile. If that endpoint is a gateway, it accepts the connection and forwards messages to the members of the object group, typically using a (proprietary) multicast group communication protocol.

The client ORB and the client application object must be unaware of whether the interoperable object group reference addressed a gateway or the primary member.

#### 23.2.5.3 *Access via a Multicast Group Communication Protocol*

Some vendors may choose to use a proprietary multicast group communication protocol within a fault tolerance domain, or even between fault tolerance domains supported by a Fault Tolerance Infrastructure from the same vendor.

The fault tolerance domain identifier and object group identifier contained in the **TAG\_FT\_GROUP** component of the profiles of the object group reference could be used to establish a connection using the proprietary multicast group communication protocol. The details of connection establishment, and recovery from faults during connection establishment, for the multicast group communication protocol are not defined in this specification.

The use of a proprietary multicast group communication protocol must, however, be invisible to both the client application object and the server application object.

### 23.2.6 Extensions to CORBA Failover Semantics

The failover semantics for Fault Tolerant CORBA extend the failover semantics for the CORBA core, and are summarized in Table 23-1 on page 23-22. Note that the Fault Tolerant CORBA failover semantics permit reinvocation of requests even when a prior invocation yielded **COMPLETED\_MAYBE**, whereas the CORBA failover semantics permit reinvocation only if all prior attempts yielded **COMPLETED\_NO**. The permissible failover behaviors are determined by whether the IOR contains the **TAG\_FT\_GROUP** component (defined in Section 23.2.2.1, “TAG\_FT\_GROUP Component,” on page 23-14) and whether the client ORB includes an **FT\_REQUEST** service context (defined in Section 23.2.8.1, “FT\_REQUEST Service Context,” on page 23-24) in its request, as well as by the completion status returned and by the exception raised.

The temporal scope of the replacement reference provided by **LOCATION\_FORWARD\_PERM** is ORB lifetime or the next **LOCATION\_FORWARD\_PERM**. It is safe, and appropriate, for an ORB to replace any reference that contains the same fault tolerance domain identifier, the same object group identifier, and a smaller value of the version of the object group reference.

If a client tries to establish a connection to an endpoint that cannot handle the request, the client ORB might receive a reply containing a **LOCATION\_FORWARD\_PERM** response, which provides the most recent object group reference for the group (as described in Section 23.2.7, “Most Recent Object Group Reference,” on page 23-22), or it might receive a **SYSTEM\_EXCEPTION**.

Each time a client ORB attempts to establish a connection, it must not abandon the attempt and raise an exception to the client application until it has tried to invoke the server using all of the alternative IIOP addresses in the IOR, and has failed to establish a connection within the **request\_duration\_policy\_value** (defined in Section 23.2.8.2, “Request Duration Policy,” on page 23-26). It must then return a **SYSTEM\_EXCEPTION** to the client application. Alternative addresses include all of the host/port pairs in all of the **TAG\_INTERNET\_IOP** profiles within the interoperable object group reference, and all of the **TAG\_ALTERNATE\_IOP\_ADDRESS** components.

Each time a client ORB attempts to invoke a method, it must not abandon the invocation and raise an exception to the client application until it has tried to invoke the server using all of the alternative IIOP addresses in the interoperable object group reference, or has received a “non-failover” condition, or the request duration has expired.

No order is prescribed for the use of the addresses present in an interoperable object group reference (including the **TAG\_ALTERNATE\_IOP\_ADDRESS**). If a failover condition arises, an ORB may retry with the same address, or may immediately retry with other addresses - this is a quality of implementation issue.

This behavior specifies the minimum failover semantics that an ORB must implement. An ORB may also retry in other conditions not stated above, but this is not mandated. Under all failover conditions, at most once semantics must be guaranteed.

Table 23-1 Permitted Failover Conditions without and with Transparent Reinvocation

|                                  | <b>Completion Status</b>        | <b>CORBA Exception</b>                                  |
|----------------------------------|---------------------------------|---------------------------------------------------------|
| Without Transparent Reinvocation | COMPLETED_NO                    | COMM_FAILURE<br>TRANSIENT<br>NO_RESPONSE<br>OBJ_ADAPTER |
| With Transparent Reinvocation    | COMPLETED_NO<br>COMPLETED_MAYBE | COMM_FAILURE<br>TRANSIENT<br>NO_RESPONSE<br>OBJ_ADAPTER |

### 23.2.7 Most Recent Object Group Reference

This section defines a mechanism that allows the server to determine whether the client is using the most recent object group reference for the server object group when the client issues a request. The mechanism consists of an **FT\_GROUP\_VERSION** service context that a client may include in its request messages.

#### 23.2.7.1 FT\_GROUP\_VERSION Service Context

The **FTGroupVersionServiceContext** struct contains the version of the object group reference for the server object group, which allows the server to determine whether the client is using an obsolete object group reference. When encoded in a request or reply message header, the **context\_data** component of the **ServiceContext** struct shall contain a CDR encapsulation of the **FTGroupVersionServiceContext** struct, which is defined below.

```

module IOP {
 const Serviced FT_GROUP_VERSION = 12;
};

module FT {
 struct FTGroupVersionServiceContext { //context_id = FT_GROUP_VERSION;
 ObjectGroupRefVersion object_group_ref_version;
 };
};

```

If the server determines that the client is using an obsolete object group reference, the server returns a **LOCATION\_FORWARD\_PERM** response that contains the most recent object group reference for the server object group.

```
const Serviced FT_GROUP_VERSION = 12;
```

A constant that designates the **FT\_GROUP\_VERSION** service context.



```

struct FTGroupVersionServiceContext{ //context_id = FT_GROUP_VERSION;
 ObjectGroupRefVersion object_group_ref_version;
};

```

A structure that contains the same **object\_group\_ref\_version** that is in the **TAG\_FT\_GROUP** component of each of the **TAG\_INTERNET\_IOP** profiles of the object group reference for the server object group, which allows the server ORB to determine whether the object group reference being used by the client is obsolete.

When the Replication Manager generates a new object group reference for the server object group, because the membership of the server object group has changed, it updates the **object\_group\_ref\_version** in the reference for the new membership.

If the highest **object\_group\_ref\_version** known to the server ORB is greater than that contained in the request from the client, the server ORB must return a **LOCATION\_FORWARD\_PERM** response to the client containing the most recent reference for the server object group.

If the **object\_group\_ref\_version** known to the server ORB is equal to that contained in the request from the client and the server ORB supports the primary member of the server object group, the server ORB invokes the member to process the request. If the **object\_group\_ref\_version** known to the server ORB is equal to that contained in the request from the client and the server ORB supports a backup member, the server ORB returns a **TRANSIENT** exception with completion status **COMPLETION\_NO** to the client ORB. The client ORB can then reinvoke the request using another profile from the object group reference.

If the most recent **object\_group\_ref\_version** known to the server ORB is less than that contained in the request from the client, the server ORB must obtain the current reference for the server object group. If the **object\_group\_ref\_version** in the object group reference returned by the Replication Manager is greater than that contained in the request from the client, the server ORB must return a **LOCATION\_FORWARD\_PERM** response to the client containing the most recent reference for the server object group. If the **object\_group\_ref\_version** in the object group reference returned by the Replication Manager is less than that contained in the request from the client, the server ORB returns an **INV\_OBJREF** exception to the client.

### 23.2.8 *Transparent Reinvocation*

This section defines mechanisms that provide transparent reinvocation of methods contained in request messages. The mechanisms handle failure of the primary member of a server object group that has the **COLD\_PASSIVE** or **WARM\_PASSIVE** Replication Styles and provide redirection of the client's outstanding request to a backup server. In the absence of such mechanisms, the failure of the primary server could cause a client's request to be executed two (or more) times, once by the original primary and once by a backup that became the new primary, without the client or the server being aware of the repetition, possibly producing erroneous results.

These specifications do not change the current at-most-once invocation semantics of the CORBA object model. At the level of the application, a client makes a request once only and that request is executed at most once. At the transport level, however, a fault-tolerant client ORB can transparently retransmit a request message to a fault-tolerant server, to mask faults including both object and link faults, thus providing higher reliability. Transparent reinvocation is permitted only under the completion status and system exception conditions listed in Table 23-1 on page 23-22, and provided that both the IOP profile used for the existing request and the IOP profile used for the reinvocation contain a **TAG\_FT\_GROUP** component. Both the existing request message and the reinvocation request message must contain an **FT\_REQUEST** service context. Neither the client application nor the server application is aware of such retransmissions. The server application executes the request at most once with no special application programming to handle repeated requests, and the client application receives its reply with no special application programming to handle exceptions. (For replicated clients communicating with replicated servers, use of a multicast group communication protocol may be appropriate because such a protocol provides stronger acknowledgment and retransmission mechanisms.)

The mechanisms defined here consist of the **FT\_REQUEST** service context, which a client may include in its request messages, and the Request Duration Policy.

#### 23.2.8.1 *FT\_REQUEST Service Context*

The **FTRequestServiceContext** is used to ensure that a request is not executed more than once under fault conditions. When encoded in a request or reply message header, the **context\_data** component of the **ServiceContext** struct shall contain a CDR encapsulation of the **FTRequestServiceContext** struct, which is defined below.

```

module IOP {
 const Servid FT_REQUEST = 13;
};

module FT {
 struct FTRequestServiceContext { // context_id = FT_REQUEST;
 string client_id;
 long retention_id;
 TimeBase::TimeT expiration_time;
 };
};

```

The **FT\_REQUEST** service context contains a unique **client\_id** for the client, a **retention\_id** for the request, and an **expiration\_time** for the request. The **client\_id** and **retention\_id** serve as a unique identifier for the client's request and allow the server ORB to recognize that the request is a repetition of a previous request. If the request is a repetition of a previous request that the server has already executed, the server (which may be a new primary) does not re-execute the request but rather returns the reply that was generated by the prior execution (possibly by a previous primary that failed). The **expiration\_time** serves as a garbage collection mechanism. It provides a lower bound on the time until which the server must honor the request and, therefore, retain the request and corresponding reply (if any) in its log.

```
const ServiceId FT_REQUEST = 13;
```

A constant that designates the **FT\_REQUEST** service context.

```
struct FTRequestServiceContext { // context_id = FT_REQUEST;
 string client_id;
 long retention_id;
 TimeBase::TimeT expiration_time;
};
```

A structure that contains the client identifier, retention identifier, and the expiration time of the request. Each repetition of a request must carry the same **client\_id**, **retention\_id**, and **expiration\_time** as the original request. These fields are defined as follows:

- The **client\_id** uniquely identifies the client, so that repeated requests from the same client can be recognized. No mechanisms are defined for generating this unique identifier.
- The **retention\_id** uniquely identifies the request within the scope of the client and the **expiration\_time**. The client ORB can reuse the **retention\_id** provided that it guarantees uniqueness.
- The **expiration\_time** defines a lower bound on the time when the request will expire. Typically, the **expiration\_time** is obtained by adding the **request\_duration\_policy\_value** defined by the Request Duration Policy, to the local clock value of the client ORB.

If a server is unable to support the **expiration\_time**, it may throw an **INVALID\_POLICY** exception. Otherwise, the server must retain each request and its reply until the time (at the server) defined by the **expiration\_time**. Until that time, the server must recognize requests that are repetitions of requests that have already been executed, and must return the reply to the original request rather than reinvoking the method. After that time, the server must return either the reply to the original request or a **BAD\_CONTEXT** exception, but all replicas of the server must make the same decision about which reply to return so that the client receives only one reply.

The client ORB that has issued the request may reissue the request to the same or a different member of the server object group, but must use the **FT\_REQUEST** service context with the **same retention\_id** and same **expiration\_time** as it used in its original request.

Before the server returns the reply for a request to the client, the Fault Tolerance Infrastructure must log the request and the reply. A backup that has become the new primary must not reply to the client until its state has been updated to include replies generated by other members of the object group, using the messages in the log.

Both the establishment of connections and the retention of requests are bounded by the **expiration\_time**, or the client ORB's current clock value plus the **request\_duration\_policy\_value** if no **expiration\_time** has been established. If a current connection fails, a new connection may be needed so that the request can be

retransmitted to an alternative member of the server object group. The establishment of the new connection must be bounded by the **expiration\_time** determined for the prior request.

### 23.2.8.2 *Request Duration Policy*

The Request Duration Policy determines how long a request, and the corresponding reply, should be retained by a server to handle reinvocation of the request under fault conditions.

```
module FT {
 const CORBA::PolicyType REQUEST_DURATION_POLICY = 47;

 interface RequestDurationPolicy : CORBA::Policy {
 readonly attribute TimeBase::TimeT request_duration_policy_value;
 };
};
```

The Request Duration Policy, applied at the client, defines the time interval over which a client's request to a server remains valid and must be retained by the server ORB to detect repeated requests.

The policy is defined by:

```
const CORBA::PolicyType REQUEST_DURATION_POLICY = 47;
```

A constant that designates the **REQUEST\_DURATION\_POLICY**.

```
interface RequestDurationPolicy : CORBA::Policy {
 readonly attribute TimeBase::TimeT request_duration_policy_value;
};
```

The **request\_duration\_policy\_value** is added to the client ORB's current clock value to obtain the **expiration\_time** that is included in the **FT\_REQUEST** service context for the request.

### 23.2.8.3 *Fault Handling for GIOP Messages*

The standard semantics of GIOP messages include definitions of fault conditions for messages of different types, and provisions for handling of faults by the ORBs. Fault Tolerant CORBA does not modify those semantics in normal (fault-free) conditions. For some types of GIOP messages, an ORB may attempt to retransmit the message or transmit the message to alternative destinations or over alternative transports. Such attempts are invisible to the client and server application and are bounded in time by the **request\_duration\_policy\_value** defined for the client by the Request Duration Policy. We discuss below those GIOP messages for which fault handling is modified.

### *LocateRequest*

If a client ORB loses an IIOP connection with a server while issuing a **LocateRequest**, or before receiving a corresponding **LocateReply**, or if it does not receive a **LocateReply** in a timely manner, then the client ORB may attempt to retransmit the message or to transmit the message to alternative destinations or over alternative transports. If the client ORB is unable to obtain a reply within the **request\_duration\_policy\_value** of the Request Duration Policy, the client ORB must return a **COMM\_FAILURE** system exception to the client application. It may return a **COMM\_FAILURE** system exception before the end of that duration.

### *Request*

If a client ORB loses the connection with a server or incurs some other kind of transport fault, the ORB may attempt to retransmit the request message, or retransmit the request message to an alternative destination or using an alternative transport, up to the **expiration\_time**.

If a client invokes a fault-tolerant server (as indicated by the presence of the **TAG\_FT\_GROUP** component in the **TAG\_INTERNET\_IOP** profiles of the server's object group reference), the client ORB may retransmit a request if it would have otherwise returned a **COMM\_FAILURE**, **TRANSIENT**, **NO\_RESPONSE**, or **OBJ\_ADAPTER** exception with a **COMPLETED\_NO** or **COMPLETED\_MAYBE** completion status to the client application. The client is protected against repeated execution by the inclusion of an **FT\_REQUEST** service context in the request message, as described in Section 23.2.8.1, "FT\_REQUEST Service Context," on page 23-24.

If a client invokes a non-fault-tolerant server (as indicated by the absence of a **TAG\_FT\_GROUP** component in the **TAG\_INTERNET\_IOP** profiles of its reference), the client ORB may retransmit the request only if it would have otherwise returned a **COMM\_FAILURE**, **TRANSIENT**, **NO\_RESPONSE**, or **OBJ\_ADAPTER** exception with a **COMPLETED\_NO** completion status to the client application.

### *LocateReply and Reply*

Retransmission of a **LocateReply** or **Reply** message may occur either because the server ORB has not received a transport-level acknowledgment for a previous transmission or because the server ORB has received a repetition of a previous **LocateRequest** or **Request** message.

### *Fragment*

Fragmented **Request** and **Reply** messages are handled like unfragmented **Request** and **Reply** messages.

## 23.2.9 *Transport Heartbeats*

With IIOP (TCP/IP), a problem can arise when a client invokes a method on a server, the host on which the server resides fails or the link fails, and the client ORB does not detect the TCP/IP problem and receives no reply. Typically, this problem is solved by

using round-trip timeouts in the client application. Setting a timeout at the application level for each request is laborious, even if one knew approximately how long a particular method will take. An alternative solution proposed here is to send another request message on the same connection that takes a known (short) time to execute; that is, a kind of no op.

This section therefore defines a new **TAG\_FT\_HEARTBEAT\_ENABLED** component of the **TAG\_INTERNET\_IOP** profile, and adds two new policies: **Heartbeat** and **HeartbeatEnabled**.

### 23.2.9.1 *TAG\_FT\_HEARTBEAT\_ENABLED Component*

The **TAG\_FT\_HEARTBEAT\_ENABLED** component in a **TAG\_INTERNET\_IOP** profile indicates that the addressed endpoint supports heartbeating.

```
module IOP {
 const ComponentId TAG_FT_HEARTBEAT_ENABLED = 29;
};

module FT {
 struct TagFTHeartbeatEnabledTaggedComponent {
 // tag =TAG_FT_HEARTBEAT_ENABLED
 boolean heartbeat_enabled;
 };
};
```

The **TAG\_FT\_HEARTBEAT\_ENABLED** component contains only a boolean.

```
const ComponentId TAG_FT_HEARTBEAT_ENABLED = 29;
```

A constant that designates the **TAG\_FT\_HEARTBEAT\_ENABLED** component that is contained in a **TAG\_INTERNET\_IOP** profile.

```
struct TagFTHeartbeatEnabledTaggedComponent {
 // tag =TAG_FT_HEARTBEAT_ENABLED
 boolean heartbeat_enabled;
};
```

The **TAG\_FT\_HEARTBEAT\_ENABLED** component may be included in a **TAG\_INTERNET\_IOP** profile to indicate that the endpoint is **heartbeat\_enabled**.

### 23.2.9.2 *Heartbeat Policy*

The Heartbeat Policy, applied at the client, allows the client to request heartbeating of its connections to servers, using the **heartbeat\_interval** and **heartbeat\_timeout**.

```
module FT {
 const CORBA::PolicyType HEARTBEAT_POLICY = 48;

 struct HeartbeatPolicyValue {
```

```

 boolean heartbeat;
 TimeBase::TimeT heartbeat_interval;
 TimeBase::TimeT heartbeat_timeout;
 };

 interface HeartbeatPolicy : CORBA::Policy {
 readonly attribute HeartbeatPolicyValue heartbeat_policy_value;
 };
};

```

When the Heartbeat Policy is applied at a client ORB, the ORB is responsible for taking the following steps. While a connection exists to a remote server, the ORB sends a request message over the connection at least as often as was requested by the **heartbeat\_interval** of the Heartbeat Policy of any client connected to a server over that connection. The request message is equivalent to an invocation of the method:

```
void FT_HB ();
```

on any one of the server objects accessed by the connection. The **FT\_HB()** operation name is reserved in CORBA for this purpose, and IDL compilers use the standard escape techniques if IDL specifications contain operations with this name.

If the corresponding reply message does not arrive at the client ORB within the **heartbeat\_timeout** of the Heartbeat Policy of a client connected to a server over that connection, the ORB closes the connection for that client. The connection may remain open for other clients whose Heartbeat Policy define a larger value for the **heartbeat\_timeout**.

The policy is defined by:

```
const CORBA::PolicyType HEARTBEAT_POLICY = 48;
```

A constant that designates the Heartbeat Policy for the client.

```

struct HeartbeatPolicyValue {
 boolean heartbeat;
 TimeBase::TimeT heartbeat_interval;
 TimeBase::TimeT heartbeat_timeout;
};

```

The **HeartbeatPolicyValue** consists of a boolean that indicates whether the client ORB supports heartbeating, a **heartbeat\_interval** that determines the frequency with which the client ORB pings the server, and a **heartbeat\_timeout** that indicates the time by which the client ORB must receive a reply from the server before it closes the connection. Both the **heartbeat\_interval** and the **heartbeat\_timeout** use the standard **TimeBase::TimeT** representation, which uses a unit of 100 nanoseconds.

```

interface HeartbeatPolicy : CORBA::Policy {
 readonly attribute HeartbeatPolicyValue heartbeat_policy_value;
};

```

A server ORB must respond to requests that contain the **FT\_HB()** operation by immediately sending a reply message. The contents of the reply message are not defined. The request id of the reply message must match the **request\_id** of the request message.

A server ORB must not involve POAs or servants on receipt or reply of the **FT\_HB()** message.

### 23.2.9.3 Heartbeat Enabled Policy

Because heartbeating can generate significant network traffic, and can use significant server resources, the heartbeating capability is explicitly enabled or disabled using the Heartbeat Enabled Policy.

```
module FT {
 const CORBA::PolicyType HEARTBEAT_ENABLED_POLICY = 49;

 interface HeartbeatEnabledPolicy : Policy {
 readonly attribute boolean heartbeat_enabled_policy_value;
 };
};
```

The Heartbeat Enabled Policy allows the heartbeating of a server endpoint. If the Heartbeat Enabled Policy is enabled for a server endpoint, the **TAG\_INTERNET\_IOP** profile for that endpoint contains the **TAG\_FT\_HEARTBEAT\_ENABLED** component to indicate to the client that the server endpoint is **heartbeat\_enabled**.

The policy is defined by:

```
const PolicyType HEARTBEAT_ENABLED_POLICY = 49;
```

A constant that designates the Heartbeat Enabled Policy for the server.

```
interface HeartbeatEnabledPolicy : CORBA::Policy
 readonly attribute boolean heartbeat_enabled_policy_value;
};
```

The **heartbeat\_enabled\_policy\_value** determines whether the server endpoint supports heartbeats.

If a client attempts to apply the Heartbeat Policy to a server for which the Heartbeat Enabled Policy is not enabled; that is, **heartbeat\_enabled\_policy\_value** is false, then an **INVALID\_POLICIES** exception is thrown. The Heartbeat Enabled Policy can be checked using **validate\_policies()**.



## 23.3 Replication Management

### 23.3.1 Overview

The Replication Manager is an important component of the Fault Tolerance Infrastructure that interacts with other components of the infrastructure. Typically, the Replication Manager is replicated for fault tolerance, though not necessarily on every host within the fault tolerance domain; however, logically, there is a single Replication Manager for each fault tolerance domain.

The Replication Manager inherits three application program interfaces: **PropertyManager**, **GenericFactory**, and **ObjectGroupManager**.

The **PropertyManager** interface allows properties of the object groups to be set, such as the **ReplicationStyle**, **MembershipStyle**, **ConsistencyStyle**, **InitialNumberReplicas**, **MinimumNumberReplicas**, etc. These properties may be set statically as defaults for the fault tolerance domain or for a particular type, or may be set or changed dynamically while the application is executing.

The **GenericFactory** interface is used by the application to create object groups, as shown in Figure 23-4 on page 23-32. It is also used by the Replication Manager to create individual members of an object group.

For the infrastructure-controlled Membership Style, the Replication Manager invokes the individual factories, for the appropriate locations, to create the members of the object group, both initially to satisfy the **InitialNumberReplicas** property, and after the loss of a member because of a fault to satisfy the **MinimumNumberReplicas** property. The Replication Manager adds the members to the object group and creates the object group reference. Subsequently, the Replication Manager removes members, if necessary.

For the application-controlled Membership Style, the **ObjectGroupManager** interface allows the application to create a member of an object group, to add an existing object to an object group, or to remove a member from an object group, citing the location of the member to be created, added, or removed. It also allows the application to define the primary member of an object group and to query the locations of the members of an object group and the primary member.

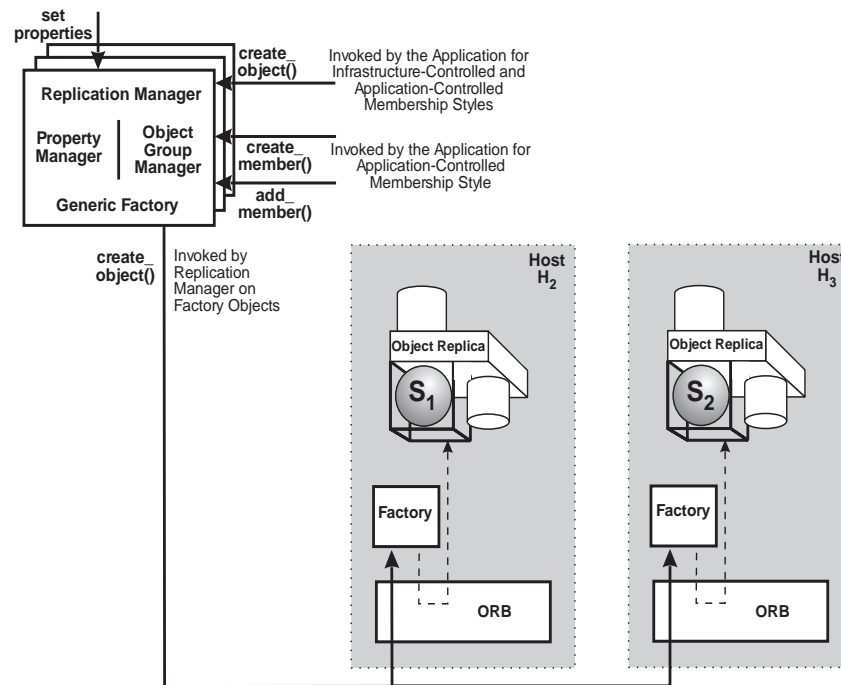

Figure 23-4 The Replication Manager and the Creation of an Object Group

### 23.3.2 Fault Tolerance Properties

Each object group has an associated set of properties that are set as defaults for the fault tolerance domain, that are set for the type of the object, that are set when the object group is created, or that are set subsequently while the application executes. The names and values of the specified properties are given below. Vendor implementations may define additional properties and may extend the property values.

#### 23.3.2.1 ReplicationStyle

|       |                                                                                               |
|-------|-----------------------------------------------------------------------------------------------|
| Name  | org.omg.ft.ReplicationStyle                                                                   |
| Value | FT::STATELESS<br>FT::COLD_PASSIVE<br>FT::WARM_PASSIVE<br>FT::ACTIVE<br>FT::ACTIVE_WITH_VOTING |

For the STATELESS Replication Style, the behavior of the object group is unaffected by its history of invocations. A typical example is a server that provides read-only access to a database.

For the `COLD_PASSIVE` or `WARM_PASSIVE` Replication Styles, only a single member, the primary member, executes the methods that have been invoked on the object group. The object group contains additional backup members for recovery after a fault.

For the `COLD_PASSIVE` Replication Style, the state of the primary is extracted from a log and loaded into a backup member when needed for recovery.

For the `WARM_PASSIVE` Replication Style, the state of the primary member is loaded into one or more backup members periodically during normal operation.

For the `ACTIVE` Replication Style, all of the members of the object group independently execute the methods invoked on the object, so that if a fault prevents one member from operating correctly, the other members will produce the required replies without the delay required for recovery. Duplicate requests and duplicate replies, generated by multiple members of the object group, are detected and suppressed. The `ACTIVE` Replication Style typically requires the use of a multicast group communication system that provides reliable totally-ordered message delivery and group membership services in a model of virtual synchrony (see the *Glossary*).

For a source object group that has the **`ACTIVE_WITH_VOTING`** Replication Style, the requests (replies) from the members of the source object group are voted, and are delivered to the members of the destination object group only if a majority of the requests (replies) are identical (match exactly). A vote on a specific request or reply must be performed using the same voting membership at each host where that vote is performed. This Replication Style requires protection against commission faults both in the objects and in the network infrastructure. The **`ACTIVE_WITH_VOTING`** Replication Style is not supported in the current specification, but is an anticipated extension. It should be understood that voting itself is computationally inexpensive but that the communication required to support voting properly is substantially more expensive than that required to tolerate only crash faults.

### 23.3.2.2 *MembershipStyle*

|       |                                        |
|-------|----------------------------------------|
| Name  | org.omg.ft.MembershipStyle             |
| Value | FT::MEMB_APP_CTRL<br>FT::MEMB_INF_CTRL |

If the value of the **`MembershipStyle`** is **`MEMB_APP_CTRL`**, the application may create an object itself and then invoke the **`add_member()`** operation of the **`ObjectGroupManager`** interface to cause the Replication Manager to add the object to the object group. Alternatively, the application may invoke the **`create_member()`** operation of the **`ObjectGroupManager`** interface to cause the Replication Manager to create the member and add it to the object group. The application is responsible for enforcing the **`InitialNumberReplicas`** and **`MinimumNumberReplicas`** properties. The Replication Manager initiates monitoring of the members for faults, according to the **`FaultMonitoringStyle`**, and registers with the Fault Notifier to receive notifications of faults. Likewise, the application may register for fault notifications for the members of the object group.

At most one member of an object group can exist at a given location. Therefore, if the application attempts to create or add a second member to an object group at the given location, a `MemberAlreadyPresent` exception is raised.

If the value of the `MembershipStyle` is `MEMB_INF_CTRL`, the Replication Manager invokes the individual factories, for the appropriate locations, to create the members of the object group, both initially to satisfy the `InitialNumberReplicas` property, and after the loss of a member because of a fault to satisfy the `MinimumNumberReplicas` property. The Replication Manager initiates monitoring of the members for faults, according to the `FaultMonitoringStyle`, and registers with the Fault Notifier to receive notifications of faults.

### 23.3.2.3 *ConsistencyStyle*

|       |                                        |
|-------|----------------------------------------|
| Name  | org.omg.ft.ConsistencyStyle            |
| Value | FT::CONS_APP_CTRL<br>FT::CONS_INF_CTRL |

If the value of the `ConsistencyStyle` is `CONS_APP_CTRL`, the application is responsible for checkpointing, logging, activation and recovery, and for maintaining whatever kind of consistency is appropriate for the application.

If the value of the `ConsistencyStyle` is `CONS_INF_CTRL`, the Fault Tolerance Infrastructure is responsible for checkpointing, logging, activation and recovery, and for maintaining Strong Replica Consistency, Strong Membership Consistency, and Uniqueness of the Primary for the `COLD_PASSIVE` and `WARM_PASSIVE` Replication Styles. The `CONS_INF_CTRL` Consistency Style requires the object to inherit the `Checkpointable` interface.

For the `COLD_PASSIVE` and `WARM_PASSIVE` Replication Styles, Strong Replica Consistency requires that, at the end of each state transfer, each of the members of an object group has, or has access to, the same state and the same requests the primary replica had, or had not, processed when it created that state. It requires that requests and replies are not lost in the event of a fault and that duplicate requests and duplicate replies, generated during recovery, are suppressed.

For the `ACTIVE` and `ACTIVE_WITH_VOTING` Replication Styles, Strong Replica Consistency requires that, at the end of each method invocation on the object group, the members of the object group have the same state, and that no requests or replies are lost or duplicated.

For the `ACTIVE`, `COLD_PASSIVE`, and `WARM_PASSIVE` Replication Styles, the behavior of each member of an object group must be deterministic and each member must start in the same state. If the same sequence of requests are then applied, in the same order, to each member of the group, Strong Replica Consistency will be maintained. Strong Replica Consistency simplifies the application programming, but requires strong mechanisms within the Fault Tolerance Infrastructure to do so. In particular, the `ACTIVE` and `ACTIVE_WITH_VOTING` Replication Styles, and perhaps

also the **WARM\_PASSIVE** Replication Style, typically employ a multicast group communication protocol that provides reliable totally-ordered delivery of messages and group membership services to maintain Strong Replica Consistency.

Strong Membership Consistency requires that, for each method invocation on an object group, the Fault Tolerance Infrastructures on all hosts have the same view of the membership of the object group. For the **COLD\_PASSIVE** and **WARM\_PASSIVE** Replication Styles, Uniqueness of the Primary requires that there is exactly one primary member of the object group at each logical point in time.

#### 23.3.2.4 *FaultMonitoringStyle*

|       |                                           |
|-------|-------------------------------------------|
| Name  | org.omg.ft.FaultMonitoringStyle           |
| Value | FT::PULL<br>FT::PUSH<br>FT::NOT_MONITORED |

For the **PULL FaultMonitoringStyle**, the Fault Monitor interrogates the monitored object periodically to determine whether it is alive. The **PULL FaultMonitoringStyle** requires that the object inherits the **PullMonitorable** interface.

For the **PUSH FaultMonitoringStyle**, the monitored object periodically reports to the fault monitor to indicate that it is alive. The **PUSH FaultMonitoringStyle** is not supported in the current specification, but is an anticipated extension.

#### 23.3.2.5 *FaultMonitoringGranularity*

|       |                                            |
|-------|--------------------------------------------|
| Name  | org.omg.ft.FaultMonitoringGranularityStyle |
| Value | FT::MEMB<br>FT::LOC<br>FT::LOC_AND_TYPE    |

For the **MEMB FaultMonitoringGranularity**, each individual member of this object group is monitored. This is the default.

For the **LOC FaultMonitoringGranularity** and for a member of this object group at a particular location, if no other object at that location is already being monitored, then the member of this object group at that location is monitored. This member acts as a “fault monitoring representative” for the members of the other objects groups at that location. If another object at that location is already being monitored, then that object acts as the “fault monitoring representative” for the member of this object group at that location. If the “fault monitoring representative” at a particular location ceases to exist due to a fault, then the Replication Manager regards all objects at that location to have failed and performs recovery for all objects at that location. If the “fault monitoring representative” ceases to exist because the member was removed from the group but had not actually failed, then the Replication Manager selects another object at that location as the “fault monitoring representative.”

For the **LOC\_AND\_TYPE FaultMonitoringGranularity** and for a member of this object group at a particular location, if no other object of the same type at that location is already being monitored, then the member of this object group at that location is monitored. This member acts as a “fault monitoring representative” for the members of the other object groups of the same type at that location. If another object of the same type at that location is already being monitored, then that object acts as the “fault monitoring representative” for the member of this object group at that location. If the “fault monitoring representative” at a particular location for a particular type ceases to exist due to a fault, then the Replication Manager regards all objects at that location of that type to have failed and performs recovery for all objects of that type at that location. If the “fault monitoring representative” ceases to exist because the member was removed from the group but had not actually failed, then the Replication Manager selects another object at that location of that type as the “fault monitoring representative.”

#### 23.3.2.6 *Factories*

|       |                      |
|-------|----------------------|
| Name  | org.omg.ft.Factories |
| Value | FactoryInfos         |

A factory is an object, the purpose of which is to create other objects. **FactoryInfos** is a sequence of **FactoryInfo**, where **FactoryInfo** contains the reference to the factory, the location at which the factory is to create a member of the object group and criteria that the factory is to use to create the member.

#### 23.3.2.7 *InitialNumberReplicas*

|       |                                  |
|-------|----------------------------------|
| Name  | org.omg.ft.InitialNumberReplicas |
| Value | An unsigned short                |

The number of replicas of an object to be created initially.

#### 23.3.2.8 *MinimumNumberReplicas*

|       |                                  |
|-------|----------------------------------|
| Name  | org.omg.ft.MinimumNumberReplicas |
| Value | An unsigned short                |

The smallest number of replicas of an object needed to maintain the desired fault tolerance.

### 23.3.3 *FaultMonitoringIntervalAndTimeout*

|       |                                              |
|-------|----------------------------------------------|
| Name  | org.omg.ft.FaultMonitoringIntervalAndTimeout |
| Value | TimeBase::TimeT<br>TimeBase::TimeT           |

The value is a struct that contains the interval of time between successive pings of an object, and the time allowed for subsequent responses from the object to determine whether it is faulty. **TimeBase::TimeT** is a long long, and the value is in units of 100 nanoseconds. **FaultMonitoringInterval** requires that the object inherits the **PullMonitorable** interface.

### 23.3.4 *CheckpointInterval*

|       |                               |
|-------|-------------------------------|
| Name  | org.omg.ft.CheckpointInterval |
| Value | TimeBase::TimeT               |

An interval of time between writing the full state of the object to the log. **TimeBase::TimeT** is a **long long**, and the value is in units of 100 nanoseconds. **CheckpointInterval** requires that the object inherits the **Checkpointable** interface.

Note that some of these properties are incompatible, such as the **STATELESS ReplicationStyle** and **CheckpointInterval** or the **CONS\_APP\_CTRL ConsistencyStyle** and **CheckpointInterval**.

Table 23-2 Fault Tolerance Properties and When They May Be Set

|                            | Default | Type | Creation | Dynamically |
|----------------------------|---------|------|----------|-------------|
| ReplicationStyle           | *       | *    | *        |             |
| MembershipStyle            | *       | *    | *        |             |
| ConsistencyStyle           | *       | *    |          |             |
| FaultMonitoringStyle       | *       | *    |          |             |
| FaultMonitoringGranularity | *       | *    | *        | *           |
| Factories                  |         | *    | *        | *           |
| InitialNumberReplicas      | *       | *    | *        |             |
| MinimumNumberReplicas      | *       | *    | *        | *           |
| FaultMonitoringInterval    | *       | *    | *        | *           |
| CheckpointInterval         | *       | *    | *        | *           |

Table 23-2 shows the Fault Tolerance Properties and when they may be set. Properties of object groups that are set as defaults apply to all object groups of all types within a fault tolerance domain. Properties of object groups that are set for a particular type apply to all object groups of that type within the fault tolerance domain, and override the properties that are set as defaults for that type. Properties of an object group that are set at creation time are set when the particular object group is created, and override the properties that are set as defaults or for the type of the object group. Properties of an object group that are set dynamically are set while the application is executing, and override the properties that are set as defaults or for the type of the object group or when the object group is created.

### 23.3.5 Common Types

```

module FT {
 interface GenericFactory;
 interface FaultNotifier;

 typedef CORBA::RepositoryId Typed;
 typedef Object ObjectGroup;

 typedef CosNaming::Name Name;
 typedef any Value;
 struct Property {
 Name nam;
 Value val;
 };
 typedef sequence<Property> Properties;

 typedef Name Location;
 typedef sequence<Location> Locations;
 typedef Properties Criteria;
 struct FactoryInfo {
 GenericFactory the_factory;
 Location the_location;
 Criteria the_criteria;
 };
 typedef sequence<FactoryInfo> FactoryInfos;

 typedef unsigned short ReplicationStyleValue;
 const ReplicationStyleValue STATELESS = 0;
 const ReplicationStyleValue COLD_PASSIVE = 1;
 const ReplicationStyleValue WARM_PASSIVE = 2;
 const ReplicationStyleValue ACTIVE = 3;
 const ReplicationStyleValue ACTIVE_WITH_VOTING = 4;

 typedef unsigned short MembershipStyleValue;
 const MembershipStyleValue MEMB_APP_CTRL = 0;
 const MembershipStyleValue MEMB_INF_CTRL = 1;

```



```

typedef unsigned short ConsistencyStyleValue;
const ConsistencyStyleValue CONS_APP_CTRL = 0;
const ConsistencyStyleValue CONS_INF_CTRL = 1;

typedef unsigned short FaultMonitoringStyleValue;
const FaultMonitoringStyleValue PULL = 0;
const FaultMonitoringStyleValue PUSH = 1;
const FaultMonitoringStyleValue NOT_MONITORED = 2;

typedef unsigned short FaultMonitoringGranularityValue;
const FaultMonitoringGranularityValue MEMB = 0;
const FaultMonitoringGranularityValue LOC = 1;
const FaultMonitoringGranularityValue LOC_AND_TYPE = 2;

typedef FactoryInfos FactoriesValue;

typedef unsigned short InitialNumberReplicasValue;
typedef unsigned short MinimumNumberReplicasValue;

struct FaultMonitoringIntervalAndTimeoutValue {
 TimeBase::TimeT monitoring_interval;
 TimeBase::TimeT timeout;
};

typedef TimeBase::TimeT CheckpointIntervalValue;
exception InterfaceNotFound {};
exception ObjectGroupNotFound {};
exception MemberNotFound {};
exception ObjectNotFound {};
exception MemberAlreadyPresent {};
exception BadReplicationStyle {};
exception ObjectNotCreated {};
exception ObjectNotAdded {};
exception PrimaryNotSet {};
exception UnsupportedProperty {
 Name nam;
 Value val;
};
exception InvalidProperty {
 Name nam;
 Value val;
};
exception NoFactory {
 Location the_location;
 TypedId type_id;
};
exception InvalidCriteria {
 Criteria invalid_criteria;
};
exception CannotMeetCriteria {
 Criteria unmet_criteria;
};

```

```
};
};
```

### 23.3.5.1 Identifiers

**typedef Object ObjectGroup;**

A reference to an object group.

**typedef CosNaming::Name Name;**

The name of a property

**typedef any Value;**

The value of a property.

```
struct Property {
 Name nam;
 Value val;
};
```

The name-value pair for a property. The name may be hierarchical.

**typedef sequence<Property> Properties;**

A sequence of properties.

**typedef Name Location;**

The name for a fault containment region, host, device, cluster of hosts, etc., which may be hierarchical. For example, the kind field of the name might be “HostIP” which defines a particular format for the address in the id field. The id field would then contain an IP address for a host. For each object group and each location, only one member of that object group may exist at that location.

**typedef sequence<Location> Locations;**

A sequence of locations of the members of an object group.

**typedef Properties Criteria;**

Criteria is a sequence of property; that is, name-value pair. Examples of criteria are initialization values, constraints on an object, preferred location of the object, and fault tolerance properties of an object group.

Two names are reserved for criteria: **org.omg.ft.ObjectLocation** and **org.omg.ft.FTProperties**. The **org.omg.ft.FTProperties** name tags a location value at which an object is to be created by a factory. The **org.omg.ft.FTProperties**

name tags a sequence of name-value pairs that represent fault tolerance properties for an object group. All other criteria are implementation-specific and are interpreted only by the factory.

```
struct FactoryInfo {
 GenericFactory the_factory;
 Location the_location;
 Criteria the_criteria;
};
```

A structure that contains the reference to a factory and the location and the criteria that the factory uses to create an object at the given location using the given criteria, such as initialization values, constraints on the object, etc.

```
typedef sequence<FactoryInfo> FactoryInfos;
```

A sequence of **FactoryInfos**.

```
typedef unsigned short ReplicationStyleValue;
 const ReplicationStyleValue STATELESS = 0;
 const ReplicationStyleValue COLD_PASSIVE = 1;
 const ReplicationStyleValue WARM_PASSIVE = 2;
 const ReplicationStyleValue ACTIVE = 3;
 const ReplicationStyleValue ACTIVE_WITH_VOTING = 4;
```

The values of the **ReplicationStyle** property.

```
typedef unsigned short MembershipStyleValue;
 const MembershipStyleValue MEMB_APP_CTRL = 0;
 const MembershipStyleValue MEMB_INF_CTRL = 1;
```

The values of the **MembershipStyle** property.

```
typedef unsigned short ConsistencyStyleValue;
 const ConsistencyStyleValue CONS_APP_CTRL = 0;
 const ConsistencyStyleValue CONS_INF_CTRL = 1;
```

The values of the **ConsistencyStyle** property.

```
typedef unsigned short FaultMonitoringStyleValue;
 const FaultMonitoringStyleValue PULL = 0;
 const FaultMonitoringStyleValue PUSH = 1;
 const FaultMonitoringStyleValue NOT_MONITORED = 2;
```

The values of the **FaultMonitoringStyle** property.

```
typedef unsigned short FaultMonitoringGranularityValue;
 const FaultMonitoringGranularityValue MEMB = 0;
 const FaultMonitoringGranularityValue LOC = 1;
 const FaultMonitoringGranularityValue LOC_AND_TYPE = 2;
```

The values of the **FaultMonitoringGranularity** property.

**typedef FactoryInfos FactoriesValue;**

The value of the **Factories** property.

**typedef unsigned short InitialNumberReplicasValue;**

The value of the **InitialNumberReplicas** property.

**typedef unsigned short MinimumNumberReplicasValue;**

The value of the **MinimumNumberReplicas** property.

```
struct FaultMonitoringIntervalAndTimeoutValue {
 TimeBase::TimeT monitoring_interval;
 TimeBase::TimeT timeout;
};
```

The value of the **FaultMonitoringIntervalAndTimeout** property. Each field is of type **TimeBase::TimeT**, which is a **long long**, and is in units of 100 nanoseconds.

**typedef TimeBase::TimeT CheckpointIntervalValue;**

The value of the **CheckpointInterval** property. **TimeBase::TimeT** is a **long long**, and the value is in units of 100 nanoseconds.

#### 23.3.5.2 *Exceptions*

**exception InterfaceNotFound {};**

The object with the given interface is not found by the Replication Manager.

**exception ObjectGroupNotFound {};**

The object group with the given identifier is not found by the Replication Manager.

**exception MemberNotFound {};**

No member of the object group exists at the given location.

**exception ObjectNotFound {};**

The object is not found by the Replication Manager.

**exception MemberAlreadyPresent {};**

A member of the object group already exists at the given location.

**exception BadReplicationStyle {};**

The **ReplicationStyle** of the object group is inappropriate.

```
exception ObjectNotCreated {};
```

The GenericFactory did not create the object.

```
exception ObjectNotAdded {};
```

The Replication Manager did not add the object to the object group.

```
exception PrimaryNotSet {};
```

The Replication Manager did not set the primary member of the object group.

```
exception UnsupportedProperty {
 Name nam;
 Value val;
};
```

A property named in the property sequence is not supported.

```
exception InvalidProperty {
 Name nam;
 Value val;
};
```

A property value in the property sequence is not valid either in itself (for example, because the number of replicas is negative) or because it conflicts with another property in the sequence or with other properties already in effect that are not overridden.

```
exception NoFactory {
 Location the_location;
 TypeId type_id;
};
```

The factory cannot create an object at the given location with the given repository identifier.

```
exception InvalidCriteria {
 Criteria invalid_criteria;
};
```

The factory does not understand the given criteria.

```
exception CannotMeetCriteria {
 Criteria unmet_criteria;
};
```

The factory understands the given criteria, but cannot satisfy the criteria.

### 23.3.6 Replication Manager

The Replication Manager inherits three application program interfaces: **PropertyManager**, **ObjectGroupManager**, and **GenericFactory**. The methods inherited from the **PropertyManager** interface allow definition of properties associated with object groups created by the Replication Manager. The operations inherited from the **ObjectGroupManager** interface allow an application to exercise control over the addition, removal, and location of members of an object group. The operations inherited from the **GenericFactory** interface allow the Replication Manager to create and delete object groups.

The **ReplicationManager** interface provides operations that allow the Fault Notifier to register with the Replication Manager and that allow the application or Fault Tolerance Infrastructure to get the reference of the Fault Notifier subsequently. This interface may be extended with similar methods for other components of the Fault Tolerance Infrastructure by the vendors of the Fault Tolerance Infrastructure.

Note that the **ReplicationManager** interface does not contain **register\_fault\_monitor()** or **get\_fault\_monitor()** operations. The reason is that typically there will be several fault monitors (detectors) within a fault tolerance domain, for example, a fault detector on each of the individual hosts that monitors the objects on that host, and a fault detector for the fault tolerance domain that monitors the fault detectors and the hosts within that domain. Therefore, the means of obtaining the references to the fault monitors is not specified. The Naming Service or Trader Service could be used to obtain the references to the various fault monitors.

```

module FT {
 interface ReplicationManager : PropertyManager, ObjectGroupManager,
 GenericFactory {
 void register_fault_notifier(in FaultNotifier fault_notifier);

 FaultNotifier get_fault_notifier()
 raises (InterfaceNotFound);
 };
};

```

#### 23.3.6.1 Operations

##### *register\_fault\_notifier*

This operation registers the Fault Notifier with the Replication Manager.

```
void register_fault_notifier(in FaultNotifier fault_notifier);
```

*Parameters*

|                |                                                               |
|----------------|---------------------------------------------------------------|
| fault_notifier | The reference of the Fault Notifier that is to be registered. |
|----------------|---------------------------------------------------------------|

*get\_fault\_notifier*

This operation returns the reference of the Fault Notifier.

```
FaultNotifier get_fault_notifier()
raises (InterfaceNotFound);
```

*Return Value*

The reference of the Fault Notifier.

*Raises*

InterfaceNotFound if the Fault Notifier is not found.

### 23.3.7 PropertyManager

The **PropertyManager** interface provides operations that set properties for object groups, such as the **ReplicationStyle**, **MembershipStyle**, **ConsistencyStyle**, **InitialNumberReplicas**, **MinimumNumberReplicas**, etc. It may set these properties statically as defaults for the fault tolerance domain or for a particular type, or may set or change the properties dynamically while the application is executing.

```
module FT {
 interface PropertyManager {
 void set_default_properties(in Properties props)
 raises (InvalidProperty,
 UnsupportedProperty);

 Properties get_default_properties();

 void remove_default_properties(in Properties props)
 raises (InvalidProperty,
 UnsupportedProperty);

 void set_type_properties(in TypedId type_id,
 in Properties overrides)
 raises (InvalidProperty,
 UnsupportedProperty);

 Properties get_type_properties(in TypedId type_id);

 void remove_type_properties(in TypedId type_id,
 in Properties props)
 raises (InvalidProperty,
 UnsupportedProperty);
 }
}
```

```

 void set_properties_dynamically(in ObjectGroup object_group,
 in Properties overrides)
 raises(ObjectGroupNotFound,
 InvalidProperty,
 UnsupportedProperty);

 Properties get_properties(in ObjectGroup object_group)
 raises(ObjectGroupNotFound);
 };
};

```

### 23.3.7.1 Operations

#### *set\_default\_properties*

This operation sets the default properties for all object groups that are to be created within the fault tolerance domain.

```

void set_default_properties(in Properties props)
 raises (InvalidProperty,
 UnsupportedProperty);

```

#### *Parameters*

|       |                                                                                                 |
|-------|-------------------------------------------------------------------------------------------------|
| props | The properties to be set for all newly created object groups within the fault tolerance domain. |
|-------|-------------------------------------------------------------------------------------------------|

#### *Raises*

InvalidProperty if one or more of the properties in the sequence is not valid.  
 UnsupportedProperty if one or more of the properties in the sequence is not supported.

#### *get\_default\_properties*

This operation returns the default properties for the object groups within the fault tolerance domain.

```

Properties get_default_properties();

```

#### *Return Value*

The default properties that have been set for the object groups.

#### *remove\_default\_properties*

This operation removes the given default properties.

```

void remove_default_properties(in Properties props)
 raises (InvalidProperty,

```



**UnsupportedProperty);***Parameters*

|       |                               |
|-------|-------------------------------|
| props | The properties to be removed. |
|-------|-------------------------------|

*Raises*

InvalidProperty if one or more of the properties in the sequence is not valid.

UnsupportedProperty if one or more of the properties in the sequence is not supported.

*set\_type\_properties*

This operation sets the properties that override the default properties of the object groups, with the given type identifier, that are created in the future.

```
void set_type_properties(in Typed type_id,
 in Properties overrides)
 raises (InvalidProperty,
 UnsupportedProperty);
```

*Parameters*

|           |                                                                                                    |
|-----------|----------------------------------------------------------------------------------------------------|
| type_id   | The repository id for which the properties, that are to override the existing properties, are set. |
| overrides | The overriding properties.                                                                         |

*Raises*

InvalidProperty if one or more of the properties in the sequence is not valid.

UnsupportedProperty if one or more of the properties in the sequence is not supported.

*get\_type\_properties*

This operation returns the properties of the object groups, with the given type identifier, that are created in the future. These properties include the properties determined by **set\_type\_properties()**, as well as the default properties that are not overridden by **set\_type\_properties()**.

**Properties get\_type\_properties(in Typed type\_id);***Parameters*

|         |                                                                                                    |
|---------|----------------------------------------------------------------------------------------------------|
| type_id | The repository id for which the properties, that are to override the existing properties, are set. |
|---------|----------------------------------------------------------------------------------------------------|

*Return Value*

The effective properties for the given type identifier.

*remove\_type\_properties*

This operation removes the given properties, with the given type identifier.

```
void remove_type_properties(in Typed type_id,
 in Properties props)
 raises (InvalidProperty,
 UnsupportedProperty);
```

*Parameters*

|         |                                                                     |
|---------|---------------------------------------------------------------------|
| type_id | The repository id for which the given properties are to be removed. |
| props   | The properties to be removed.                                       |

*Raises*

InvalidProperty if one or more of the properties in the sequence is not valid.

UnsupportedProperty if one or more of the properties in the sequence is not supported.

*set\_properties\_dynamically*

This operation sets the properties for the object group with the given reference dynamically while the application executes. The properties given as a parameter override the properties for the object when it was created which, in turn, override the properties for the given type which, in turn, override the default properties.

```
void set_properties_dynamically(in ObjectGroup object_group,
 in Properties overrides)
 raises(ObjectGroupNotFound,
 InvalidProperty,
 UnsupportedProperty);
```

*Parameters*

|              |                                                                                |
|--------------|--------------------------------------------------------------------------------|
| object_group | The reference of the object group for which the overriding properties are set. |
| overrides    | The overriding properties.                                                     |

*Raises*

**InvalidProperty** if one or more of the properties in the sequence is invalid.

**UnsupportedProperty** if one or more of the properties in the sequence is not supported.

*23.3.7.2 get\_properties*

This operation returns the current properties of the given object group. These properties include those that are set dynamically, those that are set when the object group was created but are not overridden by **set\_properties\_dynamically()**, those that are set as properties of a type but are not overridden by **create\_object()** and **set\_properties\_dyamically()**, and those that are set as defaults but are not overridden by **set\_type\_properties()**, **create\_object()**, and **set\_properties\_dyamically()**.

**Properties** **get\_properties(in ObjectGroup object\_group)**  
**raises(ObjectGroupNotFound);**

*Parameters*

|              |                                                                                |
|--------------|--------------------------------------------------------------------------------|
| object_group | The reference of the object group for which the properties are to be returned. |
|--------------|--------------------------------------------------------------------------------|

*Return Value*

The set of current properties for the object group with the given reference.

*Raises*

**ObjectGroupNotFound** if the object group is not found by the Replication Manager.

*23.3.8 ObjectGroupManager*

The **ObjectGroupManager** interface provides operations that allow an application to exercise control over the addition, removal and locations of members of an object group and to obtain the current reference and identifier for an object group.

```
module FT {
 interface ObjectGroupManager {
 ObjectGroup create_member(in ObjectGroup object_group,
 in Location the_location,
```

```

 in TypedId type_id,
 in Criteria the_criteria)
 raises(ObjectGroupNotFound,
 MemberAlreadyPresent,
 NoFactory,
 ObjectNotCreated,
 InvalidCriteria,
 CannotMeetCriteria);

ObjectGroup add_member(in ObjectGroup object_group,
 in Location the_location,
 in Object member)
 raises(ObjectGroupNotFound,
 MemberAlreadyPresent,
 ObjectNotAdded);
ObjectGroup remove_member(in ObjectGroup object_group,
 in Location the_location)
 raises(ObjectGroupNotFound,
 MemberNotFound);
ObjectGroup locations_of_members(in ObjectGroup object_group)
 raises(ObjectGroupNotFound);

ObjectGroupId get_object_group_id(in ObjectGroup object_group)
 raises(ObjectGroupNotFound);

ObjectGroup get_object_group_ref(in ObjectGroup object_group)
 raises(ObjectGroupNotFound);

Object get_member_ref(in ObjectGroup object_group,
 in Location loc)
 raises(ObjectGroupNotFound,
 MemberNotFound);
};
};

```

### 23.3.8.1 Operations

#### *create\_member*

The **create\_member()** operation allows the application to exercise explicit control over the creation of a member of an object group, and to determine where the member is created.

```

ObjectGroup create_member(in ObjectGroup object_group,
 in Location the_location,
 in TypedId type_id,
 in Criteria the_criteria)

```

```

raises(ObjectGroupNotFound,
 MemberAlreadyPresent,
 NoFactory,
 ObjectNotCreated,
 InvalidCriteria,
 CannotMeetCriteria);

```

#### *Parameters*

|              |                                                                                                                                                                                                                                                                                                                                                                                                                                                        |
|--------------|--------------------------------------------------------------------------------------------------------------------------------------------------------------------------------------------------------------------------------------------------------------------------------------------------------------------------------------------------------------------------------------------------------------------------------------------------------|
| object_group | The object group reference for the object group to which the member is to be added.                                                                                                                                                                                                                                                                                                                                                                    |
| the_location | The physical location; that is, a fault containment region, host, cluster of hosts, etc. at which the new member is to be created. There is at most one member of an object group at each location.                                                                                                                                                                                                                                                    |
| type_id      | The repository identifier for the type of the object.                                                                                                                                                                                                                                                                                                                                                                                                  |
| the_criteria | Parameters to be passed to the factory, which the factory evaluates before creating the object. The criteria are implementation-specific and are not defined in this specification. Examples of criteria are initialization values, constraints on the member, etc. The criteria passed in as a parameter to <b>create_member()</b> , if any, override the criteria set in the FactoryInfos property of the given object group for the given location. |

#### *Return Value*

The object group reference of the object group with the member added. This reference may be the same as that passed in as a parameter.

#### *Raises*

**ObjectGroupNotFound** if the object group is not found by the Replication Manager.

**MemberAlreadyPresent** if a member of the object group already exists at the given location.

**NoFactory** if the Replication Manager cannot find a factory that is capable of constructing a member of the object group with the given **type\_id** and at the given location.

**ObjectNotCreated** if the factory or the Replication Manager cannot create the member and add it to the object group.

**InvalidCriteria** if the factory does not understand the criteria.

**CannotMeetCriteria** if the factory understands the criteria but cannot satisfy it.

***add\_member***

The **add\_member()** operation allows an application to exercise explicit control over the addition of an existing object to an object group at a particular location.

```

ObjectGroup add_member(in ObjectGroup object_group,
 in Location the_location,
 in Object member)
raises(ObjectGroupNotFound,
 MemberAlreadyPresent,
 ObjectNotAdded);

```

***Parameters***

|              |                                                                                                                                                                                      |
|--------------|--------------------------------------------------------------------------------------------------------------------------------------------------------------------------------------|
| object_group | The object group reference of the object group to which the existing object is to be added.                                                                                          |
| the_location | The physical location; that is, a fault containment region, host, cluster of hosts, etc. of the object to be added. There is at most one member of an object group at each location. |
| member       | The reference of the object to be added.                                                                                                                                             |

***Return Value***

The object group reference for the object group with the object added. This reference may be the same as that passed in as a parameter.

***Raises***

**ObjectGroupNotFound** if the object group is not found by the Replication Manager.

**MemberAlreadyPresent** if a member of the object group already exists at the given location.

**ObjectNotAdded** if the Replication Manager cannot add the object to the object group.

***remove\_member***

The **remove\_member()** operation allows an application to exercise explicit control over the removal of a member from an object group at a particular location.

If the application invoked the **create\_object()** operation of the **GenericFactory** interface to create the member object and used the **add\_member()** operation to add the object to the object group, when the application invokes **remove\_member()**, the Replication Manager removes the member from the group but does not delete it. Deletion of the object is the responsibility of the application.

If the application invoked the **create\_member()** operation to create the member object, when the application invokes the **remove\_member()** operation to remove the member from the object group, the Replication Manager first removes the member from the object group and then invokes the **delete\_object()** operation of the **GenericFactory** interface to delete the object.

If the Replication Manager invoked the **create\_object()** operation of the **GenericFactory** interface to create the member object, when the application invokes the **remove\_member()** operation to remove the member, the Replication Manager first removes the member from the group and then invokes the **delete\_object()** operation of the **GenericFactory** interface to delete the object.

If the **MembershipStyle** is **MEMB\_INF\_CTRL**, the application invokes the **remove\_member()** operation and the number of members of the object group falls below the **MinimumNumberReplicas**, then the Replication Manager starts up a new member at another location.

```
ObjectGroup remove_member(in ObjectGroup object_group,
 in Location the_location)
 raises(ObjectGroupNotFound,
 MemberNotFound);
```

#### *Parameters*

|              |                                                                                                                       |
|--------------|-----------------------------------------------------------------------------------------------------------------------|
| object_group | The object group reference of the object group from which the member is to be removed.                                |
| the_location | The physical location; that is, a fault containment region, host, cluster of hosts, etc. of the member to be removed. |

#### *Return Value*

The object group reference for the object group with the member removed. This reference may be the same as that passed in as a parameter.

#### *Raises*

**ObjectGroupNotFound** if the object group is not found by the Replication Manager.

**MemberNotFound** if the Replication Manager cannot find a member of the object group at the given location.

#### *set\_primary\_member*

The **set\_primary\_member()** operation allows the application to exercise explicit control over the selection of the member of the object group that is to be the primary.

```
ObjectGroup set_primary_member(in ObjectGroup object_group,
 in Location the_location)
 raises(ObjectGroupNotFound,
```

**MemberNotFound,  
PrimaryNotSet,  
BadReplicationStyle)**

*Parameters*

|              |                                                                                   |
|--------------|-----------------------------------------------------------------------------------|
| object_group | The object group reference of the object group whose primary is to be determined. |
| the_location | The physical location of the member that is to become the primary.                |

*Return Value*

The object group reference of the object group with the primary member at the given location. This reference may be the same as that passed in as a parameter.

*Raises*

**ObjectGroupNotFound** if the object group is not found by the Replication Manager.

**MemberNotFound** if the Replication Manager cannot find a member of the object group at that location.

**PrimaryNotSet** if the Replication Manager cannot set the primary member of the object group.

**BadReplicationStyle** if the **ReplicationStyle** of the given group is not **COLD\_PASSIVE** or **WARM\_PASSIVE**.

*locations\_of\_members*

The **locations\_of\_members()** operation allows the application to determine the locations of the members of the given object group, and the location of the primary member of the group.

**Locations locations\_of\_members(in ObjectGroup object\_group)  
raises(ObjectGroupNotFound);**

*Parameters*

|              |                                                 |
|--------------|-------------------------------------------------|
| object_group | The object group reference of the object group. |
|--------------|-------------------------------------------------|

*Return Value*

A sequence of locations at which the members of the object group currently exist. If the object group has the **COLD\_PASSIVE** or **WARM\_PASSIVE** Replication Style, the first location in the sequence is the location of the primary.



**Raises**

**ObjectGroupNotFound** if the object group is not found by the Replication Manager.

***get\_object\_group\_id***

The **get\_object\_group\_id()** operation takes a reference for an object group as an in parameter, and returns the identifier of the object group.

**ObjectGroupId get\_object\_group\_id(in ObjectGroup object\_group)  
raises(ObjectGroupNotFound);**

**Parameters**

|              |                                                  |
|--------------|--------------------------------------------------|
| object_group | The object group reference for the object group. |
|--------------|--------------------------------------------------|

**Return Value**

The object group identifier for the object group.

**Raises**

**ObjectGroupNotFound** if the object group is not found by the Replication Manager.

***get\_object\_group\_ref***

The **get\_object\_group\_ref()** operation takes a reference for an object group as an in parameter, and returns the current reference for the object group.

**ObjectGroup get\_object\_group\_ref(in ObjectGroup object\_group)  
raises(ObjectGroupNotFound);**

**Parameters**

|              |                                                 |
|--------------|-------------------------------------------------|
| object_group | An object group reference for the object group. |
|--------------|-------------------------------------------------|

**Return Value**

The current object group reference for the object group. The returned reference may be the same as the reference passed in as a parameter.

**Raises**

**ObjectGroupNotFound** if the object group is not found by the Replication Manager.

***get\_member\_ref***

The **get\_member\_ref()** operation takes a reference for an object group and a location as in parameters, and returns a reference for the member.

```

Object get_member_ref(in ObjectGroup object_group,
 in Location loc)
 raises(ObjectGroupNotFound,
 MemberNotFound);

```

*Parameters*

|              |                                                 |
|--------------|-------------------------------------------------|
| object_group | An object group reference for the object group. |
| loc          | The location of the member.                     |

*Return Value*

The reference for the member.

*Raises*

**ObjectGroupNotFound** if the object group is not found by the Replication Manager.

**MemberNotFound** if the member is not found by the Replication Manager.

### 23.3.9 *GenericFactory*

The **GenericFactory** interface is generic in that it allows the creation of replicated objects (object groups), replicas (members of object groups), and unreplicated objects. It is inherited by the Replication Manager to allow the application to invoke the Replication Manager to create replicated objects. It is implemented by the application's local factory objects on the various hosts to allow the Replication Manager to invoke the local factory objects of the application to create individual members of an object group and to allow the application to invoke the local factory objects to create individual (unreplicated) objects.

The **GenericFactory** interface, inherited by the Replication Manager, is programmed by the vendor of the Fault Tolerance Infrastructure. In contrast, the local factory objects, that implement the **GenericFactory** interface, are programmed by the application programmer, rather than by the vendor of the Fault Tolerance Infrastructure; they can be regarded in the same light as the **Monitorable**, **Checkpointable**, and **Updateable** interfaces.

The **GenericFactory** interface provides **create\_object()** and **delete\_object()** operations for creating and deleting objects and object groups.

The application program invokes the **create\_object()** operation of the **GenericFactory** interface inherited by the Replication Manager to create an object group, whether it is application-controlled or infrastructure-controlled, and similarly for the **delete\_object()** operation.

If the **MembershipStyle** is **MEMB\_INF\_CTRL**, the Replication Manager in turn invokes the **create\_object()** operation of the **GenericFactory** interface of the appropriate local factories to create the members of the object group and then adds them to the group.

If the **MembershipStyle** is **MEMB\_APP\_CTRL**, the application or an application-level manager may invoke the **create\_member()** operation of the **ObjectGroupManager** interface which, in turn, causes the Replication Manager to invoke the **create\_object()** operation of the **GenericFactory** interface of the local factory, using the given location and criteria, and then to add the member to the group. Alternatively, the application or an application-level manager itself may invoke the **create\_object()** operation of the **GenericFactory** interface of the local factory to create the object and may then invoke the **add\_member()** operation of the **ObjectGroupManager** interface to cause the Replication Manager to add the object to the group.

To create an unreplicated object, the application invokes the **create\_object()** operation of the **GenericFactory** interface of a specific local factory.

```

module FT {
 interface GenericFactory {
 typedef any FactoryCreationId;
 Object create_object(in Typeld type_id,
 in Criteria the_criteria,
 out FactoryCreationId factory_creation_id)
 raises (NoFactory,
 ObjectNotCreated,
 InvalidCriteria,
 InvalidProperty,
 CannotMeetCriteria);

 void delete_object(in FactoryCreationId factory_creation_id)
 raises (ObjectNotFound);
 };
};

```

There may be multiple different implementations of the **GenericFactory** interface. Each such factory implementation may create objects of one or more types at one or more locations.

The **create\_object()** operation takes a **type\_id** as an in parameter. It also takes **the\_criteria** as an in parameter, which allows a user to specify additional criteria, such as initialization values for the object implementation, constraints on the object, or preferred location of the object. The **type\_id** and **the\_criteria** in parameters of the **create\_object()** operation contribute to the genericity and the flexibility of the **GenericFactory** interface.

The **create\_object()** operation of the **GenericFactory** interface, implemented by the application's local factory objects, accepts a criterion with the reserved name **org.omg.ft.ObjectLocation**. The value of this criterion instructs the factory where to create the object.

The **create\_object()** operation of the **GenericFactory** interface, inherited by the Replication Manager, accepts fault tolerance properties within **the\_criteria** parameter. These fault tolerance properties are contained in a single criterion with the reserved name **org.omg.ft.FTPProperties**. Such properties, if any, override the corresponding

fault tolerance properties that are specified as defaults or based on the type of the object. The Replication Manager removes the **org.omg.ft.FTPProperties** criterion from **the\_criteria** passed to it by the application in the **create\_object()** operation and adds the **org.omg.ft.ObjectLocation** criterion to the criteria before passing **the\_criteria** as a parameter of the **create\_object()** operation to the application's local factory.

The **create\_object()** operation of the **GenericFactory** interface, implemented by the application's local factory objects, returns an object reference as a result.

The **create\_object()** operation of the **GenericFactory** interface, inherited by the Replication Manager, returns an object group reference as a result. If the **MembershipStyle** is **MEMB\_APP\_CTRL**, the Replication Manager creates an object group with no members. Consequently, the returned object group reference contains no **TAG\_INTERNET\_IOP** profiles but, instead, contains a **TAG\_MULTIPLE\_COMPONENTS** profile with the **TAG\_FT\_GROUP** component in it.

The **create\_object()** operation has an out parameter, **factory\_creation\_id**, that is retained by the entity that invoked the method so that it can later invoke the **delete\_object()** operation of the factory using the **factory\_creation\_id** as an in parameter, to cause the factory to delete the object. The factory must also retain this identification information so that it can actually delete the object.

Because the factory retains the identification information that is needed to delete an object that it created, the factory has state. The local factories that create the members of an object group are not replicas of one another. To protect each of these local factories against faults, the application deployer either may replicate each of the factories using the **COLD\_PASSIVE ReplicationStyle**, or may assume that the failure of a local factory at a location (for example, process or host) is equivalent to the failure of that location.

The application deployer registers a sequence of factories with the Property Manager as the **Factories** property of the object group, which contains a sequence of factory reference, **the\_location** and **the\_criteria**, which determine where the factory may create an object and the criteria for the object that it is to create.

If the **MembershipStyle** is **MEMB\_INF\_CTRL**, the Replication Manager uses the locations to choose one or more factories from the **Factories** sequence and uses the factory references to invoke the **create\_object()** operation of the **GenericFactory** interface that the factories implement to create the members of the object group.

If the **MembershipStyle** is **MEMB\_APP\_CTRL** and the application itself invokes the **create\_member()** operation of the **ObjectGroupManager** interface, citing a location that it selected, the Replication Manager invokes the **create\_object()** operation of the **GenericFactory** interface implemented by the factory (provided by the **Factories** property) for that location to create the new member of the object group at that location.

If the **MembershipStyle** is **MEMB\_APP\_CTRL** and the application invokes the **create\_object()** operation of the **GenericFactory** interface for a particular factory to create an object, it may then invoke the **add\_member()** operation of the **ObjectGroupManager** interface to add the object to the group.

Similarly, to create an unreplicated object, the application may invoke the **create\_object()** operation of the **GenericFactory** interface of one of its own factories.

### 23.3.9.1 Identifiers

**typedef any FactoryCreationId;**

An identifier that is assigned to an object by the factory that creates the object and that is used by the factory to delete the object subsequently.

### 23.3.9.2 Operations

#### *create\_object*

This operation of the **GenericFactory** interface creates an object, using the **type\_id** parameter to determine which type of object to create and the **the\_criteria** parameter to determine restrictions on how and where to create the object. The out parameter, **factory\_creation\_id**, allows the entity that invoked the factory, and the factory itself, to identify the object for subsequent deletion.

If the application or the Replication Manager invokes the **create\_object()** operation on the **GenericFactory** interface, implemented by the application's local factory object, then it creates a single object.

If the application invokes the **create\_object()** operation on the **GenericFactory** interface, inherited by the Replication Manager, then it creates an object group. For an object group with the **MEMB\_APP\_CTRL MembershipStyle**, the Replication Manager returns an object group reference containing only the **TAG\_MULTIPLE\_COMPONENTS** profile with the **TAG\_FT\_GROUP** component in it.

One of the name-value pairs in **the\_criteria**, passed to the Replication Manager as a parameter of **create\_object()**, may have the name **org.omg.ft.FTProperties** (which is reserved for specifying fault tolerance properties). The Replication Manager removes that entry of the sequence, adds the **org.omg.ft.ObjectLocation** entry (which is reserved for specifying the location at which the factory is to create the object), and appends any location-specific criteria (specified in the Factories property for the particular location) before it invokes **create\_object()** operation on the application's local factory object.

**Object create\_object(in Typed type\_id,  
                          in Criteria the\_criteria,  
                          out FactoryCreationId factory\_creation\_id)  
          raises (NoFactory,**

**ObjectNotCreated,  
InvalidCriteria,  
InvalidProperty,  
CannotMeetCriteria);**

*Parameters*

|                     |                                                                                                                                                                                                                                                              |
|---------------------|--------------------------------------------------------------------------------------------------------------------------------------------------------------------------------------------------------------------------------------------------------------|
| type_id             | The repository identifier of the object to be created by the factory.                                                                                                                                                                                        |
| the_criteria        | Information passed to the factory, which the factory evaluates before creating the object. Examples of criteria are initialization values, constraints on the object, preferred location of the object, fault tolerance properties for an object group, etc. |
| factory_creation_id | An identifier that allows the factory to delete the object subsequently.                                                                                                                                                                                     |

*Return Value*

The reference to the object created by the **GenericFactory**. When the **GenericFactory** interface is implemented by the application's local factory object, the **create\_object()** operation returns an object reference as a result. When the **GenericFactory** interface is inherited by the Replication Manager, the **create\_object()** operation returns an object group reference as a result.

*Raises*

**NoFactory** if the object cannot be created. When the **GenericFactory** interface is implemented by the application's local factory object, the raised exception indicates that the factory cannot create an individual object of the **type\_id** at the location. When the **GenericFactory** interface is inherited by the Replication Manager, the raised exception indicates that the Replication Manager cannot create the object group because it cannot find a factory that is capable of constructing a member of the object group of the **type\_id** at the location.

**ObjectNotCreated** if the factory cannot create the object.

**InvalidCriteria** if the factory does not understand the criteria.

**InvalidProperty** if a property passed in as criteria is invalid.

**CannotMeetCriteria** if the factory understands the criteria but cannot satisfy it.

*delete\_object*

This operation deletes the object with the given identifier. If the application or the Replication Manager invokes this operation on the **GenericFactory** interface, implemented by the application's local factory object, then it deletes a single object.

If the application invokes this operation on the **GenericFactory** interface, inherited by the Replication Manager, then it deletes an object group. When this operation is invoked on it, the Replication Manager must first remove each of the members from the object group, and delete each of them, before it deletes the object group itself.

```
void delete_object(in FactoryCreationId factory_creation_id)
 raises(ObjectNotFound);
```

*Parameters*

|                     |                                                     |
|---------------------|-----------------------------------------------------|
| factory_creation_id | An identifier for the object that is to be deleted. |
|---------------------|-----------------------------------------------------|

*Raises*

ObjectNotFound if the object cannot be found.

### 23.3.10 Obtaining the Reference for the Replication Manager

The application may obtain a reference to the Replication Manager for its Fault Tolerance Domain by invoking **resolve\_initial\_references()** with an **ObjectId** of “ReplicationManager” and narrowing to the appropriate type.

### 23.3.11 Use Cases

#### 23.3.11.1 Infrastructure-Controlled Membership Style

1. The application obtains a reference to the Replication Manager by invoking **resolve\_initial\_references()** and narrowing the result.
2. To create a replicated object (object group), the application invokes the **create\_object()** operation of the **GenericFactory** interface inherited by the Replication Manager, supplying the **type\_id** and **the\_criteria**. The **create\_object()** operation returns (at Step 11) the object group reference and the object group identifier as the **factory\_creation\_id**, which is recorded by the application to permit it to subsequently request the **GenericFactory** to delete the object group.
3. The Replication Manager obtains the fault tolerance properties for the object group from the Property Manager of the type defined by the **type\_id** parameter. If additional fault tolerance properties are defined in an entry named **org.omg.ft.FTProperties** of **the\_criteria** parameter, those properties override the properties obtained from the Property Manager.
4. Using the **InitialNumberReplicas** property and the **Factories** property (a sequence of factory, location at which the factory is to create the object and criteria that the factory is to use in creating the object), the Replication Manager decides the locations at which to create the members of the object group.

5. For each member, the Replication Manager invokes the **create\_object()** operation of the **GenericFactory** interface of the requisite factory provided by the application for the location of the member, passing in as parameters the **type\_id** and **the\_criteria** obtained from the **Factories** property, as shown in Figure 23-5 on page 23-63. The operation returns the reference of the member and its **factory\_creation\_id**, which is unique within the context of the factory. The factory and the Replication Manager record this information to allow the Replication Manager to invoke the **delete\_object()** operation of the **GenericFactory** interface of the same local factory to delete the member subsequently.
6. The Replication Manager determines the identifier of the object group, and constructs the **TAG\_FT\_GROUP** component containing the fault tolerance domain identifier, the object group identifier and the object group version that allow the object group to be addressed. The Replication Manager then constructs the object group reference.
7. For each gateway:
  - a. The Replication Manager constructs a **TAG\_INTERNET\_IOP** profile for the gateway containing its host and port, and a **TAG\_FT\_GROUP** component that allows the object group to be addressed.
  - b. The Replication Manager then augments the object group reference with the gateway profile.
8. The Replication Manager records the object group reference for the object group against the object group identifier.
9. For each member:
  - a. The Replication Manager adds the member to the object group.
  - b. Depending on the Replication Style, the Replication Manager activates the member.
  - c. The Replication Manager checks the Replication Style, Fault Monitoring Style, Fault Monitoring Granularity to determine whether to initiate fault monitoring of the member.
  - d. The Replication Manager registers itself, or a fault consumer object that it has created, with the Fault Notifier to receive notifications of faults for the member.
10. For the **COLD\_PASSIVE** or **WARM\_PASSIVE** Replication Styles, the Replication Manager determines the primary member of the group and includes the **TAG\_FT\_PRIMARY** component in the profile for that member.
11. The Replication Manager returns to the application the object group reference for the object group, as constructed in Step 7, and the **object\_group\_id** as the out parameter, **factory\_creation\_id**, of the **create\_object()** operation.



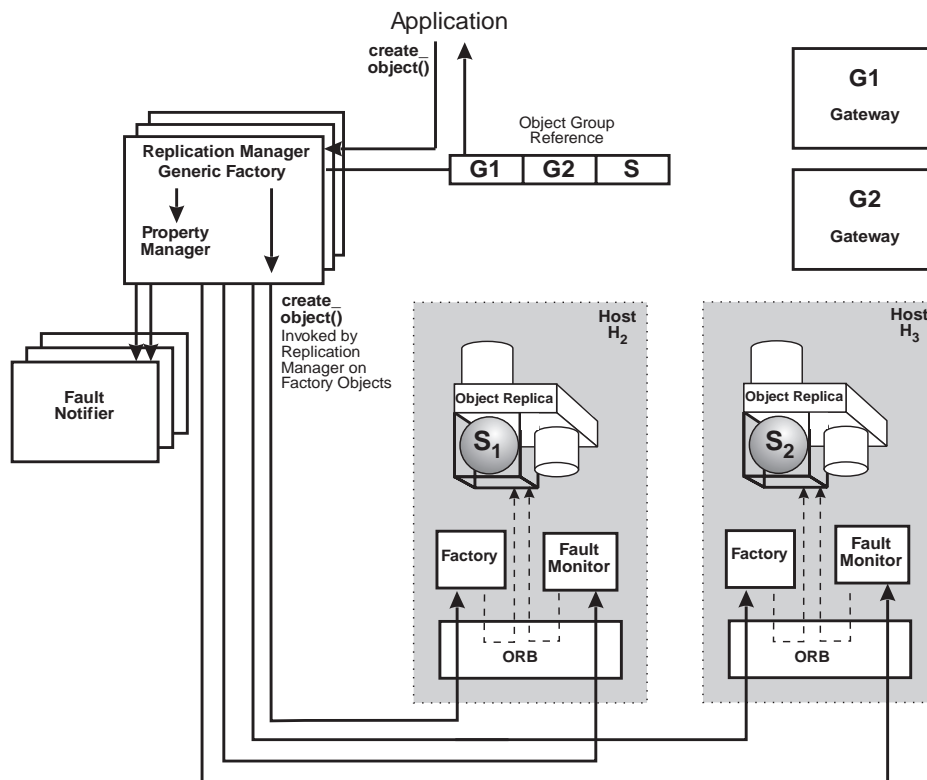

Figure 23-5 The Creation of an Object Group with the Infrastructure-Controlled Membership Style.

### 23.3.11.2 Application-Controlled Membership Style

1. The application obtains a reference to the Replication Manager by invoking **resolve\_initial\_references()**.
2. The application obtains the fault tolerance properties from the Property Manager, including the **InitialNumberReplicas**.
3. To create a replicated object (object group), the application invokes the **create\_object()** operation of the **GenericFactory** interface inherited by the Replication Manager, supplying the **type\_id** and the **criteria**, as shown in Figure 23-5.
4. The Replication Manager determines the identifier of the object group, and constructs the **TAG\_FT\_GROUP** component containing the fault tolerance domain identifier, the object group identifier and the object group version. The Replication Manager then constructs the object group reference, containing the **TAG\_MULTIPLE\_COMPONENTS** profile with the **TAG\_FT\_GROUP** component in it.

5. The Replication Manager returns to the application, as the reply to **create\_object()**, the object group reference and the object group identifier as the **factory\_creation\_id**, which allows the application to delete the object group subsequently.
6. For each member:
  - a. If the application has already created the object that is to become the member, the application invokes the **add\_member()** operation of the **ObjectGroupManager** interface, citing the object group reference, location and member reference.
  - b. If instead the application wants the infrastructure to create the member, the application invokes the **create\_member()** operation of the **ObjectGroupManager** interface, citing the object group reference, location, **type\_id** and **the\_criteria**, as shown in Figure 23-6 on page 23-65.

The Replication Manager obtains the object reference for the **factory**, **the\_location**, and **the\_criteria** from the **Factories** property. The Replication Manager takes **the\_criteria** passed to it by **create\_member()**, appends the property with the name **org.omg.ft.ObjectLocation** and **the\_location** value passed to it by **create\_member()**, and appends **the\_criteria** from the **Factories** property for the particular location. It then invokes the **create\_object()** operation of the **GenericFactory** interface of the factory provided by the application to create a member at that location, passing in the **type\_id** and **the\_criteria**.

The factory returns the object reference and the **factory\_creation\_id** for the new member, and records this identification information. The Replication Manager records the **factory\_creation\_id**, which allows it subsequently to invoke the **delete\_object()** operation of the **GenericFactory** interface of the local factory to delete the member.

- c. The Replication Manager constructs a new object group reference, taking the new member into account. The new object group reference may be the same as the existing object group reference.
- d. The Replication Manager checks the **FaultMonitoringStyle**, **FaultMonitoringGranularity**, and **FaultMonitoringInterval** properties and initiates monitoring of the new member.
- e. The Replication Manager registers itself, or a fault consumer object that it has created, with the Fault Notifier to receive fault reports about the new member.
- f. The Replication Manager returns the new object group reference to the application in case (a) as the return value of **add\_member()** and in case (b) as the return value of **create\_member()**.
7. For the **COLD\_PASSIVE** or **WARM\_PASSIVE** Replication Managers, the application determines which of the members is to be the primary and invokes the **set\_primary\_member()** operation of the **ObjectGroupManager** interface. The

Replication Manager puts the **TAG\_FT\_PRIMARY** component in the appropriate profile of the object group reference and returns the object group reference to the application as the return value of **set\_primary\_member()**.

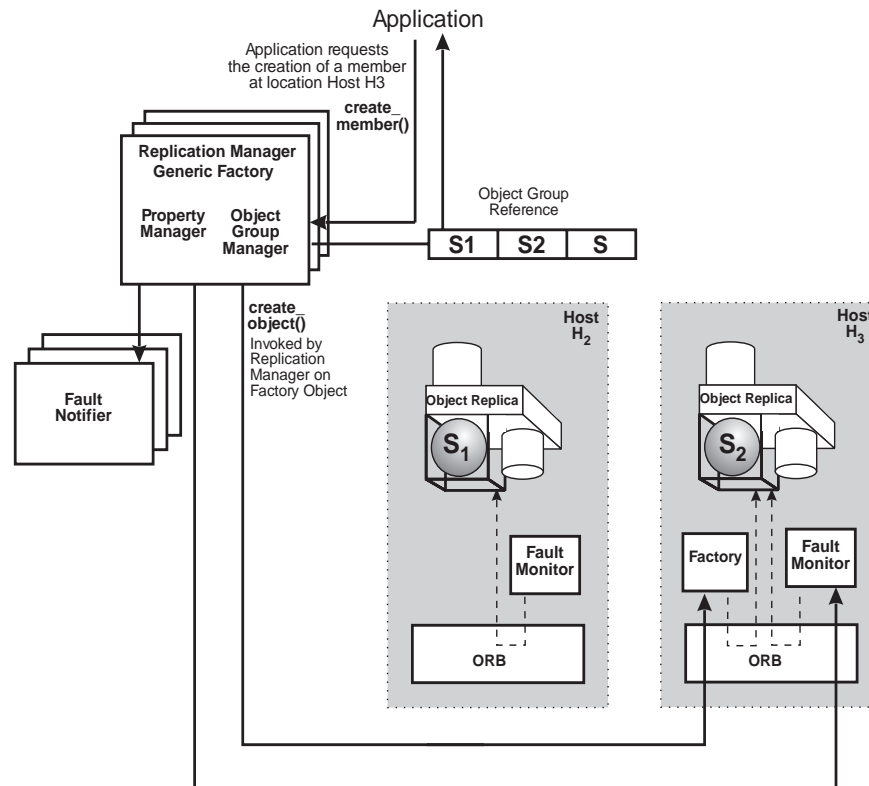

Figure 23-6 The Creation of a Member of an Object Group with the Application-Controlled Membership Style.

### 23.3.11.3 Unreplicated Object Creation and Deletion

#### Creation

1. The application obtains a reference to the local factory.
2. The application invokes the **create\_object()** operation of the **GenericFactory** interface of the local factory, supplying the **type\_id** and the **criteria**.
3. The factory creates the object and returns the object reference and the **factory\_creation\_id** to the application, as the result of **create\_object()**. The **factory\_creation\_id** is unique within the context of the factory. The application and the factory record this identification information, which they can use subsequently to delete the object.

### *Deletion*

1. The application invokes the **delete\_object()** operation of the **GenericFactory** interface of the local factory, supplying the **factory\_creation\_id**.
2. The factory associates the **factory\_creation\_id** with the recorded information and deletes the object.

## 23.4 *Fault Management*

### 23.4.1 *Overview*

In a fault-tolerant system, fault management encompasses the following activities:

- Fault detection - detecting the presence of a fault in the system and generating a fault report.
- Fault notification - propagating fault reports to entities that have registered for such notifications.
- Fault analysis/diagnosis - analyzing a (potentially large) number of related fault reports and generating condensed or summary reports.

In the Fault Tolerance Infrastructure, Fault Detectors detect faults in the objects, and report faults to the Fault Notifier. The Fault Notifier receives fault reports from the Fault Detectors, filters the reports, and propagates the filtered reports as fault event notifications to consumers that have subscribed for them. The Fault Analyzer reasons about the fault reports that it has received, and produces aggregate or summary fault reports that it propagates back to the Fault Notifier for dissemination to other consumers.

A fault-tolerant system typically has several Fault Detectors, including those provided by the infrastructure to monitor objects, and other fault detectors provided by the infrastructure or the application. Each Fault Detector belongs to a particular fault tolerance domain, and is not shared across fault tolerance domains. Most implementations of Fault Detectors are based on timeouts, and use either pull- or push-based monitoring. This section defines an interface for pull-based monitoring, the **PullMonitorable** interface, that application objects inherit, and that is invoked by a Fault Detector within the Fault Tolerance Infrastructure.

The section also defines a **FaultNotifier** interface. The Fault Notifier receives fault reports from the Fault Detectors. The Fault Notifier filters the reports to eliminate unnecessary or duplicate reports. It then sends fault event notifications to the consumers. The Replication Manager is such a consumer, as is the Fault Analyzer. The application can also subscribe to receive fault event notifications. Logically, there is one Fault Notifier per fault tolerance domain, although typically it is replicated for fault tolerance. The Fault Notifier belongs to a particular fault tolerance domain and is not shared across domains.

A fault-tolerant system may also have one or more Fault Analyzers. Each Fault Analyzer collects fault reports and performs event correlation, analysis, and diagnosis. It may condense a large number of related fault reports into a single fault report (e.g.,

the crash of a host can cause fault reports for all objects on that host, as well as a fault report for the host itself). The analysis of fault reports is application-dependent; thus, this chapter does not define a Fault Analyzer interface, but allows an application developer to hook in Fault Analyzers as consumers of fault reports generated by the Fault Notifier.

A problem with fault notification is the potential for a large number of notifications to be generated by a single fault. This problem is addressed by filtering within the Fault Notifier, by Fault Analyzers, and by the **FaultMonitoringGranularity**.

### 23.4.2 Architecture

Figure 23-7 shows the interaction between the Fault Detectors, Fault Notifier, Fault Analyzer, and Replication Manager in a relatively simple system. The fault management specification defines interfaces that allow interaction of:

- A Fault Detector with a pull-monitored object within a fault tolerance domain
- A Fault Detector with the Fault Notifier within a fault tolerance domain
- The Fault Notifier with the Replication Manager, a Fault Analyzer, or other application objects within a fault tolerance domain.

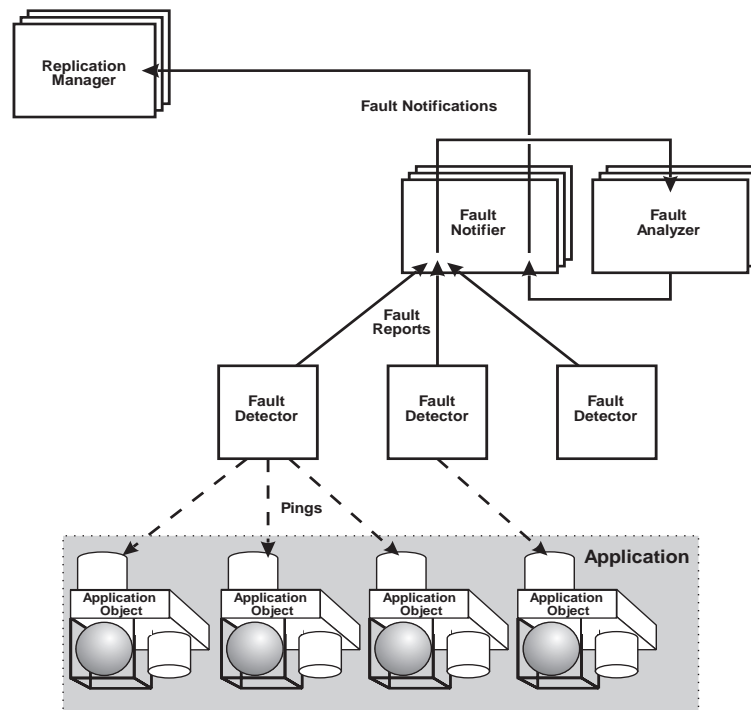

Figure 23-7 Interactions between the Fault Detectors, Fault Notifier, Fault Analyzer, and Replication Manager.

### 23.4.2.1 *Fault Detection*

In the Fault Tolerance Infrastructure, fault detection is initiated by the Replication Manager for members of object groups having either application-controlled or infrastructure-controlled **MembershipStyles** (see Section 23.3.2, “Fault Tolerance Properties,” on page 23-32). Because the fault management specification focuses on monitoring and timeout-based fault detection, the terms monitor and detector are used interchangeably.

There are two common styles of fault monitoring: PULL and PUSH. These two fault monitoring styles differ in the direction in which fault information flows in the system. Because push-based monitoring depends on characteristics of the application, it is not defined in this specification.

The fault management specification defines the interaction between a pull-based Fault Detector and application objects. It defines a **PullMonitorable** interface that the application objects inherit. Other kinds of system-specific (for example, host, network) and application-specific Fault Detectors may be present in the system, but they are not defined.

### 23.4.2.2 *Fault Notification*

This section defines a **FaultNotifier** interface that contains operations that allow a Fault Detector or Fault Analyzer to push fault reports to the Fault Notifier. It also defines operations that allow the Replication Manager, a Fault Analyzer or other application object to register as consumers of fault event notifications. The Fault Notifier filters fault reports that it has received from the Fault Detectors, and propagates fault reports to the entities that have registered for such notifications.

### 23.4.2.3 *Fault Analysis*

The Fault Analyzer registers with the Fault Notifier as a consumer of fault reports. The Fault Analyzer correlates fault reports and generates condensed fault reports. Because these activities are specific to the application or the environment, the application developer is responsible for the analysis/diagnosis algorithm employed by the Fault Analyzer. The Fault Analyzer may use the Fault Notifier to disseminate its condensed fault reports.

### 23.4.2.4 *Scalability*

The fault management specification does not limit the number or arrangement of Fault Detectors in a fault tolerance domain. In a large system spanning many hosts with each host supporting many objects, arranging the Fault Detectors in a hierarchical structure would be more scalable and efficient.

For example, consider a system where all objects at a given location (say, a process) are monitored by a local object-level Fault Detector, as shown in Figure 23-8 on page 23-69. The set of object-level Fault Detectors might be monitored by a process-level Fault Detector. The set of process-level Fault Detectors might be monitored by a

host-level Fault Detector. The Replication Manager, or a consumer object created by the Replication Manager, might be implemented to consume either object-level, process-level, or host-level fault reports. If it is implemented to consume only object-level fault reports, a Fault Analyzer that translates object-level fault reports into process- or host-level fault reports can be attached to the Fault Notifier.

Monitoring at the process level can be achieved by monitoring a single proxy object in the process. The proxy object would be responsible for ensuring that all of the other objects in the process are alive, and would monitor those objects through the use of application-specific facilities or private Fault Notifier channels provided by the infrastructure.

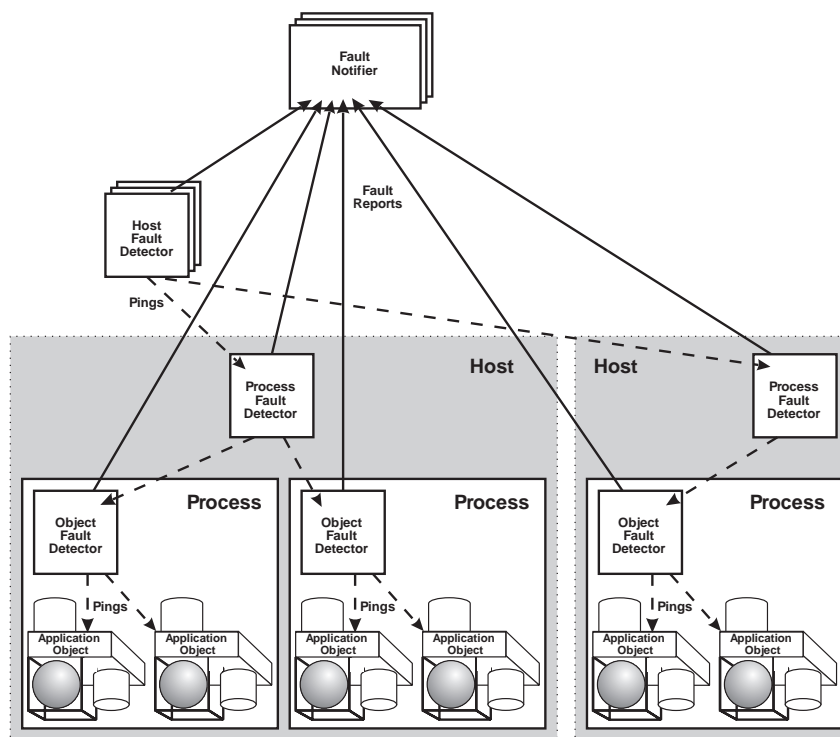

Figure 23-8 Hierarchical Fault Detection.

This example shows the generality of the Fault Tolerance Infrastructure in handling different types of arrangements of Fault Detectors. Other organizations are possible and useful.

#### 23.4.2.5 Deployment of Fault Detectors

Fault Detectors can be as varied as the applications they monitor and, for these diverse applications, Fault Detectors can be deployed in several different ways:

- **Statically Deployed Fault Detectors.** In an operating environment with a relatively static configuration, location-specific Fault Detectors will typically be created when the Fault Tolerance Infrastructure is installed. For example, these stand-alone Fault

Detectors could be implemented as daemon processes that are installed with the Fault Tolerance Infrastructure. These Fault Detectors could be registered in a manner internal to the Fault Tolerance Infrastructure, allowing the infrastructure to include them in every fault-tolerant application within the fault tolerance domain in a transparent manner.

- **Infrastructure Created Fault Detectors.** The Fault Tolerance Infrastructure may create instances of Fault Detectors to meet the needs of the applications. For example, to implement the **MEMB FaultMonitoringGranularity**, the Fault Tolerance Infrastructure must create Fault Detectors sufficient to ping every member of the object group. Because these Fault Detectors are created (or, at least, configured) by the Fault Tolerance Infrastructure, their identities need only be known to the infrastructure.
- **Application Created Fault Detectors.** It might be necessary or advantageous for applications to create their own Fault Detectors. For example, applications might have unique knowledge of their operating environment, such as access to hardware indicators of faults within the operating environment. However, unlike the other types of Fault Detectors, application-created Fault Detectors are not inherently known to the Fault Tolerance Infrastructure. They can propagate their fault information to an application-specific Fault Analyzer through the Fault Notifier provided by the infrastructure. The Fault Analyzer can interpret these application-specific fault reports, generate reports that can be understood by the Replication Manager, and propagate them to the Replication Manager through the Fault Notifier, as shown in Figure 23-8.

### 23.4.3 *Connecting Fault Detectors to Applications*

The Fault Notifier provides flexible event-based connection of Fault Detectors to the Replication Manager, Fault Analyzer, and other application objects. Fault Detectors, from whatever source, push fault reports onto Fault Notifier channels. The Replication Manager, Fault Analyzer, or application objects registers as a consumer of fault reports. The Fault Notifier provides the channel for fault reports in an indirect manner, thus allowing the decoupling of the identity and configuration of the Fault Detectors from the application. The process of connecting the Fault Detectors to the Replication Manager, Fault Analyzer, or application objects thus devolves to a process of finding the Fault Notifier with which to register for fault notifications.

Obtaining a reference to the Fault Notifier for a fault tolerance domain involves two steps:

1. Obtain a reference to the Replication Manager, which may be done using **resolve\_initial\_references()**, as described in Section 23.3.10, “Obtaining the Reference for the Replication Manager,” on page 23-61.
2. Query the Replication Manager for the registered Fault Notifier, which may be done using the **get\_fault\_notifier()** operation of the **ReplicationManager** interface, given in Section 23.3.6, “Replication Manager,” on page 23-44.

The use cases in Section 23.3.11, “Use Cases,” on page 23-61 provide further details.



### 23.4.4 Pull-Based Monitoring

Based on the **MEMB FaultMonitoringGranularity** and the **PULL FaultMonitoringStyle**, the Replication Manager chooses a pull-based Fault Detector to monitor a member of the object group. The pull-based Fault Detector periodically pings the member by invoking the **is\_alive()** operation of the **PullMonitorable** interface that the member of the object group inherits. The period of the ping is determined by the **FaultMonitoringInterval** for the object group. The pull-based Fault Detector uses the monitoring interval as a hint (in contrast to maintaining the exact value) to optimize monitoring across a number of objects.

#### 23.4.4.1 PULL Fault Monitoring Style

In the **PULL FaultMonitoringStyle**, the Fault Detector periodically invokes the object to check its liveness; the monitored object responds to these liveness requests. The monitored object must inherit the **PullMonitorable** interface. The Fault Detector invokes the **is\_alive()** operation of this interface to check the liveness of the object.

Figure 23-9 shows the interactions between the monitored object represented by the **PullMonitorable** interface and the Fault Detector for the **PULL FaultMonitoringStyle**, and the interactions with the Fault Notifier and the Replication Manager.

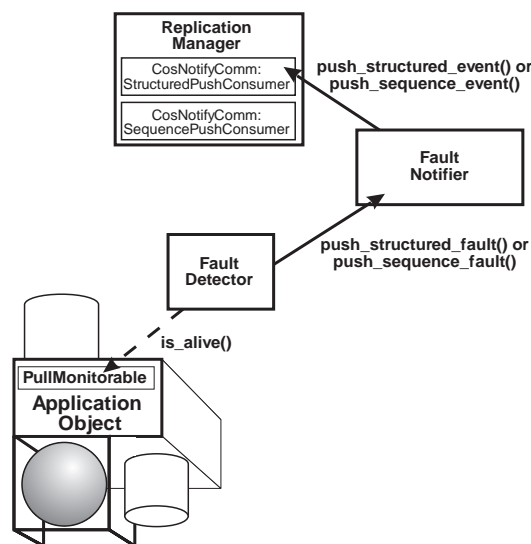

Figure 23-9 PULL FaultMonitoringStyle.

#### 23.4.4.2 PullMonitorable Interface

```

module FT {
 interface PullMonitorable
 boolean is_alive();
 };
};

```

*is\_alive*

This operation informs the pull-based Fault Detector whether the object is able to accept requests and produce replies. The monitored object may return true directly to indicate its liveness, or it may perform an application-specific “health” check (for example, assertion check) within the operation and return false if the test shows that the object is in an inconsistent state.

**boolean is\_alive();**

*Return Value*

Returns true if the object is alive and ready to take further requests, and false otherwise.

### 23.4.5 Fault Event Types

Fault reports are conveyed to the Fault Notifier by the Fault Detectors and by the Fault Notifier to the entities that have registered for such notifications. The Fault Detectors and Fault Notifier use a well-defined event type to convey a given fault event. This specification defines a set of fault event types that are understood by the Fault Tolerance Infrastructure. Vendors or the OMG may extend these fault event types to include other types of fault events.

To align the Fault Tolerant CORBA specification with the **CosNotification** Service, the fault event types are mandated to be either **CosNotification::StructuredEvent** or **CosNotification::EventBatch** (sequence of **StructuredEvent**). Fault events flow from the Fault Detectors to the Fault Notifier to the consumers according to one of these two formats.

#### 23.4.5.1 ObjectCrashFault

The fault management specification defines one event type: **ObjectCrashFault**. As the name suggests, this event is generated by a Fault Detector when it detects that an object has crashed. The definition for the event type is as follows:

```
CosNotification::StructuredEvent fault_event;
 fault_event.header.fixed_header.event_type.domain_name = "FT_CORBA";
 fault_event.header.fixed_header.event_type.type_name = "ObjectCrashFault";
 fault_event.filterable_data_length(2);
 fault_event.filterable_data[0].name = "FTDomainId";
 fault_event.filterable_data[0].value = /* Value of FTDomainId bundled into any */;
 fault_event.filterable_data[1].name = "Location";
 fault_event.filterable_data[1].value = /* Value of Location bundled into any */;
 if (all objects at a given location have failed)
 {} /* do nothing */
 else
 fault_event.filterable_data.length(3);
 fault_event.filterable_data[2].name = "TypeId";
 fault_event.filterable_data[2].value = /* Value of TypeId bundled into any */;
 if (all objects of a given type at a given location have failed)
 {} /* do nothing */
```

```

else {
 fault_event.filterable_data.length(4);
 fault_event.filterable_data[3].name = "ObjectGroupId";
 fault_event.filterable_data[3].value =
 /* Value of ObjectGroupId bundled into any */;
};
};

```

The **filterable\_data part** of the event body contains the identity of the crashed object as four name-value pairs: the fault tolerance domain identifier, the member's location identifier, the repository identifier and the object group identifier. The Fault Notifier filters events based on the **domain\_name**, the **type\_name**, and the four identifiers. All other fields of the structured event may be set to null.

The Fault Detector always sets the following fault event fields: **domain\_name**, **type\_name**, **FTDomainId**, and **Location**. The fault detector may or may not set the **TypeId** and **ObjectGroupId** fields with the following interpretations:

- Neither is set if all objects at the given location have failed.
- **TypeId** is set and **ObjectGroupId** is not set if all objects at the given location with the given type have failed.
- Both are set if the member with the given **ObjectGroupId** at the given location has failed.

### 23.4.6 Fault Notifier

The Fault Notifier takes the fault reports generated by the Fault Detectors or the Fault Analyzers, filters them, and propagates them to entities that have registered for fault notifications, such as the Replication Manager, the Fault Analyzer, or other application objects.

The Fault Notifier provides a small subset of the functionality of the **CosNotification Service**. The **CosNotification Service** is complex, and an implementation of the full specification might be difficult to render fault tolerant. The Fault Notifier assumes that the notification channel used for propagating fault reports has the following properties:

- Push-based event communication model.
- Support for propagating **CosNotification::StructuredEvent** and **CosNotification::EventBatch** (Sequence of **StructuredEvent**) types.
- Forwarding filter framework at the consumer.

A notification channel that provides the above properties and that can be made fault-tolerant is a good candidate for implementing the Fault Notifier.

The Fault Notifier uses the existing **CosNotification StructuredEvent** and **EventBatch** formats, forwarding filter framework, and consumer end interfaces. The default constraint grammar is the same as that supported by the **CosNotification Service** (see telecom/98-11-01).

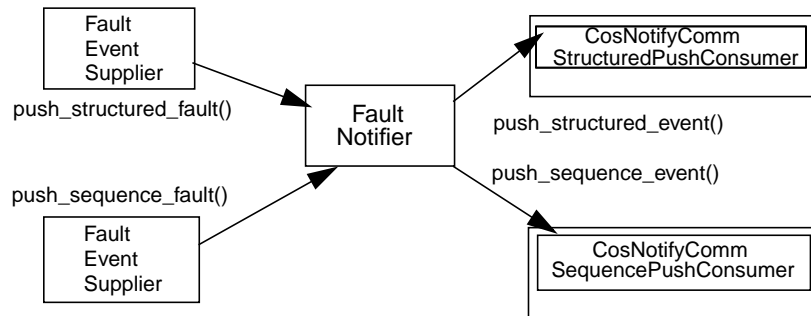

Figure 23-10 Fault Report Propagation through the Fault Notifier

Figure 23-10 shows the interaction between the Fault Notifier and the fault event suppliers and consumers during fault propagation.

Any fault event supplier (Fault Detector) may obtain the reference to the Fault Notifier and send fault reports to it. It does not need to register explicitly with the Fault Notifier. The **FaultNotifier** interface provides two operations, **push\_structured\_fault()** and **push\_sequence\_fault()**, for fault event suppliers to push fault events of the form **CosNotification::StructuredEvent** and **CosNotification::EventBatch** to the Fault Notifier.

A fault event consumer, such as the Replication Manager or a consumer object created by the Replication Manager, must register with the Fault Notifier to receive fault event notifications, as shown in Figure 23-11. The **FaultNotifier** interface provides two operations for registering consumers: **connect\_structured\_fault\_consumer()** for consumers that accepts only structured events and **connect\_sequence\_fault\_consumer()** for consumers that accept a sequence of structured events. A consumer that wishes to receive structured events must support the **CosNotifyComm::StructuredPushConsumer** interface and a consumer that wishes to receive a sequence of structured must support the **CosNotifyComm::SequencePushConsumer** interface.

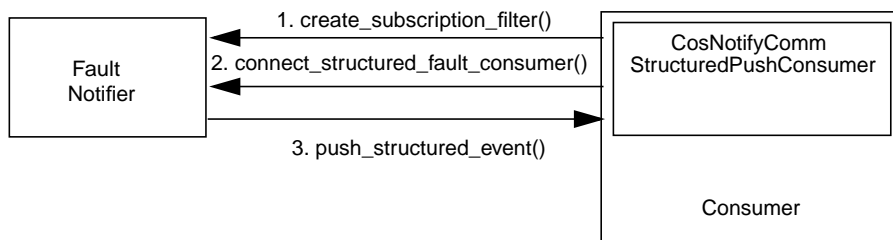

Figure 23-11 Connection Setup between the Consumer and the Fault Notifier

The Fault Notifier propagates all events of a given format to all consumers that accept that format. While a consumer is connected to the Fault Notifier, it may use the operation **replace\_constraint()** to replace a constraint for a given sequence of event types.

```

module FT {
 interface FaultNotifier {
 typedef unsigned long long ConsumerId;
 void push_structured_fault(
 in CosNotification::StructuredEvent event);

 void push_sequence_fault(
 in CosNotification::EventBatch events);

 ConsumerId connect_structured_fault_consumer(
 in CosNotifyComm:StructurePushConsumer
 push_consumer);

 ConsumerId connect_sequence_fault_consumer(
 in CosNotifyComm:StructurePushConsumer
 push_consumer);

 void disconnect_consumer (in ConsumerId connection)
 raises(CosEventComm::Disconnected);

 void replace_constraint (in ConsumerID connection,
 in CosNotification::EventTypeSeq event_types,
 in string constr_expr);

 };
};

```

#### 23.4.6.1 Identifiers

```
typedef unsigned long long ConsumerId;
```

The identifier used to identify the consumer of notifications uniquely within the Fault Notifier.

#### 23.4.6.2 Operations

##### *push\_structured\_fault*

The supplier of a fault report creates a structured event containing the fault report and invokes this operation with the structured event as an in parameter. The Fault Notifier then pushes a fault notification to the consumers that have registered for such notifications.

```
void push_structured_fault(in CosNotification::StructuredEvent event);
```

*Parameters*

|       |                                                          |
|-------|----------------------------------------------------------|
| event | The fault event that is to be delivered to the consumer. |
|-------|----------------------------------------------------------|

*push\_sequence\_fault*

The supplier of a fault report creates a sequence of structured event containing the fault reports and invokes this operation with the sequence of structured event as an in parameter. The Fault Notifier then pushes a fault notification to the consumers that have registered for such notifications.

```
void push_sequence_fault(in CosNotification::EventBatch events);
```

*Parameters*

|       |                                                          |
|-------|----------------------------------------------------------|
| event | The fault event that is to be delivered to the consumer. |
|-------|----------------------------------------------------------|

*connect\_structured\_fault\_consumer*

This operation accepts as an in parameter the reference to a consumer that wishes to receive structured events from the Fault Notifier and returns an identifier that uniquely identifies the consumer within the context of the Fault Notifier. The consumer must use this identifier in all of its subsequent interactions with the Fault Notifier. The operation establishes a logical connection between the Fault Notifier and the consumer, and allows the Fault Notifier to push fault events to the consumer, using the **push\_structured\_event()** operation of the **CosNotifyComm::StructuredPushConsumer** interface.

```
ConsumerId connect_structured_fault_consumer(
 in CosNotifyComm::StructuredPushConsumer push_consumer);
```

*Parameters*

|               |                                                                                   |
|---------------|-----------------------------------------------------------------------------------|
| push_consumer | The reference to the consumer object that is registering for fault notifications. |
|---------------|-----------------------------------------------------------------------------------|

*Return Value*

An identifier that uniquely identifies the consumer within the context of the Fault Notifier and is used by the consumer in subsequent interactions with the Fault Notifier.

*connect\_sequence\_fault\_consumer*

This operation accepts as an in parameter the reference to a consumer that wishes to accept a sequence of structured events from the Fault Notifier and returns an identifier that uniquely identifies the consumer within the context of the Fault Notifier. The consumer must use this identifier in all of its subsequent interactions with the Fault Notifier. The operation establishes a logical connection between the Fault Notifier and

the consumer, and allows the Fault Notifier to push fault events to the consumer using the **push\_sequence\_event()** operation of the **CosNotifyComm::SequencePushConsumer** interface.

```
ConsumerId connect_sequence_fault_consumer(
in CosNotifyComm::SequencePushConsumer push_consumer);
```

*Parameters*

|               |                                                                                   |
|---------------|-----------------------------------------------------------------------------------|
| push_consumer | The reference to the consumer object that is registering for fault notifications. |
|---------------|-----------------------------------------------------------------------------------|

*Return Value*

An identifier that uniquely identifies the consumer within the context of the Fault Notifier and that is used by the consumer in subsequent interactions with the Fault Notifier.

*disconnect\_consumer*

This operation is invoked by the consumer to disconnect itself from the Fault Notifier. The operation takes as an in parameter the **ConsumerId** identifying the disconnecting consumer.

```
void disconnect_consumer(in ConsumerId connection)
raises(CosEventComm::Disconnected);
```

*Parameters*

|            |                                                                                    |
|------------|------------------------------------------------------------------------------------|
| connection | The ConsumerId identifying the particular consumer that wishes to be disconnected. |
|------------|------------------------------------------------------------------------------------|

*Raises*

**CosEventComm::Disconnected** if the Fault Notifier is not currently connected to any consumer identifier by the given **ConsumerId**.

### 23.4.6.3 Filtering

Filtering is done by the Fault Notifier based on the constraints provided by the consumer.

Because Location is of type **CosNaming::Name**, a location can be described using a hierarchical location scheme. For example, an object “objA” located in process “procB” on host “hostC” can be described as follows:

```
Location object_location;
object_location.length(3);
object_location[0].id = "hostC";
object_location[0].kind = "hostname";
```

```

object_location[1].id = "procB";
object_location[1].kind = "processname";
object_location[2].id = "objA";
object_location[2].kind = "objectname";

```

To facilitate hierarchical fault detection and reporting, the Fault Detector may omit some trailing Location entries. For example, if all objects on a host fail, then a Fault Detector may send a fault report with only the leading Location entry, which identifies the failed host.

The Fault Notifier may also filter events based on a subset of the Location entries. For example, if a consumer of fault events wishes to subscribe to notifications of faults of type **ObjectCrashFault** on a particular host, the filtering selects faults based on the leading entry of Location, which identifies the host.

The Extended Trader Constraint Language is used to filter fault events, as illustrated below.

For example, to register for all fault events in ftdom0 on hostC, use the filter string "\$event\_type.domain\_name == 'FT\_CORBA' and \$event\_type.type\_name == 'ObjectCrashFault' and \$FTDomainId == 'ftdom0' and \$Location[0].id == 'hostC'".

To register for fault events for a member of an object group, identified by (ftdom0, group1, type2, hostC, procB), where the object itself crashed or the process containing the object crashed or the host supporting the process crashed, use the filter string "\$event\_type.domain\_name == 'FT\_CORBA' and \$event\_type.type\_name == 'ObjectCrashFault' and \$FTDomainId == 'ftdom0' and (not exists \$ObjectGroupId or \$ObjectGroupId == 'group1') and (not exists \$TypeId or \$TypeId == 'type2') and \$Location[0].id == 'hostC' and (not exists \$Location[1] or \$Location[1].id == 'procB')".

#### 23.4.6.4 Mapping of the Fault Notifier to the CosNotification Service

This section is intended as an informational, rather than a mandatory, part of the specification. It is intended for vendors that want to use the **CosNotification** service, in place of the **FaultNotifier** interface that has been defined in this specification. Such a vendor must use an implementation of the **CosNotification** service that can be rendered fault-tolerant and that is compatible with the rest of the Fault Tolerance Infrastructure. The six operations of the **FaultNotifier** interface map directly or indirectly to one or more of the operations of the **CosNotification** service.

##### **Initialization**

The Fault Notifier first creates a notification channel and registers itself both as a structured event supplier and a sequence of structured event supplier with the notification channel. To register itself as a supplier of structured events, the Fault Notifier goes through the following steps:

1. It invokes **CosNotifyChannelAdmin::EventChannel::default\_supplier\_admin()** and gets the reference to the **CosNotifyChannelAdmin::SupplierAdmin** interface.



2. It invokes **obtain\_notification\_push\_consumer()** on the **SupplierAdmin** interface and gets a reference to the **CosNotifyChannelAdmin::ProxyConsumer** interface, which it narrows to **CosNotifyChannelAdmin::StructuredProxyPushConsumer**.
3. It invokes **connect\_structured\_push\_supplier()** on the **StructuredProxyPushConsumer** to connect itself as a supplier of structured events.

The Fault Notifier follows similar steps to register itself as a supplier of a sequence of structured events.

### *Supplier End Operations*

The supplier end methods **push\_structured\_fault()** and **push\_sequence\_fault()** map to **CosNotifyComm::StructuredProxyPushConsumer::push\_structured\_event()** and **CosNotifyComm::SequenceProxyPushConsumer::push\_sequence\_event()**.

### *Consumer End Operations*

A consumer, such as the Replication Manager or a consumer object created by the Replication Manager, connect to the Fault Notifier through the **connect\_structured\_fault\_consumer()** and **connect\_sequence\_fault\_consumer()** operations. The consumer sets the constraints for a given sequence of event types using the **replace\_constraint()** operation.

In response to the **connect\_structured\_fault\_consumer()** invocation, the Fault Notifier goes through the following sequence of steps to set up the connection between the consumer and the notification channel.

1. It invokes **CosNotifyChannelAdmin::EventChannel::default\_consumer\_admin()** and gets the reference to the **CosNotifyChannelAdmin::ConsumerAdmin** interface.
2. It invokes **obtain\_notification\_push\_supplier()** on the **ConsumerAdmin** and gets a reference to the **CosNotifyChannelAdmin::ProxySupplier** interface which it narrows to **CosNotifyChannelAdmin::StructuredProxyPushSupplier**.
3. It invokes **connect\_structured\_push\_consumer()** on the **StructuredProxyPushSupplier** and passes it the reference to the connecting consumer. This sets up a connection capable of propagating structured fault events between the notification channel and the push consumer.

## *23.4.7 Use Cases*

### *23.4.7.1 The Fault Detector as a Fault Notification Supplier*

1. The Replication Manager wishes to monitor an object O1 with reference O1\_ref. The object belongs to the fault tolerance domain “acme.com” and object group “1” and location “object\_location.” Based on the **PULL FaultMonitoringStyle** and the location of the object, the Replication Manager chooses a pull-based Fault Detector and informs it to start monitoring the object with the value of the **FaultMonitoringInterval** given as a property.

2. The pull-based Fault Detector periodically invokes **is\_alive()** on O1\_ref.
3. If Object O1 fails to respond to the **is\_alive()** messages of the Fault Detector, the Fault Detector may declare the object to have crashed. It then takes the following actions:
  - It creates a **StructuredEvent** data structure with the following data.

```

Location object_location;
object_location.length(1);
object_location[0].id = "myhost.acme.com";
object_location[0].kind = "hostname";
CosNotification::StructuredEvent fault_event;
fault_event.header.fixed_header.event_type.domain_name = "FT_CORBA";
fault_event.header.fixed_header.event_type.type_name = "ObjectCrashFault";
fault_event.filterable_data.length(4);
fault_event.filterable_data[0].name = "FTDomainId";
fault_event.filterable_data[0].value <=<= "acme.com";
fault_event.filterable_data[1].name = "Location";
fault_event.filterable_data[1].value <=<= object_location;
fault_event.filterable_data[2].name = "TypeId";
fault_event.filterable_data[2].value <=<= object_type;
fault_event.filterable_data[3].name = "ObjectGroupId";
fault_event.filterable_data[3].value <=<= 1;

```

- It invokes **push\_structured\_event(fault\_event)** on the Fault Notifier.

#### 23.4.7.2 The Replication Manager as a Fault Notification Consumer

1. The Replication Manager wishes to be notified when object O1 crashes.
2. The Replication Manager invokes **connect\_structured\_fault\_consumer()** with a push consumer reference as an in parameter. The Fault Notifier returns a consumer identifier to the Replication Manager.
3. The Replication Manager creates a sequence of event types and their corresponding constraint expressions, as follows:

```

CosNotification::EventTypeSeq event_types;
event_types.length(1);
event_types[0].domain_name = "FT_CORBA";
event_types[0].type_name = "ObjectCrashFault";

const CORBA::string constraint_expr;
constraint_expr = "$FTDomainId == 'acme.com'
 and $ObjectGroupId == 1
 and $Location[0].id == 'myhost.acme.com'";

```

4. The Replication Manager invokes **replace\_constraint(consumer\_id, event\_types, constraint\_expr)** on the filter object returned in Step 2. The above constraints allow the Replication Manager to register for **ObjectCrashFault** of a member of object group 1 occurring on host "myhost.acme.com".

5. When the Replication Manager is no longer interested in fault reports for OI, it invokes **replace\_constraints()** on the filter object with suitable constraint values.
6. If the Replication Manager does not wish to receive any more notifications, it disconnects from the Fault Notifier by invoking **disconnect\_consumer(c\_id)** on it.

## 23.5 Logging & Recovery Management

### 23.5.1 Overview

The Fault Tolerance Infrastructure includes Logging and Recovery Management Mechanisms that support the infrastructure-controlled **ConsistencyStyle**. During normal operation, the Logging Mechanism records the state and actions of the primary member of a passively replicated object group in a log. After a fault, the Recovery Mechanism retrieves these records from the log and uses them to restore the state of a backup member of the object group, so that it can continue the service provided by the primary member that failed. The Logging and Recovery Mechanisms are also used to activate a new member of an actively replicated object group. No interfaces are defined for the Logging and Recovery Mechanisms because these mechanisms are never invoked directly by the application program.

This section defines two interfaces that objects of the application program inherit: **Checkpointable** and **Updateable**. An application object that needs to have its state logged and restored must inherit the **Checkpointable** interface. In addition, it may inherit the **Updateable** interface, which allows state changes to be logged and restored incrementally.

### 23.5.2 Logging Mechanism

During normal operation, the Logging Mechanism records the state and actions of a member of an object group in a log, as shown in Figure 23-12 on page 23-83. The state and actions correspond to messages sent and received by the member of the object group. Conceptually, the Fault Tolerance Infrastructure maintains a distinct log for each object group, although it may record the logs for many object groups within the same physical log. The log may be distributed, in which case it is maintained in local volatile storage at each member of the object group that is the destination of the message. The distributed logging strategy typically employs a reliable totally-ordered multicast protocol to deliver the messages to all of the members of the object group. Alternatively, particularly for passively replicated object groups, the log may be written to shared stable storage by the primary member of the object group that is the source of the message. To be sound, the shared logging strategy requires that each message is forced to the log on stable storage before it is transmitted, which may have an adverse effect on performance.

The format of the log is not specified in this specification. Typically, the information recorded in the log consists of request and reply messages, and states and updates in the form of **get\_state()** and **get\_update()** request and reply messages, as shown in

Figure 23-12 on page 23-83. The log must preserve the order in which messages were received by the members of the object group, so that they can be replayed in the correct order during recovery. States and updates must be positioned logically in the message sequence at the point at which they were requested by the **get\_state()** or **get\_update()** request message, even though the state or update may be contained in a reply message that is sent at a later time. A complete state consists of the **get\_state()** request message and the reply to that request. A complete update is defined similarly.

To conserve memory, the Logging Mechanism must prune the log of records that the Recovery Mechanism will not subsequently require for recovery. Thus, if the log contains a complete state, the Logging Mechanism can discard all log records prior to the **get\_state()** request message for that state. Similarly, if a log contains a complete update, the Logging Mechanism can discard all request and reply messages, other than those associated with the logging of a state or update, that precedes the **get\_update()** request message for that update. If, however, a request contains an **FT\_REQUEST** service context, which defines an expiration time for the request, the request and its matching reply must be retained until that expiration time.

### 23.5.3 *Recovery Mechanism*

The Recovery Mechanism sets the state of a member, either after a fault when a backup member of an object group is promoted to the primary member, or alternatively when a new member is introduced into an object group. The Recovery Mechanism processes the log and applies messages from the log to the member to bring that member to the correct current state, so that it can start to process messages normally, as shown in Figure 23-12 on page 23-83.

The messages in the log are not necessarily in the order required for recovery. The Recovery Mechanism processes the log, discarding irrelevant messages to form a complete log. A complete log for an object group contains:

- The most recent complete state in the log. Prior complete states are ignored and can be discarded from the log. Subsequent incomplete states are ignored but are retained in the log so that they can be completed.
- All complete updates that occur after the most recent complete state. Complete updates that occur prior to the most recent complete state are ignored and can be discarded from the log. Subsequent incomplete updates are ignored but are retained in the log so that they can be completed.

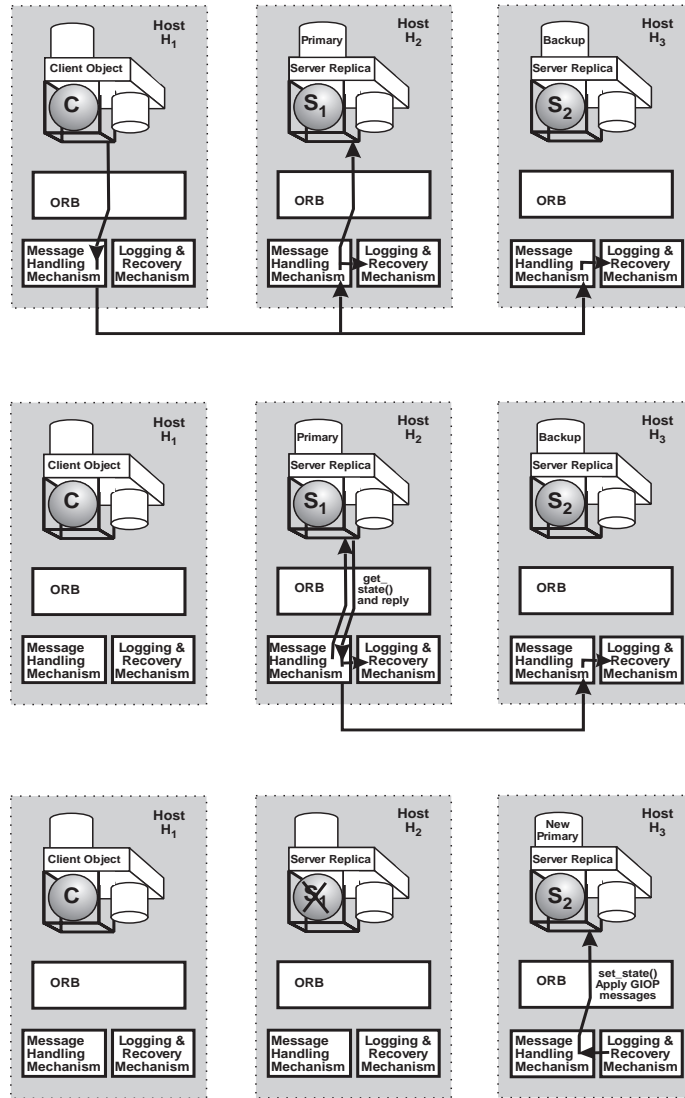

Figure 23-12 Operation of the Logging and Recovery Mechanisms for a server object group having the WARM\_PASSIVE ReplicationStyle, during normal operation, during the recording of a checkpoint, and during recovery

- All request and reply messages that occur in the log after the most recent complete state and after the most recent complete update, if present. Request and reply messages are ignored and can be discarded from the log if they occur before the complete state or complete update and if they are not the most recent request and reply messages in the sequence of request and reply messages for a client object group's invocations of this object group.

For a backup member of an object group with the **COLD\_PASSIVE ReplicationStyle** that is being promoted to primary member, or for a new member of an object group with the **ACTIVE ReplicationStyle**, the Recovery Mechanism must apply the entire complete log to the member.

For a backup member of an object group with the **WARM\_PASSIVE ReplicationStyle** that is being promoted to primary member, the member has already received states and updates during normal operation. The Recovery Mechanism applies to the member, only messages in the complete log that follow the most recent state or update applied to the member during normal operation.

For a new backup member of an object group with the **WARM\_PASSIVE ReplicationStyle**, the Recovery Mechanism applies only the state and update messages in the complete log to the member.

#### 23.5.4 Checkpointable and Updateable Interfaces

An application object inherits the **Checkpointable** interface, which provides **get\_state()** and **set\_state()** operations, to enable the Logging and Recovery Mechanisms to record and restore its state. The Logging Mechanism obtains the value of the **CheckpointInterval** from the Property Manager, which determines the interval between successive invocations of the **get\_state()** operation.

An application object may also inherit the **Updateable** interface, which provides **get\_update()** and **set\_update()** operations, to enable the Logging and Recovery Mechanisms to record and restore updates. An update is the set of changes in the state of an object since the most recent invocation of **get\_state()** or **get\_update()**.

The Logging Mechanism invokes the **get\_state()** operation on a member of an object group to obtain its state. In addition, for the **WARM\_PASSIVE ReplicationStyle**, the Logging Mechanism invokes the **get\_state()** operation on the primary member to obtain the state needed to update the backup members in order to speed up the failover process in case the primary fails. The Recovery Mechanism invokes the **set\_state()** operation on the new or recovering member of the object group, and on the backups for the **WARM\_PASSIVE ReplicationStyle**.

The Logging Mechanism invokes the **get\_update()** operation on a member of an object group to obtain data that represents the change (delta) between the previous state and the current state. The “previous” state is the state at the moment of the most recent invocation of **get\_state()** or **get\_update()**. The state of the backup is typically updated using the most recent state plus the following updates. The Recovery Mechanism invokes the **set\_update()** operation on the new or recovering member of the object group, and on the backups for the **WARM\_PASSIVE ReplicationStyle**.

```
module FT {
 typedef sequence<octet> State;

 exception NoStateAvailable {};
 exception InvalidState {};
 exception NoUpdateAvailable {};
 exception InvalidUpdate {}; get_update
```

```

interface Checkpointable {
 State get_state()
 raises(NoStateAvailable);

 void set_state(in State s)
 raises(InvalidState);
};

interface Updateable : Checkpointable {
 State get_update()
 raises(NoUpdateAvailable);

 void set_update(in State s)
 raises(InvalidUpdate);
};
};

```

#### 23.5.4.1 Identifiers

```
typedef sequence<octet> State;
```

The state or partial state (update) of an object.

#### 23.5.4.2 Exceptions

|                       |                                                                                                                                                                                       |
|-----------------------|---------------------------------------------------------------------------------------------------------------------------------------------------------------------------------------|
| NoStateAvailable {}   | This exception is thrown if the state of the object is not available.                                                                                                                 |
| InvalidState {};      | This exception is thrown if the state being supplied to the object is not a valid state for the object. The Fault Tolerance Infrastructure then assumes that the object has failed.   |
| NoUpdateAvailable {}; | This exception is thrown if an update for the object is not available.                                                                                                                |
| InvalidUpdate {};     | This exception is thrown if the update being supplied to the object is not a valid update for the object. The Fault Tolerance Infrastructure then assumes that the object has failed. |

### 23.5.4.3 Operations

#### *get\_state*

This operation obtains the state of the application object on which it is invoked. The operation is invoked by the Logging Mechanism. The **CheckpointInterval** obtained from the Property Manager determines the interval between invocations of **get\_state()**.

When the Logging Mechanism invokes **get\_state()**, the application object returns the state. For each retrieval of a state, the Logging Mechanism invokes **get\_state()** only once, and the state that is returned is the state at the time **get\_state()** is invoked.

**State get\_state()**  
**raises(NoStateAvailable);**

#### *Return Value*

The state of the application object on which the operation is invoked.

#### *Raises*

**NoStateAvailable** if the state is not available.

#### *set\_state*

This operation sets the state of the application object on which it is invoked. The operation is invoked by the Recovery Mechanism. When the Recovery Mechanism invokes **set\_state()**, it transfers the state to the application object.

**void set\_state(in State s)**  
**raises(InvalidState);**

#### *Parameters*

|   |                                                                                                    |
|---|----------------------------------------------------------------------------------------------------|
| s | The state to be used to set the state of the application object on which the operation is invoked. |
|---|----------------------------------------------------------------------------------------------------|

#### *Raises*

**InvalidState** if the parameter *s* is not a valid state. If the exception is raised, the Fault Tolerance Infrastructure assumes that the application object has failed.

#### *get\_update*

This operation obtains an update from the application object on which it is invoked. The **get\_update()** operation is invoked by the Logging Mechanism.

When the the Logging Mechanism invokes **get\_update()**, the application object returns the update. For each retrieval of an update, the Logging Mechanism invokes **get\_update()** only once, and the update that is returned is the update at the time **get\_update()** is invoked.



**State** `get_update()`  
**raises**(`NoUpdateAvailable`);

*Return Value*

An update for the application object on which the operation is invoked.

*Exception*

`NoUpdateAvailable` if an update is not available.

#### 23.5.4.4 *set\_update*

This method applies an update to the application object on which it is invoked. The operation is invoked by the Recovery Mechanism. When the Recovery Mechanism invokes **set\_update()**, it transfers the update to the application object.

**void set\_update(in State s)**  
**raises**(`InvalidUpdate`);

*Parameters*

|   |                                                                                                                                                                                                      |
|---|------------------------------------------------------------------------------------------------------------------------------------------------------------------------------------------------------|
| s | The update to be applied to the application object on which the operation is invoked. If the exception is raised, the Fault Tolerance Infrastructure assumes that the application object has failed. |
|---|------------------------------------------------------------------------------------------------------------------------------------------------------------------------------------------------------|

*Exception*

`InvalidUpdate` if the parameter s is not a valid update.

### 23.5.5 *Use Case*

#### 23.5.5.1 *Infrastructure-Controlled Consistency Style*

For the **COLD\_PASSIVE ReplicationStyle** and the **PULL FaultMonitoringStyle**, the interactions between the various components of the Fault Tolerance Infrastructure are typically as follows:

1. The Pull Monitor invokes **is\_alive()** on the primary member of the object group and the primary responds.
2. The primary fails.
3. The Pull Monitor invokes **is\_alive()** on the primary member of the object group and the primary does not respond.
4. The Pull Monitor incurs a timeout and reports to the Fault Notifier that the primary is faulty.
5. The Fault Notifier notifies the Replication Manager that the primary is faulty.

6. The Replication Manager determines the object group containing the primary, and the Replication Style of the object group.
7. The Replication Manager invokes the Fault Tolerance Infrastructure to remove the failed primary from the object group.
8. If the number of members of the object group is now less than the minimum number of replicas for this object group, the Replication Manager initiates the creation of a new member of the object group.
9. If the backup is not yet loaded, the Replication Manager invokes an operation of the Fault Tolerance Infrastructure to load the backup.
10. The Replication Manager then invokes an operation of the Fault Tolerance Infrastructure to set the new primary for the object group.
11. The Replication Manager invokes an operation of the Recovery Mechanism to activate the new primary.
12. The Recovery Mechanism accesses the log and extracts the most recent state message for the previous primary and the subsequent request and reply messages.
13. The Recovery Mechanism invokes **set\_state()** from the request and reply messages on the new primary.
14. The Recovery Mechanism returns a reply to the Replication Manager's invocation of activate.
15. The Replication Manager invokes the Pull Monitor to start monitoring the new primary.

## 23.6 Consolidated IDL

### 23.6.1 OMG IDL

```

#ifndef _FT_IDL_
#define _FT_IDL_

import ::TimeBase;
import ::CosNaming;
import ::CosEventComm;
import ::CosNotification;
import ::IOP;
import ::GIOP;
import ::CORBA;

#pragma prefix "omg.org"

module FT {
 typeprefix FT "omg.org";
 // Specification for Interoperable Object Group References

```

```

typedef string FTDomainId;
typedef unsigned long long ObjectGroupId;
typedef unsigned long ObjectGroupRefVersion;

struct TagFTGroupTaggedComponent { // tag = TAG_FT_GROUP;
 GIOP::Version version;
 FTDomainId ft_domain_id;
 ObjectGroupId object_group_id;
 ObjectGroupRefVersion object_group_ref_version;
};

struct TagFTPrimaryTaggedComponent { // tag = TAG_FT_PRIMARY;
 boolean primary;
};

// Specification for Most Recent Object Group Reference
struct FTGroupVersionServiceContext { //context_id = FT_GROUP_VERSION;
 ObjectGroupRefVersion object_group_ref_version;
};

// Specification for Transparent Reinvocation
const CORBA::PolicyType REQUEST_DURATION_POLICY = 47;

struct FTRequestServiceContext { // context_id = FT_REQUEST;
 string client_id;
 long retention_id;
 TimeBase::TimeT expiration_time;
};

interface RequestDurationPolicy : CORBA::Policy {
 readonly attribute TimeBase::TimeT request_duration_value;
};

// Specification for Transport Heartbeats
const CORBA::PolicyType HEARTBEAT_POLICY = 48;
const CORBA::PolicyType HEARTBEAT_ENABLED_POLICY = 49;

struct TagFTHeartbeatEnabledTaggedComponent {
 // tag = TAG_FT_HEARTBEAT_ENABLED;
 boolean heartbeat_enabled;
};

struct HeartbeatPolicyValue {
 boolean heartbeat;
 TimeBase::TimeT heartbeat_interval;
 TimeBase::TimeT heartbeat_timeout;
};
interface HeartbeatPolicy : CORBA::Policy {
 readonly attribute HeartbeatPolicyValue heartbeat_policy_value;
};

```

```

interface HeartbeatEnabledPolicy : CORBA::Policy {
 readonly attribute boolean heartbeat_enabled_policy_value;
};

// Specification of Common Types and Exceptions for ReplicationManager
interface GenericFactory;
interface FaultNotifier;

typedef CORBA::RepositoryId TypedId;
typedef Object ObjectGroup;

typedef CosNaming::Name Name;
typedef any Value;
struct Property {
 Name nam;
 Value val;
};
typedef sequence<Property> Properties;

typedef Name Location;
typedef sequence<Location> Locations;
typedef Properties Criteria;

struct FactoryInfo {
 GenericFactory the_factory;
 Location the_location;
 Criteria the_criteria;
};
typedef sequence<FactoryInfo> FactoryInfos;

typedef unsigned short ReplicationStyleValue;
const ReplicationStyleValue STATELESS = 0;
const ReplicationStyleValue COLD_PASSIVE = 1;
const ReplicationStyleValue WARM_PASSIVE = 2;
const ReplicationStyleValue ACTIVE = 3;
const ReplicationStyleValue ACTIVE_WITH_VOTING = 4;

typedef unsigned short MembershipStyleValue;
const MembershipStyleValue MEMB_APP_CTRL = 0;
const MembershipStyleValue MEMB_INF_CTRL = 1;

typedef unsigned short ConsistencyStyleValue;
const ConsistencyStyleValue CONS_APP_CTRL = 0;
const ConsistencyStyleValue CONS_INF_CTRL = 1;

typedef unsigned short FaultMonitoringStyleValue;
const FaultMonitoringStyleValue PULL = 0;
const FaultMonitoringStyleValue PUSH = 1;
const FaultMonitoringStyleValue NOT_MONITORED = 2;

typedef unsigned short FaultMonitoringGranularityValue;

```

```

const FaultMonitoringGranularityValue MEMB = 0;
const FaultMonitoringGranularityValue LOC = 1;
const FaultMonitoringGranularityValue LOC_AND_TYPE = 2;

typedef FactoryInfos FactoriesValue;

typedef unsigned short InitialNumberReplicasValue;
typedef unsigned short MinimumNumberReplicasValue;

struct FaultMonitoringIntervalAndTimeoutValue {
 TimeBase::TimeT monitoring_interval;
 TimeBase::TimeT timeout;
};

typedef TimeBase::TimeT CheckpointIntervalValue;

exception InterfaceNotFound {};
exception ObjectGroupNotFound {};
exception MemberNotFound {};
exception ObjectNotFound {};
exception MemberAlreadyPresent {};
exception BadReplicationStyle {};
exception ObjectNotCreated {};
exception ObjectNotAdded {};
exception PrimaryNotSet {};
exception UnsupportedProperty {
 Name nam;
 Value val;
};
exception InvalidProperty {
 Name nam;
 Value val;
};
exception NoFactory
 Location the_location;
 Typeld type_id;
};
exception InvalidCriteria {
 Criteria invalid_criteria;
};
exception CannotMeetCriteria {
 Criteria unmet_criteria;
};

// Specification of PropertyManager Interface
// which ReplicationManager Inherits
interface PropertyManager {
 void set_default_properties(in Properties props)
 raises (InvalidProperty,
 UnsupportedProperty);
 Properties get_default_properties();
};

```

```

void remove_default_properties(in Properties props)
 raises (InvalidProperty,
 UnsupportedProperty);

void set_type_properties(in Typed type_id,
 in Properties overrides)
 raises (InvalidProperty,
 UnsupportedProperty);

Properties get_type_properties(in Typed type_id);

void remove_type_properties(in Typed type_id,
 in Properties props)
 raises (InvalidProperty,
 UnsupportedProperty);

void set_properties_dynamically(in ObjectGroup object_group,
 in Properties overrides)
 raises(ObjectGroupNotFound,
 InvalidProperty,
 UnsupportedProperty);

Properties get_properties(in ObjectGroup object_group)
 raises(ObjectGroupNotFound);
};

// Specification of ObjectGroupManager Interface
// which ReplicationManager Inherits
interface ObjectGroupManager {
 ObjectGroup create_member(in ObjectGroup object_group,
 in Location the_location,
 in Typed type_id,
 in Criteria the_criteria)
 raises(ObjectGroupNotFound,
 MemberAlreadyPresent,
 NoFactory,
 ObjectNotCreated,
 InvalidCriteria,
 CannotMeetCriteria);

 ObjectGroup add_member(in ObjectGroup object_group,
 in Location the_location,
 in Object member)
 raises(ObjectGroupNotFound,
 MemberAlreadyPresent,
 ObjectNotAdded);

 ObjectGroup remove_member(in ObjectGroup object_group,
 in Location the_location)
 raises(ObjectGroupNotFound,

```

```

 MemberNotFound);

ObjectGroup set_primary_member(in ObjectGroup object_group,
 in Location the_location)
 raises(ObjectGroupNotFound,
 MemberNotFound,
 PrimaryNotSet,
 BadReplicationStyle);

Locations locations_of_members(in ObjectGroup object_group)
 raises(ObjectGroupNotFound);

ObjectGroupId get_object_group_id(in ObjectGroup object_group)
 raises(ObjectGroupNotFound);

ObjectGroup get_object_group_ref(in ObjectGroup object_group)
 raises(ObjectGroupNotFound);

Object get_member_ref(in ObjectGroup object_group,
 in Location loc)
 raises(ObjectGroupNotFound,
 MemberNotFound);
};

// Specification of GenericFactory Interface
// which ReplicationManager Inherits and Application Objects Implement
interface GenericFactory {
 typedef any FactoryCreationId;

 Object create_object(in Typed type_id,
 in Criteria the_criteria,
 out FactoryCreationId factory_creation_id)
 raises (NoFactory,
 ObjectNotCreated,
 InvalidCriteria,
 InvalidProperty,
 CannotMeetCriteria);

 void delete_object(in FactoryCreationId factory_creation_id)
 raises (ObjectNotFound);
};

// Specification of ReplicationManager Interface
interface ReplicationManager : PropertyManager, ObjectGroupManager,
 GenericFactory {
 void register_fault_notifier(in FaultNotifier fault_notifier);

 FaultNotifier get_fault_notifier()
 raises (InterfaceNotFound);
};

```

```
// Specifications for Fault Management
// Specification of PullMonitorable Interface
// which Application Objects Inherit
interface PullMonitorable {
 boolean is_alive();
};

// Specification of FaultNotifier Interface
interface FaultNotifier {
 typedef unsigned long long ConsumerId;

 void push_structured_fault(
 in CosNotification::StructuredEvent event);

 void push_sequence_fault(
 in CosNotification::EventBatch events);

 ConsumerId connect_structured_fault_consumer(
 in CosNotifyComm::StructuredPushConsumer push_consumer);

 ConsumerId connect_sequence_fault_consumer(
 in CosNotifyComm::SequencePushConsumer push_consumer);

 void disconnect_consumer(in ConsumerId connection)
 raises(CosEventComm::Disconnected);

 void replace_constraint(in ConsumerId connection,
 in CosNotification::EventTypeSeq event_types,
 in string constr_expr);
};

// Specifications for Logging and Recovery
typedef sequence<octet> State;

exception NoStateAvailable {};
exception InvalidState {};
exception NoUpdateAvailable {};
exception InvalidUpdate {};

// Specification of Checkpointable Interface
// which Updateable and Application Objects Inherit
interface Checkpointable {
 State get_state()
 raises(NoStateAvailable);

 void set_state(in State s)
 raises(InvalidState);
};

// Specification of Updateable Interface
// which Application Objects Inherit
```



---

```
interface Updateable : Checkpointable {
 State get_update()
 raises(NoUpdateAvailable);

 void set_update(in State s)
 raises(InvalidUpdate);
};
#endif // for #ifndef _FT_IDL
```

## Appendix A Glossary

### A.1 List of Terms

|                                           |                                                                                                                                                                                                                                                                                                                                                                                                                                                                                                                                                                                                                                      |
|-------------------------------------------|--------------------------------------------------------------------------------------------------------------------------------------------------------------------------------------------------------------------------------------------------------------------------------------------------------------------------------------------------------------------------------------------------------------------------------------------------------------------------------------------------------------------------------------------------------------------------------------------------------------------------------------|
| <b>Active Replication</b>                 | All of the members of an object group independently execute the methods invoked on the object, so that if a fault prevents one replica from operating correctly, the other replicas will produce the required results without the delay incurred by recovery.                                                                                                                                                                                                                                                                                                                                                                        |
| <b>Active Replication with Voting</b>     | Active replication where the requests (replies) from the members of a client (server) object group are voted, and are delivered to the members of the server (client) object group only if a majority of the requests (replies) are identical.                                                                                                                                                                                                                                                                                                                                                                                       |
| <b>Application-Controlled Consistency</b> | A <b>ConsistencyStyle</b> in which the application is responsible for checkpointing, logging, activation and recovery, and for maintaining whatever kind of consistency is appropriate for the application.                                                                                                                                                                                                                                                                                                                                                                                                                          |
| <b>Application-Controlled Membership</b>  | A <b>MembershipStyle</b> in which the application, or an application-level manager, can create a member of the object group and then invoke the <b>add_member()</b> operation of the <b>ObjectGroupManager</b> interface to cause the Replication Manager to add the member to the group. Alternatively, the application can invoke the <b>create_member()</b> operation of the <b>ObjectGroupManager</b> interface to cause the Replication Manager to create the member and add it to the object group. The application is responsible for enforcing the <b>InitialNumberReplicas</b> and <b>MinimumNumberReplicas</b> properties. |
| <b>Backup Member</b>                      | In passive replication, a member of an object group that does not execute the methods invoked on the object group but is available to assume the role of the primary member in the event of a fault.                                                                                                                                                                                                                                                                                                                                                                                                                                 |
| <b>Byzantine Fault</b>                    | A form of commission fault that occurs when an object or host generates incorrect results maliciously.                                                                                                                                                                                                                                                                                                                                                                                                                                                                                                                               |

---

|                                 |                                                                                                                                                                                                                                                                                                                                                                                                                                                                                                                                                                                                                                  |
|---------------------------------|----------------------------------------------------------------------------------------------------------------------------------------------------------------------------------------------------------------------------------------------------------------------------------------------------------------------------------------------------------------------------------------------------------------------------------------------------------------------------------------------------------------------------------------------------------------------------------------------------------------------------------|
| <b>Causal Order</b>             | <p>Causal order ensures that if a multicast message m1 could have caused, possibly indirectly, a message m2 then no object receives m2 before it receives m1. The <i>causally precedes</i> relation is the transitive closure of:</p> <ul style="list-style-type: none"><li>• If message m1 is delivered to object replica O before O sends message m2, then m1 causally precedes m2.</li><li>• If object replica O sends message m1 before message m2, then m1 causally precedes m2.</li><li>• If both m1 and m2 are delivered to object replica O, and m1 causally precedes m2, then m1 is delivered to O before m2.</li></ul> |
| <b>Checkpoint</b>               | <p>A snapshot of the state of an object.</p>                                                                                                                                                                                                                                                                                                                                                                                                                                                                                                                                                                                     |
| <b>Checkpoint Interval</b>      | <p>An interval of time (in seconds and nanoseconds) between writing the full state of an object to a log.</p>                                                                                                                                                                                                                                                                                                                                                                                                                                                                                                                    |
| <b>Cold Passive Replication</b> | <p>A form of passive replication in which only one replica, the primary replica, in the object group executes the methods invoked on the object. The state of the primary replica is extracted from the log and is loaded into the backup replica when needed for recovery.</p>                                                                                                                                                                                                                                                                                                                                                  |
| <b>Commission Fault</b>         | <p>A commission fault occurs when an object or host generates incorrect results. Commission faults must be handled by active replication with majority voting.</p>                                                                                                                                                                                                                                                                                                                                                                                                                                                               |
| <b>ConsistencyStyle</b>         | <p>The value of the ConsistencyStyle is either <b>CONS_INF_CTRL</b> or <b>CONS_APP_CTRL</b>.</p>                                                                                                                                                                                                                                                                                                                                                                                                                                                                                                                                 |
| <b>Distributed Logging</b>      | <p>A logging strategy in which a co-located log is maintained for each replica of an object.</p>                                                                                                                                                                                                                                                                                                                                                                                                                                                                                                                                 |
| <b>Duplicates</b>               | <p>Duplicate requests and duplicate replies can arise in active replication and in passive replication when the primary fails and a new primary is introduced. To maintain exactly once semantics and strong replica consistency, the Fault Tolerance Infrastructure provides mechanisms to detect and suppress duplicates.</p>                                                                                                                                                                                                                                                                                                  |
| <b>Failure</b>                  | <p>A failure is the event of a system's generating a result that does not satisfy the system specification or not generating a result that is required by the system specification. A failure is defined by the system specification, without reference to any enclosing system of which the system is a component.</p>                                                                                                                                                                                                                                                                                                          |
| <b>Fault</b>                    | <p>A fault is behavior of a component of a system that causes incorrect behavior of the system. A fault is the external manifestation of a failure of the component.</p>                                                                                                                                                                                                                                                                                                                                                                                                                                                         |

|                                          |                                                                                                                                                                                                                                                                                                                                                                          |
|------------------------------------------|--------------------------------------------------------------------------------------------------------------------------------------------------------------------------------------------------------------------------------------------------------------------------------------------------------------------------------------------------------------------------|
| <b>Fault Analyzer</b>                    | A component of the Fault Tolerance Infrastructure that registers for fault notifications and aggregates multiple related fault notifications into a single fault report.                                                                                                                                                                                                 |
| <b>Fault Containment Region</b>          | One or more locations that can be affected by a single fault. Each member of an object group is assigned to a different fault containment region to ensure that, if one member incurs a fault, the other members are not affected.                                                                                                                                       |
| <b>Fault Monitor</b>                     | A component of the system, also known as a Fault Detector, that monitors the occurrence of faults in other entities, such as objects, hosts, processes, and networks. Fault detectors are typically based on timeouts and are unreliable (inaccurate) because they cannot determine whether an entity has failed or is merely slow.                                      |
| <b>FaultMonitoringGranularity</b>        | The value of the <b>FaultMonitoringGranularity</b> of an object group is either <b>MEMB</b> , <b>LOC</b> , or <b>LOC_AND_TYPE</b> . The <b>FaultMonitoringGranularity</b> provides a means of scalably monitoring the members of many object groups.                                                                                                                     |
| <b>FaultMonitoringIntervalAndTimeout</b> | The value of the <b>FaultMonitoringIntervalAndTimeout</b> is a structure that contains an interval of time between successive pings of an object, and the time allowed for subsequent responses from the object to determine whether it is faulty.                                                                                                                       |
| <b>FaultMonitoringStyle</b>              | The value of the <b>FaultMonitoringStyle</b> is either <b>PULL</b> , <b>PUSH</b> , or <b>NOT_MONITORED</b> .                                                                                                                                                                                                                                                             |
| <b>Fault Tolerance</b>                   | The ability to provide continuous service, unperturbed by the presence of faults. In contrast, with high availability, existing operations can be disrupted by a fault but subsequent new operations, or retired existing operations, are serviced.                                                                                                                      |
| <b>Fault Tolerance Domain</b>            | For scalability, large applications are divided into multiple fault tolerance domains, each managed by a single Replication Manager. The members of an object group are located within a single fault tolerance domain but can invoke, or can be invoked by, objects of other fault tolerance domains. A host can support objects from multiple fault tolerance domains. |
| <b>Fault Transparency</b>                | A server object group is fault transparent to a client object if, in the presence of a faulty server replica, the server object group interacts with the client object as if there were no faults.                                                                                                                                                                       |

|                                              |                                                                                                                                                                                                                                                                                                                                                                                                                           |
|----------------------------------------------|---------------------------------------------------------------------------------------------------------------------------------------------------------------------------------------------------------------------------------------------------------------------------------------------------------------------------------------------------------------------------------------------------------------------------|
| <b>Gateway</b>                               | A gateway provides access into a fault tolerance domain for objects outside that domain, and provides protocol conversion between the IIOP protocol used outside the fault tolerance domain and the group communication protocol used inside that domain.                                                                                                                                                                 |
| <b>GenericFactory</b>                        | An interface of the Replication Manager that creates object groups, as well as individual members of object groups.                                                                                                                                                                                                                                                                                                       |
| <b>Group Communication Protocol</b>          | A protocol that provides communication between object groups, typically multicasting, reliable delivery, causal ordering, total ordering, group membership, and virtual synchrony.                                                                                                                                                                                                                                        |
| <b>Group Membership</b>                      | The set of members of a group, which may change dynamically in time, as members fail and are removed from the group and as new and recovered members are added.                                                                                                                                                                                                                                                           |
| <b>FT_GROUP_VERSION Service Context</b>      | A service context, included in a request message, that allows a server to determine whether the client is using an obstacle object group reference and, if so, to return a <b>LOCATION_FORWARD_PERM</b> response that contains the most recent object reference for the server object group.                                                                                                                              |
| <b>HEARTBEAT_POLICY</b>                      | A client-side policy that allows a client to request heartbeating to determine that its connection to a server has failed.                                                                                                                                                                                                                                                                                                |
| <b>HEARTBEAT_ENABLED_POLICY</b>              | A server-side policy that allows a client to determine that its connection to a server has failed.                                                                                                                                                                                                                                                                                                                        |
| <b>Incremental State Transfer</b>            | A form of state transfer that is used for transferring large states of an object in fragments.                                                                                                                                                                                                                                                                                                                            |
| <b>Infrastructure-Controlled Consistency</b> | A <b>ConsistencyStyle</b> in which the Fault Tolerance Infrastructure is responsible for checkpointing, logging, activation and recovery and for maintaining Strong Replica Consistency.                                                                                                                                                                                                                                  |
| <b>Infrastructure-Controlled Membership</b>  | A <b>MembershipStyle</b> in which the application directs the Replication Manager to create the object group and the Replication Manager invokes the individual factories, for the appropriate locations, to create the members of the object group both initially to satisfy the <b>InitialReplicas</b> property and after the loss of a member because of a fault to satisfy the <b>MinimumNumberReplicas</b> property. |

|                                      |                                                                                                                                                                                                                                                                                                                                                                                                   |
|--------------------------------------|---------------------------------------------------------------------------------------------------------------------------------------------------------------------------------------------------------------------------------------------------------------------------------------------------------------------------------------------------------------------------------------------------|
| <b>InitialNumberReplicas</b>         | The <b>InitialNumberReplicas</b> property of an object group specifies the number of replicas of the object to be created when the object group is first created.                                                                                                                                                                                                                                 |
| <b>Location</b>                      | A set of hosts that form a single fault containment region. Members of object groups are created at different locations.                                                                                                                                                                                                                                                                          |
| <b>Log</b>                           | A record of messages and object states that is created to ensure that recovery is possible after a fault.                                                                                                                                                                                                                                                                                         |
| <b>LoggingMechanism</b>              | A component of the Fault Tolerance Infrastructure that records all of the actions of an object group in a log.                                                                                                                                                                                                                                                                                    |
| <b>MembershipStyle</b>               | The value of the <b>MembershipStyle</b> of an object group is either <b>MEMB_INF_CTRL</b> or <b>MEMB_APP_CTRL</b> .                                                                                                                                                                                                                                                                               |
| <b>Membership Handling Mechanism</b> | A component of the Fault Tolerance Infrastructure that ensures that GIOP messages addressed to object groups are delivered to the appropriate members of those groups. It detects and suppresses duplicate messages, passes messages to the Logging Mechanism to put into the log, and applies to the objects messages that the Recovery Mechanism has retrieved from the log.                    |
| <b>MinimumNumberReplicas</b>         | The <b>MinimumNumberReplicas</b> property of an object group specifies the smallest number of replicas of the object needed to maintain the desired fault tolerance. The application or the Replication Manager creates additional replicas of the object to ensure that the number of replicas does not fall below the specified minimum number.                                                 |
| <b>Multicasting</b>                  | For replicated client and server objects, messages are originated by a client (server) within a client (server) object group and are multicast to the client and server object groups. Messages are delivered to the members of both the client and server object groups to facilitate the detection and suppression of duplicates.                                                               |
| <b>Object Group</b>                  | A set of member objects, each of which implements the same set of interfaces and has the same implementation code.                                                                                                                                                                                                                                                                                |
| <b>ObjectGroupManager</b>            | An interface of the Replication Manager that contains operations for creating a member of an object group at a particular location, adding a member to an object group at a particular location, removing a member from an object group at a particular location, getting the locations of the members of an object group, and setting the primary member of a passively replicated object group. |

---

|                               |                                                                                                                                                                                                                                                                                                                                                                                                                                                                                                                                                                                                                                                                                         |
|-------------------------------|-----------------------------------------------------------------------------------------------------------------------------------------------------------------------------------------------------------------------------------------------------------------------------------------------------------------------------------------------------------------------------------------------------------------------------------------------------------------------------------------------------------------------------------------------------------------------------------------------------------------------------------------------------------------------------------------|
| <b>Object Group Reference</b> | An interoperable object reference that contains multiple <b>TAG_INTERNET_IOP</b> profiles that represent primary and backup members of a passively replicated object group or that represent gateways. All of the <b>TAG_INTERNET_IOP</b> profiles contain a <b>TAG_FT_GROUP</b> component that contains the fault tolerance domain identifier, object group identifier, and object group reference version number for the server object group. If the profiles are those of members of a passively replicated server object group, then one of the profiles contains the <b>TAG_FT_PRIMARY</b> component for the profile that addresses the primary member of the server object group. |
| <b>Passive Replication</b>    | Only the primary member of an object group executes the methods that have been invoked on the object group. The object group contains additional backup replicas.                                                                                                                                                                                                                                                                                                                                                                                                                                                                                                                       |
| <b>Primary Member</b>         | In passive replication, the member of an object group that executes the methods invoked on the object group.                                                                                                                                                                                                                                                                                                                                                                                                                                                                                                                                                                            |
| <b>Property Manager</b>       | An interface of the Replication Manager that contains operations for setting and getting the fault tolerance properties.                                                                                                                                                                                                                                                                                                                                                                                                                                                                                                                                                                |
| <b>Pull Monitor</b>           | A Fault Monitor that interrogates the monitored object periodically to determine whether it is alive.                                                                                                                                                                                                                                                                                                                                                                                                                                                                                                                                                                                   |
| <b>Push Monitor</b>           | A Fault Monitor to which the monitored object periodically reports that it is alive.                                                                                                                                                                                                                                                                                                                                                                                                                                                                                                                                                                                                    |
| <b>Recovery</b>               | The restoration of the state of a member of an object group so that it can continue the operation of the object group.                                                                                                                                                                                                                                                                                                                                                                                                                                                                                                                                                                  |
| <b>Recovery Mechanism</b>     | A component of the Fault Tolerance Infrastructure that sets the state of a member of an object group, either when a backup member is promoted to be the primary member after a fault occurs, or alternatively when a new member is introduced into the group.                                                                                                                                                                                                                                                                                                                                                                                                                           |
| <b>Reliable Delivery</b>      | Every message addressed to a group, or originated by a group, is delivered to every member of the group, except for members suspected of being faulty.                                                                                                                                                                                                                                                                                                                                                                                                                                                                                                                                  |
| <b>Replica Determinism</b>    | Replica determinism requires that two or more members of an object group, when presented with the same sequence of requests and replies, behave in exactly the same manner.                                                                                                                                                                                                                                                                                                                                                                                                                                                                                                             |
| <b>Replication</b>            | The fundamental technique used in building fault-tolerant systems.                                                                                                                                                                                                                                                                                                                                                                                                                                                                                                                                                                                                                      |

|                                      |                                                                                                                                                                                                                                                                                                                                                                                                                                                           |
|--------------------------------------|-----------------------------------------------------------------------------------------------------------------------------------------------------------------------------------------------------------------------------------------------------------------------------------------------------------------------------------------------------------------------------------------------------------------------------------------------------------|
| <b>Replication Manager</b>           | A component of the Fault Tolerance Infrastructure that provides access to the Fault Notifier and that inherits three interfaces. <b>PropertyManager</b> , <b>GenericFactory</b> and <b>ObjectGroupManager</b> . Logically, there is one Replication Manager per fault tolerance domain. The Replication Manager interacts with the Fault Monitors and Fault Notifier, and with the Logging and Recovery Mechanisms of the Fault Tolerance Infrastructure. |
| <b>ReplicationStyle</b>              | The value of the ReplicationStyle of an object group is either <b>STATELESS</b> , <b>COLD_PASSIVE</b> , <b>WARM_PASSIVE</b> , <b>ACTIVE</b> , or <b>ACTIVE_WITH_VOTING</b> .                                                                                                                                                                                                                                                                              |
| <b>Replication Transparency</b>      | A client object is unaware that it is interacting with a group of server objects, but rather “thinks” that it is interacting with an individual server object.                                                                                                                                                                                                                                                                                            |
| <b>Repository Identifier</b>         | The identifier of a type within the Interface Repository.                                                                                                                                                                                                                                                                                                                                                                                                 |
| <b>REQUEST_DURATION_POLICY</b>       | A client-side policy that defines the time interval over which a client’s request to a server remains valid and should be retained by the server ORB to detect repeated requests.                                                                                                                                                                                                                                                                         |
| <b>FT_REQUEST Service Context</b>    | A service context, included in a request message, that allows a server to detect and suppress duplicate requests and to garbage collect requests that are obsolete.                                                                                                                                                                                                                                                                                       |
| <b>Shared Logging</b>                | A logging strategy in which the primary member of an object group logs its state by writing the log records onto stable storage.                                                                                                                                                                                                                                                                                                                          |
| <b>State Transfer</b>                | In both passive and active replication, when a new or recovered member of an object group is activated, a state transfer is required to transfer the state of the object to the new or recovered member, so that the new or recovered member will have the same state as the other members of the object group.                                                                                                                                           |
| <b>Stateless Object</b>              | The behavior of a stateless object is unaffected by its history of invocations. A typical example of a stateless object is a server that provides read-only access to a database.                                                                                                                                                                                                                                                                         |
| <b>Strong Membership Consistency</b> | Strong Membership Consistency means that, for each method invocation on an object group, the Fault Tolerance Infrastructure on all hosts agree on the membership of the object group.                                                                                                                                                                                                                                                                     |



**Strong Replica Consistency**

For passive replication, Strong Replica Consistency means that, at the end of each state transfer, each of the members of the object group have the same state. For active replication, Strong Replica Consistency means that, at the end of each method invocation on the object group, each of the members of the object group have the same state.

**TAG\_FT\_GROUP Component**

A component of all of the profiles of the Object Group Reference that contains the fault tolerance domain identifier, object group identifier, and object group reference version number of the server object group with that reference.

**TAG\_FT\_HEARTBEAT\_ENABLED Component**

A component of a **TAG\_INTERNET\_IOP** profile of an object group reference that indicates that a member of a server object group, or gateway, is heartbeat enabled.

**TAG\_FT\_PRIMARY Component**

A component of one of the **TAG\_INTERNET\_IOP** profiles of an object group reference that is intended to address the primary member of the object group, and that indicates that this **TAG\_INTERNET\_IOP** profile should be used in preference to other **TAG\_INTERNET\_IOP** profiles within the object group reference.

**Total Order**

The *ordered before* relation is the transitive closure of:

- If message m1 is delivered to object replica O before message m2 is delivered to O, then m1 is ordered before m2.
- If message m1 precedes message m2, then m1 is ordered before m2.
- If both m1 and m2 are delivered to object replica O, and m1 is ordered before m2, then m1 is delivered to O before m2 is delivered to O.

The ordered before relation is acyclic.

**Unique Primary Replica**

For passive replication, one and only one member of the object group executes the methods invoked on the object group.

**Unreplicated Client Object**

An unreplicated client object communicates with a replicated server object using IIOP. The client may communicate directly with a member of the server object group or, if multicasting is provided, the client may communicate with a gateway, which then multicasts the message to the server object group.

**Virtual Synchrony**

If object replicas O1 and O2 are in the same view of the object group membership M and they transition together to the next view of the object group membership M', then the same messages are delivered to O1 and O2 while they are members of M. Virtual synchrony is used to ensure that a state transfer to initialize a new member of object group membership M occurs at the point in the message order corresponding to a membership change. Thus, at the start of the next view of the object group membership M', all of the members in M' will have the same state.

**Warm Passive Replication**

A form of passive replication in which only the primary member executes the methods invoked on the object group by the client objects. Several other members operate as backups. The backups do not execute the methods invoked on the object group; rather, the state of the primary is transferred to the backups periodically.

## Appendix B Compliance

### B.1 Compliance Points

#### *B.1.1 Fault Tolerant CORBA Passive Replication Compliance Point*

This compliance point requires support of all specifications defined previously. However, the implementation of these specifications need only support the semantics for the **STATELESS**, **COLD\_PASSIVE**, and **WARM\_PASSIVE** values of the **ReplicationStyle** property.

#### *B.1.2 Fault Tolerant CORBA Active Replication Compliance Point*

This compliance point requires support of all specifications defined previously. However, the implementation of these specifications need only support the semantics for the **STATELESS** and **ACTIVE** values of the **ReplicationStyle** property.



This chapter defines the CORBA Security Attribute Service (SAS) protocol and its use within the CSIv2 architecture to address the requirements of CORBA security for interoperable authentication, delegation, and privileges.

## Contents

This chapter contains the following sections.

| Section Title                         | Page  |
|---------------------------------------|-------|
| “Overview”                            | 24-1  |
| “Protocol Message Definitions”        | 24-4  |
| “Security Attribute Service Protocol” | 24-16 |
| “Transport Security Mechanisms”       | 24-31 |
| “Interoperable Object References”     | 24-32 |
| “Conformance Levels”                  | 24-45 |
| “Sample Message Flows and Scenarios”  | 24-48 |
| “References for this Chapter”         | 24-57 |
| “IDL”                                 | 24-58 |

## 24.1 Overview

The SAS protocol is designed to exchange its protocol elements in the service context of GIOP request and reply messages that are communicated over a connection-based transport. The protocol is intended to be used in environments where transport layer security, such as that available via SSL/TLS or SECIOP, is used to provide message

protection (that is, integrity and or confidentiality) and server-to-client authentication. The protocol provides client authentication, delegation, and privilege functionality that may be applied to overcome corresponding deficiencies in an underlying transport.<sup>1</sup> The SAS protocol facilitates interoperability by serving as the higher-level protocol under which secure transports may be unified.

The SAS protocol is divided into two layers:

- The authentication layer is used to perform client authentication where sufficient authentication could not be accomplished in the transport.
- The attribute layer may be used by a client to push (that is, deliver) security attributes (identity and privilege) to a target where they may be applied in access control decisions.

The attribute layer also provides a means for a client to assert identity attributes that differ from the client's authentication identity (as established in the transport and/or SAS authentication layers). This identity assertion capability is the foundation of a general-purpose impersonation mechanism that makes it possible for an intermediate to act on behalf of some identity other than itself. An intermediate's authority to act on behalf of another identity may be based on trust by the target in the intermediate, or on trust by the target in a privilege authority that endorses the intermediate to act as proxy for the asserted identity. Identity assertion may be used by an intermediate to assume the identity of its callers in its calls.

The SAS protocol is modeled after the Generic Security Service API (GSSAPI) token exchange paradigm. A client initiates a context exchange by including a protocol element in the service context of its request that instructs the target to initiate a security context. The target either rejects or accepts the context.<sup>2</sup> When a target rejects a context, the target will reject the request and return an exception that contains a SAS protocol element that identifies the reason the context was rejected. When a target accepts a context, the reply to the request will carry a SAS protocol element that indicates that the context was accepted.

The SAS protocol element sent to initiate a security context carries layer-specific security tokens as necessary to establish the SAS authentication-layer and attribute-layer functionality corresponding to the context. Standard token formats are employed to represent the layer-specific authentication and attribute tokens. If the context includes SAS authentication-layer functionality, the protocol element will contain a mechanism-specific GSSAPI initial context token that authenticates the client to the target. If the context includes attribute-layer privilege attributes (and possibly proxy

- 
1. For example, the SSL/TLS protocol does not enforce client authentication. Moreover, in a given environment, certificate-based client authentication may not be feasible because clients often do not have a certificate.
  2. In the GSSAPI protocol, a target can challenge a client for additional context-establishment information. This is not true of the SAS context protocol, which assumes that at most one message in each direction may be used to establish a context.

endorsements), they will be contained in an attribute certificate signed by a privilege authority and corresponding to the subject of the invocation. If the context includes an attribute-layer identity assertion, the asserted identity will be represented in a standard name form corresponding to the technology domain of the asserted identity.

The SAS protocol supports the establishment of both transient and reusable security contexts. Transient contexts, also known as stateless contexts, exist only for the duration of the GIOP request that was used to establish the context. Reusable contexts, also known as stateful contexts, endure until they are discarded, and can be referenced for use with subsequent requests. The SAS protocol includes a simple negotiation protocol that defines a least-common-denominator form of interoperability between implementations that support only transient contexts and those that support both transient and reusable forms.

### 24.1.1 Assumptions

The SAS protocol was designed under the following assumptions:

- Secure interoperability is predicated on the use of a common transport-layer security mechanism, such as that provided by SSL/TLS.<sup>3</sup>
- The transport layer provides message protection as necessary to protect GIOP input and output request arguments.
- The transport layer provides target-to-client authentication as necessary to identify the target for the purpose of ensuring that the target is the intended target.
- Transport-layer security can ensure that the client does not have to issue a preliminary request to establish a confidential association with the intended target.<sup>4</sup>
- To support clients that cannot authenticate using transport-layer security mechanisms, the SAS protocol shall provide for client authentication above the transport layer.
- To support the formation of security contexts using GIOP service context, the SAS protocol shall require at most one message in each direction to establish a security context.
- The protocol shall support security contexts that exist only for the duration of a single request/reply pair.
- The protocol shall support security contexts that can be reused for multiple request/reply pairs.
- Targets cannot rely on clients to manage the lifecycle of reusable security contexts accepted by the target.

---

3. Transport security mechanisms include unprotected transports within trusted environments.

4. This assumption does not preclude the use of such mechanisms, but rather sustains the use of this protocol in environments where such mechanisms are not considered favorably.

- Clients that reuse security contexts shall be capable of processing replies that indicate that the context has been discarded by the target.

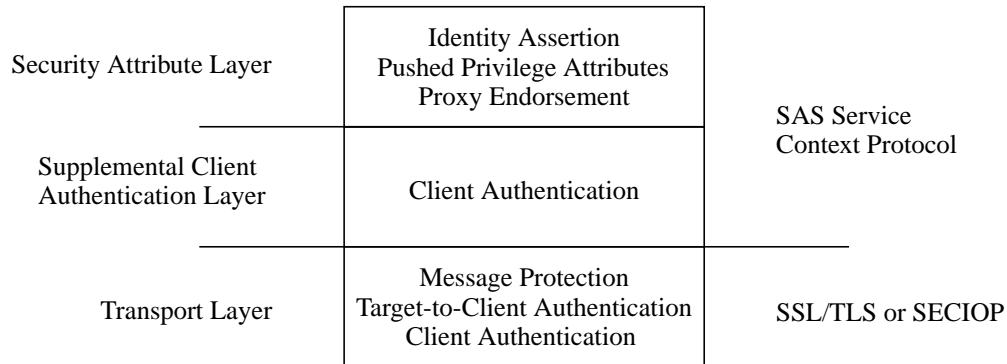

Figure 24-1 CSIV2 Security Architecture

## 24.2 Protocol Message Definitions

### 24.2.1 The Security Attribute Service Context Element

This specification defines a new GIOP service context element type, the security attribute service (SAS) element.

The SAS context element may be used to associate any or all of the following contexts with GIOP request and reply messages:

- Identity context, to be accepted based on trust
- Authorization context, including authorization-based delegation context
- Client authentication context

A new **context\_id** has been defined for the SAS element.

**const Serviced SecurityAttributeService = 15;**

The **context\_data** of a SAS element is an encapsulation octet stream containing a SAS message body marshalled according to the CDR encoding rules. The formats of the SAS message bodies are defined in the next section.

```
struct ServiceContext {
 Serviced context_id;
 sequence <octet> context_data;
};
```

At most one instance of this new service context element may be included in a GIOP request or reply.



## 24.2.2 SAS context\_data Message Body Types

Four message types comprise the security attribute service context management protocol. Each security attribute service context element shall contain a message body that carries one of the following message body types:

- **EstablishContext**  
Sent by a client security service (CSS) to establish a security attribute service context.
- **ContextError**  
Sent by a target security service (TSS) to indicate errors that were encountered in context creation, in the message protocol, or in use of a context.
- **CompleteEstablishContext**  
Sent by a target security service (TSS) to indicate the outcome of a successful request to establish a security attribute service context.
- **MessageInContext**  
Sent by a client security service (CSS) to associate request messages with an existing stateful security attribute service context. This message may also be used to indicate that the context should be discarded after processing the request.  
  
Stateful contexts, also known as reusable contexts, endure until they are discarded, and can be referenced for use with subsequent requests.

A client security service (CSS) is the security service associated with the ORB that is used by the client to invoke the target object. A target security service (TSS) is the security service associated with the ORB that hosts the target object.

### 24.2.2.1 EstablishContext Message Format

An **EstablishContext** message is sent by a CSS to establish a SAS context with a TSS. The SAS context and the context identifier allocated by the CSS to refer to it are scoped to the transport layer connection or association over which the CSS and TSS are communicating. When an association is dismantled, all SAS contexts scoped to the connection shall be invalidated and may be discarded. The **EstablishContext** message contains the following fields:

- **client\_context\_id**  
The CSS allocated identifier for the security attribute service context. A stateless CSS shall set the **client\_context\_id** to 0, indicating to the TSS that it is stateless. A stateful CSS may allocate a nonzero **client\_context\_id**. See Section 24.3.2.2, “Stateful/Reusable Contexts,” on page 24-22 for a definition of the rules governing the use and allocation of context identifiers.
- **authorization\_token**  
May be used by a CSS to “push” privilege information to a TSS. A CSS may use this token to send proxy privileges to a TSS as a means to enable the target to issue calls as the client.

- **identity\_token**

Carries a representation of the invocation identity for the call (that is, the identity under which the call is to be authorized). The **identity\_token** carries a representation of the invocation identity in one of the following forms:

- A typed mechanism-specific representation of a principal name
- A chain of identity certificates representing the subject and a chain of verifying authorities
- A distinguished name
- The anonymous principal identity (a type, not a name)

An **identity\_token** is used to assert a caller identity when that identity differs from the identity proven by authentication in the authentication layer(s). If the caller identity is intended to be the same as that established in the authentication layer(s), then it does not need to be asserted in an **identity\_token**.

- **client\_authentication\_token**

Carries a mechanism-specific GSS initial context token that authenticates the client to the TSS. It contains a mechanism type identifier and the mechanism-specific evidence (that is, the authenticator) required by the TSS to authenticate the client.

When an initial context token contains private credentials, such as a password, this message may be safely sent only after a confidential connection with a trusted TSS has been established. The determination of when it is safe to send a client authentication token in an **EstablishContext** message shall be considered in the context of the CORBA location-binding paradigm for persistent objects (where an invocation may be “location forwarded” by a location daemon to the target object). This issue is considered in Section 24.5.3, “Client-Side Requirements and Location Binding,” on page 24-44.

When a TSS is unable to validate a security attribute service context, the TSS shall not dispatch on the target object method invocation. The TSS shall reply with a **ContextError** message that carries major and minor codes indicating the reason for the failure.

If an **EstablishContext** message contains an identity token, then it is the responsibility of the TSS to extract a principal identity from the identity token and determine if the identity established in the authentication layer(s) is trusted to assert the extracted identity. If so, the asserted identity is used as the caller identity in the target’s authorization determination.

The processing of a request to establish a context that arrives on a one-way call shall be the same as an ordinary call, except that the TSS will not send an indication of the success (**CompleteEstablishContext**) or failure (**ContextError**) of the context validation.

### 24.2.2.2 *ContextError Message Format*

A **ContextError** message is sent by a TSS in response to an **EstablishContext** or **MessageInContext** message to indicate to the client that the TSS detected an error. Section 24.3.4, “CSS State Machine,” on page 24-27 defines the circumstances under which a TSS returns specific error values and exceptions. The **ContextError** message contains the following fields:

- **client\_context\_id**

The value of the **client\_context\_id** that identifies the CSS context in the **EstablishContext** or **MessageInContext** message in response to which the **ContextError** is being returned.

- **major\_status**

The reason the TSS rejected the context.

- **minor\_status**

A more specific error code that further defines the reason for rejection in the context of the major status.

- **error\_token**

A GSS mechanism-specific error token. When an **EstablishContext** message is rejected because it contains a **client\_authentication\_token** (a GSS initial context token) that is invalidated by the TSS, then depending on the mechanism, the TSS may return a CDR encapsulation of a mechanism-specific GSS error token in this field. Not all GSS mechanisms produce error tokens in response to initial context token validation failures.

In all circumstances where a TSS returns a **ContextError**, the GIOP request that carried the rejected SAS context shall not be dispatched by the target ORB.

### 24.2.2.3 *CompleteEstablishContext Message Format*

A **CompleteEstablishContext** message is sent by a TSS in response to an **EstablishContext** message to indicate that the context was established. The **CompleteEstablishContext** message contains the following fields:

- **client\_context\_id**

The CSS allocated identifier for the security attribute context. It is returned by the target so that a stateful CSS can link this message to the **EstablishContext** request. A TSS shall always return the value of the **client\_context\_id** it received in the **EstablishContext** message.

- **context\_stateful**

The value returned by the TSS to indicate whether or not the established context is stateful, and thus reusable. A stateless TSS shall always return false. A stateful TSS shall return true if the established context is reusable. Otherwise a stateful TSS shall return false.

- **final\_context\_token**

The GSS mechanism-specific final context token that is returned by a TSS if the client requests mutual authentication. When a TSS accepts an **EstablishContext** message containing an initial context token that requires mutual authentication, the TSS shall return a mechanism-specific final context token. Not all GSS mechanisms support mutual authentication, and thus not all responses to initial context tokens may include final (or output) context tokens.<sup>5</sup>

When a **CompleteEstablishContext** message contains a **final\_context\_token**, the token shall be applied (with **GSS\_Init\_sec\_context**) to the client-side GSS state machine.

Two or more stateful SAS contexts are equivalent if they are established over the same transport layer connection or association, have the same non-zero **client\_context\_id** and have byte-equivalent identity, authorization, and authentication tokens.

A multithreaded CSS may issue multiple concurrent requests to establish (that is, with an **EstablishContext** message) an equivalent stateful SAS context.

A TSS shall not create a duplicate stateful SAS context in response to a request to establish a context that is equivalent to an existing context.

A TSS shall return an exception containing a **ContextError** service context element if it receives a stateful **EstablishContext** message with a **client\_context\_id** that matches that of an existing context (established over the same transport layer connection or association) and for which any of the security tokens arriving in the message are not byte-equivalent to those recorded in the existing context. The request shall also be rejected. The exception and error values to be returned are defined in Section 24.3.4, "CSS State Machine," on page 24-27.

---

5. SAS layer authentication capabilities are designed to authenticate client to server where such authentication did not occur in the transport. The SAS protocol is predicated on server-to-client authentication having occurred in the transport layer, and in advance of the request. Server-to-client authentication in service context (which requires that the target return a **final\_context\_token**) is not the typical use model for SAS layer authentication capabilities.

Table 24-1 CompleteEstablishContext Message Semantics

| client_context_id in EstablishContext Message | client_context_id in CompleteEstablishContext Message | context_stateful in CompleteEstablishContext Message | Semantic                                                                                                                                                                             |
|-----------------------------------------------|-------------------------------------------------------|------------------------------------------------------|--------------------------------------------------------------------------------------------------------------------------------------------------------------------------------------|
| 0                                             | 0                                                     | False                                                | Client requested stateless context.                                                                                                                                                  |
| N != 0                                        | N                                                     | False                                                | TSS is stateless or TSS did not choose to remember context. In either case, if the client attempts to reuse the context (via MessageInContext) it should expect to receive an error. |
|                                               |                                                       | True                                                 | Stateful TSS accepted reusable context.                                                                                                                                              |

#### 24.2.2.4 MessageInContext Message Format

A **MessageInContext** message is used by a CSS that wishes to reuse an existing context with a request. A CSS may also use this message to release context that it has established with a stateful TSS. The **MessageInContext** message contains the following fields:

- **client\_context\_id**

The nonzero context identifier allocated by the client in the **EstablishContext** message used to create the context.

- **discard\_context**

A boolean value that indicates whether the CSS wishes the TSS to discard the context after it processes the request. A value of true indicates that the CSS wishes the context to be discarded, a value of false, indicates that it does not. The purpose of the **discard\_context** field is to allow a CSS to help a TSS manage the cleanup of reusable contexts.<sup>6</sup>

Any request message may be used to carry a **MessageInContext** message to a target. A TSS that receives a **MessageInContext** message shall complete the processing of the request before it discards the context (if **discard\_context** is set to true).

A TSS may receive a **MessageInContext** message that refers to a context that does not exist at the TSS. This can occur either because the context never existed at the TSS or because it has been discarded by the TSS. In either case, the TSS shall return an exception containing a **ContextError** service context element with major and minor

---

6.Stateful clients are under no obligation to manage TSS state, so their use of this message for that purpose is discretionary.

error codes indicating that the referenced context does not exist. The exception and error values to be returned are defined in Section 24.3.4, “CSS State Machine,” on page 24-27.

The processing of a **MessageInContext** message that arrives on a one-way call shall be the same as for an ordinary call, except that the TSS will not return a **ContextError** when the referenced context does not exist.

### 24.2.3 Authorization Token Format

The **authorization\_token** field of the **EstablishContext** message of the Security Attribute Service context element is used to carry a sequence (0 or more) of typed representations of authorization data. The **AuthorizationElementType** defines the contents and encoding of the contents of the **the\_element** field.

The high order 20-bits of each **AuthorizationElementType** constant shall contain the Vendor Minor Codeset ID (VMCID) of the organization that defined the element type. The low order 12 bits shall contain the organization-scoped element type identifier. The high-order 20 bits of all element types defined by the OMG shall contain the VMCID allocated to the OMG (that is, 0x4F4D0).

Organizations must register their VMCIDs with the OMG before using them to define an **AuthorizationElementType**.

```
typedef unsigned long AuthorizationElementType;
```

```
typedef sequence <octet> AuthorizationElementContents;
```

```
struct AuthorizationElement {
 AuthorizationElementType the_type;
 AuthorizationElementContents the_element;
};
```

```
typedef sequence <AuthorizationElement> AuthorizationToken;
```

```
const AuthorizationElementType X509AttributeCertChain = OMGVMCID | 1;
```

This specification has defined one element encoding type, an X509AttributeCertChain. For this type, the field **the\_element** contains an encapsulation octet stream containing an ASN.1 type composed of an X.509 **AttributeCertificate** and a sequence of 0 or more X.509 Certificates. The corresponding ASN.1 definition appears below:

```
VerifyingCertChain ::= SEQUENCE OF Certificate
```

```
AttributeCertChain ::= SEQUENCE {
 attributeCert AttributeCertificate,
 certificateChain VerifyingCertChain,
}
```

The chain of identity certificates may be provided to certify the attribute certificate. Each certificate in the chain shall directly certify the one preceding it. The first certificate in the chain shall certify the attribute certificate. The ASN.1 representation of Certificate shall be as defined in [IETF RFC 2459]. The ASN.1 representation of **AttributeCertificate** shall be as defined in [IETF ID PKIXAC].

### 24.2.3.1 Extensions of the IETF AC Profile for CSIV2

The **extensions** field of the X.509 Attribute Certificates (AC) provides for the association of additional attributes with the holder or subject of the AC.

Each extension includes an **extnID** (an object identifier), an **extnValue** (an octet string), and a **critical** field (a boolean). The **extnID** identifies the extension, and the **extnValue** contains the value of the instance of the identified extension. The **critical** field indicates whether a certificate-using system shall reject the certificate if it does not recognize the extension. If the **critical** field is set to TRUE and the extension is not recognized (by its **extnID**), then the certificate shall be rejected. A non-critical extension that is not recognized may be ignored.

**Extensions ::= SEQUENCE SIZE (1..MAX) OF Extension**

```
Extension ::= SEQUENCE {
 extnID OBJECT IDENTIFIER,
 critical BOOLEAN DEFAULT FALSE,
 extnValue OCTET STRING
}
```

[IETF ID PKIXAC] defines a profile for ACs that defines a collection of extensions that may be used in ACs that conform to the profile. An AC that includes any subset of these extensions conforms to the profile. An AC that includes any other critical extension does not conform to the profile. An AC that includes any other non-critical extension conforms to the profile.

The CSIV2 AC profile adds the Proxy Info extension to the collection of extensions defined by the IETF profile. This critical extension may be used to define who may act as proxy for the AC subject. Refer to [IETF ID PKIXAC] for the details of the format and semantics of the Proxy Info extension.

A TSS shall reject a security context that contains an authorization element of type **X509AttributeCertChain** that contains critical extensions or attributes not recognized by the TSS. In this case, the TSS shall return a **ContextError** service context element containing major and minor error codes indicating the evidence is invalid (that is, “Invalid evidence”) as defined in Section 24.3.5, “ContextError Values and Exceptions,” on page 24-30.

### 24.2.4 Client Authentication Token Format

A CSIV2 client authentication token is a mechanism-specific GSS initial context token. It contains a mechanism type identifier (an object identifier) and the mechanism-specific evidence (that is, the authenticator) required to authenticate the client.

The following ASN.1 basic token definition describes the format of all GSSAPI initial context tokens. The definition of the inner context tokens is mechanism-specific.

```
-- basic Token Format
[APPLICATION 0] IMPLICIT SEQUENCE {
 thisMech MechType
 -- MechType is an Object Identifier
 innerContextToken ANY DEFINED BY thisMech
 -- contents mechanism specific
};
```

The client authentication token has been designed to accommodate the initial context token corresponding to any GSSAPI mechanism. Implementations are free to employ GSSAPI mechanisms other than those required for conformance to CSIv2, such as Kerberos.

The format of the mechanism OID in GSS initial context tokens is defined in [IETF RFC 2743] Section 3.1, "Mechanism-Independent Token Format," pp. 81-82.

#### 24.2.4.1 Username Password GSS Mechanism (GSSUP)

This specification defines a GSSAPI mechanism to support the delivery of authentication secrets above the transport such that they may be applied by a TSS to authenticate clients at shared secret authentication systems.

The GSSUP mechanism assumes that transport layer security, such as that provided by SSL/TLS, will be used to achieve confidentiality and trust in server, such that the contents of the initial context token do not have to be protected against exposures that occur as the result of networking.

The object identifier allocated for the GSSUP mechanism is defined as follows:

```
{ iso-itu-t (2) international-organization (23) omg (130) security (1) authentication (1)
 gssup-mechanism (1) }
```

##### *GSSUP Initial Context Token*

For the GSSUP mechanism, only an inner context token corresponding to the initial context token is defined.

The format of a GSSUP initial context token shall be as defined in [IETF RFC 2743] Section 3.1, "Mechanism-Independent Token Format," pp. 81-82. This GSSToken shall contain an ASN.1 tag followed by a token length, an authentication mechanism identifier, and a CDR encapsulation containing a GSSUP inner context token as defined by the type **GSSUP::InitialContextToken** in Section 24.9.1, "Module GSSUP - Username/Password GSSAPI Token Formats," on page 24-58 (and repeated below).

```
// GSSUP::InitialContextToken

struct InitialContextToken {
 CSI::UTF8String username;
```



```

 CSI::UTF8String password;
 CSI::GSS_NT_ExportedName target_name;
 };

```

The **target\_name** field of the **GSSUP::InitialContextToken** contains the name of the authentication domain in which the client is authenticating. This field aids the TSS in processing the authentication should the TSS support several authentication domains. A CSS shall fill the **target\_name** field of the **GSSUP::InitialContextToken** with the contents of the **target\_name** field of the **CSIIOP::AS\_ContextSec** structure of the chosen CSI mechanism.

The format of the name passed in the **username** field depends on the authentication domain. If the mechanism identifier of the target domain is GSSUP, then the format of the username shall be a Scoped-Username (with **name\_value**) as defined in “Scoped-Username GSS Name Form” on page 24-15.

### *GSSUP Mechanism-Specific Error Token*

The GSSUP mechanism-specific error token contains a GSSUP fatal error code.

```

typedef unsigned long ErrorCode;

// GSSUP Mechanism-Specific Error Token
struct ErrorToken {
 ErrorCode error_code;
};

```

The following fatal error codes are defined by the GSSUP mechanism:

```

// The context validator has chosen not to reveal the GSSUP
// specific cause of the failure.
const ErrorCode GSS_UP_S_G_UNSPECIFIED = 1;

// The user identified in the username field of the
// GSSUP::InitialContextToken is unknown to the target.
const ErrorCode GSS_UP_S_G_NOUSER = 2;

// The password supplied in the GSSUP::InitialContextToken was
// incorrect.
const ErrorCode GSS_UP_S_G_BAD_PASSWORD = 3;

// The target_name supplied in the GSSUP::InitialContextToken does
// not match a target_name in a mechanism definition of the target.
const ErrorCode GSS_UP_S_G_BAD_TARGET = 4;

```

A TSS is under no obligation to return a GSSUP error token; however, returning this token may facilitate the transition of the client-side GSS state machine through error processing. Accordingly, a TSS may indicate that SAS context validation failed in GSSUP client authentication by returning a GSSUP error token in a SAS **ContextError** message. In this case, a TSS that chooses not to reveal specific information as to the cause of the failed GSSUP authentication shall return a status value of **GSS\_UP\_S\_G\_UNSPECIFIED**.

### 24.2.5 Identity Token Format

An identity token is used in an **EstablishContext** message to carry a “spoken for” or asserted identity. The following table lists the five identity token types and defines the type of identity value that may be carried by each of the token types.

In addition to the identity token types described in the following table, the **IdentityTokenType** as defined in Section 24.9.2, “Module CSI - Common Secure Interoperability,” on page 24-59 provides for the definition of additional CSIv2 identity token types through the default selector of the **IdentityToken** union type. Additional standard identity token types shall only be defined by the OMG. All **IdentityTokenType** constants shall be a power of 2.

Table 24-2 Identity Token Types

| <b>IdentityTokenType<br/>(Union Discriminator)</b> | <b>Meaning</b>                                                                                                                                  |
|----------------------------------------------------|-------------------------------------------------------------------------------------------------------------------------------------------------|
| ITTAbsent                                          | Identity token is absent; the message conveys no representation of identity assertion                                                           |
| ITTAnonymous                                       | Identity token is being used to assert a valueless representation of an unauthenticated caller                                                  |
| ITTPrincipalName                                   | Identity token contains an encapsulation octet stream containing a GSS mechanism-independent exported name object as defined in [IETF RFC 2743] |
| ITTDistinguishedName                               | Identity token contains an encapsulation octet stream containing an ASN.1 encoding of an X.501 distinguished name                               |
| ITTX509CertChain                                   | Identity token contains an encapsulation octet stream containing an ASN.1 encoding of a chain of X.509 identity certificates                    |

Identity tokens of type **ITTX509CertChain** contain an ASN.1 encoding of a sequence of 1 or more X.509 certificates. The asserted identity may be extracted as a distinguished name from the subject field of the first certificate. Subsequent certificates shall directly certify the certificate they follow. The ASN.1 encoding of identity tokens of this type is defined as follows:

**CertificateChain ::= SEQUENCE SIZE (1..MAX) OF Certificate**

Interpretation of identity tokens that carry a GSS mechanism-independent exported name object (that is, an identity token type of **ITTPrincipalName**) is dependent on support for GSS mechanism-specific name manipulation functionality.

When a TSS rejects a request because it carries an identity token constructed using an identity type or naming mechanism that is not supported by the target, the TSS shall return a **ContextError** service context element containing major and minor status codes indicating the mechanism was invalid.

Asserting entities may choose to overcome limitations in a target’s supported mechanisms by mapping GSS mechanism-specific identities to distinguished names or certificates. The specifics of such mapping mechanisms are outside the scope of this specification.

### *GSS Exported Name Object Form for GSSUP Mechanism*

The mechanism OID within the exported name object shall be that of the GSSUP mechanism.

```
{ iso-itu-t (2) international-organization (23) omg (130) security (1) authentication (1)
gssup-mechanism (1) }
```

The name component within the exported name object shall be a contiguous string conforming to the syntax of the scoped-username GSS name form. The encoding of GSS mechanism-independent exported name objects is defined in [IETF RFC 2743].

### *Scoped-Username GSS Name Form*

The scoped-username GSS name form is defined as follows, where **name\_value** and **name\_scope** contain a sequence of 1 or more UTF8 encoded characters.

```
scoped-username ::= name_value | name_value@name_scope |
@name_scope
```

The '@' character shall be used to delimit **name\_value** from **name\_scope**. All non-delimiter instances of '@' and all non-quoting instances of '\' shall be quoted with an immediately-preceding '\'. Except for these cases, the quoting character, '\', shall not be emitted within a scoped-username.

The Object Identifier corresponding to the GSS scoped-username name form is:

```
{ iso-itu-t (2) international-organization (23) omg (130) security (1) naming (2)
scoped-username(1) }
```

## *24.2.6 Principal Names and Distinguished Names*

Principal names are carried in **EstablishContext** messages of the SAS protocol, where they may appear in the **identity\_token** (the **ITTPPrincipalName** discriminated type of an **IdentityTokenType**) or in the **client\_authentication\_token**, which is a GSS initial context token.

Principal names are also present in the compound mechanisms defined within a **TAG\_CSI\_SEC\_MECH\_LIST** tagged component within IORs. The **target\_name** field of the **AS\_ContextSec** structure may contain a sequence of principal names corresponding to the authentication identities of the target (see “struct **AS\_ContextSec**” on page 24-39). A principal name may be used as one variant of the **ServiceSpecificName** form used to identify one of the **privilege\_authorities** within the **SAS\_ContextSec** structure of a compound mechanism definition within a target IOR (see “struct **SAS\_ContextSec**” on page 24-40).

The principal names appearing in initial context tokens are in mechanism-specific; that is, internal form, and may be converted to GSS mechanism-independent exported name object format; that is, an external form by calling a mechanism-specific implementation of **GSS\_Export\_name**. The inverse translation is performed by a

mechanism-specific implementation of **GSS\_Import\_name**. A mechanism-specific implementation of **GSS\_Display\_name** allows its caller to convert an internal name representation into a printable form with an associated mechanism type identifier.<sup>7</sup>

The principal names in identity tokens — those in the **target\_name** field of **AS\_ContextSec** structures and those in the **privilege\_authorities** field of **SAS\_ContextSec** structures — are in external form (**GSS\_NT\_ExportedName**), and may be converted to internal form by calling the appropriate mechanism-specific **GSS\_import\_name** function.

Distinguished names may appear within an identity token, either as an asserted identity or indirectly as the subject distinguished name within an asserted X.509 Identity Certificate. Distinguished names may also be derived from the underlying transport authentication layer if client authentication is done using SSL certificates. Distinguished names may also be used as a form of GeneralName in the GeneralNames variant of the ServiceSpecificName type. The **ServiceSpecificName** type is used to identify **privilege\_authorities** within the **SAS\_ContextSec** structure of a compound mechanism definition within a target IOR.

## 24.3 Security Attribute Service Protocol

### 24.3.1 Compound Mechanisms

The SAS protocol combines common authorization (security attribute) functionality with client authentication functionality and is intended to be used in conjunction with a transport-layer security mechanism, so that there may be as many as three protocol layers of security functionality. This section describes the semantics of the compound security mechanisms that may be realized using this interoperability architecture.

The three protocol layers build on top of each other. The transport layer is at the bottom. The client authentication functionality of the SAS protocol provides a way to layer additional client authentication functionality above the transport layer. The common authorization functionality provides a way to layer security attribute functionality above the authentication layers. Any or all of the layers may be absent.

A target describes in its IORs the CSI compound security mechanisms it supports. Each mechanism defines a combination of layer-specific security functionality supported by the target, as defined in Section 24.5.1.5, “TAG\_CSI\_SEC\_MECH\_LIST,” on page 24-38.

The mechanisms a client uses to interact with a target shall be compatible with the target’s capabilities and sufficient to satisfy its requirements.

---

7. As defined in “IETF RFC 2743” on page 24-58, “Generic Security Service Application Program Interface Version 2, Update 1”, J. Linn, January 2000.

### 24.3.1.1 Context Validation

A target indicates its requirements for client authentication in its IORs. The layers at which a CSS authenticates to a TSS shall satisfy the requirements established by the target (see the description in Section 24.5.1, “Target Security Configuration,” on page 24-32). When a CSS attempts to authenticate with a TSS using the client authentication functionality of the SAS context layer protocol (by including a **client\_authentication\_token** in an **EstablishContext** message), the authentication context established in the TSS will reflect the result of the service context authentication (after having satisfied the target’s requirement for transport level authentication, if any).

If the service context authentication fails, the following shall happen:

- The request shall be rejected, whether or not authentication is required by the target.
- An exception containing a **ContextError** service context element shall be returned to the CSS. The **ContextError** service context element shall contain major and minor status codes indicating that client authentication failed.

If the request does not include a **client\_authentication\_token**, the client authentication identity is derived from the transport layer.

When a request includes an identity token, the TSS shall determine if the identity established as the client authentication identity is trusted to assert the identity represented in the identity token.

A TSS that does not support authorization-token-based delegation (see Section 24.6, “Conformance Levels,” on page 24-45) shall evaluate trust by applying the client authentication identity and the asserted identity to trust rules stored at the target. We call the evaluation of trust based on rules of the target a backward trust evaluation.

When a TSS that supports authorization-token-based delegation receives a request that includes both an identity token and an authorization token with embedded proxy attributes, the TSS shall evaluate trust by determining whether the proxy attributes were established (that is, signed) by a privilege authority acceptable to the target and whether the client authentication identity is included in the identities named in the proxy attributes. We call the evaluation of trust based on rules provided by the caller a forward trust evaluation. A TSS shall not accept requests that failed a forward trust evaluation based on a backward trust evaluation.

A TSS shall determine that a trusted identity established in the authentication layer(s) is trusted to assert exactly the same identity (in terms of identifier value and identification mechanism) in an identity token.

In either case of forward or backward trust evaluation, if trust is established, the context is considered correctly formed. Otherwise, the TSS shall reject the request by returning an exception containing a **ContextError** service context element. The **ContextError** element shall contain major and minor status codes indicating that the evidence was invalid.

If a request includes an authorization token but does not include an identity token, the TSS shall ensure that the access identity named in the authorization token is the same as the client authentication identity. If the request includes an identity token, the TSS shall ensure that the access identity is the same as the identity in the identity token. A TSS that supports authorization-token-based privilege attributes shall reject any request that does not satisfy this constraint and return an exception containing a **ContextError** service context element. The **ContextError** element shall contain major and minor status codes indicating that the evidence was invalid.

When a request includes an authorization token, it is the responsibility of the TSS to determine if the target trusts the authorities that signed the privileges in the token. A TSS that supports authorization-token-based privilege attributes shall reject any request with an authorization token that contains privilege information signed by an authority that is not trusted by the target. In this case, the TSS shall return an exception containing a **ContextError** service context element. The **ContextError** element shall contain major and minor status codes indicating that the evidence was invalid.

### 24.3.1.2 *Legend for Request Principal Interpretations*

This section serves as a key to the invocation scenarios represented in Table 24-3 on page 24-19, Table 24-4 on page 24-20, and Table 24-5 on page 24-21. The three tables describe the interpretation of security context information arriving at a target object from a calling object, object 2, that may have been called by another object, object 1. The authentication identity of object 2, as seen by the target object, may have been established in the transport layer, or the SAS context layer, or both. If the authentication identity was established at the transport layer it is referred to as P2<sup>A</sup>. If the authentication identity was established at the SAS context layer it is referred to as P2<sup>B</sup>. The authentication identity seen by object 2 when it is called by another object (that is, object 1) is referred to as P1, the authentication identity of object 1. No distinction is made between the transport and SAS layer authentication identities of object 1 as seen by object 2. Object 1 may also call object 2 anonymously.

P1 is also used to represent a non-anonymous identity that may be asserted by object 2 when it calls the target object. When object 2 calls the target object, it may include an asserted identity in the form of an identity token in its SAS layer context. The asserted identity may be the anonymous identity or, a non-anonymous identity (represented by P1). When object 2 asserts an identity to the target object, it may (or may not) establish proof of its own identity by authenticating at either or both of the transport (P2<sup>A</sup>), or SAS (P2<sup>B</sup>) layers. When the target object receives a request made with an asserted identity, the target object will determine if it trusts the client authentication identity (that of object 2, or P2) acting as proxy for the asserted identity (that of object 1, or P1).

When object 2 asserts a non-anonymous identity to the target object, it may include with its request a SAS layer authorization token containing PACs. Each PAC may include an attribute that assigns proxy to a collection of identities that are endorsed by the authority that created the PAC to assert the identity to which the privileges in the PAC apply. When the target object receives a request made with an asserted identity

and an authorization token containing proxy rules, the target object will use the proxy rules to determine if it may trust the client authentication identity ( $P2^A$  or  $P2^B$ ) as proxy for the asserted identity( $P1$ ).

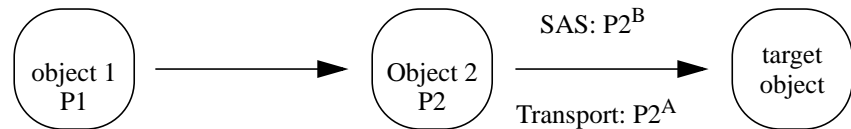

Figure 24-2 Invocation Scenarios

### 24.3.1.3 Anonymous Identity Assertion

The anonymous identity is used to represent an unauthenticated entity. To assert an anonymous caller identity, a CSS (perhaps acting as an intermediate) shall include a SAS context element containing an **EstablishContext** message with an **identity\_token** containing the anonymous **IdentityTokenType** in its request.

### 24.3.1.4 Presumed Trust

Presumed trust is a special case of the evaluation of identity assertions by a TSS. In presumed trust, a TSS accepts identity assertions based on the fact of their occurrence and without consideration of the authentication identity of the asserting entity. The presumption is that communications are constrained such that only trusted entities are capable of asserting an identity to the TSS.

### 24.3.1.5 Failed Trust Evaluations

Table 24-3 shows the circumstances under which the interpretation of caller credentials by a TSS results in a failed trust evaluation. None of these circumstances correspond to presumed trust, where trust evaluations are not performed (and therefore cannot fail).

Table 24-3 Conditions under which Trust Evaluation Fails

| Transport Client Principal | SAS Client Authentication Principal | SAS Identity Token Identity | Does Target Trust P2, or Is P2 Named as Proxy in Authorization Elements? |
|----------------------------|-------------------------------------|-----------------------------|--------------------------------------------------------------------------|
| None                       | None                                | P1                          | Not Applicable                                                           |
| None                       | $P2^B$                              | P1                          | No (with respect to $P2^B$ )                                             |
| $P2^A$                     | None                                | P1                          | No (with respect to $P2^A$ )                                             |
| $P2^A$                     | $P2^B$                              | P1                          | No (with respect to $P2^B$ )                                             |

A failed trust evaluation shall result in the request being rejected with an indication that client authentication failed.

### 24.3.1.6 Request Principal Interpretations

The entries in Table 24-4 describe the interpretation of client credentials by a TSS after an incoming call has satisfied the target's security requirements and has been validated by the TSS.

Table 24-4 TSS Interpretation of Client Credentials After Validation

| Transport Client Principal | SAS Client Authentication Principal       | SAS Identity Token Identity | Client Principal is Trusted          | Invocation Principal | Scenario               |
|----------------------------|-------------------------------------------|-----------------------------|--------------------------------------|----------------------|------------------------|
| None                       | None                                      | Absent                      | Not applicable                       | Anonymous            | Unauthenticated        |
| None                       | P2 <sup>B</sup>                           | Absent                      | Not applicable                       | P2                   | Client authentication  |
| P2 <sup>A</sup>            | None                                      | Absent                      | Not applicable                       | P2                   | Client authentication  |
| P2 <sup>A</sup>            | P2 <sup>B</sup> (by rule 1 <sup>1</sup> ) | Absent                      | Not applicable                       | P2 <sup>B</sup>      | Client authentication  |
| None                       | None                                      | P1                          | Yes if rule 2 <sup>2</sup>           | P1                   | identity assertion     |
| None                       | P2 <sup>B</sup>                           | P1                          | Yes if rule 2 or rule 3 <sup>3</sup> | P1                   | identity assertion     |
| P2 <sup>A</sup>            | None                                      | P1                          | Yes if rule 2 or rule 3              | P1                   | identity assertion     |
| P2 <sup>A</sup>            | P2 <sup>B</sup> (by rule 1)               | P1                          | Yes if rule 2 or rule 3              | P1                   | identity assertion     |
| None                       | None                                      | Anonymous                   | Yes if rule 4 <sup>4</sup>           | Anonymous            | assertion of anonymous |
| None                       | P2 <sup>B</sup>                           | Anonymous                   | Yes if rule 4                        | Anonymous            | assertion of anonymous |
| P2 <sup>A</sup>            | None                                      | Anonymous                   | Yes if rule 4                        | Anonymous            | assertion of anonymous |
| P2 <sup>A</sup>            | P2 <sup>B</sup> (by rule 1)               | Anonymous                   | Yes if rule 4                        | Anonymous            | assertion of anonymous |
| none                       | No SAS Message                            |                             | Not Applicable                       | Anonymous            | Unauthenticated        |
| P2                         | No SAS Message                            |                             | Not Applicable                       | P2                   | Client authentication  |

1. Rule 1: TSS trusts P2<sup>A</sup> to use authenticator for P2<sup>B</sup> is implied by P2<sup>B</sup> having been authenticated.
2. Rule 2: TSS presumes trust in transport to accept None, P2<sup>A</sup>, or P2<sup>B</sup> speaking for P1.
3. Rule 3: TSS trusts P2<sup>A</sup>, or P2<sup>B</sup> to speak for P1.
4. Rule 4: TSS trusts None, P2<sup>A</sup>, or P2<sup>B</sup> to speak for Anonymous. A TSS shall support the configuration of rule 4, such that Anonymous identity assertions are accepted independent of authentication of the asserter.

The entries in Table 24-5 describe additional TSS interpretation rules to support delegation. These rules have been separated from those in Table 24-4 on page 24-20, because they describe functionality required of implementations that conform to a higher level of secure interoperability as defined in Section 24.6.3, "Conformance Level 2," on page 24-47. The entries in Table 24-5 correspond to invocations that carry an identity token and an authorization token with embedded delegation token (that is, a proxy endorsement attribute) in an EstablishContext service context element. Invocations that do not carry all of these tokens are represented in Table 24-4.

An authorization token may contain authorization elements that contain proxy statements, which endorse principals to proxy for other entities. Table 24-5 describes delegation scenarios in which endorsements from the issuer of the authorization



element authorize the authenticated identity, which is P2<sup>A</sup> or P2<sup>B</sup>, to proxy for the asserted identity. In this table, the column “Proxies Named in Authorization Element” defines the identities who are endorsed by the authorization element to proxy for P1, the asserted identity and the subject of the authorization element. The value “Any” indicates that the authorization element contains a blanket endorsement, such that as far as its issuer is concerned, any identity may proxy for P1. The outcomes described in Table 24-5 assume that the TSS trusts the issuer of the authorization element to endorse principals to proxy for others.

Table 24-5 Additional TSS Rules to Support Delegation

| Transport Client Principal | SAS Client Authentication Principal | SAS Identity Token Identity | Proxies Named in Authorization Element      | Invocation Principal | Scenario              |
|----------------------------|-------------------------------------|-----------------------------|---------------------------------------------|----------------------|-----------------------|
| None                       | P2 <sup>B</sup>                     | P1                          | Any                                         | P1                   | Delegation            |
| P2 <sup>A</sup>            | None                                | P1                          | Any                                         | P1                   | Delegation            |
| P2 <sup>A</sup>            | P2 <sup>B</sup>                     | P1                          | Any                                         | P1                   | Delegation            |
| None                       | P2 <sup>B</sup>                     | P1                          | Restricted to set including P2 <sup>B</sup> | P1                   | Restricted delegation |
| P2 <sup>A</sup>            | None                                | P1                          | Restricted to set including P2 <sup>A</sup> | P1                   | Restricted delegation |
| P2 <sup>A</sup>            | P2 <sup>B</sup>                     | P1                          | Restricted to set including P2 <sup>B</sup> | P1                   | Restricted delegation |

### 24.3.2 Session Semantics

This section describes the negotiation of security contexts between a CSS and a TSS. A TSS is said to be stateless if it does not operate in the mode of accepting reusable (that is, stateful) security contexts. A TSS that accepts reusable security contexts is said to be stateful. A CSS is said to be stateless if it operates in the mode of establishing transient, non-reusable (that is, stateless) security contexts. A CSS that issues requests to establish reusable security contexts is said to be stateful.

#### 24.3.2.1 Negotiation of Statefulness

A client initiates a stateless interaction by specifying a **client\_context\_id** of 0. A client issues a request to establish a stateful context by including a nonzero **client\_context\_id** in an **EstablishContext** message.

When a stateless TSS receives a request to establish a stateful session, the TSS shall attempt to validate the security tokens bound to the request. If the validation fails, an exception containing an appropriate **ContextError** service context element shall be returned to the client. If the validation succeeds, the TSS shall negotiate to stateless by responding with a **CompleteEstablishContext** message with **context\_stateful** set to false.

A client that initiates a stateful interaction shall be capable of accepting that the target negotiated the context to stateless.

### 24.3.2.2 *Stateful/Reusable Contexts*

Each transport layer session defines a context identifier number *scope*. The CSS selects context identifiers for use within a scope.

A CSS may use the **EstablishContext** message to issue multiple concurrent requests to establish a stateful security context within a scope.

To avoid duplicate sessions, when the stateful **EstablishContext** requests sent within a scope carry equivalent security contexts, the CSS shall assign to them the same nonzero **client\_context\_id**.

Within a scope, a TSS shall reject any request to establish a stateful context that carries a different security context from an established context with the same **client\_context\_id**. In this case, an exception containing a **ContextError** service context element shall be returned to the caller.

Two security contexts are equivalent if all of the authentication, identity, and authorization tokens match both in existence and in value. Token values shall be evaluated for equivalence by comparing the corresponding byte sequences used to carry the tokens in **EstablishContext** messages.

When a target that supports stateful contexts receives a request to establish a stateful context, the TSS shall attempt to validate the security tokens in the **EstablishContext** element. If the validation succeeds, the request shall be accepted, and the reply (if there is one) shall carry a **CompleteEstablishContext** element that indicates (that is, **context\_stateful** = true) that the context is available at the TSS for the caller's reuse. If the validation fails, an exception containing an appropriate **ContextError** service context element shall be returned to the caller.

A TSS that accepts stateful contexts shall bear the responsibility for managing the lifecycle of these sessions. Clients that reuse stateful contexts shall be capable of processing replies that indicate that an established stateful context has been unilaterally discarded by the TSS.

A TSS shall not establish a stateful context in response to a request to establish a stateless context (that is, one with a **client\_context\_id** of zero)

A TSS that supports stateful contexts may negotiate a request to establish a stateful context to a stateless context in order to preserve resources. It may do so only if it does not already have an established matching stateful context.

Conversely, a stateful TSS that has negotiated a request to stateless may respond statefully to a subsequent context with the same (non-zero) **client\_context\_id**.

#### ***Relationship to Transport-Layer***

A SAS context shall not persist beyond the lifetime of the transport-layer secure association over which it was established.

Stateful SAS contexts are not compatible with transports that do not make the relationship between the connection and the association transparent.

### 24.3.3 TSS State Machine

The TSS state machine is defined in the state diagram, Figure 24-3 on page 24-24 and in the TSS state table, Table 24-6 on page 24-25. Each TSS call thread shall operate independently with respect to this state machine. Where necessary, thread synchronization at shared state shall be handled in the actions called by this state machine.

An ORB must not invoke the TSS state machine if the target object does not exist at the ORB. The TSS state machine has no capacity to reject or forward<sup>8</sup> a request because the target object does not exist, and must rely on the ORB to only invoke the TSS when the target object exists at the ORB.

In response to a one-way call, a TSS shall not perform any of the send actions described by the state machine.

The shaded rows in Table 24-6 on page 24-25 indicate transitions and states that do not exist in a stateless implementation of the SAS protocol.

The state names, function names, and function signatures that appear in the state diagram and the state table are not prescriptive.

---

8. A TSS uses the LOCATION\_FORWARD status to return an IOR containing up-to-date security mechanism configuration for an existing object.

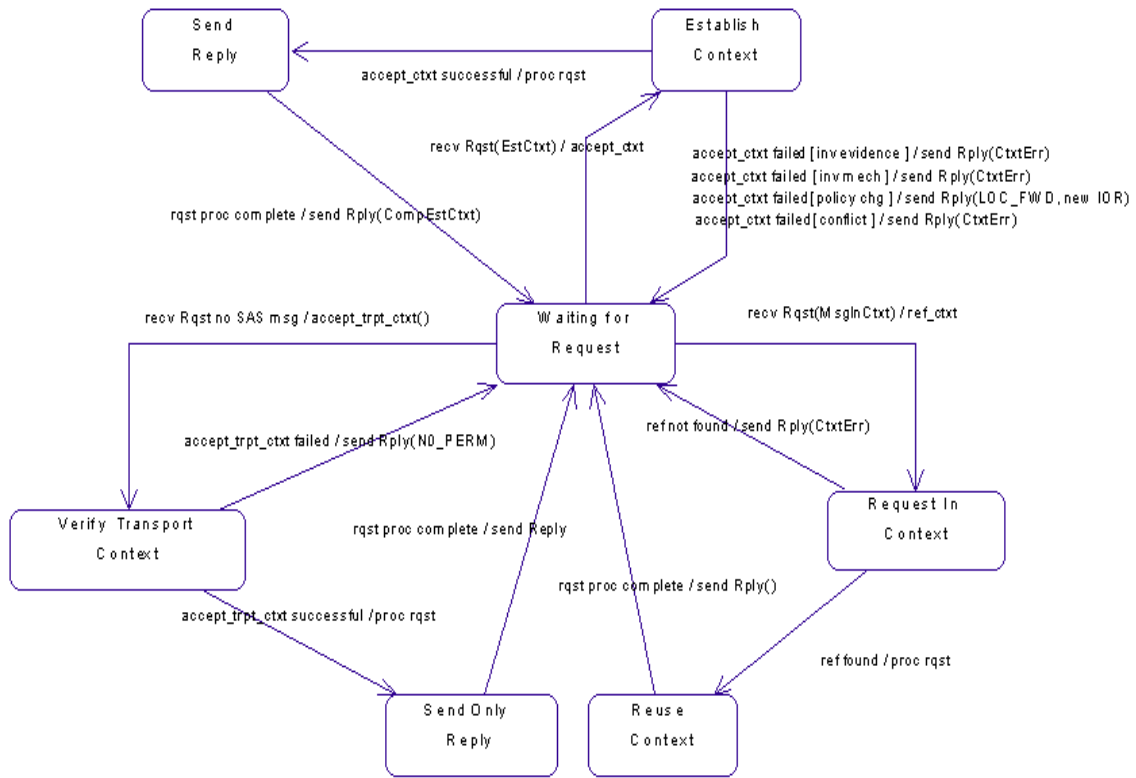

Figure 24-3 TSS State Machine

Table 24-6 TSS State Table

|   | State                    | Event                                                                             | Action                                                 | New State                |
|---|--------------------------|-----------------------------------------------------------------------------------|--------------------------------------------------------|--------------------------|
| 1 | Waiting for Request      | receive request without SAS message                                               | accept_transport_context()                             | Verify Transport Context |
|   |                          | receive Request + EstablishContext {client_context_id = N, tokens}                | accept_context( tokens, N, Out stateful)               | Establish Context        |
|   |                          | receive Request + MessageInContext {client_context_id = N, discard_context = D}   | reference_context( N )                                 | Request In Context       |
| 2 | Verify Transport Context | accept_transport_context() returned success                                       | process request                                        | Send Only Reply          |
|   |                          | accept_transport_context() returned failure                                       | send exception (NO_PERMISSION)                         | Waiting for Request      |
| 3 | Send Only Reply          | request processing completed                                                      | send Reply                                             | Waiting for Request      |
| 4 | Send Reply               | request processing completed                                                      | send Reply + CompleteEstablishContext { N, stateful}   | Waiting For Request      |
| 5 | Establish Context        | accept_context ( tokens, N, Out stateful) returned success                        | process request                                        | Send Reply               |
|   |                          | accept_context ( tokens, N, Out stateful) returned failure (invalid evidence)     | send exception + ContextError (invalid evidence)       | Waiting for Request      |
|   |                          | accept_context ( tokens, N, Out stateful) returned failure (invalid mechanism)    | send exception + ContextError (invalid mechanism)      | Waiting for Request      |
|   |                          | accept_context ( tokens, N, Out stateful) returned failure (policy change)        | send Reply + LOCATION_FORWARD status + updated IOR     | Waiting for Request      |
|   |                          | accept_context ( tokens, N, Out stateful) returned failure (conflicting evidence) | send exception + ContextError (conflicting evidence)   | Waiting for Request      |
| 6 | Request in Context       | reference_context( N ) returned reference                                         | process request                                        | Reuse Context            |
|   |                          | reference_context( N ) returned empty reference                                   | send exception + ContextError (context does not exist) | Waiting for Request      |
| 7 | Reuse Context            | request processing completed                                                      | send Reply<br>if (D) discard_context( N )              | Waiting for Request      |

### 24.3.3.1 TSS State Machine Actions

This section defines the intended semantics of the actions appearing in the TSS state machine. As noted above, the function names and function signatures are not prescriptive.

- **accept\_context** (tokens, N, Out stateful)

This action validates the security context captured in the tokens including ensuring that they are compatible with the mechanisms supported by the target object. If a context is not validated, **accept\_context** returns error codes that describe the reason the context was rejected.

When called by a stateless TSS, **accept\_context** always returns false in the output argument “**stateful**.”

When called by a stateful TSS, **accept\_context** may (depending on the effective policy of the target object) attempt to record state corresponding to the context. If state for the identified context already exists and the received tokens are not equivalent to those captured in the existing context, **accept\_context** shall reject the context. If the context state either already existed, or was recorded, **accept\_context** returns true in the output argument “**stateful**.”

An implementation of **accept\_context** shall implement the error semantics defined in the following table.

Table 24-7 Accept Context Error Semantics

| Semantic                                                                                                                                                      | Returned Error Code  |
|---------------------------------------------------------------------------------------------------------------------------------------------------------------|----------------------|
| tokens match mechanism definition of target object but could not be validated                                                                                 | Invalid evidence     |
| context has non-zero client_context_id that matches that of an existing context but tokens are not equivalent to those used to establish the existing context | Conflicting evidence |
| the mechanism configuration of the target object has changed and request indicates that CSS is not aware of the current mechanism configuration               | Policy change        |
| the mechanism configuration of the target object has not changed, and request is not consistent with target mechanism configuration                           | Invalid mechanism    |

When **accept\_context** returns any of **Invalid evidence**, **Conflicting evidence**, or **Invalid mechanism**, the TSS shall reject the request and send a **NO\_PERMISSION** exception containing a **ContextError** service context element with error codes as defined in Table 24-9 on page 24-31. When **accept\_context** returns **Policy change**, the TSS action shall reject the request and return a reply with status **LOCATION\_FORWARD** and containing a new IOR for the target object that contains an up-to-date representation of the target’s security mechanism configuration.

- **accept\_transport\_context()**

This action validates that a request that arrives without a SAS protocol message; that is, **EstablishContext** or **MessageInContext** satisfies the CSIv2 security requirements of the target object. This routine returns true if the transport layer security context (including none) over which the request was delivered satisfies the security requirements of the target object. Otherwise, **accept\_transport\_context** returns false. When **accept\_transport\_context** returns false, the TSS shall reject the request and send a **NO\_PERMISSION** exception.

- **reference\_context ( N )**

If there is an existing context with **client\_context\_id = N**, **reference\_context** returns a reference to it. Otherwise, **reference\_context** returns an empty reference.

- **discard\_context ( N )**

If context **N** exists and it is not needed to complete the processing of another thread, **discard\_context** causes the context to be deleted.

#### 24.3.4 CSS State Machine

A proposed implementation of the CSS state machine is defined in the state diagram, Figure 24-4 on page 24-28, and in the CSS state table, Table 24-8 on page 24-29. Each CSS call thread shall operate independently with respect to this state machine. Where necessary, thread synchronization at shared state shall be handled in the actions called by this state machine.

When a CSS processes a one-way call, it returns to the caller and sets its next state to done, as no response will be sent by the TSS.

The shaded rows in the state table indicate transitions and states that need not exist in a stateless CSS client side implementation.

The state names, function names, and function signatures that appear in the state diagram and state table are not prescriptive.

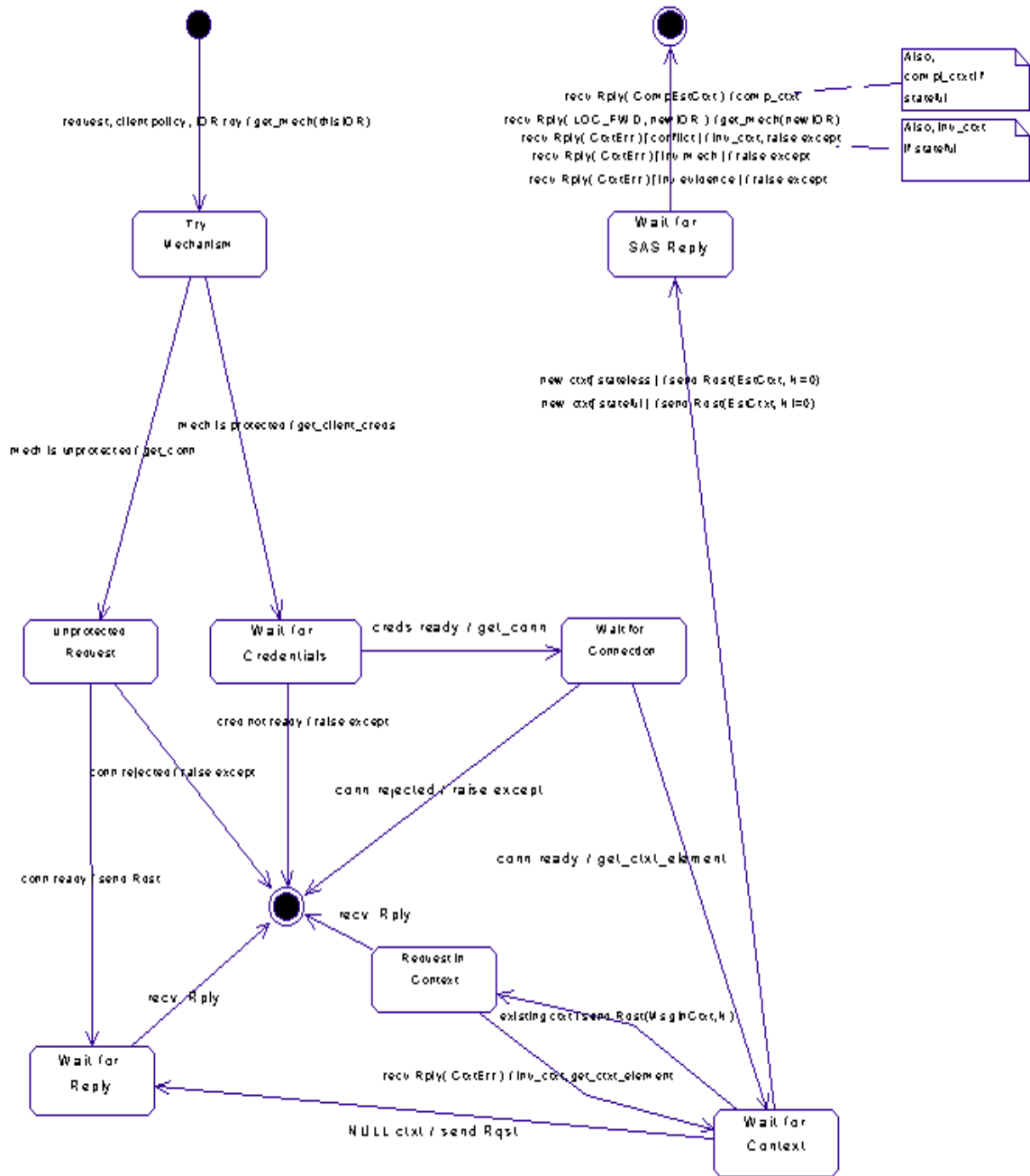

Figure 24-4 CSS State Machine



Table 24-8 CSS State Table

|                                                                | State                                     | Event                                                          | Action                                                                                  | New State            |
|----------------------------------------------------------------|-------------------------------------------|----------------------------------------------------------------|-----------------------------------------------------------------------------------------|----------------------|
| 1                                                              | start                                     | Request + client policy + IOR ready to send                    | get_mechanism (policy, thisIOR, Out mech)                                               | Try Mechanism        |
| 2                                                              | Try Mechanism                             | the selected mechanism is unprotected                          | get_connection (mech, Out c)                                                            | Unprotected Request  |
|                                                                |                                           | the selected mechanism is protected                            | get_client_creds (policy, mech, Out creds)                                              | Wait for Credentials |
| 3                                                              | Unprotected Request                       | connection ready                                               | send request                                                                            | Wait for Reply       |
|                                                                |                                           | connection rejected                                            | raise exception and return to caller <sup>1</sup>                                       | done                 |
| 4                                                              | Wait for Reply                            | receive reply                                                  | return to caller                                                                        | done                 |
| 5                                                              | Wait for Credentials                      | client credentials ready                                       | get_connection (policy, mech, creds, Out c)                                             | Wait for Connection  |
|                                                                |                                           | necessary credentials not obtained                             | raise exception and return to caller <sup>2</sup>                                       | done                 |
| 6                                                              | Wait for Connection                       | connection ready                                               | get_context_element (c, policy, creds, mech, Out element)                               | Wait for Context     |
|                                                                |                                           | connection rejected                                            | raise exception and return to caller <sup>3</sup>                                       | done                 |
| 7                                                              | Wait for Context                          | get_context_element returned EstablishContext {N = 0, tokens}  | send Request + EstablishContext {client_context_id = N = 0, tokens}                     | Wait for SAS Reply   |
|                                                                |                                           | get_context_element returned EstablishContext {N != 0, tokens} | send Request + EstablishContext {client_context_id = N != 0, tokens}                    | Wait for SAS Reply   |
|                                                                |                                           | get_context_element returned NULL                              | send request                                                                            | Wait for Reply       |
|                                                                |                                           | get_context_element returned MessageInContext {N != 0, D}      | send Request + MessageInContext {client_context_id = N != 0, D}                         | Request In Context   |
| 8                                                              | Wait for SAS Reply                        | receive exception + ContextError (invalid evidence)            | raise exception and return to caller <sup>4</sup>                                       | done                 |
|                                                                |                                           | receive exception + ContextError (invalid mechanism)           | raise exception and return to caller                                                    | done                 |
|                                                                |                                           | receive exception + ContextError (conflicting evidence)        | invalidate_context (c, N)                                                               | done                 |
|                                                                |                                           |                                                                | raise exception and return to caller                                                    |                      |
|                                                                |                                           | receive Reply + LOCATION_FORWARD status + updated IOR          | return to caller                                                                        | done                 |
| receive Reply + CompleteEstablishContext {N, context_stateful} | complete_context (c, N, context_stateful) | done                                                           |                                                                                         |                      |
|                                                                | return to caller                          |                                                                |                                                                                         |                      |
| 9                                                              | Request in Context                        | receive exception + ContextError (context does not exist)      | invalidate_context (c, N )<br>get_context_element (c, policy, creds, mech, Out element) | Wait for Context     |
|                                                                |                                           | receive Reply                                                  | return to caller                                                                        | done                 |

1. A CSS may do next mechanism processing, in which case it might call get\_next\_mechanism(policy,thisIOR) and transition to state Try Mechanism.

2. Same note as 1.

3. Same note as 1.

4. A CSS may re-collect authentication evidence and try again, in which case it might call `get_client_creds(policy, mech, Out creds)` and transition to state `Wait for Credentials`.

#### 24.3.4.1 CSS State Machine Actions

This section defines the intended semantics of the actions appearing in the CSS state machine. As noted above the function names and function signatures are not prescriptive. The descriptions appearing in the following sections are provided to facilitate understanding of the proposed implementation of the CSS state machine.

- **get\_mechanism** (policy, IOR, Out mech)  
Select from the **IOR** a **mechanism** definition that satisfies the client policy.
- **get\_client\_creds** (policy, mech, Out creds)  
Get the client **credentials** as necessary to satisfy the client **policy** and the target policy in the **mechanism**.
- **get\_connection** (mech, Out c)  
Open a connection based on the port information in the **mechanism** argument.
- **get\_connection** (policy, mech, creds, Out c)  
Open a secure connection based on the client **policy**, the target policy in the **mechanism** argument, and using the client credentials in the **creds** argument.
- **get\_context\_element**(c, policy, creds, mech, Out element)  
In the scope of connection **c**, use the client **creds** to create a SAS protocol context element that satisfies the client **policy** and the target policy in the **mechanism**. If the CSS supports reusable contexts, and the client policy is to establish a reusable context, the CSS allocates a **client\_context\_id**, and initializes a context element in the context table of the connection. A NULL context element may be returned by **get\_context\_element** when the target mechanism definition either does not support or require SAS layer security functionality, and the client establishes a policy not to use such functionality unless required to do so.
- **invalidate\_context** (c, N)  
Mark context **N** in connection scope **c** as invalid such that no more requests may (re)use it.
- **complete\_context** (c, N, context\_stateful)  
This action applies the contents of a returned **CompleteEstablishContext** message to context **N**, in connection scope **c**, to change its state to completed. In a stateful CSS, **get\_context\_element** will not return a **MessageInContext** element until **complete\_context** is called with **context\_stateful** true.

#### 24.3.5 ContextError Values and Exceptions

Table 24-9 on page 24-31 defines the circumstances under which error values and exceptions shall be returned by a TSS. The state and event columns contain states and events appearing in Table 24-6 on page 24-25.

Table 24-9 ContextError Codes and Exceptions

| State              | Event                                | Semantic             | Major | Minor | Exception     |
|--------------------|--------------------------------------|----------------------|-------|-------|---------------|
| Establish Context  | accept_context returned failure      | Invalid evidence     | 1     | 1     | NO_PERMISSION |
|                    |                                      | Invalid mechanism    | 2     | 1     | NO_PERMISSION |
|                    |                                      | Conflicting evidence | 3     | 1     | NO_PERMISSION |
| Request In Context | reference_context (N) returned false | No Context           | 4     | 1     | NO_PERMISSION |

## 24.4 Transport Security Mechanisms

### 24.4.1 Transport Layer Interoperability

The secure interoperability architecture that is defined by this specification partitions secure interoperability into three layers: the transport layer, authentication above the transport layer, and the secure attribute layer. This specification defines secure interoperability that uses transport-layer security for message protection and authentication of the target to the client.

### 24.4.2 Transport Mechanism Configuration

The configuration of transport-layer security mechanisms is specified in IORs. Support for CSI is indicated within an IOR profile by the presence of at most one **TAG\_CSI\_SEC\_MECH\_LIST** tagged component that defines the mechanism configuration pertaining to the profile. This component contains a list of one or more **CompoundSecMech** structures, each of which defines the layer-specific security mechanisms that comprise a compound mechanism that is supported by the target. This specification does not define support for CSI mechanisms in multiple-component IOR profiles.

Each **CompoundSecMech** structure contains a **transport\_mech** field that defines the transport-layer security mechanism of the compound mechanism. A compound mechanism that does not implement security functionality at the transport layer shall contain the **TAG\_NULL\_TAG** component in its **transport\_mech** field. Otherwise, the **transport\_mech** field shall contain a tagged component that defines a transport protocol and its configuration. Section 24.5.1.3, “TAG\_TLS\_SEC\_TRANS,” on page 24-35 and Section 24.5.1.4, “TAG\_SECIOP\_SEC\_TRANS,” on page 24-37 define valid transport-layer components that can be used in the **transport\_mech** field.

#### 24.4.2.1 Recommended SSL/TLS Ciphersuites

This specification recommends that implementations support the following ciphersuites in addition to the mandatory ciphersuites identified in [IETF RFC 2246]. Of these additional ciphersuites, those which use weak encryption keys are only recommended

for use in environments where strong encryption of SAS protocol elements (including GSSUP authenticators) and request arguments is not required. Some of the recommended ciphersuites are known to be encumbered by licensing constraints.

- TLS\_RSA\_WITH\_RC4\_128\_MD5
- SSL\_RSA\_WITH\_RC4\_128\_MD5
- TLS\_DHE\_DSS\_WITH\_DES\_CBC\_SHA
- SSL\_DHE\_DSS\_WITH\_DES\_CBC\_SHA
- TLS\_RSA\_EXPORT\_WITH\_RC4\_40\_MD5
- SSL\_RSA\_EXPORT\_WITH\_RC4\_40\_MD5
- TLS\_DHE\_DSS\_EXPORT\_WITH\_DES40\_CBC\_SHA
- SSL\_DHE\_DSS\_EXPORT\_WITH\_DES40\_CBC\_SHA

## 24.5 Interoperable Object References

### 24.5.1 Target Security Configuration

A target that supports unprotected IIOP invocations shall specify in the corresponding **TAG\_INTERNET\_IOP** profile a nonzero port number at which the target will accept unprotected invocations.<sup>9</sup> A target that supports only protected IIOP invocations shall specify a port number of 0 (zero) in the corresponding **TAG\_INTERNET\_IOP** profile. A target may support both protected and unprotected IIOP invocations at the same port, but it is not required to do so.

```

struct IOR {
 string type_id;
 sequence <TaggedProfile> profiles = {
 ProfileId tag = TAG_INTERNET_IOP;
 struct ProfileBody_1_1 profile_data = {
 Version iiop_version;
 string host;
 unsigned short port;
 sequence <octet> object_key;
 sequence <IOP::TaggedComponent> components;
 };
 };
};

```

---

9. The OMG has registered port numbers for IIOP (683) and IIOP/SSL (684) with IANA. Although the existence of these reservations does not prescribe their use, it may be useful to recognize these port numbers as defaults for the corresponding protocols.

A target that supports protected invocations shall describe in a **CompoundSecMech** structure the characteristics of each of the alternative compound security mechanisms that it supports. The **CompoundSecMech** structure shall be included in a list of such structures in the body of a **TAG\_CSI\_SEC\_MECH\_LIST** tagged component.

```
sequence <IOP::TaggedComponent> components = {
 IOP::TaggedComponent {
 ComponentId tag = TAG_CSI_SEC_MECH_LIST;
 sequence <octet> component_data = {
 CSIIOP::CompoundSecMechList = {
 boolean stateful;
 CompoundSecMechanisms mechanism_list = {
 CompoundSecMech;
 };
 };
 };
 };
};
```

The order of occurrence of the alternative compound mechanism definitions in a **TAG\_CSI\_SEC\_MECH\_LIST** component indicates the target's mechanism preference. The target prefers mechanism definitions occurring earlier in the list. An IOR profile shall contain at most one **TAG\_CSI\_SEC\_MECH\_LIST** tagged component. An IOR profile that contains multiple **TAG\_CSI\_SEC\_MECH\_LIST** tagged components is malformed and should be rejected by a client implementation.

#### 24.5.1.1 *AssociationOptions Type*

The **AssociationOptions** type is an unsigned short bit mask containing the logical OR of the configured options. The properties of security mechanisms are defined in an IOR in terms of the association options supported and required by the target. A CSS shall be able to interpret the association options defined in Table 24-10.

Table 24-10 Association Options

| Association Option     | target_supports                                                                                                                                                                                                                                                                                                                                                  | target_requires                                                                                                    |
|------------------------|------------------------------------------------------------------------------------------------------------------------------------------------------------------------------------------------------------------------------------------------------------------------------------------------------------------------------------------------------------------|--------------------------------------------------------------------------------------------------------------------|
| Integrity              | Target supports integrity protected messages                                                                                                                                                                                                                                                                                                                     | Target requires integrity protected messages                                                                       |
| Confidentiality        | Target supports privacy protected messages                                                                                                                                                                                                                                                                                                                       | Target requires privacy protected messages                                                                         |
| EstablishTrustInTarget | Target can authenticate to a client                                                                                                                                                                                                                                                                                                                              | Not applicable. This bit should never be set, and should be ignored by CSS                                         |
| EstablishTrustInClient | Target can authenticate a client                                                                                                                                                                                                                                                                                                                                 | Target requires client authentication                                                                              |
| IdentityAssertion      | Target accepts asserted caller identities based on trust in the authentication identity of the asserting entity. Target can evaluate trust based on trust rules of the target. If DelegationByClient is set, target can also evaluate trust when provided with a delegation token (that is, a proxy attribute contained in an authorization token). <sup>1</sup> | Not applicable. This bit should never be set, and should be ignored by CSS                                         |
| DelegationByClient     | When it occurs in conjunction with support for IdentityAssertion, this bit indicates that target can evaluate trust in an asserting entity based on a delegation token. <sup>2</sup>                                                                                                                                                                             | Target requires that CSS provide a delegation token that endorses the target as proxy for the client. <sup>3</sup> |

1. A target policy that accepts only identity assertions based on forward trust cannot be communicated in an IOR (although it can be enforced).
2. If an incoming request includes an identity token and a delegation token, the request shall be rejected if the delegation token does not endorse the asserting entity (see Section 24.3.1.1, “Context Validation,” on page 24-17)
3. A target with DelegationByClient set in **target\_requires** shall also have this bit set in **target\_supports**. As noted in the table, this has an impact on the target’s identity assertion policy (if any).

The representation of supported options is used by a client to determine if a mechanism is capable of supporting the client’s security requirements. The supported association options shall be a superset of those required by the target.

When the **IdentityAssertion** bit is set in **target\_supports**, it indicates that the target accepts asserted caller identities based on trust in the authentication identity of the asserting entity. When the **DelegationByClient** bit is not set, the target will evaluate trust based on rules of the target (that is, a backward trust evaluation). When the **IdentityAssertion** and **DelegationByClient** bits are set, they indicate that the target is also capable of evaluating trust in an asserting entity based on trust rules delivered in an authorization token (that is, a forward trust evaluation). A target that can perform a forward trust evaluation does so when trust rules are delivered in an authorization token. Otherwise a backward trust evaluation is performed.

When the **DelegationByClient** bit is set in **target\_requires**, it indicates that the target requires a delegation token to complete the processing of a request. Such circumstances will occur when a target, acting as an intermediate, attempts to issue a request as its caller and sanctioned by the delegation token delivered by its caller.

The rules for interpreting asserted identities in the presence or absence of a delegation token (that is, a proxy attribute contained in an authorization token) are as defined in Section 24.3.1.1, “Context Validation,” on page 24-17.

The security mechanism configuration in an IOR being used by a CSS may (as the result of target policy administration) no longer represent the actual security mechanism configuration of the target object.

### *Alternative Transport Association Options*

Implementations that choose to employ the service context protocol defined in this specification to achieve interoperability over an alternative secure transport (one other than SSL/TLS) may also be required to support the message protection options defined in Table 24-11.

Table 24-11 Alternative Transport Association Options

| Association Option | target_supports                                                      | target_requires                                                         |
|--------------------|----------------------------------------------------------------------|-------------------------------------------------------------------------|
| DetectReplay       | Target can detect replay of requests (and request fragments)         | Target requires security associations to detect replay                  |
| DetectMisordering  | Target can detect sequence errors of request (and request fragments) | Target requires security associations to detect message sequence errors |

#### 24.5.1.2 Transport Address

The TransportAddress structure indicates an INTERNET address where the TSS is listening for connection requests.

```
struct TransportAddress {
 string host_name;
 unsigned short port;
};
```

```
typedef sequence <TransportAddress> TransportAddressList;
```

The **host\_name** field identifies the Internet host to which connection requests will be made. The **host\_name** field shall not contain an empty string. The **host\_name** field shall contain a host name or an IP address in standard numerical address (e.g., dotted-decimal) form.

The **port** field contains the TCP/IP port number (at the specified host) where the TSS is listening for connection requests. The port number shall not be zero.

#### 24.5.1.3 TAG\_TLS\_SEC\_TRANS

An instance of the **TAG\_TLS\_SEC\_TRANS** component may occur in the **transport\_mech** field within a **CompoundSecMech** structure in a **TAG\_CSI\_SEC\_MECH\_LIST** component.

When an instance of the **TAG\_TLS\_SEC\_TRANS** component occurs in the **transport\_mech** field of the **CompoundSecMech** structure, it defines the sequence of transport addresses at which the target will be listening for SSL/TLS protected

invocations. The supported (**target\_supports**) and required (**target\_requires**) association options defined in the component shall define the transport level security characteristics of the target at the given addresses.

```
const IOP::ComponentId TAG_TLS_SEC_TRANS = 36;
```

```
struct TLS_SEC_TRANS {
 AssociationOptions target_supports;
 AssociationOptions target_requires;
 TransportAddressList addresses;
};
```

The **addresses** field provides a shorthand for defining multiple security mechanisms that differ only in their transport addresses. The **addresses** field shall contain at least one address.

Table 24-12, Table 24-13 on page 24-36, Table 24-14 on page 24-37, and Table 24-15 on page 24-37 describe the association option semantics relating to the **TAG\_TLS\_SEC\_TRANS** tagged component that shall be interpreted by a CSS and enforced by a TSS. The **IdentityAssertion** and **DelegationByClient** association options shall not occur in an instance of this component.

Table 24-12 Integrity Semantics

| <b>Integrity</b> | <b>Semantic</b>                                                            |
|------------------|----------------------------------------------------------------------------|
| Not supported    | None of the ciphersuites supported by the target designate a MAC algorithm |
| Supported        | Target supports one or more ciphersuites that designate a MAC algorithm    |
| Required         | All the ciphersuites supported by the target designate a MAC algorithm     |

Table 24-13 Confidentiality Semantics

| <b>Confidentiality</b> | <b>Semantic</b>                                                                                     |
|------------------------|-----------------------------------------------------------------------------------------------------|
| Not supported          | None of the ciphersuites supported by the target designate a bulk encryption algorithm <sup>1</sup> |
| Supported              | Target supports one or more ciphersuites that designate a bulk encryption algorithm                 |
| Required               | All the ciphersuites supported by the target designate a bulk encryption algorithm                  |

1. Bulk encryption algorithms include both block and stream ciphers.



Table 24-14 EstablishTrustInTarget Semantics

| EstablishTrustInTarget | Semantic                                                                                                                            |
|------------------------|-------------------------------------------------------------------------------------------------------------------------------------|
| Not supported          | None of the ciphersuites supported by the target designate a key exchange algorithm that will authenticate the target to the client |
| Supported              | Target supports one or more ciphersuites that designate a key exchange algorithm that will authenticate the target to the client    |
| Required               | Not applicable. This bit should never be set, and should be ignored by CSS                                                          |

Table 24-15 EstablishTrustInClient Semantics

| EstablishTrustInClient | Semantic                                                                                                                                                                                                              |
|------------------------|-----------------------------------------------------------------------------------------------------------------------------------------------------------------------------------------------------------------------|
| Not supported          | Target does not support client authentication during the handshake. Moreover, target provides no opportunity for client to authenticate in the handshake (that is, target does not send certificate request message). |
| Supported              | Target provides client with an opportunity to authenticate in handshake. Target will accept connection if client does not authenticate.                                                                               |
| Required               | Target accepts connections only from clients who successfully authenticate in the handshake                                                                                                                           |

#### 24.5.1.4 TAG\_SECIOP\_SEC\_TRANS

A tagged component with the **TAG\_SECIOP\_SEC\_TRANS** tag is a valid component for the **transport\_mech** field of the **CompoundSecMech** structure. The presence of this component indicates the generic use of the SECIOP protocol as a secure transport underneath the CSI mechanisms. A component tagged with this value shall contain the CDR encoding of the **SECIOP\_SEC\_TRANS** structure.

The **SECIOP\_SEC\_TRANS** structure defines the transport addresses for SECIOP messages, the association options pertaining to the particular GSS mechanism being supported, the GSS mechanism identifier, and the target's GSS exported name.

```
const IOP::ComponentId TAG_SECIOP_SEC_TRANS = 35;
```

```
struct SECIOP_SEC_TRANS {
 AssociationOptions target_supports;
 AssociationOptions target_requires;
 CSI::OID mech_oid;
 CSI::GSS_NT_ExportedName target_name;
 TransportAddressList addresses;
};
```

The **addresses** field provides a shorthand for defining multiple security mechanisms that differ only in their transport addresses. The **addresses** field shall contain at least one address.

Table 24-12 on page 24-36, Table 24-13 on page 24-36, Table 24-14 on page 24-37, and Table 24-15 on page 24-37 also describe the association option semantics relating to the **TAG\_SECIOP\_SEC\_TRANS** tagged component that shall be interpreted by a CSS and enforced by a TSS.

### 24.5.1.5 TAG\_CSI\_SEC\_MECH\_LIST

This new tagged component, **TAG\_CSI\_SEC\_MECH\_LIST**, is used to describe support in the target for a sequence of one or more compound security mechanisms represented in the **mechanism\_list** field of a **CompoundSecMechList** structure. The mechanism descriptions in the **mechanism\_list** occur in decreasing order of target preference.

```
const IOP::ComponentId TAG_CSI_SEC_MECH_LIST = 33;

struct CompoundSecMech {
 AssociationOptions target_requires;
 IOP::TaggedComponent transport_mech;
 AS_ContextSec as_context_mech;
 SAS_ContextSec sas_context_mech;
};

typedef sequence <CompoundSecMech> CompoundSecMechanisms;

struct CompoundSecMechList {
 boolean stateful;
 CompoundSecMechanisms mechanism_list;
};
```

The **CompoundSecMech** structure is used to describe support in the target for a compound security mechanism that may include security functionality that is realized in the transport and/or security functionality realized above the transport in service context. Where a compound security mechanism implements security functionality in the transport layer, the transport functionality shall be represented in a transport-specific component (for example, **TAG\_TLS\_SEC\_TRANS**) contained in the **transport\_mech** field of the **CompoundSecMech** structure. Where a compound security mechanism implements client authentication functionality in service context, the mechanism shall be represented in an **AS\_ContextSec** structure contained in the **as\_context\_mech** field of the **CompoundSecMech** structure. Where a compound security mechanism supports identity assertion or supports authorization attributes delivered in service context, the mechanism shall be represented in a **SAS\_ContextSec** structure contained in the **sas\_context\_mech** field of the **CompoundSecMech** structure.

At least one of the **transport\_mech**, **as\_context\_mech**, or **sas\_context\_mech** fields shall be configured. The **TAG\_NULL\_TAG** component shall be used in the **transport\_mech** field to indicate that a mechanism does not implement security functionality at the transport layer. A value of “no bits set” in the **target\_supports** field of either the **as\_context\_mech** or **sas\_context\_mech** fields shall be used to indicate that the mechanism does not implement security functionality at the corresponding layer.

The **target\_requires** field of the **CompoundSecMech** structure is used to designate a required outcome that shall be satisfied by one or more supporting (but not requiring) layers. The **target\_requires** field also represents all the options required independently by the various layers as defined within the mechanism.

Each compound mechanism defines a combination of layer-specific functionality that is supported by the target. A target's mechanism configuration is the sum of the combinations defined in the individual mechanisms.

A value of TRUE in the **stateful** field of the **CompoundSecMechList** structure indicates that the target supports the establishment of stateful or reusable SAS contexts. This field is provided to assist clients in their selection of a target that supports stateful contexts. It is also provided to sustain implementations that serialize stateful context establishment on the client side as a means to conserve precious server-side authentication capacity.<sup>10</sup>

A TSS shall set the **stateful** bit to FALSE in the **CompoundSecMechList** structure of IORs corresponding to target objects at which it will not accept reusable security contexts.

#### *struct AS\_ContextSec*

The **AS\_ContextSec** structure is used in the **as\_context\_mech** field within a **CompoundSecMech** structure in a **TAG\_CSI\_SEC\_MECH\_LIST** component to describe the client authentication functionality that the target expects to be layered above the transport in service context by means of the **client\_authentication\_token** of the **EstablishContext** element of the SAS protocol.

```
struct AS_ContextSec{
 AssociationOptions target_supports;
 AssociationOptions target_requires;
 CSI::OID client_authentication_mech;
 CSI::GSS_NT_ExportedName target_name;
};
```

A value of “no bits set” in the **target\_supports** field indicates that the mechanism does not implement client authentication functionality above the transport in service context. In this case, the values present in any of the other fields in this structure are irrelevant.

If the **target\_supports** field indicates that the mechanism supports client authentication in service context, then the **client\_authentication\_mech** field shall contain a GSS OID that identifies the GSS mechanism that the compound mechanism supports for client authentication above the transport.

The target uses the **target\_name** field to make its security name and or authentication domain available to clients. This information may be required by the client to obtain or construct (depending on the mechanism) a suitable initial context token.

---

10.This serialization is only done when an attempt is being made to establish a stateful context.

Table 24-16 describes the association options that are supported by conforming implementations.

Table 24-16 EstablishTrustInClient Semantics

|   | <b>EstablishTrustInClient</b> | <b>Semantic</b>                                                                                                                                                                                                     |
|---|-------------------------------|---------------------------------------------------------------------------------------------------------------------------------------------------------------------------------------------------------------------|
| 1 | Not supported                 | Target does not support client authentication in service context (at this compound mechanism)                                                                                                                       |
| 2 | Supported                     | Target supports client authentication in service context. If a CSS does not send an initial context token (in an EstablishContext service context element), then the caller identity is obtained from the transport |
| 3 | Required                      | Target requires client authentication in service context. The CSS may have also authenticated in the transport, but the caller identity is obtained from the service context layer                                  |

When a compound mechanism that implements client authentication functionality above the transport also contains a transport mechanism (in the **transport\_mech** field), any required association options configured in the transport component shall be interpreted as a prerequisite to satisfying the requirements of the client authentication mechanism.

#### *struct SAS\_ContextSec*

The **SAS\_ContextSec** structure is used in the **sas\_context\_mech** field within a **CompoundSecMech** structure in a **TAG\_CSI\_SEC\_MECH\_LIST** component to describe the security functionality that the target expects to be layered above the transport in service context by means of the **identity\_token** and **authorization\_token** of the **EstablishContext** element of the SAS service context protocol. The security functionality represented by this structure is configured as association options in the **target\_supports** and **target\_requires** fields.

```
// The high order 20-bits of each ServiceConfigurationSyntax
// constant shall contain the Vendor Minor Codeset ID (VMCID) of
// the organization that defined the syntax. The low order 12 bits
// shall contain the organization-scoped syntax identifier. The
// high-order 20 bits of all syntaxes defined by the OMG shall
// contain the VMCID allocated to the OMG (that is, 0x4F4D0).
```

```
typedef unsigned long ServiceConfigurationSyntax;
```

```
const ServiceConfigurationSyntax SCS_GeneralNames = CSI::OMGVMCID | 0;
const ServiceConfigurationSyntax SCS_GSSExportedName = CSI::OMGVMCID | 1;
```

```
typedef sequence <octet> ServiceSpecificName;
```

```
// The name field of the ServiceConfiguration structure identifies
// a privilege authority in the format identified in the syntax
// field. If the syntax is SCS_GeneralNames, the name field
// contains an ASN.1 (BER) SEQUENCE[1..MAX] OF GeneralName, as
// defined by the type GeneralNames in [IETF RFC 2459]. If the
// syntax is SCS_GSSExportedName, the name field contains a GSS
```

```
// exported name encoded according to the rules in [IETF RFC 2743]
// Section 3.2, "Mechanism-Independent Exported Name Object
// Format," p. 84.
```

```
struct ServiceConfiguration {
 ServiceConfigurationSyntax syntax;
 ServiceSpecificName name;
};

typedef sequence <ServiceConfiguration> ServiceConfigurationList;

struct SAS_ContextSec{
 AssociationOptions target_supports;
 AssociationOptions target_requires;
 ServiceConfigurationList privilege_authorities;
 CSI::OIDList supported_naming_mechanisms;
 CSI::IdentityTokenType supported_identity_types;
};
```

The **privilege\_authorities** field contains a sequence of zero or more **ServiceConfiguration** elements. A non-empty sequence indicates that the target supports the CSS delivery of an **AuthorizationToken**, which is delivered in the **EstablishContext** message. A CSS shall not be required to look beyond the first element of this sequence unless required by the first element.

The **syntax** field within the **ServiceConfiguration** element identifies the format used to represent the authority. Two alternative formats are currently defined: an ASN.1 encoding of the **GeneralNames** (as defined in [IETF RFC 2459]) which identify a privilege authority, or a GSS exported name (as defined in [IETF RFC 2743] Section 3.2) encoding of the name of a privilege authority.

The high order 20-bits of each **ServiceConfigurationSyntax** constant shall contain the Vendor Minor Codeset ID (VMCID) of the organization that defined the **syntax**. The low order 12 bits shall contain the organization-scoped syntax identifier. The high-order 20 bits of all syntaxes defined by the OMG shall contain the VMCID allocated to the OMG (that is, 0x4F4D0).

Organizations must register their VMCIDs with the OMG before using them to define a **ServiceConfigurationSyntax**.

The **supported\_naming\_mechanisms** field contains a list of GSS mechanism OIDs. A TSS shall set the value of this field to contain the GSS mechanism OIDs for which the target supports identity assertions using an identity token of type **ITTPrincipalName**. The Identity token types are defined in Section 24.2.5, "Identity Token Format," on page 24-14.

The value of the **supported\_identity\_types** field shall be the bitmapped representation of the set of identity token types supported by the target. A target always supports ITTAbsent.

The value in **supported\_identity\_types** shall be non-zero if and only if the **IdentityAssertion** bit is non-zero in target\_supports. The bit corresponding to the **ITTPrincipalName** identity token type shall be non-zero in **supported\_identity\_types** if and only if the value in **supported\_naming\_mechanisms** contains at least one element.

Table 24-17 describes the combinations of association options that are supported by conforming implementations. Each combination in the table describes the attribute layer functionality of a target that may be defined in a mechanism definition. A target that defines multiple mechanisms may support multiple combinations.

A compound mechanism definition with the **DelegationByClient** bit set shall include the name of at least one authority in the **privilege\_authorities** field.

When a compound mechanism configuration that defines SAS attribute layer functionality also defines client authentication layer or transport layer functionality, any required association options configured in these other layers shall be interpreted as a prerequisite to satisfying the requirements of the functionality defined in the attribute layer

Table 24-17 Attribute Layer Association Option Combinations

|   | <b>DelegationByClient</b> | <b>IdentityAssertion</b> | <b>Semantic</b>                                                                                                                                                                                                                                                                                                                                 |
|---|---------------------------|--------------------------|-------------------------------------------------------------------------------------------------------------------------------------------------------------------------------------------------------------------------------------------------------------------------------------------------------------------------------------------------|
| 1 | Not supported             | Not supported            | Target does not support identity assertion (that is, identity tokens in the EstablishContext message of the SAS protocol).<br>The caller identity will be obtained from the authentication layer(s).                                                                                                                                            |
| 2 | Not supported             | Supported                | Target evaluates asserted caller identities based on trust rules of the target. In the absence of an asserted identity, the caller identity will be obtained from the authentication layer(s).                                                                                                                                                  |
| 3 | Supported                 | Not supported            | Target accepts delegation tokens that indicate who has been endorsed to assert an identity.<br>Target does not accept asserted caller identities. The caller identity will be obtained from the authentication layer(s).                                                                                                                        |
| 4 | Supported                 | Supported                | Target accepts delegation tokens that indicate who has been endorsed to assert an identity.<br>Target evaluates asserted caller identities based on trust rules of the target or based on endorsements in a delegation token.<br>In the absence of an asserted identity, the caller identity will be obtained from the authentication layer(s). |
| 5 | Required                  | Not supported            | Same as 3, with the addition that target requires a delegation token that endorses the target as proxy for the caller                                                                                                                                                                                                                           |
| 6 | Required                  | Supported                | Same as 4, with the addition that target requires a delegation token that endorses the target as proxy for the caller                                                                                                                                                                                                                           |

### 24.5.1.6 TAG\_NULL\_TAG

This new tagged component is used in the **transport\_mech** field of a **CompoundSecMech** structure to indicate that the compound mechanism does not implement security functionality at the transport layer.

```
// The body of the TAG_NULL_TAG component is a sequence of octets of
// length 0.
const IOP::ComponentId TAG_NULL_TAG = 34;
```

### 24.5.2 Client-side Mechanism Selection

A client should evaluate the compound security mechanism definitions contained within the **CompoundSecMechList** in the **TAG\_CSI\_SEC\_MECH\_LIST** component in an IOR to select a mechanism that supports the options required by the client.

The options supported by a compound mechanism are the union (the logical OR) of the options supported by the **transport\_mech**, **as\_context\_mech**, and **sas\_context\_mech** fields of the **CompoundSecMech** structure.

The following table defines the semantics defined by the union of association options in compound mechanism definitions. Association options for server to client authentication and message protection add additional semantics that are not represented in the table.

Table 24-18 Interpretation of Compound Mechanism Association Options

|   | Semantic                                                                   | EstablishTrustInClient |          | IdentityAssertion | DelegationByClient      |          |
|---|----------------------------------------------------------------------------|------------------------|----------|-------------------|-------------------------|----------|
|   |                                                                            | Supported              | Required | Supported         | Supported               | Required |
| 1 | No client identification                                                   |                        |          |                   | Don't care <sup>2</sup> |          |
| 2 | Presumed trust                                                             |                        |          | X                 |                         |          |
| 3 | Authentication optional                                                    | X                      |          |                   | Don't care              |          |
| 4 | Authentication optional, assertion supported                               | X                      |          | X                 |                         |          |
| 5 | Authentication Required                                                    | X                      | X        |                   | Don't care              |          |
| 6 | Authentication Required, assertion supported                               | X                      | X        | X                 |                         |          |
| 7 | Presumed trust including support for provided target restrictions          |                        |          | X                 | X                       |          |
| 8 | Authentication optional, assertion supported including forward trust rules | X                      |          | X                 | X                       |          |
| 9 | Authentication required, assertion supported including forward trust rules | X                      | X        | X                 | X                       |          |

Table 24-18 Interpretation of Compound Mechanism Association Options

|    | Semantic                                                                                                                                                               | EstablishTrustInClient |          | IdentityAssertion | DelegationByClient |          |
|----|------------------------------------------------------------------------------------------------------------------------------------------------------------------------|------------------------|----------|-------------------|--------------------|----------|
|    |                                                                                                                                                                        | Supported              | Required | Supported         | Supported          | Required |
| 10 | Presumed Trust including support for provided target restrictions, delegation token required which implies assertion required <sup>1</sup>                             |                        |          | X                 | X                  | X        |
| 11 | Authentication optional, assertion supported including forward trust rules, delegation token required which implies either client authentication or assertion required | X                      |          | X                 | X                  | X        |
| 12 | Authentication required, delegation token required                                                                                                                     | X                      | X        |                   | X                  | X        |
| 13 | Authentication required, assertion supported including forward trust rules, delegation token required                                                                  | X                      | X        | X                 | X                  | X        |

1. If a delegation token is required, a non-anonymous client identity shall be established so that it can be endorsed by the delegation token. This same rule applies to row 11, and explains why there is no row that supports client authentication and requires a delegation token.
2. If DelegationByClient is supported, a delegation token may be provided, but it is not required to process the request

### 24.5.3 Client-Side Requirements and Location Binding

The primary assumption of this interoperability protocol is that transport layer security can ensure that it is not necessary to issue a preliminary request to establish a confidential association with the intended target.

In order to sustain this assumption, trust in target and a confidential transport shall be established prior to issuing any call that may contain arguments (including object keys) or service context elements that the client considers confidential. A CSS acting on behalf of a client may trust a target to locate an object (process a locate request) without having to trust the target with confidential arguments (other than object keys) or service context elements. For example, a CSS may have established a confidential connection to an address it learned from an IOR, and may then determine if the client trusts the target with its request arguments and any associated service context elements. If the client does not trust the target with its request, the CSS may send a locate request.<sup>11</sup> If the locate reply contains a new address, the CSS may establish a new confidential connection, evaluate the level of trust the client has in the new target,

---

<sup>11</sup> This requires that the CSS be provided with a method to cause the ORB to issue a locate request. There is no standard API to cause an ORB to issue a locate request.



and determine whether it can issue the client's request to the target. If in response to the request, the CSS receives a location forward, it will establish another confidential connection with the new address and repeat its trust determination.

Compound security mechanisms appearing in IORs leading to a location daemon should not require clients to authenticate using the username/password mechanism if doing so would cause an overly trusting caller to share its password with an untrusted location daemon.

The way in which a location daemon derives an IOR for a target object is not prescribed by this specification.

#### *24.5.3.1 Comments on Establishing Trust in Client*

A client that does not have the artifacts necessary to provide evidence of its authenticity over at least one of the transports supported by it and its target should search the IOR for a security mechanism definition that does not require client authentication to occur in a transport mechanism.

## *24.6 Conformance Levels*

### *24.6.1 Conformance Level 0*

Level 0 defines the base level of secure interoperability that all implementations are required to support. Level 0 requires support for SSL/TLS protected connections. Level 0 implementations are also required to support username/password client authentication and identity assertion by using the service context protocol defined in this specification.

#### *24.6.1.1 Transport-Layer Requirements*

Implementations shall support the Security Attribute Service (SAS) protocol within the service context lists of GIOP request and reply messages exchanged over SSL 3.0 and TLS 1.0 protected connections.

Implementations shall also support the SAS protocol within the service context lists of GIOP request and reply messages over unprotected transports defined within IIOP.<sup>12</sup>

---

<sup>12</sup>.SAS protocol elements should only be sent over unprotected transports within trusted environments.

### ***Required Ciphersuites***

Conforming implementations are required to support both SSL 3.0 and TLS 1.0 and the mandatory TLS 1.0 ciphersuites identified in [IETF RFC 2246]. Conforming implementations are also required to support the SSL 3.0 ciphersuites corresponding to the mandatory TLS 1.0 ciphersuites.

An additional set of recommended ciphersuites is identified in Section 24.4.2.1, “Recommended SSL/TLS Ciphersuites,” on page 24-31.

### ***24.6.1.2 Service Context Protocol Requirements***

All implementations shall support the Security Attribute Service (SAS) context element protocol in the manner described in the following sections.

#### ***Stateless Mode***

All implementations shall support the stateless CSS and stateless TSS modes of operation as defined in Section 24.3.2, “Session Semantics,” on page 24-21, and in the protocol message definitions appearing in Section 24.2.2, “SAS context\_data Message Body Types,” on page 24-5.

#### ***Client Authentication Tokens and Mechanisms***

All implementations shall support the username password (GSSUP) mechanism for client authentication as defined in Section 24.2.4.1, “Username Password GSS Mechanism (GSSUP),” on page 24-12.

#### ***Identity Tokens and Identity Assertion***

All implementations shall support the identity assertion functionality defined in Section 24.3.1.1, “Context Validation,” on page 24-17 and the identity token formats and functionality defined in Section 24.2.5, “Identity Token Format,” on page 24-14.

All implementations shall support GSSUP mechanism specific identity tokens of type **ITTPrincipalName**.

#### ***Authorization Tokens (not required)***

At this level of conformance, implementations are not required to be capable of including an authorization token in the SAS protocol elements they send or of interpreting such tokens if they are included in received SAS protocol elements.

The format of authorization tokens is defined in Section 24.2.3, “Authorization Token Format,” on page 24-10.

### 24.6.1.3 *Interoperable Object References (IORs)*

The security mechanism configuration of CSIV2 target objects, shall be as defined in Section 24.5.1, “Target Security Configuration,” on page 24-32, with the exception that Level 0 implementations are not required to support the **DelegationByClient** functionality described in Section 24.5.1.1, “AssociationOptions Type,” on page 24-33.

## 24.6.2 *Conformance Level 1*

Level 1 adds the following additional requirements to those of Level 0.

### 24.6.2.1 *Authorization Tokens*

Level 1 implementations shall support the push model for privilege attributes.

Level 1 requires that a CSS provide clients with an ability to include an authorization token, as defined in Section 24.2.3, “Authorization Token Format,” on page 24-10, in SAS EstablishContext protocol messages.

Level 1 requires that a TSS be capable of evaluating its support for a received authorization token according to the rules defined in Section 24.2.3.1, “Extensions of the IETF AC Profile for CSIV2,” on page 24-11.

A Level 1 TSS shall recognize the standard attributes and extensions defined in the attribute certificate profile defined in [IETF ID PKIXAC].

Level 1 requires that a target object that supports pushed privilege attributes include in its IORs the names of the privilege authorities trusted by the target object (as defined in “struct SAS\_ContextSec” on page 24-40).

## 24.6.3 *Conformance Level 2*

Level 2 adds to Level 1 the following additional requirements.

### 24.6.3.1 *Authorization-Token-Based Delegation*

Level 2 adds to Level 1 a requirement that implementations support the authorization-token-based delegation mechanism implemented by the SAS protocol.

A Level 2 TSS shall be capable of evaluating proxy rules arriving in an authorization token to determine whether an asserting entity has been endorsed (by the authority which vouched for the privilege attributes in the authorization token) to assert the identity to which the privilege attributes pertain. The semantics of the relationship between the identity token and authorization token shall be as defined in Section 24.3.1.1, “Context Validation,” on page 24-17.

A Level 2 TSS shall recognize the Section 24.2.3.1, “Extensions of the IETF AC Profile for CSIV2,” on page 24-11” (that is, the Proxy Info extension) as defined on that page.

Level 2 requires that a target object that accepts identity assertions based on endorsements in authorization tokens represent this support in its IORs as defined in Table 24-17 on page 24-42.

Level 2 requires that a target object that requires an endorsement to act as proxy for its callers represent this requirement in its IORs as defined in Table 24-17 on page 24-42.

#### *24.6.4 Stateful Conformance*

Implementations are differentiated not only by the conformance levels described in the preceding sections but also by whether or not they support stateful security contexts.

For an implementation to claim stateful conformance, it shall implement the stateless and stateful functionality as defined in Section 24.3.2, “Session Semantics,” on page 24-21 and in Section 24.2.2, “SAS context\_data Message Body Types,” on page 24-5.

### *24.7 Sample Message Flows and Scenarios*

This appendix contains sequence diagrams and sample IORs for a set of scenarios selected to illustrate the interoperability protocols defined in this specification. The sample IORs are expressed in pseudocode.

### 24.7.1 Confidentiality, Trust in Server, and Trust in Client Established in the Connection

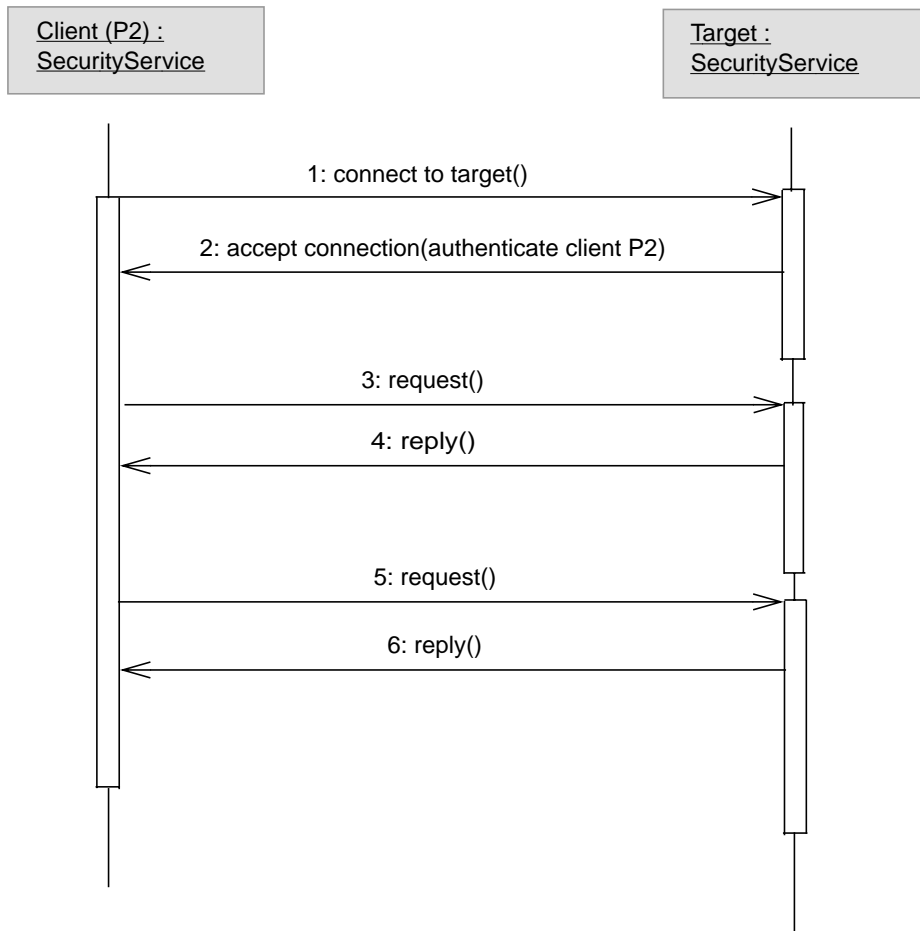

1. Initiate SSL/TLS connection to TSS.
2. SSL/TLS connection and ciphersuite negotiation accepted by both CSS and TSS. CSS evaluates its trust in target authentication identity and decides to continue. Client (P2) authenticates to TSS in the handshake.
3. Send request (with no security service context element).
4. Receive reply (with no security service context element).
5. Same as 3.
6. Same as 4.

### 24.7.1.1 Sample IOR Configuration

The following sample IOR was designed to address the related scenario.

```
CompoundSecMechList{
 stateful = FALSE;
 mechanism_list = {
 CompoundSecMec {
 target_requires = {Integrity, Confidentiality, EstablishTrustInClient};
 transport_mech = TAG_TLS_SEC_TRANS {
 target_supports = {Integrity, Confidentiality, EstablishTrustInClient,
 EstablishTrustInTarget};
 target_requires = {Integrity, Confidentiality, EstablishTrustInClient};
 addresses = {
 TransportAddress {
 host_name = x;
 port = y;
 };
 };
 };
 as_context_mech = {
 target_supports = {};
 ...
 };
 sas_context_mech = {
 target_supports = {};
 ...
 };
 };
 };
};
```

Note that based on the ciphersuites listed in “Required Ciphersuites” on page 24-46 and the rules for `target_supports` and `target_requires` appearing in the tables in Section 24.5.1.3, “TAG\_TLS\_SEC\_TRANS,” on page 24-35, all target IORs should include `{Integrity, Confidentiality, EstablishTrustInTarget}` in **target\_supports** and at least `{Integrity, Confidentiality}` in **target\_requires**. This statement applies to all the sample IORs corresponding to all the scenarios described in this chapter.

### 24.7.2 Confidentiality and Trust in Server Established in the Connection - Stateless Trust in Client Established in Service Context

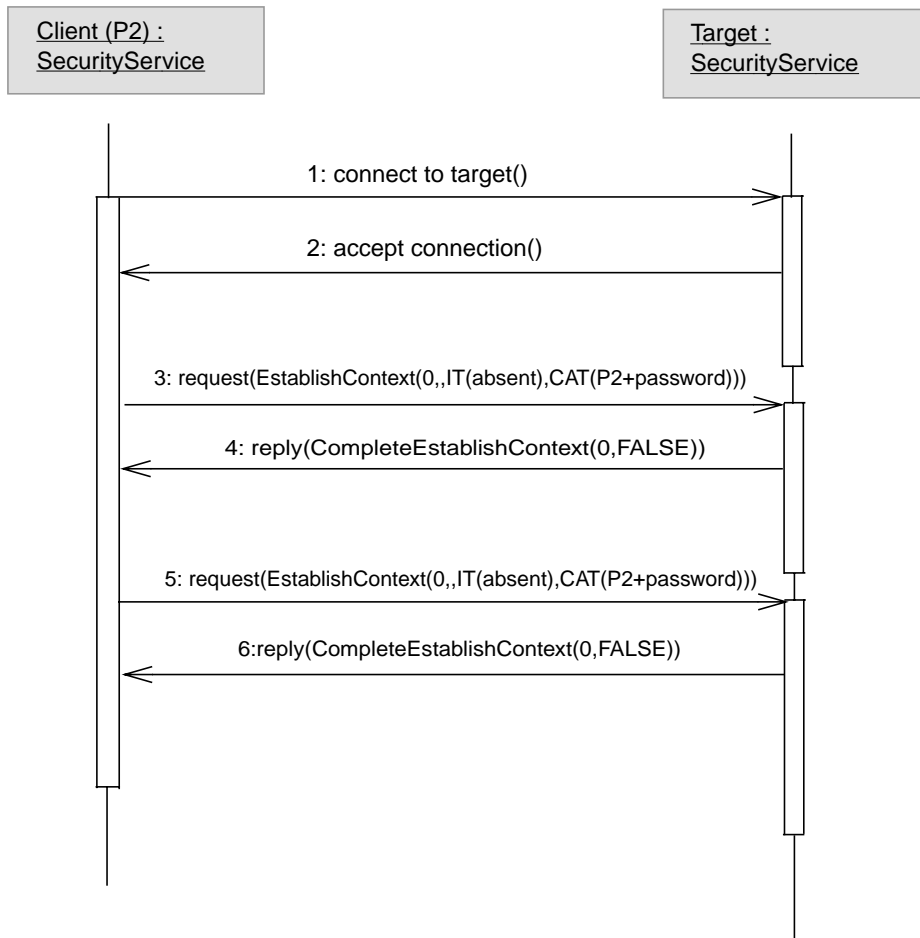

1. Initiate SSL/TLS connection to TSS.
2. SSL/TLS connection and ciphersuite negotiation accepted by both CSS and TSS. CSS evaluates its trust in target authentication identity and decides to continue.
3. Send request (with stateless security service context element containing a **client\_authentication\_token**).
4. Receive reply with **CompleteEstablishContext** service context element indicating context (and request) was accepted.
5. Same as 3.
6. Same as 4.

### 24.7.2.1 Sample IOR Configuration

The following sample IOR was designed to address the related scenario.

```

CompoundSecMechList{
 stateful = FALSE;
 mechanism_list = {
 CompoundSecMec {
 target_requires = {Integrity, Confidentiality, EstablishTrustInClient};
 transport_mech = TAG_TLS_SEC_TRANS {
 target_supports = {Integrity, Confidentiality, EstablishTrustInClient,
 EstablishTrustInTarget};
 target_requires = {Integrity, Confidentiality};
 addresses = {
 TransportAddress {
 host_name = x;
 port = y;
 };
 };
 };
 as_context_mech = {
 target_supports = {EstablishTrustInClient};
 target_requires = {EstablishTrustInClient};
 client_authentication_mech = GSSUPMechOID;
 target_name = (GSSUPMechOID + name_scope);
 };
 sas_context_mech = {
 target_supports = {};
 ...
 };
 };
 };
};

```



### 24.7.3 Confidentiality, Trust in Server, and Trust in Client Established in the Connection - Stateless Trust Association Established in Service Context

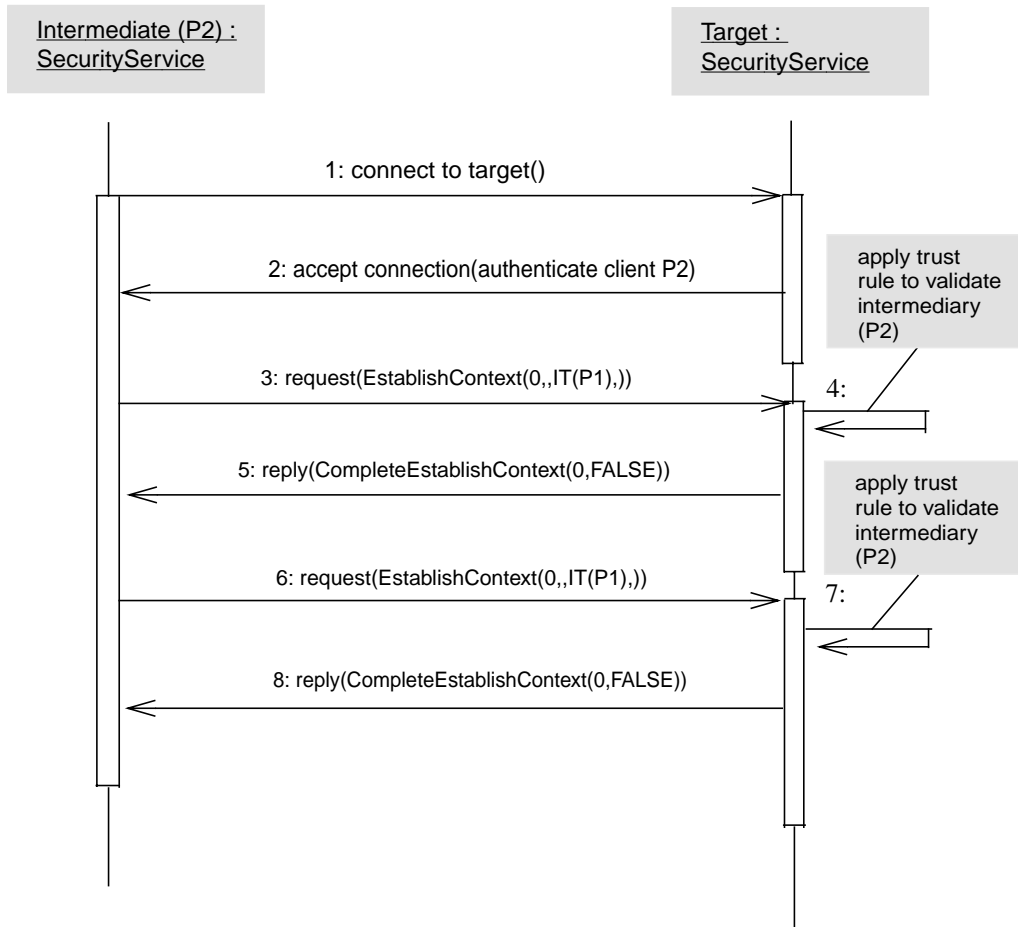

1. Initiate SSL/TLS connection to TSS.
2. SSL/TLS connection and ciphersuite negotiation accepted by both CSS and TSS. CSS evaluates its trust in target authentication identity and decides to continue. Client (P2) authenticates to TSS in the handshake.
3. Send request (with stateless security service context element containing spoken for identity (P1) in **identity\_token**).
4. TSS validates that target trusts P2 to speak for P1.
5. Receive reply with **CompleteEstablishContext** service context element indicating context (and request) was accepted.
6. Same as 3.

7. Same as 4.
8. Same as 5.

### 24.7.3.1 *Sample IOR Configuration*

The following sample IOR was designed to address the related scenario.

```

CompoundSecMechList {
 stateful = FALSE;
 mechanism_list = {
 CompoundSecMec {
 target_requires = {Integrity, Confidentiality, EstablishTrustInClient};
 transport_mech = TAG_TLS_SEC_TRANS {
 target_supports = {Integrity, Confidentiality, EstablishTrustInClient,
 EstablishTrustInTarget};
 target_requires = {Integrity, Confidentiality, EstablishTrustInClient};
 addresses = {
 TransportAddress {
 host_name = x;
 port = y;
 };
 };
 };
 };
 as_context_mech = {
 target_supports = {};
 ...
 };
 sas_context_mech = {
 target_supports = {IdentityAssertion};
 target_requires = {};
 privilege_authorities = {};
 supported_naming_mechanisms = {GSSUPMechOID};
 supported_identity_types = {ITTPrincipalName};
 };
 };
};

```

### 24.7.3.2 *Validating the Trusted Server*

If trust is not presumed, then the TSS shall evaluate the trustworthiness of the speaking for identity (i.e., the client identity established in the authentication layer(s) - P2 in the preceding example) in order to determine if it is authorized to speak for the spoken for identity (i.e., the non-anonymous identity represented as P1 in the identity token in the preceding example).

### 24.7.3.3 Presuming the Security of the Connection

There are variants of this scenario where either no security is established in the connection, or the connection is used to establish confidentiality only, and/or trust in the target only. These cases all fall under what is referred to as a presumed trust association. Where the security of the connection and the party using it is presumed, the TSS will not validate the trustworthiness of the speaking-for identity.

```

CompoundSecMechList {
 stateful = FALSE;
 mechanism_list = {
 CompoundSecMec {
 target_requires = {Integrity, Confidentiality};
 transport_mech = TAG_TLS_SEC_TRANS {
 target_supports = {Integrity, Confidentiality, EstablishTrustInTarget};
 target_requires = {Integrity, Confidentiality};
 addresses = {
 TransportAddress {
 host_name = x;
 port = y;
 };
 };
 };
 };
 as_context_mech = {
 target_supports = {};
 ...
 };
 sas_context_mech = {
 target_supports = {IdentityAssertion};
 target_requires = {};
 privilege_authorities = {};
 supported_naming_mechanisms = {GSSUPMechOID};
 supported_identity_types = {ITTPrincipalName};
 };
 };
};

```

#### 24.7.4 Confidentiality, Trust in Server, and Trust in Client Established in the Connection - Stateless Forward Trust Association Established in Service Context

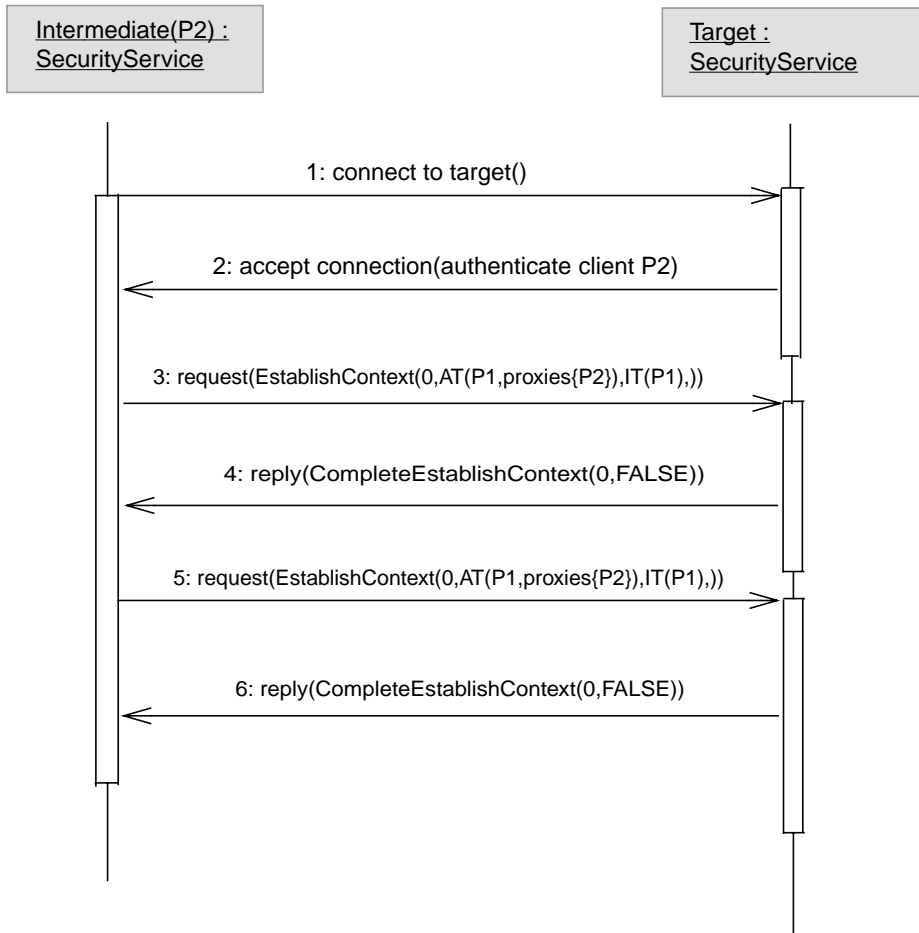

1. Initiate SSL/TLS connection to TSS.
2. SSL/TLS connection and ciphersuite negotiation accepted by both CSS and TSS. CSS evaluates its trust in target authentication identity and decides to continue. Intermediate (P2) authenticates to TSS in the handshake.
3. Send request with stateless security service context element containing spoken for identity (P1) in **identity\_token**, and trust rule from P1 in **authorization\_token** delegating proxy to P2.
4. Receive reply with **CompleteEstablishContext** service context element indicating context (and request) was accepted.
5. Same as 3.

6. Same as 4.

#### 24.7.4.1 Sample IOR Configuration

The following sample IOR was designed to address the related scenario.

```

CompoundSecMechList {
 stateful = FALSE;
 mechanism_list = {
 CompoundSecMec {
 target_requires = {Integrity, Confidentiality, EstablishTrustInClient};
 transport_mech = TAG_TLS_SEC_TRANS {
 target_supports = {Integrity, Confidentiality, EstablishTrustInClient,
 EstablishTrustInTarget};
 target_requires = {Integrity, Confidentiality, EstablishTrustInClient};
 addresses = {
 TransportAddress {
 host_name = x;
 port = y;
 };
 };
 };
 };
 as_context_mech = {
 target_supports = {};
 ...
 };
 sas_context_mech = {
 target_supports = {IdentityAssertion, DelegationByClient};
 target_requires = {};
 privilege_authorities = {
 ServiceConfigurationSyntax {
 syntax = s;
 name = n;
 };
 };
 supported_naming_mechanisms = {GSSUPMechOID};
 supported_identity_types = {ITTPPrincipalName};
 };
 };
};

```

## 24.8 References for this Chapter

### CORBASEC

CORBA Security Service, Revision 1.2, <http://www.omg.org/docs/ptc/98-01-02>

CORBA Security Service, Revision 1.5, <http://www.omg.org/docs/ptc/98-12-03>

CORBA Security Service, Revision 1.7, <http://www.omg.org/docs/ptc/99-12-03>

*IETF ID PKIXAC*

An Internet Attribute Certificate Profile for Authorization, <draft-ietf-pkix-ac509prof-05.txt>, S. Farrell, Baltimore Technologies, R. Housley, SPYRUS, August 2000.

*IETF RFC 2246*

The TLS Protocol Version 1.0, T. Dierks, C. Allen, January 1999.

*IETF RFC 2459*

Internet X.509 Public Key Infrastructure Certificate and CRL Profile, R Housley, W. Ford, W. Polk, and D. Solo, January 1999.

*IETF RFC 2743*

Generic Security Service Application Program Interface Version 2, Update 1, J. Linn, January 2000.

*X.501-93*

ITU-T Recommendation X.501: Information Technology - Open Systems Interconnection - The Directory: Models, 1993.

## 24.9 IDL

### 24.9.1 Module GSSUP - Username/Password GSSAPI Token Formats

```
#ifndef _GSSUP_IDL_
#define _GSSUP_IDL_

import ::CSI;

module GSSUP {
 typeprefix GSSUP "omg.org";

 // The GSS Object Identifier allocated for the
 // username/password mechanism is defined below.
 //
 // { iso-itu-t (2) international-organization (23) omg (130)
 // security (1) authentication (1) gssup-mechanism (1) }

 const CSI::StringOID GSSUPMechOID = "oid:2.23.130.1.1.1";

 // The following structure defines the inner contents of the
 // username password initial context token. This structure is
 // CDR encapsulated and appended at the end of the
 // username/password GSS (initial context) Token.

 struct InitialContextToken {
 CSI::UTF8String username;
 CSI::UTF8String password;
 CSI::GSS_NT_ExportedName target_name;
 };
};
```

```

};

typedef unsigned long ErrorCode;

// GSSUP Mechanism-Specific Error Token
struct ErrorToken {
 ErrorCode error_code;
};

// The context validator has chosen not to reveal the GSSUP
// specific cause of the failure.
const ErrorCode GSS_UP_S_G_UNSPECIFIED = 1;

// The user identified in the username field of the
// GSSUP::InitialContextToken is unknown to the target.
const ErrorCode GSS_UP_S_G_NOUSER = 2;

// The password supplied in the GSSUP::InitialContextToken was
// incorrect.
const ErrorCode GSS_UP_S_G_BAD_PASSWORD = 3;

// The target_name supplied in the GSSUP::InitialContextToken does
// not match a target_name in a mechanism definition of the target.
const ErrorCode GSS_UP_S_G_BAD_TARGET = 4;

}; // GSSUP

#endif

```

### 24.9.2 Module CSI - Common Secure Interoperability

```

#ifndef _CSI_IDL_
#define _CSI_IDL_

module CSI {
 typeprefix CSI "omg.org";

 // The OMG VMCID; same value as CORBA::OMGVMCID. Do not change ever.

 const unsigned long OMGVMCID = 0x4F4D0;

 // An X509CertificateChain contains an ASN.1 BER encoded SEQUENCE
 // [1..MAX] OF X.509 certificates encapsulated in a sequence of octets. The
 // subject's certificate shall come first in the list. Each following
 // certificate shall directly certify the one preceding it. The ASN.1
 // representation of Certificate is as defined in [IETF RFC 2459].

 typedef sequence <octet> X509CertificateChain;

 // an X.501 type name or Distinguished Name encapsulated in a sequence of
 // octets containing the ASN.1 encoding.

 typedef sequence <octet> X501DistinguishedName;

```

```

// UTF-8 Encoding of String

typedef sequence <octet> UTF8String;

// ASN.1 Encoding of an OBJECT IDENTIFIER

typedef sequence <octet> OID;

typedef sequence <OID> OIDList;

// A sequence of octets containing a GSSToken. Initial context tokens are
// ASN.1 encoded as defined in [IETF RFC 2743] Section 3.1,
// "Mechanism-Independent token Format", pp. 81-82. Initial context tokens
// contain an ASN.1 tag followed by a token length, a mechanism identifier,
// and a mechanism-specific token (i.e. a GSSUP::InitialContextToken). The
// encoding of all other GSS tokens (e.g. error tokens and final context
// tokens) is mechanism dependent.

typedef sequence <octet> GSSToken;

// An encoding of a GSS Mechanism-Independent Exported Name Object as
// defined in [IETF RFC 2743] Section 3.2, "GSS Mechanism-Independent
// Exported Name Object Format," p. 84.

typedef sequence <octet> GSS_NT_ExportedName;

typedef sequence <GSS_NT_ExportedName> GSS_NT_ExportedNameList;

// The MsgType enumeration defines the complete set of service context
// message types used by the CSI context management protocols, including
// those message types pertaining only to the stateful application of the
// protocols (to insure proper alignment of the identifiers between
// stateless and stateful implementations). Specifically, the
// MTMessageInContext is not sent by stateless clients (although it may
// be received by stateless targets).

typedef short MsgType;

const MsgType MTEstablishContext = 0;
const MsgType MTCompleteEstablishContext = 1;
const MsgType MTContextError = 4;
const MsgType MTMessageInContext = 5;

// The ContextId type is used carry session identifiers. A stateless
// application of the service context protocol is indicated by a session
// identifier value of 0.

typedef unsigned long long ContextId;

// The AuthorizationElementType defines the contents and encoding of
// the _element field of the AuthorizationElement.

// The high order 20-bits of each AuthorizationElementType constant
// shall contain the Vendor Minor Codeset ID (VMCID) of the
// organization that defined the element type. The low order 12 bits

```



```

// shall contain the organization-scoped element type identifier. The
// high-order 20 bits of all element types defined by the OMG shall
// contain the VMCID allocated to the OMG (that is, 0x4F4D0).

typedef unsigned long AuthorizationElementType;

// An AuthorizationElementType of X509AttributeCertChain indicates that
// the _element field of the AuthorizationElement contains an ASN.1 BER
// SEQUENCE composed of an (X.509) AttributeCertificate followed by a
// SEQUENCE OF (X.509) Certificate. The two-part SEQUENCE is encapsulated
// in an octet stream. The chain of identity certificates is provided
// to certify the attribute certificate. Each certificate in the chain
// shall directly certify the one preceding it. The first certificate
// in the chain shall certify the attribute certificate. The ASN.1
// representation of (X.509) Certificate is as defined in [IETF RFC 2459].
// The ASN.1 representation of (X.509) AttributeCertificate is as defined
// in [IETF ID PKIXAC].

const AuthorizationElementType X509AttributeCertChain = OMGVMCID | 1;

typedef sequence <octet> AuthorizationElementContents;

// The AuthorizationElement contains one element of an authorization token.
// Each element of an authorization token is logically a PAC.

struct AuthorizationElement {
 AuthorizationElementType the_type;
 AuthorizationElementContents the_element;
};

// The AuthorizationToken is made up of a sequence of
// AuthorizationElements

typedef sequence <AuthorizationElement> AuthorizationToken;

typedef unsigned long IdentityTokenType;

// Additional standard identity token types shall only be defined by the
// OMG. All IdentityTokenType constants shall be a power of 2.

const IdentityTokenType ITTAbsent = 0;
const IdentityTokenType ITTAnonymous = 1;
const IdentityTokenType ITTPrincipalName = 2;
const IdentityTokenType ITTX509CertChain = 4;
const IdentityTokenType ITTDistinguishedName = 8;

typedef sequence <octet> IdentityExtension;

union IdentityToken switch (IdentityTokenType) {
 case ITTAbsent: boolean absent;
 case ITTAnonymous: boolean anonymous;
 case ITTPrincipalName: GSS_NT_ExportedName principal_name;
 case ITTX509CertChain: X509CertificateChain certificate_chain;
 case ITTDistinguishedName: X501DistinguishedName dn;
 default: IdentityExtension id;
}

```

```

};

struct EstablishContext {
 ContextId client_context_id;
 AuthorizationToken authorization_token;
 IdentityToken identity_token;
 GSSToken client_authentication_token;
};

struct CompleteEstablishContext {
 ContextId client_context_id;
 boolean context_stateful;
 GSSToken final_context_token;
};

struct ContextError {
 ContextId client_context_id;
 long major_status;
 long minor_status;
 GSSToken error_token;
};

// Not sent by stateless clients. If received by a stateless server, a
// ContextError message should be returned, indicating the session does
// not exist.

struct MessageInContext {
 ContextId client_context_id;
 boolean discard_context;
};

union SASContextBody switch (MsgType) {
 case MTEstablishContext: EstablishContext establish_msg;
 case MTCompleteEstablishContext: CompleteEstablishContext
complete_msg;
 case MTContextError: ContextError error_msg;
 case MTMessageInContext: MessageInContext in_context_msg;
};

// The following type represents the string representation of an ASN.1
// OBJECT IDENTIFIER (OID). OIDs are represented by the string "oid:"
// followed by the integer base 10 representation of the OID separated
// by dots. For example, the OID corresponding to the OMG is represented
// as: "oid:2.23.130"

typedef string StringOID;

// The GSS Object Identifier for the KRB5 mechanism is:
// { iso(1) member-body(2) United States(840) mit(113554) infosys(1)
// gssapi(2) krb5(2) }

const StringOID KRB5MechOID = "oid:1.2.840.113554.1.2.2";

// The GSS Object Identifier for name objects of the Mechanism-independent
// Exported Name Object type is:

```

```

// { iso(1) org(3) dod(6) internet(1) security(5) nametypes(6)
// gss-api-exported-name(4) }

const StringOID GSS_NT_Export_Name_OID = "oid:1.3.6.1.5.6.4";

// The GSS Object Identifier for the scoped-username name form is:
// { iso-itu-t (2) international-organization (23) omg (130) security (1)
// naming (2) scoped-username(1) }

const StringOID GSS_NT_Scoped_Username_OID = "oid:2.23.130.1.2.1";

}; // CSI

#endif

```

### 24.9.3 Module CSIIOP - CSIV2 IOR Component Tag Definitions

```

#ifndef _CSIIOP_IDL_
#define _CSIIOP_IDL_

import ::IOP;
import ::CSI;

module CSIIOP {
 typeprefix CIOP "omg.org";

 // Association options

 typedef unsigned short AssociationOptions;

 const AssociationOptions NoProtection = 1;
 const AssociationOptions Integrity = 2;
 const AssociationOptions Confidentiality = 4;
 const AssociationOptions DetectReplay = 8;
 const AssociationOptions DetectMisordering = 16;
 const AssociationOptions EstablishTrustInTarget = 32;
 const AssociationOptions EstablishTrustInClient = 64;
 const AssociationOptions NoDelegation = 128;
 const AssociationOptions SimpleDelegation = 256;
 const AssociationOptions CompositeDelegation = 512;
 const AssociationOptions IdentityAssertion = 1024;
 const AssociationOptions DelegationByClient = 2048;

 // The high order 20-bits of each ServiceConfigurationSyntax constant
 // shall contain the Vendor Minor Codeset ID (VMCID) of the
 // organization that defined the syntax. The low order 12 bits shall
 // contain the organization-scoped syntax identifier. The high-order 20
 // bits of all syntaxes defined by the OMG shall contain the VMCID
 // allocated to the OMG (that is, 0x4F4D0).

 typedef unsigned long ServiceConfigurationSyntax;

 const ServiceConfigurationSyntax SCS_GeneralNames = CSI::OMGVMCID | 0;
 const ServiceConfigurationSyntax SCS_GSSExportedName = CSI::OMGVMCID | 1;

```

```

typedef sequence <octet> ServiceSpecificName;

// The name field of the ServiceConfiguration structure identifies a
// privilege authority in the format identified in the syntax field. If the
// syntax is SCS_GeneralNames, the name field contains an ASN.1 (BER)
// SEQUENCE [1..MAX] OF GeneralName, as defined by the type GeneralNames in
// [IETF RFC 2459]. If the syntax is SCS_GSSExportedName, the name field
// contains a GSS exported name encoded according to the rules in
// [IETF RFC 2743] Section 3.2, "Mechanism-Independent Exported Name
// Object Format," p. 84.

struct ServiceConfiguration {
 ServiceConfigurationSyntax syntax;
 ServiceSpecificName name;
};

typedef sequence <ServiceConfiguration> ServiceConfigurationList;

// The body of the TAG_NULL_TAG component is a sequence of octets of
// length 0.

// type used to define AS layer functionality within a compound mechanism
// definition

struct AS_ContextSec {
 AssociationOptions target_supports;
 AssociationOptions target_requires;
 CSI::OID client_authentication_mech;
 CSI::GSS_NT_ExportedName target_name;
};

// type used to define SAS layer functionality within a compound mechanism
// definition

struct SAS_ContextSec {
 AssociationOptions target_supports;
 AssociationOptions target_requires;
 ServiceConfigurationList privilege_authorities;
 CSI::OIDList supported_naming_mechanisms;
 CSI::IdentityTokenType supported_identity_types;
};

// type used in the body of a TAG_CSI_SEC_MECH_LIST component to
// describe a compound mechanism

struct CompoundSecMech {
 AssociationOptions target_requires;
 IOP::TaggedComponent transport_mech;
 AS_ContextSec as_context_mech;
 SAS_ContextSec sas_context_mech;
};

typedef sequence <CompoundSecMech> CompoundSecMechanisms;

```

```
// type corresponding to the body of a TAG_CSI_SEC_MECH_LIST
// component

struct CompoundSecMechList {
 boolean stateful;
 CompoundSecMechanisms mechanism_list;
};

struct TransportAddress {
 string host_name;
 unsigned short port;
};

typedef sequence <TransportAddress> TransportAddressList;

// Tagged component for configuring SECIOP as a CSIV2 transport mechanism

const IOP::ComponentId TAG_SECIOP_SEC_TRANS = 35;

struct SECIOP_SEC_TRANS {
 AssociationOptions target_supports;
 AssociationOptions target_requires;
 CSI::OID mech_oid;
 CSI::GSS_NT_ExportedName target_name;
 TransportAddressList addresses;
};

// tagged component for configuring TLS/SSL as a CSIV2 transport mechanism

const IOP::ComponentId TAG_TLS_SEC_TRANS = 36;

struct TLS_SEC_TRANS {
 AssociationOptions target_supports;
 AssociationOptions target_requires;
 TransportAddressList addresses;
};

}; //CSIOP

#endif
```



# OMGIDLTags

# A

This appendix lists the standardized profile, service, component, policy tags and exception codes described in the CORBA documentation. Implementor-defined tags can also be registered in this manual. Requests to register tags with the OMG should be sent to [tag\\_request@omg.org](mailto:tag_request@omg.org).

## A.1 Profile ID Tags

| Tag Name  | Tag Value                   | Described in                                                                                            |
|-----------|-----------------------------|---------------------------------------------------------------------------------------------------------|
| ProfileId | TAG_INTERNET_IOP = 0        | <i>ORB Interoperability Architecture</i> chapter, “Interoperable Object References: IORs” section.      |
| ProfileId | TAG_MULTIPLE_COMPONENTS = 1 | <i>ORB Interoperability Architecture</i> chapter, “An Information Model for Object References” section. |
| ProfileId | TAG_SCCP_IOP = 2            | CORBA/TC Interworking specification (formal/00-01-01)                                                   |

## A.2 Service ID Tags

| Tag Name  | Tag Value                     | Described in                                                                               |
|-----------|-------------------------------|--------------------------------------------------------------------------------------------|
| ServiceId | TransactionService = 0        | Transaction Service specification (formal/01-11-03)                                        |
| ServiceId | CodeSets = 1                  | <i>ORB Interoperability Architecture</i> chapter, “Code Set Conversion Framework” section. |
| ServiceId | ChainBypassCheck = 2          | <i>Interoperability with non-CORBA Systems</i> chapter, “Chain Bypass” section.            |
| ServiceId | ChainBypassInfo = 3           | <i>Interoperability with non-CORBA Systems</i> chapter, “Chain Bypass” section.            |
| ServiceId | LogicalThreadId = 4           | <i>Interoperability with non-CORBA Systems</i> chapter, “Thread Identification” section.   |
| ServiceId | BI_DIR_IIOB = 5               | <i>General Inter-ORB Protocol</i> chapter, “Bi-Directional GIOP” section.                  |
| ServiceId | SendingContextRunTime = 6     | <i>Value Type Semantics</i> chapter, “Access to the Sending Context Run Time” section.     |
| ServiceId | INVOCATION_POLICIES = 7       | CORBA Messaging chapter, “Propogation of Messaging QoS” section.                           |
| ServiceId | FORWARDED_IDENTITY = 8        | Firewall specification (orbos/98-05-04)                                                    |
| ServiceId | UnknownExceptionInfo = 9      | Java to IDL Language Mapping specification (formal/01-06-07)                               |
| ServiceId | RTCorbaPriority = 10          | Real-Time CORBA, v1.1 (formal/02-xx-xx), “Client Propagated Priority Model” section.       |
| ServiceId | RTCorbaPriorityRange = 11     | Real-Time CORBA, v1.1 (formal/02-xx-xx), “Binding of Priority Banded Connection” section.  |
| ServiceId | FT_GROUP_VERSION = 12         | Fault Tolerant CORBA chapter, “TAG_FT_GROUP Component” section.                            |
| ServiceId | FT_REQUEST= 13                | Fault Tolerant CORBA chapter, “FT_REQUEST Service Context” section.                        |
| ServiceId | ExceptionDetailMessage = 14   | ORB Interoperability Architecture chapter, “Standard Service Contexts” section.            |
| ServiceId | SecurityAttributeService = 15 | Secure Interoperability chapter, “The Security Attribute Service Context Element” section. |
| ServiceId | ActivityService = 16          | Additional Structuring Mechanisms for the OTS (orbos/01-11-08).                            |
| ServiceId | RMICustomMaxStreamFormat = 17 | Java to IDL Language Mapping specification (formal/01-06-07).                              |



### A.3 Component ID Tags

| Tag Name    | Tag Value                         | Described in                                                                               |
|-------------|-----------------------------------|--------------------------------------------------------------------------------------------|
| ComponentId | TAG_ORB_TYPE = 0                  | <i>ORB Interoperability Architecture</i> chapter, “TAG_ORB_TYPE Component” section.        |
| ComponentId | TAG_CODE_SETS = 1                 | <i>ORB Interoperability Architecture</i> chapter, “Code Set Conversion Framework” section. |
| ComponentId | TAG_POLICIES = 2                  | <i>CORBA Messaging</i> chapter, “Propogation of Messaging QoS” section.                    |
| ComponentId | TAG_ALTERNATE_IIOB_ADDRESS = 3    | <i>General Inter-ORB Protocol</i> chapter, “IIOB IOR Profile Components” section.          |
| ComponentId | TAG_COMPLETE_OBJECT_KEY = 5       | <i>The DCE ESIOP</i> chapter, “Complete Object Key Component” section.                     |
| ComponentId | TAG_ENDPOINT_ID_POSITION = 6      | <i>The DCE ESIOP</i> chapter, “Endpoint ID Position Component” section.                    |
| ComponentId | TAG_LOCATION_POLICY = 12          | <i>The DCE ESIOP</i> chapter, “Location Policy Component” section.                         |
| ComponentId | TAG_ASSOCIATION_OPTIONS = 13      | Security Service specification (formal/02-03-11)                                           |
| ComponentId | TAG_SEC_NAME = 14                 |                                                                                            |
| ComponentId | TAG_SPKM_1_SEC_MECH = 15          |                                                                                            |
| ComponentId | TAG_SPKM_2_SEC_MECH = 16          |                                                                                            |
| ComponentId | TAG_KerberosV5_SEC_MECH = 17      |                                                                                            |
| ComponentId | TAG_CSI_ECMA_Secret_SEC_MECH = 18 |                                                                                            |
| ComponentId | TAG_CSI_ECMA_Hybrid_SEC_MECH = 19 |                                                                                            |
| ComponentId | TAG_SSL_SEC_TRANS = 20            |                                                                                            |
| ComponentId | TAG_CSI_ECMA_Public_SEC_MECH = 21 |                                                                                            |
| ComponentId | TAG_GENERIC_SEC_MECH = 22         |                                                                                            |
| ComponentId | TAG_FIREWALL_TRANS = 23           | Firewall specification (orbos/98-05-04)                                                    |
| ComponentId | TAG_SCCP_CONTACT_INFO = 24        | CORBA/TC Interworking specification (formal/00-01-01)                                      |
| ComponentId | TAG_JAVA_CODEBASE = 25            | Java to IDL Language Mapping specification (formal/01-06-07)                               |
| ComponentId | TAG_TRANSACTION_POLICY = 26       | Object Transaction Service specification (formal/01-11-03).                                |
| ComponentId | TAG_FT_GROUP= 27                  | <i>Fault Tolerant CORBA</i> chapter, “TAG_FT_GROUP Component” section                      |
| ComponentId | TAG_FT_PRIMARY= 28                | <i>Fault Tolerant CORBA</i> chapter, “TAG_FT_PRIMARY Component” section.                   |
| ComponentId | TAG_FT_HEARTBEAT_ENABLED = 29     | <i>Fault Tolerant CORBA</i> chapter, “TAG_FT_HEARTBEAT_ENABLED” section.                   |

| Tag Name    | Tag Value                             | Described in                                                               |
|-------------|---------------------------------------|----------------------------------------------------------------------------|
| ComponentId | TAG_MESSAGE_ROUTERS = 30              | <i>CORBA Messaging</i> chapter, “Routing Object References” section.       |
| ComponentId | TAG_OTS_POLICY = 31                   | Object Transaction Service specification (formal/01-11-03)                 |
| ComponentId | TAG_INV_POLICY = 32                   | Object Transaction Service specification (formal/01-11-03)                 |
| ComponentId | TAG_CSI_SEC_MECH_LIST = 33            | <i>Secure Interoperability</i> chapter, “TAG_CSI_SEC_MECH_LIST” section.   |
| ComponentId | TAG_NULL_TAG = 34                     | <i>Secure Interoperability</i> chapter, “TAG_NULL_TAG” section.            |
| ComponentId | TAG_SECIOP_SEC_TRANS = 35             | <i>Secure Interoperability</i> chapter, “TAG_SECIOP_SEC_TRANS”             |
| ComponentId | TAG_TLS_SEC_TRANS = 36                | <i>Secure Interoperability</i> chapter, “TAG_TLS_SEC_TRANS” section.       |
| ComponentId | TAG_ACTIVITY_POLICY = 37              | Additional Structuring Mechanisms for OTS (orbos/01-11-08).                |
| ComponentId | TAG_RMI_CUSTOM_MAX_STREAM_FORMAT = 38 | Java-IDL                                                                   |
| ComponentId | TAG_DCE_STRING_BINDING = 100          | <i>The DCE ESIOP</i> chapter, “DCE-CIOP String Binding Component” section. |
| ComponentId | TAG_DCE_BINDING_NAME = 101            | <i>The DCE ESIOP</i> chapter, “DCE-CIOP Binding Name Component” section.   |
| ComponentId | TAG_DCE_NO_PIPES = 102                | <i>The DCE ESIOP</i> chapter, “DCE-CIOP No Pipes Component” section.       |
| ComponentId | TAG_DCE_SEC_MECH = 103                | Security Service specification (formal/02-03-11)                           |
| ComponentId | TAG_INET_SEC_TRANS = 123              | Security Service specification (formal/02-03-11)                           |

## A.4 Policy Type Tags

The table below lists the standard policy types that are defined by various parts of CORBA and CORBA Services in this version of CORBA/IIOP.

| Policy Type                         | Policy Interface                            | Defined in                                        | Uses create_policy |
|-------------------------------------|---------------------------------------------|---------------------------------------------------|--------------------|
| SecClientInvocationAccess = 1       | SecurityAdmin::AccessPolicy                 | Security Service (formal/02-03-11)                | N                  |
| SecTargetInvocationAccess = 2       | SecurityAdmin::AccessPolicy                 |                                                   | N                  |
| SecApplicationAccess = 3            | SecurityAdmin::AccessPolicy                 |                                                   | N                  |
| SecClientInvocationAudit = 4        | SecurityAdmin::AuditPolicy                  |                                                   | N                  |
| SecTargetInvocationAudit = 5        | SecurityAdmin::AuditPolicy                  |                                                   | N                  |
| SecApplicationAudit = 6             | SecurityAdmin::AuditPolicy                  |                                                   | N                  |
| SecDelegation = 7                   | SecurityAdmin::Delegation Policy            |                                                   | N                  |
| SecClientSecureInvocation = 8       | SecurityAdmin::SecureInvocationPolicy       |                                                   | N                  |
| SecTargetSecureInvocation = 9       | SecurityAdmin::SecureInvocationPolicy       |                                                   | N                  |
| SecNonRepudiation = 10              | NRService::NRPolicy                         |                                                   | N                  |
| SecConstruction = 11                | CORBA::SecConstruction                      | CORBA Core - ORB Interface (chapter 4)            | N                  |
| SecMechanismPolicy = 12             | SecurityLevel2::MechanismPolicy             | Security Service (formal/02-03-11)                | Y                  |
| SecInvocationCredentialsPolicy = 13 | SecurityLevel2::InvocationCredentialsPolicy |                                                   | Y                  |
| SecFeaturesPolicy = 14              | SecurityLevel2::FeaturesPolicy              |                                                   | Y                  |
| SecQOPPolicy = 15                   | SecurityLevel2::QOPPolicy                   |                                                   | Y                  |
| THREAD_POLICY_ID = 16               | PortableServer::ThreadPolicy                | CORBA Core - Portable Object Adapter (chapter 11) | Y                  |
| LIFESPAN_POLICY_ID = 17             | PortableServer::LifespanPolicy              |                                                   | Y                  |
| ID_UNIQUENESS_POLICY_ID = 18        | PortableServer::IdUniquenessPolicy          |                                                   | Y                  |
| ID_ASSIGNMENT_POLICY_ID = 19        | PortableServer::IdAssignmentPolicy          |                                                   | Y                  |
| IMPLICIT_ACTIVATION_POLICY_ID = 20  | PortableServer::ImplicitActivationPolicy    |                                                   | Y                  |
| SERVENT_RETENTION_POLICY_ID = 21    | PortableServer::ServentRetentionPolicy      |                                                   | Y                  |
| REQUEST_PROCESSING_POLICY_ID = 22   | PortableServer::RequestProcessingPolicy     |                                                   | Y                  |

| Policy Type                                 | Policy Interface                          | Defined in                                           | Uses create_policy |
|---------------------------------------------|-------------------------------------------|------------------------------------------------------|--------------------|
| REBIND_POLICY_TYPE = 23                     | Messaging::RebindPolicy                   | CORBA Core Asynchronous Messaging (chapter 22)       | Y                  |
| SYNC_SCOPE_POLICY_TYPE = 24                 | Messaging::SyncScopePolicy                |                                                      | Y                  |
| REQUEST_PRIORITY_POLICY_TYPE = 25           | Messaging::RequestPriorityPolicy          |                                                      | Y                  |
| REPLY_PRIORITY_POLICY_TYPE = 26             | Messaging::ReplyPriorityPolicy            |                                                      | Y                  |
| REQUEST_START_TIME_POLICY_TYPE = 27         | Messaging::RequestStartTimePolicy         |                                                      | Y                  |
| REQUEST_END_TIME_POLICY_TYPE = 28           | Messaging::RequestEndTimePolicy           |                                                      | Y                  |
| REPLY_START_TIME_POLICY_TYPE = 29           | Messaging::ReplyStartTimePolicy           |                                                      | Y                  |
| REPLY_END_TIME_POLICY_TYPE = 30             | Messaging::ReplyEndTimePolicy             |                                                      | Y                  |
| RELATIVE_REQ_TIMEOUT_POLICY_TYPE = 31       | Messaging::RelativeRequestTimeoutPolicy   |                                                      | Y                  |
| RELATIVE_RT_TIMEOUT_POLICY_TYPE = 32        | Messaging::RelativeRoundtripPolicy        |                                                      | Y                  |
| ROUTING_POLICY_TYPE = 33                    | Messaging::RoutingPolicy                  |                                                      | Y                  |
| MAX_HOPS_POLICY_TYPE = 34                   | Messaging::MaxHopsPolicy                  |                                                      | Y                  |
| QUEUE_ORDER_POLICY_TYPE = 35                | Messaging::QueueOrderPolicy               |                                                      | Y                  |
| FIREWALL_POLICY_TYPE = 36                   | Firewall::FirewallPolicy                  | Firewall (orbos/98-05-04)                            | Y                  |
| BIDIRECTIONAL_POLICY_TYPE = 37              | BiDirPolicy::BidirectionalPolicy          | CORBA Core - General Inter-ORB Protocol (chapter 15) | Y                  |
| SecDelegationDirectivePolicy = 38           | SecurityLevel2::DelegationDirectivePolicy | Security Service (formal/02-03-11)                   | Y                  |
| SecEstablishTrustPolicy = 39                | SecurityLevel2::EstablishTrustPolicy      |                                                      | Y                  |
| PRIORITY_MODEL_POLICY_TYPE = 40             | RTCORBA::PriorityModelPolicy              | Real-Time CORBA , v1.1 (formal/02-xx-xx)             | Y                  |
| THREADPOOL_POLICY_TYPE = 41                 | RTCORBA::ThreadpoolPolicy                 |                                                      | Y                  |
| SERVER_PROTOCOL_POLICY_TYPE = 42            | RTCORBA::ServerProtocolPolicy             |                                                      | Y                  |
| CLIENT_PROTOCOL_POLICY_TYPE = 43            | RTCORBA::ClientProtocolPolicy             |                                                      | Y                  |
| PRIVATE_CONNECTION_POLICY_TYPE = 44         | RTCORBA::PrivateConnectionpolicy          |                                                      | Y                  |
| PRIORITY_BANDED_CONNECTION_POLICY_TYPE = 45 | RTCORBA::PriorityBandedConnectionPolicy   |                                                      | Y                  |

| Policy Type                        | Policy Interface                           | Defined in                                               | Uses create_policy |
|------------------------------------|--------------------------------------------|----------------------------------------------------------|--------------------|
| TransactionPolicyType = 46         | CosTransactions::TransactionPolicy         | Object Transaction Service (formal/01-11-03)             | Y                  |
| IMMEDIATE_SUSPEND_POLICY_TYPE = 50 | valuetype MessageRouting::ImmediateSuspend | CORBA Core-Asynchronous Messaging (chapter 22)           | N                  |
| UNLIMITED_PING_POLICY_TYPE = 51    | valuetype MessageRouting::UnlimitedPing    |                                                          | N                  |
| LIMITED_PING_POLICY_TYPE = 52      | valuetype MessageRouting::LimitedPing      |                                                          | N                  |
| DECAY_POLICY_TYPE = 53             | valuetype MessageRouting::DecayPolicy      |                                                          | N                  |
| RESUME_POLICY_TYPE = 54            | valuetype MessageRouting::ResumePolicy     |                                                          | N                  |
| INVOCATION_POLICY_TYPE = 55        | CosTransactions::InvocationPolicy          | Object Transaction Service (formal/01-11-03)             | Y                  |
| OTS_POLICY_TYPE = 56               | CosTransactions::OTSPolicy                 |                                                          | Y                  |
| NON_TX_TARGET_POLICY_TYPE = 57     | CosTransactions::NonTxTargetPolicy         |                                                          | Y                  |
| ActivityPolicyType = 58            | CORBA::PolicyType                          | Additional Structuring Mechanisms for OTS (ptc/01-10-16) | Y                  |
| OSA_MANAGER_POLICY = 59            |                                            | Security Domain Membership (orbos/01-06-01)              |                    |
| ODM_MANAGER_POLICY = 60            |                                            | Security Domain Membership (orbos/01-06-01)              |                    |

## A.5 Exception Codes

If an exception that is to be raised for an error condition does not explicitly specify a specific standard minor code for that error condition, implementations can either use a minor code of zero, or use a vendor-specific minor code to convey more detail about the error.

The following table specifies standard minor exception codes that have been assigned for the standard system exceptions. The actual value that is to be found in the **minor** field of the **ex\_body** structure is obtained by or-ing the values in this table with the **OMGVMCID** constant. For example “Missing local value implementation” for the exception **NO\_IMPLEMENT** would be denoted by the **minor** value **0x4f4d0001**.

| SYSTEM EXCEPTION   | MINOR CODE | EXPLANATION                                                                                                                                                                                                                                                              |
|--------------------|------------|--------------------------------------------------------------------------------------------------------------------------------------------------------------------------------------------------------------------------------------------------------------------------|
| ACTIVITY_COMPLETED | 1          | Indicates that the Activity context in which the method call was made has been completed due to a timeout of either the Activity itself or a transaction that encompasses the Activity, or that the Activity completed in a manner other than that originally requested. |
| ACTIVITY_REQUIRED  | 1          | Indicates that an Activity context was necessary to perform the invoked operation, but one was not found associated with the calling thread.                                                                                                                             |
| BAD_CONTEXT        | 1          | IDL context not found.                                                                                                                                                                                                                                                   |
|                    | 2          | No matching IDL context property.                                                                                                                                                                                                                                        |
| BAD_INV_ORDER      | 1          | Dependency exists in IFR preventing destruction of this object.                                                                                                                                                                                                          |
|                    | 2          | Attempt to destroy indestructible objects in IFR.                                                                                                                                                                                                                        |
|                    | 3          | Operation would deadlock.                                                                                                                                                                                                                                                |
|                    | 4          | ORB has shutdown                                                                                                                                                                                                                                                         |
|                    | 5          | Attempt to invoke send or invoke operation of the same Request object more than once.                                                                                                                                                                                    |
|                    | 6          | Attempt to set a servant manager after one has already been set.                                                                                                                                                                                                         |
|                    | 7          | ServerRequest::arguments called more than once or after a call to ServerRequest:: set_exception.                                                                                                                                                                         |
|                    | 8          | ServerRequest::ctx called more than once or before ServerRequest::arguments or after ServerRequest::ctx, ServerRequest::set_result or ServerRequest::set_exception.                                                                                                      |
|                    | 9          | ServerRequest::set_result called more than once or before ServerRequest::arguments or after ServerRequest::set_result or ServerRequest::set_exception.                                                                                                                   |
|                    | 10         | Attempt to send a DII request after it was sent previously.                                                                                                                                                                                                              |
|                    | 11         | Attempt to poll a DII request or to retrieve its result before the request was sent.                                                                                                                                                                                     |
|                    | 12         | Attempt to poll a DII request or to retrieve its result after the result was retrieved previously.                                                                                                                                                                       |
|                    | 13         | Attempt to poll a synchronous DII request or to retrieve results from a synchronous DII request.                                                                                                                                                                         |
|                    | 14         | Invalid portable interceptor call.                                                                                                                                                                                                                                       |
|                    | 15         | Service context add failed in portable interceptor because a service context with the given id already exists.                                                                                                                                                           |
|                    | 16         | Registration of PolicyFactory failed because a factory already exists for the given PolicyType.                                                                                                                                                                          |

| SYSTEM EXCEPTION | MINOR CODE | EXPLANATION                                                                                         |
|------------------|------------|-----------------------------------------------------------------------------------------------------|
| BAD_INV_ORDER    | 17         | POA cannot create POAs while undergoing destruction                                                 |
|                  | 18         | Attempt to reassign priority.                                                                       |
|                  | 19         | An OTS/XA integration <b>xa_start</b> call returned <b>XAER_OUTSIDE</b> .                           |
|                  | 20         | An OTS/XA integration <b>xa_</b> call returned <b>XAER_PROTO</b> .                                  |
| BAD_OPERATION    | 1          | ServantManager returned wrong servant type.                                                         |
|                  | 2          | Operation or attribute not known to target object                                                   |
| BAD_PARAM        | 1          | Failure to register, unregister, or lookup value factory.                                           |
|                  | 2          | RID already defined in IFR.                                                                         |
|                  | 3          | Name already used in the context in IFR.                                                            |
|                  | 4          | Target is not a valid container.                                                                    |
|                  | 5          | Name clash in inherited context.                                                                    |
|                  | 6          | Incorrect type for abstract interface.                                                              |
|                  | 7          | string_to_object conversion failed due to bad scheme name.                                          |
|                  | 8          | string_to_object conversion failed due to bad address.                                              |
|                  | 9          | string_to_object conversion failed due to bad bad schema specific part.                             |
|                  | 10         | string_to_object conversion failed due to non specific reason.                                      |
|                  | 11         | Attempt to derive abstract interface from non-abstract base interface in the Interface Repository.  |
|                  | 12         | Attempt to let a ValueDef support more than one non-abstract interface in the Interface Repository. |
|                  | 13         | Attempt to use an incomplete TypeCode as a parameter.                                               |
|                  | 14         | Invalid object id passed to POA::create_reference_by_id.                                            |
|                  | 15         | Bad name argument in TypeCode operation.                                                            |
|                  | 16         | Bad RepositoryId argument in TypeCode operation.                                                    |
|                  | 17         | Invalid member name in TypeCode operation.                                                          |
|                  | 18         | Duplicate label value in create_union_tc.                                                           |
|                  | 19         | Incompatible TypeCode of label and discriminator in create_union_tc.                                |
|                  | 20         | Supplied discriminator type illegitimate in create_union_tc.                                        |
|                  | 21         | Any passed to ServerRequest::set_exception does not contain an exception.                           |
|                  | 22         | Unlisted user exception passed to ServerRequest::set_exception.                                     |
|                  | 23         | wchar transmission code set not in service context.                                                 |

| SYSTEM EXCEPTION | MINOR CODE                                                    | EXPLANATION                                                                                                                                                                                                                                                                              |
|------------------|---------------------------------------------------------------|------------------------------------------------------------------------------------------------------------------------------------------------------------------------------------------------------------------------------------------------------------------------------------------|
| BAD_PARAM        | 24                                                            | Service context is not in OMG-defined range.                                                                                                                                                                                                                                             |
|                  | 25                                                            | Enum value out of range.                                                                                                                                                                                                                                                                 |
|                  | 26                                                            | Invalid service context Id in portable interceptor                                                                                                                                                                                                                                       |
|                  | 27                                                            | Attempt to call register_initial_reference with a null Object                                                                                                                                                                                                                            |
|                  | 28                                                            | Invalid component Id in portable interceptor                                                                                                                                                                                                                                             |
|                  | 29                                                            | Invalid profile Id in portable interceptor                                                                                                                                                                                                                                               |
|                  | 30                                                            | Two or more Policy objects with the same PolicyType value supplied to Object::set_policy_overrides or PolicyManager::set_policy_overrides.                                                                                                                                               |
|                  | 31                                                            | Attempt to define a oneway operation with non-void result, out or inout parameters or user exceptions.                                                                                                                                                                                   |
|                  | 32                                                            | DII asked to create request for an implicit operation.                                                                                                                                                                                                                                   |
|                  | 33                                                            | An OTS/XA integration <b>xa_</b> call returned <b>XAER_INVALID</b> .                                                                                                                                                                                                                     |
|                  | 34                                                            | Union branch modifier called with bad case label discriminator.                                                                                                                                                                                                                          |
|                  | 35                                                            | Illegal IDL context property name.                                                                                                                                                                                                                                                       |
|                  | 36                                                            | Illegal IDL property search string.                                                                                                                                                                                                                                                      |
|                  | 37                                                            | Illegal IDL context name.                                                                                                                                                                                                                                                                |
|                  | 38                                                            | Non-empty IDL context.                                                                                                                                                                                                                                                                   |
|                  | 39                                                            | Unsupported RMI/IDL custom value type stream format.                                                                                                                                                                                                                                     |
|                  | 40                                                            | ORB output stream does not support ValueOutputStream interface.                                                                                                                                                                                                                          |
| 41               | ORB input stream does not support ValueInputStream interface. |                                                                                                                                                                                                                                                                                          |
| BAD_TYPECODE     | 1                                                             | Attempt to marshal incomplete TypeCode.                                                                                                                                                                                                                                                  |
|                  | 2                                                             | Member type code illegitimate in TypeCode operation.                                                                                                                                                                                                                                     |
|                  | 3                                                             | Illegal parameter type.                                                                                                                                                                                                                                                                  |
| DATA_CONVERSION  | 1                                                             | Character does not map to negotiated transmission code set.                                                                                                                                                                                                                              |
|                  | 2                                                             | Failure of <b>PriorityMapping</b> object.                                                                                                                                                                                                                                                |
| IMP_LIMIT        | 1                                                             | Unable to use any profile in IOR.                                                                                                                                                                                                                                                        |
| INITIALIZE       | 1                                                             | Priority range too restricted for ORB.                                                                                                                                                                                                                                                   |
| INTERNAL         | 1                                                             | An OTS/XA integration <b>xa_</b> call returned <b>XAER_RMERR</b> .                                                                                                                                                                                                                       |
|                  | 2                                                             | An OTS/XA integration <b>xa_</b> call returned <b>XAER_RMFAIL</b> .                                                                                                                                                                                                                      |
| INTF_REPOS       | 1                                                             | Interface Repository not available                                                                                                                                                                                                                                                       |
|                  | 2                                                             | No entry for requested interface in Interface Repository                                                                                                                                                                                                                                 |
| INVALID_ACTIVITY | 1                                                             | May be raised on the Activity or Transaction services' resume methods if a transaction or Activity is resumed in a context different to that from which it was suspended. It is also raised when an attempted invocation is made that is incompatible with the Activity's current state. |



| SYSTEM EXCEPTION | MINOR CODE | EXPLANATION                                                                                                  |
|------------------|------------|--------------------------------------------------------------------------------------------------------------|
| INV_OBJREF       | 1          | wchar Code Set support not specified.                                                                        |
|                  | 2          | Codeset component required for type using wchar or wstring data                                              |
| INV_POLICY       | 1          | Unable to reconcile IOR specified policy with effective policy override.                                     |
|                  | 2          | Invalid PolicyType.                                                                                          |
|                  | 3          | No PolicyFactory has been registered for the given PolicyType.                                               |
| MARSHAL          | 1          | Unable to locate value factory.                                                                              |
|                  | 2          | ServerRequest::set_result called before ServerRequest::ctx when the operation IDL contains a context clause. |
|                  | 3          | NVList passed to ServerRequest::arguments does not describe all parameters passed by client.                 |
|                  | 4          | Attempt to marshal Local object.                                                                             |
|                  | 5          | wchar or wstring data erroneously sent by client over GIOP 1.0 connection                                    |
|                  | 6          | wchar or wstring data erroneously returned by server over GIOP 1.0 connection.                               |
|                  | 7          | Unsupported RMI/IDL custom value type stream format.                                                         |
| NO_IMPLEMENT     | 1          | Missing local value implementation.                                                                          |
|                  | 2          | Incompatible value implementation version.                                                                   |
|                  | 3          | Unable to use any profile in IOR.                                                                            |
|                  | 4          | Attempt to use DII on Local object.                                                                          |
|                  | 5          | Biomolecular Sequence Analysis iterator cannot be reset.                                                     |
|                  | 6          | Biomolecular Sequence Analysis metadata is not available as XML.                                             |
|                  | 7          | Genomic Maps iterator cannot be rest.                                                                        |
| NO_RESOURCES     | 1          | Portable Interceptor operation not supported in this binding.                                                |
|                  | 2          | No connection for request's priority.                                                                        |
| OBJ_ADAPTER      | 1          | System exception in AdapterActivator::unknown_adapter.                                                       |
|                  | 2          | Incorrect servant type returned by servant manager.                                                          |
|                  | 3          | No default servant available [POA policy].                                                                   |
|                  | 4          | No servant manager available [POA Policy].                                                                   |
|                  | 5          | Violation of POA policy by ServantActivator::incarnate.                                                      |
|                  | 6          | Exception in <b>PortableInterceptor::IORInterceptor.components_established</b> .                             |
|                  | 7          | Null servant returned by servant manager                                                                     |

| SYSTEM EXCEPTION       | MINOR CODE | EXPLANATION                                                                                                       |
|------------------------|------------|-------------------------------------------------------------------------------------------------------------------|
| OBJECT_NOT_EXIST       | 1          | Attempt to pass an unactivated (unregistered) value as an object reference.                                       |
|                        | 2          | Failed to create or locate Object Adapter.                                                                        |
|                        | 3          | Biomolecular Sequence Analysis Service is no longer available.                                                    |
|                        | 4          | Object Adapter inactive.                                                                                          |
| TRANSACTION_ROLLEDBACK | 1          | An OTS/XA integration <b>xa_</b> call returned <b>XAER_RB</b> .                                                   |
|                        | 2          | An OTS/XA integration <b>xa_</b> call returned <b>XAER_NOTA</b> .                                                 |
|                        | 3          | OTS/XA integration <b>end</b> was called with success set to <b>TRUE</b> while transaction rollback was deferred. |
| TRANSIENT              | 1          | Request discarded because of resource exhaustion in POA, or because POA is in <b>discarding</b> state.            |
|                        | 2          | No usable profile in IOR.                                                                                         |
|                        | 3          | Request cancelled.                                                                                                |
|                        | 4          | POA destroyed.                                                                                                    |
| UNKNOWN                | 1          | Unlisted user exception received by client.                                                                       |
|                        | 2          | Non-standard System Exception not supported.                                                                      |
|                        | 3          | An unknown user exception received by a portable interceptor                                                      |

## Glossary

---

|                                           |                                                                                                                                                                                                                                                                                                                                                                                                                                                                                                                                                                                                                                         |
|-------------------------------------------|-----------------------------------------------------------------------------------------------------------------------------------------------------------------------------------------------------------------------------------------------------------------------------------------------------------------------------------------------------------------------------------------------------------------------------------------------------------------------------------------------------------------------------------------------------------------------------------------------------------------------------------------|
| <b>activation</b>                         | Preparing an object to execute an operation. For example, copying the persistent form of methods and stored data into an executable address space to allow execution of the methods on the stored data.                                                                                                                                                                                                                                                                                                                                                                                                                                 |
| <b>active replication</b>                 | All of the members of an object group independently execute the methods invoked on the object, so that if a fault prevents one replica from operating correctly, the other replicas will produce the required results without the delay incurred by recovery.                                                                                                                                                                                                                                                                                                                                                                           |
| <b>active replication with voting</b>     | Active replication where the requests (replies) from the members of a client (server) object group are voted, and are delivered to the members of the server (client) object group only if a majority of the requests (replies) are identical.                                                                                                                                                                                                                                                                                                                                                                                          |
| <b>adapter</b>                            | Same as object adapter.                                                                                                                                                                                                                                                                                                                                                                                                                                                                                                                                                                                                                 |
| <b>application-controlled consistency</b> | A ConsistencyStyle in which the application is responsible for checkpointing, logging, activation and recovery, and for maintaining whatever kind of consistency is appropriate for the application.                                                                                                                                                                                                                                                                                                                                                                                                                                    |
| <b>application-controlled membership</b>  | A MembershipStyle in which the application, or an application-level manager, can create a member of the object group and then invoke the <code>add_member()</code> operation of the ObjectGroupManager interface to cause the Replication Manager to add the member to the group. Alternatively, the application can invoke the <code>create_member()</code> operation of the ObjectGroupManager interface to cause the Replication Manager to create the member and add it to the object group. The application is responsible for enforcing the <code>InitialNumberReplicas</code> and <code>MinimumNumberReplicas</code> properties. |
| <b>attribute</b>                          | An identifiable association between an object and a value. An attribute <b>A</b> is made visible to clients as a pair of operations: <b>get_A</b> and <b>set_A</b> . Readonly attributes only generate a <b>get</b> operation.                                                                                                                                                                                                                                                                                                                                                                                                          |

---

|                                 |                                                                                                                                                                                                                                                                                                                                                                                                                                                                                                                                                                                                                                      |
|---------------------------------|--------------------------------------------------------------------------------------------------------------------------------------------------------------------------------------------------------------------------------------------------------------------------------------------------------------------------------------------------------------------------------------------------------------------------------------------------------------------------------------------------------------------------------------------------------------------------------------------------------------------------------------|
| <b>backup member</b>            | In passive replication, a member of an object group that does not execute the methods invoked on the object group but is available to assume the role of the primary member in the event of a fault.                                                                                                                                                                                                                                                                                                                                                                                                                                 |
| <b>behavior</b>                 | The observable effects of an object performing the requested operation including its results binding. See language binding, dynamic invocation, static invocation, or method resolution for alternatives.                                                                                                                                                                                                                                                                                                                                                                                                                            |
| <b>byzantine fault</b>          | A form of commission fault that occurs when an object or host generates incorrect results maliciously.                                                                                                                                                                                                                                                                                                                                                                                                                                                                                                                               |
| <b>causal order</b>             | <p>Causal order ensures that if a multicast message m1 could have caused, possibly indirectly, a message m2 then no object receives m2 before it receives m1. The <i>causally precedes</i> relation is the transitive closure of:</p> <ul style="list-style-type: none"> <li>• If message m1 is delivered to object replica O before O sends message m2, then m1 causally precedes m2.</li> <li>• If object replica O sends message m1 before message m2, then m1 causally precedes m2.</li> <li>• If both m1 and m2 are delivered to object replica O, and m1 causally precedes m2, then m1 is delivered to O before m2.</li> </ul> |
| <b>checkpoint</b>               | A snapshot of the state of an object.                                                                                                                                                                                                                                                                                                                                                                                                                                                                                                                                                                                                |
| <b>checkpoint interval</b>      | An interval of time (in seconds and nanoseconds) between writing the full state of an object to a log.                                                                                                                                                                                                                                                                                                                                                                                                                                                                                                                               |
| <b>class</b>                    | See interface and implementation for alternatives.                                                                                                                                                                                                                                                                                                                                                                                                                                                                                                                                                                                   |
| <b>client</b>                   | The code or process that invokes an operation on an object.                                                                                                                                                                                                                                                                                                                                                                                                                                                                                                                                                                          |
| <b>cold passive replication</b> | A form of passive replication in which only one replica, the primary replica, in the object group executes the methods invoked on the object. The state of the primary replica is extracted from the log and is loaded into the backup replica when needed for recovery.                                                                                                                                                                                                                                                                                                                                                             |
| <b>commission fault</b>         | A commission fault occurs when an object or host generates incorrect results. Commission faults must be handled by active replication with majority voting.                                                                                                                                                                                                                                                                                                                                                                                                                                                                          |
| <b>ConsistencyStyle</b>         | The value of the ConsistencyStyle is either CONS_INF_CTRL or CONS_APP_CTRL.                                                                                                                                                                                                                                                                                                                                                                                                                                                                                                                                                          |
| <b>context object</b>           | A collection of name-value pairs that provides environmental or user-preference information.                                                                                                                                                                                                                                                                                                                                                                                                                                                                                                                                         |
| <b>CORBA</b>                    | Common Object Request Broker Architecture.                                                                                                                                                                                                                                                                                                                                                                                                                                                                                                                                                                                           |
| <b>data type</b>                | A categorization of values operation arguments, typically covering both behavior and representation (i.e., the traditional non-OO programming language notion of type).                                                                                                                                                                                                                                                                                                                                                                                                                                                              |
| <b>deactivation</b>             | The opposite of activation.                                                                                                                                                                                                                                                                                                                                                                                                                                                                                                                                                                                                          |

---

|                                          |                                                                                                                                                                                                                                                                                                                                     |
|------------------------------------------|-------------------------------------------------------------------------------------------------------------------------------------------------------------------------------------------------------------------------------------------------------------------------------------------------------------------------------------|
| <b>deferred synchronous request</b>      | A request where the client does not wait for completion of the request, but does intend to accept results later. Contrast with synchronous request and one-way request.                                                                                                                                                             |
| <b>distributed logging</b>               | A logging strategy in which a co-located log is maintained for each replica of an object.                                                                                                                                                                                                                                           |
| <b>domain</b>                            | A concept important to interoperability, it is a distinct scope, within which common characteristics are exhibited, common rules observed, and over which a distribution transparency is preserved.                                                                                                                                 |
| <b>duplicates</b>                        | Duplicate requests and duplicate replies can arise in active replication and in passive replication when the primary fails and a new primary is introduced. To maintain exactly once semantics and strong replica consistency, the Fault Tolerance Infrastructure provides mechanisms to detect and suppress duplicates.            |
| <b>dynamic invocation</b>                | Constructing and issuing a request whose signature is possibly not known until run-time.                                                                                                                                                                                                                                            |
| <b>dynamic skeleton</b>                  | An interface-independent kind of skeleton, used by servers to handle requests whose signatures are possibly not known until run-time.                                                                                                                                                                                               |
| <b>externalized object reference</b>     | An object reference expressed as an ORB-specific string. Suitable for storage in files or other external media.                                                                                                                                                                                                                     |
| <b>failure</b>                           | A failure is the event of a system's generating a result that does not satisfy the system specification or not generating a result that is required by the system specification. A failure is defined by the system specification, without reference to any enclosing system of which the system is a component.                    |
| <b>fault</b>                             | A fault is behavior of a component of a system that causes incorrect behavior of the system. A fault is the external manifestation of a failure of the component.                                                                                                                                                                   |
| <b>fault analyzer</b>                    | A component of the Fault Tolerance Infrastructure that registers for fault notifications and aggregates multiple related fault notifications into a single fault report.                                                                                                                                                            |
| <b>fault containment region</b>          | One or more locations that can be affected by a single fault. Each member of an object group is assigned to a different fault containment region to ensure that, if one member incurs a fault, the other members are not affected.                                                                                                  |
| <b>fault monitor</b>                     | A component of the system, also known as a Fault Detector, that monitors the occurrence of faults in other entities, such as objects, hosts, processes, and networks. Fault detectors are typically based on timeouts and are unreliable (inaccurate) because they cannot determine whether an entity has failed or is merely slow. |
| <b>FaultMonitoringGranularity</b>        | The value of the FaultMonitoringGranularity of an object group is either MEMB, LOC, or LOC_AND_TYPE. The FaultMonitoringGranularity provides a means of scalably monitoring the members of many object groups.                                                                                                                      |
| <b>FaultMonitoringIntervalAndTimeout</b> | The value of the FaultMonitoringIntervalAndTimeout is a structure that contains an interval of time between successive pings of an object, and the time allowed for subsequent responses from the object to determine whether it is faulty.                                                                                         |

---

|                                         |                                                                                                                                                                                                                                                                                                                                                                          |
|-----------------------------------------|--------------------------------------------------------------------------------------------------------------------------------------------------------------------------------------------------------------------------------------------------------------------------------------------------------------------------------------------------------------------------|
| <b>FaultMonitoringStyle</b>             | The value of the FaultMonitoringStyle is either PULL, PUSH, or NOT_MONITORED.                                                                                                                                                                                                                                                                                            |
| <b>fault tolerance</b>                  | The ability to provide continuous service, unperturbed by the presence of faults. In contrast, with high availability, existing operations can be disrupted by a fault but subsequent new operations, or retired existing operations, are serviced.                                                                                                                      |
| <b>fault tolerance domain</b>           | For scalability, large applications are divided into multiple fault tolerance domains, each managed by a single Replication Manager. The members of an object group are located within a single fault tolerance domain but can invoke, or can be invoked by, objects of other fault tolerance domains. A host can support objects from multiple fault tolerance domains. |
| <b>fault transparency</b>               | A server object group is fault transparent to a client object if, in the presence of a faulty server replica, the server object group interacts with the client object as if there were no faults.                                                                                                                                                                       |
| <b>FT_GROUP_VERSION Service Context</b> | A service context, included in a request message, that allows a server to determine whether the client is using an obstacle object group reference and, if so, to return a LOCATION_FORWARD_PERM response that contains the most recent object reference for the server object group.                                                                                    |
| <b>FT_REQUEST Service Context</b>       | A service context, included in a request message, that allows a server to detect and suppress duplicate requests and to garbage collect requests that are obsolete.                                                                                                                                                                                                      |
| <b>gateway</b>                          | A gateway provides access into a fault tolerance domain for objects outside that domain, and provides protocol conversion between the IIOP protocol used outside the fault tolerance domain and the group communication protocol used inside that domain.                                                                                                                |
| <b>GenericFactory</b>                   | An interface of the Replication Manager that creates object groups, as well as individual members of object groups.                                                                                                                                                                                                                                                      |
| <b>group communication protocol</b>     | A protocol that provides communication between object groups, typically multicasting, reliable delivery, causal ordering, total ordering, group membership, and virtual synchrony.                                                                                                                                                                                       |
| <b>group membership</b>                 | The set of members of a group, which may change dynamically in time, as members fail and are removed from the group and as new and recovered members are added.                                                                                                                                                                                                          |
| <b>FT_GROUP_VERSION Service Context</b> | A service context, included in a request message, that allows a server to determine whether the client is using an obstacle object group reference and, if so, to return a LOCATION_FORWARD_PERM response that contains the most recent object reference for the server object group.                                                                                    |
| <b>HEARTBEAT_POLICY</b>                 | A client-side policy that allows a client to request heartbeating to determine that its connection to a server has failed.                                                                                                                                                                                                                                               |
| <b>HEARTBEAT_ENABLED_POLICY</b>         | A server-side policy that allows a client to determine that its connection to a server has failed.                                                                                                                                                                                                                                                                       |

---

|                                              |                                                                                                                                                                                                                                                                                                                                                                                                                                                           |
|----------------------------------------------|-----------------------------------------------------------------------------------------------------------------------------------------------------------------------------------------------------------------------------------------------------------------------------------------------------------------------------------------------------------------------------------------------------------------------------------------------------------|
| <b>implementation</b>                        | A definition that provides the information needed to create an object and allow the object to participate in providing an appropriate set of services. An implementation typically includes a description of the data structure used to represent the core state associated with an object, as well as definitions of the methods that access that data structure. It will also typically include information about the intended interface of the object. |
| <b>implementation definition language</b>    | A notation for describing implementations. The implementation definition language is currently beyond the scope of the ORB standard. It may contain vendor-specific and adapter-specific notations.                                                                                                                                                                                                                                                       |
| <b>implementation inheritance</b>            | The construction of an implementation by incremental modification of other implementations. The ORB does not provide implementation inheritance. Implementation inheritance may be provided by higher level tools.                                                                                                                                                                                                                                        |
| <b>implementation object</b>                 | An object that serves as an implementation definition. Implementation objects reside in an implementation repository.                                                                                                                                                                                                                                                                                                                                     |
| <b>implementation repository</b>             | A storage place for object implementation information.                                                                                                                                                                                                                                                                                                                                                                                                    |
| <b>incremental state transfer</b>            | A form of state transfer that is used for transferring large states of an object in fragments.                                                                                                                                                                                                                                                                                                                                                            |
| <b>Infrastructure-Controlled Consistency</b> | A ConsistencyStyle in which the Fault Tolerance Infrastructure is responsible for checkpointing, logging, activation and recovery and for maintaining Strong Replica Consistency.                                                                                                                                                                                                                                                                         |
| <b>Infrastructure-Controlled Membership</b>  | A MembershipStyle in which the application directs the Replication Manager to create the object group and the Replication Manager invokes the individual factories, for the appropriate locations, to create the members of the object group both initially to satisfy the InitialReplicas property and after the loss of a member because of a fault to satisfy the MinimumNumberReplicas property.                                                      |
| <b>inheritance</b>                           | The construction of a definition by incremental modification of other definitions. See <i>interface</i> and <i>implementation inheritance</i> .                                                                                                                                                                                                                                                                                                           |
| <b>InitialNumberReplicas</b>                 | The InitialNumberReplicas property of an object group specifies the number of replicas of the object to be created when the object group is first created.                                                                                                                                                                                                                                                                                                |
| <b>instance</b>                              | An object is an instance of an interface if it provides the operations, signatures and semantics specified by that interface. An object is an instance of an implementation if its behavior is provided by that implementation.                                                                                                                                                                                                                           |
| <b>interface</b>                             | A listing of the operations and attributes that an object provides. This includes the signatures of the operations, and the types of the attributes. An interface definition ideally includes the semantics as well. An object <i>satisfies</i> an interface if it can be specified as the target object in each potential request described by the interface.                                                                                            |
| <b>interface inheritance</b>                 | The construction of an interface by incremental modification of other interfaces. The IDL language provides interface inheritance.                                                                                                                                                                                                                                                                                                                        |

---

|                                      |                                                                                                                                                                                                                                                                                                                                                                                |
|--------------------------------------|--------------------------------------------------------------------------------------------------------------------------------------------------------------------------------------------------------------------------------------------------------------------------------------------------------------------------------------------------------------------------------|
| <b>interface object</b>              | An object that serves to describe an interface. Interface objects reside in an interface repository.                                                                                                                                                                                                                                                                           |
| <b>interface repository</b>          | A storage place for interface information.                                                                                                                                                                                                                                                                                                                                     |
| <b>interface type</b>                | A type satisfied by any object that satisfies a particular interface.                                                                                                                                                                                                                                                                                                          |
| <b>interoperability</b>              | The ability for two or more ORBs to cooperate to deliver requests to the proper object. Interoperating ORBs appear to a client to be a single ORB.                                                                                                                                                                                                                             |
| <b>language binding or mapping</b>   | The means and conventions by which a programmer writing in a specific programming language accesses ORB capabilities.                                                                                                                                                                                                                                                          |
| <b>location</b>                      | A set of hosts that form a single fault containment region. Members of object groups are created at different locations.                                                                                                                                                                                                                                                       |
| <b>log</b>                           | A record of messages and object states that is created to ensure that recovery is possible after a fault.                                                                                                                                                                                                                                                                      |
| <b>LoggingMechanism</b>              | A component of the Fault Tolerance Infrastructure that records all of the actions of an object group in a log.                                                                                                                                                                                                                                                                 |
| <b>MembershipStyle</b>               | The value of the MembershipStyle of an object group is either MEMB_INF_CTRL or MEMB_APP_CTRL.                                                                                                                                                                                                                                                                                  |
| <b>membership handling mechanism</b> | A component of the Fault Tolerance Infrastructure that ensures that GIOP messages addressed to object groups are delivered to the appropriate members of those groups. It detects and suppresses duplicate messages, passes messages to the Logging Mechanism to put into the log, and applies to the objects messages that the Recovery Mechanism has retrieved from the log. |
| <b>method</b>                        | An implementation of an operation. Code that may be executed to perform a requested service. Methods associated with an object may be structured into one or more programs.                                                                                                                                                                                                    |
| <b>method resolution</b>             | The selection of the method to perform a requested operation.                                                                                                                                                                                                                                                                                                                  |
| <b>MinimumNumberReplicas</b>         | The MinimumNumberReplicas property of an object group specifies the smallest number of replicas of the object needed to maintain the desired fault tolerance. The application or the Replication Manager creates additional replicas of the object to ensure that the number of replicas does not fall below the specified minimum number.                                     |
| <b>multicasting</b>                  | For replicated client and server objects, messages are originated by a client (server) within a client (server) object group and are multicast to the client and server object groups. Messages are delivered to the members of both the client and server object groups to facilitate the detection and suppression of duplicates.                                            |
| <b>multiple inheritance</b>          | The construction of a definition by incremental modification of more than one other definition.                                                                                                                                                                                                                                                                                |
| <b>object</b>                        | A combination of state and a set of methods that explicitly embodies an abstraction characterized by the behavior of relevant requests. An object is an instance of                                                                                                                                                                                                            |



---

|                               |                                                                                                                                                                                                                                                                                                                                                                                                                                                                                                                                                                                                                                                                    |
|-------------------------------|--------------------------------------------------------------------------------------------------------------------------------------------------------------------------------------------------------------------------------------------------------------------------------------------------------------------------------------------------------------------------------------------------------------------------------------------------------------------------------------------------------------------------------------------------------------------------------------------------------------------------------------------------------------------|
|                               | <p>an implementation and an interface. An object models a real-world entity, and it is implemented as a computational entity that encapsulates state and operations (internally implemented as data and methods) and responds to request or services.</p>                                                                                                                                                                                                                                                                                                                                                                                                          |
| <b>object adapter</b>         | <p>The ORB component which provides object reference, activation, and state related services to an object implementation. There may be different adapters provided for different kinds of implementations.</p>                                                                                                                                                                                                                                                                                                                                                                                                                                                     |
| <b>object creation</b>        | <p>An event that causes the existence of an object that is distinct from any other object.</p>                                                                                                                                                                                                                                                                                                                                                                                                                                                                                                                                                                     |
| <b>object destruction</b>     | <p>An event that causes an object to cease to exist.</p>                                                                                                                                                                                                                                                                                                                                                                                                                                                                                                                                                                                                           |
| <b>object group</b>           | <p>A set of member objects, each of which implements the same set of interfaces and has the same implementation code.</p>                                                                                                                                                                                                                                                                                                                                                                                                                                                                                                                                          |
| <b>ObjectGroupManager</b>     | <p>An interface of the Replication Manager that contains operations for creating a member of an object group at a particular location, adding a member to an object group at a particular location, removing a member from an object group at a particular location, getting the locations of the members of an object group, and setting the primary member of a passively replicated object group.</p>                                                                                                                                                                                                                                                           |
| <b>object group reference</b> | <p>An interoperable object reference that contains multiple TAG_INTERNET_IOP profiles that represent primary and backup members of a passively replicated object group or that represent gateways. All of the TAG_INTERNET_IOP profiles contain a TAG_FT_GROUP component that contains the fault tolerance domain identifier, object group identifier, and object group reference version number for the server object group. If the profiles are those of members of a passively replicated server object group, then one of the profiles contains the TAG_FT_PRIMARY component for the profile that addresses the primary member of the server object group.</p> |
| <b>object implementation</b>  | <p>Same as implementation.</p>                                                                                                                                                                                                                                                                                                                                                                                                                                                                                                                                                                                                                                     |
| <b>object reference</b>       | <p>A value that unambiguously identifies an object. Object references are never reused to identify another object.</p>                                                                                                                                                                                                                                                                                                                                                                                                                                                                                                                                             |
| <b>objref</b>                 | <p>An abbreviation for object reference.</p>                                                                                                                                                                                                                                                                                                                                                                                                                                                                                                                                                                                                                       |
| <b>one-way request</b>        | <p>A request where the client does not wait for completion of the request, nor does it intend to accept results. Contrast with deferred synchronous request and synchronous request.</p>                                                                                                                                                                                                                                                                                                                                                                                                                                                                           |
| <b>operation</b>              | <p>A service that can be requested. An operation has an associated signature, which may restrict which actual parameters are valid.</p>                                                                                                                                                                                                                                                                                                                                                                                                                                                                                                                            |
| <b>operation name</b>         | <p>A name used in a request to identify an operation.</p>                                                                                                                                                                                                                                                                                                                                                                                                                                                                                                                                                                                                          |
| <b>ORB</b>                    | <p>Object Request Broker. Provides the means by which clients make and receive requests and responses.</p>                                                                                                                                                                                                                                                                                                                                                                                                                                                                                                                                                         |

---

|                                |                                                                                                                                                                                                                                                                                                                                                                                                                                    |
|--------------------------------|------------------------------------------------------------------------------------------------------------------------------------------------------------------------------------------------------------------------------------------------------------------------------------------------------------------------------------------------------------------------------------------------------------------------------------|
| <b>ORB core</b>                | The ORB component which moves a request from a client to the appropriate adapter for the target object.                                                                                                                                                                                                                                                                                                                            |
| <b>parameter passing mode</b>  | Describes the direction of information flow for an operation parameter. The parameter passing modes are IN, OUT, and INOUT.                                                                                                                                                                                                                                                                                                        |
| <b>passive replication</b>     | Only the primary member of an object group executes the methods that have been invoked on the object group. The object group contains additional backup replicas.                                                                                                                                                                                                                                                                  |
| <b>persistent object</b>       | An object that can survive the process or thread that created it. A persistent object exists until it is explicitly deleted.                                                                                                                                                                                                                                                                                                       |
| <b>portable object adapter</b> | The object adapter described in Chapter 9.                                                                                                                                                                                                                                                                                                                                                                                         |
| <b>primary member</b>          | In passive replication, the member of an object group that executes the methods invoked on the object group.                                                                                                                                                                                                                                                                                                                       |
| <b>property manager</b>        | An interface of the Replication Manager that contains operations for setting and getting the fault tolerance properties.                                                                                                                                                                                                                                                                                                           |
| <b>pull monitor</b>            | A Fault Monitor that interrogates the monitored object periodically to determine whether it is alive.                                                                                                                                                                                                                                                                                                                              |
| <b>push monitor</b>            | A Fault Monitor to which the monitored object periodically reports that it is alive.                                                                                                                                                                                                                                                                                                                                               |
| <b>recovery</b>                | The restoration of the state of a member of an object group so that it can continue the operation of the object group.                                                                                                                                                                                                                                                                                                             |
| <b>recovery mechanism</b>      | A component of the Fault Tolerance Infrastructure that sets the state of a member of an object group, either when a backup member is promoted to be the primary member after a fault occurs, or alternatively when a new member is introduced into the group.                                                                                                                                                                      |
| <b>referential integrity</b>   | The property ensuring that an object reference that exists in the state associated with an object reliably identifies a single object.                                                                                                                                                                                                                                                                                             |
| <b>reliable delivery</b>       | Every message addressed to a group, or originated by a group, is delivered to every member of the group, except for members suspected of being faulty.                                                                                                                                                                                                                                                                             |
| <b>replica determinism</b>     | Replica determinism requires that two or more members of an object group, when presented with the same sequence of requests and replies, behave in exactly the same manner.                                                                                                                                                                                                                                                        |
| <b>replication</b>             | The fundamental technique used in building fault-tolerant systems.                                                                                                                                                                                                                                                                                                                                                                 |
| <b>replication manager</b>     | A component of the Fault Tolerance Infrastructure that provides access to the Fault Notifier and that inherits three interfaces. PropertyManager, GenericFactory and ObjectGroupManager. Logically, there is one Replication Manager per fault tolerance domain. The Replication Manager interacts with the Fault Monitors and Fault Notifier, and with the Logging and Recovery Mechanisms of the Fault Tolerance Infrastructure. |

---

|                                 |                                                                                                                                                                                                                                                                                                                 |
|---------------------------------|-----------------------------------------------------------------------------------------------------------------------------------------------------------------------------------------------------------------------------------------------------------------------------------------------------------------|
| <b>ReplicationStyle</b>         | The value of the ReplicationStyle of an object group is either STATELESS, COLD_PASSIVE, WARM_PASSIVE, ACTIVE, or ACTIVE_WITH_VOTING.                                                                                                                                                                            |
| <b>replication transparency</b> | A client object is unaware that it is interacting with a group of server objects, but rather “thinks” that it is interacting with an individual server object.                                                                                                                                                  |
| <b>repository</b>               | See interface repository and implementation repository.                                                                                                                                                                                                                                                         |
| <b>repository identifier</b>    | The identifier of a type within the Interface Repository.                                                                                                                                                                                                                                                       |
| <b>request</b>                  | A client issues a request to cause a service to be performed. A request consists of an operation and zero or more actual parameters.                                                                                                                                                                            |
| <b>REQUEST_DURATION_POLICY</b>  | A client-side policy that defines the time interval over which a client’s request to a server remains valid and should be retained by the server ORB to detect repeated requests.                                                                                                                               |
| <b>results</b>                  | The information returned to the client, which may include values as well as status information indicating that exceptional conditions were raised in attempting to perform the requested service.                                                                                                               |
| <b>server</b>                   | A process implementing one or more operations on one or more objects.                                                                                                                                                                                                                                           |
| <b>server object</b>            | An object providing response to a request for a service. A given object may be a client for some requests and a server for other requests.                                                                                                                                                                      |
| <b>shared logging</b>           | A logging strategy in which the primary member of an object group logs its state by writing the log records onto stable storage.                                                                                                                                                                                |
| <b>signature</b>                | Defines the parameters of a given operation including their number order, data types, and passing mode; the results if any; and the possible outcomes (normal vs. exceptional) that might occur.                                                                                                                |
| <b>single inheritance</b>       | The construction of a definition by incremental modification of one definition. Contrast with multiple inheritance.                                                                                                                                                                                             |
| <b>skeleton</b>                 | The object-interface-specific ORB component which assists an object adapter in passing requests to particular methods.                                                                                                                                                                                          |
| <b>state</b>                    | The time-varying properties of an object that affect that object’s behavior.                                                                                                                                                                                                                                    |
| <b>state transfer</b>           | In both passive and active replication, when a new or recovered member of an object group is activated, a state transfer is required to transfer the state of the object to the new or recovered member, so that the new or recovered member will have the same state as the other members of the object group. |
| <b>stateless object</b>         | The behavior of a stateless object is unaffected by its history of invocations. A typical example of a stateless object is a server that provides read-only access to a database.                                                                                                                               |
| <b>static invocation</b>        | Constructing a request at compile time. Calling an operation via a stub procedure.                                                                                                                                                                                                                              |

---

|                                           |                                                                                                                                                                                                                                                                                                                                                                                                                                                                                                                              |
|-------------------------------------------|------------------------------------------------------------------------------------------------------------------------------------------------------------------------------------------------------------------------------------------------------------------------------------------------------------------------------------------------------------------------------------------------------------------------------------------------------------------------------------------------------------------------------|
| <b>strong membership consistency</b>      | Strong Membership Consistency means that, for each method invocation on an object group, the Fault Tolerance Infrastructure on all hosts agree on the membership of the object group.                                                                                                                                                                                                                                                                                                                                        |
| <b>strong replica consistency</b>         | For passive replication, Strong Replica Consistency means that, at the end of each state transfer, each of the members of the object group have the same state. For active replication, Strong Replica Consistency means that, at the end of each method invocation on the object group, each of the members of the object group have the same state.                                                                                                                                                                        |
| <b>stub</b>                               | A local procedure corresponding to a single operation that invokes that operation when called.                                                                                                                                                                                                                                                                                                                                                                                                                               |
| <b>synchronous request</b>                | A request where the client pauses to wait for completion of the request. Contrast with deferred synchronous request and one-way request.                                                                                                                                                                                                                                                                                                                                                                                     |
| <b>TAG_FT_GROUP Component</b>             | A component of all of the profiles of the Object Group Reference that contains the fault tolerance domain identifier, object group identifier, and object group reference version number of the server object group with that reference.                                                                                                                                                                                                                                                                                     |
| <b>TAG_FT_HEARTBEAT_ENABLED Component</b> | A component of a TAG_INTERNET_IOP profile of an object group reference that indicates that a member of a server object group, or gateway, is heartbeat enabled.                                                                                                                                                                                                                                                                                                                                                              |
| <b>TAG_FT_PRIMARY Component</b>           | A component of one of the TAG_INTERNET_IOP profiles of an object group reference that is intended to address the primary member of the object group, and that indicates that this TAG_INTERNET_IOP profile should be used in preference to other TAG_INTERNET_IOP profiles within the object group reference.                                                                                                                                                                                                                |
| <b>total order</b>                        | <p>The <i>ordered before</i> relation is the transitive closure of:</p> <ul style="list-style-type: none"> <li>• If message m1 is delivered to object replica O before message m2 is delivered to O, then m1 is ordered before m2.</li> <li>• If message m1 precedes message m2, then m1 is ordered before m2.</li> <li>• If both m1 and m2 are delivered to object replica O, and m1 is ordered before m2, then m1 is delivered to O before m2 is delivered to O.</li> </ul> <p>The ordered before relation is acyclic.</p> |
| <b>transient object</b>                   | An object whose existence is limited by the lifetime of the process or thread that created it.                                                                                                                                                                                                                                                                                                                                                                                                                               |
| <b>type</b>                               | See <i>data type</i> and <i>interface</i> .                                                                                                                                                                                                                                                                                                                                                                                                                                                                                  |
| <b>unique primary replica</b>             | For passive replication, one and only one member of the object group executes the methods invoked on the object group.                                                                                                                                                                                                                                                                                                                                                                                                       |
| <b>unreplicated client object</b>         | An unreplicated client object communicates with a replicated server object using IOP. The client may communicate directly with a member of the server object group or, if multicasting is provided, the client may communicate with a gateway, which then multicasts the message to the server object group.                                                                                                                                                                                                                 |

---

**value**

Any entity that may be a possible actual parameter in a request. Values that serve to identify objects are called object references.

**virtual synchrony**

If object replicas O1 and O2 are in the same view of the object group membership M and they transition together to the next view of the object group membership M', then the same messages are delivered to O1 and O2 while they are members of M. Virtual synchrony is used to ensure that a state transfer to initialize a new member of object group membership M occurs at the point in the message order corresponding to a membership change. Thus, at the start of the next view of the object group membership M', all of the members in M' will have the same state.

**warm passive replication**

A form of passive replication in which only the primary member executes the methods invoked on the object group by the client objects. Several other members operate as backups. The backups do not execute the methods invoked on the object group; rather, the state of the primary is transferred to the backups periodically.



# CORBA 3 Chapter Map

The following chapters represent the structure of the CORBA 3.0 specification. This is a new version that includes changes as shown in the table below. You will find specific changes marked with change bars and colored text in the change bar version of CORBA 3.0.

| <b>CORBA 3.0 chapters:</b>                  | <b>Changes based on these OMG documents:</b>                                                                |
|---------------------------------------------|-------------------------------------------------------------------------------------------------------------|
| 1. The Object Model                         | unchanged                                                                                                   |
| 2. CORBA Overview                           | unchanged                                                                                                   |
| 3. OMG IDL Syntax and Semantics             | CORE RTF, Components FTF                                                                                    |
| 4. ORB Interface                            | CORE RTF, Components FTF, Object Reference Template available specification                                 |
| 5. Value Type Semantics                     | unchanged                                                                                                   |
| 6. Abstract Interface Semantics             | editorial changes only                                                                                      |
| 7. Dynamic Invocation Interface             | CORE 12/2000 RTF, Components specification                                                                  |
| 8. Dynamic Skeleton Interface               | unchanged                                                                                                   |
| 9. Dynamic Management of Any Values         | CORE 12/2000 RTF, Components specification                                                                  |
| 10. Interface Repository                    | CORE 12/2000 RTF, Interop 12/2000 RTF, Components specification + FTF                                       |
| 11. Portable Object Adapter                 | CORE RTF, Components specification, Object Reference Template available specification                       |
| 12. Interoperability Overview               | unchanged                                                                                                   |
| 13. ORB Interoperability Architecture       | CORE/Interop 12.2000 RTF, Components specification + FTF, Object Reference Template available specification |
| 14. Building Inter-ORB Bridges              | unchanged                                                                                                   |
| 15. General Inter-ORB Protocol              | CORE/Interop RTF, Components specification                                                                  |
| 16. The DCE ESIOP                           | unchanged                                                                                                   |
| 17. Interworking Architecture               | unchanged                                                                                                   |
| 18. Mapping: COM and CORBA                  | unchanged                                                                                                   |
| 19. Mapping: OLE Automation and CORBA       | unchanged                                                                                                   |
| 20. Interoperability with non-CORBA Systems | unchanged                                                                                                   |
| 21. Portable Interceptors                   | CORE 12/2000 RTF, Object Reference Template available specification                                         |
| 22. CORBA Messaging                         | CORE 12/2000 RTF                                                                                            |
| 23. Minimum CORBA                           | removed - now a stand-alone document (formal/02-xx-xx)                                                      |
| 24. Real-Time CORBA                         | removed - now a stand-alone document (formal/02-xx-xx)<br>CORE 12/2000 RTF                                  |
| 23. Fault Tolerant CORBA                    | text unchanged, chapter was renumbered                                                                      |
| 24. Secure Interoperability                 | text unchanged, chapter was renumbered                                                                      |
| Appendix A - OMG IDL Tags                   | CORE RTF, Components FTF                                                                                    |
| Glossary, Index                             | updated                                                                                                     |

## Approved OMG Documents

The following is an alphabetical list of the approved technology documents that comprise the CORBA 3.0 release:

- Core RTF 12/2000
  - ptc/02-01-13 - Final report
  - ptc/02-01-14 - Core 3.0 draft changed chapters CORBA 2.6 + Core 12/2000 RTF + Components FTF
  - ptc/02-01-15 - CORBA Core 3.0 IDL
  
- Interop RTF 12/2000
  - ptc/02-01-14 - Core 3.0 draft changed chapters CORBA 2.6 + Core 12/2000 RTF + Components FTF
  - ptc/02-01-15 - CORBA Core 3.0 IDL
  - ptc/02-01-18 - Interop RTF Report
  
- Components
  - ptc/00-12-05 - FTF Final report
  - ptc/01-11-03 - updated CCM specification
  
- Object Reference Template
  - ptc/01-08-31 - Final adopted specification
  - ptc/01-10-23 - FTF Final report
  - ptc/01-01-04 - submission



**A**

- abstract interface 1-7
- Abstract Interfaces
  - Semantics of 6-1
- Abstract interfaces 6-1
- Abstract Model Description
  - Dynamic Skeleton Interface 11-13
  - Implicit Activation 11-10
  - Location Transparency 11-14
  - Model Architecture 11-4
  - Model Components 11-2
  - Multi-threading 11-11
  - Object Activation States 11-8
  - POA Creation 11-6
  - Reference Creation 11-7
  - Request Processing 11-9
- abstract object model 1-1
- AbstractInterfaceDef 10-39, 10-41
- activation 1-10
- ACTIVE 22-62
- AdapterActivator 11-7
- add\_pollable 7-15
- Aggregation of Automation Views 19-38
- AliasDef 10-28
  - OMG IDL for 10-28
- alignment 15-11
- AMI/THI Abstract Model Design 22-75
- AMI/THI abstract model design 22-75
- any type 3-39, 7-2, 15-29, 18-9, 18-39
- Any values
  - dynamic management overview 9-2
- array
  - sample mapping to OLE collection 19-49
  - syntax of 3-46
- ArrayDef 10-31
  - OMG IDL for 10-31
- associated\_handler 22-25
- Async Operation Mapping 22-16
- async operation mapping 22-16
- Asynchronous Method Invocation (AMI) 22-75
- Asynchronous Method Invocation Components 22-75
- Asynchronous Method Signatures 22-30
- asynchrony
  - and narrowing of object references 22-81
- AsyncOperation Mapping
  - Callback Model Signatures (sendc) 22-16
  - Polling Model Signatures (sendp) 22-18
- attribute
  - defined 1-9
  - mapped to OLE 19-4
  - mapping to COM 18-24
  - mapping to OLE Automation 17-10
- attribute associated\_handler 22-52
- Attribute Declaration 3-53
- attribute declaration
  - syntax of 3-53
- Attribute\_Def
  - OMG IDL for 10-32
- AttributeDef 10-32, 10-33
- Automation View Dual interface, default name 17-31
- Automation View interface 19-3, 19-15

- non-dual 19-36
- Automation View Interface as a Dispatch Interface (Nondual) 19-36
- Automation View interface class id 17-32
- Automation View interface, default name 17-30

**B**

- backoff\_factor 22-63
- base interface 3-23
- base\_interval\_seconds 22-63
- basic object adapter 19-38
- Basic types 1-4
- Basic Type-Specific Poller 22-26
- Basics
  - Interface Repository Objects 10-6
  - Names and Identifiers 10-6
  - Structure and Navigation of the Interface Repository 10-8
  - Types and TypeCodes 10-6
- Bi-Directional GIOP 15-56
  - Bi-Directional IIOP 15-58
- Bi-directional GIOP policy 15-60
- big-endian 15-7
- binding 17-20
- Binding and Life Cycle 17-20
- BindingIterator interface 19-59
- blocking 22-51
- body 22-49
- boolean 19-59
- boolean is\_a operation
  - OMG PIDL for 4-16
- boolean types 3-39, 15-10
- Bootstrapping Bridges 14-7
- bridge
  - architecture of inter-ORB 13-2
  - in networks 13-11
  - inter-domain 13-9
  - inter-ORB 12-2, 12-5, 13-6
  - locality 17-33
- Bridging 14-2
- bridging techniques 13-8

**C**

- C++
  - sample COM mapping 18-16
- C++ Language
  - Usage in 9-26
- Callback Model
  - Exception Delivery 22-20
  - exception delivery in 22-20
  - signatures 22-16
- Callback Model Detailed Design 22-78
- CDR 15-4
  - features of 15-3
- CDR Transfer Syntax 15-4
  - Alignment 15-5
  - Boolean 15-10
  - Character Types 15-10
  - Encapsulation 15-14
  - Floating Point Data Types 15-7
  - Integer Data Types 15-6
  - Object References 15-30

- Octet 15-10
- OMG IDL Constructed Types 15-11
- Primitive Types 15-5
- Pseudo-Object Types 15-23
- Value Types 15-15
- Chain Avoidance
  - COM Chain Avoidance 20-17
  - CORBA Chain Avoidance 20-16
- Chain Bypass
  - COM Chain Bypass 20-20
  - CORBA Chain Bypass 20-19
  - Thread Identification 20-21
- char type 3-39
- Client
  - Structure 2-12
- client 2-7
- Client Stubs 2-9
- Clients 2-7
- client-side components
  - Asynchronous Method Invocation (AMI) 22-75
  - Poller 22-75
  - ReplyHandler 22-75
- client-side policies 22-72
- CLSID 17-32, 18-44
- Collocated ORBs 14-4
- COM 18-2
  - described 17-4
- COM to CORBA Data Type Mapping
  - Inheritance Mapping 18-50
  - Interface Mapping 18-44
  - Mapping for Array Types 18-40
  - Mapping for Basic Data Types 18-33
  - Mapping for bounded string types 18-36
  - Mapping for COM Errors 18-44
  - Mapping for Constants 18-34
  - Mapping for Encapsulated Unions 18-38
  - Mapping for Enumerators 18-34
  - Mapping for Interface Identifiers 18-44
  - Mapping for nonencapsulated unions 18-39
  - Mapping for nonfixed arrays 18-40
  - Mapping for Operations 18-47
  - Mapping for Pointers 18-43
  - Mapping for Properties 18-48
  - Mapping for Read-Only Attributes 18-49
  - Mapping for Read-Write Attributes 18-49
  - Mapping for SAFEARRAY 18-40
  - Mapping for String Types 18-35
  - Mapping for Structure Types 18-37
  - Mapping for unbounded string types 18-35
  - Mapping for unicode bound string types 18-37
  - Mapping for Unicode Unbounded String Types 18-36
  - Mapping for Union Types 18-38
  - Mapping for VARIANT 18-41
  - Mapping of Names 18-47
  - Mapping of Nested Data Types 18-47
  - Type Library Mapping 18-52
- COM View interface,default tag 17-30
- COM/CORBA Interworking
  - Compliance to 17-34
- COM/CORBA Part A 20-2
- Common Data Representation
  - see CDR
- Common Data Representation (CDR) 15-3
- Common Data Structures 7-2
- Complex Declarator
  - Arrays 3-46
  - Deprecated Anonymous Types 3-47
- component
  - tags for A-1
- Component Design 22-73
- Component Object Model
  - see COM 17-4
- Component Relationships 22-73, 22-76
- concrete object model 1-1
- Conformance Issues 22-84
  - CORBA Clients for DCOM Servers 20-3
  - Performance Issues 20-3
  - Scalability Issues 20-3
- ConnectionPoint Service 19-52
- Consistency 20-9
- Constant Declaration
  - Semantics 3-33
  - Syntax 3-32
- constant declaration
  - syntax of 3-32
- ConstantDef 10-25
- constructed data types 15-11
- Constructed Recursive Types 3-41
- Constructed types 1-5
- Contained interface
  - OMG IDL for 10-14
- Container interface 10-11
  - OMG IDL for 10-16
- containment 13-6
- Conventions for Naming Components of the
  - Automation View 19-36
- Conversion Errors 19-43
- CORBA
  - Any values
    - dynamic creation of 9-26
    - dynamic interpretation 9-27
  - object references and request level bridging 14-6
- CORBA Exceptions 19-30
- CORBA Module 3-66
- CORBA module
  - types defined by 7-1
- CORBA Required Object Adapter
  - Portable Object Adapter 2-17
- CORBA System Exceptions 19-33
- CORBA User Exceptions 19-31
- CORBA\_free 7-4
- CORBAComposite interface 18-51
- CORBAtoCOM Data Type Mapping 18-2
- CosNaming interface 19-55
- create\_dii\_pollable 7-15
- create\_persistent\_request 22-52
- create\_pollable\_set 7-14
- create\_request operation 4-14
- CreateType method 19-28
- Current 11-45

**D**

- data type
  - basic OMG IDL 3-37–3-39
  - constructed OMG IDL 3-39–3-44
  - constructs for OMG IDL 3-36
  - native 3-38
  - OMG IDL template 3-44–3-45
- Data Type Mapping 18-1
- DCE 12-1, 18-1
- DCE CIOP
  - pipe interface, DCE IDL for 16-6
- DCE CIOP module
  - OMG IDL for 16-25
- DCE Common Inter-ORB Protocol
  - Goals 16-1
- DCE Common Inter-ORB Protocol Overview 16-2
- DCE ESIOP 13-28
  - see also DCE CIOP
- DCE UUID 17-17
- DCE-CIOP
  - storage in IOR 16-5
- DCE-CIOP Data Representation 16-3
- DCE-CIOP Message Formats 16-11
  - DCE\_CIOP Invoke Request Message 16-11
  - DCE-CIOP Invoke Response Message 16-12
  - DCE-CIOP Locate Request Message 16-14
  - DCE-CIOP Locate Response Message 16-15
- DCE-CIOP Message Transport 16-5
  - Array-based Interface 16-8
  - Pipe-based Interface 16-6
- DCE-CIOP Messages 16-4
- DCE-CIOP Object Location 16-21
  - Activation 16-23
  - Basic Location Algorithm 16-23
  - Location Mechanism Overview 16-22
  - Use of the Location Policy and the Endpoint ID 16-24
- DCE-CIOP Object References 16-16
  - Complete Object Key Component 16-19
  - DCE-CIOP Binding Name Component 16-18
  - DCE-CIOP No Pipes Component 16-19
  - DCE-CIOP String Binding Component 16-17
  - Endpoint ID Position Component 16-20
  - Location Policy Component 16-20
- DCE-CIOP RPC 16-2
- DCOM Value Objects
  - DICORBAAny 20-14
  - DICORBAStruct 20-13
  - DICORBATypeCode and ICORBATypeCode 20-13
  - DICORBAUnion 20-13
  - DICORBAUserException 20-13
  - DIForeignComplexType 20-12
  - DIForeignException 20-12
  - DISystemException 20-12
  - ICORBAAny 20-15
  - IForeignObject 20-12
  - Passing Automation Compound Types as DCOM Value Objects 20-11
  - Passing CORBA-Defined Pseudo-Objects as DCOM Value Objects 20-12
  - User Exceptions in COM 20-15
- DCORBATypeCode interface 19-23
- DCORBAUnion interface 19-21
- DCORBAUserException interface 19-32
- deactivation 1-10
- DecayPolicy 22-64
- derived interface 3-23
- DICORBAAny interface 17-27, 19-24
- DICORBAFactory interface 17-25, 19-26, 19-27
- DICORBAStruct interface 19-20
- DICORBASystemException interface 19-34
- DICORBAUnion interface 19-21, 19-22
- DICORBAUserException interface 19-32
- DIForeignComplexType interface 19-19
- DII and DSI 19-38
- DII Deferred Synchronous 22-81
- DIIPollable interface 7-14
- Distribution
  - Bridge Locality 17-32
  - Distribution Architecture 17-33
  - Interworking Targets 17-34
- domain 13-2
  - architecture 13-5
  - containment 13-6
  - federation 13-6
  - naming objects for multiple 13-12
  - object references 13-12
  - object referencing for 13-12–13-14
  - security 14-4
- DSI
  - Language Mapping 8-4
- Dual interface 17-12, 19-4
- Dynamic creation of CORBA
  - Any values 9-26
- Dynamic interpretation of CORBA
  - Any values 9-27
- Dynamic Invocation Interface 2-9, 7-1
- Dynamic Invocation interface 18-29, 19-38
  - overview of 2-4, 2-9
  - parameters 7-2
  - request level bridging 14-6
  - request routines 7-4
- dynamic protocol selection 22-82
- dynamic routing 22-83
- Dynamic Skeleton Interface 2-10, 8-1
- Dynamic Skeleton interface 14-5, 19-38
  - overview of 2-5, 2-10, 8-1
- DynAny 9-2
  - management overview 9-2
- DynAny API 9-3
- DynAny Api
  - Creating a DynAny object 9-9
  - The DynAny interface 9-11
  - The DynArray interface 9-23
  - The DynEnum interface 9-17
  - The DynFixed Interface 9-16
  - The DynSequence interface 9-22
  - The DynStruct interface 9-17
  - The DynUnion interface 9-19
  - The DynValue interface 9-24
  - The DynValueBox interface 9-25
- DynAny interface 9-11

DynAny object  
  basic data type values 9-14  
  copying 9-14  
  creating 9-9  
  destroying 9-13  
  generating an any value from 9-12, 9-13  
  initializing from an any value 9-12  
  initializing from another DynAny object 9-12  
  interface 9-11  
  TypeCode associated with 9-12  
DynArray interface 9-23  
DynArray objects  
  interface 9-23  
DynEnum interface 9-17  
DynEnum objects  
  interface 9-17  
DynFixed interface 9-16  
DynFixed objects  
  interface 9-16  
DynSequence interface 9-22  
DynSequence objects  
  interface 9-22  
DynStruct interface 9-17  
DynStruct objects  
  interface 9-17  
DynUnion interface 9-19  
DynUnion objects  
  interface 9-19  
DynValue interface 9-24  
DynValueBox interface 9-25

**E**  
encapsulation 15-14  
  defined 15-5  
enum 15-12  
EnumDef 10-28  
enumerated types 3-43  
environment specific inter-ORB protocol for  
  OSF's DCE environment  
  see DCE ESIOP  
environment-specific inter\_ORB protocol  
  see ESIOP  
Environment-Specific Inter-ORB Protocols (ESIOPs) 12-4  
ESIOP 12-1, 12-4  
Example Programmer Usage  
  C++ Example of Callback Client Program 22-37  
  C++ Example of Generated ReplyHandler 22-31  
  C++ Example of Polling Client Program 22-39  
  C++ Example of User-Implemented ReplyHandler 22-33  
  C++ Example of Using PollableSet in a Client Program 22-42  
  Client-Side C++ Example for the Asynchronous Method  
    Signatures 22-30  
  Client-Side C++ Example of the Callback Model 22-31  
  Client-Side C++ Example of the Polling Model 22-38  
  Example Programmer Usage (Examples Mapped to C++) 22-30  
Example Programmer Usage  
  Server Side 22-44  
exception 1-8  
Exception Declaration 3-49  
Exception replies 22-79  
ExceptionDef 10-32

ExceptionDef interface  
  OMG IDL for 10-32  
exceptions  
  COM and CORBA compared 18-12  
  COM exception structure example 18-17  
  InvalidState 22-63  
  mapped to COM error codes 18-45, 19-35  
  mapped to COM interfaces 18-20  
  REBIND 4-71  
  TIMEOUT 4-71  
  TRANSACTION\_UNAVAILABLE 4-71  
ExplicitRequest State  
  ServerRequestPseudo-Object 8-3  
expression  
  context 3-53  
  raises 3-52  
Extent Definition  
  DVO\_BLOB 20-8  
  DVO\_EXTENT 20-8  
  DVO\_IFACE 20-8  
  DVO\_IMPLDATA 20-8  
  Extent Format 20-7  
  Marshaling Constraints 20-6  
  Marshaling Key 20-6

**F**  
federation 13-6  
FixedDef 10-30  
floating point data type 15-7  
floating point type 3-38  
foreign object system  
  integration of 2-18  
Foreign Object Systems  
  Integration of 2-17  
Forward Declarations 3-41  
full bridge 14-2

**G**  
General Inter-ORB Protocol  
  Goals 15-2  
general inter-ORB protocol  
  see GIOP  
General Inter-ORB Protocol (GIOP) 12-3  
Generic Bridges 14-6  
Generic Poller Value  
  associated\_handler 22-25  
  is\_from\_poller 22-25  
  operation\_name 22-25  
  operation\_target 22-25  
Generic Poller value 22-24  
get\_client\_policy 4-19  
get\_interface operation 4-14  
  OMG PIDL for 4-14  
get\_interface() operation 10-10  
get\_policy\_overrides 4-19, 4-45  
get\_reply 22-51  
GIOP 12-3, 13-28  
  alignment for primitive data types 15-6  
  and language mapping 15-11  
  and primitive data types 15-3, 15-5, 15-10  
  any type 15-29

- array type 15-12
- cancel request header, OMG IDL for 15-41
- close connection message 15-45
- constructed data types 15-11
- context pseudo object 15-30
- exception 15-30
- floating point data type 15-7
- goals of 15-2
- implementation on various transport protocols 15-47
- integer data types 15-6
- locate reply header, OMG IDL for 15-44
- locate request header, OMG IDL for 15-42
- mapping to TCP/IP transport protocol 15-51
- message header, OMG IDL for 15-32
- message type 15-31
- primitive data types 15-5
- principal pseudo object 15-29
- relationship to IIOP 12-3
- reply message, OMG IDL for 15-39
- request header, OMG IDL for 15-35
- TCKind 15-23
- typecode 15-23
- GIOP Message Formats 15-31
  - CancelRequest Message 15-41
  - CloseConnection Message 15-45
  - Fragment Message 15-45
  - GIOP Message Header 15-31
  - LocateReply Message 15-43
  - LocateRequest Message 15-41
  - MessageError Message 15-45
  - Reply Message 15-37
  - Request Message 15-34
- GIOP Message Overview 15-3
- GIOP Message Transfer 15-4
- GIOP Message Transport 15-47
  - Connection Management 15-47
  - Message Ordering 15-49
- GIOP module 15-34, 15-42
  - OMG IDL for 15-60
- GIOP Overview 15-2
- giop\_version 22-49
- global name 3-68
  - and inheritance 3-68
  - and Interface Repository ScopedName 10-13
- H**
- handler 22-49
- handler\_type 22-49
- hash operation 4-17
- hexadecimal string 13-23
- HRESULT 18-11, 19-5, 19-10, 19-37
  - constants and their values 18-12
- I**
- IConnectionPointContainer interface 19-52
- ICORBAFactory interface 17-24, 17-37
- ICORBAObject interface 17-27
- ICustomer
  - Get\_Profile interface 18-26
- IdAssignmentPolicy 11-32
- identifier 3-21
- IDispatch interface 17-4, 17-11, 19-10
- IDL for PortableServer Module 11-46
- IDL to ODL Mapping 19-12
- IDLType interface 10-11
- IdUniquenessPolicy 11-31
- IEnumConnectionPoints interface 19-53
- IEnumConnections interface 19-53
- IForeignException interface 19-30
- IForeignObject interface 17-26, 17-36, 19-16
- IID 17-17, 17-30, 18-44
- IIOP 13-16, 13-28, 15-2, 15-51, 17-17, 17-32, 17-33
  - defined 15-51
  - host 15-54
  - object key 15-54
  - port 15-54
  - relationship to GIOP 12-3
  - version 15-54
- IIOP module 13-19, 15-53, 15-64
- IIOP profile
  - OMG IDL for 15-52
- ImmediateSuspend 22-63
- IMonikerProvider interface 17-23, 17-36
- implementation
  - defined 1-10
  - model for 1-9
- Implementation Dependencies 10-4
  - Managing Interface Repositories 10-4
- Implementation Repository 2-11
  - overview of 2-11
- Implementation Skeleton 2-9
- implementation skeleton
  - overview of 2-9
- implicit context 13-10, 14-7
- ImplicitActivationPolicy 11-34
- incarnate operation 11-24
- Indirection Levels for Operation Parameters 18-26
- infix operator 3-34
- inheritance
  - COM mapping for 18-26
  - OLE Automation mapping for 19-5
- Inheritance Mapping 18-26
- inheritance, multiple 17-11
- inheritance, single 19-5
- Initial Request Router 22-54
- Initialization interfaces 19-40
- In-line Bridging 14-3
- in-line bridging 14-2
- integer data type 15-6
- integer tdata type 3-38
- interface 1-6
  - defined 1-6
- Interface Composition Mapping
  - CORBA/COM 17-11
  - Detailed Mapping Rules 17-13
  - Example of Applying Ordering Rules 17-14
  - Mapping Interface Identity 17-16
- Interface Composition Mappings 17-11
- Interface Declaration
  - Forward Declaration 3-22
  - Interface Body 3-22
  - Interface Header 3-21

# Index

---

- Interface Inheritance 3-23
- Interface Inheritance Specification 3-21
- interface identifier
  - see IID 17-17
- Interface Mapping 18-11
  - Automation/CORBA 17-10
  - COM/CORBA 17-10
  - CORBA/Automation 17-9
  - CORBA/COM 17-9
- interface object 10-8
- Interface Repository 2-5, 2-11, 10-1
  - AliasDef, OMG IDL 10-28
  - and COM EX repository id 19-31
  - and COM mapping 17-11
  - and identifiers 10-12
  - and request level bridging 14-6
  - ArrayDef, OMG IDL 10-31
  - AttributeDef, OMG IDL 10-32
  - Contained interface, OMG IDL 10-14
  - Container 10-11
  - Container interface, OMG IDL 10-16
  - ExceptionDef interface 10-32
  - IDLType 10-11
  - inserting information 10-4
  - InterfaceDef, OMG IDL 10-36, 10-44
  - IRObjct interface 10-11
  - IRObjct interface, OMG IDL 10-13
  - location of interfaces in 10-9
  - mapped to OLE type library 18-52
  - ModuleDef interface, OMG IDL 10-24
  - OMG IDL for 10-75
  - OperationDef, OMG IDL 10-34
  - overview of 2-11, 10-1
  - PrimitiveDef, OMG IDL 10-29
  - Repository interface, OMG IDL 10-22, 10-52
  - SequenceDef, OMG IDL 10-30
  - StringDef, OMG IDL 10-29
  - StructDef, OMG IDL 10-26
  - TypeCode 4-58
  - TypeCode interface, OMG IDL 4-52
- Interface Repository Interfaces
  - AbstractInterfaceDef 10-39
  - AliasDef 10-28
  - ArrayDef 10-31
  - ConstantDef 10-25
  - Contained 10-14
  - Container 10-16
  - EnumDef 10-28
  - ExceptionDef 10-32
  - FixedDef 10-30
  - IDLType 10-22
  - InterfaceDef 10-36
  - IRObjct 10-13
  - LocalInterfaceDef 10-41
  - ModuleDef 10-24
  - NativeDef 10-50
  - OperationDef 10-34
  - PrimitiveDef 10-29
  - Repository 10-22
  - SequenceDef 10-30
  - StringDef 10-29
- StructDef 10-26
- Supporting Type Definitions 10-12
- TypedefDef 10-26
- UnionDef 10-27
- ValueBoxDef 10-49
- ValueDef 10-44, 10-48
- ValueMemberDef 10-43
- WstringDef 10-30
- Interface Repository Mapping 18-32
- interface repository objects 10-6
- interface type 1-6
- InterfaceDef 10-10, 10-36, 10-38
  - OMG IDL for 10-36, 10-44
- InterfaceDef interface 18-52
- Interfaces 11-14
  - AdapterActivator Interface 11-22
  - attribute associated\_handler 22-52
  - create\_persistent\_request 22-52
  - Current Operations 11-45
  - get\_reply 22-51
  - Handling LOCATION\_FORWARD Replies 22-58
  - Handling of Service Contexts 22-58
  - Initial Request Router 22-54
  - Intermediate Request Router 22-55
  - Invoking Client 22-53
  - PersistentRequest 22-51
  - PersistentRequestRouter 22-52
  - POA Interface 11-34
  - POA Policy Objects 11-30
  - POAManager Interface 11-15
  - readonly attribute reply\_available 22-51
  - reply 22-51
  - ReplyHandler 22-50
  - Replying to a Type-specific ReplyHandler 22-57
  - Replying to an UntypedReplyHandler 22-57
  - Request Routing Algorithm 22-54
  - Router 22-50
  - Routing of Replies 22-58
  - Routing Protocol 22-52
  - send\_multiple\_requests 22-50
  - send\_request 22-50
  - ServantActivator Interface 11-25
  - ServantLocator Interface 11-27
  - ServantManager Interface 11-24
  - Target Router 22-55
  - The Servant IDL Type 11-15
  - UntypedReplyHandler 22-51, 22-58
- interfaces
  - interface MaxHopsPolicy 22-11
  - interface PolicyCurrent 4-46
  - interface PolicyManager 4-45
  - interface Pollable 7-14
  - interface PollableSet 7-14
  - interface QueueOrderPolicy 22-12
  - interface RelativeRequestTimeoutPolicy 22-9
  - interface RelativeRoundtripTimeoutPolicy 22-10
  - interface ReplyEndTimePolicy 22-9
  - interface ReplyPriorityPolicy 22-8
  - interface ReplyStartTimePolicy 22-9
  - interface RequestEndTimePolicy 22-9
  - interface RequestPriorityPolicy 22-7



- interface RequestStartTimePolicy 22-8
- interface RoutingPolicy 22-11
- interface RebindPolicy 22-5
  - PersistentRequest 22-51
  - PersistentRequestRouter 22-52
  - ReplyHandler 22-50
  - Router 22-50
  - RouterAdmin 22-64
  - SyncScopePolicy 22-7
  - UntypedReplyHandler 22-51
- Interface-specific Bridges 14-6
- Intermediate Request Router 22-55
- Internet inter-ORB protocol
  - see IIOP
- Internet Inter-ORB Protocol (IIOP) 12-3, 15-51
  - IIOP IOR Profile Components] 15-55
  - IIOP IOR Profiles 15-52
  - TCP/IP Connection Usage 15-52
- Interoperability Design Goals 12-9
- Interoperability
  - Elements of 12-1
- interoperability
  - architecture of 13-1
  - compliance 12-5
  - domain 13-5
  - examples of 12-5
  - object service-specific information, passing 13-28, 15-4
  - overview of 12-2
  - primitive data types 15-5
  - RFP for 13-1
- Interoperability Design Goals 12-9
- Interoperability Solutions
  - Examples of 12-5
- interoperable object reference
  - see IOR
- Interoperable Object Reference (IOR) 16-5
- Interoperable Routing Protocol 22-76
- Inter-ORB Bridge Support 12-2
- interval\_limit 22-64
- interworking 17-13
  - any type 18-39
  - array to collection mapping 19-49
  - Automation View Dual interface 17-31
  - Automation View interface 17-30, 17-32
  - BindingIterator interface, mapped to ODL 19-59
  - bridges 17-33
  - COM aggregation mechanism 19-38
  - COM data types mapped to CORBA types 18-2
  - COM Service 19-51
  - COM View interface 17-30
  - ConnectionPoint Service 19-52
  - CORBAComposite interface 18-51
  - CosNaming interface
    - mapped to ODL 19-55
  - DCORBATypeCode interface 19-23
  - DCORBAUnion interface 19-21
  - DCORBAUserException interface 19-32
  - DICORBAAny interface 17-27, 19-24
  - DICORBAFactory interface 17-25, 19-26, 19-27
  - DICORBAStruct interface 19-20
  - DICORBASystemException interface 19-34
  - DICORBAUnion interface 19-21, 19-22
  - DICORBAUserException interface 19-32
  - DIForeignComplexType interface 19-19
  - Dual interface 17-12, 19-4
  - HRESULT 18-11, 19-5, 19-10, 19-37
  - IConnectionPointContainer interface 19-52
  - ICORBAFactory interface 17-24, 17-37
  - ICORBAObject interface 17-27
  - ICustomer
    - Get\_Profile interface 18-26
  - IDispatch interface 17-4, 19-10
  - IEnumConnectionPoints interface 19-53
  - IEnumConnections interface 19-53
  - IForeignException interface 19-30
  - IForeignObject interface 17-26, 17-36, 19-16
  - IMonikerProvider interface 17-23, 17-36
  - inheritance, mapping for 18-50
  - IORBObject interface 17-28
  - IProvideClassInfo interface 18-33, 18-52
  - ISO Latin1 alphabetic ordering model 19-8
  - ISupportErrorInfo interface 18-15
  - ITypeFactory interface 19-29
  - ITypeInfo interface 18-33, 18-52
  - IUnknown interface 19-10
  - mapping between OMG IDL and OLE, overview 19-3
  - MIDL and ODL data types mapped to CORBA types 18-33
  - MIDL data types 18-2
  - MIDL pointers 18-44
  - multiple inheritance 19-6
  - OLE data types 19-9
  - OLE data types mapped to CORBA types 19-42
  - pseudo object mapping 18-29
  - QueryInterface 17-11, 19-7
  - sequence to collection mapping 19-49
  - SetErrorInfo interface 18-15
  - single inheritance 19-5
  - target 17-6
  - types of mappings 17-8
  - VARIANT 18-41, 19-5, 19-48
  - VARIANT data types 18-41
  - view 17-5
  - View interface program id 17-31
- Interworking Architecture
  - Purpose of 17-2
- Interworking Interfaces
  - ICORBAFactory Interface 17-24
  - ICORBAObject Interface 17-27
  - ICORBAObject2 17-28
  - IForeignObject Interface 17-26
  - IMonikerProvider Interface and Moniker Use 17-23
  - IORBObject Interface 17-28
  - Naming Conversions for View Components 17-30
  - SimpleFactory Interface 17-23
- Interworking Mapping Issues 17-8
- Interworking Object Model
  - Basic Description of the Interworking Model 17-4
  - Relationship to CORBA Object Model 17-3
  - Relationship to the OLE/COM Model 17-4
- interworking object model 17-3
- InvalidState 22-63
- INVOCATION\_POLICIES 22-72

# Index

---

- invocations
    - DII Deferred Synchronous 22-81
  - Invoking Client 22-53
  - IOP module
    - and DCE ESIOP 13-28
    - and GIOP 13-28
    - and IOP 13-28
  - IOR 13-15, 13-22, 16-5
    - converting to object reference 13-23
    - externalized 13-23
  - IORBObject interface 17-28
  - IProvideClassInfo interface 18-33, 18-52
  - IObject 10-13
  - IObject interface 10-11
    - OMG IDL for 10-13
  - is\_equivalent operation 4-17
  - is\_from\_poller 22-25
  - is\_ready 7-14
  - ISupportErrorInfo interface 18-15
  - ISynchronize and DISynchronize 20-11
  - ITypeFactory interface 19-29
  - ITypeInfo interface 18-33, 18-52
  - IUnknown interface 19-10
  - IValueObject 20-10
- L**
- language mapping
    - overview 2-8
  - Lexical Conventions 3-3
    - Comments 3-6
    - Escaped Identifiers 3-7
    - Identifiers 3-6
    - Keywords 3-8
    - Tokens 3-6
  - LifespanPolicy 11-31
  - LimitedPing 22-63
  - Liskov substitution principle 1-6
  - List Operations 7-16
    - add\_item 7-17
    - create\_list 7-17
    - create\_operation\_list 7-18
    - free 7-18
    - free\_memory 7-18
    - get\_count 7-18
  - Literals
    - Character Literals 3-9
    - Fixed-Point Literals 3-11
    - Floating-point Literals 3-10
    - Integer Literals 3-9
    - String Literals 3-10
  - little endian 15-7
  - Local Interface 3-26
  - LocalInterfaceDef 10-41, 10-43
  - Locality of the Bridge 20-4
  - LocalObject 4-22
  - LOCATION\_FORWARD Replies 22-58
  - logical\_type\_id string 4-16
- M**
- magic 15-32, 15-61
  - Mapping
    - Array Types 18-9, 18-40
    - Attributes 18-24
    - Basic Data Types 18-2, 18-33
    - Bounded Sequence Types 18-8
    - Bounded String Types 18-5
    - bounded string types 18-36
    - COM Errors 18-44
    - COM to CORBA data type 18-33
    - Constants 18-2, 18-34
    - context pseudo-object 18-31
    - Encapsulated Unions 18-38
    - Enumerators 18-3, 18-34
    - exception types 18-11
    - Interface Identifiers 18-44
    - interface identifiers 18-11
    - Interface Repository 18-32
    - Names 18-47
    - Nested Data Types 18-47
    - nonencapsulated unions 18-39
    - Oneway Operations 18-24
    - Operations 18-22, 18-47
    - Pointers 18-43
    - principal pseudo-object 18-32
    - Properties 18-48
    - Pseudo-Objects 18-29
    - Read-Only Attributes 18-49
    - Read-Write Attributes 18-49
    - SAFEARRAY 18-40
    - String Types 18-4, 18-35
    - Struct Types 18-5
    - Structure Types 18-37
    - the any Type 18-9
    - TypeCode pseudo-object 18-29
    - Unbounded Sequence Types 18-8
    - Unbounded String Types 18-4
    - unbounded string types 18-35
    - unicode bound string types 18-37
    - Unicode Unbounded String Types 18-36
    - Union Types 18-6, 18-38
    - VARIANT 18-41
  - Mapping a COM Service to OMG IDL 19-51
  - Mapping an OMG Object Service to Automation 19-55
  - Mapping Automation Exceptions to CORBA 19-49
  - Mapping Automation Objects as CORBA Objects 19-38
  - Mapping CORBA Exceptions to Automation Exceptions 19-30
  - Mapping CORBA Objects to Automation 19-2
  - Mapping for Array Types 18-9
  - Mapping for Arrays and Sequences 19-18
  - Mapping for Attributes 18-24
  - Mapping for Attributes and Operations 19-4
  - Mapping for Automation Basic Data Types
    - Basic automation types 19-42
  - Mapping for Basic Data Types 18-2, 19-9
    - Basic Automation Types 19-9
    - Converting Automation boolean to CORBA boolean and CORBA boolean to Automation boolean 19-11
    - Converting Automation long to CORBA unsigned long 19-10
    - Demoting Automation long to CORBA unsigned short 19-11
    - Demoting CORBAUnsigned long to Automation long 19-11
    - Mapping for Strings 19-11
  - Mapping for Bounded Sequence Types 18-8



- Mapping for Bounded String Types 18-5
  - Mapping for Constants 18-2, 19-25
  - Mapping for context pseudo-object 18-31
  - Mapping for CORBA Complex Types 19-19
    - Creating Initial in Parameters for Complex Types 19-27
    - DObjectInfo Interface 19-29
    - Getting Initial CORBA Object References 19-26
    - ITypeFactory Interface 19-29
    - Mapping for anys 19-24
    - Mapping for Constants 19-25
    - Mapping for Structure Types 19-20
    - Mapping for TypeCodes 19-22
    - Mapping for Typedefs 19-25
    - Mapping for Union Types 19-21
  - Mapping for Enumerated Types 19-17, 19-47
  - Mapping for Enumerators 18-3
  - Mapping for exception types 18-11
  - Mapping for Inheritance 19-40
  - Mapping for Interface identifiers 18-11
  - Mapping for Interfaces 19-3, 19-40
  - Mapping for Nested Types 18-21
  - Mapping for Object References 19-46
    - Object Reference Parameters and IForeignObject 19-16
    - Type Mapping 19-15
  - Mapping for ODL Properties and Methods 19-41
  - Mapping for OMG IDL Arrays and Sequences
    - to Collections 19-49
  - Mapping for OMG IDL Single Inheritance 19-5
  - Mapping for Oneway Operations 18-24
  - Mapping for Operations 18-22
  - Mapping for principal pseudo-object 18-32
  - Mapping for Pseudo-Objects 18-29
  - Mapping for SafeArrays 19-48
  - Mapping for Sequence Types 18-8
  - Mapping for String Types 18-4
  - Mapping for Strings 19-11
  - Mapping for Struct Types 18-5
  - Mapping for the any Type 18-9
  - Mapping for TypeCode pseudo-object 18-29
  - Mapping for Typedefs 19-25, 19-48
  - Mapping for Unbounded Sequence Types 18-8
  - Mapping for Unbounded String Types 18-4
  - Mapping for Union Types 18-6
  - Mapping for VARIANTS 19-48
  - Mapping of OMG IDL Multiple Inheritance 19-6
  - Mapping of OMG IDL to Programming Languages 2-8
  - Mapping the OMG Naming Service to Automation 19-51
  - max\_backoffs 22-63
  - MaxHopsPolicy interfaces 22-11
  - mediated bridging 13-8
  - Memory Usage 7-4
  - message 22-50, 22-52
  - message payload 22-82
  - Message Routing 22-46
  - message routing 22-46
  - Message Routing Abstract Model Design 22-81
  - Message Routing Interoperability 22-45
  - MessageBody 22-48
  - Messaging
    - module 22-65
  - Messaging module 22-2, 22-12
  - Messaging Programming Model 22-13
  - Messaging QoS 22-12
    - propagation of 22-12
  - Messaging QoS Profile Component 22-13
  - Messaging QoS Service Context 22-13
  - Messaging Quality of Service 22-2
    - method 1-9
  - Microsoft Interface Definition Language
    - see MIDL 17-4
  - MIDL 17-4
    - transformation rules 17-13
  - mode 1-8
  - Mode Property 20-11
  - Model Components 22-72
  - module
    - Messaging 22-12
  - Module Declaration 3-20
  - ModuleDef 10-24
  - ModuleDef interface
    - OMG IDL for 10-24
  - modules
    - Messaging 22-2, 22-65
  - Multidimensional SafeArrays 19-48
  - multiple inheritance 3-23, 17-11, 19-6
- N**
- NamedValue type 7-2
  - Names and Scoping
    - Qualified Names 3-67
    - Scoping Rules and Name Resolution 3-69
    - Special Scoping Rules for Type Names 3-72
  - Naming Conventions 19-36
  - Naming Conventions for Pseudo-Structs, Pseudo-Unions, and Pseudo-Exceptions 19-36
  - NamingContext 14-7
  - NativeDef 10-50
  - NO\_EXCEPTION 22-57
  - NO\_REBIND 22-5
  - NO\_RECONNECT 22-5
  - Non-Goals 12-10
  - NOT\_REGISTERED 22-62
  - number\_left 7-16
  - NVList 18-29
  - NVList interface
    - add\_item operation 7-17
    - create\_list operation 7-17
    - create\_operation\_list 7-18
    - get\_count operation 7-18
  - NVList operation
    - free\_memory operation 7-18
- O**
- object 1-2
    - CORBA and COM compared 17-9
    - implementation 1-10, 2-7
    - invocation 2-9, 2-10
    - reference 2-8
    - reference canonicalization 13-13
    - reference embedding 13-12
    - reference encapsulation 13-13
    - references, stringified 13-22

# Index

---

- request 13-3
- Object Adapter
  - Structure 2-15
- object adapter 2-6, 2-9, 2-14
  - and request level bridging 14-6
  - functions of 2-15
  - overview of 2-5, 2-10
- Object Adapters 2-10
- Object Creation and Destruction
  - Abstract Interfaces 1-7
  - Attributes 1-9
  - Basic types 1-4
  - Constructed types 1-5
  - Interfaces 1-6
  - Operations 1-7
  - Types 1-4
  - Value Types 1-6
- Object Definition Language 17-4
- object duplicate operation
  - OMG PIDL for 4-15
- object identifiers
  - and hash operation 4-17
- Object Identity Issues 17-19
- Object Identity, Binding, and Life Cycle 17-18
- Object Implementation
  - Structure 2-13
  - The Construction Model 1-10
  - The Execution Model 1-9
- Object Implementations 2-7
- Object interface
  - create\_request operation 4-14
  - OMG PIDL for 4-12
- object key 15-30
- Object Location 15-50
- Object model 1-2
- object reference 1-3
  - and COM interface pointers 17-4
  - obtaining for View interface 19-40
  - testing for equivalence 4-17
- Object References 2-8
- object references
  - obtaining for automation controller environments 19-26
- Object Request Broker 2-6
  - explained 2-1
  - how implemented 2-6
  - interfaces to 2-2
  - sample implementations 2-11, 2-13
  - Structure 2-1
- Object Semantics
- Objects 1-2
- Requests 1-3
- Object Services
  - and GIOP module 15-37
  - and interoperability 14-7
  - and IOP module 13-28
  - Life Cycle 17-21, 17-23, 18-51, 19-26
  - Naming 14-7, 17-25, 19-26, 19-40
  - Naming, sample mapping to OLE 19-51, 19-55
  - Relationship 12-5
  - tags for A-1
  - Transaction 13-10
- object system 1-2
- object\_key 22-49
- object\_to\_string operation 4-8
  - OMG PIDL for 4-9
- object-level policies 4-43
- Objects 1-2
- octet type 3-39, 15-4, 15-10
- ODL 18-4, 19-1
- Older Automation Controllers 19-49
- OLE Automation 17-4
  - basic data types 19-9
  - basic data types mapped to CORBA types 19-42
  - relationship to OMG IDL 19-3
  - transformation rules 17-13
- OLE automation controller 19-2
- OMG IDL
  - BiDirPolicy Module 15-65
  - GIOP Module 15-60
  - IOP Module 15-64
  - overview of 2-8
  - relationship to OLE 19-3
  - syntax of 3-18
- OMG IDL for Interface Repository 10-75
- OMG IDL for the DCE CIOP Module 16-25
- OMG IDL global name 3-68
- OMG IDL Grammar 3-12
- OMG IDL Specification 3-18
- OMG IDL tags
  - requests to allocate 13-22, A-1
- OMG IDL to ODL Mapping for the Basic Data Types 19-44
- OMG IDL, explained 2-3, 2-8
- OMG IDL-to-programming language mapping
  - overview 2-8
- OMG Interface Definition Language 2-8
- oneway 18-24, 7
- opaque data type 15-5
- operation 1-7, 22-49
  - attribute,syntax of 3-51
  - declaration,syntax of 3-50
  - defined 1-7
  - signature of 1-7
- Operation Declaration
  - Context Expressions 3-53
  - Operation Attribute 3-51
  - Parameter Declarations 3-51
  - Raises Expressions 3-52
- operation\_name 22-25, 22-51
- operation\_target 22-25
- OperationDef 10-34
  - OMG IDL for 10-34
- Operations 19-34
- operations
  - oneway 22-81
- Operations that raise system exceptions 19-34
- Operations that Raise User Exceptions 19-32
- ORB
  - backbone 13-11
  - connecting 10-4
  - core 13-3
  - kernel 13-3
- ORB Boundaries 12-8

- ORB Implementation Diversity 12-8
  - ORB Interface 2-10
    - overview of 2-10
  - ORB interface
    - and create\_list operation 7-17
    - and create\_operation\_list operation 7-18
  - ORB interoperability 12-1
  - ORB Interoperability Architecture 12-2
  - ORB Operations
    - get\_next\_response and poll\_next\_response 7-11
    - send\_multiple\_requests 7-11
  - ORB Services 13-3, 13-7
    - how selected 13-4
    - vs. Object Services 13-3
  - ORB-level policies 4-43
  - ORBs
    - Client- and Implementation-resident ORB 2-11
    - Library-based ORB 2-12
    - Server-based ORB 2-12
    - System-based ORB 2-12
  - ORBs Vary in Scope, Distance, and Lifetime 12-9
  - ORDER\_ANY 22-11
  - ORDER\_DEADLINE 22-12
  - ORDER\_PRIORITY 22-12
  - ORDER\_TEMPORAL 22-11
  - Ordering 22-11
  - OTS Behavior 22-85
- P**
- parameter
    - defined 1-8
  - parameter declaration
    - syntax of 3-51
  - Persistent ReplyHandler 22-76
  - PersistentPoller 22-76
  - PersistentRequest 22-75
  - PersistentRequest interface 22-51
  - PersistentRequestRouter interface 22-52
  - POA
    - location transparency 11-14
  - POA Interface 11-34
  - POA Threading Models 11-11
  - POAManager Interface 11-15
  - POA-related interfaces 11-14
  - policies
    - object-level 4-43
    - thread-level 4-43
  - Policy 22-72
  - PolicyCurrent interface 4-46
  - PolicyList 22-72
  - PolicyManager 22-72
  - PolicyManager interface 4-45
  - PolicyValue 22-12
  - Pollable interface 7-14
  - PollableSet interface 7-14
  - Poller 22-26, 22-75
  - Poller operations
    - for Interface attributes 22-27
    - for Interface operations 22-26
  - Poller Value
    - generic 22-24
  - Poller/PersistentRequest Detailed Design 22-79
  - Poller/PersistentRequest detailed design 22-79
  - Polling 7-12
    - Abstract Valuetype DIIPollable 7-14
    - Abstract Valuetype Pollable 7-14
    - interface PollableSet 7-14
  - Polling Model
    - signatures 22-18
  - Portable Object Adapter 11-1
  - Portable Object Adaptor
    - abstract model description 11-2
    - AdaptorActivator interface 11-22
    - creating 11-35, 11-55
    - creating object references 11-7
    - creation 11-6
    - destroying 11-36
    - dynamic skeleton interface 11-13
    - finding 11-35
    - implicit activation 11-10
    - Implicit Activation policy 11-34
    - interface 11-34
    - model architecture 11-4
    - model components 11-2
    - multi-threading 11-11
    - overview 11-1
    - request processing 11-9
    - root POA 11-54
    - ServantActivator interface 11-25
    - ServantLocator Interface 11-27
    - ServantManager interface 11-24
    - SYSTEM\_ID policy 11-55
    - usage scenarios 11-54
  - Portable Object Adaptor
    - policy objects 11-30
  - PortableServer
    - UML description of 11-52
  - Pragma 10-71
  - pragma directive
    - and Interface Repository 10-67
    - id 10-68
  - Prefix Pragma 10-68
  - preinvoke operation 11-24
  - prepare 7-10
  - Preprocessing 3-11
  - PrimitiveDef 10-29
    - OMG IDL for 10-29
  - principal 15-14
  - principal pseudo object 18-29, 18-32
  - PriorityRange 22-7
  - profile
    - tags for A-1
  - profile\_index 22-50, 22-52
  - proxy 14-5
  - Proxy Creation and Management 14-5
- Q**
- QoS Abstract Model Design 22-72
  - qualified name 3-67
  - Quality of Service
    - framework 22-2
  - Quality of Service (QoS) 22-2

# Index

---

- QueryInterface 17-11, 19-7
- QueueOrderPolicy 22-12
- QueueOrderPolicy interface 22-12
- R**
- REBIND 4-71
- Rebind Support 22-5
  - Interface RebindPolicy 22-5
  - Request and Reply Priority 22-7
  - Request and Reply Timeout 22-8
  - Routing 22-10
  - Synchronization Scope 22-6
  - typedefshortRebindMode 22-5
- RebindMode 22-5
- RebindPolicy interface 22-5
- ReCopy Method 20-11
- reference encapsulation 14-5
- reference model ii
- reference translation 14-5
- register\_destination 22-64
- Registering Dynamic Implementation Routines 8-5
- RegistrationState 22-62
- Relationship Service 12-5
- RelativeRequestTimeoutPolicy 22-9
- RelativeRequestTimeoutPolicy interface 22-9
- RelativeRoundtripTimeoutPolicy interface 22-10
- release operation 4-15
- remove 7-16
- reply 22-51
- reply\_body 22-51, 22-52
- reply\_destination 22-50
- reply\_type 22-51
- ReplyDestination 22-49
- ReplyEndTimePolicy 22-9
- ReplyEndTimePolicy interfaces 22-9
- ReplyHandler 22-21, 22-75, 22-78
- ReplyHandler interface 22-50
- ReplyHandler Operations
  - for NO\_EXCEPTION Replies 22-22
- ReplyHandler operations
  - for exceptional replies 22-23
  - for NO\_EXCEPTION replies 22-22
- ReplyHandler Operations for Exceptional Replies 22-23
- ReplyHandler Operations for NO\_EXCEPTION Replies 22-22
- ReplyPriorityPolicy 22-8
- ReplyPriorityPolicy interfaces 22-8
- ReplyStartTimePolicy 22-9
- ReplyStartTimePolicy interfaces 22-9
- Repository interface
  - OMG IDL for 10-22, 10-52
- RepositoryId
  - and COM interface identifiers 18-44
  - and COM mapping 18-11
  - and pragma directive 10-67
  - format of 10-64
- RepositoryIds 10-64
  - DCE UUID Format 10-67
  - For More Information 10-73
  - LOCAL Format 10-67
  - OMG IDL Format 10-65
  - Pragma Directives for RepositoryId 10-67
  - RepositoryIDs for OMG-Specified Types 10-73
  - RMI Hashed Format 10-65
- request 1-3
- request context 1-8
- request form 1-3
- Request interface
  - get\_response operation 7-9
  - send operation 7-8
- request level bridging 14-2
  - types of 14-6
- Request Operations
  - add\_arg 7-7
  - create\_request 7-5
  - delete 7-8
  - get\_response 7-9
  - invoke 7-8
  - poll\_response 7-9
  - prepare 7-10
  - send 7-8
  - sendc 7-10
  - sendp 7-10
- Request Routing Algorithm 22-54
- Request/Reply Extent Semantics 20-8
- Request/Reply Routers 22-82
- RequestEndTimePolicy 22-9
- RequestEndTimePolicy interface 22-9
- RequestInfo 22-49
- Request-level Bridging 14-3
- RequestMessage 22-48
- RequestPriorityPolicy 22-7
- RequestPriorityPolicy interface 22-7
- RequestProcessingPolicy 11-32
- Requests 1-3
- reserved 22-49
- response\_flags 15-35, 22-49
- result
  - defined 1-8
- resume\_destination 22-64
- ResumePolicy 22-64
- RetryPolicy 22-63
- Return Status and Exceptions 7-4
- ROUTE\_FORWARD 22-10
- ROUTE\_NONE 22-10
- ROUTE\_STORE\_AND\_FORWARD 22-10
- Router 22-76
- Router Administration 22-59
  - Constants 22-62
  - Exceptions 22-63
  - Interfaces 22-64
  - Values 22-63
- Router interface 22-50
- RouterAdmin 22-59
- RouterAdmin interface 22-64
- Routing Object References 22-46
- routing object references 22-46
- RoutingPolicy interface 22-11
- RoutingType 22-10
- RoutingTypeRange 22-10
- RPC 16-20, 16-24

**S**

- SAFEARRAY 17-10, 18-40
- scoped name identifier 3-67
- scoped\_name 3-24
- Security Considerations 6-4
- Security Service 22-86
- see ODL 17-4
- selected\_qos 22-50, 22-52
- send\_multiple\_requests 22-50
- send\_request 22-50
- sendc 7-10, 22-16
- sendp 7-10, 22-18
- sequence octet 15-14, 15-29
- sequence type 3-42, 3-44, 15-12
- SequenceDef 10-30
  - OMG IDL for 10-30
- ServantRetentionPolicy 11-32
- ServerRequest pseudo-object 8-3
- ServerRequest's Handling of Operation Parameters 8-4
- ServerRequestPseudo-Object 8-3
- server-side
  - policy management 4-44
- server-side policies 22-73
- Service Contexts 22-58
- service\_contexts 22-49
- ServiceContext 13-29
- ServiceID 13-30
- set\_policy\_overrides 4-45
- SetErrorInfo interface 18-15
- signature 1-7
- Special Cases of Data Type Conversion 19-43
- static routing 22-83
- string type 3-45
- string\_to\_object operation 4-8
  - OMG PIDL for 4-9
- StringDef 10-29
  - OMG IDL for 10-29
- struct type 15-12
- StructDef 10-26
  - OMG IDL for 10-26
- Structures
  - MessageBody 22-48
  - ReplyDestination 22-49
  - RequestInfo 22-49
  - RequestMessage 22-48
- stub interface 2-8
- subject 3-54
- suspend\_destination 22-64
- SUSPENDED 22-62
- SYNC\_NONE 22-6
- SYNC\_WITH\_SERVER 22-6
- SYNC\_WITH\_TARGET 22-7
- SYNC\_WITH\_TRANSPORT 22-6
- SyncNow Method 20-11
- SyncScope 22-6
- SyncScopePolicy 22-7
- SyncScopePolicy interface 22-7
- SYSTEM\_EXCEPTION 22-57
- component 13-22
  - protocol 13-22
  - requests to allocate A-1
- TAG\_MULTIPLE\_COMPONENTS tag 13-22
- TAG\_POLICIES 22-72
- target 17-6, 17-34, 22-50, 22-52
- Target Router 22-55
- TCKind 15-23
- TCP/IP 15-47, 15-51
- thread-level policies 4-43
- ThreadPolicy 11-30
- TII 22-82
- Time-Independent Invocation 22-76
- Time-Independent Invocation Components 22-75
- TIMEOUT 4-71
- timeout 22-52
- to\_visit 22-50, 22-52
- Transaction Service 13-10
- Transaction service compatibility 22-84
- TRANSACTION\_MODE exception 4-71
- TRANSACTION\_UNAVAILABLE Exception 4-71
- transfer syntax
  - between ORBs and inter-ORB bridges 15-3
- Translating COM
  - Currency to Automation CURRENCY 19-43
- Translating CORBA boolean to Automation boolean
  - and Automation boolean to CORBA boolean 19-43
- Translating CORBA double to Automation DATE 19-43
- transparency 13-4
- transparency of location 13-2
- TRANSPARENT 22-5
- type 1-4
- Type Declaration
  - Any Type 3-39
  - Basic Types 3-37
  - Boolean Type 3-39
  - Char Type 3-38
  - Constructed Types 3-39
  - Floating-Point Types 3-38
  - Integer Types 3-38
  - Native Types 3-46
  - Octet Type 3-39
  - Template Types 3-44
  - Wide Char Type 3-39
- Type Library Mapping 18-52
- type specifier
  - syntax of 3-36
- TypeCode 7-2, 18-29
  - OMG IDL for 4-58
- TypeCode constants 4-57
- TypeCode interface
  - OMG IDL for 4-52
- TypeCodes
  - Creating TypeCodes 4-58
  - The TypeCode Interface 4-52
  - TypeCode Constants 4-57
- TypedefDef 10-26
- types
  - any 1-5
  - basic 1-4
  - constructed 1-5

**T**  
tag

# Index

---

- defined 1-4
- Type-Specific Poller Mapping 22-26
  - Basic Type-Specific Poller 22-26
  - Persistent Type-Specific Poller 22-28
  - Poller operations for Interface attributes 22-27
  - Poller operations for Interface operations 22-26
- Type-specific ReplyHandler
  - Replying to a 22-57
- Type-Specific ReplyHandler Mapping 22-21

**U**

- UML Description of PortableServer 11-52
- Unicode 17-10, 18-37, 19-11
- union type 3-40, 15-12
- UnionDef 10-27
- UnlimitedPing 22-63
- unregister\_destination 22-65
- UntypedReplyHandler 22-58
  - Replying to an 22-57
- UntypedReplyHandler interface 22-51
- Usage Guidelines 6-3
- Usage Scenarios
  - Creating a POA 11-55
  - Creating References before Activation 11-57
  - Explicit Activation with POA-assigned Object Ids 11-55
  - Explicit Activation with User-assigned Object Ids 11-56
  - Getting the Root POA 11-54
  - Multiple Object Ids Mapping to a Single Servant 11-61
  - Object Activation on Demand 11-59
  - One Servant for All Objects 11-61
  - Persistent Objects with POA-assigned Ids 11-60
  - Servant Manager Definition and Creation 11-57
  - Single Servant, Many Objects and Types, Using DSI 11-64

- USER\_EXCEPTION 22-57

**V**

- validate\_connection 4-21
- value 1-3
- Value Declaration
  - Abstract Value Type 3-30
  - Boxed Value Type 3-29
  - Regular Value Type 3-27
  - Value Forward Declaration 3-30
  - Valuetype Inheritance 3-31
- value type 1-6
- Value types 5-2
- ValueBoxDef 10-49
- ValueDef 10-44, 10-48
- ValueMemberDef 10-43
- Values
  - DecayPolicy 22-64
  - ImmediatePing 22-63
  - ImmediateSuspend 22-63
  - LimitedPing 22-63
  - ResumePolicy 22-64
- VARIANT 18-41, 19-5, 19-30, 19-48
  - OLE data types 18-41
- Version Pragma 10-71
- view 17-5, 17-22
- View interface 17-31
- visited 22-49
- Visual Basic 17-9

**W**

- Windows System Registry 17-25, 19-2, 19-25
- WstringDef 10-30