



Business Process Model and Notation (BPMN)

Version 2.0.1 with change bars

OMG Document Number: formal/2013-09-03
Standard document URL: <http://www.omg.org/spec/BPMN>
Machine consumable files:
<http://www.omg.org/spec/BPMN/20100501/BPMN20.cmf>
<http://www.omg.org/spec/BPMN/20100501/BPMNDI.cmf>
<http://www.omg.org/spec/BPMN/20100501/DC.cmf>
<http://www.omg.org/spec/BPMN/20100501/DI.cmf>
<http://www.omg.org/spec/BPMN/20100501/BPMN20.xsd>
<http://www.omg.org/spec/BPMN/20100501/BPMNDI.xsd>
<http://www.omg.org/spec/BPMN/20100501/DC.xsd>
<http://www.omg.org/spec/BPMN/20100501/DI.xsd>
<http://www.omg.org/spec/BPMN/20100501/Semantic.xsd>
<http://www.omg.org/spec/BPMN/20100502/Infrastructure.cmf>
<http://www.omg.org/spec/BPMN/20100502/Semantic.cmf>

Copyright © 2010, Axway
Copyright © 2010, BizAgi
Copyright © 2010, Bruce Silver Associates
Copyright © 2010, IDS Scheer
Copyright © 2010, IBM Corp.
Copyright © 2010, MEGA International
Copyright © 2010, Model Driven Solutions
Copyright © 2013, Object Management Group
Copyright © 2010, Oracle
Copyright © 2010, SAP AG
Copyright © 2010, Software AG
Copyright © 2010, TIBCO Software
Copyright © 2010, Unisys

USE OF SPECIFICATION - TERMS, CONDITIONS & NOTICES

The material in this document details an Object Management Group specification in accordance with the terms, conditions and notices set forth below. This document does not represent a commitment to implement any portion of this specification in any company's products. The information contained in this document is subject to change without notice.

LICENSES

The companies listed above have granted to the Object Management Group, Inc. (OMG) a nonexclusive, royalty-free, paid up, worldwide license to copy and distribute this document and to modify this document and distribute copies of the modified version. Each of the copyright holders listed above has agreed that no person shall be deemed to have infringed the copyright in the included material of any such copyright holder by reason of having used the specification set forth herein or having conformed any computer software to the specification.

Subject to all of the terms and conditions below, the owners of the copyright in this specification hereby grant you a fully-paid up, non-exclusive, nontransferable, perpetual, worldwide license (without the right to sublicense), to use this specification to create and distribute software and special purpose specifications that are based upon this specification, and to use, copy, and distribute this specification as provided under the Copyright Act; provided that: (1) both the copyright notice identified above and this permission notice appear on any copies of this specification; (2) the use of the specifications is for informational purposes and will not be copied or posted on any network computer or broadcast in any media and will not be otherwise resold or transferred for commercial purposes; and (3) no modifications are made to this specification. This limited permission automatically terminates without notice if you breach any of these terms or conditions. Upon termination, you will destroy immediately any copies of the specifications in your possession or control.

PATENTS

The attention of adopters is directed to the possibility that compliance with or adoption of OMG specifications may require use of an invention covered by patent rights. OMG shall not be responsible for identifying patents for which a license may be required by any OMG specification, or for conducting legal inquiries into the legal validity or scope of those patents that are brought to its attention. OMG specifications are prospective and advisory only. Prospective users are responsible for protecting themselves against liability for infringement of patents.

GENERAL USE RESTRICTIONS

Any unauthorized use of this specification may violate copyright laws, trademark laws, and communications regulations and statutes. This document contains information which is protected by copyright. All Rights Reserved. No part of this work covered by copyright herein may be reproduced or used in any form or by any means--graphic, electronic, or

mechanical, including photocopying, recording, taping, or information storage and retrieval systems--without permission of the copyright owner.

DISCLAIMER OF WARRANTY

WHILE THIS PUBLICATION IS BELIEVED TO BE ACCURATE, IT IS PROVIDED "AS IS" AND MAY CONTAIN ERRORS OR MISPRINTS. THE OBJECT MANAGEMENT GROUP AND THE COMPANIES LISTED ABOVE MAKE NO WARRANTY OF ANY KIND, EXPRESS OR IMPLIED, WITH REGARD TO THIS PUBLICATION, INCLUDING BUT NOT LIMITED TO ANY WARRANTY OF TITLE OR OWNERSHIP, IMPLIED WARRANTY OF MERCHANTABILITY OR WARRANTY OF FITNESS FOR A PARTICULAR PURPOSE OR USE. IN NO EVENT SHALL THE OBJECT MANAGEMENT GROUP OR ANY OF THE COMPANIES LISTED ABOVE BE LIABLE FOR ERRORS CONTAINED HEREIN OR FOR DIRECT, INDIRECT, INCIDENTAL, SPECIAL, CONSEQUENTIAL, RELIANCE OR COVER DAMAGES, INCLUDING LOSS OF PROFITS, REVENUE, DATA OR USE, INCURRED BY ANY USER OR ANY THIRD PARTY IN CONNECTION WITH THE FURNISHING, PERFORMANCE, OR USE OF THIS MATERIAL, EVEN IF ADVISED OF THE POSSIBILITY OF SUCH DAMAGES.

The entire risk as to the quality and performance of software developed using this specification is borne by you. This disclaimer of warranty constitutes an essential part of the license granted to you to use this specification.

RESTRICTED RIGHTS LEGEND

Use, duplication or disclosure by the U.S. Government is subject to the restrictions set forth in subparagraph (c) (1) (ii) of The Rights in Technical Data and Computer Software Clause at DFARS 252.227-7013 or in subparagraph (c)(1) and (2) of the Commercial Computer Software - Restricted Rights clauses at 48 C.F.R. 52.227-19 or as specified in 48 C.F.R. 227-7202-2 of the DoD F.A.R. Supplement and its successors, or as specified in 48 C.F.R. 12.212 of the Federal Acquisition Regulations and its successors, as applicable. The specification copyright owners are as indicated above and may be contacted through the Object Management Group, 109 Highland Avenue, Needham, MA 02494, U.S.A.

TRADEMARKS

IMM®, MDA®, Model Driven Architecture®, UML®, UML Cube logo®, OMG Logo®, CORBA® and XMI® are registered trademarks of the Object Management Group, Inc., and Object Management Group™, OMG™, Unified Modeling Language™, Model Driven Architecture Logo™, Model Driven Architecture Diagram™, CORBA logos™, XMI Logo™, CWM™, CWM Logo™, IOP™, MOF™, OMG Interface Definition Language (IDL)™, and OMG SysML™ are trademarks of the Object Management Group. All other products or company names mentioned are used for identification purposes only, and may be trademarks of their respective owners.

COMPLIANCE

The copyright holders listed above acknowledge that the Object Management Group (acting itself or through its designees) is and shall at all times be the sole entity that may authorize developers, suppliers and sellers of computer software to use certification marks, trademarks or other special designations to indicate compliance with these materials. Software developed under the terms of this license may claim compliance or conformance with this specification if and only if the software compliance is of a nature fully matching the applicable compliance points as stated in the specification. Software developed only partially matching the applicable compliance points may claim only that the software was based on this specification, but may not claim compliance or conformance with this specification. In the event that testing suites are implemented or approved by Object Management Group, Inc., software developed using this specification may claim compliance or conformance with the specification only if the software satisfactorily completes the testing suites.

OMG's Issue Reporting Procedure

All OMG specifications are subject to continuous review and improvement. As part of this process we encourage readers to report any ambiguities, inconsistencies, or inaccuracies they may find by completing the Issue Reporting Form listed on the main web page <http://www.omg.org>, under Documents, Report a Bug/Issue (http://www.omg.org/report_issue.htm).

Table of Contents

Preface	xxvii
1 Scope	1
1.1 General	1
2 Conformance	1
2.1 General	1
2.2 Process Modeling Conformance	2
2.2.1 BPMN Process Types	2
2.2.2 BPMN Process Elements	3
2.2.3 Visual Appearance	8
2.2.4 Structural Conformance	8
2.2.5 Process Semantics	9
2.2.6 Attributes and Model Associations	9
2.2.7 Extended and Optional Elements	9
2.2.8 Visual Interchange	10
2.3 Process Execution Conformance	10
2.3.1 Execution Semantics	10
2.3.2 Import of Process Diagrams	10
2.4 BPEL Process Execution Conformance	10
2.5 Choreography Modeling Conformance	10
2.5.1 BPMN Choreography Types	10
2.5.2 BPMN Choreography Elements	11
2.5.3 Visual Appearance	11
2.5.4 Choreography Semantics	11
2.5.5 Visual Interchange	11
2.6 Summary of BPMN Conformance Types	12
3 Normative References	12
3.1 General	12
3.2 Normative	13
3.3 Non-Normative	13
4 Terms and Definitions	16
5 Symbols	16
6 Additional Information	16
6.1 Conventions	16
6.1.1 Typographical and Linguistic Conventions and Style	16
6.1.2 Abbreviations	17
6.2 Structure of this Document	17
6.3 Acknowledgments	17

7 Overview	19
7.1 General	19
7.2 BPMN Scope	20
7.2.1 Uses of BPMN	21
7.3 BPMN Elements	25
7.3.1 Basic BPMN Modeling Elements	26
7.3.2 Extended BPMN Modeling Elements	29
7.4 BPMN Diagram Types	39
7.5 Use of Text, Color, Size, and Lines in a Diagram	39
7.6 Flow Object Connection Rules	40
7.6.1 Sequence Flow Connections Rules	40
7.6.2 Message Flow Connection Rules	41
7.7 BPMN Extensibility	42
7.8 BPMN Example	43
8 BPMN Core Structure	47
8.1 General	47
8.2 Infrastructure	49
8.2.1 Definitions	49
8.2.2 Import	51
8.2.3 Infrastructure Package XML Schemas.....	52
8.3 Foundation	53
8.3.1 Base Element	54
8.3.2 Documentation	54
8.3.3 Extensibility	55
8.3.4 External Relationships	59
8.3.5 Root Element	62
8.3.6 Foundation Package XML Schemas	62
8.4 Common Elements	64
8.4.1 Artifacts	64
8.4.2 Correlation	72
8.4.3 Error	79
8.4.4 Escalation	80
8.4.5 Events	81
8.4.6 Expressions	82
8.4.7 Flow Element	84
8.4.8 Flow Elements Container	86
8.4.9 Gateways	88
8.4.10 Item Definition	89
8.4.11 Message	91
8.4.12 Resources	93
8.4.13 Sequence Flow	95
8.4.14 Common Package XML Schemas	98
8.5 Services	101
8.5.1 Interface	102
8.5.2 EndPoint	103
8.5.3 Operation	103
8.5.4 Service Package XML Schemas	104

9 Collaboration	107
9.1 General	107
9.2 Basic Collaboration Concepts	110
9.2.1 Use of BPMN Common Elements	110
9.3 Pool and Participant	111
9.3.1 Participants	113
9.3.2 Lanes	119
9.4 Message Flow	119
9.4.1 Interaction Node	122
9.4.2 Message Flow Associations	122
9.5 Conversations	123
9.5.1 Conversation Node	127
9.5.2 Conversation	129
9.5.3 Sub-Conversation	129
9.5.4 Call Conversation	130
9.5.5 Global Conversation	131
9.5.6 Conversation Link	131
9.5.7 Conversation Association	134
9.5.8 Correlations	135
9.6 Process within Collaboration	136
9.7 Choreography within Collaboration	136
9.8 Collaboration Package XML Schemas	138
10 Process	143
10.1 General	143
10.2 Basic Process Concepts	147
10.2.1 Types of BPMN Processes	147
10.2.2 Use of BPMN Common Elements	148
10.3 Activities	149
10.3.1 Resource Assignment	152
10.3.2 Performer	154
10.3.3 Tasks	154
10.3.4 Human Interactions	163
10.3.5 Sub-Processes	171
10.3.6 Call Activity	182
10.3.7 Global Task	186
10.3.8 Loop Characteristics	188
10.3.9 XML Schema for Activities	194
10.4 Items and Data	202
10.4.1 Data Modeling	202
10.4.2 Execution Semantics for Data	224
10.4.3 Usage of Data in XPath Expressions	225
10.4.4 XML Schema for Data	228
10.5 Events	232
10.5.1 Concepts	233
10.5.2 Start Event	237
10.5.3 End Event	245
10.5.4 Intermediate Event	248

10.5.5 Event Definitions	259
10.5.6 Handling Events	274
10.5.7 Scopes	280
10.5.8 Events Package XML Schemas	281
10.6 Gateways	286
10.6.1 Sequence Flow Considerations	288
10.6.2 Exclusive Gateway	289
10.6.3 Inclusive Gateway	291
10.6.4 Parallel Gateway	292
10.6.5 Complex Gateway	294
10.6.6 Event-Based Gateway	296
10.6.7 Gateway Package XML Schemas	300
10.7 Compensation	301
10.7.1 Compensation Handler	302
10.7.2 Compensation Triggering	303
10.7.3 Relationship between Error Handling and Compensation	304
10.8 Lanes	304
10.9 Process Instances, Unmodeled Activities, and Public Processes	308
10.10 Auditing	310
10.11 Monitoring	310
10.12 Process Package XML Schemas	311
11 Choreography	315
11.1 General	315
11.2 Basic Choreography Concepts	317
11.3 Data	319
11.4 Use of BPMN Common Elements	319
11.4.1 Sequence Flow	320
11.4.2 Artifacts	321
11.5 Choreography Activities	321
11.5.1 Choreography Task	323
11.5.2 Sub-Choreography	328
11.5.3 Call Choreography	333
11.5.4 Global Choreography Task	335
11.5.5 Looping Activities	335
11.5.6 The Sequencing of Activities	335
11.6 Events	339
11.6.1 Start Events	339
11.6.2 Intermediate Events	340
11.6.3 End Events	343
11.7 Gateways	344
11.7.1 Exclusive Gateway	344
11.7.2 Event-Based Gateway	349
11.7.3 Inclusive Gateway	351
11.7.4 Parallel Gateway	358
11.7.5 Complex Gateway	360
11.7.6 Chaining Gateways	361
11.8 Choreography within Collaboration	361

11.8.1	Participants	361
11.8.2	Swimlanes	362
11.9	XML Schema for Choreography	363
12	BPMN Notation and Diagrams	367
12.1	BPMN Diagram Interchange (BPMN DI)	367
12.1.1	Scope	367
12.1.2	Diagram Definition and Interchange	367
12.1.3	How to Read this Clause	368
12.2	BPMN Diagram Interchange (DI) Meta-model	368
12.2.1	Overview	368
12.2.2	Abstract Syntax	368
12.2.3	Classifier Descriptions	370
12.2.4	Complete BPMN DI XML Schema	378
12.3	Notational Depiction Library and Abstract Element Resolutions	380
12.3.1	Labels	381
12.3.2	BPMNShape	381
12.3.3	BPMNEdge	410
12.4	Example(s)	412
12.4.1	Depicting Content in a Sub-Process	412
12.4.2	Multiple Lanes and Nested Lanes	417
12.4.3	Vertical Collaboration	418
12.4.4	Conversation	419
12.4.5	Choreography	421
13	BPMN Execution Semantics	425
13.1	General	425
13.2	Process Instantiation and Termination	426
13.3	Activities	426
13.3.1	Sequence Flow Considerations	427
13.3.2	Activity	428
13.3.3	Task	430
13.3.4	Sub-Process/Call Activity	430
13.3.5	Ad-Hoc Sub-Process	431
13.3.6	Loop Activity	432
13.3.7	Multiple Instances Activity	432
13.4	Gateways	434
13.4.1	Parallel Gateway (Fork and Join)	434
13.4.2	Exclusive Gateway (Exclusive Decision (data-based) and Exclusive Merge) ...	434
13.4.3	Inclusive Gateway (Inclusive Decision and Inclusive Merge)	435
13.4.4	Event-based Gateway (Exclusive Decision (event-based))	437
13.4.5	Complex Gateway (related to Complex Condition and Complex Merge)	437
13.5	Events	439
13.5.1	Start Events	439
13.5.2	Intermediate Events	440
13.5.3	Intermediate Boundary Events	440
13.5.4	Event Sub-Processes	440
13.5.5	Compensation	441
13.5.6	End Events	443

14 Mapping BPMN Models to WS-BPEL	445
14.1 General	445
14.2 Basic BPMN-BPEL Mapping	446
14.2.1 Process	447
14.2.2 Activities	448
14.2.3 Events	455
14.2.4 Gateways and Sequence Flows	461
14.2.5 Handling Data	465
14.3 Extended BPMN-BPEL Mapping	469
14.3.1 End Events	469
14.3.2 Loop/Switch Combinations From a Gateway	469
14.3.3 Interleaved Loops	470
14.3.4 Infinite Loops	473
14.3.5 BPMN Elements that Span Multiple WSBPEL Sub-Elements	473
15 Exchange Formats	475
15.1 Interchanging Incomplete Models	475
15.2 Machine Readable Files	475
15.3 XSD	475
15.3.1 Document Structure	475
15.3.2 References within the BPMN XSD	476
15.4 XMI	477
15.5 XSLT Transformation between XSD and XMI	477
Annex A - Changes from v1.2.....	479
Annex B - Diagram Interchange.....	481
Annex C - Glossary.....	499

List of Figures

- Figure 7.1 – Example of a private Business Process 21
- Figure 7.2 – Example of a public Process 22
- Figure 7.3 – An example of a Collaborative Process 23
- Figure 7.4 – An example of a Choreography 23
- Figure 7.5 – An example of a Conversation diagram 24
- Figure 7.6 – An example of a Collaboration diagram with black-box Pools 43
- Figure 7.7 – An example of a stand-alone Choreography diagram 44
- Figure 7.8 – An example of a stand-alone Process (Orchestration) diagram 45
- Figure 8.1 – A representation of the BPMN Core and Layer Structure 47
- Figure 8.2 – Class diagram showing the core packages 48
- Figure 8.3 – Class diagram showing the organization of the core BPMN elements 49
- Figure 8.4 – Definitions class diagram 50
- Figure 8.5 – Classes in the Foundation package 53
- Figure 8.6 – Extension class diagram 55
- Figure 8.7 – External Relationship Metamodel 60
- Figure 8.8 – Artifacts Metamodel 64
- Figure 8.9 – An Association 65
- Figure 8.10 – The Association Class Diagram 65
- Figure 8.11 – A Directional Association 66
- Figure 8.12 – An Association of Text Annotation 66
- Figure 8.13 – A Group Artifact 67
- Figure 8.14 – A Group around Activities in different Pools 67
- Figure 8.15 – The Group class diagram 68
- Figure 8.16 – A Text Annotation 69
- Figure 8.17 – The Correlation Class Diagram 74
- Figure 8.18 – Error class diagram 79
- Figure 8.19 – Escalation class diagram 80
- Figure 8.20 – Event class diagram 82
- Figure 8.21 – Expression class diagram 83
- Figure 8.22 – FlowElement class diagram 85
- Figure 8.23 – FlowElementContainers class diagram 87
- Figure 8.24 – Gateway class diagram 88
- Figure 8.25 – ItemDefinition class diagram 90
- Figure 8.26 – A Message 91
- Figure 8.27 – A non-initiating Message 91
- Figure 8.28 – Messages Association overlapping Message Flows 92
- Figure 8.29 – Messages shown Associated with a Choreography Task 92
- Figure 8.30 – The Message class diagram 93
- Figure 8.31 – Resource class diagram 94
- Figure 8.32 – A Sequence Flow 95
- Figure 8.33 – A Conditional Sequence Flow 95
- Figure 8.34 – A Default Sequence Flow 96

Figure 8.35 – SequenceFlow class diagram 96

Figure 8.36 – The Service class diagram 102

Figure 9.1 – Classes in the Collaboration package 108

Figure 9.2 – A Pool 111

Figure 9.3 – Message Flows connecting to the boundaries of two Pools 112

Figure 9.4 – Message Flows connecting to Flow Objects within two Pools 112

Figure 9.5 – Main (Internal) Pool without boundaries 113

Figure 9.6 – Pools with a Multi-Instance Participant Markers 113

Figure 9.7 – The Participant Class Diagram 114

Figure 9.8 – A Pool with a Multiple Participant 116

Figure 9.9 – The Participant Multiplicity class diagram 116

Figure 9.10 – ParticipantAssociation class diagram 118

Figure 9.11 – A Message Flow 119

Figure 9.12 – A Message Flow with an Attached Message 120

Figure 9.13 – A Message Flow passing through a Choreography Task 120

Figure 9.14 – The Message Flow Class Diagram 121

Figure 9.15 – MessageFlowAssociation class diagram 123

Figure 9.16 – A Conversation diagram 124

Figure 9.17 – A Conversation diagram where the Conversation is expanded into Message Flows 124

Figure 9.18 – Conversation diagram depicting several conversations between Participants in a related domain 125

Figure 9.19 – An example of a Sub-Conversation 126

Figure 9.20 – An example of a Sub-Conversation expanded to a Conversation and Message Flow 126

Figure 9.21 – An example of a Sub-Conversation that is fully expanded 127

Figure 9.22 – Metamodel of ConversationNode Related Elements 128

Figure 9.23 – A Communication element 129

Figure 9.24 – A compound Conversation element 130

Figure 9.25 – A Call Conversation calling a GlobalConversation 130

Figure 9.26 – A Call Conversation calling a Collaboration 130

Figure 9.27 – A Conversation Link element 131

Figure 9.28 – Conversation links to Activities and Events 132

Figure 9.29 – Metamodel of Conversation Links related elements 133

Figure 9.30 – Call Conversation Links 134

Figure 9.31 – The ConversationAssociation class diagram 135

Figure 9.32 – An example of a Choreography within a Collaboration 137

Figure 9.33– Choreography within Collaboration class diagram 138

Figure 10.1 – An Example of a Process 143

Figure 10.2 – Process class diagram 144

Figure 10.3 – Process Details class diagram 145

Figure 10.4 – Example of a private Business Process 148

Figure 10.5 – Example of a public Process 148

Figure 10.6 – Activity class diagram 149

Figure 10.7 – The class diagram for assigning Resources 152

Figure 10.8 – A Task object 154

Figure 10.9 – Task markers 155

Figure 10.10 – The Task class diagram 155

Figure 10.11 – A Service Task Object 156

Figure 10.12 – The Service Task class diagram 157

Figure 10.13 – A Send Task Object 158

Figure 10.14 – The Send Task and Receive Task class diagram 158

Figure 10.15 – A Receive Task Object 159

Figure 10.16 – A Receive Task Object that instantiates a Process 160

Figure 10.17 – A User Task Object 161

Figure 10.18 – A Manual Task Object 161

Figure 10.19 – A Business Rule Task Object 162

Figure 10.20 – A Script Task Object 162

Figure 10.21 – Manual Task class diagram 163

Figure 10.22 – User Task class diagram 164

Figure 10.23 – HumanPerformer class diagram 165

Figure 10.24 – Procurement Process Example 168

Figure 10.25 – A Sub-Process object (collapsed) 171

Figure 10.26 – A Sub-Process object (expanded) 172

Figure 10.27 – Expanded Sub-Process used as a “Parallel Box” 172

Figure 10.28 – Collapsed Sub-Process Markers 173

Figure 10.29– The Sub-Process class diagram 173

Figure 10.30 – An Event Sub-Process object (Collapsed) 175

Figure 10.31 – An Event Sub-Process object (expanded) 175

Figure 10.32 – An example that includes Event Sub-Processes 176

Figure 10.33 – A Transaction Sub-Process 177

Figure 10.34 – A Collapsed Transaction Sub-Process 177

Figure 10.35 – A collapsed Ad-Hoc Sub-Process 179

Figure 10.36 – An expanded Ad-Hoc Sub-Process 179

Figure 10.37 – An Ad-Hoc Sub-Process for writing a book chapter 181

Figure 10.38 – An Ad-Hoc Sub-Process with data and sequence dependencies 182

Figure 10.39– A Call Activity object calling a Global Task 183

Figure 10.40 – A Call Activity object calling a Process (Collapsed) 183

Figure 10.41 – A Call Activity object calling a Process (Expanded) 183

Figure 10.42 –The Call Activity class diagram 184

Figure 10.43 – CallableElement class diagram 185

Figure 10.44 – Global Tasks class diagram 187

Figure 10.45 – LoopCharacteristics class diagram 188

Figure 10.46 – A Task object with a Standard Loop Marker 189

Figure 10.47 – A Sub-Process object with a Standard Loop Marker 189

Figure 10.48 – Activity Multi-Instance marker for parallel instances 190

Figure 10.49 – Activity Multi-Instance marker for sequential instances 190

Figure 10.50 - ItemAware class diagram 203

Figure 10.51 – DataObject class diagram 204

Figure 10.52 – A DataObject 206

Figure 10.53 – A DataObject that is a collection 206

Figure 10.54 – A Data Store 207

Figure 10.55 – DataStore class diagram 207

Figure 10.56 – Property class diagram 209

Figure 10.57 – InputOutputSpecification class diagram 211

Figure 10.58 – A DataInput 213

Figure 10.59 – Data Input class diagram 213

Figure 10.60 – A Data Output 215
Figure 10.61 – Data Output class diagram 215
Figure 10.62 – InputSet class diagram 218
Figure 10.63 – OutputSet class diagram 219
Figure 10.64 – DataAssociation class diagram 221
Figure 10.65 – A Data Association 221
Figure 10.66 – A Data Association used for an Outputs and Inputs into an Activities 221
Figure 10.67 – A Data Object shown as an output and an inputs 223
Figure 10.68 – A Data Object associated with a Sequence Flow 224
Figure 10.69 – The Event Class Diagram 233
Figure 10.70 – Start Event 238
Figure 10.71 – End Event 245
Figure 10.72 – Intermediate Event 249
Figure 10.73 – EventDefinition Class Diagram 261
Figure 10.74 – Cancel Events 262
Figure 10.75 – Compensation Events 262
Figure 10.76 – CompensationEventDefinition Class Diagram 262
Figure 10.77 – Conditional Events 263
Figure 10.78 – ConditionalEventDefinition Class Diagram 264
Figure 10.79 – Error Events 264
Figure 10.80 – ErrorEventDefinition Class Diagram 265
Figure 10.81 – Escalation Events 265
Figure 10.82 – EscalationEventDefinition Class Diagram 266
Figure 10.83 – Link Events 266
Figure 10.84 – Link Events Used as Off-Page Connector 267
Figure 10.85 – A Process with a long Sequence Flow 268
Figure 10.86 – A Process with Link Intermediate Events used as Go To Objects 268
Figure 10.87 – Link Events Used for looping 269
Figure 10.88 – Message Events 269
Figure 10.89 – MessageEventDefinition Class Diagram 270
Figure 10.90 – Multiple Events 271
Figure 10.91 – None Events 271
Figure 10.92 – Multiple Events 272
Figure 10.93 – SignalEventDefinition Class Diagram 272
Figure 10.94 – Signal Events 272
Figure 10.95 – Terminate Event 273
Figure 10.96 – Timer Events 273
Figure 10.97 – Exclusive start of a Process 274
Figure 10.98 – A Process initiated by an Event-Based Gateway 275
Figure 10.99 – Event synchronization at Process start 275
Figure 10.100 – Example of inline Event Handling via Event Sub-Processes 277
Figure 10.101 – Example of boundary Event Handling 278
Figure 10.102 – A Gateway 286
Figure 10.103 – The Different types of Gateways 287
Figure 10.104 – Gateway class diagram 288
Figure 10.105 – An Exclusive Data-Based Decision (Gateway) Example without the Internal Indicator 289
Figure 10.106 – A Data-Based Exclusive Decision (Gateway) Example with the Internal Indicator 290

Figure 10.107 – Exclusive Gateway class diagram 290

Figure 10.108 – An example using an Inclusive Gateway 291

Figure 10.109 – Inclusive Gateway class diagram 292

Figure 10.110 – An example using an Parallel Gateway 293

Figure 10.111 – An example of a synchronizing Parallel Gateway 293

Figure 10.112 – Parallel Gateway class diagram 294

Figure 10.113 – An example using a Complex Gateway 294

Figure 10.114 – Complex Gateway class diagram 295

Figure 10.115 – Event-Based Gateway 296

Figure 10.116 – An Event-Based Gateway example using Message Intermediate Events 297

Figure 10.117 – An Event-Based Gateway example using Receive Tasks 297

Figure 10.118 – Exclusive Event-Based Gateway to start a Process 298

Figure 10.119 – Parallel Event-Based Gateway to start a Process 298

Figure 10.120 – Event-Based Gateway class diagram 299

Figure 10.121– Compensation through a boundary Event 302

Figure 10.122 – Monitoring Class Diagram 303

Figure 10.123 – Two Lanes in a Vertical Pool 305

Figure 10.124 – Two Lanes in a horizontal Pool 305

Figure 10.125 – An Example of Nested Lanes 306

Figure 10.126 – The Lane class diagram 307

Figure 10.127 – One Process supporting to another 309

Figure 10.128 – Auditing Class Diagram 310

Figure 10.129 – Monitoring Class Diagram 311

Figure 11.1 – The Choreography metamodel 316

Figure 11.2 – An example of a Choreography 317

Figure 11.3 – A Collaboration diagram logistics example 318

Figure 11.4 – The corresponding Choreography diagram logistics example 319

Figure 11.5 – The use of Sequence Flows in a Choreography 320

Figure 11.6 – The metamodel segment for a Choreography Activity 322

Figure 11.7 – A Collaboration view of Choreography Task elements 323

Figure 11.8 – A Choreography Task 323

Figure 11.9 – A Collaboration view of a Choreography Task 324

Figure 11.10 – A two-way Choreography Task 324

Figure 11.11 – A Collaboration view of a two-way Choreography Task 325

Figure 11.12 – Choreography Task Markers 326

Figure 11.13 – The Collaboration view of a looping Choreography Task 326

Figure 11.14 – The Collaboration view of a Parallel Multi-Instance Choreography Task 327

Figure 11.15 – A Choreography Task with a multiple Participant 327

Figure 11.16 – A Collaboration view of a Choreography Task with a multiple Participant 328

Figure 11.17– A Sub-Choreography 329

Figure 11.18 – A Collaboration view of a Sub-Choreography 329

Figure 11.19 – An expanded Sub-Choreography 330

Figure 11.20 – A Collaboration view of an expanded Sub-Choreography 330

Figure 11.21 – Sub-Choreography (Collapsed) with More than Two Participants 331

Figure 11.22 – Sub-Choreography Markers 332

Figure 11.23 – Sub-Choreography Markers with a multi-instance Participant 332

Figure 11.24 – A Call Choreography calling a Global Choreography Task 333

Figure 11.25 – A Call Choreography calling a Choreography (Collapsed) 333

Figure 11.26 – A Call Choreography calling a Choreography (expanded) 334

Figure 11.27– The Call Choreography class diagram 334

Figure 11.28 – A valid sequence of Choreography Activities 336

Figure 11.29 – The corresponding Collaboration for a valid Choreography sequence 337

Figure 11.30 – A valid sequence of Choreography Activities with a two-way Activity 337

Figure 11.31 – The corresponding Collaboration for a valid Choreography sequence with a two-way Activity 338

Figure 11.32 – An invalid sequence of Choreography Activities 338

Figure 11.33 – The corresponding Collaboration for an invalid Choreography sequence 339

Figure 11.34 – An example of the Exclusive Gateway 345

Figure 11.35 – The relationship of Choreography Activity Participants across the sides of the Exclusive Gateway shown through a Collaboration 346

Figure 11.36 – Different Receiving Choreography Activity Participants on the output sides of the Exclusive Gateway 347

Figure 11.37 – The corresponding Collaboration view of the above Choreography Exclusive Gateway configuration 348

Figure 11.38 – An example of an Event Gateway 349

Figure 11.39 – The corresponding Collaboration view of the above Choreography Event Gateway configuration 350

Figure 11.40 – An example of a Choreography Inclusive Gateway configuration 352

Figure 11.41 – The corresponding Collaboration view of the above Choreography Inclusive Gateway configuration 353

Figure 11.42 – An example of a Choreography Inclusive Gateway configuration 354

Figure 11.43 – The corresponding Collaboration view of the above Choreography Inclusive Gateway configuration 355

Figure 11.44 – Another example of a Choreography Inclusive Gateway configuration 356

Figure 11.45 – The corresponding Collaboration view of the above Choreography Inclusive Gateway configuration 357

Figure 11.46 – The relationship of Choreography Activity Participants across the sides of the Parallel Gateway 358

Figure 11.47 – The corresponding Collaboration view of the above Choreography Parallel Gateway configuration 359

Figure 11.48 – An example of a Choreography Complex Gateway configuration 360

Figure 11.49 – The corresponding Collaboration view of the above Choreography Complex Gateway configuration 361

Figure 11.50 – An example of a Choreography Process combined with Black Box Pools 362

Figure 11.51 – An example of a Choreography Process combined with Pools that contain Processes 363

Figure 12.1 – BPMN Diagram 369

Figure 12.2 – BPMN Plane 369

Figure 12.3 – BPMN Shape 369

Figure 12.4 – BPMN Edge 370

Figure 12.5 – BPMN Label 370

Figure 12.6 – Depicting a Label for a DataObjectReference with its state 381

Figure 12.7 – Combined Compensation and Loop Characteristic Marker Example 384

Figure 12.8 – Expanded Sub-Process Example 413

Figure 12.9 – Start and End Events on the Border Example 414

Figure 12.10 – Collapsed Sub-Process 415

Figure 12.11 – Contents of Collapsed Sub-Process 416

Figure 12.12 – Nested Lanes Example 417
Figure 12.13 – Vertical Collaboration Example 418
Figure 12.14 – Conversation Example 420
Figure 12.15 – Choreography Example 422
Figure 13.1 – Behavior of multiple outgoing Sequence Flows of an Activity 427
Figure 13.2 – The Lifecycle of a BPMN Activity 428
Figure 13.3 – Merging and Branching Sequence Flows for a Parallel Gateway 434
Figure 13.4 – Merging and Branching Sequence Flows for an Exclusive Gateway 434
Figure 13.5 – Merging and Branching Sequence Flows for an Inclusive Gateway 435
Figure 13.6 – Merging and branching Sequence Flows for an Event-Based Gateway 437
Figure 13.7 – Merging and branching Sequence Flows for a Complex Gateway 437
Figure 14.1 – A BPMN orchestration process and its block hierarchy 446
Figure 14.2 – An example of distributed token recombination 469
Figure 14.3 – An example of a loop from a decision with more than two alternative paths 470
Figure 14.4 – An example of interleaved loops 471
Figure 14.5 – An example of the WSBPEL pattern for substituting for the derived Process 472
Figure 14.6 – An example of a WSBPEL pattern for the derived Process 472
Figure 14.7 – An example: An infinite loop 473
Figure 14.8 – An example: Activity that spans two paths of a WSBPEL structured element 474
Figure B.1 – Diagram Definition Architecture 483
Figure B.2 – The Primitive Types 483
Figure B.3 – Diagram Definition Architecture 484
Figure B.4 – Diagram Definition Architecture 484
Figure B.5 – Dependencies of the DI package 488
Figure B.6 – Diagram Element 488
Figure B.7 – Node 488
Figure B.8 – Edge 489
Figure B.9 – Diagram 489
Figure B.10 – Plane 489
Figure B.11 – Labeled Edge 490
Figure B.12 – Labeled Shape 490
Figure B.13 – Shape 490

List of Tables

Table 2.1 – Descriptive Conformance Sub-Class Elements and Attributes	3
Table 2.2 – Analytic Conformance Sub-Class Elements and Attributes	4
Table 2.3 – Common Executable Conformance Sub-Class Elements and Attributes	6
Table 2.4 – Common Executable Conformance Sub-Class Supporting Classes	7
Table 2.5 – Types of BPMN Conformance	12
Table 7.1 – Basic Modeling Elements	27
Table 7.2 – BPMN Extended Modeling Elements	29
Table 7.3 – Sequence Flow Connection Rules	40
Table 7.4 – Message Flow Connection Rules	42
Table 8.1 – Definitions attributes and model associations	50
Table 8.2 – Import attributes	52
Table 8.3 – Definitions XML schema	52
Table 8.4 – Import XML schema	53
Table 8.5 – BaseElement attributes and model associations	54
Table 8.6 – Documentation attributes	54
Table 8.7 – Extension attributes and model associations	56
Table 8.8 – ExtensionDefinition attributes and model associations	57
Table 8.9 – ExtensionAttributeDefinition attributes	57
Table 8.10 – ExtensionAttributeValue model associations	57
Table 8.11 – Extension XML schema	58
Table 8.12 – Example Core XML schema	58
Table 8.13 – Example Extension XML schema	59
Table 8.14 – Sample XML instance	59
Table 8.15 – Relationship attributes	61
Table 8.16 – Reengineer XML schema	61
Table 8.17 – BaseElement XML schema	62
Table 8.18 – RootElement XML schema	63
Table 8.19 – Relationship XML schema	63
Table 8.20 – Association attributes and model associations	66
Table 8.21 – Group model associations	68
Table 8.22 – Category model associations	69
Table 8.23 – CategoryValue attributes and model associations	69
Table 8.24 – Text Annotation attributes	70
Table 8.25 – Artifact XML schema	70
Table 8.26 – Association XML schema	70
Table 8.27 – Category XML schema	70
Table 8.28 – CategoryValue XML schema	71
Table 8.29 – Group XML schema	71
Table 8.30 – Text Annotation XML schema	71
Table 8.31 – CorrelationKey model associations	75
Table 8.32 – CorrelationProperty model associations	75
Table 8.33 – CorrelationPropertyRetrievalExpression model associations	76

Table 8.34 – CorrelationSubscription model associations	76
Table 8.35 – CorrelationPropertyBinding model associations	77
Table 8.36 – Correlation Key XML schema	77
Table 8.37 – Correlation Property XML schema	77
Table 8.38 – Correlation Property Binding XML schema	78
Table 8.39 – Correlation Property Retrieval Expression XML schema	78
Table 8.40 – Correlation Subscription XML schema	78
Table 8.41 – Error attributes and model associations	80
Table 8.42 – Escalation attributes and model associations	81
Table 8.43 – FormalExpression attributes and model associations	84
Table 8.44 – FlowElement attributes and model associations	86
Table 8.45 – FlowElementsContainer model associations	87
Table 8.46 – Gateway attributes	89
Table 8.47 – ItemDefinition attributes & model associations	90
Table 8.48 – Message attributes and model associations	93
Table 8.49 – Resource attributes and model associations	94
Table 8.50 – ResourceParameter attributes and model associations	95
Table 8.51 – SequenceFlow attributes and model associations	97
Table 8.52 – FlowNode model associations	98
Table 8.53 – Error XML schema	98
Table 8.54 – Escalation XML schema	98
Table 8.55 – Expression XML schema	98
Table 8.56 – FlowElement XML schema	99
Table 8.57 – FlowNode XML schema	99
Table 8.58 – FormalExpression XML schema	99
Table 8.59 – InputOutputBinding XML schema	99
Table 8.60 – ItemDefinition XML schema	100
Table 8.61 – Message XML schema	100
Table 8.62 – Resources XML schema	100
Table 8.63 – ResourceParameter XML schema	101
Table 8.64 – SequenceFlow XML schema	101
Table 8.65 – Interface attributes and model associations	103
Table 8.66 – Operation attributes and model associations	104
Table 8.67 – Interface XML schema	104
Table 8.68 – Operation XML schema	104
Table 8.69 – EndPoint XML schema	105
Table 9.1 – Collaboration Attributes and Model Associations	108
Table 9.2 – Participant attributes and model associations	115
Table 9.3 – PartnerEntity attributes	115
Table 9.4 – PartnerRole attributes	116
Table 9.5 – ParticipantMultiplicity attributes	117
Table 9.6 – ParticipantMultiplicity Instance attributes	117
Table 9.7 – ParticipantAssociation model associations	119
Table 9.8 – Message Flow attributes and model associations	122
Table 9.9 – MessageFlowAssociation attributes and model associations	123
Table 9.10 – ConversationNode Model Associations	129
Table 9.11 – Sub-Conversation Model Associations	130

Table 9.12 – Call Conversation Model Associations	131
Table 9.13 – Conversation Link Attributes and Model Associations	133
Table 9.14 – ConversationAssociation Model Associations	135
Table 9.15 – Call Conversation XML schema	138
Table 9.16 – Collaboration XML schema	138
Table 9.17 – Conversation XML schema	139
Table 9.18 – ConversationAssociation XML schema	139
Table 9.19 – ConversationAssociation XML schema	139
Table 9.20 – ConversationNode XML schema	140
Table 9.21 – Conversation Node XML schema	140
Table 9.22 – Global Conversation XML schema	140
Table 9.23 – MessageFlow XML schema	140
Table 9.24 – MessageFlowAssociation XML schema	141
Table 9.25 – Participant XML schema	141
Table 9.26 – ParticipantAssociation XML schema	141
Table 9.27 – ParticipantMultiplicity XML schema	142
Table 9.28 – PartnerEntity XML schema	142
Table 9.29 – PartnerRole XML schema	142
Table 9.30 – Sub-Conversation XML schema	142
Table 10.1 – Process Attributes & Model Associations	145
Table 10.2 – Process instance attributes	147
Table 10.3 – Activity attributes and model associations	150
Table 10.4 – Activity instance attributes	151
Table 10.5 – Resource Role model associations	153
Table 10.6 – ResourceAssignmentExpression model associations	153
Table 10.7 – ResourceParameterBinding model associations	154
Table 10.8 – Service Task model associations	157
Table 10.9 – Send Task model associations	159
Table 10.10 – Receive Task attributes and model associations	160
Table 10.11 – Business Rule Task attributes and model associations	162
Table 10.12 – Script Task attributes	163
Table 10.13 – User Task attributes and model associations	164
Table 10.14 – User Task instance attributes	165
Table 10.15 – ManualTask XML schema	166
Table 10.16 – UserTask XML schema	167
Table 10.17 – HumanPerformer XML schema	168
Table 10.18 – PotentialOwner XML schema	168
Table 10.19 – XML serialization of Buyer process	169
Table 10.20 – Sub-Process attributes	174
Table 10.21 – Transaction Sub-Process attributes and model associations	178
Table 10.22 – Ad-hoc Sub-Process model associations	180
Table 10.23 – CallActivity model associations	185
Table 10.24 – CallableElement attributes and model associations	186
Table 10.25 – InputOutputBinding model associations	186
Table 10.26 – Global Task model associations	187
Table 10.27 – Loop Activity instance attributes	189
Table 10.28 – StandardLoopCharacteristics attributes and model associations	190

Table 10.29	– MultiInstanceLoopCharacteristics attributes and model associations	191
Table 10.30	– Multi-instance Activity instance attributes	193
Table 10.31	– ComplexBehaviorDefinition attributes and model associations	194
Table 10.32	– Activity XML schema	194
Table 10.33	– AdHocSubProcess XML schema	195
Table 10.34	– BusinessRuleTask XML schema	195
Table 10.35	– CallableElement XML schema	196
Table 10.36	– CallActivity XML schema	196
Table 10.37	– GlobalBusinessRuleTask XML schema	196
Table 10.38	– GlobalScriptTask XML schema	197
Table 10.39	– GlobalTask XML schema	197
Table 10.40	– LoopCharacteristics XML schema	197
Table 10.41	– MultiInstanceLoopCharacteristics XML schema	198
Table 10.42	– ReceiveTask XML schema	199
Table 10.43	– ResourceRole XML schema	199
Table 10.44	– ScriptTask XML schema	200
Table 10.45	– SendTask XML schema	200
Table 10.46	– ServiceTask XML schema	200
Table 10.47	– StandardLoopCharacteristics XML schema	201
Table 10.48	– SubProcess XML schema	201
Table 10.49	– Task XML schema	201
Table 10.50	– Transaction XML schema	202
Table 10.51	– ItemAwareElement model associations	203
Table 10.52	– DataObject attributes	205
Table 10.53	– DataObjectReference attributes and model associations	205
Table 10.54	– DataState attributes and model associations	205
Table 10.55	– Data Store attributes	208
Table 10.56	– Data Store attributes	208
Table 10.57	– Property attributes	209
Table 10.58	– InputOutputSpecification Attributes and Model Associations	212
Table 10.59	– DataInput attributes and model associations	214
Table 10.60	– DataOutput attributes and associations	216
Table 10.61	– InputSet attributes and model associations	218
Table 10.62	– OutputSet attributes and model associations	220
Table 10.63	– DataAssociation model associations	222
Table 10.64	– Assignment attributes	223
Table 10.65	– XPath Extension Function for Data Objects	226
Table 10.66	– XPath Extension Function for Data Inputs and Data Outputs	226
Table 10.67	– XPath Extension Functions for Properties	227
Table 10.68	– XPath extension functions for instance attributes	228
Table 10.69	– Assignment XML schema	228
Table 10.70	– DataAssociation XML schema	229
Table 10.71	– DataInput XML schema	229
Table 10.72	– DataInputAssociation XML schema	229
Table 10.73	– DataObject XML schema	230
Table 10.74	– DataState XML schema	230
Table 10.75	– DataOutput XML schema	230

Table 10.76 – DataOutputAssociation XML schema	230
Table 10.77 – InputOutputSpecification XML schema	231
Table 10.78 – InputSet XML schema	231
Table 10.79 – OutputSet XML schema	232
Table 10.80 – Property XML schema	232
Table 10.81 – Event model associations	235
Table 10.82 – CatchEvent attributes and model associations	235
Table 10.83 – ThrowEvent attributes and model associations	236
Table 10.84 – Top-Level Process Start Event Types	239
Table 10.85 – Sub-Process Start Event Types	241
Table 10.86 – Event Sub-Process Start Event Types	241
Table 10.87 – Start Event attributes	244
Table 10.88 – End Event Types	246
Table 10.89 – Intermediate Event Types in Normal Flow	250
Table 10.90 – Intermediate Event Types Attached to an Activity Boundary	253
Table 10.91 – Boundary Event attributes	257
Table 10.92 – Possible Values of the cancelActivity Attribute	257
Table 10.93 – Types of Events and their Markers	260
Table 10.94 – CompensationEventDefinition attributes and model associations	263
Table 10.95 – ConditionalEventDefinition model associations	264
Table 10.96 – ErrorEventDefinition attributes and model associations	265
Table 10.97 – EscalationEventDefinition attributes and model associations	266
Table 10.98 – LinkEventDefinition attributes	269
Table 10.99 – MessageEventDefinition model associations	270
Table 10.100 – SignalEventDefinition model associations	272
Table 10.101 – TimerEventDefinition model associations	273
Table 10.102 – BoundaryEvent XML schema	281
Table 10.103 – CancelEventDefinition XML schema	281
Table 10.104 – CatchEvent XML schema	281
Table 10.105 – CancelEventDefinition XML schema	281
Table 10.106 – CompensateEventDefinition XML schema	282
Table 10.107 – ConditionalEventDefinition XML schema	282
Table 10.108 – ErrorEventDefinition XML schema	282
Table 10.109 – EscalationEventDefinition XML schema	282
Table 10.110 – Event XML schema	283
Table 10.111 – EventDefinition XML schema	283
Table 10.112 – ImplicitThrowEvent XML schema	283
Table 10.113 – IntermediateCatchEvent XML schema	283
Table 10.114 – IntermediateThrowEvent XML schema	283
Table 10.115 – LinkEventDefinition XML schema	283
Table 10.116 – MessageEventDefinition XML schema	284
Table 10.117 – Signal XML schema	284
Table 10.118 – SignalEventDefinition XML schema	284
Table 10.119 – StartEvent XML schema	285
Table 10.120 – TerminateEventDefinition XML schema	285
Table 10.121 – ThrowEvent XML schema	285
Table 10.122 – TimerEventDefinition XML schema	285

Table 10.123 – ExclusiveGateway Attributes & Model Associations	291
Table 10.124 – InclusiveGateway Attributes & Model Associations	292
Table 10.125 – Complex Gateway model associations	295
Table 10.126 – Instance attributes related to the Complex Gateway	296
Table 10.127 – EventBasedGateway Attributes & Model Associations	299
Table 10.128 – ComplexGateway XML schema	300
Table 10.129 – EventBasedGateway XML schema	300
Table 10.130 – ExclusiveGateway XML schema	300
Table 10.131 – Gateway XML schema	300
Table 10.132 – InclusiveGateway XML schema	301
Table 10.133 – ParallelGateway XML schema	301
Table 10.134 – LaneSet attributes and model associations	307
Table 10.135 – Lane attributes and model associations	308
Table 10.136 – Process XML schema	311
Table 10.137 – Auditing XML schema	312
Table 10.138 – GlobalTask XML schema	312
Table 10.139 – Lane XML schema	312
Table 10.140 – LaneSet XML schema	312
Table 10.141 – Monitoring XML schema	313
Table 10.142 – Performer XML schema	313
Table 11.1 – Choreography Activity Model Associations	322
Table 11.2 – Choreography Task Model Associations	328
Table 11.3 – Sub-Choreography Model Associations	332
Table 11.4 – Call Choreography Model Associations	335
Table 11.5 – Global Choreography Task Model Associations	335
Table 11.6 – Use of Start Events in Choreography	340
Table 11.7 – Use of Intermediate Events in Choreography	340
Table 11.8 – Use of End Events in Choreography	343
Table 11.9 – Choreography XML schema	363
Table 11.10 – GlobalChoreographyTask XML schema	364
Table 11.11 – ChoreographyActivity XML schema	364
Table 11.12 – ChoreographyTask XML schema	364
Table 11.13 – CallChoreography XML schema	365
Table 11.14 – SubChoreography XML schema	365
Table 12.1 – BPMNDiagram XML schema	371
Table 12.2 – BPMNPlane XML schema	372
Table 12.3 – BPMNShape XML schema	374
Table 12.4 – BPMNEdge XML schema	376
Table 12.5 – BPMNLabel XML schema	377
Table 12.6 – BPMNLabelStyle XML schema	378
Table 12.7 – Complete BPMN DI XML schema	378
Table 12.8 – Depiction Resolution for Loop Compensation Marker	382
Table 12.9 – Depiction Resolution for Tasks	385
Table 12.10 – Depiction Resolution for Collapsed Sub-Processes	386
Table 12.11 – Depiction Resolution for Expanded Sub-Processes	386
Table 12.12 – Depiction Resolution for Collapsed Ad Hoc Sub-Processes	387
Table 12.13 – Depiction Resolution for Expanded Ad Hoc Sub-Processes	387

Table 12.14 – Depiction Resolution for Collapsed Transactions	387
Table 12.15 – Depiction Resolution for Tasks	388
Table 12.16 – Depiction Resolution for Collapsed Event Sub-Processes	388
Table 12.17 – Depiction Resolution for Expanded Event Sub-Processes	391
Table 12.18 – Depiction Resolution for Call Activities (Calling a Global Task)	391
Table 12.19 – Depiction Resolution for Collapsed Call Activities (Calling a Process)	392
Table 12.20 – Depiction Resolution for Expanded Call Activities (Calling a Process)	392
Table 12.21 – Depiction Resolution for Data	393
Table 12.22 – Depiction Resolution for Events	394
Table 12.23 – Depiction Resolution for Gateways	400
Table 12.24 – Depiction Resolution for Artifacts	401
Table 12.25 – Depiction Resolution for Lanes	401
Table 12.26 – Depiction Resolution for Pools	402
Table 12.27 – Depiction Resolution for Choreography Tasks	403
Table 12.28 – Depiction Resolution for Sub-Choreographies (Collapsed)	404
Table 12.29 – Depiction Resolution for Sub-Choreographies (Expanded)	405
Table 12.30 – Depiction Resolution for Call Choreographies (Calling a Global Choreography Task)	405
Table 12.31 – Depiction Resolution for Collapsed Call Choreographies (Calling a Choreography)	406
Table 12.32 – Depiction Resolution for Expanded Call Choreographies (Calling a Choreography)	407
Table 12.33 – Depiction Resolution for Choreography Participant Bands	408
Table 12.34 – Depiction Resolution for Conversations	410
Table 12.35 – Depiction Resolution for Connecting Objects	411
Table 12.36 – Expanded Sub-Process BPMN DI instance	413
Table 12.37 – Start and End Events on the Border BPMN DI instance	414
Table 12.38 – Collapsed Sub-Process BPMN DI instance	416
Table 12.39 – Sub-Process Content BPMN DI instance	416
Table 12.40 – Multiple Lanes and Nested Lanes BPMN DI instance	417
Table 12.41 – Vertical Collaboration BPMN DI instance	418
Table 12.42 – Conversation BPMN DI instance	420
Table 12.43 – Choreography BPMN DI instance	422
Table 13.1 – Parallel Gateway Execution Semantics	434
Table 13.2 – Exclusive Gateway Execution Semantics	435
Table 13.3 – Inclusive Gateway Execution Semantics	436
Table 13.4 – Event-Based Gateway Execution Semantics	437
Table 13.5 – Semantics of the Complex Gateway	438
Table 14.1 – Common Activity Mappings to WS-BPEL	448
Table 14.2 – Expressions mapping to WS-BPEL	468

Preface

About the Object Management Group

OMG

Founded in 1989, the Object Management Group, Inc. (OMG) is an open membership, not-for-profit computer industry standards consortium that produces and maintains computer industry specifications for interoperable, portable, and reusable enterprise applications in distributed, heterogeneous environments. Membership includes Information Technology vendors, end users, government agencies, and academia.

OMG member companies write, adopt, and maintain its specifications following a mature, open process. OMG's specifications implement the Model Driven Architecture® (MDA®), maximizing ROI through a full-lifecycle approach to enterprise integration that covers multiple operating systems, programming languages, middleware and networking infrastructures, and software development environments. OMG's specifications include: UML® (Unified Modeling Language™); CORBA® (Common Object Request Broker Architecture); CWM™ (Common Warehouse Metamodel); and industry-specific standards for dozens of vertical markets.

More information on the OMG is available at <http://www.omg.org/>.

OMG Specifications

As noted, OMG specifications address middleware, modeling and vertical domain frameworks. All OMG specifications are available from the OMG website at:

<http://www.omg.org/spec>

Specifications are organized by the following categories:

Business Modeling Specifications

Middleware Specifications

- CORBA/IIOP
- Data Distribution Services
- Specialized CORBA

IDL/Language Mapping Specifications

Modeling and Metadata Specifications

- UML, MOF, CWM, XMI
- UML Profile

Modernization Specifications

Platform Independent Model (PIM), Platform Specific Model (PSM), Interface Specifications

- CORBAServices
- CORBAFacilities

OMG Domain Specifications

CORBA Embedded Intelligence Specifications

CORBA Security Specifications

All of OMG's formal specifications may be downloaded without charge from our website. (Products implementing OMG specifications are available from individual suppliers.) Copies of specifications, available in PostScript and PDF format, may be obtained from the link cited above or by contacting the Object Management Group, Inc. at:

OMG Headquarters
109 Highland Avenue
Needham, MA 02494
USA
Tel: +1-781-444-0404
Fax: +1-781-444-0320
Email: pubs@omg.org

Certain OMG specifications are also available as ISO standards. Please consult <http://www.iso.org>

Typographical Conventions

The type styles shown below are used in this document to distinguish programming statements from ordinary English. However, these conventions are not used in tables or section headings where no distinction is necessary.

Times/Times New Roman - 10 pt.: Standard body text

Helvetica/Arial - 10 pt. Bold: OMG Interface Definition Language (OMG IDL) and syntax elements.

Courier - 10 pt. Bold: Programming language elements.

Helvetica/Arial - 10 pt: Exceptions

Note – Terms that appear in *italics* are defined in the glossary. Italic text also represents the name of a document, specification, or other publication.

Issues

The reader is encouraged to report any technical or editing issues/problems with this specification to http://www.omg.org/report_issue.htm.

1 Scope

1.1 General

The **Object Management Group** (OMG) has developed a standard **Business Process Model and Notation (BPMN)**. The primary goal of **BPMN** is to provide a notation that is readily understandable by all business users, from the business analysts that create the initial drafts of the processes, to the technical developers responsible for implementing the technology that will perform those processes, and finally, to the business people who will manage and monitor those processes. Thus, **BPMN** creates a standardized bridge for the gap between the business process design and process implementation.

Another goal, but no less important, is to ensure that XML languages designed for the execution of business processes, such as **WSBPEL** (Web Services Business Process Execution Language), can be visualized with a business-oriented notation.

This International Standard represents the amalgamation of best practices within the business modeling community to define the notation and semantics of **Collaboration** diagrams, **Process** diagrams, and **Choreography** diagrams. The intent of **BPMN** is to standardize a business process model and notation in the face of many different modeling notations and viewpoints. In doing so, **BPMN** will provide a simple means of communicating process information to other business users, process implementers, customers, and suppliers.

The membership of the OMG has brought forth expertise and experience with many existing notations and has sought to consolidate the best ideas from these divergent notations into a single standard notation. Examples of other notations or methodologies that were reviewed are UML Activity Diagram, UML EDOC Business Processes, IDEF, ebXML BPSS, Activity-Decision Flow (ADF) Diagram, RosettaNet, LOVeM, and Event-Process Chains (EPCs).

2 Conformance

2.1 General

Software can claim compliance or conformance with **BPMN 2.0** if and only if the software fully matches the applicable compliance points as stated in the International Standard. Software developed only partially matching the applicable compliance points can claim only that the software was based on this International Standard, but cannot claim compliance or conformance with this International Standard. The International Standard defines four types of conformance namely **Process Modeling Conformance**, **Process Execution Conformance**, **BPEL Process Execution Conformance**, and **Choreography Modeling Conformance**.

The implementation claiming conformance to **Process Modeling Conformance** type is NOT REQUIRED to support **Choreography Modeling Conformance** type and vice-versa. Similarly, the implementation claiming **Process Execution Conformance** type is NOT REQUIRED to be conformant to the **Process Modeling** and **Choreography Conformance** types.

The implementation claiming conformance to the **Process Modeling Conformance type** SHALL comply with all of the requirements set forth in sub clause 2.1. The implementation claiming conformance to the **Process Execution Conformance type** SHALL comply with all of the requirements set forth in sub clause 2.2. The implementation claiming conformance to the **BPEL Process Execution Semantics Conformance type** SHALL comply with all of the

requirements set forth in sub clause 2.3. The implementation claiming conformance to the **Choreography Conformance type** SHALL comply with all of the requirements set forth in sub clause 2.4. The implementation is said to have **BPMN Complete Conformance** if it complies with all of the requirements stated in sub clauses 2.1, 2.2, 2.3, and 2.4.

2.2 Process Modeling Conformance

The next eight sub clauses describe **Process Modeling Conformance**.

2.2.1 BPMN Process Types

The implementations claiming **Process Modeling Conformance** MUST support the following **BPMN** packages:

- ◆ The **BPMN** core elements, which include those defined in the *Infrastructure, Foundation, Common, and Service* packages (see Clause 8).
- ◆ **Process** diagrams, which include the elements defined in the **Process, Activities, Data, and Human Interaction** packages (see Clause 10).
- ◆ **Collaboration** diagrams, which include **Pools** and **Message Flow** (see Clause 9).
- ◆ **Conversation** diagrams, which include **Pools, Conversations, and Conversation Links** (see Clause 9).

As an alternative to full **Process Modeling Conformance**, there are three conformance sub-classes defined:

- ◆ **Descriptive**
- ◆ **Analytic**
- ◆ **Common Executable**

Descriptive is concerned with visible elements and attributes used in high-level modeling. It should be comfortable for analysts who have used BPA flowcharting tools.

Analytic contains all of **Descriptive** and in total about half of the constructs in the full **Process Modeling Conformance** Class. It is based on experience gathered in BPMN training and an analysis of user-patterns in the Department of Defense Architecture Framework and planned standardization for that framework.

Both **Descriptive** and **Analytic** focus on visible elements and a minimal subset of supporting attributes/elements.

Common Executable focuses on what is needed for executable process models.

Elements and attributes not in these sub-classes are contained in the full **Process Modeling Conformance** class.

The elements for each sub-class are defined in the next sub clause.

2.2.2 BPMN Process Elements

The **Process Modeling Conformance** type set consists of **Collaboration** and **Process** diagram elements, including all **Task** types, *embedded Sub-Processes*, **CallActivity**, all **Gateway** types, all **Event** types (**Start, Intermediate, and End**), **Lane, Participants, Data Object** (including **DataInput** and **DataOutput**), **Message, Group, Text Annotation, Sequence Flow** (including *conditional* and *default* flows), **Message Flow, Conversations** (limited to grouping **Message Flow**, and associating *correlations*), *Correlation*, and **Association** (including **Compensation Association**). The set also includes markers (**Loop, Multi-Instance, Transaction, Compensation**) for **Tasks** and *embedded Sub-Processes*).

NOTE: Implementations are not expected to support **Choreography** modeling elements such as **Choreography Task** and **Sub-Choreography**.

For a tool to claim support for a sub-class the following criteria **MUST** be satisfied:

- ◆ All the elements in the sub-class **MUST** be supported.
- ◆ For each element, all the listed attributes **MUST** be supported.
- ◆ In general, if the sub-class doesn't mention an attribute and it is **NOT REQUIRED** by the schema, then it is not in the subclass. Exceptions to this rule are noted.

Descriptive Conformance Sub-Class

The **Descriptive** conformance sub-class elements are shown in Table 2.1.

Table 2.1 – Descriptive Conformance Sub-Class Elements and Attributes

Element	Attributes
participant (pool)	id, name, processRef
laneSet	id, lane with name, childLaneSet, flowElementRef
sequenceFlow (unconditional)	id, name, sourceRef, targetRef
messageFlow	id, name, sourceRef, targetRef
exclusiveGateway	id, name
parallelGateway	id, name
task (None)	id, name
userTask	id, name
serviceTask	id, name
subProcess (expanded)	id, name, flowElement
subProcess (collapsed)	id, name, flowElement
CallActivity	id, name, calledElement
DataObject	id, name
TextAnnotation	id, text
association/dataAssociation ^a	id, name, sourceRef, targetRef, associationDirection ^b
dataStoreReference	id, name, dataStoreRef
startEvent (None)	id, name
endEvent (None)	id, name

Table 2.1 – Descriptive Conformance Sub-Class Elements and Attributes

messageStartEvent	id, name, messageEventDefinition
messageEndEvent	id, name, messageEventDefinition
timerStartEvent	id, name, timerEventDefinition
terminateEndEvent	id, name, terminateEventDefinition
documentation ^c	text
Group	id, categoryRef

- a. **Data Association** is ABSTRACT: **Data Input Association** and **Data Output Association** will appear in the XML serialization. These both have REQUIRED attributes [sourceRef and targetRef] which refer to itemAwareElements. To be consistent with the metamodel, this will require the following additional elements: ioSpecification, inputSet, outputSet, **Data Input**, **Data Output**. When a **BPMN** editor draws a **Data Association** to an **Activity** or **Event** it should generate this supporting invisible substructure. Otherwise, the metamodel would have to be changed to make sourceRef and targetRef optional or allow reference to non-itemAwareElements, e.g., **Activity** and **Event**.
- b. associationDirection not specified for **Data Association**
- c. Documentation is not a visible element. It is an attribute of most elements.

Analytic Conformance Sub-Class

The **Analytic** conformance sub-class contains all the elements of the **Descriptive** conformance sub-class plus the elements shown in Table 2.2.

Table 2.2 – Analytic Conformance Sub-Class Elements and Attributes

Element	Attributes
sequenceFlow (conditional)	id, name, sourceRef, targetRef, conditionExpression ^a
sequenceFlow (default)	id, name, sourceRef, targetRef, default ^b
sendTask	id, name
receiveTask	id, name
Looping Activity	standardLoopCharacteristics
MultInstance Activity	multiInstanceLoopCharacteristics
exclusiveGateway	Add default attribute
inclusiveGateway	id, name, eventGatewayType
eventBasedGateway	id, name, eventGatewayType
Link catch/throw Intermediate Event	Id, name, linkEventDefinition
signalStartEvent	id, name, signalEventDefinition

Table 2.2 – Analytic Conformance Sub-Class Elements and Attributes

signalEndEvent	id, name, signalEventDefinition
Catching message Intermediate Event	id, name, messageEventDefinition
Throwing message Intermediate Event	id, name, messageEventDefinition
Boundary message Intermediate Event	id, name, attachedToRef, messageEventDefinition
Non-interrupting Boundary message Intermediate Event	id, name, attachedToRef, cancelActivity=false, messageEventDefinition
Catching timer Intermediate Event	id, name, timerEventDefinition
Boundary timer Intermediate Event	id, name, attachedToRef, timerEventDefinition
Non-interrupting Boundary timer Intermediate Event	id, name, attachedToRef, cancelActivity=false, timerEventDefinition
Boundary error Intermediate Event	id, name, attachedToRef, errorEventDefinition
errorEndEvent	id, name, errorEventDefinition
Non-interrupting Boundary escalation Intermediate Event	id, name, attachedToRef, cancelActivity=false, escalationEventDefinition
Throwing escalation Intermediate Event	id, name, escalationEventDefinition
escalationEndEvent	id, name, escalationEventDefinition
Catching signal Intermediate Event	id, name, signalEventDefinition
Throwing signal Intermediate Event	id, name, signalEventDefinition
Boundary signal Intermediate Event	id, name, attachedToRef, signalEventDefinition
Non-interrupting Boundary signal Intermediate Event	id, name, attachedToRef, cancelActivity=false, signalEventDefinition
conditionalStartEvent	id, name, conditionalEventDefinition
Catching conditional Intermediate Event	id, name, conditionalEventDefinition
Boundary conditional Intermediate Event	id, name, conditionalEventDefinition
Non-interrupting Boundary conditional Intermediate Event	id, name, cancelActivity=false, conditionalEventDefinition

Table 2.2 – Analytic Conformance Sub-Class Elements and Attributes

message ^c	id, name, add messageRef attribute to messageFlow
----------------------	---

- a. ConditionExpression, allowed only for **Sequence Flow** out of **Gateways**, MAY be null.
- b. Default is an attribute of a sourceRef (exclusive or inclusive) **Gateway**.
- c. Note that messageRef, an attribute of various message **Events**, is optional and not in the sub-class.

Common Executable Conformance Sub-Class

This conformance sub-class is intended for modeling tools that can emit executable models.

- ◆ Data type definition language MUST be XML Schema.
- ◆ Service Interface definition language MUST be WSDL.
- ◆ Data access language MUST be XPath.

The **Common Executable** conformance sub-class elements are shown in Table 2.3 and its supporting classes in Table 2.4.

Table 2.3 – Common Executable Conformance Sub-Class Elements and Attributes

Element	Attributes
sequenceFlow (unconditional)	id, (name), sourceRef ^a , targetRef ^b
sequenceFlow (conditional)	id, name, sourceRef, targetRef, conditionExpression ^c
sequenceFlow (default)	id, name, sourceRef, targetRef, default ^d
subProcess (expanded)	id, name, flowElement, loopCharacteristics, boundaryEventRefs
exclusiveGateway	id, name, gatewayDirection (only converging and diverging), default
parallelGateway	id, name, gatewayDirection (only converging and diverging)
startEvent (None)	id, name
endEvent (None)	id, name
eventBasedGateway	id, name, gatewayDirection, eventGatewayType
userTask	id, name, renderings, implementation, resources, ioSpecification, dataInputAssociations, dataOutputAssociations, loopCharacteristics, boundaryEventRefs
serviceTask	id, name, implementation, operationRef, ioSpecification, dataInputAssociations, dataOutputAssociations, loopCharacteristics, boundaryEventRefs
callActivity	id, name, calledElement, ioSpecification, dataInputAssociations, dataOutputAssociations, loopCharacteristics, boundaryEventRefs
dataObject	id, name, isCollection, itemSubjectRef
textAnnotation	id, text

Table 2.3 – Common Executable Conformance Sub-Class Elements and Attributes

dataAssociation	id, name, sourceRef, targetRef, assignment
messageStartEvent	id, name, messageEventDefinition (either ref or contained), dataOutput, dataOutputAssociations
messageEndEvent	id, name, messageEventDefinition, (either ref or contained), dataInput, dataInputAssociations
terminateEndEvent	(Terminating trigger in combination with one of the other end events)
Catching message Intermediate Event	id, name, messageEventDefinition (either ref or contained), dataOutput, dataOutputAssociations
Throwing message Intermediate Event	id, name, messageEventDefinition (either ref or contained), dataInput, dataInputAssociations
Catching timer Intermediate Event	id, name, timerEventDefinition (contained)
Boundary error Intermediate Event	id, name, attachedToRef, errorEventDefinition, (contained or referenced), dataOutput, dataOutputAssociations

- a. Multiple outgoing connections are only allowed for converging **Gateways**.
- b. Multiple outgoing connections are only allowed for diverging **Gateways**.
- c. `ConditionExpression`, allowed only for **Sequence Flow** out of **Gateways**, MAY be null.
- d. `Default` is an attribute of a `sourceRef` (exclusive or inclusive) **Gateway**.

Table 2.4 – Common Executable Conformance Sub-Class Supporting Classes

Element	Attributes
StandardLoopCharacteristics	id, loopCondition
MultInstanceLoopCharacteristics	id, isSequential, loopDataInput, inputDataItem
Rendering	
Resource	id, name
ResourceRole	id, resourceRef, resourceAssignmentExpression
InputOutputSpecification	id, dataInputs, dataOutputs
DataInput	id, name, isCollection, itemSubjectRef
DataOutput	id, name, isCollection, itemSubjectRef
ItemDefinition	id, structure or import ^a
Operation	id, name, inMessageRef, outMessageRef, errorRefs
Message	id, name, structureRef
Error	id, structureRef
Assignment	id, from, to ^b

Table 2.4 – Common Executable Conformance Sub-Class Supporting Classes

MessageEventDefinition	id, messageRef, operationRef
TerminateEventDefinition	id
TimerEventDefinition	id, timeDate

- a. Structure MUST be defined by an XSD Complex Type
- b. Structure MUST be defined by an XSD Complex Type

2.2.3 Visual Appearance

A key element of **BPMN** is the choice of shapes and icons used for the graphical elements identified in this International Standard. The intent is to create a standard visual language that all process modelers will recognize and understand. An implementation that creates and displays **BPMN Process** Diagrams SHALL use the graphical elements, shapes, and markers illustrated in this International Standard.

NOTE: There is flexibility in the size, color, line style, and text positions of the defined graphical elements, except where otherwise specified (see page 41).

The following extensions to a **BPMN** Diagram are permitted:

- ◆ New markers or indicators MAY be added to the specified graphical elements. These markers or indicators could be used to highlight a specific attribute of a **BPMN** element or to represent a new subtype of the corresponding concept.
- ◆ A new shape representing a kind of **Artifact** MAY be added to a Diagram, but the new **Artifact** shape SHALL NOT conflict with the shape specified for any other **BPMN** element or marker.
- ◆ Graphical elements MAY be colored, and the coloring MAY have specified semantics that extend the information conveyed by the element as specified in this International Standard.
- ◆ The line style of a graphical element MAY be changed, but that change SHALL NOT conflict with any other line style REQUIRED by this International Standard.
- ◆ An extension SHALL NOT change the specified shape of a defined graphical element or marker (e.g., changing a square into a triangle, or changing rounded corners into squared corners, etc.).

2.2.4 Structural Conformance

An implementation that creates and displays **BPMN** diagrams SHALL conform to the specifications and restrictions with respect to the connections and other diagrammatic relationships between graphical elements. Where permitted or requested connections are specified as conditional and based on attributes of the corresponding concepts, the implementation SHALL ensure the correspondence between the connections and the values of those attributes.

NOTE: In general, these connections and relationships have specified semantic interpretations, which specify interactions among the process concepts represented by the graphical elements. Conditional relationships based on attributes represent specific variations in behavior. Structural conformance therefore guarantees the correct interpretation of the diagram as a specification of process, in terms of flows of control and information. Throughout the document, structural specifications will appear in paragraphs using a special shaped bullet: Example: ◆ A **TASK** MAY be a target for **Sequence Flow**; it can have multiple *incoming* Flows. An *incoming* Flow MAY be from an alternative path and/or parallel paths.

2.2.5 Process Semantics

This International Standard defines many semantic concepts used in defining **Processes**, and associates them with graphical elements, markers, and connections. To the extent that an implementation provides an interpretation of the **BPMN** diagram as a semantic specification of **Process**, the interpretation SHALL be consistent with the semantic interpretation herein specified. In other words, the implementation claiming **BPMN Process Modeling Conformance** has to support the semantics surrounding the diagram elements expressed in Clause 10.

NOTE: The implementations claiming **Process Modeling Conformance** are not expected to support the **BPMN** execution semantics described in Clause 13.

2.2.6 Attributes and Model Associations

This International Standard defines a number of attributes and properties of the semantic elements represented by the graphical elements, markers, and connections. Some of these attributes are purely representational and are so marked, and some have mandated representations. Some attributes are specified as mandatory, but have no representation or only optional representation. And some attributes are specified as optional. For every attribute or property that is specified as mandatory, a conforming implementation SHALL provide some mechanism by which values of that attribute or property can be created and displayed. This mechanism SHALL permit the user to create or view these values for each **BPMN** element specified to have that attribute or property. Where a graphical representation for that attribute or property is specified as **REQUIRED**, that graphical representation SHALL be used. Where a graphical representation for that attribute or property is specified as optional, the implementation MAY use either a graphical representation or some other mechanism. If a graphical representation is used, it SHALL be the representation specified. Where no graphical representation for that attribute or property is specified, the implementation MAY use either a graphical representation or some other mechanism. If a graphical representation is used, it SHALL NOT conflict with the specified graphical representation of any other **BPMN** element.

2.2.7 Extended and Optional Elements

A conforming implementation is **NOT REQUIRED** to support any element or attribute that is specified herein to be non-normative or informative. In each instance in which this International Standard defines a feature to be “optional,” it specifies whether the option is in:

- how the feature will be displayed,
- whether the feature will be displayed,
- whether the feature will be supported.

A conforming implementation is **NOT REQUIRED** to support any feature whose support is specified to be optional. If an implementation supports an optional feature, it SHALL support it as specified. A conforming implementation SHALL support any “optional” feature for which the option is only in whether or how it SHALL be displayed.

2.2.8 Visual Interchange

One of the main goals of this International Standard is to provide an interchange format that can be used to exchange **BPMN** definitions (both domain model and diagram layout) between different tools. The implementation should support the metamodel for **Process** types specified in sub clause 13.1 to enable portability of process diagrams so that users can take business process definitions created in one vendor’s environment and use them in another vendor’s environment.

2.3 Process Execution Conformance

The next two sub clauses describe **Process Execution Conformance**.

2.3.1 Execution Semantics

The **BPMN** execution semantics have been fully formalized in this version of the International Standard. The tool claiming **BPMN Execution Conformance** type MUST fully support and interpret the operational semantics and **Activity** life-cycle specified in sub clause 14.2.2. Non-operational elements listed in Clause 14 MAY be ignored by implementations claiming **BPMN Execution Conformance** type. Conformant implementations MUST fully support and interpret the underlying metamodel.

NOTE: The tool claiming **Process Execution Conformance type** is not expected to support and interpret **Choreography** models. The tool claiming **Process Execution Conformance type** is not expected to support **Process Modeling Conformance**. More precisely, the tool is not required to support graphical syntax and semantics defined in this International Standard. It MAY use different graphical elements, shapes and markers, than those defined in this International Standard.

2.3.2 Import of Process Diagrams

The tool claiming **Process Execution Conformance type** MUST support import of **BPMN Process** diagram types including its definitional **Collaboration** (see Table 10.1).

2.4 BPEL Process Execution Conformance

Special type of Process Execution Conformance that supports the **BPMN** mapping to WS-BPEL as specified in sub clause 15.1 can claim **BPEL Process Execution Conformance**.

NOTE: The tool claiming **BPEL Process Execution Conformance** MUST fully support **Process Execution Conformance**. The tool claiming **BPEL Process Execution Conformance** is not expected to support and interpret **Choreography** models. The tool claiming **BPEL Process Execution Conformance** is not expected to support **Process Modeling Conformance**.

2.5 Choreography Modeling Conformance

The next five sub clauses describe **Choreography Conformance**.

2.5.1 BPMN Choreography Types

The implementations claiming **Choreography Conformance** type MUST support the following **BPMN** packages:

- ◆ The **BPMN** core elements, which include those defined in the Infrastructure, Foundation, Common, and Service packages (see Clause 8).
- ◆ **Choreography** diagrams, which includes the elements defined in the **Choreography**, and **Choreography** packages (see Clause 11).
- ◆ **Collaboration** diagrams, which include **Pools** and **Message Flow** (see Clause 9).

2.5.2 BPMN Choreography Elements

The **Choreography Conformance** set includes **Message**, **Choreography Task**, **Global Choreography Task**, **Sub-Choreography** (expanded and collapsed), certain types of **Start Events** (e.g., **None**, **Timer**, **Conditional**, **Signal**, and **Multiple**), certain types of **Intermediate Events** (**None**, **Message** attached to **Activity** boundary, **Timer** – normal as well as attached to **Activity** boundary, **Timer** used in **Event Gateways**, **Cancel** attached to an **Activity** boundary, **Conditional**, **Signal**, **Multiple**, **Link**, etc.) and certain types of **End Events** (**None** and **Terminate**), and **Gateways**. In addition, to enable **Choreography** within **Collaboration** it should support **Pools** and **Message Flow**.

2.5.3 Visual Appearance

An implementation that creates and displays **BPMN Choreography** Diagrams SHALL use the graphical elements, shapes, and markers as specified in the **BPMN** International Standard. The use of text, color, size and lines for **Choreography** diagram types are listed in sub clause 7.4.

2.5.4 Choreography Semantics

The tool claiming **Choreography Conformance** should fully support and interpret the graphical and execution semantics surrounding **Choreography** diagram elements and **Choreography** diagram types.

2.5.5 Visual Interchange

The implementation should support import/export of **Choreography** diagram types and **Collaboration** diagram types that depict **Choreography** within **collaboration** as specified in sub clause 9.4 to enable portability of **Choreography** definitions, so that users can take **BPMN** definitions created in one vendor's environment and use them in another vendor's environment.

2.6 Summary of BPMN Conformance Types

Table 2.5 summarizes the requirements for **BPMN** Conformance.

Table 2.5 – Types of BPMN Conformance

Category	Process Modeling Conformance	Process Execution Conformance	BPEL Process Execution Conformance	Choreography Conformance
Visual representation of BPMN Diagram Types	Process diagram types and Collaboration diagram types depicting collaborations among Process diagram types.	N/A	N/A	Choreography diagram types and Collaboration diagram types depicting collaboration among Choreography diagram types.
BPMN Diagram Elements that need to be supported.	All Task types, embedded Sub-Process, Call Activity, all Event types, all Gateway types, Pool, Lane, Data Object (including DataInput and DataOutput), Message, Group, Artifacts, markers for Tasks and Sub-Processes, SequenceFlow, Associations, and Message Flow.	N/A	N/A	Message, Choreography Task, Global Choreography Task, Sub-Choreography (expanded and collapsed), certain types of Start, Intermediate, and End Events, Gateways, Pools and Message Flow.
Import/Export of diagram types	Yes for Process and Collaboration diagrams that depict Process within Collaboration.	Yes for Process diagrams	Yes for Process diagrams	Yes for Choreography and Collaboration diagrams depicting choreography within Collaboration.
Support for Graphical syntax and semantics	Process and Collaboration diagrams that depict Process within Collaboration.	N/A	N/A	Choreography and Collaboration diagrams depicting Choreography within Collaboration.
Support for Execution Semantics	N/A	Yes for Process diagrams	Yes for Process diagrams	Choreography execution semantics

3 Normative References

3.1 General

The following referenced documents are indispensable for the application of this document. For dated references, only the edition cited applies. For undated references, the latest edition of the referenced document (including any amendments) applies.

3.2 Normative

OMG UML

- OMG Unified Modeling Language (OMG UML), Superstructure, V2.1.2 - <http://www.omg.org/spec/UML/2.1.2/Superstructure>

OMG MOF

- Object Management Group - Meta Object Facility (MOF) Core Specification, V2.0 <http://www.omg.org/spec/MOF/2.0>

RFC-2119

- Key words for use in RFCs to Indicate Requirement Levels, S. Bradner, IETF RFC 2119, March 1997 <http://www.ietf.org/rfc/rfc2119.txt>

3.3 Non-Normative

Activity Service

- Additional Structuring Mechanism for the OTS Specification, OMG, June 1999 <http://www.omg.org>
- J2EE Activity Service for Extended Transactions (JSR 95), JCP <http://www.jcp.org/jsr/detail/95.jsp>

BPEL4People

- WS-BPEL Extension for People (BPEL4People) Specification Version 1.1, Committee Specification, 17 August 2010 <http://docs.oasis-open.org/bpel4people/bpel4people-1.1-spec-cs-01.html>

Business Process Definition Metamodel

- OMG, May 2008, <http://www.omg.org/docs/dtc/08-05-07.pdf>

Business Process Modeling

- Jean-Jacques Dubray, "A Novel Approach for Modeling Business Process Definitions," 2002 <http://www.ebpm.org/ebpm12.2.doc>

Business Transaction Protocol

- OASIS BTP Technical Committee, June, 2002 http://www.oasis-open.org/committees/download.php/1184/2002-06-03.BTP_cttee_spec_1.0.pdf

Dublin Core Meta Data

- Dublin Core Metadata Element Set, Dublin Core Metadata Initiative
<http://dublincore.org/documents/dces/>

ebXML BPSS

- Jean-Jacques Dubray, “A new model for ebXML BPSS Multi-party Collaborations and Web Services Choreography,” 2002
<http://www.ebpml.org/ebpml.doc>

Open Nested Transactions

- Concepts and Applications of Multilevel Transactions and Open Nested Transactions, Gerhard Weikum, Hans-J. Schek, 1992
<http://citeseer.nj.nec.com/weikum92concepts.html>

RDF

- RDF Vocabulary Description Language 1.0: RDF Schema, W3C Working Draft
<http://www.w3.org/TR/rdf-schema/>

SOAP 1.2

- SOAP Version 1.2 Part 1: Messaging Framework, W3C Working Draft
<http://www.w3.org/TR/soap12-part1/>
- SOAP Version 1.2 Part21: Adjuncts, W3C Working Draft
<http://www.w3.org/TR/soap12-part2/>

UDDI

- Universal Description, Discovery and Integration, Ariba, IBM and Microsoft, UDDI.org.
<http://www.uddi.org>

URI

- Uniform Resource Identifiers (URI): Generic Syntax, T. Berners-Lee, R. Fielding, L. Masinter, IETF RFC 2396, August 1998
<http://www.ietf.org/rfc/rfc2396.txt>

WfMC Glossary

- Workflow Management Coalition Terminology and Glossary
<http://www.wfmc.org/wfmc-standards-framework.html>

Web Services Transaction

- (WS-Transaction) 1.1, OASIS, 12 July 2007,
<http://www.oasis-open.org/committees/ws-tx/>

Workflow Patterns

- Russell, N., ter Hofstede, A.H.M., van der Aalst W.M.P, & Mulyar, N. (2006). Workflow Control-Flow Patterns: A Revised View. BPM Center Report BPM-06-22, BPMcentre.org
<http://www.workflowpatterns.com/>

WSBPEL

- Web Services Business Process Execution Language (WSBPEL) 2.0, OASIS Standard, April 2007
<http://docs.oasis-open.org/wsbpel/2.0/OS/wsbpel-v2.0-OS.html>

WS-Coordination

- Web Services Coordination (WS-Coordination) 1.1, OASIS Standard, July 2007
<http://www.oasis-open.org/committees/ws-tx/>

WSDL

- Web Services Description Language (WSDL) 2.0, W3C Proposed Recommendation, June 2007
<http://www.w3.org/TR/wsd120/>

WS-HumanTask

- Web Services Human Task (WS-HumanTask) 1.1, August 2010
<http://docs.oasis-open.org/bpel4people/ws-humantask-1.1-spec-cs-01.html>

XML 1.0 (Second Edition)

- Extensible Markup Language (XML) 1.0, Second Edition, Tim Bray et al., eds., W3C, 6 October 2000
<http://www.w3.org/TR/REC-xml>

XML-Namespaces

- Namespaces in XML, Tim Bray et al., eds., W3C, 14 January 1999
<http://www.w3.org/TR/REC-xml-names>

XML-Schema

- XML Schema Part 1: Structures, Henry S. Thompson, David Beech, Murray Maloney, Noah Mendelsohn, W3C, 2 May 2001
<http://www.w3.org/TR/xmlschema-1/>
- XML Schema Part 2: Datatypes, Paul V. Biron and Ashok Malhotra, eds., W3C, 2 May 2001
<http://www.w3.org/TR/xmlschema-2/>

XPath

- XML Path Language (XPath) 1.0, James Clark and Steve DeRose, eds., W3C, 16 November 1999
<http://www.w3.org/TR/xpath>

XPDL

- Workflow Management Coalition XML Process Definition Language, version 2.0.
<http://www.wfmc.org/wfmc-standards-framework.html>

4 Terms and Definitions

NOTE: See Annex C - Glossary.

5 Symbols

NOTE: There are no symbols defined.

6 Additional Information

6.1 Conventions

The sub clause introduces the conventions used in this document. This includes (text) notational conventions and notations for schema components. Also included are designated namespace definitions.

6.1.1 Typographical and Linguistic Conventions and Style

This International Standard incorporates the following conventions:

- The keywords “MUST,” “MUST NOT,” “REQUIRED,” “SHALL,” “MUST NOT,” “SHOULD,” “SHOULD NOT,” “RECOMMENDED,” “MAY,” and “OPTIONAL” in this document are to be interpreted as described in RFC-2119.
- A **term** is a word or phrase that has a special meaning. When a term is defined, the term name is highlighted in **bold** typeface.
- A reference to another definition, sub clause, or specification is highlighted with underlined typeface and provides a link to the relevant location in this International Standard.
- A reference to a graphical element is highlighted with a bold, capitalized word and will be presented with the **Arial** font (e.g., **Sub-Process**).
- A reference to a non-graphical element or **BPMN** concept is highlighted by being italicized and will be presented with the Times New Roman font (e.g., *token*).
- A reference to an attribute or model association will be presented with the Courier New font (e.g., *Expression*).
- A reference to a WSBPEL element, attribute, or construct is highlighted with an italic lower-case word, usually preceded by the word “WSBPEL” and will be presented with the Courier New font (e.g., *WSBPEL pick*).
- Non-normative examples are set off in boxes and accompanied by a brief explanation.

- XML and pseudo code is highlighted with mono-spaced typeface. Different font colors MAY be used to highlight the different components of the XML code.
- The cardinality of any content part is specified using the following operators:
 - <none> — exactly once
 - [0..1] — 0 or 1
 - [0..*] — 0 or more
 - [1..*] — 1 or more
- Attributes separated by | and grouped within { and } — alternative values
 - <value> — default value
 - <type> — the type of the attribute

6.1.2 Abbreviations

The following abbreviations are used throughout:

This abbreviation	Refers to
WSBPEL	Web Services Business Process Execution Language (see WSBPEL). This abbreviation refers specifically to version 2.0 of this International Standard.
WSDL	Web Service Description Language (see WSDL). This abbreviation refers specifically to the W3C Technical Note, 15 March 2001, but is intended to support future versions of the WSDL specification.

6.2 Structure of this Document

Clause 1 discusses the scope of the document and provides a summary of the elements introduced in subsequent clauses of the document.

Clause 7 introduces the **BPMN Core** that includes basic **BPMN** elements needed for constructing various **Business Processes**, including **collaborations**, *orchestration Processes* and **Choreographies**.

Elements needed for modeling of **Collaborations**, *orchestration Processes*, **Conversations**, and **Choreographies** are introduced in Clauses 8, 9, 10 and 11, respectively.

Clause 13 introduces the **BPMN** visual diagram model. Clause 14 defines the execution semantics for **Process orchestrations** in **BPMN 2.0**. Clause 14 discusses a mapping of a **BPMN** model to WS-BPEL that is derived by analyzing the **BPMN** objects and the relationships between these objects. Exchange formats and an XSLT transformation between them are provided in Clause 15.

6.3 Acknowledgments

Submitting Organizations

The following companies are formal submitting members of OMG:

- Axway
- International Business Machines

- MEGA International
- Oracle
- SAP AG
- Unisys

Supporting Organizations

The following organizations support this International Standard but are not formal submitters:

- Accenture
- Adaptive
- BizAgi
- Bruce Silver Associates
- Capgemini
- Enterprise Agility
- France Telecom
- IDS Scheer
- Intalio
- Metastorm
- Model Driven Solutions
- Nortel
- Red Hat Software
- Software AG
- TIBCO Software
- Vangent

Special Acknowledgments

The following persons were members of the core teams that contributed to the content of this International Standard: Anurag Aggarwal, Mike Amend, Sylvain Astier, Alistair Barros, Rob Bartel, Mariano Benitez, Conrad Bock, Gary Brown, Justin Brunt, John Bulles, Martin Chapman, Fred Cummins, Rouven Day, Maged Elaasar, David Frankel, Denis Gagné, John Hall, Reiner Hille-Doering, Dave Ings, Pablo Irassar, Oliver Kieselbach, Matthias Kloppmann, Jana Koehler, Frank Michael Kraft, Tammo van Lessen, Frank Leymann, Antoine Lonjon, Sumeet Malhotra, Falko Menge, Jeff Mischkinsky, Dale Moberg, Alex Moffat, Ralf Mueller, Sjir Nijssen, Karsten Ploesser, Pete Rivett, Michael Rowley, Bernd Ruecker, Tom Rutt, Suzette Samoojh, Robert Shapiro, Vishal Saxena, Scott Schanel, Axel Scheithauer, Bruce Silver, Meera Srinivasan, Antoine Toulme, Ivana Trickovic, Hagen Voelzer, Franz Weber, Andrea Westerinen and Stephen A. White.

In addition, the following persons contributed valuable ideas and feedback that improved the content and the quality of this International Standard: im Amsden, Mariano Belaunde, Peter Carlson, Cory Casanave, Michele Chinosi, Manoj Das, Robert Lario, Sumeet Malhotra, Henk de Man, David Marston, Neal McWhorter, Edita Mileviciene, Vadim Pevzner, Pete Rivett, Jesus Sanchez, Markus Schacher, Sebastian Stein, and Prasad Yendluri.

7 Overview

7.1 General

There has been much activity in the past few years in developing web service-based XML execution languages for Business Process Management (BPM) systems. Languages such as WSBPEL provide a formal mechanism for the definition of business processes. The key element of such languages is that they are optimized for the operation and inter-operation of BPM Systems. The optimization of these languages for software operations renders them less suited for direct use by humans to design, manage, and monitor **Business Processes**. WSBPEL has both graph and block structures and utilizes the principles of formal mathematical models, such as pi-calculus¹. This technical underpinning provides the foundation for business process execution to handle the complex nature of both internal and B2B interactions and takes advantage of the benefits of Web services. Given the nature of WSBPEL, a complex **Business Process** could be organized in a potentially complex, disjointed, and unintuitive format that is handled very well by a software system (or a computer programmer), but would be hard to understand by the business analysts and managers tasked to develop, manage, and monitor the **Process**. Thus, there is a human level of “inter-operability” or “portability” that is not addressed by these web service-based XML execution languages.

Business people are very comfortable with visualizing **Business Processes** in a flow-chart format. There are thousands of business analysts studying the way companies work and defining **Business Processes** with simple flow charts. This creates a technical gap between the format of the initial design of **Business Processes** and the format of the languages, such as WSBPEL, that will execute these **Business Processes**. This gap needs to be bridged with a formal mechanism that maps the appropriate visualization of the **Business Processes** (a notation) to the appropriate execution format (a BPM execution language) for these **Business Processes**.

Inter-operation of **Business Processes** at the human level, rather than the software engine level, can be solved with standardization of the Business Process Model and Notation (**BPMN**). **BPMN** provides multiple diagrams, which are designed for use by the people who design and manage **Business Processes**. **BPMN** also provides a mapping to an execution language of BPM Systems (WSBPEL). Thus, **BPMN** would provide a standard visualization mechanism for **Business Processes** defined in an execution optimized business process language.

BPMN provides businesses with the capability of understanding their internal business procedures in a graphical notation and will give organizations the ability to communicate these procedures in a standard manner. Currently, there are scores of **Process** modeling tools and methodologies. Given that individuals will move from one company to another and that companies will merge and diverge, it is likely that business analysts need to understand multiple representations of **Business Processes**—potentially different representations of the same **Process** as it moves through its lifecycle of development, implementation, execution, monitoring, and analysis. Therefore, a standard graphical notation will facilitate the understanding of the performance **Collaborations** and business *transactions* within and between the organizations. This will ensure that businesses will understand themselves and participants in their business and will enable organizations to adjust to new internal and B2B business circumstances quickly. **BPMN** follows the tradition of flowcharting notations for readability and flexibility. In addition, the **BPMN** execution semantics is fully formalized. The OMG is using the experience of the business process notations that have preceded **BPMN** to create the next generation notation that combines readability, flexibility, and expandability.

1. See Milner, 1999, “Communicating and Mobile Systems: the π -Calculus,” Cambridge University Press. ISBN 0 521 64320 1 (hc.) ISBN 0 521 65869 1 (pbk.)

BPMN will also advance the capabilities of traditional business process notations by inherently handling B2B **Business Process** concepts, such as *public* and *private* **Processes** and **Choreographies**, as well as advanced modeling concepts, such as *exception handling*, *transactions*, and *compensation*.

7.2 BPMN Scope

This International Standard provides a notation and model for **Business Processes** and an interchange format that can be used to exchange **BPMN Process** definitions (both domain model and diagram layout) between different tools. The goal of the International Standard is to enable portability of **Process** definitions, so that users can take **Process** definitions created in one vendor's environment and use them in another vendor's environment.

The **BPMN 2.0.1** International Standard extends the scope and capabilities of the **BPMN 1.2** in several areas:

- Formalizes the execution semantics for all **BPMN** elements.
- Defines an extensibility mechanism for both **Process** model extensions and graphical extensions.
- Refines **Event** composition and correlation.
- Extends the definition of human interactions.
- Defines a **Choreography** model.

This International Standard also resolves known **BPMN 1.2** inconsistencies and ambiguities.

BPMN is constrained to support only the concepts of modeling that are applicable to **Business Processes**. This means that other types of modeling done by organizations for business purposes is out of scope for **BPMN**. Therefore, the following are aspects that are out of the scope of this International Standard:

- Definition of organizational models and resources,
- Modeling of functional breakdowns,
- Data and information models,
- Modeling of strategy,
- Business rules models.

Since these types of high-level modeling either directly or indirectly affects **Business Processes**, the relationships between **BPMN** and other high-level business modeling can be defined more formally as **BPMN** and other specifications are advanced.

While **BPMN** shows the flow of data (**Messages**), and the association of data artifacts to **Activities**, it is not a data flow language. In addition, operational simulation, monitoring, and deployment of **Business Processes** are out of scope of this International Standard.

BPMN 2.0.1 can be mapped to more than one platform dependent process modeling language, e.g., WS-BPEL 2.0. This International Standard includes a mapping of a subset of **BPMN** to WS-BPEL 2.0. Mappings to other emerging standards are considered to be separate efforts.

The International Standard utilizes other standards for defining data types, Expressions, and service operations. These standards are XML Schema, XPath, and WSDL, respectively.

7.2.1 Uses of BPMN

Business Process modeling is used to communicate a wide variety of information to a wide variety of audiences. **BPMN** is designed to cover many types of modeling and allows the creation of end-to-end **Business Processes**. The structural elements of **BPMN** allow the viewer to be able to easily differentiate between sections of a **BPMN** Diagram. There are three basic types of sub-models within an end-to-end **BPMN** model:

1. **Processes** (*Orchestration*), including:
 - *Private non-executable* (internal) **Business Processes**
 - *Private executable* (internal) **Business Processes**
 - **Public Processes**
2. **Choreographies**
3. **Collaborations**, which can include **Processes** and/or **Choreographies**
 - A view of **Conversations**

Private (Internal) Business Processes

Private Business Processes are those internal to a specific organization. These **Processes** have been generally called workflow or BPM **Processes** (see Figure 10.4). Another synonym typically used in the Web services area is the *Orchestration* of services. There are two types of *private Processes*: *executable* and *non-executable*. An *executable Process* is a **Process** that has been modeled for the purpose of being executed according to the semantics defined in Clause 14. Of course, during the development cycle of the **Process**, there will be stages where the **Process** does not have enough detail to be “executable.” A non-executable **Process** is a *private Process* that has been modeled for the purpose of documenting **Process** behavior at a modeler-defined level of detail. Thus, information needed for execution, such as formal condition **Expressions** are typically not included in a *non-executable Process*.

If a swimlanes-like notation is used (e.g., a **Collaboration**, see below) then a *private Business Process* will be contained within a single **Pool**. The **Process** flow is therefore contained within the **Pool** and cannot cross the boundaries of the **Pool**. The flow of **Messages** can cross the **Pool** boundary to show the interactions that exist between separate *private Business Processes*.



Figure 7.1 – Example of a *private Business Process*

Public Processes

A *public Process* represents the interactions between a *private Business Process* and another **Process** or *Participant* (see Figure 7.2). Only those **Activities** that are used to communicate to the other *Participant(s)* are included in the *public Process*. All other “internal” **Activities** of the *private Business Process* are not shown in the *public Process*. Thus, the *public Process* shows to the outside world the **Message Flows** and the order of those **Message Flows** that are needed to interact with that **Process**. *Public Processes* can be modeled separately or within a **Collaboration** to show the flow of **Messages** between the *public Process Activities* and other *Participants*. Note that the *public* type of **Process** was named “abstract” in **BPMN 1.2**.

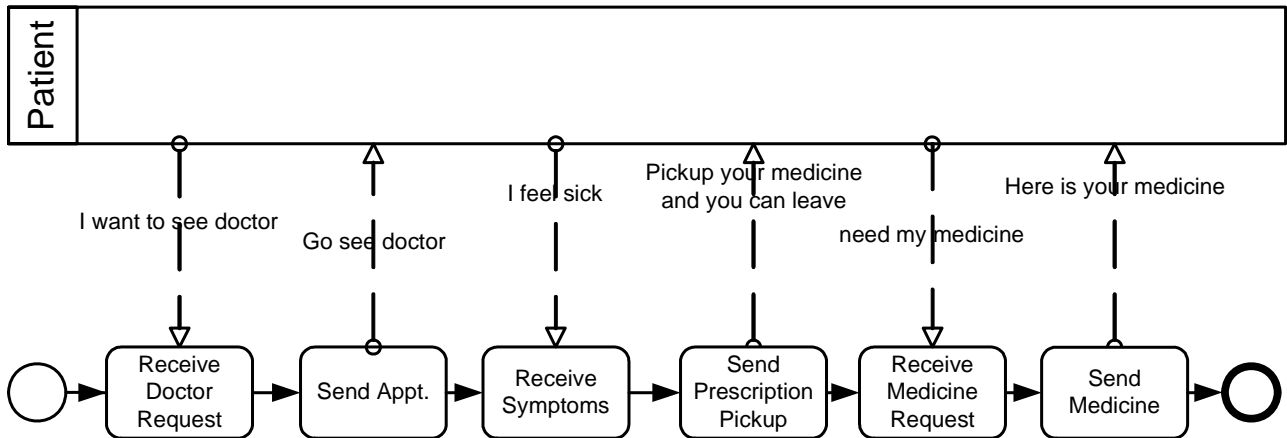

Figure 7.2 – Example of a *public* Process

Collaborations

A **Collaboration** depicts the interactions between two or more business entities. A **Collaboration** usually contains two or more **Pools**, representing the *Participants* in the **Collaboration**. The **Message** exchange between the *Participants* is shown by a **Message Flow** that connects two **Pools** (or the objects within the **Pools**). The **Messages** associated with the **Message Flows** can also be shown. The **Collaboration** can be shown as two or more *public* **Processes** communicating with each other (see Figure 7.3). With a *public* **Process**, the **Activities** for the **Collaboration** participants can be considered the “touch-points” between the participants. The corresponding internal (executable) **Processes** are likely to have much more **Activity** and detail than what is shown in the *public* **Processes**. Or a **Pool** MAY be empty, a “black box.” **Choreographies** MAY be shown “in between” the **Pools** as they bisect the **Message Flows** between the **Pools**. All combinations of **Pools**, **Processes**, and a **Choreography** are allowed in a **Collaboration**.

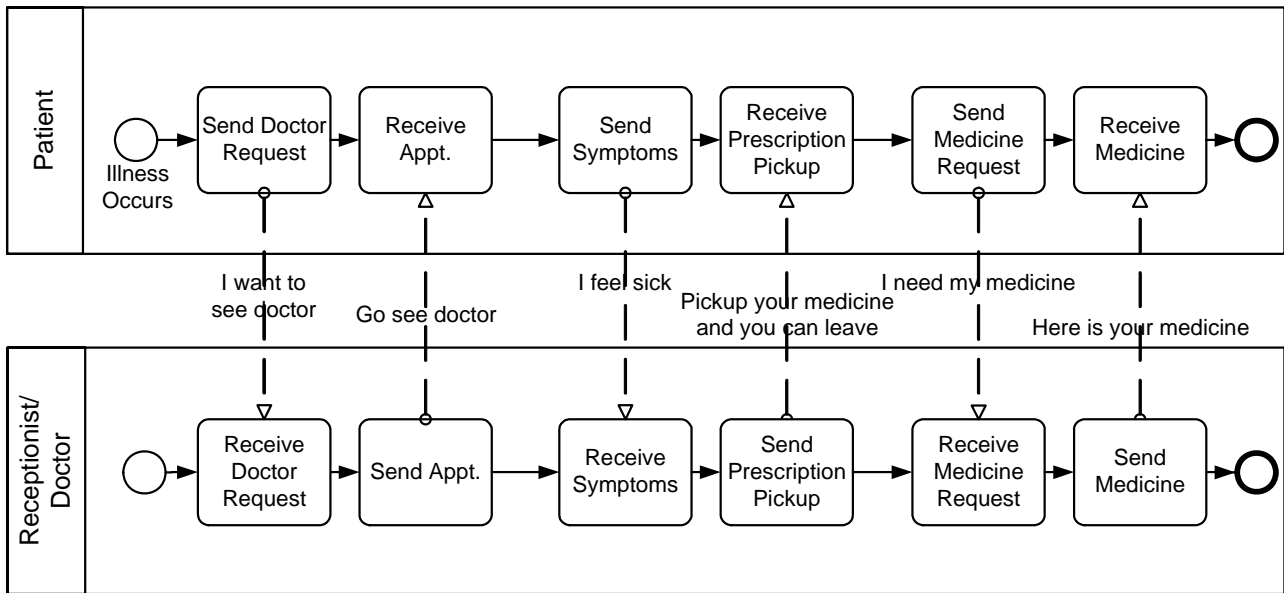

Figure 7.3 – An example of a Collaborative Process

Choreographies

A self-contained **Choreography** (no **Pools** or *Orchestration*) is a definition of the expected behavior, basically a procedural contract, between interacting *Participants*. While a normal **Process** exists within a **Pool**, a **Choreography** exists between **Pools** (or *Participants*).

The **Choreography** looks similar to a *private Business Process* since it consists of a network of **Activities**, **Events**, and **Gateways** (see Figure 7.4). However, a **Choreography** is different in that the **Activities** are interactions that represent a set (1 or more) of **Message** exchanges, which involves two or more *Participants*. In addition, unlike a normal **Process**, there is no central controller, responsible entity, or observer of the **Process**.

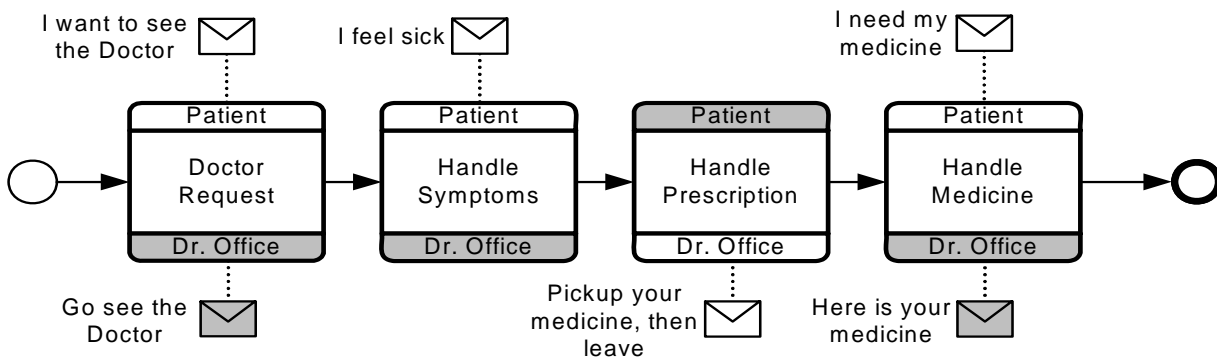

Figure 7.4 – An example of a Choreography

Conversations

The **Conversation** diagram is a particular usage of and an informal description of a **Collaboration** diagram. However, the **Pools** of a **Conversation** usually do not contain a **Process** and a **Choreography** is usually not placed in between the **Pools** of a **Conversation** diagram. A **Conversation** is the logical relation of **Message** exchanges. The logical relation, in practice, often concerns a business object(s) of interest, e.g., “Order,” “Shipment and Delivery,” or “Invoice.”

Message exchanges are related to each other and reflect distinct business scenarios. For example, in logistics, stock replenishments involve the following type scenarios: creation of sales orders; assignment of carriers for shipments combining different sales orders; crossing customs/quarantine; processing payment, and investigating exceptions. Thus, a **Conversation** diagram, as shown in Figure 7.5, shows **Conversations** (as hexagons) between *Participants* (**Pools**). This provides a “bird’s eye” perspective of the different **Conversations** that relate to the domain.

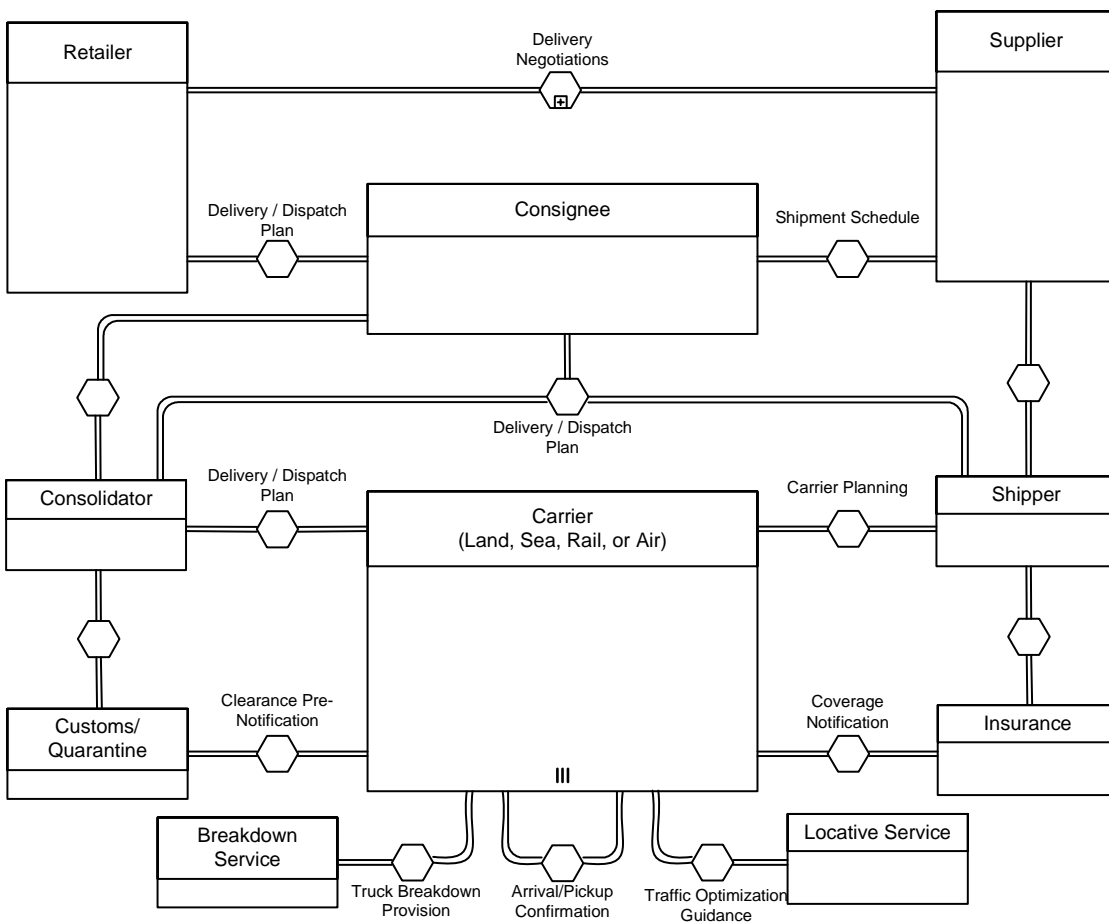

Figure 7.5 – An example of a Conversation diagram

Diagram Point of View

Since a **BPMN** Diagram MAY depict the **Processes** of different Participants, each Participant could view the Diagram differently. That is, the Participants have different points of view regarding how the **Processes** will apply to them. Some of the **Activities** will be internal to the Participant (meaning performed by or under control of the Participant) and other **Activities** will be external to the Participant. Each Participant will have a different perspective as to which are internal and external. At runtime, the difference between internal and external **Activities** is important in how a Participant can

view the status of the **Activities** or troubleshoot any problems. However, the Diagram itself remains the same. Figure 7.3 displays a **Business Process** that has two points of view. One point of view is of a Patient, the other is of the Doctor's office. The Diagram shows the **Activities** of both participants in the **Process**, but when the **Process** is actually being performed, each Participant will only have control over their own **Activities**. Although the Diagram point of view is important for a viewer of the Diagram to understand how the behavior of the **Process** will relate to that viewer, **BPMN** will not currently specify any graphical mechanisms to highlight the point of view. It is open to the modeler or modeling tool vendor to provide any visual cues to emphasize this characteristic of a Diagram.

Understanding the Behavior of Diagrams

Throughout this International Standard, we discuss how **Sequence Flows** are used within a **Process**. To facilitate this discussion, we employ the concept of a *token* that will traverse the **Sequence Flows** and pass through the elements in the **Process**. A *token* is a theoretical concept that is used as an aid to define the behavior of a **Process** that is being performed. The behavior of **Process** elements can be defined by describing how they interact with a *token* as it "traverses" the structure of the **Process**. However, modeling and execution tools that implement **BPMN** are NOT REQUIRED to implement any form of *token*.

A **Start Event** generates a *token* that MUST eventually be consumed at an **End Event** (which MAY be implicit if not graphically displayed). The path of *tokens* should be traceable through the network of **Sequence Flows**, **Gateways**, and **Activities** within a **Process**.

NOTE: A *token* does not traverse a **Message Flow** since it is a **Message** that is passed down a **Message Flow** (as the name implies).

7.3 BPMN Elements

It should be emphasized that one of the drivers for the development of **BPMN** is to create a simple and understandable mechanism for creating **Business Process** models, while at the same time being able to handle the complexity inherent to **Business Processes**. The approach taken to handle these two conflicting requirements was to organize the graphical aspects of the notation into specific categories. This provides a small set of notation categories so that the reader of a **BPMN** diagram can easily recognize the basic types of elements and understand the diagram. Within the basic categories of elements, additional variation and information can be added to support the requirements for complexity without dramatically changing the basic look and feel of the diagram. The five basic categories of elements are:

1. Flow Objects
2. Data
3. Connecting Objects
4. Swimlanes
5. Artifacts

Flow Objects are the main graphical elements to define the behavior of a **Business Process**. There are three *Flow Objects*:

1. Events
2. Activities
3. Gateways

Data is represented with the four elements:

1. Data Objects
2. Data Inputs
3. Data Outputs
4. Data Stores

There are four ways of connecting the Flow Objects to each other or other information. There are four Connecting Objects:

1. Sequence Flows
2. Message Flows
3. Associations
4. Data Associations

There are two ways of grouping the primary modeling elements through “Swimlanes:”

1. Pools
2. Lanes

Artifacts are used to provide additional information about the **Process**. There are two standardized Artifacts, but modelers or modeling tools are free to add as many Artifacts as necessary. There could be additional **BPMN** efforts to standardize a larger set of Artifacts for general use or for vertical markets. The current set of Artifacts includes:

- Group
- Text Annotation

7.3.1 Basic BPMN Modeling Elements

Table 7.1 displays a list of the basic modeling elements that are depicted by the notation.

Table 7.1 – Basic Modeling Elements



Element	Description	Notation
Event	An Event is something that “happens” during the course of a Process (see page 237) or a Choreography (see page 339). These Events affect the flow of the model and usually have a cause (<i>trigger</i>) or an impact (<i>result</i>). Events are circles with open centers to allow internal markers to differentiate different <i>triggers</i> or <i>results</i> . There are three types of Events, based on when they affect the flow: Start, Intermediate, and End.	
Activity	An Activity is a generic term for work that company performs (see page 149) in a Process. An Activity can be atomic or non-atomic (compound). The types of Activities that are a part of a Process Model are: Sub-Process and Task, which are rounded rectangles. Activities are used in both standard Processes and in Choreographies.	

Table 7.1 – Basic Modeling Elements





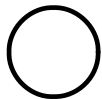

Gateway	A Gateway is used to control the divergence and convergence of Sequence Flows in a Process (see page 143) and in a Choreography (see page 344). Thus, it will determine branching, forking, merging, and joining of paths. Internal markers will indicate the type of behavior control.	
Sequence Flow	A Sequence Flow is used to show the order that Activities will be performed in a Process (see page 95) and in a Choreography (see page 320).	
Message Flow	A Message Flow is used to show the flow of Messages between two <i>Participants</i> that are prepared to send and receive them (see page 119). In BPMN, two separate Pools in a Collaboration Diagram will represent the two <i>Participants</i> (e.g., PartnerEntities and/or PartnerRoles).	
Association	An Association is used to link information and Artifacts with BPMN graphical elements (see page 65). Text Annotations (see page 69) and other Artifacts (see page 64) can be Associated with the graphical elements. An arrowhead on the Association indicates a direction of flow (e.g., data), when appropriate.	
Pool	A Pool is the graphical representation of a <i>Participant</i> in a Collaboration (see page 111). It also acts as a “swimlane” and a graphical container for partitioning a set of Activities from other Pools, usually in the context of B2B situations. A Pool MAY have internal details, in the form of the Process that will be executed. Or a Pool MAY have no internal details, i.e., it can be a “black box.”	
Lane	A Lane is a sub-partition within a Process, sometimes within a Pool, and will extend the entire length of the Process, either vertically or horizontally (see on page 304). Lanes are used to organize and categorize Activities.	
Data Object	Data Objects provide information about what Activities require to be performed and/or what they produce (see page 204), Data Objects can represent a singular object or a collection of objects. Data Input and Data Output provide the same information for Processes.	
Message	A Message is used to depict the contents of a communication between two <i>Participants</i> (as defined by a business PartnerRole or a business PartnerEntity—see on page 91).	

Table 7.1 – Basic Modeling Elements

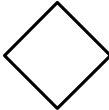
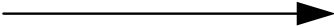
<p>Group (a box around a group of objects within the same category)</p>	<p>A Group is a grouping of graphical elements that are within the same Category (see page 68). This type of grouping does not affect the Sequence Flows within the Group. The Category name appears on the diagram as the group label. Categories can be used for documentation or analysis purposes. Groups are one way in which Categories of objects can be visually displayed on the diagram.</p>	
<p>Text Annotation (attached with an Association)</p>	<p>Text Annotations are a mechanism for a modeler to provide additional text information for the reader of a BPMN Diagram (see page 69).</p>	

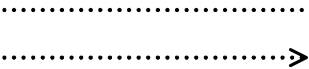
7.3.2 Extended BPMN Modeling Elements

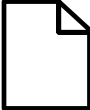
Table 7.2 displays a more extensive list of the **Business Process** concepts that could be depicted through a business process modeling notation.

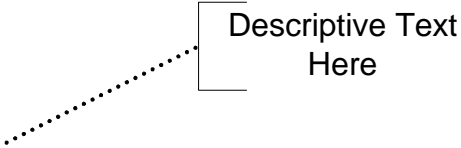
Table 7.2 – BPMN Extended Modeling Elements

Element	Description	Notation
<p>Event</p>	<p>An Event is something that “happens” during the course of a Process (see page 237) or a Choreography (see page 339). These Events affect the flow of the model and usually have a cause (<i>Trigger</i>) or an impact (<i>Result</i>). Events are circles with open centers to allow internal markers to differentiate different <i>Triggers</i> or <i>Results</i>. There are three types of Events, based on when they affect the flow: Start, Intermediate, and End.</p>	
<p>Flow Dimension (e.g., Start, Intermediate, End)</p>		

Table 7.2 – BPMN Extended Modeling Elements



<p>Start</p> <p>Intermediate</p> <p>End</p>	<p>As the name implies, the Start Event indicates where a particular Process (see page 237) or Choreography (see page 339) will start.</p> <p>Intermediate Events occur between a Start Event and an End Event. They will affect the flow of the Process (see page 248) or Choreography (see page 340), but will not start or (directly) terminate the Process.</p> <p>As the name implies, the End Event indicates where a Process (see page 245) or Choreography (see page 343) will end.</p>	<p>Start</p>  <p>Intermediate</p>  <p>End</p> 																																																				
<p>Type Dimension (e.g., None, Message, Timer, Error, Cancel, Compensation, Conditional, Link, Signal, Multiple, Terminate.)</p>	<p>The Start and some Intermediate Events have “triggers” that define the cause for the Event (see section entitled “Start Event” on page 237 and section entitled “Intermediate Event” on page 248). There are multiple ways that these events can be triggered. End Events MAY define a “result” that is a consequence of a Sequence Flow path ending. Start Events can only react to (“catch”) a <i>trigger</i>. End Events can only create (“throw”) a <i>result</i>. Intermediate Events can catch or throw <i>triggers</i>. For the Events, <i>triggers</i> that catch, the markers are unfilled, and for <i>triggers</i> and <i>results</i> that throw, the markers are filled.</p> <p>Additionally, some Events, which were used to interrupt Activities in BPMN 1.1, can now be used in a mode that does not interrupt. The boundary of these Events is dashed (see figure to the right).</p>	<table border="0"> <thead> <tr> <th></th> <th>“Catching”</th> <th>“Throwing”</th> <th>Non-Interrupting</th> </tr> </thead> <tbody> <tr> <td>Message</td> <td></td> <td></td> <td></td> </tr> <tr> <td>Timer</td> <td></td> <td></td> <td></td> </tr> <tr> <td>Error</td> <td></td> <td></td> <td></td> </tr> <tr> <td>Escalation</td> <td></td> <td></td> <td></td> </tr> <tr> <td>Cancel</td> <td></td> <td></td> <td></td> </tr> <tr> <td>Compensation</td> <td></td> <td></td> <td></td> </tr> <tr> <td>Conditional</td> <td></td> <td></td> <td></td> </tr> <tr> <td>Link</td> <td></td> <td></td> <td></td> </tr> <tr> <td>Signal</td> <td></td> <td></td> <td></td> </tr> <tr> <td>Terminate</td> <td></td> <td></td> <td></td> </tr> <tr> <td>Multiple</td> <td></td> <td></td> <td></td> </tr> <tr> <td>Parallel Multiple</td> <td></td> <td></td> <td></td> </tr> </tbody> </table>		“Catching”	“Throwing”	Non-Interrupting	Message				Timer				Error				Escalation				Cancel				Compensation				Conditional				Link				Signal				Terminate				Multiple				Parallel Multiple			
	“Catching”	“Throwing”	Non-Interrupting																																																			
Message																																																						
Timer																																																						
Error																																																						
Escalation																																																						
Cancel																																																						
Compensation																																																						
Conditional																																																						
Link																																																						
Signal																																																						
Terminate																																																						
Multiple																																																						
Parallel Multiple																																																						

Table 7.2 – BPMN Extended Modeling Elements

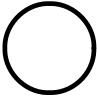
<p>Activity</p>	<p>An Activity is a generic term for work that company performs (see page 149) in a Process. An Activity can be atomic or non-atomic (compound). The types of Activities that are a part of a Process Model are: Sub-Process and Task, which are rounded rectangles. Activities are used in both standard Processes and in Choreographies.</p>	
<p>Task (Atomic)</p>	<p>A Task is an atomic Activity that is included within a Process (see page 154). A Task is used when the work in the Process is not broken down to a finer level of Process detail.</p>	
<p>Choreography Task</p>	<p>A Choreography Task is an atomic Activity in a Choreography (see page 323). It represents a set of one (1) or more Message exchanges. Each Choreography Task involves two (2) <i>Participants</i>. The name of the Choreography Task and each of the <i>Participants</i> are all displayed in the different bands that make up the shape's graphical notation. There are two (2) or more <i>Participant Bands</i> and one Task Name Band.</p>	
<p>Process/Sub-Process (non-atomic)</p>	<p>A Sub-Process is a compound Activity that is included within a Process (see page 171) or Choreography (see page 328). It is compound in that it can be broken down into a finer level of detail (a Process or Choreography) through a set of sub-Activities.</p>	<p>See Next Four Figures</p>
<p>Collapsed Sub-Process</p>	<p>The details of the Sub-Process are not visible in the Diagram (see page 171). A “plus” sign in the lower-center of the shape indicates that the Activity is a Sub-Process and has a lower-level of detail.</p>	
<p>Expanded Sub-Process</p>	<p>The boundary of the Sub-Process is expanded and the details (a Process) are visible within its boundary (see page 171). Note that Sequence Flows cannot cross the boundary of a Sub-Process.</p>	

Table 7.2 – BPMN Extended Modeling Elements

<p>Collapsed Sub-Choreography</p>	<p>The details of the Sub-Choreography are not visible in the Diagram (see page 328). A “plus” sign in the lower-center of the Task Name Band of the shape indicates that the Activity is a Sub-Process and has a lower-level of detail.</p>	
<p>Expanded Sub-Choreography</p>	<p>The boundary of the Sub-Choreography is expanded and the details (a Choreography) are visible within its boundary (see page 328).</p> <p>Note that Sequence Flows cannot cross the boundary of a Sub-Choreography.</p>	
<p>Gateway</p>	<p>A Gateway is used to control the divergence and convergence of Sequence Flows in a Process (see page 286) and in a Choreography (see page 344). Thus, it will determine branching, forking, merging, and joining of paths. Internal markers will indicate the type of behavior control (see below).</p>	

Table 7.2 – BPMN Extended Modeling Elements



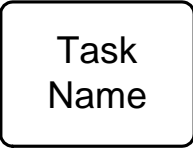
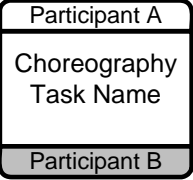
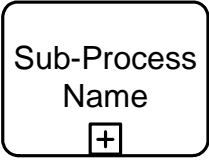
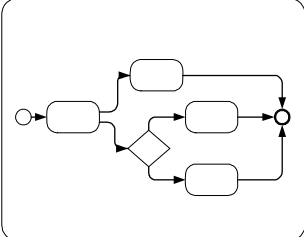



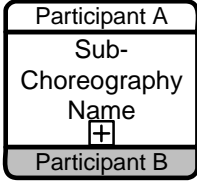
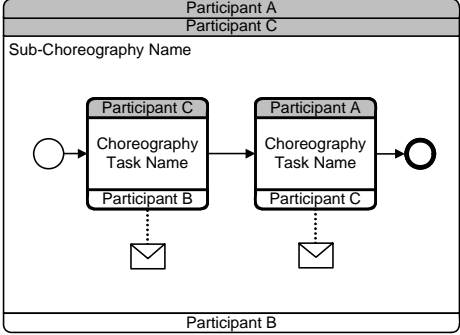
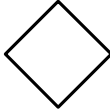

<p>Gateway Control Types</p>	<p>Icons within the diamond shape of the Gateway will indicate the type of flow control behavior. The types of control include:</p> <ul style="list-style-type: none"> • Exclusive decision and merging. Both Exclusive (see page 289) and Event-Based (see page 296) perform exclusive decisions and merging Exclusive can be shown with or without the "X" marker. • Event-Based and Parallel Event-based gateways can start a new instance of the Process. • Inclusive Gateway decision and merging (see page 291). • Complex Gateway -- complex conditions and situations (e.g., 3 out of 5; page 294). • Parallel Gateway forking and joining (see page 292). <p>Each type of control affects both the incoming and outgoing flow.</p>	<p>Exclusive  or </p> <p>Event-Based  </p> <p>Parallel Event-Based </p> <p>Inclusive </p> <p>Complex </p> <p>Parallel </p>
<p>Sequence Flow</p>	<p>A Sequence Flow is used to show the order that Activities will be performed in a Process (see page 95) and in a Choreography (see page 320).</p>	<p>See next seven figures</p>
<p>Normal Flow</p>	<p><i>Normal flow</i> refers to paths of Sequence Flow that do not start from an Intermediate Event attached to the boundary of an Activity.</p>	
<p>Uncontrolled flow</p>	<p><i>Uncontrolled flow</i> refers to flow that is not affected by any conditions or does not pass through a Gateway. The simplest example of this is a single Sequence Flow connecting two Activities. This can also apply to multiple Sequence Flows that converge to or diverge from an Activity. For each uncontrolled Sequence Flows a <i>token</i> will flow from the source object through the Sequence Flows to the target object.</p>	

Table 7.2 – BPMN Extended Modeling Elements

<p>Conditional flow</p>	<p>A Sequence Flow can have a condition Expression that are evaluated at runtime to determine whether or not the Sequence Flow will be used (i.e., will a <i>token</i> travel down the Sequence Flow – see page 95). If the <i>conditional flow</i> is outgoing from an Activity, then the Sequence Flow will have a mini-diamond at the beginning of the connector (see figure to the right). If the <i>conditional flow</i> is outgoing from a Gateway, then the line will not have a mini-diamond (see figure in the row above).</p>	
<p>Default flow</p>	<p>For Data-Based Exclusive Gateways or Inclusive Gateways, one type of flow is the Default <i>condition flow</i> (see page 95). This flow will be used only if all the other outgoing <i>conditional flow</i> is not <i>true</i> at runtime. These Sequence Flows will have a diagonal slash at the beginning of the connector (see the figure to the right).</p>	
<p>Exception Flow</p>	<p><i>Exception flow</i> occurs outside the <i>normal flow</i> of the Process and is based upon an Intermediate Event attached to the boundary of an Activity that occurs during the performance of the Process (see page 286).</p>	
<p>Message Flow</p>	<p>A Message Flow is used to show the flow of Messages between two <i>Participants</i> that are prepared to send and receive them (see page 119). In BPMN, two separate Pools in a Collaboration Diagram will represent the two <i>Participants</i> (e.g., <i>PartnerEntities</i> and/or <i>PartnerRoles</i>).</p>	
<p>Compensation Association</p>	<p><i>Compensation Association</i> occurs outside the <i>normal flow</i> of the Process and is based upon a Compensation Intermediate Event that is triggered through the failure of a <i>transaction</i> or a <i>throw Compensation Event</i> (see page 301). The target of the Association MUST be marked as a Compensation Activity.</p>	

Table 7.2 – BPMN Extended Modeling Elements

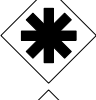
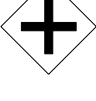
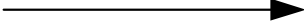

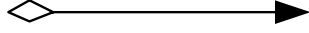
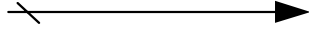
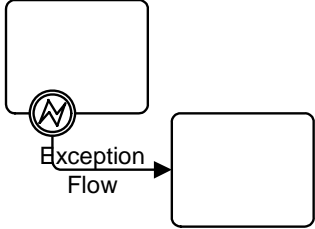
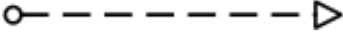
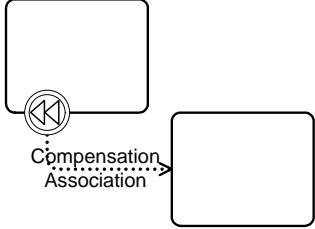

<p>Data Object</p>	<p>Data Objects provide information about what Activities require to be performed and/or what they produce (see page 204), Data Objects can represent a singular object or a collection of objects. Data Input and Data Output provide the same information for Processes.</p>	<p>Data Object</p>  <p>Data Object (Collection)</p>  <p>Data Input Data Output</p>  
<p>Message</p>	<p>A Message is used to depict the contents of a communication between two <i>Participants</i> (as defined by a business <i>PartnerRole</i> or a business <i>PartnerEntity</i>—see on page 91).</p>	
<p>Fork</p>	<p>BPMN uses the term “fork” to refer to the dividing of a path into two or more parallel paths (also known as an AND-Split). It is a place in the Process where activities can be performed concurrently, rather than sequentially.</p> <p>There are two options:</p> <ul style="list-style-type: none"> • Multiple Outgoing Sequence Flows can be used (see figure top-right). This represents “uncontrolled” flow is the preferred method for most situations. • A Parallel Gateway can be used (see figure bottom-right). This will be used rarely, usually in combination with other Gateways. 	

Table 7.2 – BPMN Extended Modeling Elements

<p>Join</p>	<p>BPMN uses the term “join” to refer to the combining of two or more parallel paths into one path (also known as an AND-Join or synchronization).</p> <p>A Parallel Gateway is used to show the joining of multiple Sequence Flows.</p>	
<p>Decision, Branching Point</p>	<p>Decisions are Gateways within a Process (see page 286) or a Choreography (see page 344) where the flow of control can take one or more alternative paths.</p>	<p>See next five rows.</p>
<p>Exclusive</p>	<p>This Decision represents a branching point where Alternatives are based on conditional Expressions contained within the <i>outgoing</i> Sequence Flows (see page 289 or page 344). Only one of the Alternatives will be chosen.</p>	
<p>Event-Based</p>	<p>This Decision represents a branching point where Alternatives are based on an Event that occurs at that point in the Process (see page 296) or Choreography (see page 349). The specific Event, usually the receipt of a Message, determines which of the paths will be taken. Other types of Events can be used, such as Timer. Only one of the Alternatives will be chosen.</p> <p>There are two options for receiving Messages:</p> <ul style="list-style-type: none"> • Tasks of Type Receive can be used (see figure top-right). • Intermediate Events of Type Message can be used (see figure bottom-right). 	

Table 7.2 – BPMN Extended Modeling Elements

<p>Inclusive</p>	<p>This Decision represents a branching point where Alternatives are based on conditional Expressions contained within the outgoing Sequence Flows (see page 291). In some sense it is a grouping of related independent Binary (Yes/No) Decisions. Since each path is independent, all combinations of the paths MAY be taken, from zero to all. However, it should be designed so that at least one path is taken. A Default Condition could be used to ensure that at least one path is taken.</p> <p>There are two versions of this type of Decision:</p> <ul style="list-style-type: none"> • The first uses a collection of conditional Sequence Flows, marked with mini-diamonds (see top-right figure). • The second uses an Inclusive Gateway (see bottom-right picture). 	
<p>Merging</p>	<p>BPMN uses the term “merge” to refer to the exclusive combining of two or more paths into one path (also known as an OR-Join). A Merging Exclusive Gateway is used to show the merging of multiple Sequence Flows (see upper figure to the right). If all the incoming flow is alternative, then a Gateway is not needed. That is, uncontrolled flow provides the same behavior (see lower figure to the right).</p>	
<p>Looping</p>	<p>BPMN provides two mechanisms for looping within a Process.</p>	<p>See Next Two Figures</p>
<p>Activity Looping</p>	<p>The attributes of Tasks and Sub-Processes will determine if they are repeated or performed once (see page 189). There are two types of loops: Standard and Multi-Instance. A small looping indicator will be displayed at the bottom-center of the activity.</p>	

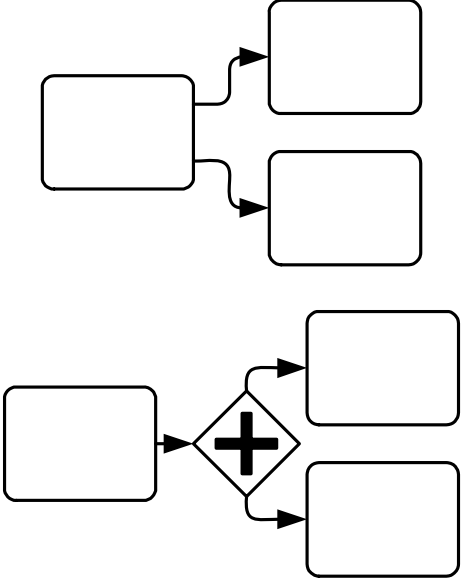
Table 7.2 – BPMN Extended Modeling Elements

<p>Sequence Flow Looping</p>	<p>Loops can be created by connecting a Sequence Flow to an “upstream” object. An object is considered to be upstream if that object has an outgoing Sequence Flow that leads to a series of other Sequence Flows, the last of which is an incoming Sequence Flow for the original object.</p>	
<p>Multiple Instances</p>	<p>The attributes of Tasks and Sub-Processes will determine if they are repeated or performed once (see page 190). A set of three horizontal lines will be displayed at the bottom-center of the activity for sequential Multi-Instances (see upper figure to the right). A set of three vertical lines will be displayed at the bottom-center of the activity for sequential Multi-Instances (see lower figure to the right).</p>	<p style="text-align: center;">Sequential</p>  <p style="text-align: center;">Parallel</p> 
<p>Process Break (something out of the control of the process makes the process pause)</p>	<p>A Process Break is a location in the Process that shows where an expected delay will occur within a Process (see page 248). An Intermediate Event is used to show the actual behavior (see top-right figure). In addition, a Process Break Artifact, as designed by a modeler or modeling tool, can be associated with the Event to highlight the location of the delay within the flow.</p>	
<p>Transaction</p>	<p>A transaction is a Sub-Process that is supported by a special protocol that insures that all parties involved have complete agreement that the activity should be completed or canceled (see page 176). The attributes of the activity will determine if the activity is a transaction. A double-lined boundary indicates that the Sub-Process is a Transaction.</p>	

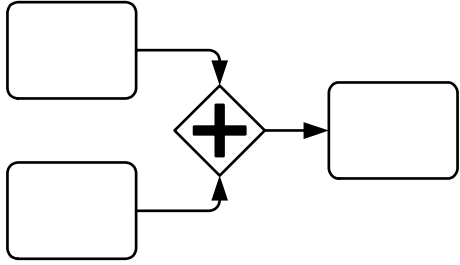
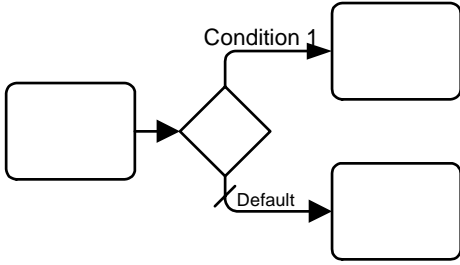
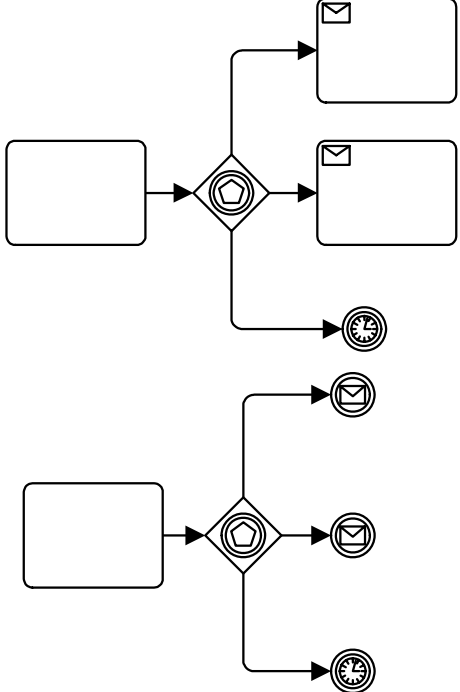
Table 7.2 – BPMN Extended Modeling Elements



<p>Nested/Embedded Sub-Process (Inline Block)</p>	<p>A nested (or embedded) Sub-Process is an activity that shares the same set of data as its parent process (see page 171). This is opposed to a Sub-Process that is independent, re-usable, and referenced from the parent process. Data needs to be passed to the referenced Sub-Process, but not to the nested Sub-Process.</p>	<p>There is no special indicator for nested Sub-Processes</p>
<p>Group (a box around a group of objects within the same category)</p>	<p>A Group is a grouping of graphical elements that are within the same <i>Category</i> (see page 66). This type of grouping does not affect the Sequence Flows within the Group. The <i>Category</i> name appears on the diagram as the group label. <i>Categories</i> can be used for documentation or analysis purposes. Groups are one way in which <i>Categories</i> of objects can be visually displayed on the diagram.</p>	
<p>Off-Page Connector</p>	<p>Generally used for printing, this object will show where a Sequence Flow leaves one page and then restarts on the next page. A Link Intermediate Event can be used as an Off-Page Connector.</p>	
<p>Association</p>	<p>An Association is used to link information and Artifacts with BPMN graphical elements (see page 65). Text Annotations (see page 69) and other Artifacts (see page 64) can be Associated with the graphical elements. An arrowhead on the Association indicates a direction of flow (e.g., data), when appropriate.</p>	
<p>Text Annotation (attached with an Association)</p>	<p>Text Annotations are a mechanism for a modeler to provide additional text information for the reader of a BPMN Diagram (see page 69).</p>	
<p>Pool</p>	<p>A Pool is the graphical representation of a <i>Participant</i> in a Collaboration (see page 111). It also acts as a “swimlane” and a graphical container for partitioning a set of Activities from other Pools, usually in the context of B2B situations. A Pool MAY have internal details, in the form of the Process that will be executed. Or a Pool MAY have no internal details, i.e., it can be a “black box.”</p>	

Table 7.2 – BPMN Extended Modeling Elements

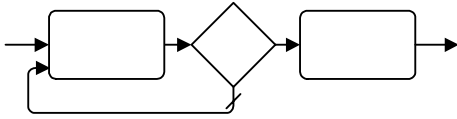
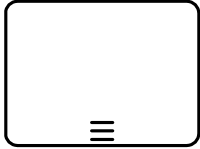
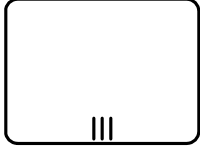
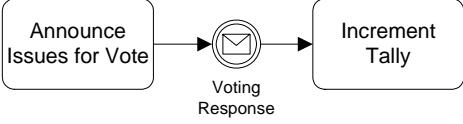
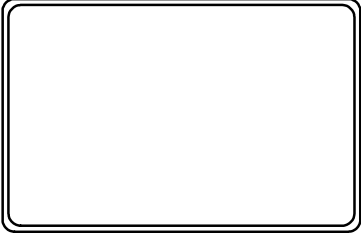
Lanes	A Lane is a sub-partition within a Pool and will extend the entire length of the Pool, either vertically or horizontally (see on page 304). Lanes are used to organize and categorize Activities.	
-------	---	--

7.4 BPMN Diagram Types

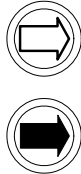
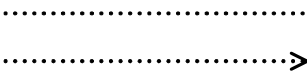
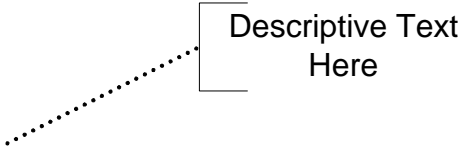
The **BPMN 2.0.1** aims to cover three basic models of **Processes**: *private Processes* (both *executable* and *non-executable*), *public Processes*, and **Choreographies**. Within and between these three **BPMN** sub-models, many types of Diagrams can be created. The following are examples of **Business Processes** that can be modeled using **BPMN 2.0.1**:

- High-level *non-executable* **Process Activities** (not functional breakdown).
- Detailed executable **Business Process**.
- As-is or old **Business Process**.
- To-be or new **Business Process**.
- A description of expected behavior between two (2) or more business *Participants*—a **Choreography**.
- Detailed *private* **Business Process** (either *executable* or *non-executable*) with interactions to one or more external *Entities* (or “Black Box” **Processes**).
- Two or more detailed *executable* **Processes** interacting.
- Detailed *executable* **Business Process** relationship to a **Choreography**.
- Two or more *public* **Processes**.
- *Public* **Process** relationship to **Choreography**.
- Two or more detailed *executable* **Business Processes** interacting through a **Choreography**.

BPMN is designed to allow describing all above examples of **Business Processes**. However, the ways that different sub-models are combined is left to tool vendors. A **BPMN 2.0.1** compliant implementation could RECOMMEND that modelers pick a focused purpose, such as a *private* **Process**, or **Choreographies**. However, the **BPMN 2.0.1** International Standard makes no assumptions.

7.5 Use of Text, Color, Size, and Lines in a Diagram

Text Annotation objects can be used by the modeler to display additional information about a **Process** or attributes of the objects within a **BPMN** Diagram.

- ◆ BPMN elements (e.g., Flow objects) MAY have labels (e.g., its name and/or other attributes) placed inside the shape, or above or below the shape, in any direction or location, depending on the preference of the modeler or modeling tool vendor.
- ◆ The fills that are used for the graphical elements MAY be white or clear.
 - ◆ The notation MAY be extended to use other fill colors to suit the purpose of the modeler or tool (e.g., to highlight the value of an object attribute). However,
 - ◆ the markers for “throwing” Events MUST have a dark fill (see “End Event” on page 245 and “Intermediate Event” on page 248 for more details).

- ◆ Participant Bands for Choreography Tasks and Sub-Choreographies that are *not* the initiator of the Activity **MUST** have a light fill (see “Choreography Task” on page 323 and “Sub-Choreography” on page 328 for more details).
- ◆ Flow objects and markers **MAY** be of any size that suits the purposes of the modeler or modeling tool.
- ◆ The lines that are used to draw the graphical elements **MAY** be black.
- ◆ The notation **MAY** be extended to use other line colors to suit the purpose of the modeler or tool (e.g., to highlight the value of an object attribute).
- ◆ The notation **MAY** be extended to use other line styles to suit the purpose of the modeler or tool (e.g., to highlight the value of an object attribute) with the condition that the line style **MUST NOT** conflict with any current BPMN defined line style. Thus, the line styles of Sequence Flows, Message Flows, and Text Associations **MUST NOT** be modified or duplicated.

7.6 Flow Object Connection Rules

An *incoming* **Sequence Flow** can connect to any location on a Flow Object (left, right, top, or bottom). Likewise, an *outgoing* **Sequence Flow** can connect from any location on a Flow Object (left, right, top, or bottom). A **Message Flow** also has this capability.

NOTE: **BPMN** allows this flexibility; however, we also **RECOMMEND** that modelers use judgment or best practices in how Flow Objects should be connected so that readers of the Diagrams will find the behavior clear and easy to follow. This is even more important when a Diagram contains **Sequence Flows** and **Message Flows**. In these situations it is best to pick a direction of **Sequence Flows**, either left to right or top to bottom, and then direct the **Message Flows** at a 90° angle to the **Sequence Flows**. The resulting Diagrams will be much easier to understand.

7.6.1 Sequence Flow Connections Rules

Table 7.3 displays the **BPMN** Flow Objects and shows how these objects can connect to one another through **Sequence Flows**. These rules apply to the connections within a **Process** Diagram and within a **Choreography** Diagram. The ↗ symbol indicates that the object listed in the row can connect to the object listed in the column. The quantity of connections into and out of an object is subject to various configuration dependencies are not specified here. Refer to the sub clauses in the next clause for each individual object for more detailed information on the appropriate connection rules. *Note that if a Sub-Process has been expanded within a Diagram, the objects within the Sub-Process cannot be connected to objects outside of the Sub-Process, nor can Sequence Flows cross a Pool boundary.*

Table 7.3 – Sequence Flow Connection Rules







From\To						
		‰	↗	↗	↗	↗

Table 7.3 – Sequence Flow Connection Rules

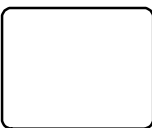
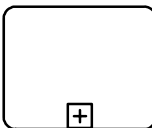
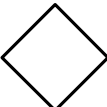



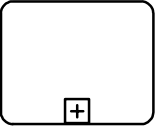
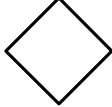





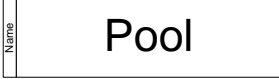

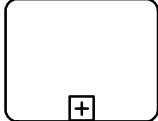













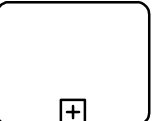



		‰	↗	↗	↗	↗
		‰	↗	↗	↗	↗
		‰	↗	↗	↗	↗
		‰	↗	↗	↗	↗
						

Only those objects that can have *incoming* and/or *outgoing* **Sequence Flows** are shown in the table. Thus, **Pool, Lane, Data Object, Group, and Text Annotation** are not listed in the table. Also, the **Activity** shapes in the table represent **Activities** and **Sub-Processes** for **Processes**, and **Choreography Activities** and **Sub-Choreographies** for **Choreography**.

7.6.2 Message Flow Connection Rules

Table 7.4 displays the **BPMN** modeling objects and shows how these objects can connect to one another through **Message Flows**. These rules apply to the connections within a **Collaboration Diagram**. The ↗ symbol indicates that the object listed in the row can connect to the object listed in the column. The quantity of connections into and out of an object is subject to various configuration dependencies that are not specified here. Refer to the sub clauses in the next clause for each individual object for more detailed information on the appropriate connection rules. *Note that Message Flows cannot connect to objects that are within the same Pool.*

Table 7.4– Message Flow Connection Rules

From\To						
						
	^					
	^					
	^					
	^					
	^					

Only those objects that can have *incoming* and/or *outgoing* **Message Flows** are shown in the table. Thus, **Lane**, **Gateway**, **Data Object**, **Group**, and **Text Annotation** are not listed in the table.

7.7 BPMN Extensibility

BPMN 2.0.1 introduces an extensibility mechanism that allows extending standard **BPMN** elements with additional attributes. It can be used by modelers and modeling tools to add non-standard elements or **Artifacts** to satisfy a specific need, such as the unique requirements of a vertical domain, and still have valid **BPMN Core**. Extension attributes **MUST NOT** contradict the semantics of any **BPMN** element. In addition, while extensible, **BPMN Diagrams** should still have the basic look-and-feel so that a Diagram by any modeler should be easily understood by any viewer of the Diagram. Thus the footprint of the basic flow elements (**Events**, **Activities**, and **Gateways**) **MUST NOT** be altered.

The International Standard differentiates between mandatory and optional extensions (sub clause 8.3.3 explains the syntax used to declare extensions). If a mandatory extension is used, a compliant implementation **MUST** understand the extension. If an optional extension is used, a compliant implementation **MAY** ignore the extension.

7.8 BPMN Example

The following is an example of a manufacturing process from different perspectives.

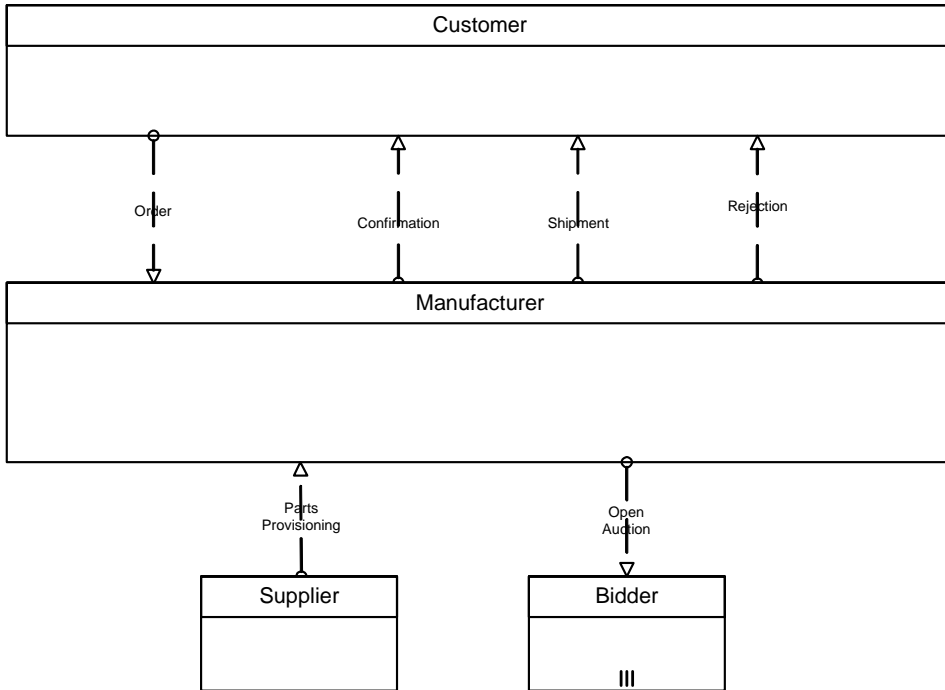

Figure 7.6 – An example of a Collaboration diagram with black-box Pools

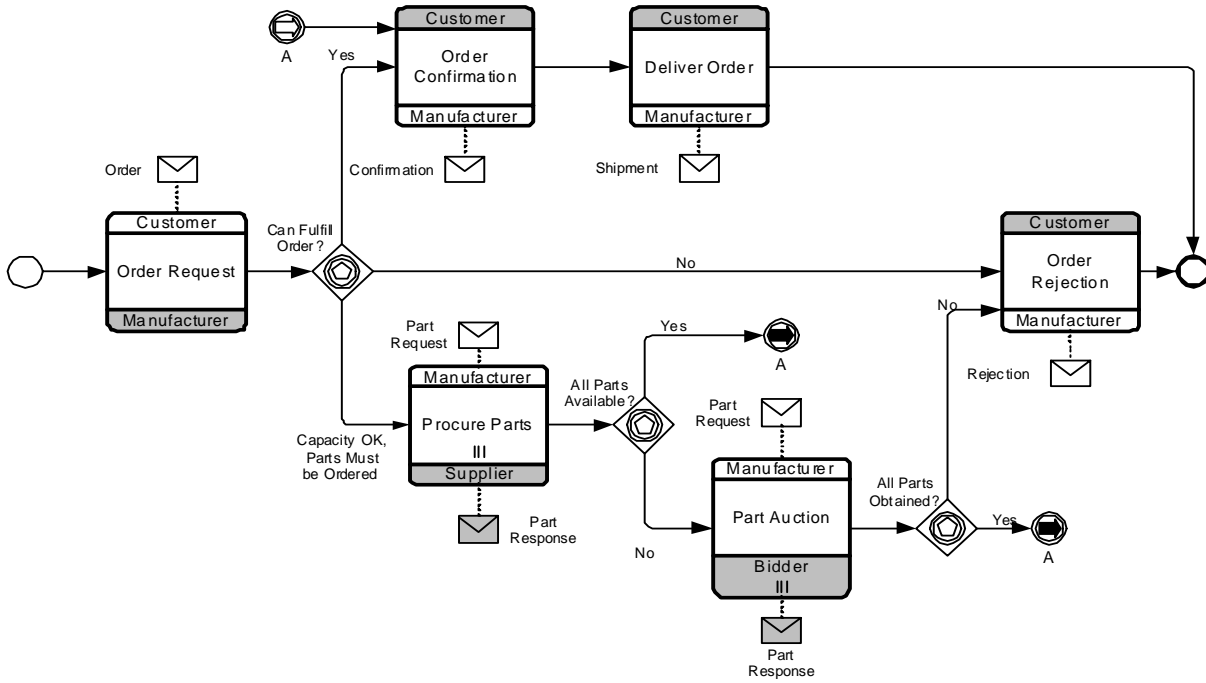

Figure 7.7 – An example of a stand-alone Choreography diagram

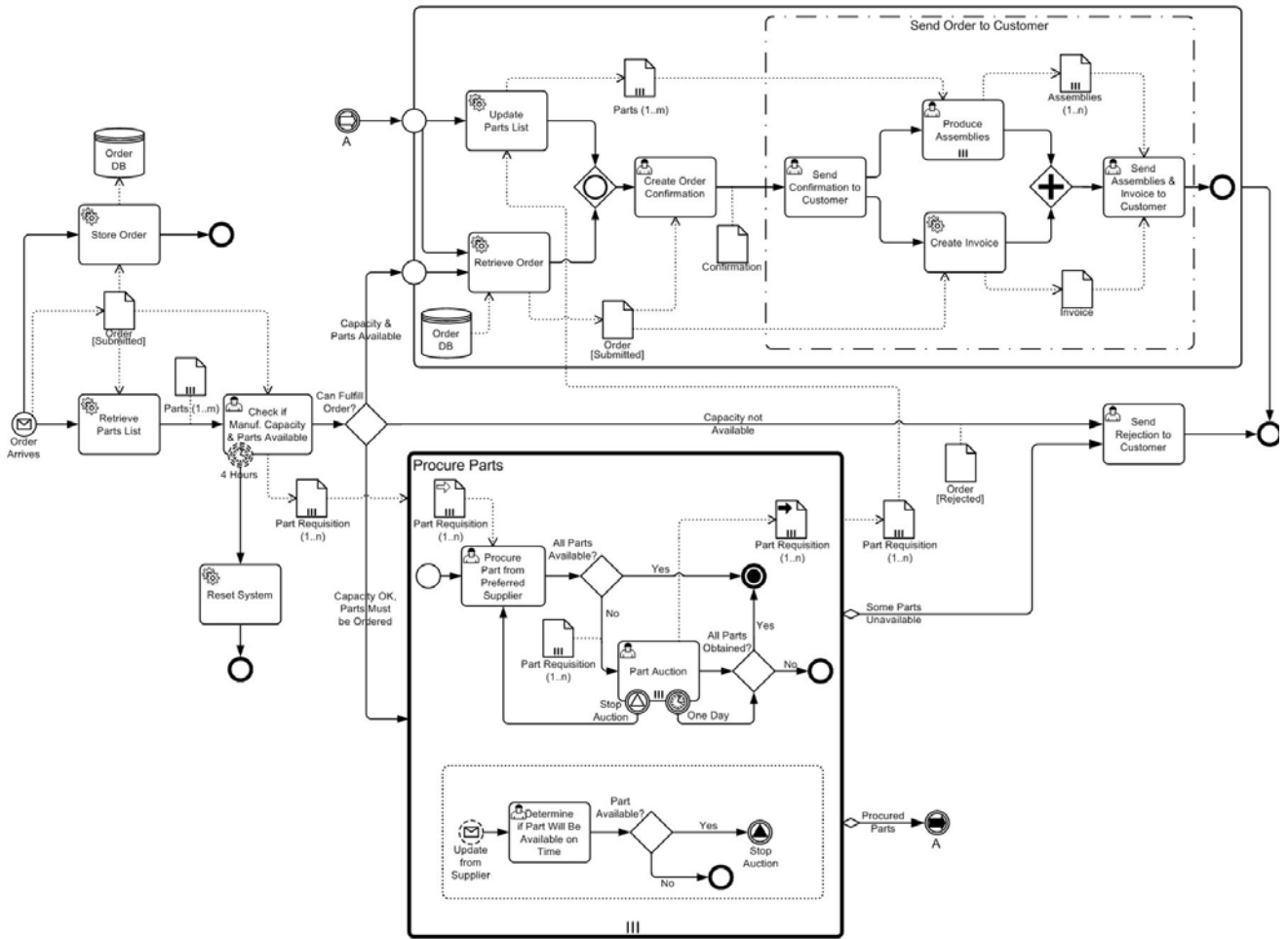

Figure 7.8 – An example of a stand-alone Process (Orchestration) diagram

8 BPMN Core Structure

8.1 General

NOTE: The content of this clause is REQUIRED for all **BPMN** conformance types. For more information about **BPMN** conformance types, see page 1.

The technical structuring of **BPMN** is based on the concept of extensibility layers on top of a basic series of simple elements identified as *Core Elements* of the International Standard. From this core set of constructs, layering is used to describe additional elements that extend and add new constructs to the International Standard and relies on clear dependency paths for resolution. The XML Schema model lends itself particularly well to the structuring model with formalized import and resolution mechanics that remove ambiguities in the definitions of elements in the outer layers of the International Standard.

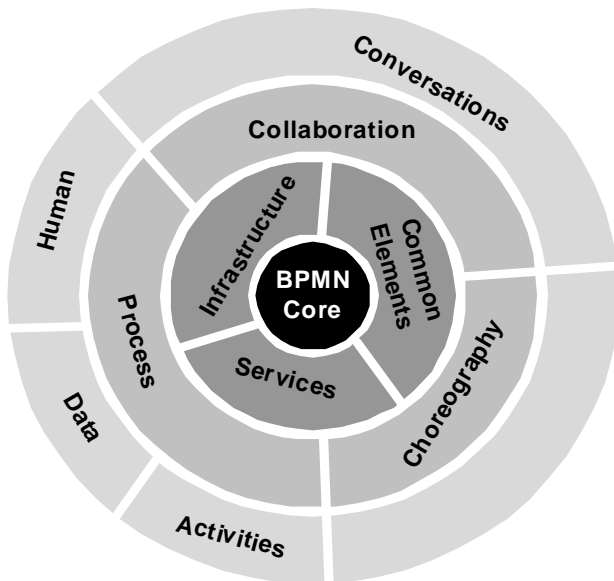

Figure 8.1 – A representation of the BPMN Core and Layer Structure

Figure 8.1 shows the basic principles of layering that can be composed in well defined ways. The approach uses formalization constructs for extensibility that are applied consistently to the definition.

The additional effect of layering is that compatibility layers can be built, allowing for different levels of compliance among vendors, and also enabling vendors to add their own layers in support of different vertical industries or target audiences. In addition, it provides a mechanism for the redefinition of previously existing concepts without affecting backwards compatibility, but defining two or more non-composable layers, the level of compliance with the International Standard and backwards compatibility can be achieved without compromising clarity.

The **BPMN** International Standard is structured in layers, where each layer builds on top of and extends lower layers. Included is a *Core* or kernel that includes the most fundamental elements of **BPMN**, which are **REQUIRED** for constructing **BPMN** diagrams: **Process**, **Choreography**, and **Collaboration**. The *Core* is intended to be simple, concise, and extendable with well defined behavior.

The *Core* contains four sub-packages (see Figure 8.2):

1. **Infrastructure**: Two elements that are used for both abstract syntax models and diagram models.
2. **Foundation**: The fundamental constructs needed for **BPMN** modeling.
3. **Service**: The fundamental constructs needed for modeling services and interfaces.
4. **Common**: Those classes which are common to the layers of **Process**, **Choreography**, and **Collaboration**.

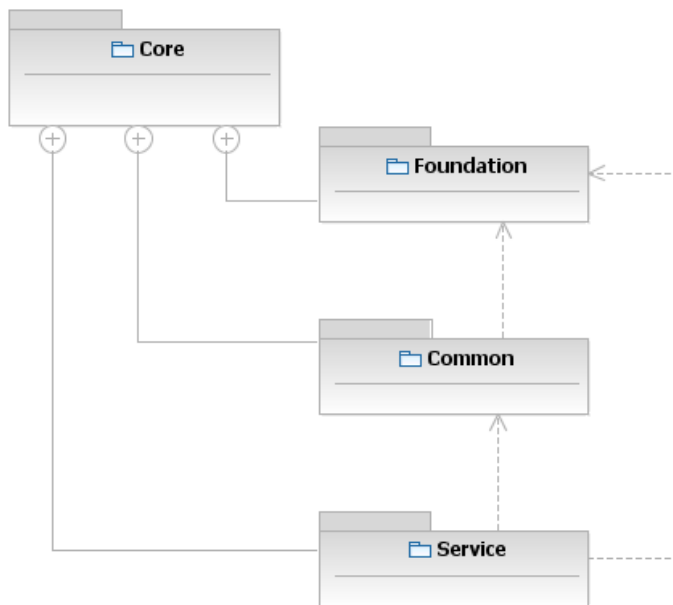

Figure 8.2 – Class diagram showing the core packages

NOTE: To simplify the diagram, the Infrastructure package is not shown in Figure 8.2.

Figure 8.3 displays the organization of the main set of BPMN core model elements.

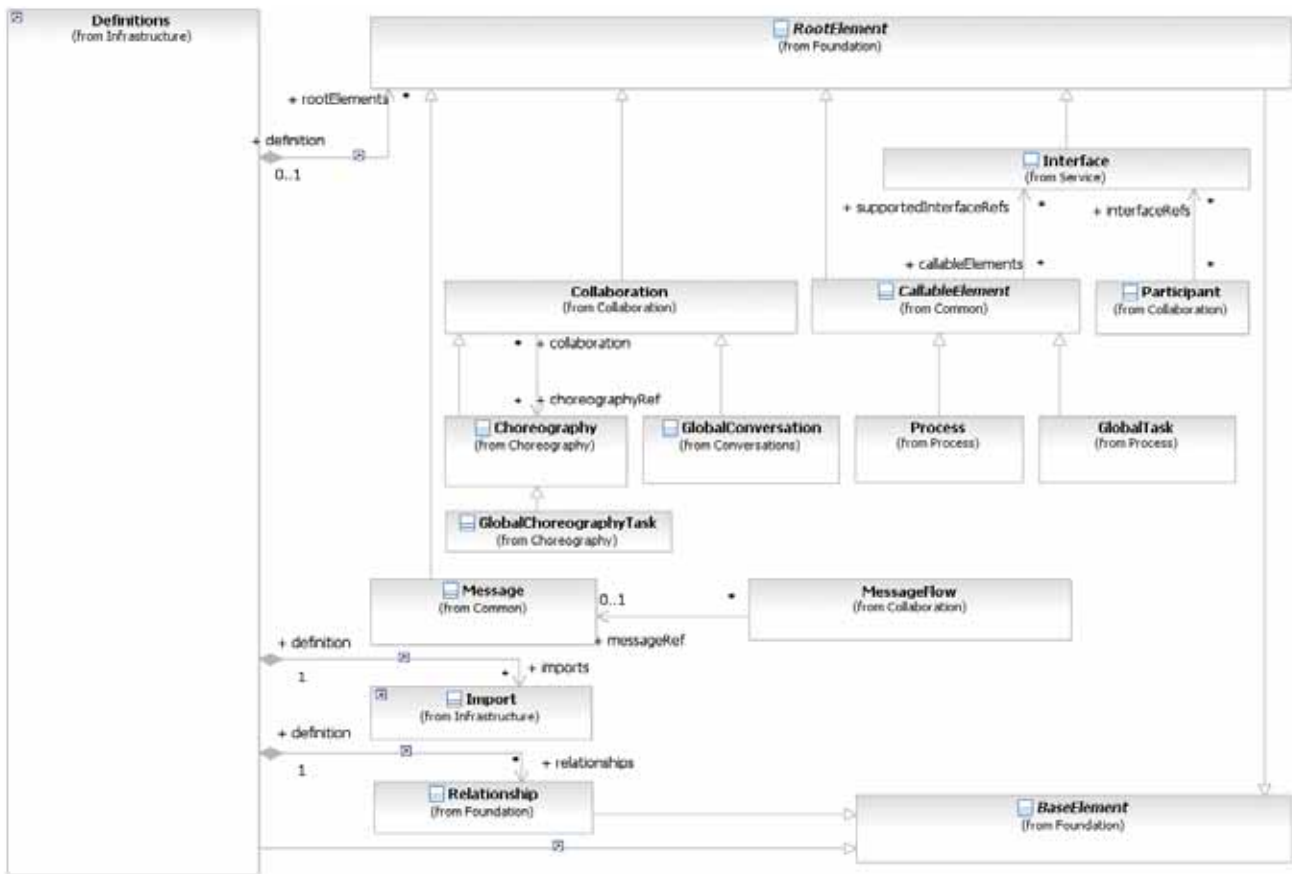

Figure 8.3 – Class diagram showing the organization of the core BPMN elements

8.2 Infrastructure

The BPMN Infrastructure package contains two elements that are used for both abstract syntax models and diagram models.

8.2.1 Definitions

The Definitions class is the outermost containing object for all BPMN elements. It defines the scope of visibility and the namespace for all contained elements. The interchange of BPMN files will always be through one or more Definitions.

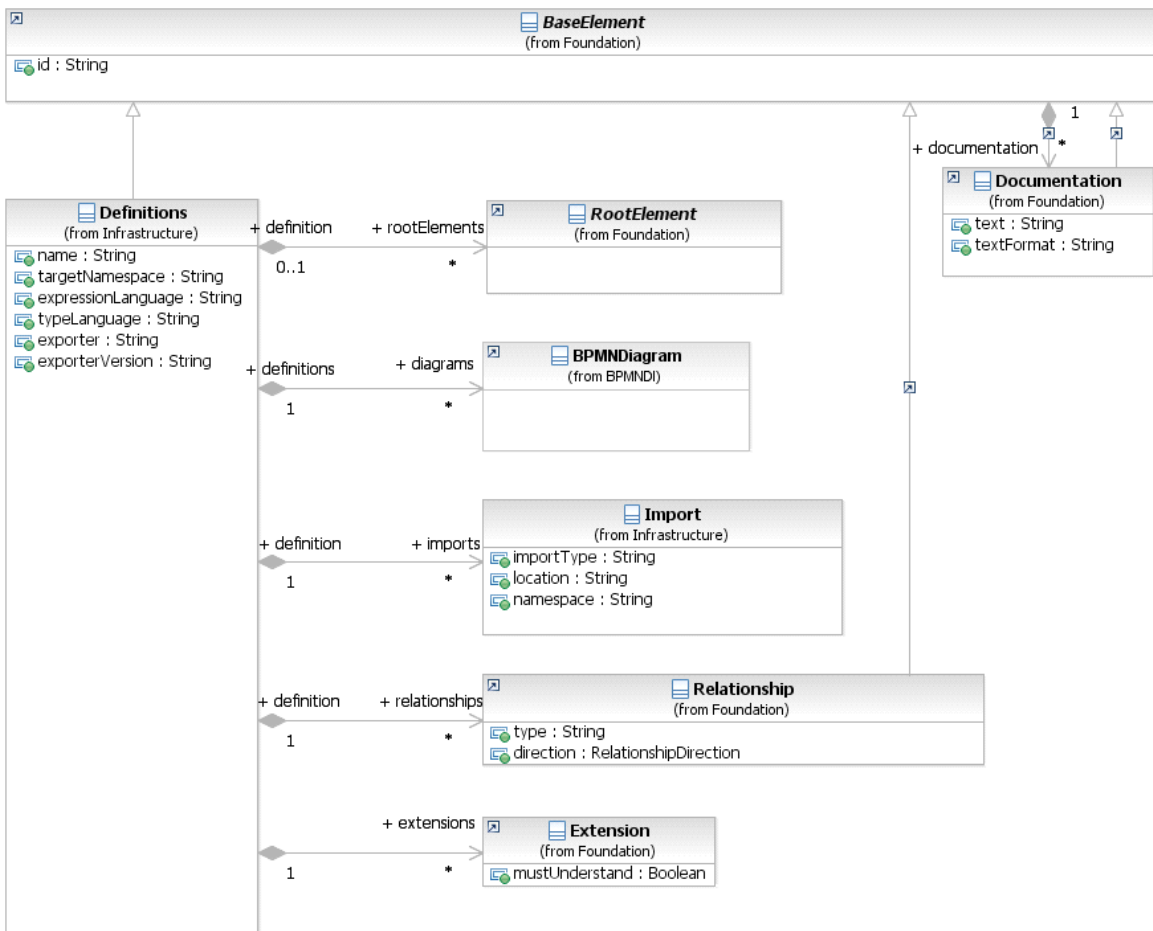

Figure 8.4 – Definitions class diagram

The Definitions element inherits the attributes and model associations of BaseElement (see Table 8.5). Table 8.1 presents the additional attributes and model associations of the Definitions element.

Table 8.1 – Definitions attributes and model association

Attribute Name	Description/Usage
name: string	The name of the Definition.
targetNamespace: string	This attribute identifies the namespace associated with the Definition and follows the convention established by XML Schema.
expressionLanguage: string [0..1]	This attribute identifies the formal Expression language used in Expressions within the elements of this Definition. The Default is “http://www.w3.org/1999/XPath”. This value MAY be overridden on each individual formal Expression. The language MUST be specified in a URI format.

Table 8.1 – Definitions attributes and model association

typeLanguage: string [0..1]	This attribute identifies the type system used by the elements of this Definition. Defaults to http://www.w3.org/2001/XMLSchema . This value can be overridden on each individual ItemDefinition. The language MUST be specified in a URI format.
rootElements: RootElement [0..*]	This attribute lists the root elements that are at the root of this Definitions. These elements can be referenced within this Definitions and are visible to other Definitions.
diagrams: BPMNDiagram [0..*]	This attribute lists the BPMNDiagrams that are contained within this Definitions (see page 365 for more information on BPMNDiagrams).
imports: Import [0..*]	This attribute is used to import externally defined elements and make them available for use by elements within this Definitions.
extensions: Extension [0..*]	This attribute identifies extensions beyond the attributes and model associations in the base BPMN specification. See page 57 for additional information on extensibility.
relationships: Relationship [0..*]	This attribute enables the extension and integration of BPMN models into larger system/development Processes .
exporter: string [0..1]	This attribute identifies the tool that is exporting the bpmn model file.
exporterVersion: string [0..1]	This attribute identifies the version of the tool that is exporting the bpmn model file.

8.2.2 Import

The `Import` class is used when referencing external element, either **BPMN** elements contained in other **BPMN** Definitions or non-**BPMN** elements. `Imports` MUST be explicitly defined.

Table 8.2 presents the attributes of `Import`.

Table 8.2 – Import attributes

Attribute Name	Description/Usage
importType: string	Identifies the type of document being imported by providing an absolute URI that identifies the encoding language used in the document. The value of the importType attribute MUST be set to http://www.w3.org/2001/XMLSchema when importing XML Schema 1.0 documents, to http://www.w3.org/TR/wsdl20/ when importing WSDL 2.0 documents, and http://www.omg.org/spec/BPMN/20100524/MODEL when importing BPMN 2.0 documents. Other types of documents MAY be supported. Importing Xml Schema 1.0, WSDL 2.0 and BPMN 2.0 types MUST be supported.
location: string [0..1]	Identifies the location of the imported element.
namespace: string	Identifies the namespace of the imported element.

8.2.3 Infrastructure Package XML Schemas

Table 8.3 – Definitions XML schema

```

<xsd:element name="definitions" type="tDefinitions"/>
<xsd:complexType name="tDefinitions">
  <xsd:sequence>
    <xsd:element ref="import" minOccurs="0" maxOccurs="unbounded"/>
    <xsd:element ref="extension" minOccurs="0" maxOccurs="unbounded"/>
    <xsd:element ref="rootElement" minOccurs="0" maxOccurs="unbounded"/>
    <xsd:element ref="bpmndi:BPMNDiagram" minOccurs="0" maxOccurs="unbounded"/>
    <xsd:element ref="relationship" minOccurs="0" maxOccurs="unbounded"/>
  </xsd:sequence>
  <xsd:attribute name="id" type="xsd:ID" use="optional"/>
  <xsd:attribute name="targetNamespace" type="xsd:anyURI" use="required"/>
  <xsd:attribute name="expressionLanguage" type="xsd:anyURI" use="optional" default="http://
    www.w3.org/1999/XPath"/>
  <xsd:attribute name="typeLanguage" type="xsd:anyURI" use="optional" default="http://www.w3.org/
    2001/XMLSchema"/>
  <xsd:anyAttribute name="exporter" type="xsd:ID"/>
  <xsd:anyAttribute name="exporterVersion" type="xsd:ID"/>
  <xsd:anyAttribute namespace="##other" processContents="lax"/>
</xsd:complexType>

```

Table 8.4 – Import XML schema

```

<xsd:element name="import" type="tImport"/>
<xsd:complexType name="tImport">
  <xsd:attribute name="namespace" type="xsd:anyURI" use="required"/>
  <xsd:attribute name="location" type="xsd:string" use="required"/>
  <xsd:attribute name="importType" type="xsd:anyURI" use="required"/>
</xsd:complexType>

```

8.3 Foundation

The Foundation package contains classes that are shared among other packages in the Core (see Figure 8.5) of an abstract syntax model.

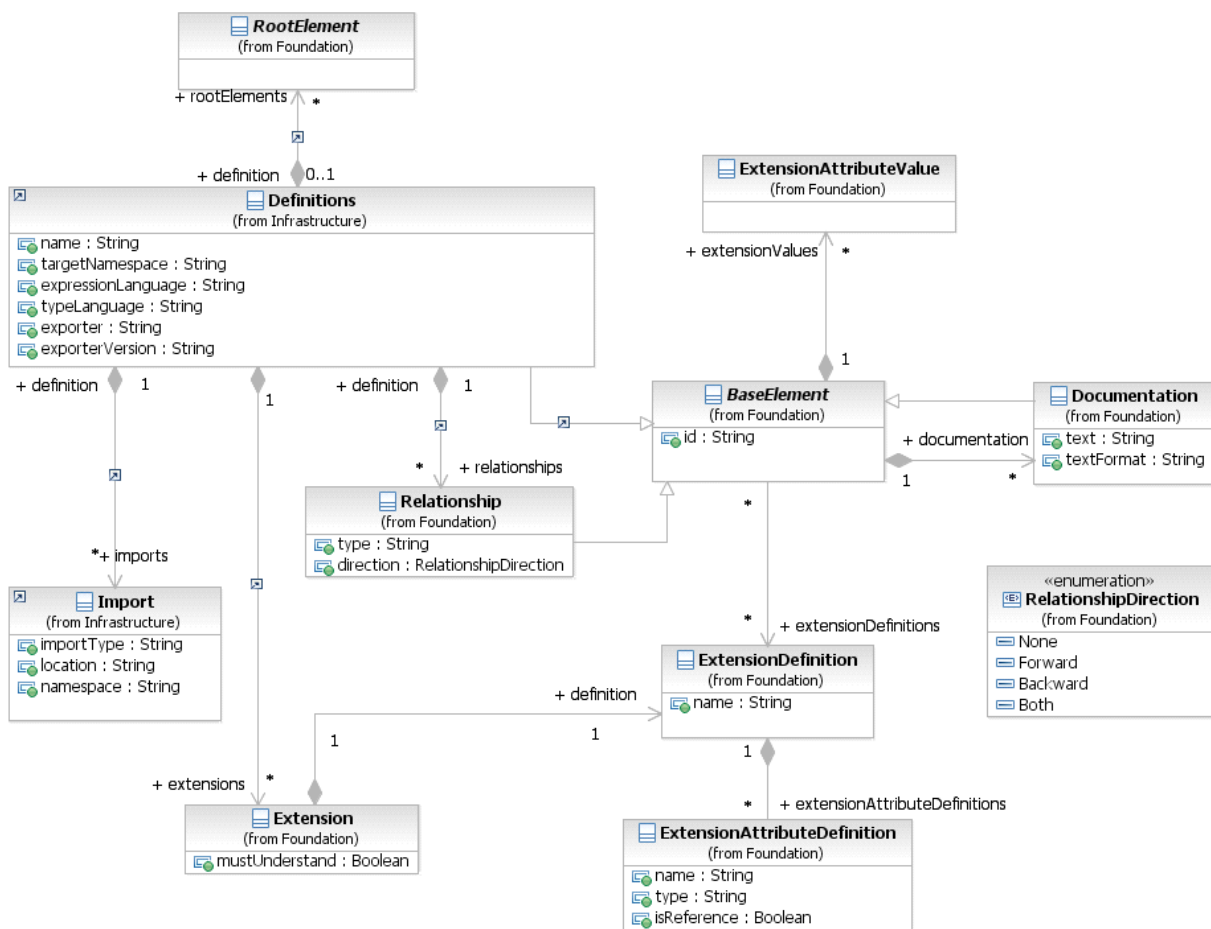

Figure 8.5 – Classes in the Foundation package

8.3.1 Base Element

BaseElement is the abstract super class for most BPMN elements. It provides the attributes `id` and `documentation`, which other elements will inherit.

Table 8.5 presents the attributes and model associations for the BaseElement.

Table 8.5 – BaseElement attributes and model associations

Attribute Name	Description/Usage
<code>id</code> : string	This attribute is used to uniquely identify BPMN elements. The <code>id</code> is REQUIRED if this element is referenced or intended to be referenced by something else. If the element is not currently referenced and is never intended to be referenced, the <code>id</code> MAY be omitted.
documentation : Documentation [0..*]	This attribute is used to annotate the BPMN element, such as descriptions and other documentation.
extensionDefinitions : ExtensionDefinition [0..*]	This attribute is used to attach additional attributes and associations to any BaseElement. This association is not applicable when the XML schema interchange is used, since the XSD mechanisms for supporting <code>anyAttribute</code> and any element already satisfy this requirement. See page 57 for additional information on extensibility.
extensionValues : ExtensionAttributeValue [0..*]	This attribute is used to provide values for extended attributes and model associations. This association is not applicable when the XML schema interchange is used, since the XSD mechanisms for supporting <code>anyAttribute</code> and any element already satisfy this requirement. See page 57 for additional information on extensibility.

8.3.2 Documentation

All **BPMN** elements that inherit from the BaseElement will have the capability, through the `Documentation` element, to have one (1) or more text descriptions of that element.

The `Documentation` element inherits the attributes and model associations of BaseElement (see Table 8.5). Table 8.6 presents the additional attributes of the `Documentation` element.

Table 8.6 – Documentation attributes

Attribute Name	Description/Usage
<code>text</code> : string	This attribute is used to capture the text descriptions of a BPMN element.
<code>textFormat</code> : string	This attribute identifies the format of the text. It MUST follow the mime-type format. The default is "text/plain."

In the **BPMN** schema, the `tDocumentation` complexType does not contain a text attribute or element. Instead, the documentation text is expected to appear in the body of the documentation element. For example:

<documentation>An example of how the documentation text is entered.</documentation>

8.3.3 Extensibility

The **BPMN** metamodel is aimed to be extensible. This allows **BPMN** adopters to extend the specified metamodel in a way that allows them to be still **BPMN**-compliant.

It provides a set of extension elements, which allows **BPMN** adopters to attach additional attributes and elements to standard and existing **BPMN** elements.

This approach results in more interchangeable models, because the standard elements are still intact and can still be understood by other **BPMN** adopters. It's only the additional attributes and elements that MAY be lost during interchange.

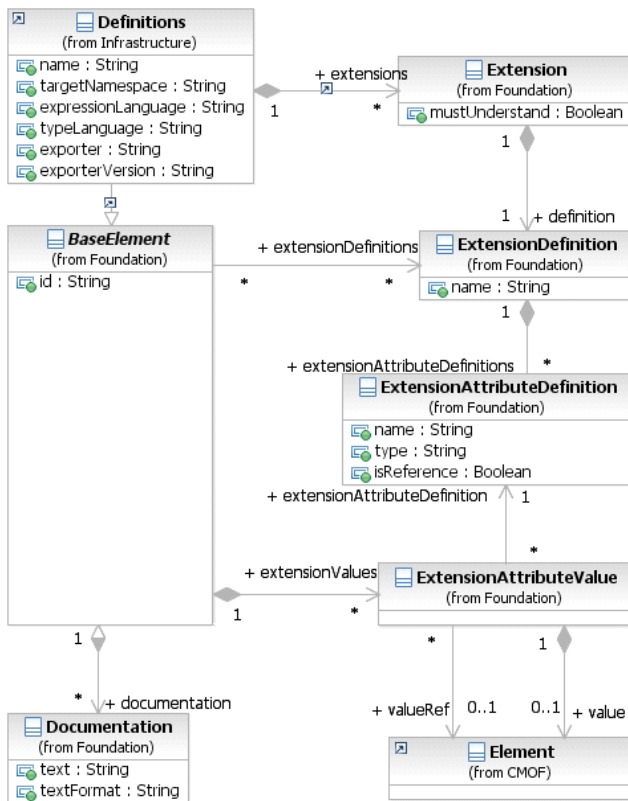

Figure 8.6 – Extension class diagram

A **BPMN** Extension basically consists of four different elements:

1. Extension
2. ExtensionDefinition
3. ExtensionAttributeDefinition
4. ExtensionAttributeValue

The core elements of an Extension are the `ExtensionDefinition` and `ExtensionAttributeDefinition`. The latter defines a list of attributes that can be attached to any **BPMN** element. The attribute list defines the name and type of the new attribute. This allows **BPMN** adopters to integrate any meta model into the **BPMN** meta model and reuse already existing model elements.

The `ExtensionDefinition` itself can be created independent of any **BPMN** element or any **BPMN** definition.

In order to use an `ExtensionDefinition` within a **BPMN** model definition (`Definitions` element), the `ExtensionDefinition` **MUST** be associated with an `Extension` element that binds the `ExtensionDefinition` to a specific **BPMN** model definition. The `Extension` element itself is contained within the **BPMN** element `Definitions` and therefore available to be associated with any **BPMN** element making use of the `ExtensionDefinition`.

Every **BPMN** element which subclasses the **BPMN** `BaseElement` can be extended by additional attributes. This works by associating a **BPMN** element with an `ExtensionDefinition`, which was defined at the **BPMN** model definitions level (element `Definitions`).

Additionally, every “extended” **BPMN** element contains the actual extension attribute value. The attribute value, defined by the element `ExtensionAttributeValue` contains the value of type `Element`. It also has an association to the corresponding attribute definition.

Extension

The `Extension` element binds/imports an `ExtensionDefinition` and its attributes to a **BPMN** model definition.

Table 8.7 presents the attributes and model associations for the `Extension` element.

Table 8.7 – Extension attributes and model associations

Attribute Name	Description/Usage
mustUnderstand : boolean [0..1] = False	This flag defines if the semantics defined by the extension definition and its attribute definition MUST be understood by the BPMN adopter in order to process the BPMN model correctly. Defaults to False.
definition : <code>ExtensionDefinition</code>	Defines the content of the extension. Note that in the XML schema, this definition is provided by an external XML schema file and is simply referenced by <code>QName</code> .

ExtensionDefinition

The `ExtensionDefinition` class defines and groups additional attributes. This type is not applicable when the XML schema interchange is used, since XSD Complex Types already satisfy this requirement.

Table 8.8 presents the attributes and model associations for the `ExtensionDefinition` element.

Table 8.8 – ExtensionDefinition attributes and model associations

Attribute Name	Description/Usage
name: string	The name of the extension. This is used as a namespace to uniquely identify the extension content.
extensionAttributeDefinitions: ExtensionAttributeDefinition [0..*]	The specific attributes that make up the extension.

ExtensionAttributeDefinition

The `ExtensionAttributeDefinition` defines new attributes. This type is not applicable when the XML schema interchange is used; since the XSD mechanisms for supporting “AnyAttribute” and “Any” type already satisfy this requirement.

Table 8.9 presents the attributes for the `ExtensionAttributeDefinition` element.

Table 8.9- ExtensionAttributeDefinition attributes

Attribute Name	Description/Usage
name: string	The name of the extension attribute.
type: string	The type that is associated with the attribute.
isReference: boolean [0..1] = False	Indicates if the attribute value will be referenced or contained.

ExtensionAttributeValue

The `ExtensionAttributeValue` contains the attribute value. This type is not applicable when the XML schema interchange is used; since the XSD mechanisms for supporting “AnyAttribute” and “Any” type already satisfy this requirement.

Table 8.10 presents the model associations for the `ExtensionAttributeValue` element.

Table 8.10 – ExtensionAttributeValue model associations

Attribute Name	Description/Usage
value: [Element [0..1]]	The contained attribute value, used when the associated <code>ExtensionAttributeDefinition.isReference</code> is false. The type of this <code>Element</code> MUST conform to the type specified in the associated <code>ExtensionAttributeDefinition</code> .
valueRef: [Element [0..1]]	The referenced attribute value, used when the associated <code>ExtensionAttributeDefinition.isReference</code> is true. The type of this <code>Element</code> MUST conform to the type specified in the associated <code>ExtensionAttributeDefinition</code> .
extensionAttributeDefinition: ExtensionAttributeDefinition	Defines the extension attribute for which this value is being provided.

Extensibility XML Schemas

Table 8.11 – Extension XML schema

```
<xsd:element name="extension" type="tExtension"/>
<xsd:complexType name="tExtension">
  <xsd:sequence>
    <xsd:element ref="documentation" minOccurs="0" maxOccurs="unbounded"/>
  </xsd:sequence>
  <xsd:attribute name="definition" type="xsd:QName"/>
  <xsd:attribute name="mustUnderstand" type="xsd:boolean" use="optional"/>
</xsd:complexType>
```

XML Example

This example shows a **Task**, defined the **BPMN** Core, being extended with Inputs and Outputs defined outside of the Core.

Table 8.12 – Example Core XML schema

```
<xsd:schema ...>
  ...
  <xsd:element name="task" type="tTask"/>
  <xsd:complexType name="tTask">
    <xsd:complexContent>
      <xsd:extension base="tActivity"/>
    </xsd:complexContent>
  </xsd:complexType>
  ...
</xsd:schema>
```

Table 8.13 – Example Extension XML schema

```
<xsd:schema ...>
  ...
  <xsd:group name="dataRequirements">
    <xsd:sequence>
      <xsd:element ref="dataInput" minOccurs="0" maxOccurs="unbounded" />
      <xsd:element ref="dataOutput" minOccurs="0" maxOccurs="unbounded" />
      <xsd:element ref="inputSet" minOccurs="0" maxOccurs="unbounded" />
      <xsd:element ref="outputSet" minOccurs="0" maxOccurs="unbounded" />
    </xsd:sequence>
  </xsd:group>
  ...
</xsd:schema>
```

Table 8.14 – Sample XML instance

```
<bpmn:definitions id="ID_1" ...>
  ...
  <bpmn:extension mustUnderstand="true" definition="bpmn:dataRequirements"/>
  ...
  <bpmn:task name="Retrieve Customer Record" id="ID_2">
    <bpmn:dataInput name="Order Input" id="ID_3">
      <bpmn:typeDefinition typeRef="bo:Order" id="ID_4"/>
    </bpmn:dataInput>
    <bpmn:dataOutput name="Customer Record Output" id="ID_5">
      <bpmn:typeDefinition typeRef="bo:CustomerRecord" id="ID_6"/>
    </bpmn:dataOutput>
    <bpmn:inputSet name="Inputs" id="ID_7" dataInputRefs="ID_3"/>
    <bpmn:outputSet name="Outputs" id="ID_8" dataOutputRefs="ID_5"/>
  </bpmn:task>
  ...
</bpmn:definitions>
```

8.3.4 External Relationships

It is the intention of this International Standard to cover the basic elements necessary for the construction of semantically rich and syntactically valid **Process** models to be used in the description of **Processes**, **Choreographies**, and business operations in multiple levels of abstraction. As the International Standard indicates, extension capabilities enable the enrichment of the information described in **BPMN** and supporting models to be augmented to fulfill particularities of a given usage model. These extensions' intention is to extend the semantics of a given **BPMN** *Artifact* to provide specialization of intent or meaning.

Process models do not exist in isolation and generally participate in larger, more complex business and system development **Processes**. The intention of the following element is to enable **BPMN** Artifacts to be integrated in these development **Processes** via the specification of a non-intrusive identity/relationship model between **BPMN** Artifacts and elements expressed in any other addressable domain model.

The ‘identity/relationship’ model is reduced to the creation of families of typed relationships that enable **BPMN** and non-**BPMN** Artifacts to be related in non intrusive manner. By simply defining ‘relationship types’ that can be associated with elements in the **BPMN** Artifacts and arbitrary elements in a given addressable domain model, it enables the extension and integration of **BPMN** models into larger system/development **Processes**.

It is that these extensions will enable, for example, the linkage of ‘derivation’ or ‘definition’ relationships between UML artifacts and **BPMN** Artifacts in novel ways. So, a UML use case could be related to a **Process** element in the **BPMN** International Standard without affecting the nature of the Artifacts themselves, but enabling different integration models that traverse specialized relationships.

Simply, the model enables the external specification of augmentation relationships between **BPMN** Artifacts and arbitrary relationship classification models, these external models, via traversing relationships declared in the external definition allow for linkages between **BPMN** elements and other structured or non-structured metadata definitions.

The UML model for this International Standard follows a simple extensible pattern as shown below; where named relationships can be established by referencing objects that exist in their given namespaces.

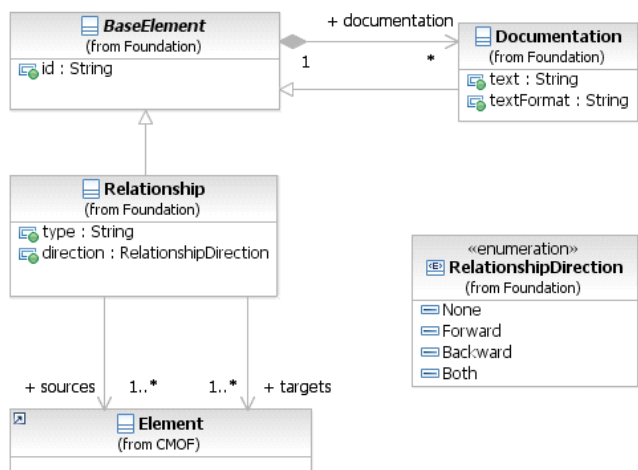

Figure 8.7 – External Relationship Metamodel

The `Relationship` element inherits the attributes and model associations of `BaseElement` (see Table 8.5). Table 8.15 presents the additional attributes for the `Relationship` element.

Table 8.15 – Relationship attributes

Attribute Name	Description/Usage
type: string	The descriptive name of the element.
direction: RelationshipDirection {None Forward Backward Both}	This attribute specifies the direction of the relationship.
sources: [Element [1..*]]	This association defines artifacts that are augmented by the relationship.
targets: [Element[1..*]]	This association defines artifacts used to extend the semantics of the source element(s).

In this manner you can, for example, create relationships between different artifacts that enable external annotations used for traceability, derivation, arbitrary classifications, etc.

An example where the ‘reengineer’ relationship is shown between elements in a Visio™ artifact and a **BPMN** Artifact.

Table 8.16 – Reengineer XML schema

```
<?xml version="1.0" encoding="UTF-8"?>
<definitions targetNamespace=""
  typeLanguage="" id="a123" expressionLanguage=""
  xsi:schemaLocation="http://www.omg.org/spec/BPMN/20100524/MODEL Core-Common.xsd"
  xmlns="http://www.omg.org/spec/BPMN/20100524/MODEL"
  xmlns:xsi="http://www.w3.org/2001/XMLSchema-instance"
  xmlns:src="http://www.example.org/Processes/Old"
  xmlns:tgt="http://www.example.org/Processes/New">

  <import importType="http://office.microsoft.com/visio" location="OrderConfirmationProcess.vsd"
    namespace="http://www.example.org/Processes/Old"/>
  <import importType="http://www.omg.org/spec/BPMN/20100524/MODEL"
    location="OrderConfirmationProcess.xml"
    namespace="http://www.example.org/Processes/New"/>

  <relationship type="reengineered" id="a234" direction="both">
    <documentation>An as-is and to-be relationship. The as-is model is expressed as a Visio dia-
      gram. The re-engineered process has been split in two and is captured in BPMN 2.0 for-
      mat.</documentation>
    <source ref="src:OrderConfirmation"/>
    <target ref="tgt:OrderConfirmation_PartI"/>
    <target ref="tgt:OrderConfirmation_PartII"/>
  </relationship>
</definitions>
```

8.3.5 Root Element

`RootElement` is the abstract super class for all **BPMN** elements that are contained within `Definitions`. When contained within `Definitions`, these elements have their own defined life-cycle and are not deleted with the deletion of other elements. Examples of concrete `RootElement`s include **Collaboration**, **Process**, and **Choreography**. Depending on their use, `RootElement`s can be referenced by multiple other elements (i.e., they can be reused). Some `RootElement`s MAY be contained within other elements instead of `Definitions`. This is done to avoid the maintenance overhead of an independent life-cycle. For example, an `EventDefinition` would be contained in a **Process** since it is used only there. In this case the `EventDefinition` would be dependent on the tool life-cycle of the **Process**.

The `RootElement` element inherits the attributes and model associations of `BaseElement` (see Table 8.5), but does not have any further attributes or model associations.

8.3.6 Foundation Package XML Schemas

Table 8.17 – `BaseElement` XML schema

```
<xsd:element name="baseElement" type="tBaseElement"/>
<xsd:complexType name="tBaseElement" abstract="true">
  <xsd:sequence>
    <xsd:element ref="documentation" minOccurs="0" maxOccurs="unbounded"/>
    <xsd:element ref="extensionElements" minOccurs="0" maxOccurs="1"/>
  </xsd:sequence>
  <xsd:attribute name="id" type="xsd:ID" use="optional"/>
  <xsd:anyAttribute namespace="##other" processContents="lax"/>
</xsd:complexType>

<xsd:element name="baseElementWithMixedContent" type="tBaseElementWithMixedContent"/>
<xsd:complexType name="tBaseElementWithMixedContent" abstract="true" mixed="true">
  <xsd:sequence>
    <xsd:element ref="documentation" minOccurs="0" maxOccurs="unbounded"/>
    <xsd:element ref="extensionElements" minOccurs="0" maxOccurs="1"/>
  </xsd:sequence>
  <xsd:attribute name="id" type="xsd:ID" use="optional"/>
  <xsd:anyAttribute namespace="##other" processContents="lax"/>
</xsd:complexType>

<xsd:element name="extensionElements" type="tExtensionElements"/>
<xsd:complexType name="tExtensionElements">
  <xsd:sequence>
    <xsd:any namespace="##any" processContents="lax" minOccurs="0" maxOccurs="unbounded"/>
  </xsd:sequence>
</xsd:complexType>

<xsd:element name="documentation" type="tDocumentation"/>
<xsd:complexType name="tDocumentation" mixed="true">
```

```

<xsd:sequence>
  <xsd:any namespace="##any" processContents="lax" minOccurs="0"/>
</xsd:sequence>
<xsd:attribute name="id" type="xsd:ID" use="optional"/>
<xsd:attribute name="textFormat" type="xsd:string" default="textplain"/>
</xsd:complexType>

```

Table 8.18 – RootElement XML schema

```

<xsd:element name="rootElement" type="tRootElement"/>
<xsd:complexType name="tRootElement" abstract="true">
  <xsd:complexContent>
    <xsd:extension base="tBaseElement"/>
  </xsd:complexContent>
</xsd:complexType>

```

Table 8.19 – Relationship XML schema

```

<xsd:element name="relationship" type="tRelationship"/>
<xsd:complexType name="tRelationship">
  <xsd:complexContent>
    <xsd:extension base="tBaseElement">
      <xsd:sequence>
        <xsd:element name="source" type="xsd:QName" minOccurs="1" maxOccurs="unbounded"/>
        <xsd:element name="target" type="xsd:QName" minOccurs="1" maxOccurs="unbounded"/>
      </xsd:sequence>
      <xsd:attribute name="type" type="xsd:string" use="required"/>
      <xsd:attribute name="direction" type="tRelationshipDirection"/>
    </xsd:extension>
  </xsd:complexContent>
</xsd:complexType>

<xsd:simpleType name="tRelationshipDirection">
  <xsd:restriction base="xsd:string">
    <xsd:enumeration value="None"/>
    <xsd:enumeration value="Forward"/>
    <xsd:enumeration value="Backward"/>
    <xsd:enumeration value="Both"/>
  </xsd:restriction>
</xsd:simpleType>

```

8.4 Common Elements

The following sub clauses define **BPMN** elements that MAY be used in more than one type of diagram (e.g., **Process**, **Collaboration**, and **Choreography**).

8.4.1 Artifacts

BPMN provides modelers with the capability of showing additional information about a **Process** that is not directly related to the **Sequence Flows** or **Message Flows** of the **Process**.

At this point, **BPMN** provides three standard **Artifacts**: **Associations**, **Groups**, and **Text Annotations**. Additional **Artifacts** MAY be added to the **BPMN** International Standard in later versions. A modeler or modeling tool MAY extend a **BPMN** diagram and add new types of **Artifacts** to a **Diagram**. Any new **Artifact** MUST follow the **Sequence Flow** and **Message Flow** connection rules (listed below). **Associations** can be used to link **Artifacts** to **Flow Objects** (see page 67).

Figure 8.8 shows the **Artifacts** class diagram. When an **Artifact** is defined it is contained within a **Collaboration** or a **FlowElementsContainer** (a **Process** or **Choreography**).

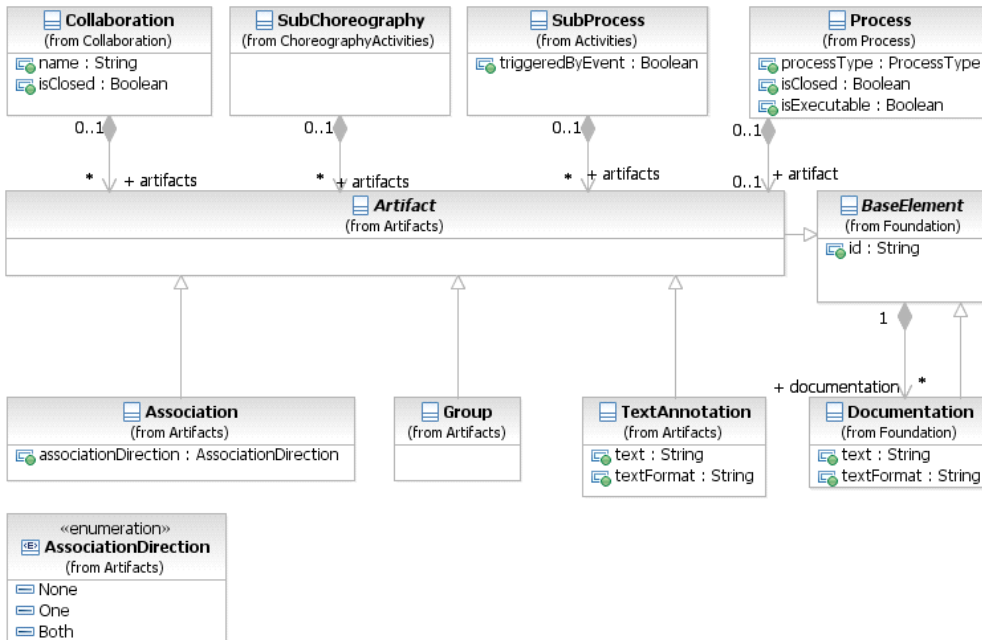

Figure 8.8 – Artifacts Metamodel

Common Artifact Definitions

The following sub clauses provide definitions that are common to all **Artifacts**.

Artifact Sequence Flow Connections

See “Sequence Flow Connections Rules” on page 40 for the entire set of objects and how they MAY be source or targets of a **Sequence Flow**.

- ◆ An **Artifact** **MUST NOT** be a target for a **Sequence Flow**.
- ◆ An **Artifact** **MUST NOT** be a source for a **Sequence Flow**.

Artifact Message Flow Connections

See “Message Flow Connection Rules” on page 41 for the entire set of objects and how they **MAY** be source or targets of a **Message Flow**.

- ◆ An **Artifact** **MUST NOT** be a target for a **Message Flow**.
- ◆ An **Artifact** **MUST NOT** be a source for a **Message Flow**.

Association

An **Association** is used to associate information and **Artifacts** with *Flow Objects*. Text and graphical non-*Flow Objects* can be associated with the *Flow Objects* and Flow. An **Association** is also used to show the **Activity** used for *compensation*. More information about *compensation* can be found on page 300.

- ◆ An **Association** is line that **MUST** be drawn with a dotted single line (see Figure 8.9).
- ◆ The use of text, color, size, and lines for an **Association** **MUST** follow the rules defined in “Use of Text, Color, Size, and Lines in a Diagram” on page 39.

.....

Figure 8.9 – An Association

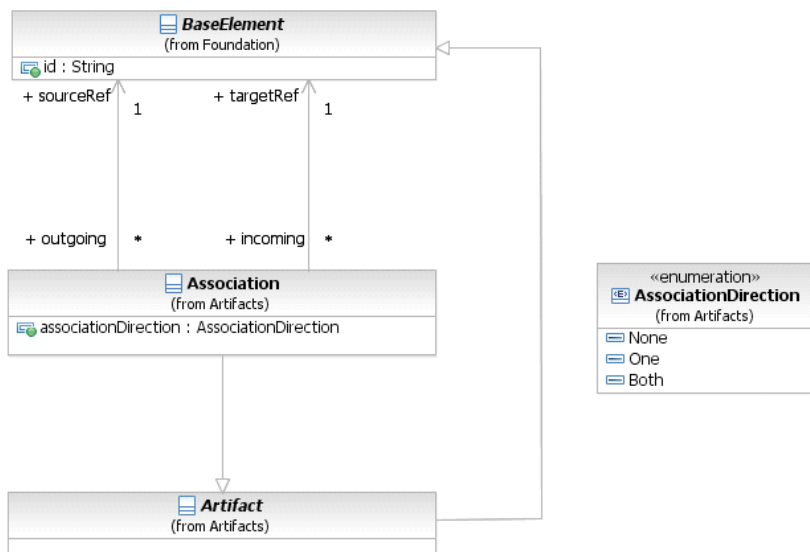

Figure 8.10 – The Association Class Diagram

If there is a reason to put directionality on the **Association** then:

- ◆ A line arrowhead **MAY** be added to the **Association** line (see Figure 8.11).
- ◆ The directionality of the **Association** can be in one (1) direction or in both directions.



Figure 8.11 – A Directional Association

Note that directional **Associations** were used in **BPMN 1.2** to show how **Data Objects** were inputs or outputs to **Activities**. In **BPMN 2.0.1**, a **Data Association** connector is used to show inputs and outputs (see page 220). A **Data Association** uses the same notation as a directed **Association** (as in Figure 8.11, above).

An **Association** is used to connect user-defined text (an **Annotation**) with a *Flow Object* (see Figure 8.12).

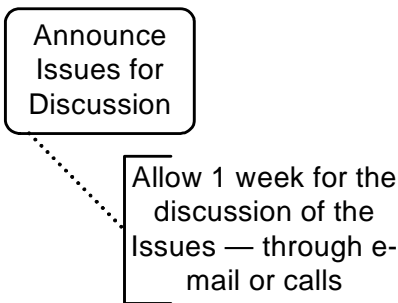

Figure 8.12 – An Association of Text Annotation

The **Association** element inherits the attributes and model associations of `BaseElement` (see Table 8.5). Table 8.20 presents the additional attributes and model associations for an **Association**.

Table 8.20 – Association attributes and model associations

Attributes	Description
associationDirection: AssociationDirection = None {None One Both}	<code>associationDirection</code> is an attribute that defines whether or not the Association shows any directionality with an arrowhead. The default is <code>None</code> (no arrowhead). A value of <code>One</code> means that the arrowhead SHALL be at the Target Object. A value of <code>Both</code> means that there SHALL be an arrowhead at both ends of the Association line.
sourceRef: BaseElement	The <code>BaseElement</code> that the Association is connecting from.
targetRef: BaseElement	The <code>BaseElement</code> that the Association is connecting to.

Group

The **Group** object is an **Artifact** that provides a visual mechanism to group elements of a diagram informally. The grouping is tied to the `CategoryValue` supporting element. That is, a **Group** is a visual depiction of a single `CategoryValue`. The graphical elements within the **Group** will be assigned the `CategoryValue` of the **Group**. (NOTE - `CategoryValues` can be highlighted through other mechanisms, such as color, as defined by a modeler or a modeling tool).

- ◆ A **Group** is a rounded corner rectangle that **MUST** be drawn with a solid dashed line (as seen in Figure 8.13).

- ◆ The use of text, color, size, and lines for a **Group** MUST follow the rules defined in “Use of Text, Color, Size, and Lines in a Diagram” on page 39.



Figure 8.13 – A Group Artifact

As an Artifact, a **Group** is not an **Activity** or any Flow Object, and, therefore, cannot connect to **Sequence Flows** or **Message Flows**. In addition, **Groups** are not constrained by restrictions of **Pools** and **Lanes**. This means that a **Group** can stretch across the boundaries of a **Pool** to surround **Diagram** elements (see Figure 8.14), often to identify **Activities** that exist within a distributed business-to-business transaction.

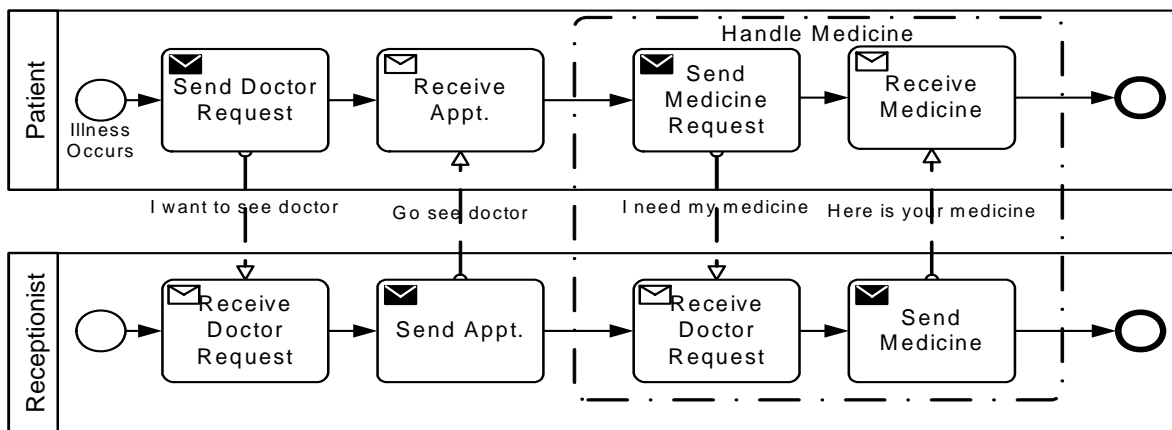

Figure 8.14 – A Group around Activities in different Pools

Groups are often used to highlight certain sub clauses of a Diagram without adding additional constraints for performance, as a **Sub-Process** would. The highlighted (grouped) sub clause of the Diagram can be separated for reporting and analysis purposes. **Groups** do not affect the flow of the **Process**.

Figure 8.15 shows the **Group** class diagram.

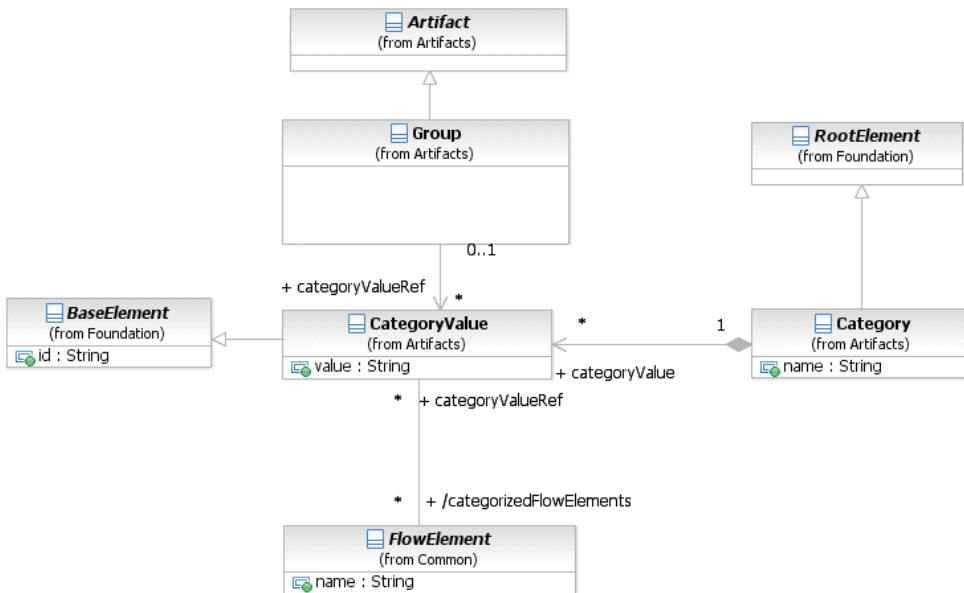

Figure 8.15 – The Group class diagram

The **Group** element inherits the attributes and model associations of **BaseElement** (see Table 8.5), through its relationship to **Artifact**. Table 8.21 presents the additional model associations for a **Group**.

Table 8.21 – Group model associations

Attributes	Description
categoryValueRef: CategoryValue [0..1]	The categoryValueRef attribute specifies the CategoryValue that the Group represents. (Further details about the definition of a Category and CategoryValue can be found on page 70.) The name of the Category and the value of the CategoryValue separated by delineator "." provides the label for the Group . The graphical elements within the boundaries of the Group will be assigned the CategoryValue .

Category

Categories, which have user-defined semantics, can be used for documentation or analysis purposes. For example, **FlowElements** can be categorized as being customer oriented vs. support oriented. Furthermore, the cost and time of **Activities** per **Category** can be calculated.

Groups are one way in which **Categories** of objects can be visually displayed on the diagram. That is, a **Group** is a visual depiction of a single **CategoryValue**. The graphical elements within the **Group** will be assigned the **CategoryValue** of the **Group**. The value of the **CategoryValue**, optionally prepended by the **Category** name and delineator ":", appears on the diagram as the **Group** label. (NOTE - **Categories** can be highlighted through other mechanisms, such as color, as defined by a modeler or a modeling tool). A single **Category** can be used for multiple **Groups** in a diagram.

The `Category` element inherits the attributes and model associations of `BaseElement` (see Table 8.5) through its relationship to `RootElement`. Table 8.22 displays the additional model associations of the `Category` element.

Table 8.22 – Category model associations

Attributes	Description
name: string	The descriptive name of the element.
categoryValue: <code>CategoryValue</code> [0..*]	The <code>categoryValue</code> attribute specifies one or more values of the <code>Category</code> . For example, the <code>Category</code> is “Region” then this <code>Category</code> could specify values like “North,” “South,” “West,” and “East.”

The `CategoryValue` element inherits the attributes and model associations of `BaseElement` (see Table 8.5). Table 8.23 displays the attributes and model associations of the `CategoryValue` element.

Table 8.23 – CategoryValue attributes and model associations

Attributes	Description
value: string	This attribute provides the value of the <code>CategoryValue</code> element.
category: <code>Category</code> [0..1]	The <code>category</code> attribute specifies the <code>Category</code> representing the <code>CategoryValue</code> as such and contains the <code>CategoryValue</code> (Further details about the definition of a <code>Category</code> can be found on page 70).
categorizedFlowElements: <code>FlowElement</code> [0..*]	The <code>FlowElements</code> attribute identifies all of the elements (e.g., <code>Events</code> , <code>Activities</code> , <code>Gateways</code> , and <code>Artifacts</code>) that are within the boundaries of the <code>Group</code> .

Text Annotation

Text Annotations are a mechanism for a modeler to provide additional information for the reader of a **BPMN** Diagram.

- ◆ A **Text Annotation** is an open rectangle that **MUST** be drawn with a solid single line (as seen in Figure 8.16).
- ◆ The use of text, color, size, and lines for a **Text Annotation** **MUST** follow the rules defined in “Use of Text, Color, Size, and Lines in a Diagram” on page 39.

The **Text Annotation** object can be connected to a specific object on the Diagram with an **Association**, but does not affect the flow of the **Process**. Text associated with the **Annotation** can be placed within the bounds of the open rectangle.

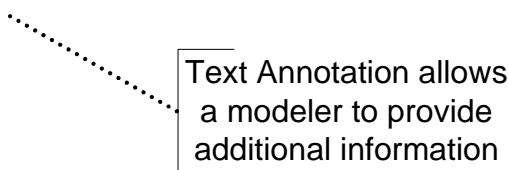

Figure 8.16 – A Text Annotation

The **Text Annotation** element inherits the attributes and model associations of `BaseElement` (see Table 8.5). Table 8.24 presents the additional attributes for a **Text Annotation**.

Table 8.24 –Text Annotation attributes

Attributes	Description
text: string	Text is an attribute that is text that the modeler wishes to communicate to the reader of the Diagram.
textFormat: string	This attribute identifies the format of the text. It MUST follow the mime-type format. The default is "text/plain."

XML Schema for Artifacts

Table 8.25 – Artifact XML schema

```
<xsd:element name="artifact" type="tArtifact"/>
<xsd:complexType name="tArtifact" abstract="true">
  <xsd:complexContent>
    <xsd:extension base="tBaseElement"/>
  </xsd:complexContent>
</xsd:complexType>
```

Table 8.26 – Association XML schema

```
<xsd:element name="association" type="tAssociation" substitutionGroup="artifact"/>
<xsd:complexType name="tAssociation">
  <xsd:complexContent>
    <xsd:extension base="tArtifact">
      <xsd:attribute name="sourceRef" type="xsd:QName" use="required"/>
      <xsd:attribute name="targetRef" type="xsd:QName" use="required"/>
      <xsd:attribute name="associationDirection" type="tAssociationDirection" default="None"/>
    </xsd:extension>
  </xsd:complexContent>
</xsd:complexType>

<xsd:simpleType name="tAssociationDirection">
  <xsd:restriction base="xsd:string">
    <xsd:enumeration value="None"/>
    <xsd:enumeration value="One"/>
    <xsd:enumeration value="Both"/>
  </xsd:restriction>
</xsd:simpleType>
```

Table 8.27 – Category XML schema

```
<xsd:element name="category" type="tCategory" substitutionGroup="rootElement"/>
```

```

<xsd:complexType name="tCategory">
  <xsd:complexContent>
    <xsd:extension base="tRootElement">
      <xsd:sequence>
        <xsd:element ref="categoryValue" minOccurs="0" maxOccurs="unbounded"/>
      </xsd:sequence>
      <xsd:attribute name="name" type="xsd:string"/>
    </xsd:extension>
  </xsd:complexContent>
</xsd:complexType>

```

Table 8.28 – CategoryValue XML schema

```

<xsd:element name="categoryValue" type="tCategoryValue"/>
<xsd:complexType name="tCategoryValue">
  <xsd:complexContent>
    <xsd:extension base="tBaseElement">
      <xsd:attribute name="value" type="xsd:string" use="optional"/>
    </xsd:extension>
  </xsd:complexContent>
</xsd:complexType>

```

Table 8.29 – Group XML schema

```

<xsd:element name="group" type="tGroup" substitutionGroup="artifact"/>
<xsd:complexType name="tGroup">
  <xsd:complexContent>
    <xsd:extension base="tArtifact">
      <xsd:attribute name="categoryValueRef" type="xsd:QName" use="optional"/>
    </xsd:extension>
  </xsd:complexContent>
</xsd:complexType>

```

Table 8.30– Text Annotation XML schema

```

<xsd:element name="textAnnotation" type="tTextAnnotation" substitutionGroup="artifact"/>
<xsd:complexType name="tTextAnnotation">
  <xsd:complexContent>
    <xsd:extension base="tArtifact">
      <xsd:sequence>
        <xsd:element ref="text" minOccurs="0" maxOccurs="1"/>
      </xsd:sequence>
      <xsd:attribute name="textFormat" type="xsd:string" default="textplain"/>
    </xsd:extension>
  </xsd:complexContent>
</xsd:complexType>

```

```

<xsd:element name="text" type="tText"/>
<xsd:complexType name="tText" mixed="true">
  <xsd:sequence>
    <xsd:any namespace="##any" processContents="lax" minOccurs="0"/>
  </xsd:sequence>
</xsd:complexType>

```

8.4.2 Correlation

Business Processes typically can run for days or even months, requiring asynchronous communication via **Message**. Also, many *instances* of a particular **Process** will typically run in parallel, e.g., many *instances* of an order process, each representing a particular order. *Correlation* is used to associate a particular **Message** to an ongoing **Conversation** between two particular **Process instances**. **BPMN** allows using existing **Message** data for *correlation* purposes, e.g., for the order process, a particular *instance* can be identified by means of its `orderId` and/or `customerID`, rather than requiring the introduction of technical *correlation* data.

The concept of *Correlation* facilitates the association of a **Message** to a **Send Task** or **Receive Task**¹ often in the context of a **Conversation**, which is also known as *instance routing*. It is a particular useful concept where there is no infrastructure support for *instance routing*. Note that this association can be viewed at multiple levels, namely the **Collaboration (Conversation)**, **Choreography**, and **Process** level. However, the actual correlation happens during runtime (e.g., at the **Process** level). *Correlations* describe a set of predicates on a **Message** (generally on the application payload) that need to be satisfied in order for that **Message** to be associated to a distinct **Send Task** or **Receive Task**. By the same token, each **Send Task** and each **Receive Task** participates in one or many **Conversations**. Furthermore, it identifies the **Message** it sends or receives and thereby establishes the relationship to one (or many) *CorrelationKeys*.

There are two, non-exclusive correlation mechanisms in place:

1. In plain, key-based correlation, **Messages** that are exchanged within a **Conversation** are logically correlated by means of one or more common *CorrelationKeys*. That is, any **Message** that is sent or received within this **Conversation** needs to carry the value of at least one of these *CorrelationKey* instances within its payload. A *CorrelationKey* basically defines a (composite) key. The first **Message** that is initially sent or received initializes one or more *CorrelationKey* instances associated with the **Conversation**, i.e., assigns values to its *CorrelationProperty* instances that are the fields (partial keys) of the *CorrelationKey*. A *CorrelationKey* is only considered valid for use, if the **Message** has resulted in all *CorrelationProperty* fields within the key being populated with a value. If a follow-up **Message** derives a *CorrelationKey* instance, where that *CorrelationKey* had previously been initialized within the **Conversation**, then the *CorrelationKey* value in the **Message** and **Conversation** **MUST** match. If the follow-up **Message** derives a *CorrelationKey* instance associated with the **Conversation**, that had not previously been initialized, then the *CorrelationKey* value will become associated with the **Conversation**. As a **Conversation** can comprise different **Messages** that can be differently structured, each *CorrelationProperty* comes with as many extraction rules (*CorrelationPropertyRetrievalExpression*) for the respective partial key as there are different **Messages**.

-
1. All references to **Send** or **Receive Tasks** in this sub clause also include message *catch* or *throw Events*; they behave identically with respect to correlation.

2. In context-based correlation, the **Process** context (i.e., its **Data Objects** and **Properties**) can dynamically influence the matching criterion. That is, a **CorrelationKey** can be complemented by a **Process**-specific **CorrelationSubscription**. A **CorrelationSubscription** aggregates as many **CorrelationPropertyBindings** as there are **CorrelationProperties** in the **CorrelationKey**. A **CorrelationPropertyBinding** relates to a specific **CorrelationProperty** and also links to a **FormalExpression** that denotes a dynamic extraction rule atop the **Process** context. At runtime, the **CorrelationKey** instance for a particular **Conversation** is populated (and dynamically updated) from the **Process** context using these **FormalExpressions**. In that sense, changes in the **Process** context can alter the correlation condition.

Correlation can be applied to **Message Flows** in **Collaboration** and **Choreography**, as described in Clause 9, 'Collaboration' and 11, 'Choreography'. The keys applying to a **Message Flow** are the keys of containers or groupings of the **Message Flow**, such as **Collaborations**, **Choreographies**, and **Conversation Nodes**, and **Choreography Activities**. This might result in multiple **CorrelationKeys** applying to the same **Message Flow**, perhaps due to multiple layers of containment. In particular, calls of **Collaborations** and **Choreographies** are special kinds of **Conversation Nodes** and **Choreography Activities**, respectively, and are considered a kind of containment for the purposes of *correlation*. The **CorrelationKeys** specified in the caller apply to **Message Flow** in a called **Collaboration** or **Choreography**.

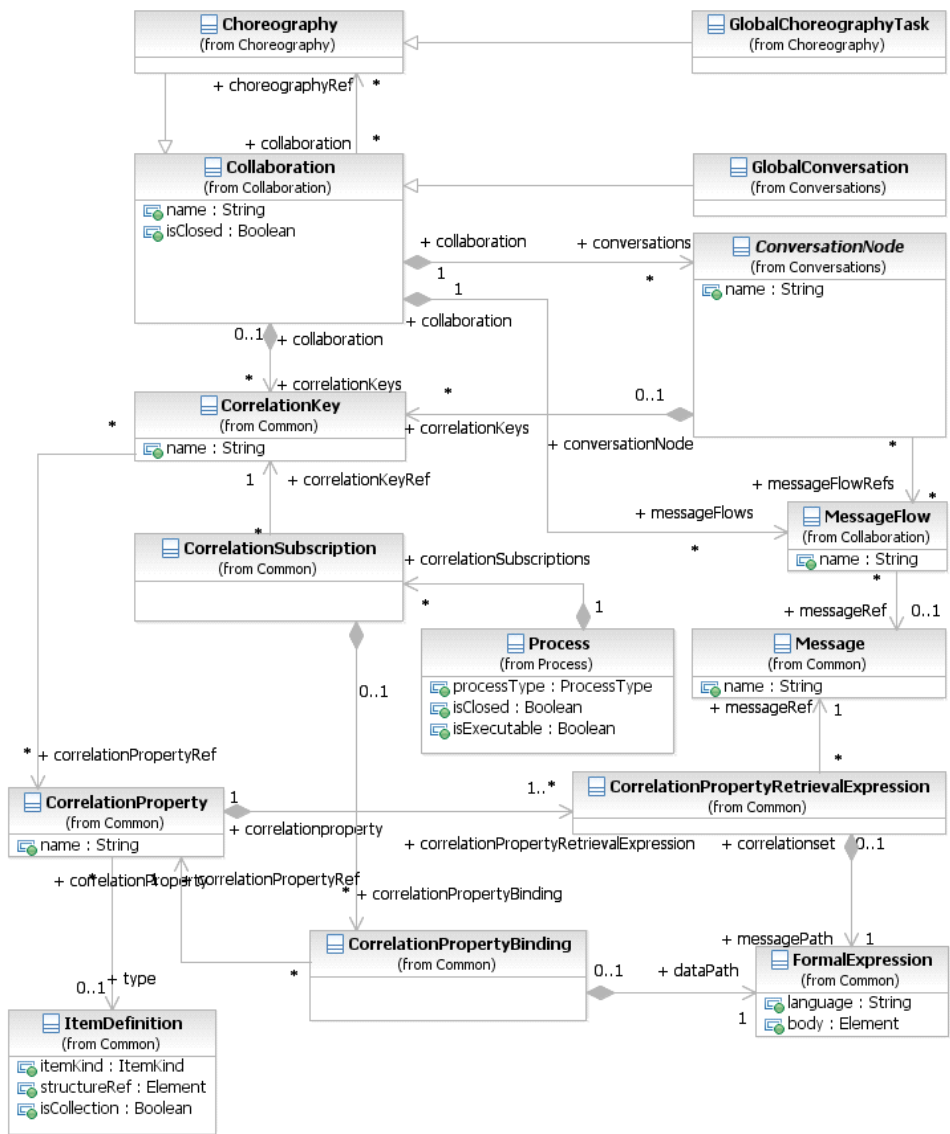

Figure 8.17 – The Correlation Class Diagram

CorrelationKey

A **CorrelationKey** represents a composite key out of one or many **CorrelationProperties** that essentially specify extraction Expressions atop **Messages**. As a result, each **CorrelationProperty** acts as a partial key for the *correlation*. For each **Message** that is exchanged as part of a particular **Conversation**, the **CorrelationProperties** need to provide a **CorrelationPropertyRetrievalExpression** which references a **FormalExpression** to the **Message** payload. That is, for each **Message** (that is used in a **Conversation**) there is an Expression, which extracts portions of the respective **Message's** payload.

The **CorrelationKey** element inherits the attributes and model associations of **BaseElement** (see Table 8.5). Table 8.31 displays the additional model associations of the **CorrelationKey** element.

Table 8.31 – CorrelationKey model associations

Attribute Name	Description/Usage
name: string [0..1]	Specifies the name of the <code>CorrelationKey</code> .
correlationPropertyRef: CorrelationProperty [0..*]	The <code>CorrelationProperties</code> , representing the partial keys of this <code>CorrelationKey</code> .

Key-based Correlation

Key-based *correlation* is a simple and efficient form of *correlation*, where one or more keys are used to identify a **Conversation**. Any incoming **Message** can be matched against the `CorrelationKey` by extracting the `CorrelationProperties` from the **Message** according to the corresponding `CorrelationPropertyRetrievalExpression` and comparing the resulting composite key with the `CorrelationKey` instance for this **Conversation**. The idea is to use a joint **Conversation** “token” which is used (passed to and received from) and *outgoing* and *incoming* **Message**. **Messages** are associated to a particular **Conversation** if the composite key extracted from their payload matches the `CorrelationKey` initialized for this **Conversation**.

At runtime the first **Send Task** or **Receive Task** in a **Conversation** MUST populate at least one of the `CorrelationKey` instances by extracting the values of the `CorrelationProperties` according to the `CorrelationPropertyRetrievalExpression` from the initially sent or received **Message**. Later in the **Conversation**, the populated `CorrelationKey` instances are used for the described matching procedure where from incoming **Messages** a composite key is extracted and used to identify the associated **Conversation**. Where these non-initiating **Messages** derive values for `CorrelationKeys`, associated with the **Conversation** but not yet populated, then the derived value will be associated with the **Conversation** instance.

The `CorrelationProperty` element inherits the attributes and model associations of `BaseElement` (see Table 8.5) through its relationship to `RootElement`. Table 8.32 displays the additional model associations of the `CorrelationProperty` element.

Table 8.32 – CorrelationProperty model associations

Attribute Name	Description/Usage
name: string [0..1]	Specifies the name of the <code>CorrelationProperty</code> .
type: string [0..1]	Specifies the type of the <code>CorrelationProperty</code> .
correlationPropertyRetrieval-Expression: CorrelationPropertyRetrievalExpression [1..*]	The <code>CorrelationPropertyRetrievalExpressions</code> for this <code>CorrelationProperty</code> , representing the associations of <code>FormalExpressions</code> (extraction paths) to specific <code>Messages</code> occurring in this Conversation .

The `CorrelationPropertyRetrievalExpression` element inherits the attributes and model associations of `BaseElement` (see Table 8.5). Table 8.33 displays the additional model associations of the `CorrelationPropertyRetrievalExpression` element.

Table 8.33 – CorrelationPropertyRetrievalExpression model associations

Attribute Name	Description/Usage
messagePath : FormalExpression	The FormalExpression that defines how to extract a CorrelationProperty from the Message payload.
messageRef : Message	The specific Message the FormalExpression extracts the CorrelationProperty from.

Context-based Correlation

Context-based *correlation* is a more expressive form of *correlation* on top of key-based *correlation*. In addition to implicitly populating the CorrelationKey *instance* from the first sent or received **Message**, another mechanism relates the CorrelationKey to the **Process** context. That is, a **Process** MAY provide a CorrelationSubscription that acts as the **Process**-specific counterpart to a specific CorrelationKey. In this way, a **Conversation** MAY additionally refer to explicitly updateable **Process** context data to determine whether or not a **Message** needs to be received. At runtime, the CorrelationKey instance holds a composite key that is dynamically calculated from the **Process** context and automatically updated whenever the underlying **Data Objects** or **Properties** change.

CorrelationPropertyBindings represent the partial keys of a CorrelationSubscription where each relates to a specific CorrelationProperty in the associated CorrelationKey. A FormalExpression defines how that CorrelationProperty *instance* is populated and updated at runtime from the **Process** context (i.e., its **Data Objects** and **Properties**).

The CorrelationSubscription element inherits the attributes and model associations of BaseElement (see Table 8.5). Table 8.34 displays the additional model associations of the CorrelationSubscription element.

Table 8.34 – CorrelationSubscription model associations

Attribute Name	Description/Usage
correlationKeyRef : CorrelationKey	The CorrelationKey this CorrelationSubscription refers to.
correlationPropertyBinding : CorrelationPropertyBinding [0..*]	The bindings to specific CorrelationProperties and FormalExpressions (extraction rules atop the Process context).

The CorrelationPropertyBinding element inherits the attributes and model associations of BaseElement (see Table 8.5). Table 8.35 displays the additional model associations of the CorrelationPropertyBinding element.

Table 8.35 – CorrelationPropertyBinding model associations

Attribute Name	Description/Usage
dataPath: FormalExpression	The FormalExpression that defines the extraction rule atop the Process context.
correlationPropertyRef: CorrelationProperty	The specific CorrelationProperty, this CorrelationPropertyBinding refers to.

At runtime, the correlation mechanism works as follows: When a **Process** instance is created the CorrelationKey instances of all **Conversations** are initialized with some initial values that specify to correlate *any* incoming **Message** for these **Conversations**. A SubscriptionProperty is updated whenever any of the **Data Objects** or **Properties** changes that are referenced from the respective FormalExpression. As a result, incoming **Messages** are matched against the now populated CorrelationKey instance. Later in the **Process** run, the SubscriptionProperties can again change and implicitly change the correlation criterion. Alternatively, the established mechanism of having the first **Send Task** or **Receive Task** populate the CorrelationKey *instance* applies.

XML Schema for Correlation

Table 8.36 – Correlation Key XML schema

```
<xsd:element name="correlationKey" type="tCorrelationKey"/>
<xsd:complexType name="tCorrelationKey">
  <xsd:complexContent>
    <xsd:extension base="tBaseElement">
      <xsd:sequence>
        <xsd:element name="correlationPropertyRef" type="xsd:QName" minOccurs="0" maxOccurs="unbounded"/>
      </xsd:sequence>
      <xsd:attribute name="name" type="xsd:String" use="optional"/>
    </xsd:extension>
  </xsd:complexContent>
</xsd:complexType>
```

Table 8.37 – Correlation Property XML schema

```
<xsd:element name="correlationProperty" type="tCorrelationProperty" substitutionGroup="rootElement"/>
<xsd:complexType name="tCorrelationProperty">
  <xsd:complexContent>
    <xsd:extension base="tRootElement">
      <xsd:sequence>
        <xsd:element ref="correlationPropertyRetrievalExpression" minOccurs="1" maxOccurs="unbounded"/>
      </xsd:sequence>
      <xsd:attribute name="name" type="xsd:String" use="optional"/>
      <xsd:attribute name="type" type="xsd:QName"/>
    </xsd:extension>
  </xsd:complexContent>
</xsd:complexType>
```

```

    </xsd:complexContent>
</xsd:complexType>

```

Table 8.38 – Correlation Property Binding XML schema

```

<xsd:element name="correlationPropertyBinding" type="tCorrelationPropertyBinding"/>
<xsd:complexType name="tCorrelationPropertyBinding">
  <xsd:complexContent>
    <xsd:extension base="tBaseElement">
      <xsd:sequence>
        <xsd:element name="dataPath" type="tFormalExpression" minOccurs="1" maxOccurs="1"/>
      </xsd:sequence>
      <xsd:attribute name="correlationPropertyRef" type="xsd:QName" use="required"/>
    </xsd:extension>
  </xsd:complexContent>
</xsd:complexType>

```

Table 8.39 – Correlation Property Retrieval Expression XML schema

```

<xsd:element name="correlationPropertyRetrievalExpression" type="tCorrelationPropertyRetrievalExpression"/>
<xsd:complexType name="tCorrelationPropertyRetrievalExpression">
  <xsd:complexContent>
    <xsd:extension base="tBaseElement">
      <xsd:sequence>
        <xsd:element name="messagePath" type="tFormalExpression" minOccurs="1" maxOccurs="1"/>
      </xsd:sequence>
      <xsd:attribute name="messageRef" type="xsd:QName" use="required"/>
    </xsd:extension>
  </xsd:complexContent>
</xsd:complexType>

```

Table 8.40 – Correlation Subscription XML schema

```

<xsd:element name="correlationSubscription" type="tCorrelationSubscription"/>
<xsd:complexType name="tCorrelationSubscription">
  <xsd:complexContent>
    <xsd:extension base="tBaseElement">
      <xsd:sequence>
        <xsd:element name="process" type="xsd:QName" use="required"/>
        <xsd:element ref="correlationKeyRef" minOccurs="1" maxOccurs="1"/>
        <xsd:element name="correlationPropertyBinding" type="xsd:QName" minOccurs="0" maxOccurs="unbounded"/>
      </xsd:sequence>
    </xsd:extension>
  </xsd:complexContent>
</xsd:complexType>

```

8.4.3 Error

An **Error** represents the content of an **Error Event** or the **Fault** of a failed **Operation**. An **ItemDefinition** is used to specify the structure of the **Error**. An **Error** is generated when there is a critical problem in the processing of an **Activity** or when the execution of an **Operation** failed.

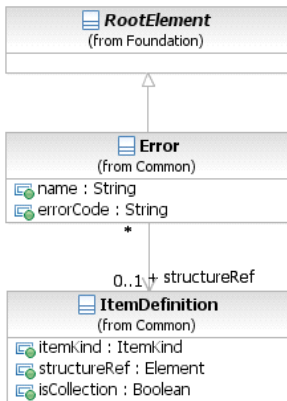

Figure 8.18 – Error class diagram

The **Error** element inherits the attributes and model associations of **BaseElement** (see Table 8.5), through its relationship to **RootElement**. Table 8.41 presents the additional attributes and model associations of the **Error** element.

Table 8.41 – Error attributes and model associations

Attribute Name	Description/Usage
structureRef : ItemDefinition [0..1]	An ItemDefinition is used to define the “payload” of the Error.
name : string	The descriptive name of the Error.
errorCode: string	<p>For an End Event:</p> <p>If the <i>result</i> is an Error, then the errorCode MUST be supplied (if the processType attribute of the Process is set to executable) This “throws” the Error.</p> <p>For an Intermediate Event within <i>normal flow</i>:</p> <p>If the <i>trigger</i> is an Error, then the errorCode MUST be entered (if the processType attribute of the Process is set to executable). This “throws” the Error.</p> <p>For an Intermediate Event attached to the boundary of an Activity:</p> <p>If the <i>trigger</i> is an Error, then the errorCode MAY be entered. This Event “catches” the Error. If there is no errorCode, then any error SHALL trigger the Event. If there is an errorCode, then only an Error that matches the errorCode SHALL trigger the Event.</p>

8.4.4 Escalation

An Escalation identifies a business situation that a **Process** might need to react to. An ItemDefinition is used to specify the structure of the Escalation.

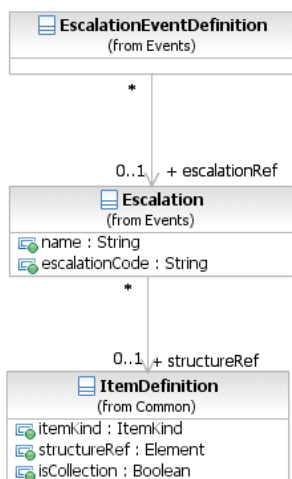

Figure 8.19 – Escalation class diagram

The Escalation element inherits the attributes and model associations of BaseElement (see Table 8.5), through its relationship to RootElement. Table 8.41 presents the additional model associations of the Error element.

Table 8.42 – Escalation attributes and model associations

Attribute Name	Description/Usage
structureRef : ItemDefinition [0..1]	An ItemDefinition is used to define the “payload” of the Escalation.
name : string	The descriptive name of the Escalation.
escalationCode: string	<p>For an End Event:</p> <p>If the Result is an Escalation, then the escalationCode MUST be supplied (if the processType attribute of the Process is set to executable). This “throws” the Escalation.</p> <p>For an Intermediate Event within <i>normal flow</i>:</p> <p>If the <i>trigger</i> is an Escalation, then the escalationCode MUST be entered (if the processType attribute of the Process is set to executable). This “throws” the Escalation.</p> <p>For an Intermediate Event attached to the boundary of an Activity:</p> <p>If the <i>trigger</i> is an Escalation, then the escalationCode MAY be entered. This Event “catches” the Escalation. If there is no escalationCode, then any Escalation SHALL trigger the Event. If there is an escalationCode, then only an Escalation that matches the escalationCode SHALL trigger the Event.</p>

8.4.5 Events

An **Event** is something that happens during the course of a **Process**. These **Events** affect the flow of the **Process** and usually have a cause or an impact. The term event is general enough to cover many things in a **Process**. The start of an **Activity**, the end of an **Activity**, the change of state of a document, a **Message** that arrives, etc., all could be considered **Events**. However, **BPMN** has restricted the use of **Events** to include only those types of **Events** that will affect the sequence or timing of **Activities** of a **Process**.

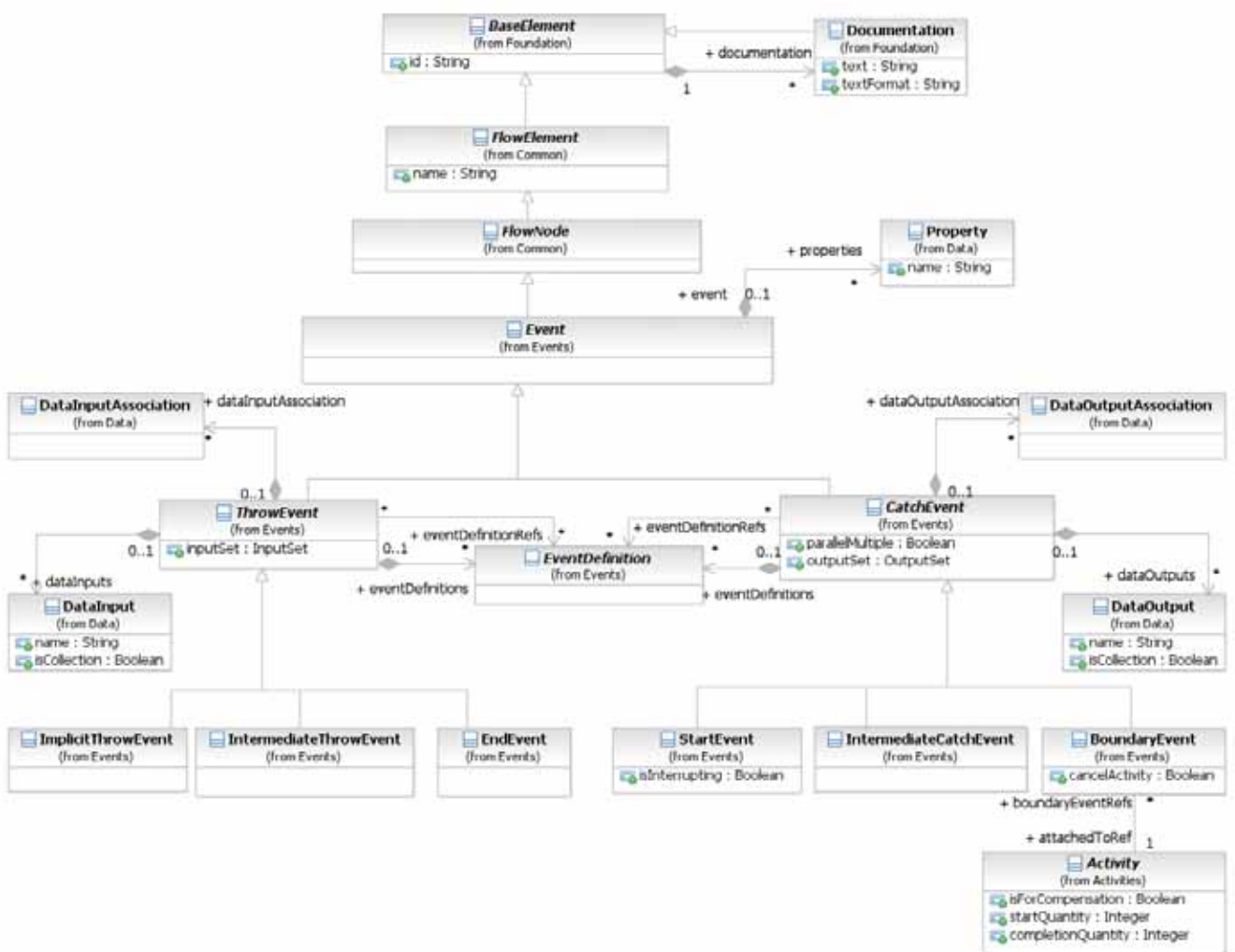

Figure 8.20 – Event class diagram

The **Event** element inherits the attributes and model associations of `FlowElement` (see Table 8.44), but adds no additional attributes or model associations.

The details for the types of **Events** (**Start**, **Intermediate**, and **End**) are defined in “Event Definitions” on page 258.

8.4.6 Expressions

The `Expression` class is used to specify an Expression using natural-language text. These Expressions are not executable. The natural language text is captured using the `documentation` attribute, inherited from `BaseElement`.

`Expression` inherits the attributes and model associations of `BaseElement` (see Table 8.5), but adds no additional attributes or model associations.

Expressions are used in many places within **BPMN** to extract information from the different elements, normally data elements. The most common usage is when modeling decisions, where conditional Expressions are used to direct the flow along specific paths based on some criteria.

BPMN supports underspecified Expressions, where the logic is captured as natural-language descriptive text. It also supports formal Expressions, where the logic is captured in an executable form using a specified Expression language.

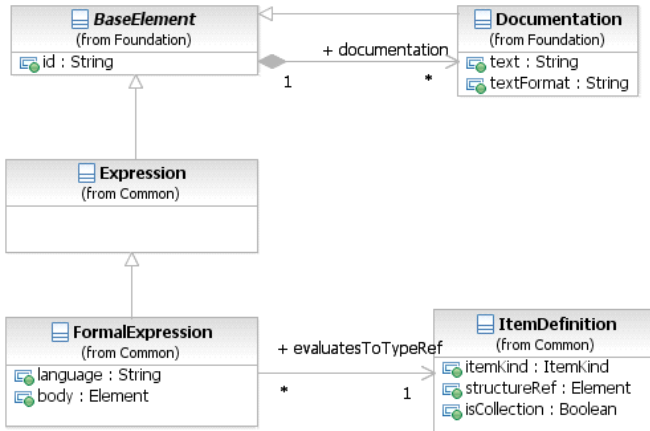

Figure 8.21 – Expression class diagram

Expression

The Expression class is used to specify an Expression using natural-language text. These Expressions are not executable and are considered underspecified.

The definition of an Expression can be done in two ways: it can be contained where it is used, or it can be defined at the **Process** level and then referenced where it is used.

The Expression element inherits the attributes and model associations of BaseElement (see Table 8.5), but does not have any additional attributes or model associations.

Formal Expression

The FormalExpression class is used to specify an executable Expression using a specified Expression language. A natural-language description of the Expression can also be specified, in addition to the formal specification.

The default Expression language for all Expressions is specified in the Definitions element, using the expressionLanguage attribute. It can also be overridden on each individual FormalExpression using the same attribute.

The FormalExpression element inherits the attributes and model associations of BaseElement (see Table 8.5), through the Expression element. Table 8.43 presents the additional attributes and model associations of the FormalExpression.

Table 8.43 – FormalExpression attributes and model associations

Attribute Name	Description/Usage
language: string [0..1]	Overrides the Expression language specified in the Definitions. The language MUST be specified in a URI format.
body: Element	<p>The body of the Expression.</p> <p>Note that this attribute is not relevant when the XML Schema is used for interchange. Instead, the <code>FormalExpression</code> complex type supports mixed content. The body of the Expression would be specified as element content.</p> <p>For example:</p> <pre data-bbox="512 684 1262 795"><formalExpression id="ID_2"> count(../dataObject[id="CustomerRecord_1"]/emailAddress) > 0 <evaluatesToType id="ID_3" typeRef="xsd:boolean"/> </formalExpression></pre>
evaluatesToTypeRef: ItemDefinition	The type of object that this Expression returns when evaluated. For example, <i>conditional</i> Expressions evaluate to a <i>boolean</i> .

8.4.7 Flow Element

`FlowElement` is the abstract super class for all elements that can appear in a **Process** flow, which are `FlowNodes` (see page 99, which consist of **Activities** (see page 149), **Choreography Activities** (see page 319) **Gateways** (see page 285), and **Events** (see page 231), **Data Objects** (see page 204), **Data Associations** (see page 220), and **Sequence Flows** (see page 97).

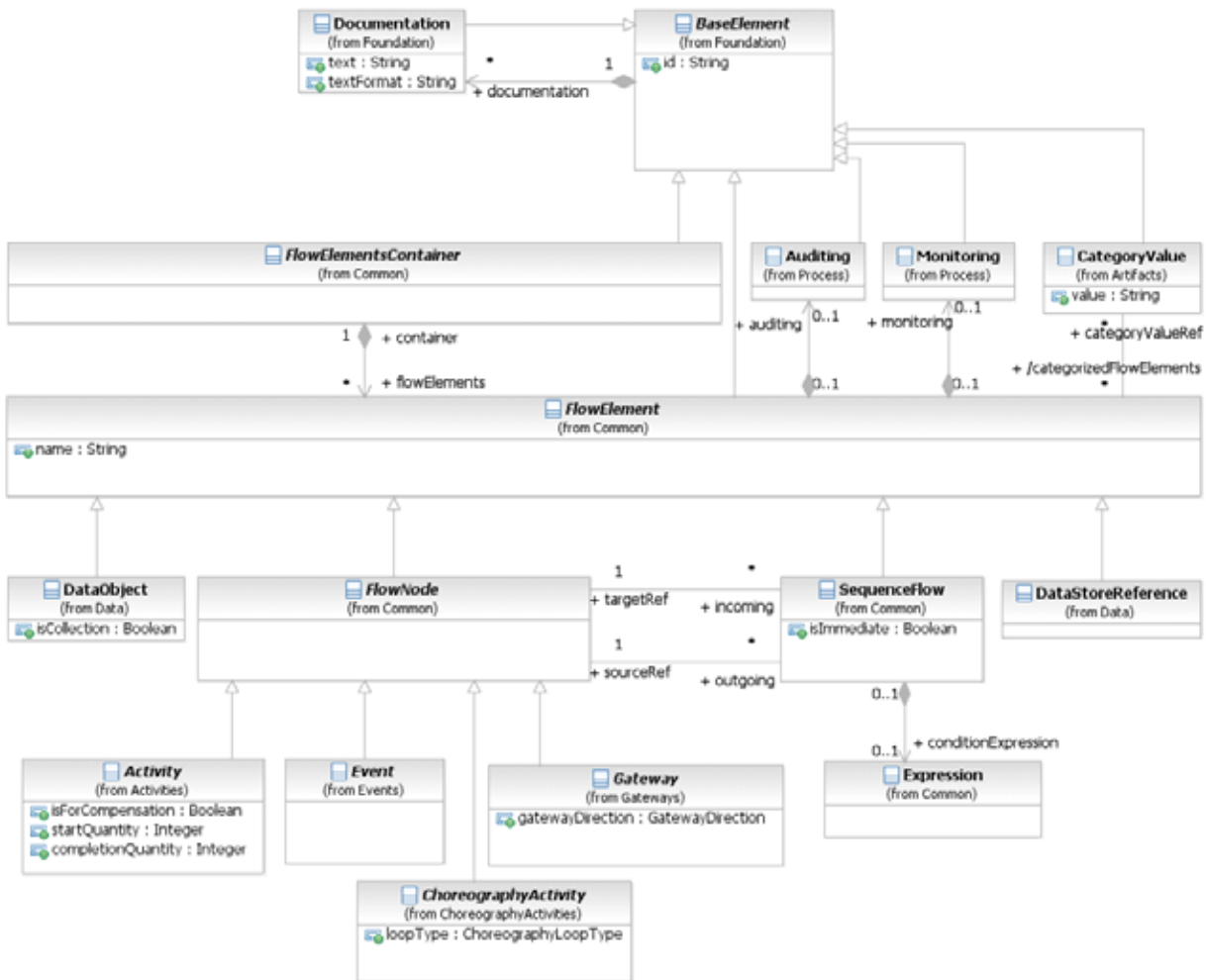

Figure 8.22 – FlowElement class diagram

The FlowElement element inherits the attributes and model associations of BaseElement (see Table 8.5). Table 8.44 presents the additional attributes and model associations of the FlowElement element.

Table 8.44 – FlowElement attributes and model associations

Attribute Name	Description/Usage
name: string [0..1]	The descriptive name of the element.
categoryValueRef: CategoryValue [0..*]	A reference to the <code>Category Values</code> that are associated with this <code>Flow Element</code> .
auditing: Auditing [0..1]	A hook for specifying audit related properties. <code>Auditing</code> can only be defined for a Process .
monitoring: Monitoring [0..1]	A hook for specifying monitoring related properties. <code>Monitoring</code> can only be defined for a Process .

8.4.8 Flow Elements Container

`FlowElementsContainer` is an abstract super class for **BPMN** diagrams (or views) and defines the superset of elements that are contained in those diagrams. Basically, a `FlowElementsContainer` contains `FlowElements`, which are **Events** (see page 231), **Gateways** (see page 285), **Sequence Flows** (see page 97), **Activities** (see page 149), and **Choreography Activities** (see page 319).

There are four (4) types of `FlowElementsContainers` (see Figure 8.23): **Process**, **Sub-Process**, **Choreography**, and **Sub-Choreography**.

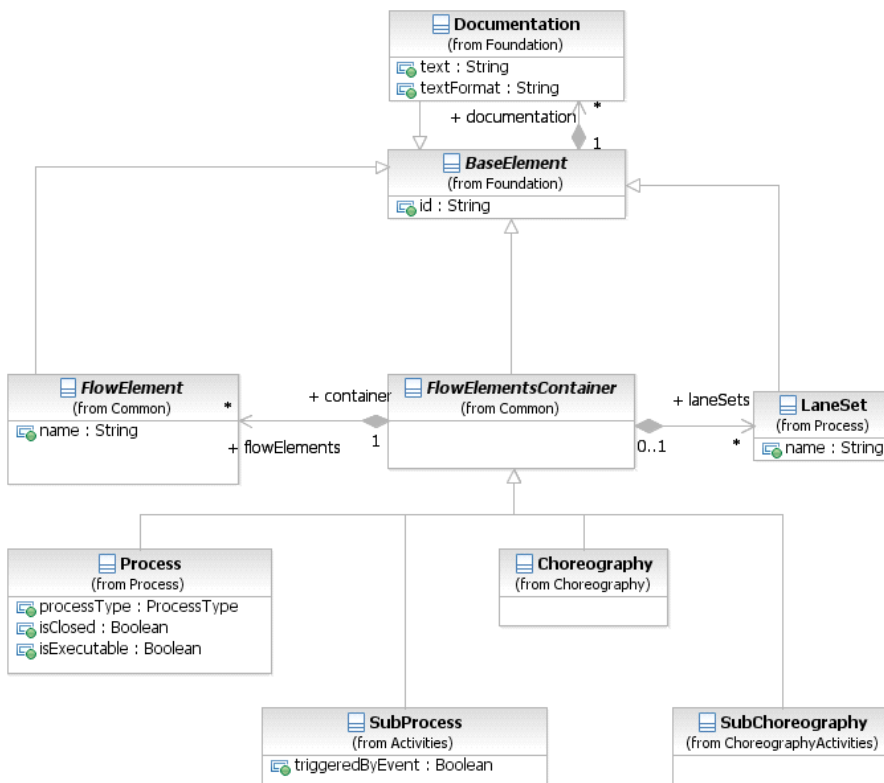

Figure 8.23 – FlowElementContainers class diagram

The FlowElementsContainer element inherits the attributes and model associations of BaseElement (see Table 8.5). Table 8.45 presents the additional model associations of the FlowElementsContainer element.

Table 8.45 – FlowElementsContainer model associations

Attribute Name	Description/Usage
flowElements: Flow Element [0..*]	This association specifies the particular flow elements contained in a FlowElementContainer. <i>Flow elements</i> are Events, Gateways, Sequence Flows, Activities, Data Objects, Data Associations, and Choreography Activities . Note that: <ul style="list-style-type: none"> • Choreography Activities MUST NOT be included as a flowElement for a Process. • Activities, Data Associations, and Data Objects MUST NOT be included as a flowElement for a Choreography.
laneSets: LaneSet [0..*]	This attribute defines the list of LaneSets used in the FlowElementsContainer. LaneSets are not used for Choreographies or Sub-Choreographies .

8.4.9 Gateways

Gateways are used to control how the **Process** flows (how *Tokens* flow) through **Sequence Flows** as they converge and diverge within a **Process**. If the flow does not need to be controlled, then a **Gateway** is not needed. The term “gateway” implies that there is a gating mechanism that either allows or disallows passage through the **Gateway**; that is, as *tokens* arrive at a **Gateway**, they can be merged together on input and/or split apart on output as the **Gateway** mechanisms are invoked.

Gateways, like **Activities**, are capable of consuming or generating additional control *tokens*, effectively controlling the execution semantics of a given **Process**. The main difference is that **Gateways** do not represent ‘work’ being done and they are considered to have zero effect on the operational measures of the **Process** being executed (cost, time, etc.).

The **Gateway** controls the flow of both diverging and converging **Sequence Flows**. That is, a single **Gateway** could have multiple input and multiple output flows. Modelers and modeling tools might want to enforce a best practice of a **Gateway** only performing one of these functions. Thus, it would take two sequential **Gateways** to first converge and then to diverge the **Sequence Flows**.

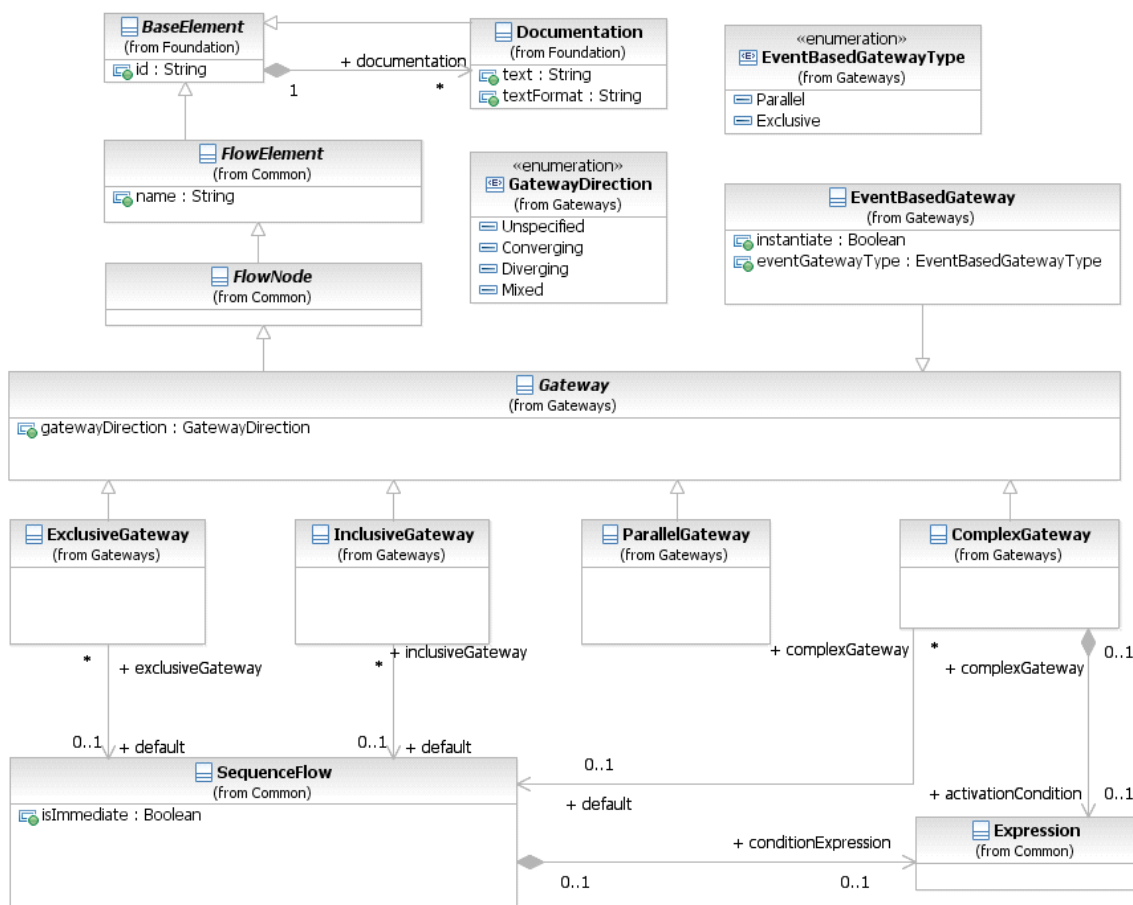

Figure 8.24 – Gateway class diagram

The details for the types of **Gateways** (**Exclusive**, **Inclusive**, **Parallel**, **Event-Based**, and **Complex**) is defined on page 285 for **Processes** and on page 342 for **Choreographies**.

The **Gateway** class is an abstract type. Its concrete subclasses define the specific semantics of individual **Gateway** types, defining how the **Gateway** behaves in different situations.

The **Gateway** element inherits the attributes and model associations of `FlowElement` (see Table 8.44). Table 8.46 presents the additional attributes of the **Gateway** element.

Table 8.46 – Gateway attributes

Attribute Name	Description/Usage
gatewayDirection : GatewayDirection = Unspecified { Unspecified Converging Diverging Mixed }	An attribute that adds constraints on how the Gateway MAY be used. <ul style="list-style-type: none"> • Unspecified: There are no constraints. The Gateway MAY have any number of <i>incoming</i> and <i>outgoing</i> Sequence Flows. • Converging: This Gateway MAY have multiple <i>incoming</i> Sequence Flows but MUST have no more than one (1) <i>outgoing</i> Sequence Flow. • Diverging: This Gateway MAY have multiple <i>outgoing</i> Sequence Flows but MUST have no more than one (1) <i>incoming</i> Sequence Flow. • Mixed: This Gateway contains multiple <i>outgoing</i> and multiple <i>incoming</i> Sequence Flows.

8.4.10 Item Definition

BPMN elements, such as `DataObjects` and `Messages`, represent items that are manipulated, transferred, transformed, or stored during **Process** flows. These items can be either physical items, such as the mechanical part of a vehicle, or information items such the catalog of the mechanical parts of a vehicle.

An important characteristics of items in **Process** is their structure. **BPMN** does not require a particular format for this data structure, but it does designate XML Schema as its default. The `structure` attribute references the actual data structure.

The default format of the data structure for all elements can be specified in the `Definitions` element using the `typeLanguage` attribute. For example, a `typeLanguage` value of <http://www.w3.org/2001/XMLSchema> indicates that the data structures using by elements within that `Definitions` are in the form of XML Schema types. If unspecified, the default is XML schema. An `Import` is used to further identify the location of the data structure (if applicable). For example, in the case of data structures contributed by an XML schema, an `Import` would be used to specify the file location of that schema.

Structure definitions are always defined as separate entities, so they cannot be inlined in one of their usages. You will see that in every mention of structure definition there is a “reference” to the element. This is why this class inherits from `RootElement`.

An `ItemDefinition` element can specify an import reference where the proper definition of the structure is defined.

In cases where the data structure represents a collection, the multiplicity can be projected into the attribute `isCollection`. If this attribute is set to “*true*,” but the actual type is not a collection type, the model is considered as invalid. **BPMN** compliant tools might support an automatic check for these inconsistencies and report this as an error. The default value for this element is “*false*.”

The `itemKind` attribute specifies the nature of an item which can be a physical or an information item.

Figure 8.25 shows the `ItemDefinition` class diagram. When an `ItemDefinition` is defined it is contained in `Definitions`.

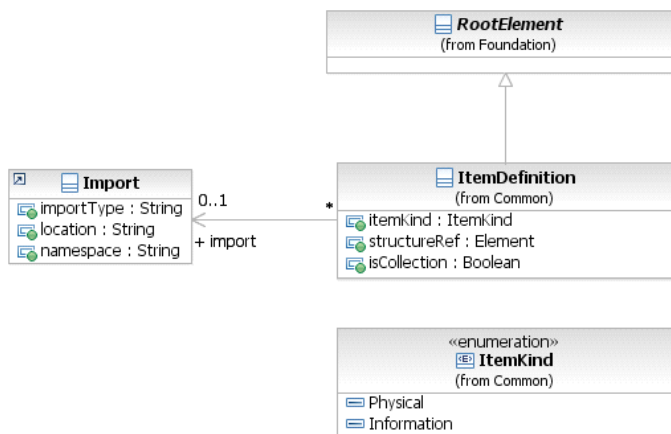

Figure 8.25 – ItemDefinition class diagram

The `ItemDefinition` element inherits the attributes and model associations `BaseElement` (see Table 8.5) through its relationship to `RootElement`. Table 8.47 presents the additional attributes and model associations for the `ItemDefinition` element.

Table 8.47 – ItemDefinition attributes & model associations

Attribute Name	Description/Usage
itemKind: ItemKind = Information { Information Physical }	This defines the nature of the Item. Possible values are <i>physical</i> or <i>information</i> . The default value is <i>information</i> .
structureRef: [Element [0..1]]	The concrete data structure to be used.
import: Import [0..1]	Identifies the location of the data structure and its format. If the <code>importType</code> attribute is left unspecified, the <code>typeLanguage</code> specified in the <code>Definitions</code> that contains this <code>ItemDefinition</code> is assumed.
isCollection: boolean = False	Setting this flag to <i>true</i> indicates that the actual data type is a collection.

8.4.11 Message

A **Message** represents the content of a communication between two *Participants*. In **BPMN 2.0.1**, a **Message** is a graphical decorator (it was a supporting element in **BPMN 1.2**). An *ItemDefinition* is used to specify the **Message** structure.

When displayed in a diagram:

- ◆ In a **Message** is a rectangle with converging diagonal lines in the upper half of the rectangle to give the appearance of an envelope (see Figure 8.26). It **MUST** be drawn with a single thin line.
- ◆ The use of text, color, size, and lines for a **Message** **MUST** follow the rules defined in “Use of Text, Color, Size, and Lines in a Diagram” on page 39.



Figure 8.26 – A Message

In addition, when used in a **Choreography** Diagram more than one **Message** **MAY** be used for a single **Choreography Task**. In this case, it is important to know the first (initiating) **Message** of the interaction. For return (non-initiating) **Messages** the symbol of the **Message** is shaded with a light fill (see Figure 8.27).



Figure 8.27 – A non-initiating Message

- ◆ Any **Message** sent by the non-initiating *Participant* or **Sub-Choreography** **MUST** be shaded with a light fill.

In a **Collaboration**, the communication itself is represented by a **Message Flow** (see “Message Flow” below for more details). The **Message** can be optionally depicted as a graphical decorator on a **Message Flow** in a **Collaboration** (see Figure 8.28 and Figure 8.29).

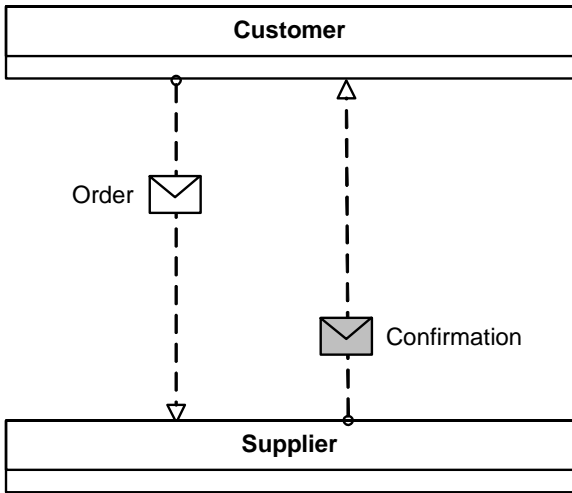

Figure 8.28 – Messages Association overlapping Message Flows

In a **Choreography**, the communication is represented by a **Choreography Task** (see page 321). The **Message** can be depicted as a decorator with a **Choreography Task** in a **Choreography** (see Figure 8.29).

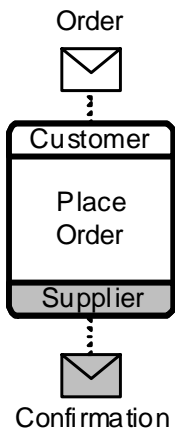

Figure 8.29 – Messages shown Associated with a Choreography Task

Figure 8.30 displays the class diagram showing the attributes and model associations for the **Message** element.

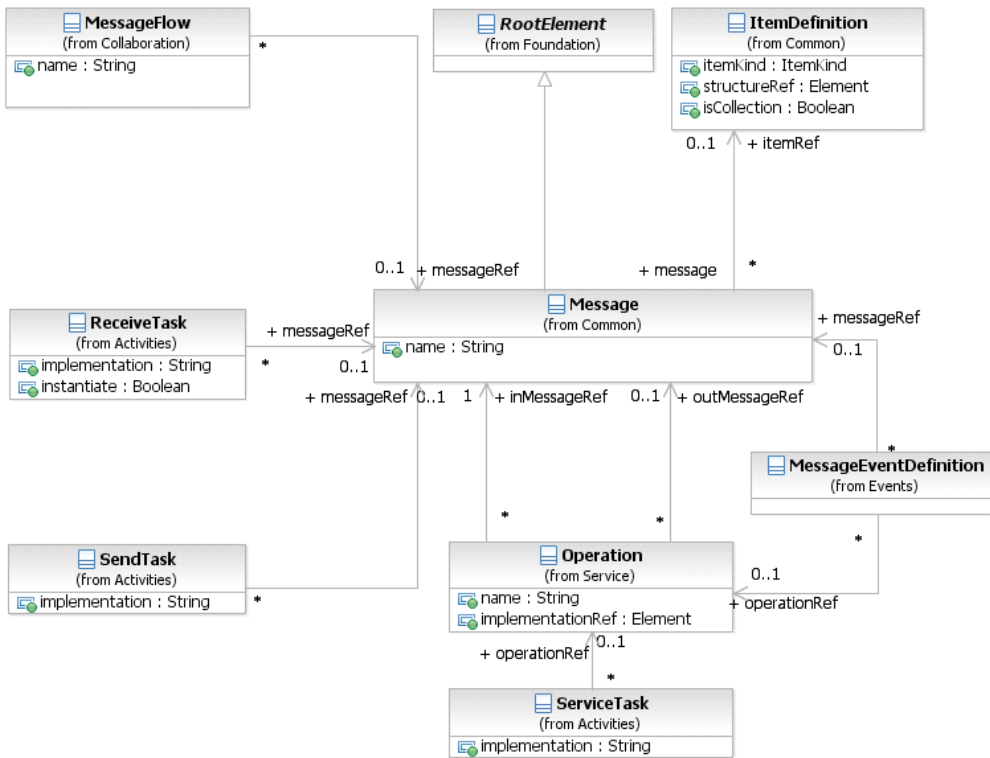

Figure 8.30 – The Message class diagram

The **Message** element inherits the attributes and model associations of BaseElement (see Table 8.5) through its relationship to RootElement. Table 8.48 presents the additional attributes and model associations for the **Message** element.

Table 8.48 – Message attributes and model associations

Attribute Name	Description/Usage
name: string	Name is a text description of the Message .
itemRef : ItemDefinition [0..1]	An ItemDefinition is used to define the “payload” of the Message .

8.4.12 Resources

The Resource class is used to specify resources that can be referenced by **Activities**. These Resources can be Human Resources as well as any other resource assigned to **Activities** during **Process** execution time.

The definition of a Resource is “abstract,” because it only defines the Resource, without detailing how e.g., actual user IDs are associated at runtime. Multiple **Activities** can utilize the same Resource.

Every Resource can define a set of ResourceParameters. These parameters can be used at runtime to define query e.g., into an Organizational Directory. Every **Activity** referencing a parameterized Resource can bind values available in the scope of the **Activity** to these parameters.

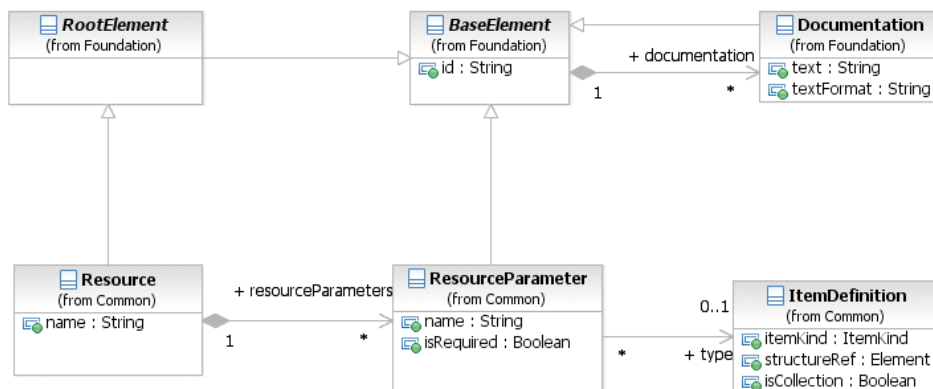

Figure 8.31 – Resource class diagram

The Resource element inherits the attributes and model associations of BaseElement (see Table 8.5) through its relationship to RootElement. Table 8.51 presents the additional model associations for the Resource element.

Table 8.49 – Resource attributes and model associations

Attribute Name	Description/Usage
name: string	This attribute specifies the name of the Resource.
resourceParameters: ResourceParameter [0..*]	This model association specifies the definition of the parameters needed at runtime to resolve the Resource.

As mentioned before, the Resource can define a set of parameters to define a query to resolve the actual resources (e.g., user ids).

The ResourceParameter element inherits the attributes and model associations of BaseElement (see Table 8.5) through its relationship to RootElement. Table 8.51 presents the additional model associations for the ResourceParameter element.

Table 8.50 – ResourceParameter attributes and model associations

Attribute Name	Description/Usage
name: string	Specifies the name of the query parameter.
type: ItemDefinition	Specifies the type of the query parameter.
isRequired: boolean	Specifies, if a parameter is optional or mandatory.

8.4.13 Sequence Flow

A **Sequence Flow** is used to show the order of Flow Elements in a **Process** or a **Choreography**. Each **Sequence Flow** has only one *source* and only one *target*. The *source* and *target* MUST be from the set of the following Flow Elements: **Events** (**Start**, **Intermediate**, and **End**), **Activities** (**Task** and **Sub-Process**; for **Processes**), **Choreography Activities** (**Choreography Task** and **Sub-Choreography**; for **Choreographies**), and **Gateways**.

- ◆ A **Sequence Flow** is line with a solid arrowhead that MUST be drawn with a solid single line (as seen in Figure 8.32).
- ◆ The use of text, color, size, and lines for a **Sequence Flow** MUST follow the rules defined in “Use of Text, Color, Size, and Lines in a Diagram” on page 39.



Figure 8.32 – A Sequence Flow

A **Sequence Flow** can optionally define a condition Expression, indicating that the *token* will be passed down the **Sequence Flow** only if the Expression evaluates to *true*. This Expression is typically used when the source of the **Sequence Flow** is a **Gateway** or an **Activity**.

- ◆ A *conditional outgoing Sequence Flow* from an **Activity** MUST be drawn with a mini-diamond marker at the beginning of the connector (as seen in Figure 8.33).
- ◆ If a *conditional Sequence Flow* is used from a source **Activity**, then there MUST be at least one other *outgoing Sequence Flow* from that **Activity**.
- ◆ *Conditional outgoing Sequence Flows* from a **Gateway** MUST NOT be drawn with a mini-diamond marker at the beginning of the connector.
- ◆ A source **Gateway** MUST NOT be of type **Parallel** or **Event**.



Figure 8.33 – A Conditional Sequence Flow

A **Sequence Flow** that has an **Exclusive**, **Inclusive**, or **Complex Gateway** or an **Activity** as its source can also be defined with as *default*. Such a **Sequence Flow** will have a marker to show that it is a *default* flow. The *default Sequence Flow* is taken (a token is passed) only if all the other outgoing **Sequence Flows** from the **Activity** or **Gateway** are not valid (i.e., their condition **Expressions** are *false*).

- ◆ A *default outgoing Sequence Flow* **MUST** be drawn with a slash marker at the beginning of the connector (as seen in Figure 8.34).



Figure 8.34 – A Default Sequence Flow

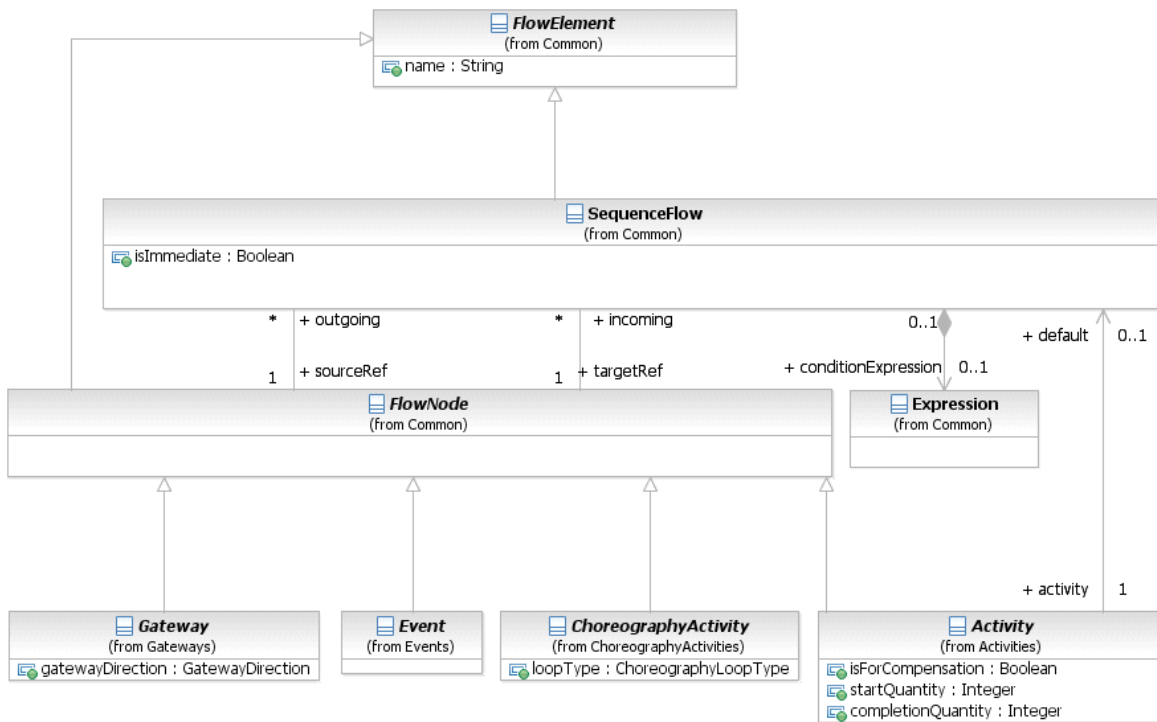

Figure 8.35 – SequenceFlow class diagram

The **Sequence Flow** element inherits the attributes and model associations of **FlowElement** (see Table 8.44). Table 8.51 presents the additional attributes and model associations of the **Sequence Flow** element.

Table 8.51 – SequenceFlow attributes and model associations

Attribute Name	Description/Usage
sourceRef: FlowNode	The FlowNode that the Sequence Flow is connecting from. For a Process : Of the types of FlowNode, only Activities , Gateways , and Events can be the <i>source</i> . However, Activities that are Event Sub-Processes are not allowed to be a <i>source</i> . For a Choreography : Of the types of FlowNode, only Choreography Activities , Gateways , and Events can be the <i>source</i> .
targetRef: FlowNode	The FlowNode that the Sequence Flow is connecting to. For a Process : Of the types of FlowNode, only Activities , Gateways , and Events can be the target. However, Activities that are Event Sub-Processes are not allowed to be a target. For a Choreography : Of the types of FlowNode, only Choreography Activities , Gateways , and Events can be the target.
conditionExpression: Expression [0..1]	An optional boolean Expression that acts as a gating condition. A <i>token</i> will only be placed on this Sequence Flow if this conditionExpression evaluates to true.
isImmediate: boolean [0..1]	An optional boolean value specifying whether Activities or Choreography Activities not in the model containing the Sequence Flow can occur between the elements connected by the Sequence Flow . If the value is true, they MAY NOT occur. If the value is false, they MAY occur. Also see the isClosed attribute on Process, Choreography, and Collaboration. When the attribute has no value, the default semantics depends on the kind of model containing Sequence Flows : <ul style="list-style-type: none"> • For non-executable Processes (public Processes and non-executable private Processes) and Choreographies no value has the same semantics as if the value were <i>false</i>. • For an executable Processes no value has the same semantics as if the value were <i>true</i>. • For executable Processes, the attribute MUST NOT be <i>false</i>.

Flow Node

The FlowNode element is used to provide a single element as the source and target **Sequence Flow** associations (see Figure 8.35) instead of the individual associations of the elements that can connect to **Sequence Flows** (see above). Only the **Gateway**, **Activity**, **Choreography Activity**, and **Event** elements can connect to **Sequence Flows** and thus, these elements are the only ones that are sub-classes of FlowNode.

Since **Gateway**, **Activity**, **Choreography Activity**, and **Event** have their own attributes, model associations, and inheritances; the FlowNode element does not inherit from any other **BPMN** element. Table 8.52 presents the additional model associations of the FlowNode element.

Table 8.52 – FlowNode model associations

Attribute Name	Description/Usage
incoming: Sequence Flow [0..*]	This attribute identifies the <i>incoming Sequence Flow</i> of the FlowNode.
outgoing: Sequence Flow [0..*]	This attribute identifies the <i>outgoing Sequence Flow</i> of the FlowNode. This is an ordered collection.

8.4.14 Common Package XML Schemas

Table 8.53 – Error XML schema

```
<xsd:element name="error" type="tError" substitutionGroup="rootElement"/>
<xsd:complexType name="tError">
  <xsd:complexContent>
    <xsd:extension base="tRootElement">
      <xsd:attribute name="name" type="xsd:string"/>
      <xsd:attribute name="errorCode" type="xsd:string"/>
      <xsd:attribute name="structureRef" type="xsd:QName"/>
    </xsd:extension>
  </xsd:complexContent>
</xsd:complexType>
```

Table 8.54 – Escalation XML schema

```
<xsd:element name="escalation" type="tEscalation" substitutionGroup="rootElement"/>
<xsd:complexType name="tEscalation">
  <xsd:complexContent>
    <xsd:extension base="tRootElement">
      <xsd:attribute name="name" type="xsd:string"/>
      <xsd:attribute name="escalationCode" type="xsd:string"/>
      <xsd:attribute name="structureRef" type="xsd:QName"/>
    </xsd:extension>
  </xsd:complexContent>
</xsd:complexType>
```

Table 8.55 – Expression XML schema

```
<xsd:element name="expression" type="tExpression"/>
<xsd:complexType name="tExpression">
  <xsd:complexContent>
    <xsd:extension base="tBaseElementWithMixedContent"/>
  </xsd:complexContent>
</xsd:complexType>
```

Table 8.56 – FlowElement XML schema

```
<xsd:element name="flowElement" type="tFlowElement"/>
<xsd:complexType name="tFlowElement" abstract="true">
  <xsd:complexContent>
    <xsd:extension base="tBaseElement">
      <xsd:sequence>
        <xsd:element ref="auditing" minOccurs="0" maxOccurs="1"/>
        <xsd:element ref="monitoring" minOccurs="0" maxOccurs="1"/>
        <xsd:element name="categoryValueRef" type="xsd:QName" minOccurs="0" maxOccurs="unbounded"/>
      </xsd:sequence>
      <xsd:attribute name="name" type="xsd:string"/>
    </xsd:extension>
  </xsd:complexContent>
</xsd:complexType>
```

Table 8.57 – FlowNode XML schema

```
<xsd:element name="flowNode" type="tFlowNode"/>
<xsd:complexType name="tFlowNode" abstract="true">
  <xsd:complexContent>
    <xsd:extension base="tFlowElement">
      <xsd:sequence>
        <xsd:element name="incoming" type="xsd:QName" minOccurs="0" maxOccurs="unbounded"/>
        <xsd:element name="outgoing" type="xsd:QName" minOccurs="0" maxOccurs="unbounded"/>
      </xsd:sequence>
    </xsd:extension>
  </xsd:complexContent>
</xsd:complexType>
```

Table 8.58– FormalExpression XML schema

```
<xsd:element name="formalExpression" type="tFormalExpression" substitutionGroup="expression"/>
<xsd:complexType name="tFormalExpression">
  <xsd:complexContent>
    <xsd:extension base="tExpression">
      <xsd:attribute name="language" type="xsd:anyURI" use="optional"/>
      <xsd:attribute name="evaluatesToTypeRef" type="xsd:QName"/>
    </xsd:extension>
  </xsd:complexContent>
</xsd:complexType>
```

Table 8.59 – InputOutputBinding XML schema

```
<xsd:element name="ioBinding" type="tinputOutputBinding"/>
<xsd:complexType name="tinputOutputBinding">
  <xsd:complexContent>
    <xsd:extension base="tBaseElement">
      <xsd:attribute name="inputDataRef" type="xsd:IDREF"/>
    </xsd:extension>
  </xsd:complexContent>
</xsd:complexType>
```

```

        <xsd:attribute name="outputDataRef" type="xsd:IDREF"/>
        <xsd:attribute name="operationRef" type="xsd:QName"/>
    </xsd:extension>
</xsd:complexContent>
</xsd:complexType>

```

Table 8.60 – ItemDefinition XML schema

```

<xsd:element name="itemDefinition" type="tItemDefinition" substitutionGroup="rootElement"/>
<xsd:complexType name="tItemDefinition">
    <xsd:complexContent>
        <xsd:extension base="tRootElement">
            <xsd:attribute name="structureRef" type="xsd:QName"/>
            <xsd:attribute name="isCollection" type="xsd:boolean" default="false"/>
            <xsd:attribute name="itemKind" type="tItemKind" default="Information"/>
        </xsd:extension>
    </xsd:complexContent>
</xsd:complexType>

<xsd:simpleType name="tItemKind">
    <xsd:restriction base="xsd:string">
        <xsd:enumeration value="Information"/>
        <xsd:enumeration value="Physical"/>
    </xsd:restriction>
</xsd:simpleType>

```

Table 8.61 – Message XML schema

```

<xsd:element name="message" type="tMessage" substitutionGroup="rootElement"/>
<xsd:complexType name="tMessage">
    <xsd:complexContent>
        <xsd:extension base="tRootElement">
            <xsd:attribute name="name" type="xsd:string"/>
            <xsd:attribute name="itemRef" type="xsd:QName"/>
        </xsd:extension>
    </xsd:complexContent>
</xsd:complexType>

```

Table 8.62 – Resources XML schema

```

<xsd:element name="resource" type="tResource" substitutionGroup="rootElement"/>
<xsd:complexType name="tResource">
    <xsd:complexContent>
        <xsd:extension base="tRootElement">
            <xsd:sequence>
                <xsd:element ref="resourceParameter" minOccurs="0" maxOccurs="unbounded"/>
            </xsd:sequence>
            <xsd:attribute name="name" type="xsd:string" use="required"/>
        </xsd:extension>
    </xsd:complexContent>
</xsd:complexType>

```

```
</xsd:complexContent>
</xsd:complexType>
```

Table 8.63 – ResourceParameter XML schema

```
<xsd:element name="resourceParameter" type="tResourceParameter" />
<xsd:complexType name="tResourceParameter">
  <xsd:complexContent>
    <xsd:extension base="tBaseElement">
      <xsd:attribute name="name" type="xsd:string"/>
      <xsd:attribute name="type" type="xsd:QName"/>
      <xsd:attribute name="isRequired" type="xsd:Boolean" />
    </xsd:extension>
  </xsd:complexContent>
</xsd:complexType>
```

Table 8.64 – SequenceFlow XML schema

```
<xsd:element name="sequenceFlow" type="tSequenceFlow" substitutionGroup="flowElement"/>
<xsd:complexType name="tSequenceFlow">
  <xsd:complexContent>
    <xsd:extension base="tFlowElement">
      <xsd:sequence>
        <xsd:element name="conditionExpression" type="tExpression" minOccurs="0" maxOccurs="1"/>
      </xsd:sequence>
      <xsd:attribute name="sourceRef" type="xsd:IDREF" use="required"/>
      <xsd:attribute name="targetRef" type="xsd:IDREF" use="required"/>
      <xsd:attribute name="isImmediate" type="xsd:boolean" use="optional"/>
    </xsd:extension>
  </xsd:complexContent>
</xsd:complexType>
```

8.5 Services

The Service package contains constructs necessary for modeling services, interfaces, and operations.

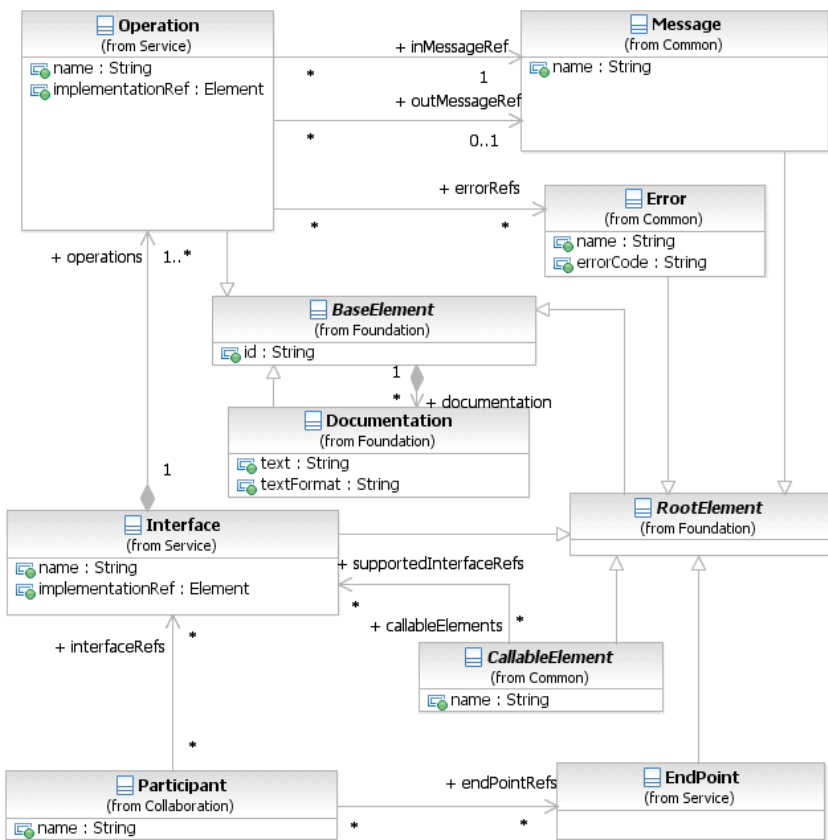

Figure 8.36 – The Service class diagram

8.5.1 Interface

An Interface defines a set of operations that are implemented by Services.

The Interface inherits the attributes and model associations of BaseElement (see Table 8.5) through its relationship to RootElement. Table 8.65 presents the additional attributes and model associations of the Interface.

Table 8.65 – Interface attributes and model associations

Attribute Name	Description/Usage
name: string	The descriptive name of the element.
operations: Operation [1..*]	This attribute specifies operations that are defined as part of the Interface. An Interface has at least one Operation.
callableElements: CallableElement [0..*]	The CallableElements that use this Interface.
implementationRef: Element [0..1]	This attribute allows to reference a concrete artifact in the underlying implementation technology representing that interface, such as a WSDL porttype.

8.5.2 EndPoint

The actual definition of the service address is out of scope of **BPMN 2.0**. The EndPoint element is an extension point and extends from RootElement. The EndPoint element MAY be extended with endpoint reference definitions introduced in other specifications (e.g., WS-Addressing).

EndPoints can be specified for *Participants*.

8.5.3 Operation

An Operation defines **Messages** that are consumed and, optionally, produced when the Operation is called. It can also define zero or more errors that are returned when operation fails. The Operation inherits the attributes and model associations of BaseElement (see Table 8.5). Table 8.66 below presents the additional attributes and model associations of the Operation.

Table 8.66 – Operation attributes and model associations

Attribute Name	Description/Usage
name: string	The descriptive name of the element.
inMessageRef: Message	This attribute specifies the input Message of the Operation. An Operation has exactly one input Message .
outMessageRef: Message [0..1]	This attribute specifies the output Message of the Operation. An Operation has at most one input Message .
errorRef: Error [0..*]	This attribute specifies errors that the Operation may return. An Operation MAY refer to zero or more Error elements.
implementationRef: Element [0..1]	This attribute allows to reference a concrete artifact in the underlying implementation technology representing that operation, such as a WSDL operation.

8.5.4 Service Package XML Schemas

Table 8.67 – Interface XML schema

```

<xsd:element name="interface" type="tInterface" substitutionGroup="rootElement"/>
<xsd:complexType name="tInterface">
  <xsd:complexContent>
    <xsd:extension base="tRootElement">
      <xsd:sequence>
        <xsd:element ref="operation" minOccurs="1" maxOccurs="unbounded"/>
      </xsd:sequence>
      <xsd:attribute name="name" type="xsd:string" use="required"/>
      <xsd:attribute name="implementationRef" type="xsd:QName" use="optional"/>
    </xsd:extension>
  </xsd:complexContent>
</xsd:complexType>

```

Table 8.68 – Operation XML schema

```

<xsd:element name="operation" type="tOperation"/>
<xsd:complexType name="tOperation">
  <xsd:complexContent>
    <xsd:extension base="tBaseElement">
      <xsd:sequence>
        <xsd:element name="inMessageRef" type="xsd:QName" minOccurs="1" maxOccurs="1"/>
        <xsd:element name="outMessageRef" type="xsd:QName" minOccurs="0" maxOccurs="1"/>
        <xsd:element name="errorRef" type="xsd:QName" minOccurs="0" maxOccurs="unbounded"/>
      </xsd:sequence>
      <xsd:attribute name="name" type="xsd:string" use="required"/>
      <xsd:attribute name="implementationRef" type="xsd:QName" use="optional"/>
    </xsd:extension>
  </xsd:complexContent>
</xsd:complexType>

```

```
</xsd:complexContent>  
</xsd:complexType>
```

Table 8.69 – EndPoint XML schema

```
<xsd:element name="endPoint" type="tEndPoint"/>  
<xsd:complexType name="tEndPoint">  
  <xsd:complexContent>  
    <xsd:extension base="tRootElement"/>  
  </xsd:complexContent>  
</xsd:complexType>
```

9 Collaboration

9.1 General

NOTE: The contents of this clause are REQUIRED for **BPMN Choreography Modeling Conformance**, **BPMN Process Modeling Conformance**, or for **BPMN Complete Conformance**. However, this clause is NOT REQUIRED for **BPMN Process Execution Conformance** or **BPMN BPEL Process Execution Conformance**. For more information about **BPMN** conformance types, see page 1.

The `Collaboration` package contains classes that are used for modeling **Collaborations**, which is a collection of *Participants* shown as **Pools**, their interactions as shown by **Message Flows**, and MAY include **Processes** within the **Pools** and/or **Choreographies** between the **Pools** (see Figure 9.1). A **Choreography** is an extended type of **Collaboration**. When a **Collaboration** is defined it is contained in `Definitions`.

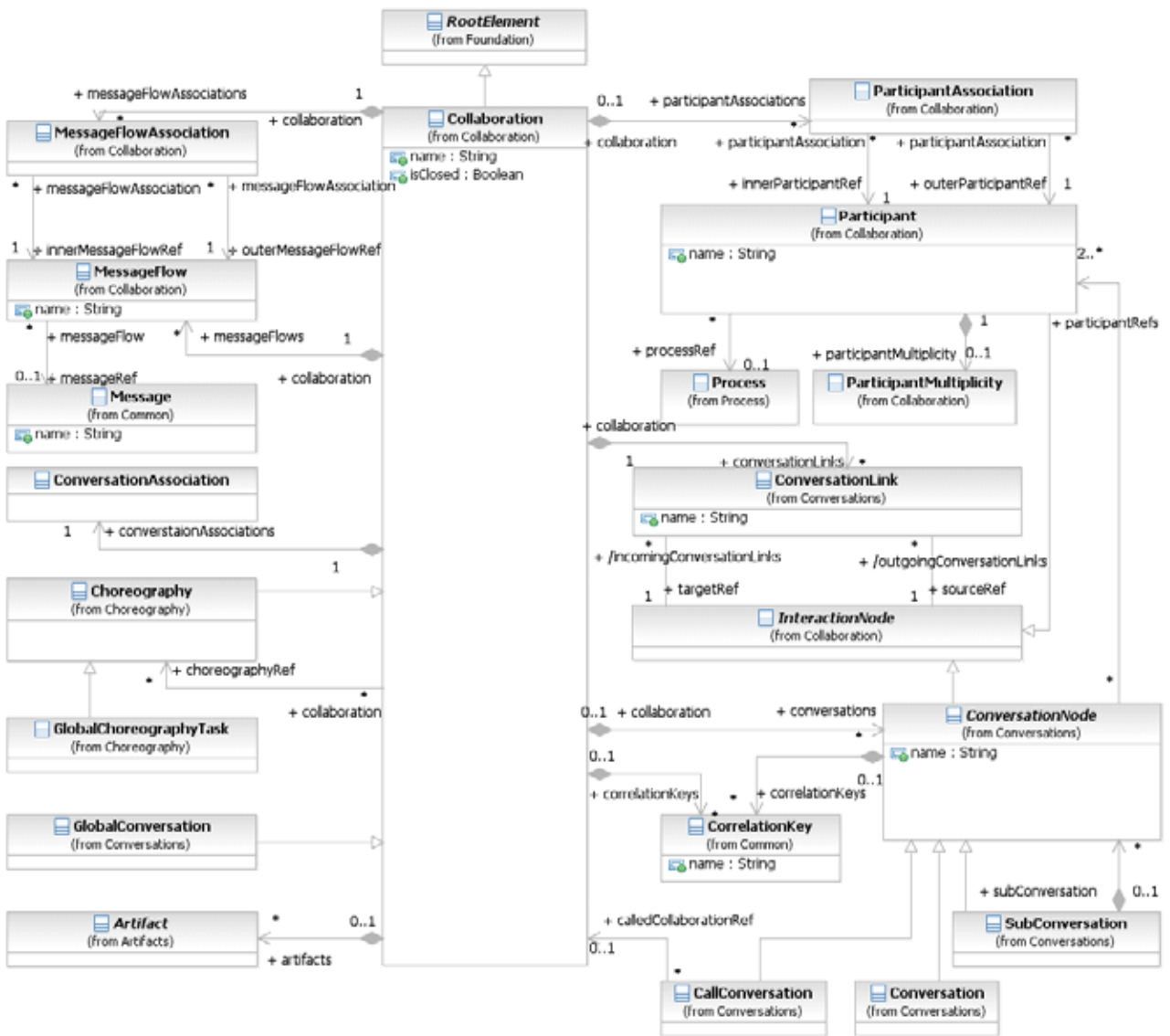

Figure 9.1 – Classes in the Collaboration package

The **Collaboration** element inherits the attributes and model associations of **BaseElement** (see Table 8.5) through its relationship to **RootElement**. Table 9.1 presents the additional attributes and model associations for the **Collaboration** element.

Table 9.1 – Collaboration Attributes and Model Associations

Attribute Name	Description/Usage
name: string	Name is a text description of the Collaboration .

Table 9.1 – Collaboration Attributes and Model Associations

<p>choreographyRef: Choreography [0..*]</p>	<p>The choreographyRef model association defines the Choreographies that can be shown between the Pools of the Collaboration. A Choreography specifies a business contract (or the order in which messages will be exchanged) between interacting <i>Participants</i>. See page 315 for more details on Choreography.</p> <p>The <i>participantAssociations</i> (see below) are used to map the <i>Participants</i> of the Choreography to the <i>Participants</i> of the Collaboration.</p> <p>The <i>MessageFlowAssociations</i> (see below) are used to map the Message Flows of the Choreography to the Message Flows of the Collaboration.</p> <p>The <i>conversationAssociations</i> (see below) are used to map the Conversations of the Choreography to the Conversations of the Collaboration.</p> <p>Note that this attribute is not applicable for Choreography or <i>GlobalConversation</i> which are a subtypes of Collaboration. Thus, a Choreography cannot reference another Choreography.</p>
<p>correlationKeys: CorrelationKey [0..*]</p>	<p>This association specifies <i>CorrelationKeys</i> used to associate Messages to a particular Collaboration.</p>
<p>conversationAssociations: ConversationAssociation [0..*]</p>	<p>This attribute provides a list of mappings from the Conversations of a referenced Collaboration to the Conversations of another Collaboration. It is used when:</p> <ul style="list-style-type: none"> • When a Choreography is referenced by a Collaboration.
<p>conversations: ConversationNode [0..*]</p>	<p>The <i>conversations</i> model aggregation relationship allows a Collaboration to contain Conversation elements, in order to group Message Flows of the Collaboration and associate <i>correlation</i> information, as is REQUIRED for the <i>definitional</i> Collaboration of a Process model. The Conversation elements will be visualized if the Collaboration is a Collaboration, but not for a Choreography.</p>
<p>conversationLinks: ConversationLink [0..*]</p>	<p>This provides the Conversation Links that are used in the Collaboration.</p>
<p>artifacts: Artifact [0..*]</p>	<p>This attribute provides the list of <i>Artifacts</i> that are contained within the Collaboration.</p>
<p>participants: Participant [0..*]</p>	<p>This provides the list of <i>Participants</i> that are used in the Collaboration. <i>Participants</i> are visualized as Pools in a Collaboration and as Participant Bands in Choreography Activities in a Choreography.</p>

Table 9.1 – Collaboration Attributes and Model Associations

<p>participantAssociations: ParticipantAssociations [0..*]</p>	<p>This attribute provides a list of mappings from the <i>Participants</i> of a referenced Collaboration to the <i>Participants</i> of another Collaboration. It is used in the following situations</p> <ul style="list-style-type: none"> • When a Choreography is referenced by the Collaboration. • When a <i>definitional Collaboration</i> for a Process is referenced through a Call Activity (and mapped to <i>definitional Collaboration</i> of the calling Process).
<p>messageFlow: Message Flow [0..*]</p>	<p>This provides the list of Message Flows that are used in the Collaboration. Message Flows are visualized in Collaboration (as dashed line) and hidden in Choreography.</p>
<p>messageFlowAssociations: Message Flow Association [0..*]</p>	<p>This attribute provides a list of mappings for the Message Flows of the Collaboration to Message Flows of a referenced model. It is used in the following situation:</p> <ul style="list-style-type: none"> • When a Choreography is referenced by a Collaboration. This allows the "wiring up" of the Collaboration Message Flows to the appropriate Choreography Activities.
<p>IsClosed: boolean = false</p>	<p>A boolean value specifying whether Message Flows not modeled in the Collaboration can occur when the Collaboration is carried out.</p> <ul style="list-style-type: none"> • If the value is <i>true</i>, they MAY NOT occur. • If the value is <i>false</i>, they MAY occur.

A set of **Messages Flow** of a particular **Collaboration** MAY belong to a **Conversation**. A **Conversation** is a set of **Message Flows** that share a particular purpose (i.e., they all relate to the handling of a single order - see page 123 for more information about **Conversations**).

9.2 Basic Collaboration Concepts

A **Collaboration** usually contains two or more **Pools**, representing the *Participants* in the **Collaboration**. The **Message** exchange between the *Participants* is shown by a **Message Flow** that connects two **Pools** (or the objects within the **Pools**). The **Messages** associated with the **Message Flows** MAY also be shown. See 9.3, 9.4, and 9.5 for examples of **Collaborations**.

A **Pool** MAY be empty, a “black box,” or MAY show a **Process** within. **Choreographies** MAY be shown “in between” the **Pools** as they bisect the **Message Flows** between the **Pools**. All combinations of **Pools**, **Processes**, and a **Choreography** are allowed in a **Collaboration**.

9.2.1 Use of BPMN Common Elements

Some **BPMN** elements are common to both **Process** and **Choreography**, as well as **Collaboration**; they are used in these diagrams. The next few sub clauses will describe the use of **Messages**, **Message Flows**, **Participants**, **Sequence Flows**, **Artifacts**, **Correlations**, **Expressions**, and **Services** in **Choreography**.

9.3 Pool and Participant

A **Pool** is the graphical representation of a Participant in a **Collaboration**. A *Participant* (see page 113) can be a specific `PartnerEntity` (e.g., a company) or can be a more general `PartnerRole` (e.g., a buyer, seller, or manufacturer). A **Pool** MAY or MAY NOT reference a **Process**. A **Pool** is NOT REQUIRED to contain a **Process**, i.e., it can be a “black box.”

- ◆ A **Pool** is a square-cornered rectangle that MUST be drawn with a solid single line (see Figure 9.2).
- ◆ The label for the **Pool** MAY be placed in any location and direction within the **Pool**, but MUST be separated from the contents of the **Pool** by a single line.
- ◆ If the **Pool** is a black box (i.e., does not contain a **Process**), then the label for the **Pool** MAY be placed anywhere within the **Pool** without a single line separator.
- ◆ One, and only one, **Pool** in a diagram MAY be presented without a boundary. If there is more than one **Pool** in the diagram, then the remaining **Pools** MUST have a boundary.

The use of text, color, size, and lines for a **Pool** MUST follow the rules defined in “Use of Text, Color, Size, and Lines in a Diagram” on page 39.



Figure 9.2 – A Pool

To help with the clarity of the Diagram, a **Pool** extends the entire length of the Diagram, either horizontally or vertically. However, there is no specific restriction to the size and/or positioning of a **Pool**. Modelers and modeling tools can use **Pools** in a flexible manner in the interest of conserving the “real estate” of a Diagram on a screen or a printed page.

A **Pool** acts as the container for the **Sequence Flows** between **Activities** (of a contained **Process**). The **Sequence Flows** can cross the boundaries between **Lanes** of a **Pool** (see page 304 for more details on **Lanes**), but cannot cross the boundaries of a **Pool**. That is, a **Process** is fully contained within the **Pool**. The interaction between **Pools** is shown through **Message Flows**.

Another aspect of **Pools** is whether or not there is any **Activity** detailed within the **Pool**. Thus, a given **Pool** MAY be shown as a “White Box,” with all details (e.g., a **Process**) exposed, or as a “Black Box,” with all details hidden. No **Sequence Flows** are associated with a “Black Box” **Pool**, but **Message Flows** can attach to its boundaries (see Figure 9.3).

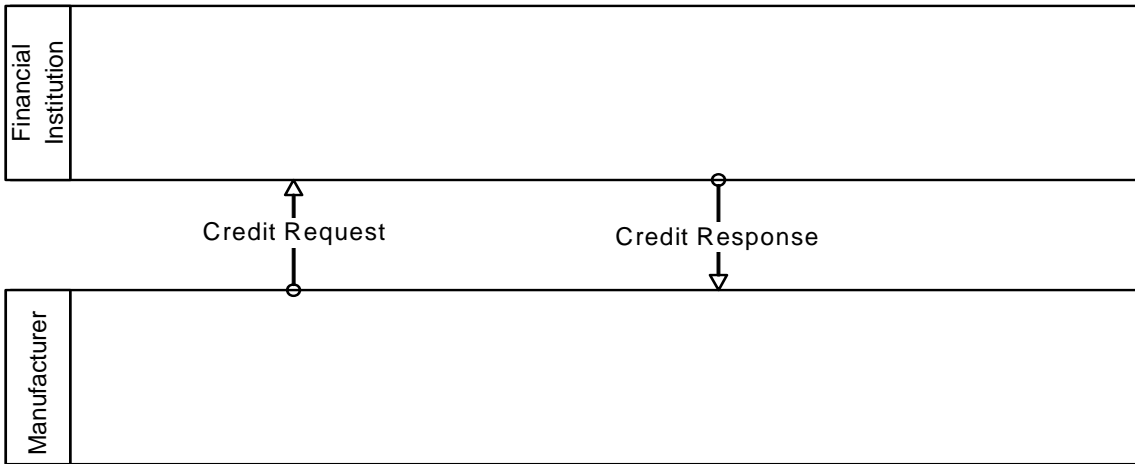

Figure 9.3 – Message Flows connecting to the boundaries of two Pools

For a “White Box” **Pool**, the **Activities** within are organized by **Sequence Flows**. **Message Flows** can cross the **Pool** boundary to attach to the appropriate **Activity** (see Figure 9.4).

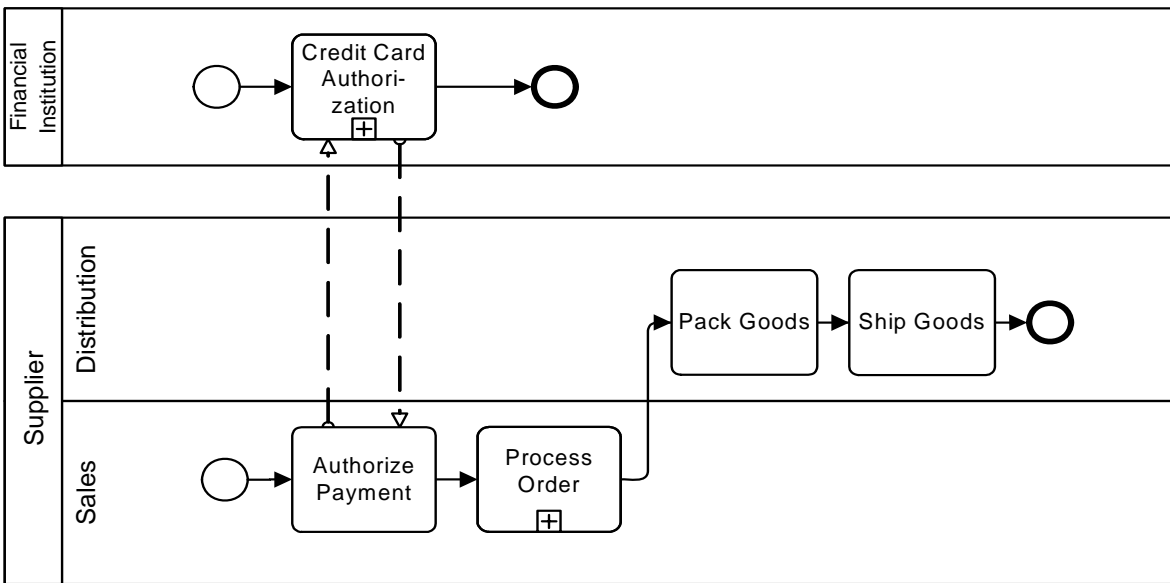

Figure 9.4 – Message Flows connecting to Flow Objects within two Pools

A **Collaboration** can contain two (2) or more **Pools** (i.e., *Participants*). However, a **Process** that represents the work performed from the point of view of the modeler or the modeler’s organization can be considered “internal” and is **NOT REQUIRED** to be surrounded by the boundary of the **Pool**, while the other **Pools** in the Diagram **MUST** have their boundary (see Figure 9.5).

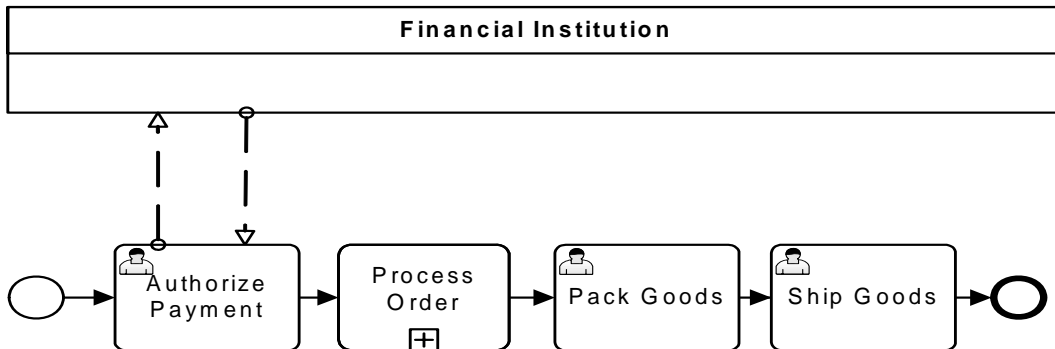

Figure 9.5 – Main (Internal) Pool without boundaries

BPMN specifies a marker for **Pools**: a *multi-instance* marker May be displayed for a **Pool** (see Figure 9.6). The marker is used if the *Participant* defined for the **Pool** is a *multi-instance Participant*. See page 116 for more information on *Participant* multiplicity.

- ◆ The marker for a **Pool** that is a *multi-instance* MUST be a set of three vertical lines in parallel.
- ◆ The marker, if used, MUST be centered at the bottom of the shape.

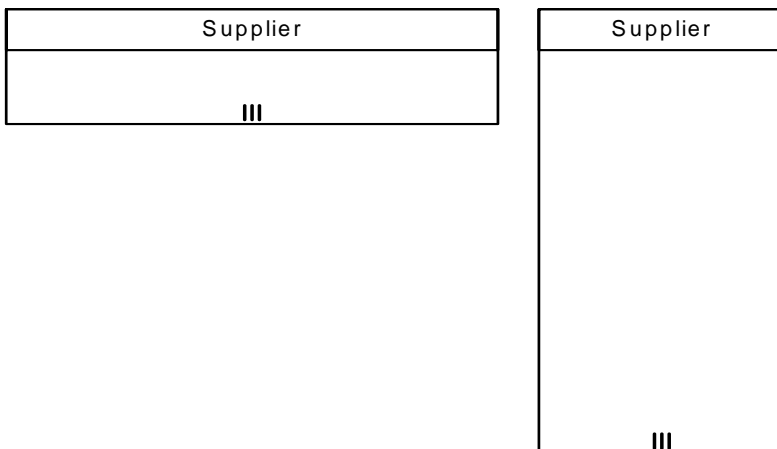

Figure 9.6 – Pools with a Multi-Instance Participant Markers

9.3.1 Participants

A *Participant* represents a specific *PartnerEntity* (e.g., a company) and/or a more general *PartnerRole* (e.g., a buyer, seller, or manufacturer) that are *Participants* in a **Collaboration**. A *Participant* is often responsible for the execution of the **Process** enclosed in a **Pool**; however, a **Pool** MAY be defined without a **Process**.

Figure 9.7 displays the class diagram of the *Participant* and its relationships to other **BPMN** elements. When *Participants* are defined they are contained within a **Collaboration**, which includes the sub-types of **Choreography**, **GlobalConversation**, or **GlobalChoreographyTask**.

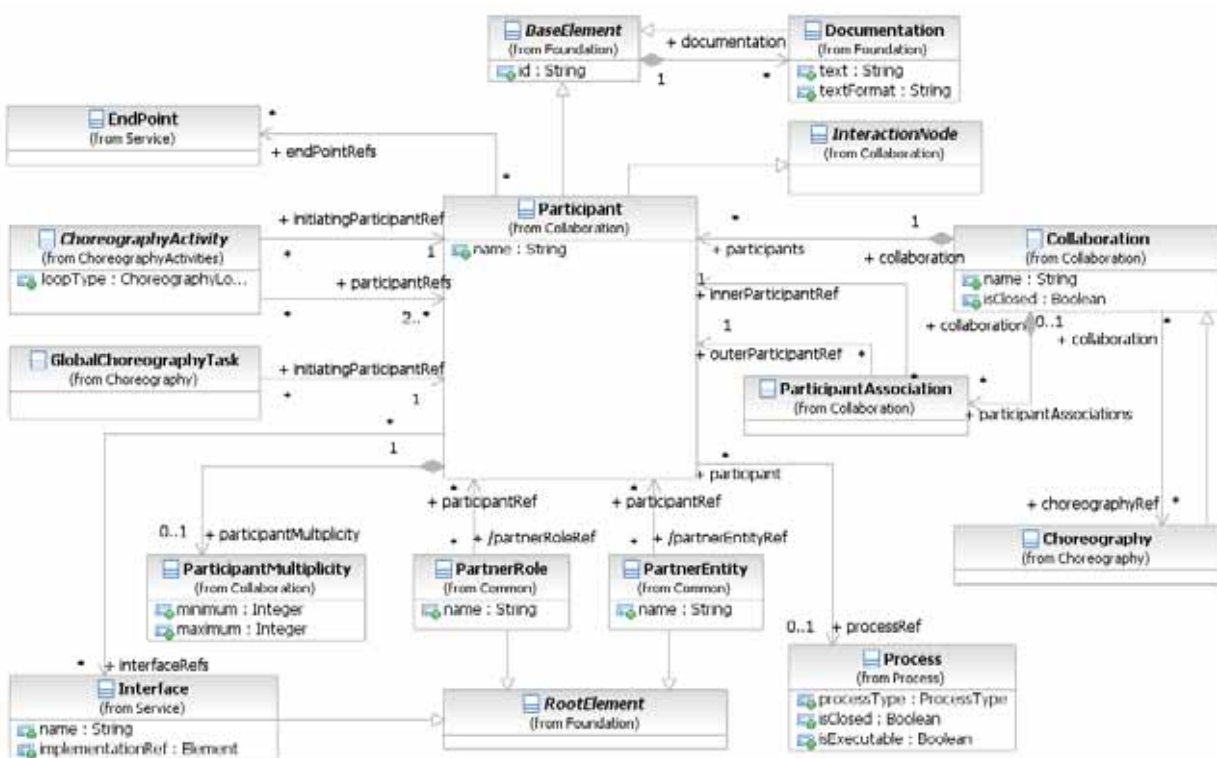

Figure 9.7 – The Participant Class Diagram

The *Participant* element inherits the attributes and model associations of *BaseElement* (see Table 8.5). Table 9.2 presents the additional attributes and model associations for the *Participant* element.

Table 9.2 – Participant attributes and model associations

Attribute Name	Description/Usage
name: string [0..1]	Name is a text description of the <i>Participant</i> . The name of the <i>Participant</i> can be displayed directly or it can be substituted by the associated <code>PartnerRole</code> or <code>PartnerEntity</code> . Potentially, both the <code>PartnerEntity</code> name and <code>PartnerRole</code> name can be displayed for the <i>Participant</i> .
processRef: Process [0..1]	The <code>processRef</code> attribute identifies the Process that the <i>Participant</i> uses in the <i>Collaboration</i> . The Process will be displayed within the <i>Participant's</i> Pool.
partnerRoleRef: PartnerRole [0..*]	The <code>partnerRoleRef</code> attribute identifies a <code>PartnerRole</code> that the <i>Participant</i> plays in the <i>Collaboration</i> . Both a <code>PartnerRole</code> and a <code>PartnerEntity</code> MAY be defined for the <i>Participant</i> . This attribute is derived from the <code>participantRefs</code> of <code>PartnerRole</code> .
partnerEntityRef: PartnerEntity [0..*]	The <code>partnerEntityRef</code> attribute identifies a <code>PartnerEntity</code> that the <i>Participant</i> plays in the <i>Collaboration</i> . Both a <code>PartnerRole</code> and a <code>PartnerEntity</code> MAY be defined for the <i>Participant</i> . This attribute is derived from the <code>participantRefs</code> of <code>PartnerEntity</code> .
interfaceRef: Interface [0..*]	This association defines <code>Interfaces</code> that a <i>Participant</i> supports. The definition of <code>Interfaces</code> is provided on page 102.
participantMultiplicity: participantMultiplicity [0..1]	The <code>participantMultiplicityRef</code> model association is used to define <i>Participants</i> that represent more than one (1) instance of the <i>Participant</i> for a given interaction. See the next sub clause for more details on <code>ParticipantMultiplicity</code> .
endPointRefs: EndPoint [0..*]	This attribute is used to specify the address (or endpoint reference) of concrete services realizing the <i>Participant</i> .

PartnerEntity

A `PartnerEntity` is one of the possible types of *Participant* (see above).

The `PartnerEntity` element inherits the attributes and model associations of `BaseElement` (see Figure 8.5). Table 9.3 presents the additional attributes and model associations for the `PartnerEntity` element.

Table 9.3 – PartnerEntity attributes

Attribute Name	Description/Usage
name: string	Name is a text description of the <code>PartnerEntity</code> .
participantRef: Participant [0..*]	Specifies how the <code>PartnerEntity</code> participates in Collaborations and Choreographies .

PartnerRole

A `PartnerRole` is one of the possible types of `Participant` (see above).

The `PartnerRole` element inherits the attributes and model associations of `BaseElement` (see Figure 8.5). Table 9.4 presents the additional attributes and model associations for the `PartnerRole` element.

Table 9.4 – PartnerRole attributes

Attribute Name	Description/Usage
name: string	Name is a text description of the <code>PartnerRole</code> .
participantRef: <code>Participant</code> [0..*]	Specifies how the <code>PartnerRole</code> participates in Collaborations and Choreographies .

Participant Multiplicity

`ParticipantMultiplicity` is used to define the multiplicity of a `Participant`.

For example, a manufacturer can request a quote from multiple suppliers in a **Collaboration**.

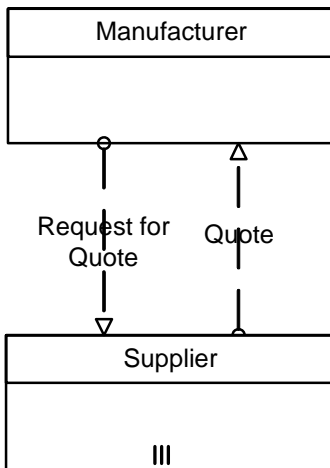

Figure 9.8 – A Pool with a Multiple Participant

The following figure shows the `Participant` class diagram.



Figure 9.9 – The Participant Multiplicity class diagram

The *multi-instance* marker will be displayed in bottom center of the **Pool** (*Participant* - see Figure 9.9, above), or the **Participant Band** of a **Choreography Activity** (see page 321), when the *ParticipantMultiplicity* is associated with the *Participant*, and the maximum attribute is either not set, or has a value of two or more.

Table 9.5 presents the attributes for the *ParticipantMultiplicity* element.

Table 9.5 – ParticipantMultiplicity attributes

Attribute Name	Description/Usage
minimum: integer = 0	The minimum attribute defines minimum number of <i>Participants</i> that MUST be involved in the Collaboration . If a value is specified in the maximum attribute, it MUST be greater or equal to this minimum value.
maximum: integer [0..1] = 1	The maximum attribute defines maximum number of <i>Participants</i> that MAY be involved in the Collaboration . The value of maximum MUST be one or greater, AND MUST be equal or greater than the minimum value.

Table 9.6 presents the *Instance* attributes of the *ParticipantMultiplicity* element.

Table 9.6 – ParticipantMultiplicity Instance attributes

Attribute Name	Description/Usage
numParticipants: integer [0..1]	The current number of the multiplicity of the <i>Participant</i> for this Choreography or Collaboration Instance .

ParticipantAssociation

These elements are used to do mapping between two elements that both contain *Participants*. There are situations where the *Participants* in different diagrams can be defined differently because they were developed independently, but represent the same thing. The *ParticipantAssociation* provides the mechanism to match up the *Participants*.

A *ParticipantAssociation* is used when an (*outer*) diagram with *Participants* contains an (*inner*) diagram that also has *Participants*. There are four usages of *ParticipantAssociation*. It is used when:

1. A **Collaboration** references a **Choreography** for inclusion between the **Collaboration's Pools** (*Participants*). The *Participants* of the **Choreography** (the inner diagram) need to be mapped to the *Participants* of the **Collaboration** (the outer diagram).
2. A **Call Conversation** references a **Collaboration** or *GlobalConversation*. Thus, the *Participants* of the **Collaboration** or *GlobalConversation* (the inner diagram) need to be mapped to the *Participants* referenced by the **Call Conversation** (the outer element). Each **Call Conversation** contains its own set of *ParticipantAssociations*.
3. A **Call Choreography** references a **Choreography** or *GlobalChoreographyTask*. Thus, the *Participants* of the **Choreography** or *GlobalChoreographyTask* (the inner diagram) need to be mapped to the *Participants* referenced by the **Call Choreography** (the outer element). Each **Call Choreography** contains its own set of *ParticipantAssociations*.

Table 9.7 – ParticipantAssociation model associations

Attribute Name	Description/Usage
innerParticipantRef : Participant	This attribute defines the <i>Participant</i> of the referenced element (e.g., a Choreography to be used in a Collaboration) that will be mapped to the parent element (e.g., the Collaboration).
outerParticipantRef : Participant	This attribute defines the <i>Participant</i> of the parent element (e.g., a Collaboration references a Choreography) that will be mapped to the referenced element (e.g., the Choreography).

9.3.2 Lanes

A **Lane** is a sub-partition within a **Process** (often within a **Pool**) and will extend the entire length of the **Process** level, either vertically (see Figure 10.123) or horizontally (see Figure 10.124). See page 304 for more information on **Lanes**.

9.4 Message Flow

A **Message Flow** is used to show the flow of **Messages** between two **Participants** that are prepared to send and receive them.

- ◆ A **Message Flow** MUST connect two separate **Pools**. They connect either to the **Pool** boundary or to Flow Objects within the **Pool** boundary. They MUST NOT connect two objects within the same **Pool**.
- ◆ A **Message Flow** is a line with an open circle line start and an open arrowhead line end that MUST be drawn with a dashed single line (see Figure 9.11).
- ◆ The use of text, color, size, and lines for a **Message Flow** MUST follow the rules defined in “Use of Text, Color, Size, and Lines in a Diagram” on page 39.

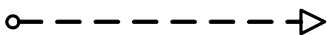

Figure 9.11 – A Message Flow

In Collaboration Diagrams (the view showing the **Choreography Process** Combined with Orchestration **Processes**), a **Message Flow** can be extended to show the **Message** that is passed from one **Participant** to another (see Figure 9.12).

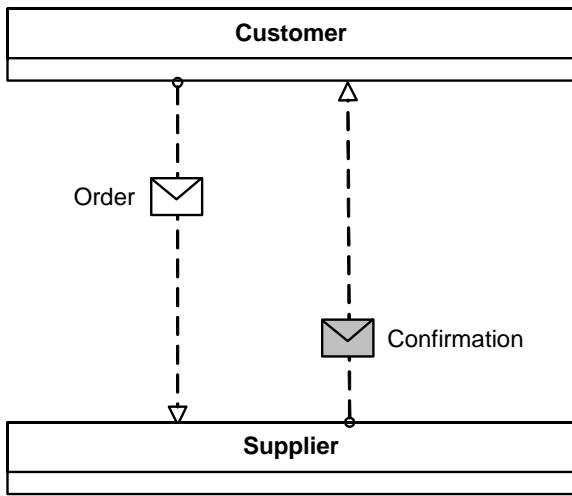

Figure 9.12 – A Message Flow with an Attached Message

If a **Choreography** is included in the **Collaboration**, then the **Message Flow** will “pass-through” a **Choreography Task** as it connects from one Participant to another (see Figure 9.13).

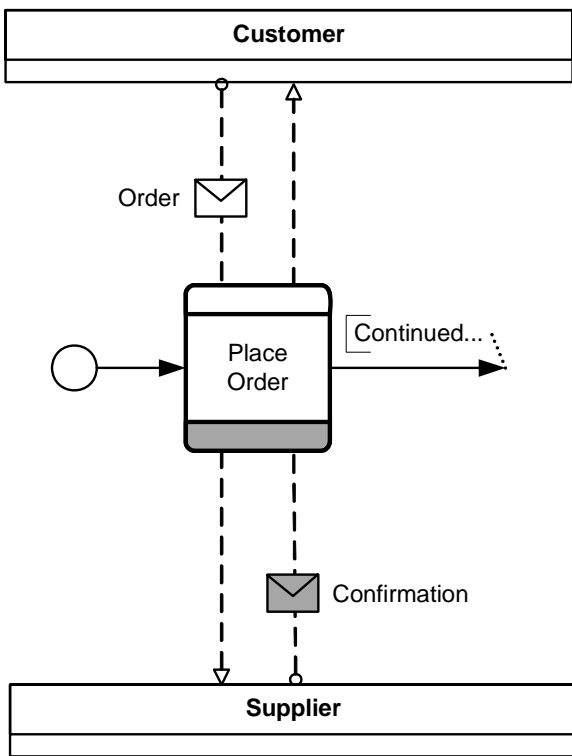

Figure 9.13 – A Message Flow passing through a Choreography Task

Figure 9.14 displays the class diagram of a **Message Flow** and its relationships to other BPMN elements. When a **Message Flow** is defined it is contained either within a **Collaboration**, a **Choreography**, or a **GlobalChoreographyTask**.

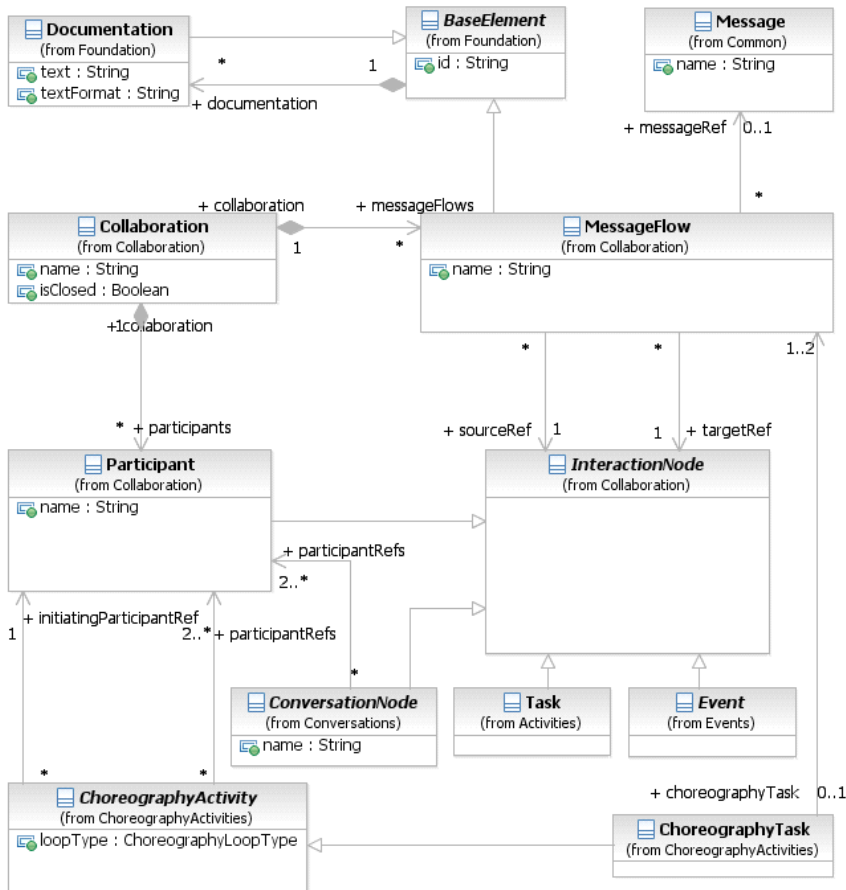

Figure 9.14 – The Message Flow Class Diagram

The **Message Flow** element inherits the attributes and model associations of **BaseElement** (see Table 8.5). Table 9.8 presents the additional attributes and model associations for the **Message Flow** element.

Table 9.8 – Message Flow attributes and model associations

Attribute Name	Description/Usage
name: string	Name is a text description of the Message Flow .
sourceRef: InteractionNode	The InteractionNode that the Message Flow is connecting from. Of the types of InteractionNode, only Pools/Participants , Activities , and Events can be the <i>source</i> of a Message Flow .
targetRef: InteractionNode	The InteractionNode that the Message Flow is connecting to. Of the types of InteractionNode, only Pools/Participants , Activities , and Events can be the <i>target</i> of a Message Flow .
messageRef: Message [0..1]	The messageRef model association defines the Message that is passed via the Message Flow (see page 91 for more details).

9.4.1 Interaction Node

The InteractionNode element is used to provide a single element as the source and target **Message Flow** associations (see Figure 9.14, above) instead of the individual associations of the elements that can connect to **Message Flows** (see above). Only the **Pool/Participant**, **Activity**, and **Event** elements can connect to **Message Flows**. The InteractionNode element is also used to provide a single element for source and target of **Conversation Links**, see page 131.

The InteractionNode element does not have any attributes or model associations and does not inherit from any other **BPMN** element. Since **Pools/Participants**, **Activities**, and **Events** have their own attributes, model associations, and inheritances, additional attributes and model associations for the InteractionNode element are not necessary.

9.4.2 Message Flow Associations

These elements are used to do mapping between two elements that both contain **Message Flows**. The MessageFlowAssociation provides the mechanism to match up the **Message Flows**.

A MessageFlowAssociation is used when an (*outer*) diagram with **Message Flows** contains an (*inner*) diagram that also has **Message Flows**. It is used when:

- A **Collaboration** references a **Choreography** for inclusion between the **Collaboration's Pools** (*Participants*). The **Message Flows** of the **Choreography** (the inner diagram) need to be mapped to the **Message Flows** of the **Collaboration** (the outer diagram).
- A **Collaboration** references a **Conversation** that contains **Message Flows**. The **Message Flows** of the **Conversation** can serve as a partial requirement for the **Collaboration**. Thus, the **Message Flows** of the **Conversation** (the inner diagram) need to be mapped to the **Message Flows** of the **Collaboration** (the outer diagram).
- A **Choreography** references a **Conversation** that contains **Message Flows**. The **Message Flows** of the **Conversation** can serve as a partial requirement for the **Choreography**. Thus, the **Message Flows** of the **Conversation** (the inner diagram) need to be mapped to the **Message Flows** of the **Choreography** (the outer diagram).

Figure 9.15 shows the class diagram for the MessageFlowAssociation element.

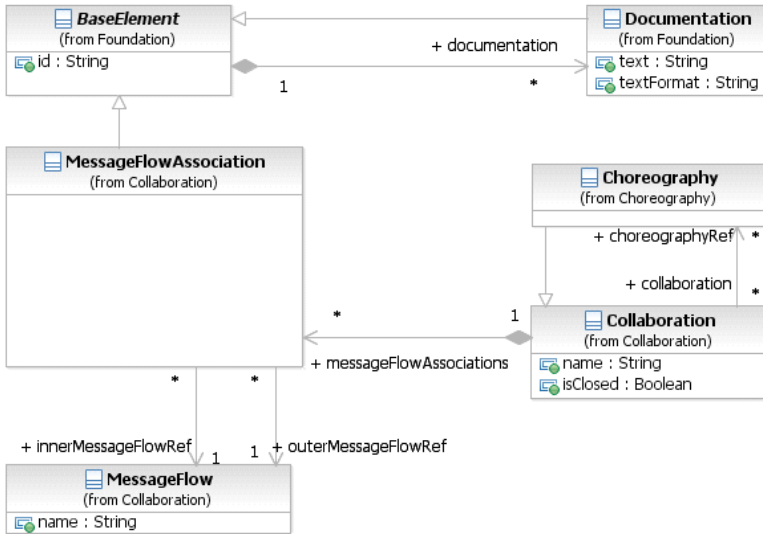

Figure 9.15 – MessageFlowAssociation class diagram

The MessageFlowAssociation element inherits the attributes and model associations of BaseElement (see Table 8.5). Table 9.9 presents the additional model associations for the MessageFlowAssociation element.

Table 9.9 – MessageFlowAssociation attributes and model associations

Attribute Name	Description/Usage
innerMessageFlowRef: Message Flow	This attribute defines the Message Flow of the referenced element (e.g., a Choreography to be used in a Collaboration) that will be mapped to the parent element (e.g., the Collaboration).
outerMessageFlowRef: Message Flow	This attribute defines the Message Flow of the parent element (e.g., a Collaboration references a Choreography) that will be mapped to the referenced element (e.g., the Choreography).

9.5 Conversations

The **Conversation** diagram is particular usage of and an informal description of a **Collaboration** diagram. In general, it is a simplified version of **Collaboration**, but **Conversation** diagrams do maintain all the features of a **Collaboration**. In particular, **Processes** can appear within the *Participants* (**Pools**) of **Conversation** diagrams, to show how **Conversation** and **Activities** are related.

The view includes two additional graphical elements that do not exist in other **BPMN** views:

1. **Conversation Node** elements (**Conversation**, **Sub-Conversation**, and **Call Conversation**)
2. A **Conversation Link**

A **Conversation** is a logical grouping of **Message** exchanges (**Message Flows**) that can share a *Correlation*. A **Conversation** is the logical relation of **Message** exchanges. The logical relation, in practice, often concerns a business object(s) of interest, e.g., “Order,” “Shipment and Delivery,” and “Invoice.” Hence, a **Conversation** is associated with a set of name-value pairs, or a *Correlation Key* (e.g., “Order Identifier,” “Delivery Identifier”), which is recorded in the **Messages** that are exchanged. In this way, a **Message** can be routed to the specific **Process** *instance* responsible for receiving and processing the **Message**.

Figure 9.16 shows a simple example of a **Conversation** diagram.

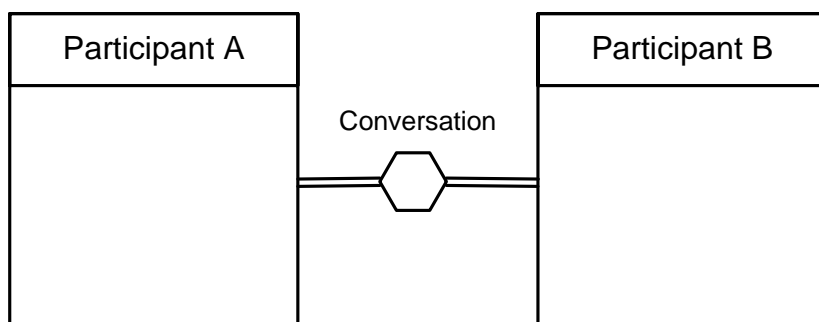

Figure 9.16 – A Conversation diagram

Figure 9.17 shows a variation of the example above where the **Conversation** node has been expanded into its component **Message Flows**. Note that the diagram looks the same as a simple **Collaboration** diagram (as in Figure 9.3, above).

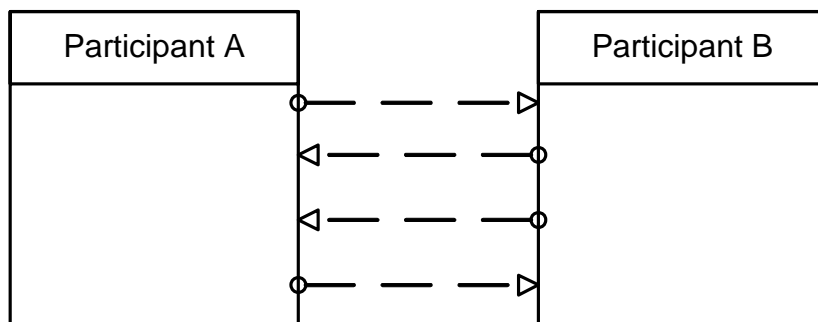

Figure 9.17 – A Conversation diagram where the Conversation is expanded into Message Flows

Message exchanges are related to each other and reflect distinct business scenarios. The relation is sometimes simple, for example, a request followed by a response, and can be described as part of a structural interface of a service (e.g., as a WSDL operation definition). However for commercial business transactions managed through **Business Processes**, the relation can be complex, involving long-running, reciprocal **Message** exchanges, and that could extend beyond bilateral to complex, multilateral **Collaborations**. For example, in logistics, stock replenishments involve the following types scenarios: creation of sales orders, assignment of carriers for shipments combining different sales orders, crossing customs/quarantine, processing payment, and investigating exceptions.

In addition to an *orchestration Process*, **Conversations** are relevant to a **Choreography**, but the **Conversations** are not visualized in a **Choreography**. The difference is that a **Choreography** provides a multi-party perspective of a **Conversation**. This is because the **Message** exchanges modeled using **Choreography Activities** concern multiple Participants, unlike an *orchestration Process* where the **Message** sending and receiving elements relate to one Participant only. Other than the difference in perspective, the notion of **Conversation** remains the same across **Choreography** and *orchestration*, and the **Message** exchanges of a **Conversation** will be executed ultimately through an *orchestration Process*.

Since **Collaboration** provides a top-down, design-time modeling perspective for **Message** exchanges and their **Conversations**, an abstracted view of the all **Conversations** pertaining to a domain being modeled is available through a **Conversation** diagram. A **Conversation** diagram, as depicted in Figure 9.18, shows **Conversations** (as hexagons) between *Participants*. This provides a “bird’s eye” perspective of the different **Conversations** that relate to the domain.

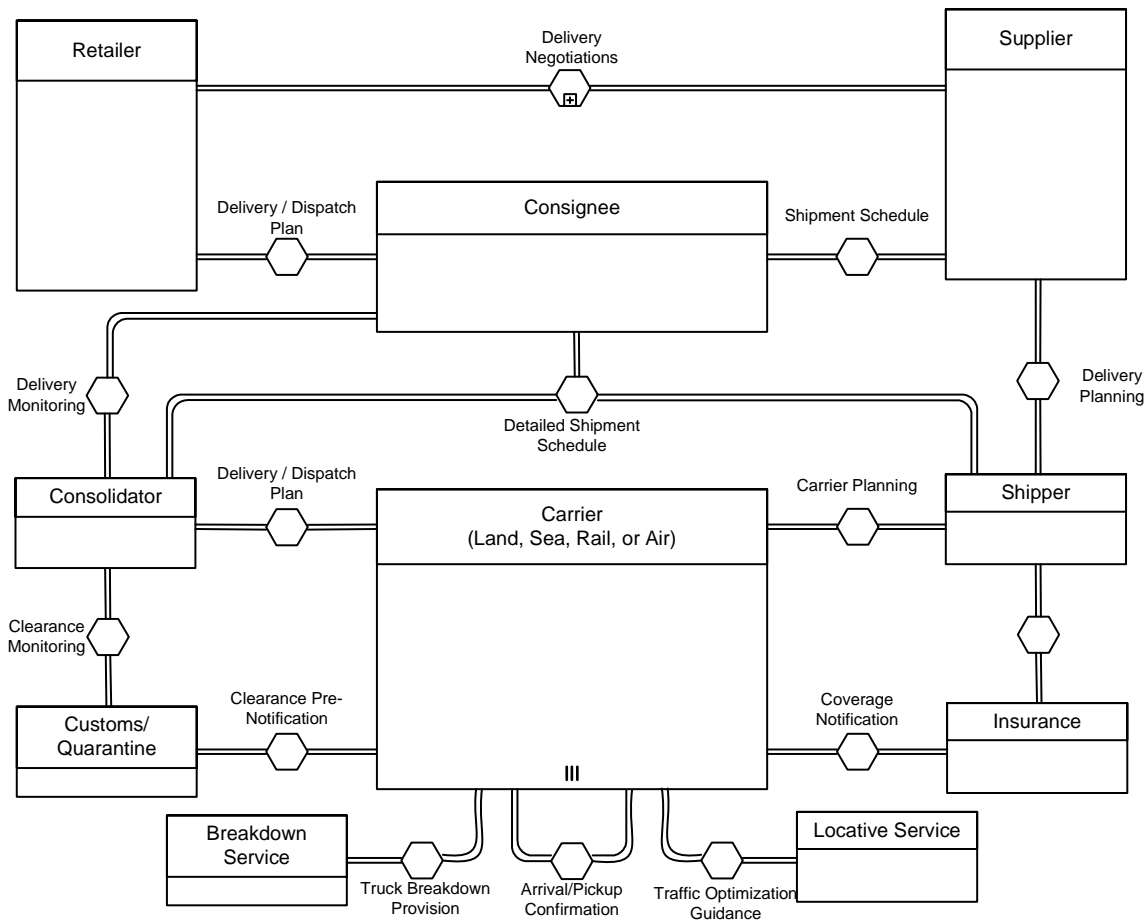

Figure 9.18 – Conversation diagram depicting several conversations between *Participants* in a related domain

Figure 9.18 depicts 13 distinct **Conversations** between collaborating Participants in a logistics domain. As examples, *Retailer* and *Supplier* are involved in a *Delivery Negotiations Conversation*, and *Consignee* converses with *Retailer* and *Supplier* through *Delivery/Dispatch Plan* and *Shipment Schedule Conversations* respectively. More than two participants MAY be involved in a **Conversation**, e.g., *Consignee*, *Consolidator* and *Shipper* in *Detailed Shipment*

Schedule. The association of Participants to a **Conversation** are constrained to indicate whether one or many of *Participants* are involved. For example, one *instance* of *Retailer* converses with one *instance* of *Supplier* for *Delivery Negotiations*. However, one *instance* of *Shipper* converses with multiple *instances* of *Carrier* (indicated by the multi-instance symbol of the **Pool** for *Carrier*) for *Carrier Planning*. Note, multiplicity in constraints of **Conversation** diagrams means one or more (not zero or more).

The behavior of different **Conversations** is modeled through separate **Choreographies**, detailing the **Message** exchange sequences. In practice, **Conversations** which are closely related could be combined in the same **Choreography** models. For example, a **Message** exchange in the *Delivery Negotiation* leads to *Shipment Schedule*, *Delivery Planning*, and *Delivery/Dispatch Conversations* and these could be combined together in the same **Choreography**. Alternatively, they could be separated in different models.

Figure 9.19 shows a subset of the larger **Conversation** diagram of Figure 9.18, above. Figure 9.20 and Figure 9.21 show the drill down into the “Delivery Negotiations” **Sub-Conversation**. This expands the **Conversation** with the **Message Flows**, providing a structural view of a **Conversation** without the “clutter” of sequencing details in the same diagram. Figure 9.19 also indicates the **CorrelationKey** involved in the **Message Flows** of the **Conversation**. For example, *Order Id* is necessary for in all **Messages** of **Message Flows** in Delivery Negotiation. In addition, some **Message Flows** also require *Variation Id* (for dealing with shipment variations on a per line item basis).

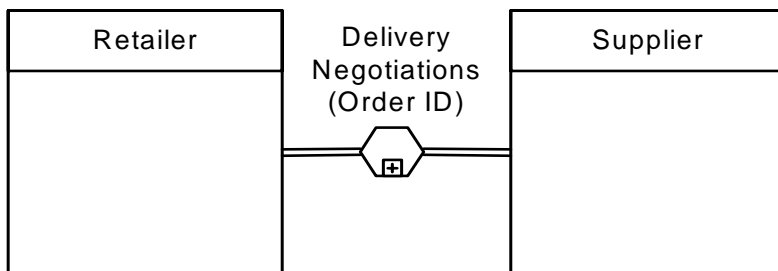

Figure 9.19 – An example of a Sub-Conversation

Figure 9.20 shows how the **Sub-Conversation** of Figure 9.19, above, is expanded into a set of **Message Flows** and a lower-level **Conversation**.

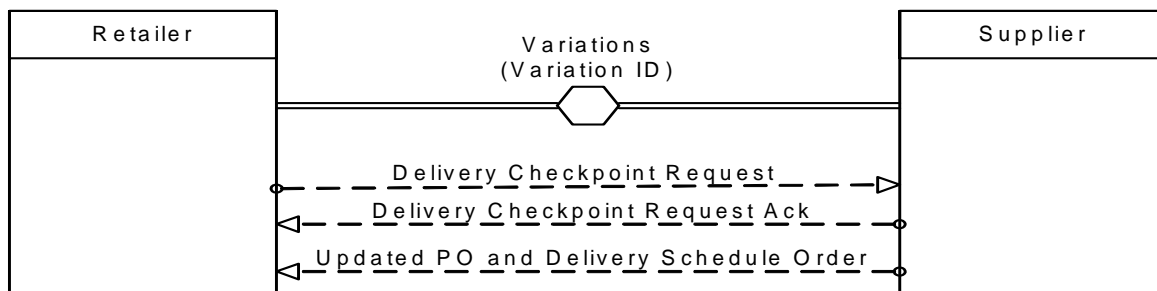

Figure 9.20 – An example of a Sub-Conversation expanded to a Conversation and Message Flow

Figure 9.21 shows how the **Conversation** of Figure 9.20 is also expanded into a set of **Message Flows**, combined with the previous **Message Flows**. Note that the newly exposed **Message Flows** of the lower-level **Conversation** will be correlated by the `CorrelationKey` of both the lower-level **Conversation** (*Variation Id*) and the higher-level **Sub-Conversations** (*Order Id*).

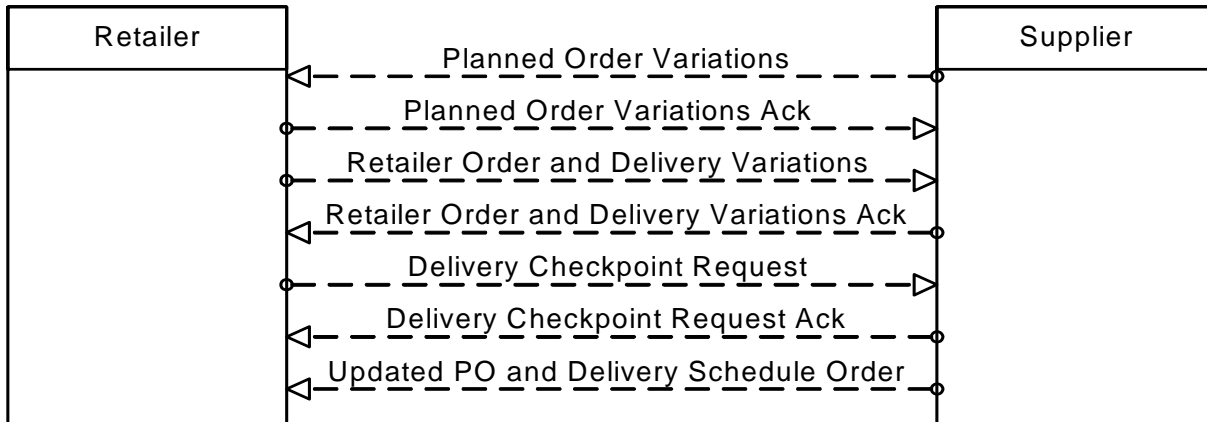

Figure 9.21 – An example of a Sub-Conversation that is fully expanded

In Figure 9.19 a hierarchical structure of **Conversations** can be seen with one set of **Message Flows** occurring within another in a parent-child relationship. In particular, after *Planned Order Variations* (keyed on *Order Id*) at the parent, a number of **Message Flows** of the child follow till *Retailer Order and Delivery Variations Ack* (keyed on *Variation Id* and *Order Id*). The remaining **Message Flows** (keyed on *Order Id*) are at the parent level. The child **Conversation**, as such, is part of the parent **Conversation**. Nesting is indicated graphically on a **Conversation** symbol (by a “+”), indicating a **Sub-Conversation** or a **Call Conversation** calling a **Collaboration**. Nesting can go to an arbitrary number of levels.

A common dependency between **Conversations** is overlap. Overlap occurs when two or more **Conversations** have some **Message** exchanges in common but not others. As an example in Figure 9.18, a **Message** is sent as part of *Detailed Shipment Schedule* (keyed on *Carrier Schedule Id*) to trigger *Delivery Monitoring* (keyed on *Shipment Id*). During *Delivery Monitoring*, **Message** could be sent to *Detailed Shipment Schedule* (to request modifications when transportation exceptions occur).

Splits and *joins* are special types of overlap scenarios. A **Conversation split** arises when, as part of a **Conversation**, a message is exchanged between two or more *Participants* that at the same time spawns a new, distinct **Conversation** (either between the same set of *Participants* or another set). Additionally, no further **Message** exchanges are shared by the split **Conversations** as well as no subsequent merges of them occur. An example is *Delivery Planning* which leads to *Carrier Planning* and *Special Cover*. A **Conversation join** occurs when several **Conversations** are merged into one **Conversation** and no further **Message** exchanges occur in the original **Conversations**, i.e., these **Conversations** are finalized. The generalization of a *split* and *join* is a **Conversation refactor** where **Conversations** are split into parallel **Conversations** and then are merged at a later point in time.

9.5.1 Conversation Node

`ConversationNode` is the abstract super class for all elements that can comprise the **Conversation** elements of a **Collaboration** diagram, which are **Conversation** (see page 129), **Sub-Conversation** (see page 129), and **Call Conversation** (see page 130).

Table 9.10 – ConversationNode Model Associations

Attribute Name	Description/Usage
name: string [0..1]	Name is a text description of the <code>ConversationNode</code> element.
participantRefs: Participant [2..*]	This provides the list of <i>Participants</i> that are used in the <code>ConversationNode</code> from the list provided by the <code>ConversationNode</code> 's parent Conversation . This reference is visualized through a Conversation Link (see page 131).
messageFlowRefs: MessageFlow [0..*]	A reference to all Message Flows (and consequently Messages) grouped by a Conversation element.
correlationKeys: CorrelationKey [0..*]	This is a list of the <code>ConversationNode</code> 's <code>CorrelationKeys</code> , which are used to group Message Flows for the <code>ConversationNode</code> .

9.5.2 Conversation

A **Conversation** is an atomic element for a **Conversation (Collaboration)** diagram. It represents a set of **Message Flows** grouped together based on a concept and/or a `CorrelationKey`. A **Conversation** will involve two or more *Participants*.

- ◆ A **Conversation** is a hexagon that **MUST** be drawn with a single thin line (see Figure 9.23).



Figure 9.23 – A Communication element

The **Conversation** element inherits the attributes and model associations of `ConversationNode` (see Table 9.10), but does not contain any additional attributes or model associations.

9.5.3 Sub-Conversation

A **Sub-Conversation** is a `ConversationNode` that is a hierarchical division within the parent **Collaboration**. A **Sub-Conversation** is a graphical object within a **Collaboration**, but it also can be “opened up” to show the lower-level details of the **Conversation**, which consist of **Message Flows**, **Conversations**, and/or other **Sub-Conversations**. The **Sub-Conversation** shares the *Participants* of its parent **Conversation**.

- ◆ A **Sub-Conversation** is a hexagon that **MUST** be drawn with a single thin line (see Figure 9.24).
- ◆ The **Sub- Conversation** marker **MUST** be a small square with a plus sign (+) inside. The square **MUST** be positioned at the bottom center of the shape.



Figure 9.24 – A compound Conversation element

The **Sub-Conversation** element inherits the attributes and model associations of `ConversationNode` (see Table 9.10). Table 9.11 presents the additional model associations for the **Sub-Conversation** element.

Table 9.11 – Sub-Conversation Model Associations

Attribute Name	Description/Usage
conversationNodes: <code>ConversationNode [0..*]</code>	The <code>ConversationNodes</code> model aggregation relationship allows a Sub-Conversation to contain other <code>ConversationNodes</code> , in order to group Message Flows of the Sub-Conversation and associate correlation information.

9.5.4 Call Conversation

A **Call Conversation** identifies a place in the **Conversation (Collaboration)** where a global **Conversation** or a `GlobalConversation` is used.

- ◆ If the **Call Conversation** calls a `GlobalConversation`, then the shape will be the same as a **Conversation**, but the boundary of the shape will **MUST** have a thick line (see Figure 9.25).
- ◆ If the **Call Conversation** calls a **Collaboration**, then the shape will be the same as a **Sub-Conversation**, but the boundary of the shape will **MUST** have a thick line (see Figure 9.26).



Figure 9.25 – A Call Conversation calling a `GlobalConversation`



Figure 9.26 – A Call Conversation calling a **Collaboration**

The **Call Conversation** element inherits the attributes and model associations of `ConversationNode` (see Table 9.10). Table 9.12 presents the additional model associations for the **Call Conversation** element.

Table 9.12 – Call Conversation Model Associations

Attribute Name	Description/Usage
calledCollaborationRef: Collaboration [0..1]	The element to be called, which MAY be either a Collaboration or a GlobalConversation . The called element MUST NOT be a Choreography or a GlobalChoreographyTask (which are subtypes of Collaboration)
participantAssociations: Participant Association [0..*]	This attribute provides a list of mappings from the <i>Participants</i> of a referenced GlobalConversation or Conversation to the <i>Participants</i> of the parent Conversation .

NOTE: The *ConversationNode* attribute *messageFlowRef* doesn't apply to **Call Conversations**.

9.5.5 Global Conversation

A **GlobalConversation** is a reusable, atomic **Conversation** definition that can be called from within any **Collaboration** by a **Call Conversation**.

The **GlobalConversation** element inherits the attributes and model associations and **Collaboration** (see Table 9.1), but does not have any additional attributes or model associations.

A **GlobalConversation** is a restricted type of **Collaboration**, it is an “empty **Collaboration**.”

- ◆ A **GlobalConversation** MUST NOT contain any **ConversationNodes**.

Since a **GlobalConversation** does not have any Flow Elements, it does not require **MessageFlowAssociations**, **ParticipantAssociations**, or **ConversationAssociations** or **Artifacts**. It is basically a set of *Participants*, **Message Flows**, and **CorrelationKeys** intended for reuse. Also, the **Collaboration** attribute *choreographyRef* is not applicable to **GlobalConversation**.

9.5.6 Conversation Link

Conversation Links are used to connect **ConversationNodes** to and from *Participants* (**Pools** -- see Figure 9.27).

- ◆ **Conversation Links** MUST be drawn with double thin lines.

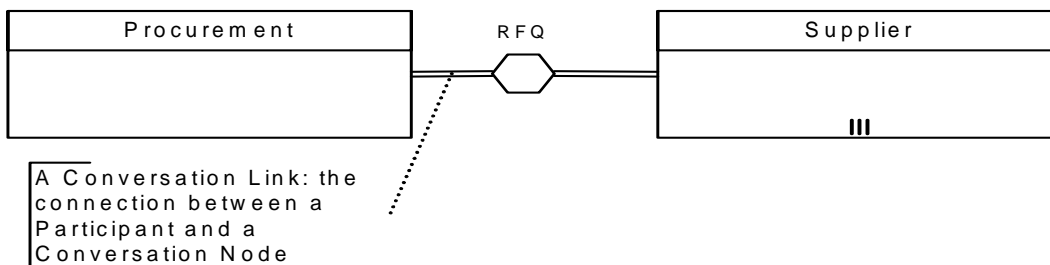

Figure 9.27 – A Conversation Link element

Processes can appear in the Participants (**Pools**) of **Conversation** diagrams, as shown in Figure 9.28. The invoicing and ordering **Conversations** have links into **Activities** and **Events** of the **Process** in the Order Processor. The other two **Conversations** do not have their links “expanded.” **Conversation Links** into **Activities** that are not **Send** or **Receive Tasks** indicate that the **Activity** will send or receive **Messages** of the **Conversation** at some level of nesting.

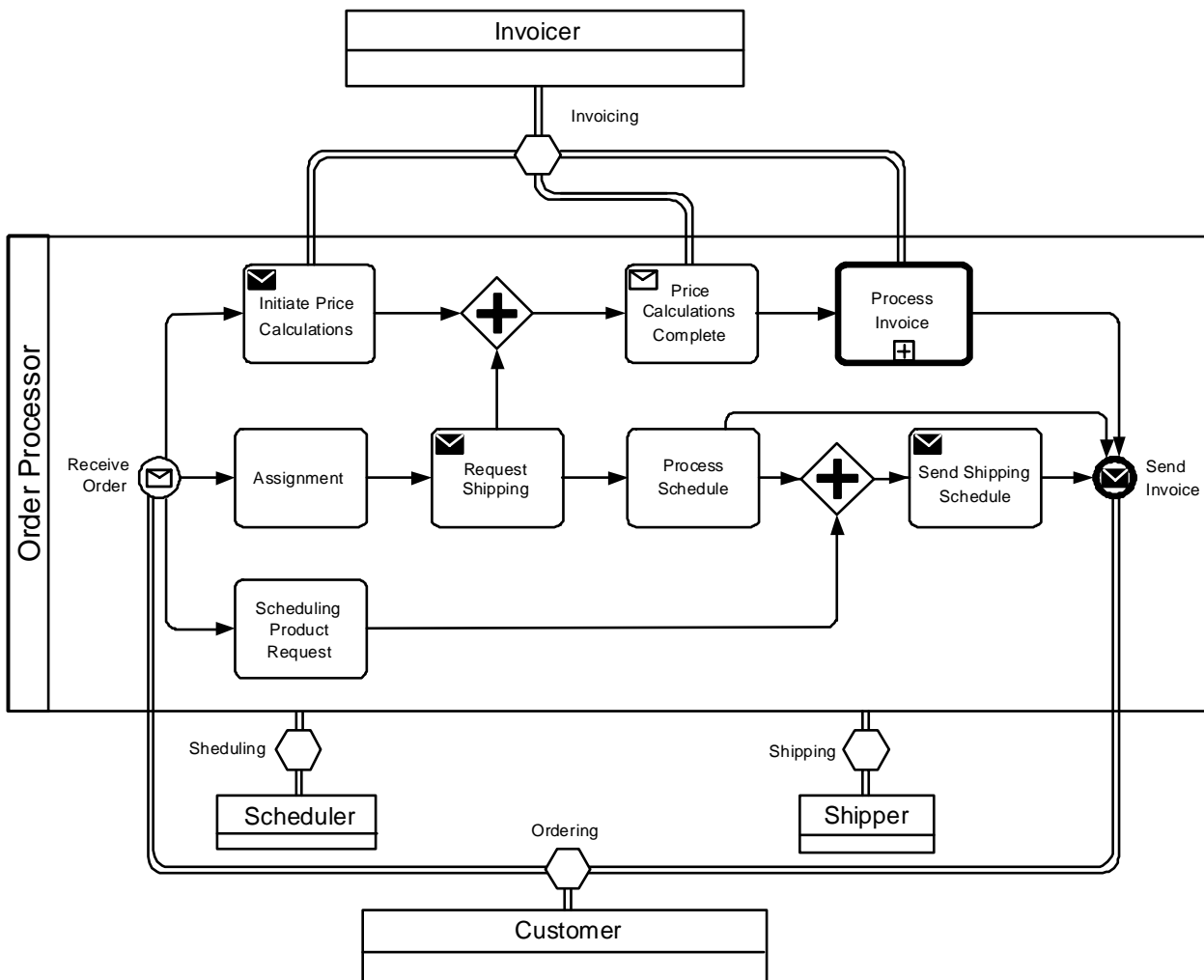

Figure 9.28 – Conversation links to Activities and Events

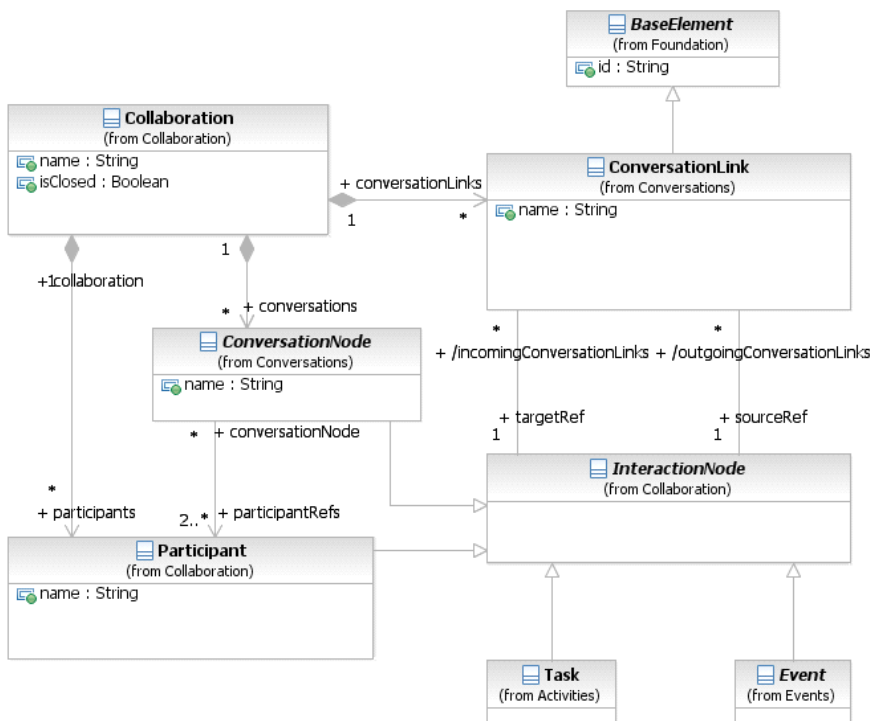

Figure 9.29 – Metamodel of Conversation Links related elements

The **Conversation Link** element inherits the attributes and model associations of BaseElement (see Table 8.5). Table 9.13 presents the additional attributes and model associations for the **Conversation Link** element.

Table 9.13 – Conversation Link Attributes and Model Associations

Attribute Name	Description/Usage
name: string [0..1]	This attribute specifies the name of the Conversation Link .
sourceRef: InteractionNode	The InteractionNode that the Conversation Link is connecting from. A Conversation Link MUST connect to exactly one ConversationNode. If the sourceRef is not a ConversationNode, then the targetRef MUST be a ConversationNode.
targetRef: InteractionNode	The InteractionNode that the Conversation Link is connecting to. A Conversation Link MUST connect to exactly one ConversationNode. If the targetRef is not a ConversationNode, then the sourceRef MUST be a ConversationNode.

Conversation Links for **Call Conversations** show the names of *Participants* in nested **Collaboration** or global **Collaborations**, as identified by ParticipantAssociations. For example, Figure 9.30 has a **Collaboration** on the left with a **Call Conversations** to a **Collaboration** on the right. The **Conversation Links** on the left indicate

which *Participants* in the called **Collaboration** on the right correspond to which *Participants* in the calling **Collaboration** on the left. For example, the Credit Agency *Participants* on the right corresponds to the Financial Company *Participant* on the left. *ParticipantAssociations* (not shown) tie each *Participant* in the **Collaboration** on the left to a *Participant* in the **Collaboration** on the right. They can be used to show the names of *Participants* in nested **Collaboration** or global **Collaborations**.

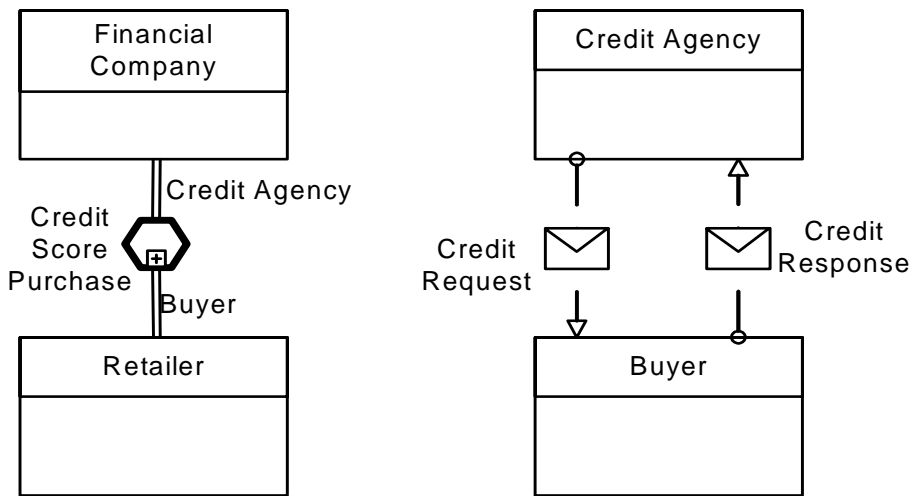

Figure 9.30 – Call Conversation Links

9.5.7 Conversation Association

A *ConversationAssociation* is used within **Collaborations** and **Choreographies** to apply a reusable **Conversation** to the **Message Flows** of those diagrams.

A *ConversationAssociation* is used when a diagram references a **Conversation** to provide **Message** correlation information and/or to logically group **Message Flows**. It is used when:

- A **Collaboration** references a **Choreography** for inclusion between the **Collaboration's Pools** (*Participants*). The *ConversationNodes* of the **Choreography** (the inner diagram) need to be mapped to the *ConversationNodes* of the **Collaboration** (the outer diagram).

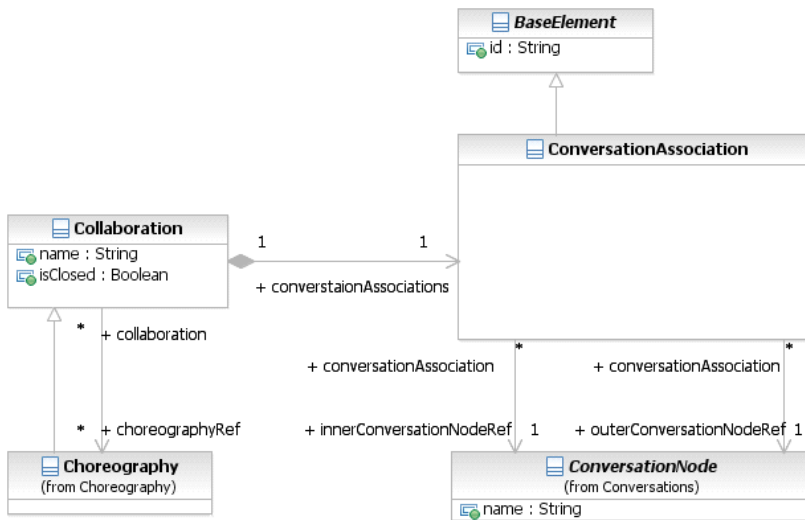

Figure 9.31 – The ConversationAssociation class diagram

The ConversationAssociation element inherits the attributes and model associations of BaseElement (see Table 8.5). Table 9.14 presents the additional model associations for the ConversationAssociation element.

Table 9.14 – ConversationAssociation Model Associations

Attribute Name	Description/Usage
innerConversationNodeRef: ConversationNode [0..1]	This attribute defines the ConversationNodes of the referenced element (e.g., a Choreography to be used in a Collaboration) that will be mapped to the parent element (e.g., the Collaboration).
outerConversationNodeRef: ConversationNode [0..*]	This attribute defines the ConversationNodes of the parent element (e.g., a Collaboration references a Choreography) that will be mapped to the referenced element (e.g., the Choreography).

9.5.8 Correlations

Correlations are the mechanism that is used to assign the **Messages** to the proper **Process instance**, and can be defined for the **Message Flows** that belong to the **Conversation**. Correlations can be used to specify **Conversations** between **Processes** that follow a fairly simple **Conversation** pattern in the sense that:

- The conceptual data of the **Conversation** is well known and defined by the participating **Processes**. However this doesn't mandate that underlying type systems are identical. It is sufficient that the data is known "conceptually" on a (potentially very high) business level.
- A **Conversation** takes place by means of simple **Message** exchange between **Processes**, no additional agreements MUST be considered.
- There exists send and receive **Tasks** accepting the conceptual data of the **Conversation**. (An Order send by a **Task** of a **Process** should be received by at least one **Task** of the participating **Process**).

- The *correlation* itself is defined in terms of correlation fields, which denote a subset of the conceptual data that should be used for the *correlation*. (For example, if the conceptual data comprises an order, then the correlation field might be denoted by the order ID).

In some applications it is useful to allow more **Messages** to be sent between *Participants* when a **Collaboration** is carried out than are contained in the **Collaboration** model. This enables *Participants* to exchange other **Messages** as needed without changing the **Collaboration**. If the `isClosed` attribute of a **Collaboration** has a value of *false* or no value, then *Participants* **MAY** send **Messages** to each other without additional **Message Flows** in the **Collaboration**. If the `isClosed` attribute of a **Collaboration** has a value of *true*, then *Participants* **MAY NOT** send **Messages** to each other without additional **Message Flows** in the **Collaboration**. If a **Collaboration** contains a **Choreography**, then the value of the `isClosed` attribute **MUST** be the same in both. Restrictions on unmodeled messaging specified with `isClosed` apply only under the **Collaboration** containing the restriction. `PartnerEntities` and `PartnerRoles` of the *Participants* **MAY** send **Messages** to each other under other **Choreographies**, **Collaborations**, and **Conversations**.

9.6 Process within Collaboration

Processes can be included in a **Collaboration** diagram. A *Participant/Pool* within the **Collaboration** can contain a **Process** (but they are NOT REQUIRED). An example of this is shown in Figure 9.4.

When a **Lane** (in a **Process**) represents a **Conversation**, the *Flow Elements* in the **Lane** (or elements nested or called in them) that send or receive **Messages** **MUST** do so as part of the **Conversation** represented by the **Lane**.

9.7 Choreography within Collaboration

Choreographies can be included in a **Collaboration** diagram. A **Collaboration** specifies how the *Participants* and **Message Flows** in the **Choreography** are matched up with the *Participants* and **Message Flows** in the **Collaboration**. A **Collaboration** uses `ParticipantAssociations` and `MessageFlowAssociations` for this purpose.

To handle the *Participants*, the `innerParticipant` of a `ParticipantAssociation` refers to a *Participant* in the **Choreography**, while the `outerParticipant` refers to a *Participant* in the **Collaboration** containing the **Choreography**. This mapping matches the **Participant Bands** of the **Choreography Activities** in the **Choreography** to the **Pools** in the **Collaboration**. Thus, the names in the **Participant Bands** are NOT REQUIRED (see Figure 9.32).

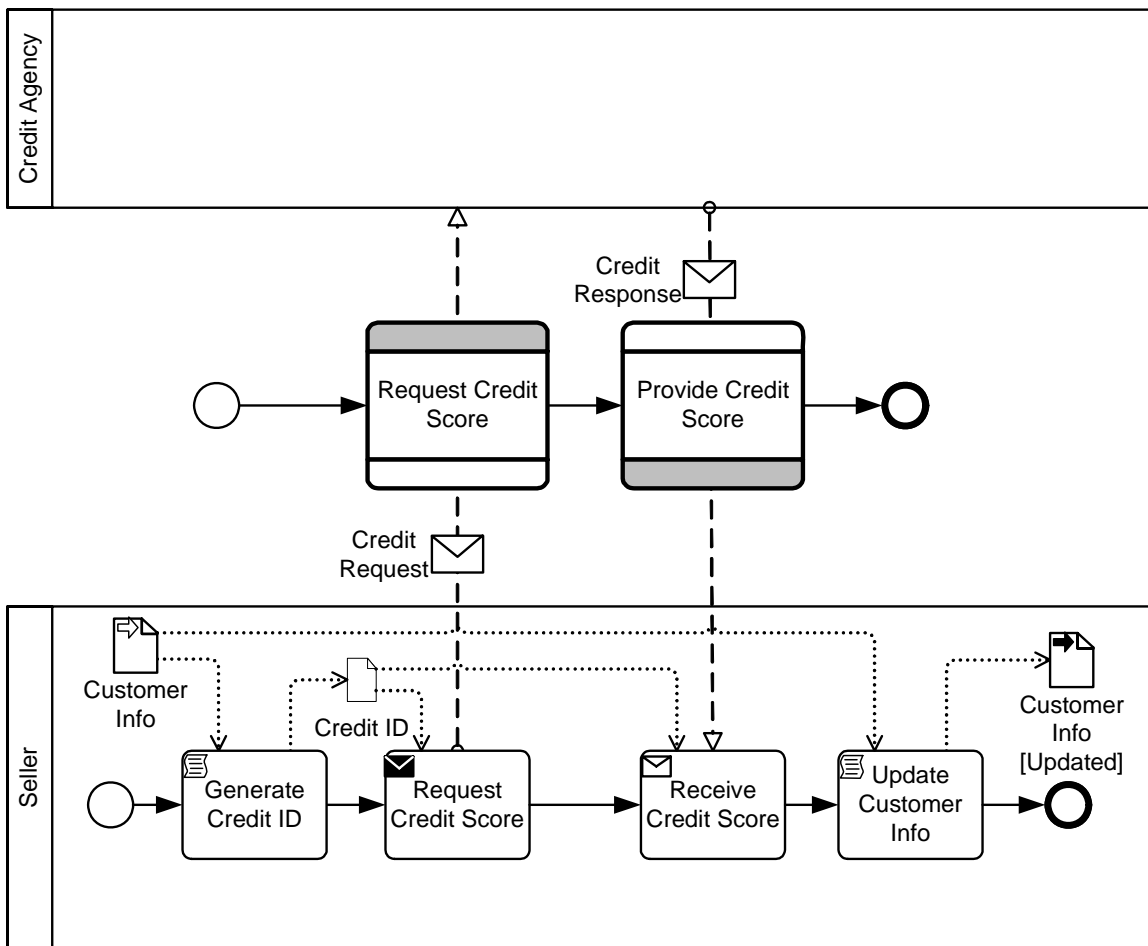

Figure 9.32 – An example of a Choreography within a Collaboration

To handle **Message Flows**, the `innerMessageFlow` of a `MessageFlowAssociation` refers to a **Message Flow** in the **Choreography**, while the `outerMessageFlow` refers to a **Message Flow** in the **Collaboration** containing the **Choreography**. This mapping matches the **Message Flows** of the **Choreography** (which are not visible) to the **Message Flows** in the **Collaboration** (which are visible). This allows the **Message Flows** of the **Collaboration** to be “wired up” through the appropriate **Choreography Activity** in the **Choreography** (see Figure 9.32).

The `ParticipantAssociations` might be derived from the `partnerEntities` or `partnerRoles` of the *Participants*. For example, if a **Choreography Activity** has a *Participant* with the same `partnerEntity` as a *Participant* in the **Collaboration** containing the **Choreography**, then these two *Participants* could be assumed to be the inner and outerParticipants of a `ParticipantAssociation`. Similarly, **Message Flows** that reference the same **Message** in a **Call Choreography Activity** and the **Collaboration**, could be automatically synchronized by a `MessageFlowAssociation`, if only one **Message Flow** has that **Message**.

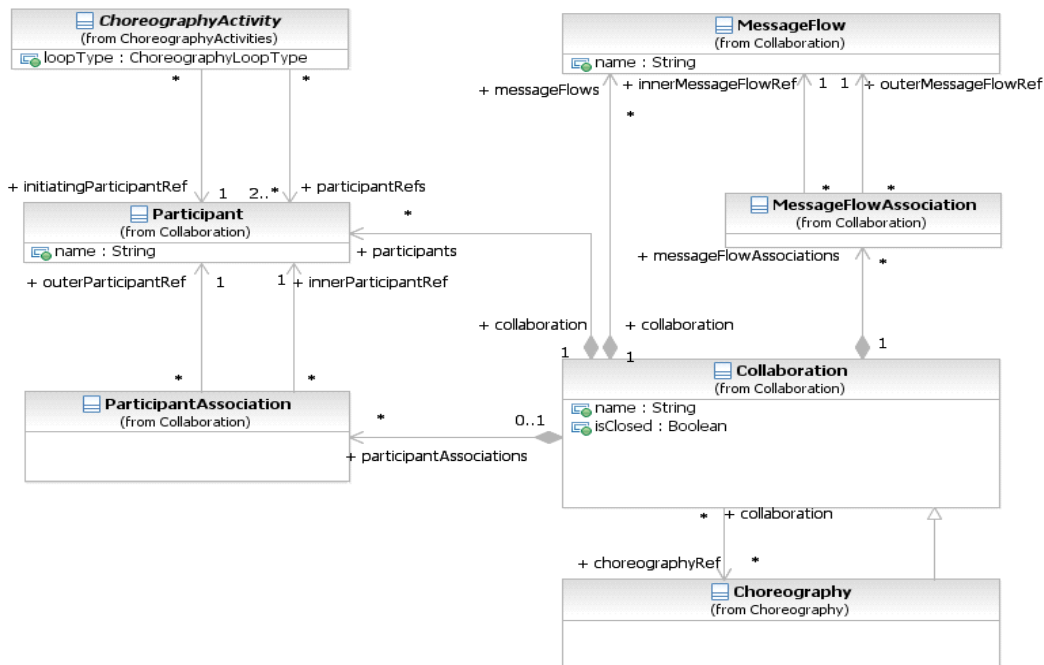

Figure 9.33 – Choreography within Collaboration class diagram

9.8 Collaboration Package XML Schemas

Table 9.15 – Call Conversation XML schema

```

<xsd:element name="callConversation" type="tCallConversation" substitutionGroup="conversationNode"/>
<xsd:complexType name="tCallConversation">
  <xsd:complexContent>
    <xsd:extension base="tConversationNode">
      <xsd:sequence>
        <xsd:element ref="participantAssociation" minOccurs="0" maxOccurs="unbounded"/>
      </xsd:sequence>
      <xsd:attribute name="calledCollaborationRef" type="xsd:QName" use="optional"/>
    </xsd:extension>
  </xsd:complexContent>
</xsd:complexType>

```

Table 9.16 – Collaboration XML schema

```

<xsd:element name="collaboration" type="tCollaboration" substitutionGroup="rootElement"/>
<xsd:complexType name="tCollaboration">
  <xsd:complexContent>
    <xsd:extension base="tRootElement">
      <xsd:sequence>
        <xsd:element name="choreography" minOccurs="0" maxOccurs="unbounded"/>
      </xsd:sequence>
    </xsd:extension>
  </xsd:complexContent>

```



```

    <xsd:element ref="participant" minOccurs="0" maxOccurs="unbounded"/>
    <xsd:element ref="messageFlow" minOccurs="0" maxOccurs="unbounded"/>
    <xsd:element ref="artifact" minOccurs="0" maxOccurs="unbounded"/>
    <xsd:element ref="conversationNode" minOccurs="0" maxOccurs="unbounded"/>
    <xsd:element name="conversationLink" minOccurs="0" maxOccurs="unbounded"/>
    <xsd:element name="conversationAssociation" minOccurs="0" maxOccurs="unbounded"/>
    <xsd:element ref="participantAssociation" minOccurs="0" maxOccurs="unbounded"/>
    <xsd:element name="MessageFlowAssociation" type="tMessageFlowAssociation" minOccurs="0" maxOccurs="unbounded"/>
    <xsd:element ref="correlationKey" minOccurs="0" maxOccurs="unbounded"/>
  </xsd:sequence>
  <xsd:attribute name="name" type="xsd:string"/>
  <xsd:attribute name="isClosed" type="xsd:boolean" default="false"/>
</xsd:extension>
</xsd:complexContent>
</xsd:complexType>

```

Table 9.17 – Conversation XML schema

```

<xsd:element name="conversation" type="tConversation" substitutionGroup="conversationNode"/>
<xsd:complexType name="tConversation">
  <xsd:complexContent>
    <xsd:extension base="tConversationNode"/>
  </xsd:complexContent>
</xsd:complexType>

```

Table 9.18 – ConversationAssociation XML schema

```

<xsd:element name="conversationAssociation" type="tConversationAssociation"/>
<xsd:complexType name="tConversationAssociation">
  <xsd:complexContent>
    <xsd:extension base="tBaseElement">
      <xsd:attribute name="innerConversationNodeRef" type="xsd:QName" use="required"/>
      <xsd:attribute name="outerConversationNodeRef" type="xsd:QName" use="required"/>
    </xsd:extension>
  </xsd:complexContent>
</xsd:complexType>

```

Table 9.19 – ConversationAssociation XML schema

```

<xsd:element name="conversationLink" type="tConversationLink"/>
<xsd:complexType name="tConversationLink">
  <xsd:complexContent>
    <xsd:extension base="tBaseElement">
      <xsd:attribute name="name" type="xsd:string" use="optional"/>
      <xsd:attribute name="sourceRef" type="xsd:QName" use="required"/>
      <xsd:attribute name="targetRef" type="xsd:QName" use="required"/>
    </xsd:extension>
  </xsd:complexContent>
</xsd:complexType>

```

Table 9.20 – ConversationNode XML schema

```
<xsd:element name="conversation" type="tConversation" substitutionGroup="rootElement"/>
<xsd:complexType name="tConversation">
  <xsd:complexContent>
    <xsd:extension base="tCallableElement">
      <xsd:sequence>
        <xsd:element ref="conversationNode" minOccurs="0" maxOccurs="unbounded"/>
        <xsd:element ref="participant" minOccurs="0" maxOccurs="unbounded"/>
        <xsd:element ref="artifact" minOccurs="0" maxOccurs="unbounded"/>
        <xsd:element ref="messageFlow" minOccurs="0" maxOccurs="unbounded"/>
        <xsd:element name="messageFlowRef" type="xsd:QName" minOccurs="0" maxOccurs="unbounded"/>
        <xsd:element ref="correlationKey" minOccurs="0" maxOccurs="unbounded"/>
      </xsd:sequence>
    </xsd:extension>
  </xsd:complexContent>
</xsd:complexType>
```

Table 9.21 – Conversation Node XML schema

```
<xsd:element name="conversationNode" type="tConversationNode"/>
<xsd:complexType name="tConversationNode" abstract="true">
  <xsd:complexContent>
    <xsd:extension base="tBaseElement">
      <xsd:sequence>
        <xsd:element name="messageFlowRef" type="xsd:QName" minOccurs="0" maxOccurs="unbounded"/>
        <xsd:element name="participantRef" type="xsd:QName" minOccurs="0" maxOccurs="unbounded"/>
      </xsd:sequence>
      <xsd:attribute name="conversationRef" type="xsd:QName"/>
      <xsd:attribute name="correlationKeyRef" type="xsd:QName"/>
    </xsd:extension>
  </xsd:complexContent>
</xsd:complexType>
```

Table 9.22 – Global Conversation XML schema

```
<xsd:element name="globalConversation" type="tGlobalConversation" substitutionGroup="collaboration"/>
<xsd:complexType name="tGlobalConversation">
  <xsd:complexContent>
    <xsd:extension base="tCollaboration"/>
  </xsd:complexContent>
</xsd:complexType>
```

Table 9.23 – MessageFlow XML schema

```
<xsd:element name="messageFlow" type="tMessageFlow"/>
<xsd:complexType name="tMessageFlow">
  <xsd:complexContent>
    <xsd:extension base="tBaseElement">
```

```

    <xsd:attribute name="name" type="xsd:string" use="optional"/>
    <xsd:attribute name="sourceRef" type="xsd:QName" use="required"/>
    <xsd:attribute name="targetRef" type="xsd:QName" use="required"/>
    <xsd:attribute name="messageRef" type="xsd:QName"/>
  </xsd:extension>
</xsd:complexContent>
</xsd:complexType>

```

Table 9.24 – MessageFlowAssociation XML schema

```

<xsd:element name="messageFlowAssociation" type="tMessageFlowAssociation"/>
<xsd:complexType name="tMessageFlowAssociation">
  <xsd:complexContent>
    <xsd:extension base="tBaseElement">
      <xsd:attribute name="innerMessageFlowRef" type="xsd:QName" use="required"/>
      <xsd:attribute name="outerMessageFlowRef" type="xsd:QName" use="required"/>
    </xsd:extension>
  </xsd:complexContent>
</xsd:complexType>

```

Table 9.25 – Participant XML schema

```

<xsd:element name="participant" type="tParticipant"/>
<xsd:complexType name="tParticipant">
  <xsd:complexContent>
    <xsd:extension base="tBaseElement">
      <xsd:sequence>
        <xsd:element name="interfaceRef" type="xsd:QName" minOccurs="0" maxOccurs="unbounded"/>
        >
        <xsd:element name="endPointRef" type="xsd:QName" minOccurs="0" maxOccurs="unbounded"/>
        >
        <xsd:element ref="participantMultiplicity" minOccurs="0" maxOccurs="1"/>
      </xsd:sequence>
      <xsd:attribute name="name" type="xsd:string"/>
      <xsd:attribute name="processRef" type="xsd:QName" use="optional"/>
    </xsd:extension>
  </xsd:complexContent>
</xsd:complexType>

```

Table 9.26 – ParticipantAssociation XML schema

```

<xsd:element name="participantAssociation" type="tParticipantAssociation"/>
<xsd:complexType name="tParticipantAssociation">
  <xsd:complexContent>
    <xsd:extension base="tBaseElement">
      <xsd:sequence>
        <xsd:element name="innerParticipantRef" type="xsd:QName" use="required"/>
        <xsd:element name="outerParticipantRef" type="xsd:QName" use="required"/>
      </xsd:sequence>
    </xsd:extension>
  </xsd:complexContent>

```

```
</xsd:complexType>
```

Table 9.27 – ParticipantMultiplicity XML schema

```
<xsd:element name="participantMultiplicity" type="tParticipantMultiplicity"/>
<xsd:complexType name="tParticipantMultiplicity">
  <xsd:complexContent>
    <xsd:extension base="tBaseElement">
      <xsd:attribute name="minimum" type="xsd:int"/>
      <xsd:attribute name="maximum" type="xsd:int"/>
    </xsd:extension>
  </xsd:complexContent>
</xsd:complexType>
```

Table 9.28 – PartnerEntity XML schema

```
<xsd:element name="partnerEntity" type="tPartnerEntity" substitutionGroup="rootElement"/>
<xsd:complexType name="tPartnerEntity">
  <xsd:complexContent>
    <xsd:extension base="tRootElement">
      <xsd:attribute name="name" type="xsd:string"/>
    </xsd:extension>
  </xsd:complexContent>
</xsd:complexType>
```

Table 9.29 – PartnerRole XML schema

```
<xsd:element name="partnerRole" type="tPartnerRole" substitutionGroup="rootElement"/>
<xsd:complexType name="tPartnerRole">
  <xsd:complexContent>
    <xsd:extension base="tRootElement">
      <xsd:attribute name="name" type="xsd:string"/>
    </xsd:extension>
  </xsd:complexContent>
</xsd:complexType>
```

Table 9.30 – Sub-Conversation XML schema

```
<xsd:element name="subConversation" type="tSubConversation" substitutionGroup="conversationNode"/>
<xsd:complexType name="tSubConversation">
  <xsd:complexContent>
    <xsd:extension base="tConversationNode">
      <xsd:sequence>
        <xsd:element ref="conversationNode" minOccurs="0" maxOccurs="unbounded"/>
      </xsd:sequence>
    </xsd:extension>
  </xsd:complexContent>
</xsd:complexType>
```

10 Process

10.1 General

NOTE: The content of this clause is REQUIRED for **BPMN Process Modeling Conformance** or for **BPMN Complete Conformance**. However, this clause is NOT REQUIRED for **BPMN Process Choreography Conformance**, **BPMN Process Execution Conformance**, or **BPMN BPEL Process Execution Conformance**. For more information about **BPMN** conformance types, see page 1.

A **Process** describes a sequence or flow of **Activities** in an organization with the objective of carrying out work. In **BPMN** a **Process** is depicted as a graph of Flow Elements, which are a set of **Activities**, **Events**, **Gateways**, and **Sequence Flows** that define finite execution semantics (see Figure 10.1). **Processes** can be defined at any level from enterprise-wide **Processes** to **Processes** performed by a single person. Low-level **Processes** can be grouped together to achieve a common business goal.

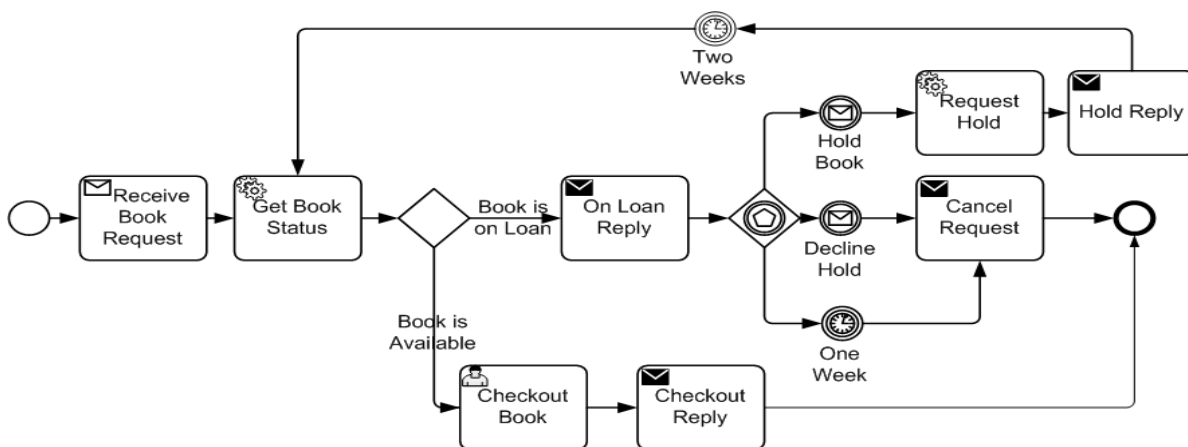

Figure 10.1 – An Example of a Process

Note that **BPMN** uses the term **Process** specifically to mean a set of *flow elements*. It uses the terms **Collaboration** and **Choreography** when modeling the interaction between **Processes**.

The **Process** package contains classes that are used for modeling the flow of **Activities**, **Events**, and **Gateways**, and how they are sequenced within a **Process** (see Figure 10.2). When a **Process** is defined it is contained within **Definitions**.

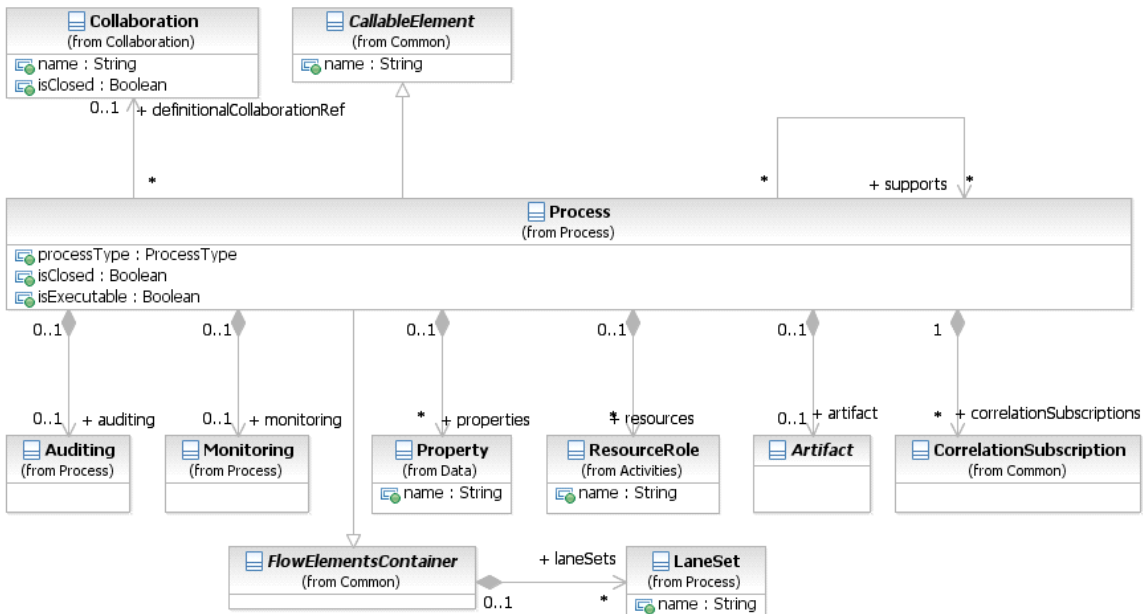

Figure 10.3 – Process Details class diagram

The **Process** element inherits the attributes and model associations of **CallableElement** (see Table 10.24) and of **FlowElementContainer** (see Table 8.45). Table 10.1 presents the additional attributes and model associations of the **Process** element:

Table 10.1 – Process Attributes & Model Associations

Attribute Name	Description/Usage
processType: ProcessType = none { None Private Public }	The <code>processType</code> attribute Provides additional information about the level of abstraction modeled by this Process . A public Process shows only those flow elements that are relevant to external consumers. Internal details are not modeled. These Processes are publicly visible and can be used within a Collaboration . Note that the public <code>processType</code> was named abstract in BPMN 1.2 . A private Process is one that is internal to a specific organization. By default, the <code>processType</code> is “none,” meaning undefined.

Table 10.1 – Process Attributes & Model Associations

<p>isExecutable: boolean [0..1]</p>	<p>An optional Boolean value specifying whether the Process is executable.</p> <p>An executable Process is a private Process that has been modeled for the purpose of being executed according to the semantics of Clause 14 (see page 426). Of course, during the development cycle of the Process, there will be stages where the Process does not have enough detail to be “executable.”</p> <p>A non-executable Process is a private Process that has been modeled for the purpose of documenting Process behavior at a modeler-defined level of detail. Thus, information needed for execution, such as formal condition expressions are typically not included in a non-executable Process.</p> <p>For public Processes, no value has the same semantics as if the value were <i>false</i>. The value MAY not be <i>true</i> for public Processes.</p>
<p>auditing: Auditing [0..1]</p>	<p>This attribute provides a hook for specifying audit related properties.</p>
<p>monitoring: Monitoring [0..1]</p>	<p>This attribute provides a hook for specifying monitoring related properties.</p>
<p>artifacts: Artifact [0..*]</p>	<p>This attribute provides the list of Artifacts that are contained within the Process.</p>
<p>IsClosed: boolean = false</p>	<p>A boolean value specifying whether interactions, such as sending and receiving Messages and Events, not modeled in the Process can occur when the Process is executed or performed. If the value is <i>true</i>, they MAY NOT occur. If the value is <i>false</i>, they MAY occur.</p>
<p>supports: Process [0..*]</p>	<p>Modelers can declare that they intend all executions or performances of one Process to also be valid for another Process. This means they expect all the executions or performances of the first Processes to also follow the steps laid out in the second Process.</p>
<p>properties: Property [0..*]</p>	<p>Modeler-defined <i>properties</i> MAY be added to a Process. These <i>properties</i> are contained within the Process. All Tasks and Sub-Processes SHALL have access to these <i>properties</i>.</p>
<p>resources: ResourceRole [0..*]</p>	<p>Defines the resource that will perform or will be responsible for the Process. The resource, e.g., a performer, can be specified in the form of a specific individual, a group, an organization role or position, or an organization.</p> <p>Note that the assigned resources of the Process does not determine the assigned resources of the Activities that are contained by the Process. See more details about resource assignment on page 152.</p>

Table 10.1 – Process Attributes & Model Associations

correlationSubscriptions: CorrelationSubscription [0..*]	correlationSubscriptions are a feature of context-based correlation (cf. sub clause 8.3.3). CorrelationSubscriptions are used to correlate incoming Messages against data in the Process context. A Process MAY contain several correlationSubscriptions.
definitionalCollaborationRef: Collaboration [0..1]	For Processes that interact with other Participants, a definitional Collaboration can be referenced by the Process . The definitional Collaboration specifies the Participants the Process interacts with, and more specifically, which individual service, Send or Receive Task , or Message Event , is connected to which Participant through Message Flows . The definitional Collaboration need not be displayed. Additionally, the definitional Collaboration can be used to include Conversation information within a Process .

In addition, a **Process** *instance* has attributes whose values MAY be referenced by Expressions (see Table 10.2). These values are only available when the **Process** is being executed.

Table 10.2 – Process instance attributes

Attribute Name	Description/Usage
state: string = None	See Figure 13.2 ("The Lifecycle of a BPMN Activity") in Section 13.3.2 for permissible values.

10.2 Basic Process Concepts

10.2.1 Types of BPMN Processes

Business Process modeling is used to communicate a wide variety of information to a wide variety of audiences. **BPMN** is designed to cover many types of modeling and allows the creation of end-to-end **Business Processes**. There are three basic types of **BPMN Processes**:

1. *Private Non-executable (internal)* **Business Processes**
2. *Private Executable (internal)* **Business Processes**
3. *Public* **Processes**

10.2.1.1 Private (Internal) Business Processes

Private Business Processes are those internal to a specific organization. These **Processes** have been generally called workflow or BPM **Processes** (see Figure 10.4). Another synonym typically used in the Web services area is the *Orchestration* of services. There are two types of *private Processes*: *executable* and *non-executable*. An *executable Process* is a **Process** that has been modeled for the purpose of being executed according to the semantics defined in Clause 14 (see page 426). Of course, during the development cycle of the **Process**, there will be stages where the

Process does not have enough detail to be “executable.” A non-executable **Process** is a *private Process* that has been modeled for the purpose of documenting **Process** behavior at a modeler-defined level of detail. Thus, information needed for execution, such as formal condition **Expressions** are typically not included in a *non-executable Process*.

If a swimlanes-like notation is used (e.g., a **Collaboration**, see below), then a *private Business Process* will be contained within a single **Pool**. The **Process** flow is therefore contained within the **Pool** and cannot cross the boundaries of the **Pool**. The flow of **Messages** can cross the **Pool** boundary to show the interactions that exist between separate *private Business Processes*.



Figure 10.4 – Example of a private Business Process

10.2.1.2 Public Processes

A *public Process* represents the interactions between a *private Business Process* and another **Process** or **Participant** (see Figure 10.5). Only those **Activities** that are used to communicate to the other **Participant(s)**, plus the order of these **Activities**, are included in the *public Process*. All other “internal” **Activities** of the *private Business Process* are not shown in the *public Process*. Thus, the *public Process* shows to the outside world the **Messages**, and the order of these **Messages**, that are needed to interact with that **Business Process**. *Public Processes* can be modeled separately or within a **Collaboration** to show the flow of **Messages** between the *public Process Activities* and other **Participants**. Note that the *public* type of **Process** was named “abstract” in **BPMN 1.2**.

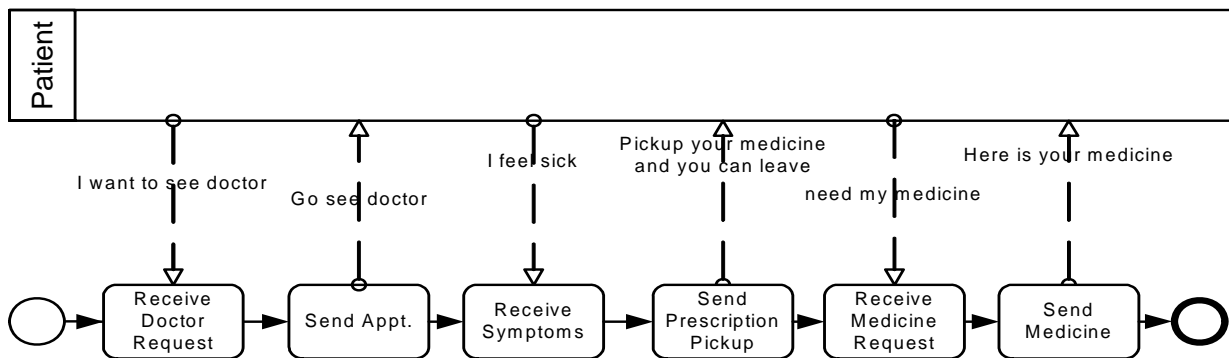

Figure 10.5 – Example of a *public Process*

10.2.2 Use of BPMN Common Elements

Some **BPMN** elements are common to both **Process** and **Choreography**, as well as **Collaboration**; they are used in these diagrams. The next few sub clauses will describe the use of **Messages**, **Message Flows**, **Participants**, **Sequence Flows**, **Artifacts**, **Correlations**, **Expressions**, and **Services** in **Choreography**.

The key graphical elements of **Gateways** and **Events** are also common to both **Choreography** and **Process**. Since their usage has a large impact, they are described in major sub clauses of this clause (see page 232 for **Events** and page 286 for **Gateways**).

10.3 Activities

An **Activity** is work that is performed within a **Business Process**. An **Activity** can be atomic or non-atomic (compound). The types of **Activities** that are a part of a **Process** are: **Task**, **Sub-Process**, and **Call Activity**, which allows the inclusion of re-usable **Tasks** and **Processes** in the diagram. However, a **Process** is not a specific graphical object. Instead, it is a set of graphical objects. The following sub clauses will focus on the graphical objects **Sub-Process** and **Task**.

Activities represent points in a **Process** flow where work is performed. They are the executable elements of a **BPMN Process**.

The **Activity** class is an abstract element, sub-classing from **FlowElement** (as shown in Figure 10.6).

Concrete sub-classes of **Activity** specify additional semantics above and beyond that defined for the generic **Activity**.

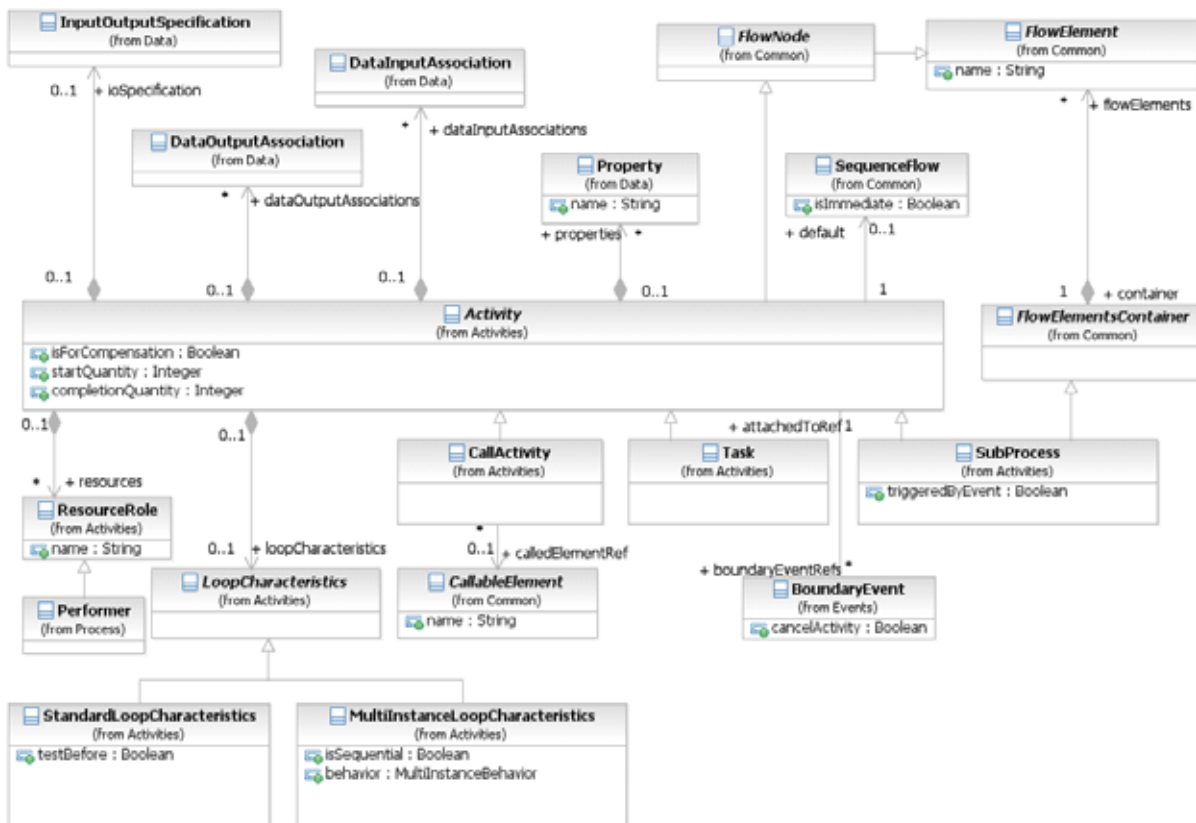

Figure 10.6 – Activity class diagram

The **Activity** class is the abstract super class for all concrete **Activity** types.

The **Activity** element inherits the attributes and model associations of **FlowElement** (see Table 8.44). Table 10.3 presents the additional attributes and model associations of the **Activity** element.

Table 10.3 – Activity attributes and model associations

Attribute Name	Description/Usage
isForCompensation: boolean = false	A flag that identifies whether this Activity is intended for the purposes of <i>compensation</i> . If <i>false</i> , then this Activity executes as a result of normal execution flow. If <i>true</i> , this Activity is only activated when a Compensation Event is detected and initiated under Compensation Event visibility scope (see page 280 for more information on <i>scopes</i>).
loopCharacteristics: LoopCharacteristics [0..1]	An Activity MAY be performed once or MAY be repeated. If repeated, the Activity MUST have <i>loopCharacteristics</i> that define the repetition criteria (if the <i>isExecutable</i> attribute of the Process is set to <i>true</i>).
resources: ResourceRole [0..*]	Defines the resource that will perform or will be responsible for the Activity . The resource, e.g., a performer, can be specified in the form of a specific individual, a group, an organization role or position, or an organization.
default: SequenceFlow [0..1]	The Sequence Flow that will receive a <i>token</i> when none of the <i>conditionExpressions</i> on other <i>outgoing Sequence Flows</i> evaluate to <i>true</i> . The <i>default Sequence Flow</i> should not have a <i>conditionExpression</i> . Any such <i>Expression</i> SHALL be ignored.
ioSpecification: Input OutputSpecification [0..1]	The <i>InputOutputSpecification</i> defines the <i>inputs</i> and <i>outputs</i> and the <i>InputSets</i> and <i>OutputSets</i> for the Activity . See page 210 for more information on the <i>InputOutputSpecification</i> .
properties: Property [0..*]	Modeler-defined <i>properties</i> MAY be added to an Activity . These <i>properties</i> are contained within the Activity .
boundaryEventRefs: BoundaryEvent [0..*]	This references the Intermediate Events that are attached to the boundary of the Activity .
dataInputAssociations: DataInputAssociation [0..*]	An optional reference to the <i>DataInputAssociations</i> . A <i>DataInputAssociation</i> defines how the <i>DataInput</i> of the Activity's <i>InputOutputSpecification</i> will be populated.
dataOutputAssociations: DataOutputAssociation [0..*]	An optional reference to the <i>DataOutputAssociations</i> .
startQuantity: integer = 1	The default value is 1. The value MUST NOT be less than 1. This attribute defines the number of <i>tokens</i> that MUST arrive before the Activity can begin. Note that any value for the attribute that is greater than 1 is an advanced type of modeling and should be used with caution.

Table 10.3 – Activity attributes and model associations

completionQuantity: integer = 1	The default value is 1. The value MUST NOT be less than 1. This attribute defines the number of <i>tokens</i> that MUST be generated from the Activity . This number of tokens will be sent done any <i>outgoing Sequence Flow</i> (assuming any Sequence Flow conditions are satisfied). Note that any value for the attribute that is greater than 1 is an advanced type of modeling and should be used with caution.
--	---

In addition, an **Activity** *instance* has attributes whose values **MAY** be referenced by *Expressions*. These values are only available when the **Activity** is being executed.

Table 10.4 presents the *instance* attributes of the **Activity** element.

Table 10.4 – Activity instance attributes

Attribute Name	Description/Usage
state: string = None	See Figure 13.2 ("The Lifecycle of a BPMN Activity") in Section 13.3.2 for permissible values.

Sequence Flow Connections

See “Sequence Flow Connections Rules” on page 40 for the entire set of objects and how they **MAY** be *sources* or *targets* of **Sequence Flows**.

- ◆ An **Activity** **MAY** be a target for **Sequence Flows**; it can have multiple *incoming Sequence Flows*. *Incoming Sequence Flows* **MAY** be from an alternative path and/or parallel paths.
- ◆ If the **Activity** does not have an *incoming Sequence Flow*, then the **Activity** **MUST** be instantiated when the **Process** is instantiated.
- ◆ There are two exceptions to this: **Compensation Activities** and **Event Sub-Processes**.

NOTE: If the **Activity** has multiple *incoming Sequence Flows*, then this is considered uncontrolled flow. This means that when a *token* arrives from one of the Paths, the **Activity** will be instantiated. It will not wait for the arrival of *tokens* from the other paths. If another *token* arrives from the same path or another path, then a separate *instance* of the **Activity** will be created. If the flow needs to be controlled, then the flow should converge on a **Gateway** that precedes the **Activities** (see “Gateways” on page 286 for more information on **Gateways**).

- ◆ An **Activity** **MAY** be a source for **Sequence Flows**; it can have multiple *outgoing Sequence Flows*. If there are multiple *outgoing Sequence Flows*, then this means that a separate parallel path is being created for each **Sequence Flow** (i.e., *tokens* will be generated for each *outgoing Sequence Flow* from the **Activity**).
- ◆ If the **Activity** does not have an *outgoing Sequence Flow*, then the **Activity** marks the end of one or more paths in the **Process**. When the **Activity** ends and there are no other parallel paths active, then the **Process** **MUST** be completed.
- ◆ There are two exceptions to this: **Compensation Activities** and **Event Sub-Processes**.

Message Flow Connections

See “Message Flow Connection Rules” on page 41 for the entire set of objects and how they **MAY** be *sources* or *targets* of **Message Flows**.

NOTE: All **Message Flows** MUST connect two separate **Pools**. They MAY connect to the **Pool** boundary or to Flow Objects within the **Pool** boundary. They MUST NOT connect two objects within the same **Pool**.

- ◆ An **Activity** MAY be the target of a **Message Flow**; it can have zero (0) or more *incoming* **Message Flows**.
- ◆ An **Activity** MAY be a source of a **Message Flow**; it can have zero (0) or more *outgoing* **Message Flows**.

10.3.1 Resource Assignment

The following sub clauses define how **Resources** can be defined for an **Activity**. Figure 10.7 displays the class diagram for the **BPMN** elements used for **Resource** assignment.

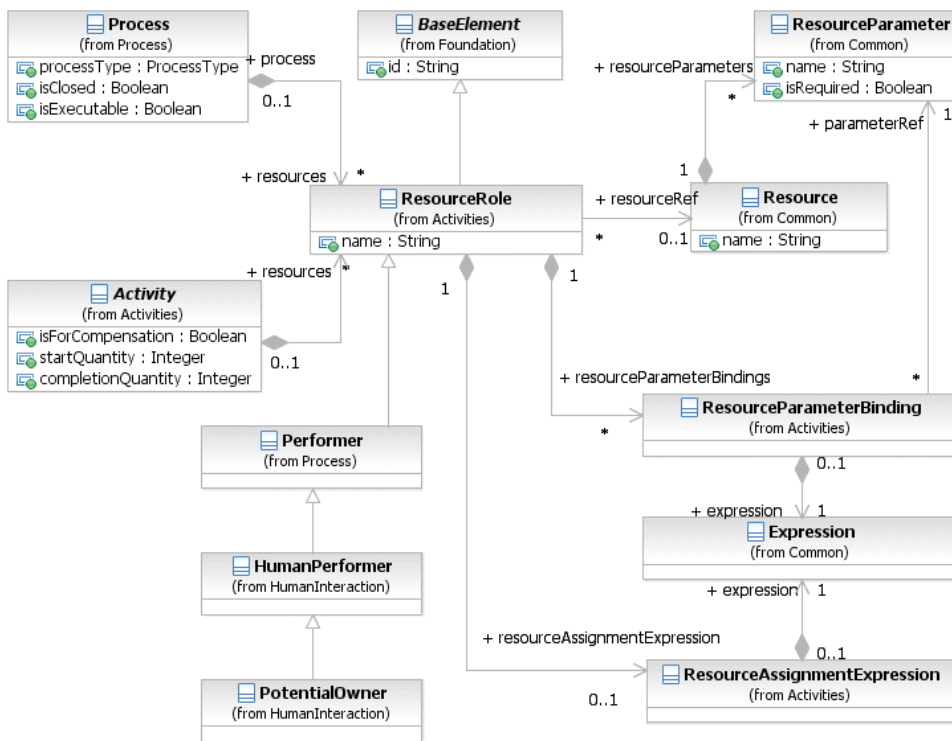

Figure 10.7 – The class diagram for assigning Resources

Resource Role

The **ResourceRole** element inherits the attributes and model associations of **BaseElement** (see Table 8.5). Table 10.5 presents the additional model associations of the **ResourceRole** element.

Table 10.5 – Resource Role model associations

Attribute Name	Description/Usage
resourceRef: Resource [0..1]	The <code>Resource</code> that is associated with Activity . Should not be specified when <code>resourceAssignmentExpression</code> is provided.
resourceAssignmentExpression: ResourceAssignmentExpression [0..1]	This defines the <code>Expression</code> used for the <code>Resource</code> assignment (see below). Should not be specified when a <code>resourceRef</code> is provided.
resourceParameterBindings: Resource-ParameterBinding [0..*]	This defines the <code>Parameter</code> bindings used for the <code>Resource</code> assignment (see below). Is only applicable if a <code>resourceRef</code> is specified.

Expression Assignment

Resources can be assigned to an **Activity** using Expressions. These Expressions **MUST** return Resource entity related data types, like Users or Groups. Different Expressions can return multiple Resources. All of them are assigned to the respective subclass of the ResourceRole element, for example as potential owners. The semantics is defined by the subclass.

The ResourceAssignmentExpression element inherits the attributes and model associations of BaseElement (see Table 8.5). Table 10.6 presents the additional model associations of the ResourceAssignmentExpression element.

Table 10.6 – ResourceAssignmentExpression model associations

Attribute Name	Description/Usage
expression: Expression	The element ResourceAssignmentExpression MUST contain an Expression which is used at runtime to assign resource(s) to a ResourceRole element.

Parameterized Resource Assignment

Resources support query parameters that are passed to the Resource query at runtime. Parameters **MAY** refer to **Task** *instance* data using Expressions. During Resource query execution, an infrastructure can decide which of the Parameters defined by the Resource are used. It **MAY** use zero (0) or more of the Parameters specified. It **MAY** also override certain Parameters with values defined during Resource deployment. The deployment mechanism for **Tasks** and Resources is out of scope for this document. Resource queries are evaluated to determine the set of Resources, e.g., people, assigned to the **Activity**. Failed Resource queries are treated like Resource queries that return an empty result set. Resource queries return one Resource or a set of Resources.

The ResourceParameterBinding element inherits the attributes and model associations of BaseElement (see Table 8.5). Table 10.7 presents the additional model associations of the ResourceParameterBinding element.

Table 10.7 – ResourceParameterBinding model associations

Attribute Name	Description/Usage
parameterRef: ResourceParameter	Reference to the parameter defined by the Resource.
expression: Expression	The Expression that evaluates the value used to bind the ResourceParameter.

10.3.2 Performer

The Performer class defines the resource that will perform or will be responsible for an **Activity**. The performer can be specified in the form of a specific individual, a group, an organization role or position, or an organization.

The Performer element inherits the attributes and model associations of BaseElement (see Table 8.5) through its relationship to ResourceRole, but does not have any additional attributes or model associations.

10.3.3 Tasks

A **Task** is an *atomic Activity* within a **Process** flow. A **Task** is used when the work in the **Process** cannot be broken down to a finer level of detail. Generally, an end-user and/or applications are used to perform the **Task** when it is executed.

A **Task** object shares the same shape as the **Sub-Process**, which is a rectangle that has rounded corners (see Figure 10.8).

- ◆ A **Task** is a rounded corner rectangle that **MUST** be drawn with a single thin line.
- ◆ The use of text, color, size, and lines for a **Task** **MUST** follow the rules defined in “Use of Text, Color, Size, and Lines in a Diagram” on page 39.
 - ◆ A boundary drawn with a thick line **SHALL** be reserved for **Call Activity** (Global Tasks) (see page 186).
 - ◆ A boundary drawn with a dotted line **SHALL** be reserved for **Event Sub-Processes** (see page 174) and thus are not allowed for **Tasks**.
 - ◆ A boundary drawn with a double line **SHALL** be reserved for **Transaction Sub-Processes** (see page 176) and thus are not allowed for **Tasks**.



Figure 10.8 – A Task object

BPMN specifies three types of markers for **Task**: a **Loop** marker or a **Multi-Instance** marker and a **Compensation** marker. A **Task** **MAY** have one or two of these markers (see Figure 10.9).

- ◆ The marker for a **Task** that is a standard *loop* MUST be a small line with an arrowhead that curls back upon itself. See page 188 for more information on *loop Activities*.
- ◆ The *loop* Marker MAY be used in combination with the *compensation* marker.
- ◆ The marker for a **Task** that is a *multi-instance* MUST be a set of three vertical lines. See page 190 for more information on *multi-instance Activities*.
- ◆ If the *multi-instance instances* are set to be performed in sequence rather than parallel, then the marker will be rotated 90 degrees (see Figure 10.49).
- ◆ The *multi-instance* marker MAY be used in combination with the *compensation* marker.
- ◆ The marker for a **Task** that is used for *compensation* MUST be a pair of left facing triangles (like a tape player “rewind” button). See page 301 for more information on *compensation*.
- ◆ The **Compensation** Marker MAY be used in combination with the *loop* marker or the *multi-instance* marker.

All the markers that are present MUST be grouped and the whole group centered at the bottom of the shape.



Figure 10.9 – Task markers

Figure 10.10 displays the class diagram for the Task element.

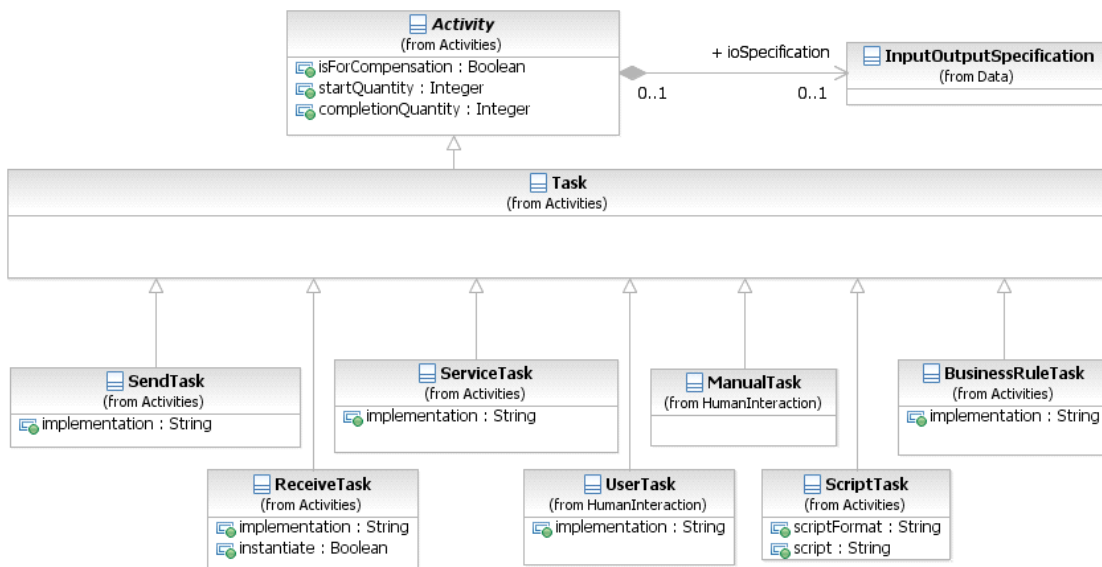

Figure 10.10 – The Task class diagram

The **Task** inherits the attributes and model associations of **Activity** (see Table 10.3). There are no further attributes or model associations of the **Task**.

10.3.3.1 Types of Tasks

There are different types of **Tasks** identified within **BPMN** to separate the types of inherent behavior that **Tasks** might represent. The list of **Task** types **MAY** be extended along with any corresponding indicators. A **Task** which is not further specified is called **Abstract Task** (this was referred to as the **None Task** in **BPMN 1.2**). The notation of the **Abstract Task** is shown in Figure 10.8.

Service Task

A **Service Task** is a **Task** that uses some sort of service, which could be a Web service or an automated application.

A **Service Task** object shares the same shape as the **Task**, which is a rectangle that has rounded corners. However, there is a graphical marker in the upper left corner of the shape that indicates that the **Task** is a **Service Task** (see Figure 10.11).

A **Service Task** is a rounded corner rectangle that **MUST** be drawn with a single thin line and includes a marker that distinguishes the shape from other **Task** types (as shown in Figure 10.11).

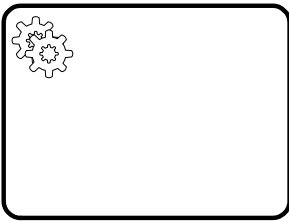

Figure 10.11 – A Service Task Object

The **Service Task** inherits the attributes and model associations of **Activity** (see Table 10.3). In addition the following constraints are introduced when the **Service Task** references an **Operation**: The **Service Task** has exactly one **inputSet** and at most one **outputSet**. It has a single **Data Input** with an **ItemDefinition** equivalent to the one defined by the **Message** referenced by the **inMessageRef** attribute of the associated **Operation**. If the **Operation** defines output **Messages**, the **Service Task** has a single **Data Output** that has an **ItemDefinition** equivalent to the one defined by the **Message** referenced by the **outMessageRef** attribute of the associated **Operation**.

The actual *Participant* whose service is used can be identified by connecting the **Service Task** to a *Participant* using a **Message Flows** within the definitional **Collaboration** of the **Process** – see Table 10.1.

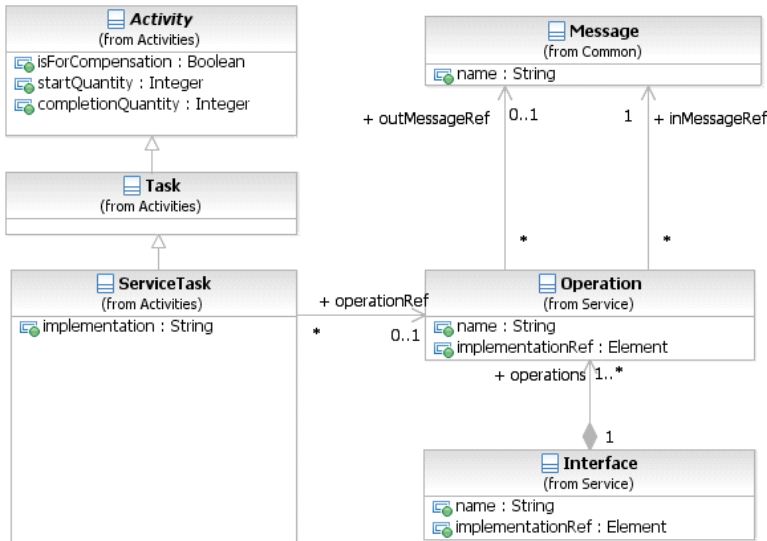

Figure 10.12 – The Service Task class diagram

The **Service Task** inherits the attributes and model associations of **Activity** (see Table 10.3). Table 10.8 presents additional the model associations of the **Service Task**.

Table 10.8 – Service Task model associations

Attribute Name	Description/Usage
implementation: string = ##webService	This attribute specifies the technology that will be used to send and receive the Messages . Valid values are "##unspecified" for leaving the implementation technology open, "##WebService" for the Web service technology or a URI identifying any other technology or coordination protocol. A Web service is the default technology.
operationRef: Operation [0..1]	This attribute specifies the operation that is invoked by the Service Task.

Send Task

A **Send Task** is a simple **Task** that is designed to send a **Message** to an external Participant (relative to the **Process**). Once the **Message** has been sent, the **Task** is completed.

The actual *Participant* which the **Message** is sent can be identified by connecting the **Send Task** to a *Participant* using a **Message Flows** within the definitional **Collaboration** of the **Process** (see Table 10.1).

A **Send Task** object shares the same shape as the **Task**, which is a rectangle that has rounded corners. However, there is a filled envelope marker (the same marker as a *throw Message Event*) in the upper left corner of the shape that indicates that the **Task** is a **Send Task**.

A **Send Task** is a rounded corner rectangle that **MUST** be drawn with a single thin line and includes a filled envelope marker that distinguishes the shape from other **Task** types (as shown in Figure 10.13).

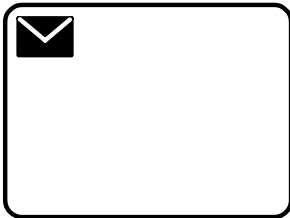

Figure 10.13 – A Send Task Object

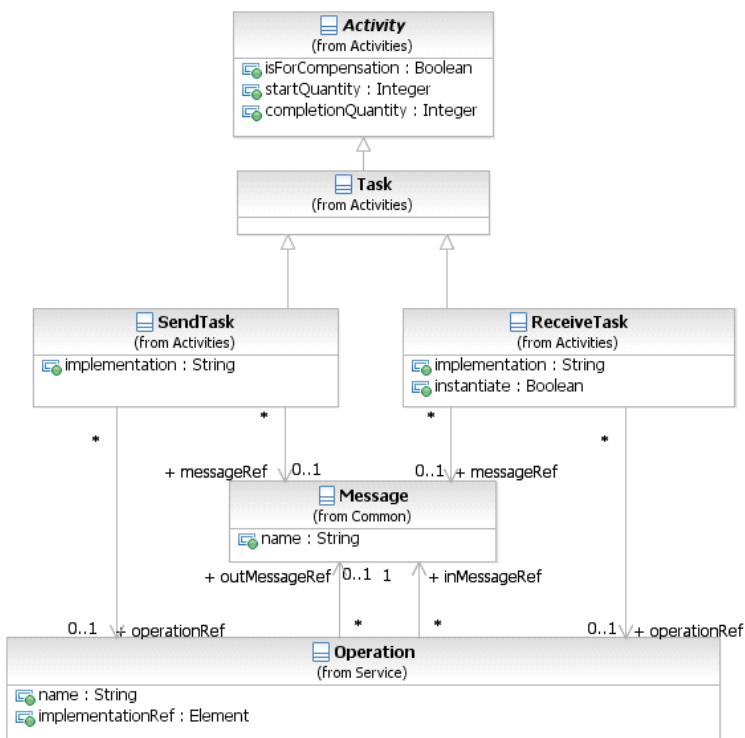

Figure 10.14 – The Send Task and Receive Task class diagram

The **Send Task** inherits the attributes and model associations of **Activity** (see Table 10.3). In addition the following constraints apply when the **Send Task** references a **Message**: The **Send Task** has at most one **inputSet** and one **Data Input**. If the **Data Input** is present, it **MUST** have an **ItemDefinition** equivalent to the one defined by the associated **Message**. At execution time, when the **Send Task** is executed, the data automatically moves from the **Data Input** on the **Send Task** into the **Message** to be sent. If the **Data Input** is not present, the **Message** will not be populated with data from the **Process**.

Table 10.9 presents the additional model associations of the **Send Task**.

Table 10.9 – Send Task model associations

Attribute Name	Description/Usage
messageRef: Message [0..1]	A Message for the <code>messageRef</code> attribute MAY be entered. This indicates that the Message will be sent by the Task . The Message in this context is equivalent to an <i>out-only</i> message pattern (Web service). One or more corresponding <i>outgoing Message Flows</i> MAY be shown on the diagram. However, the display of the Message Flows is NOT REQUIRED. The Message is applied to all <i>outgoing Message Flows</i> and the Message will be sent down all <i>outgoing Message Flows</i> at the completion of a single <i>instance</i> of the Task .
operationRef: Operation	This attribute specifies the operation that is invoked by the Send Task .
implementation: string = ##webService	This attribute specifies the technology that will be used to send and receive the Messages . Valid values are "##unspecified" for leaving the implementation technology open, "##WebService" for the Web service technology or a URI identifying any other technology or coordination protocol A Web service is the default technology.

Receive Task

A **Receive Task** is a simple **Task** that is designed to wait for a **Message** to arrive from an external Participant (relative to the **Process**). Once the **Message** has been received, the **Task** is completed.

The actual *Participant* from which the **Message** is received can be identified by connecting the **Receive Task** to a *Participant* using a **Message Flows** within the definitional **Collaboration** of the **Process** – see Table 10.1.

A **Receive Task** is often used to start a **Process**. In a sense, the **Process** is bootstrapped by the receipt of the **Message**. In order for the **Receive Task** to instantiate the **Process** its `instantiate` attribute MUST be set to *true* and it MUST NOT have any incoming **Sequence Flow**.

A **Receive Task** object shares the same shape as the **Task**, which is a rectangle that has rounded corners. However, there is an unfilled envelope marker (the same marker as a *catch Message Event*) in the upper left corner of the shape that indicates that the **Task** is a **Receive Task**.

A **Receive Task** is a rounded corner rectangle that MUST be drawn with a single thin line and includes an unfilled envelope marker that distinguishes the shape from other **Task** types (as shown in Figure 10.15). If the `instantiate` attribute is set to *true*, the envelope marker looks like a **Message Start Event** (as shown in Figure 10.16).

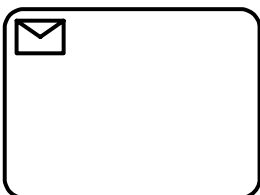

Figure 10.15 – A Receive Task Object

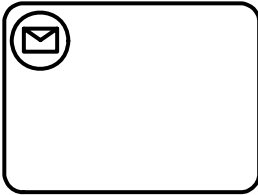

Figure 10.16 – A Receive Task Object that instantiates a Process

The **Receive Task** inherits the attributes and model associations of **Activity** (see Table 10.3). In addition the following constraints apply when the **Receive Task** references a **Message**: The **Receive Task** has at most one **outputSet** and at most one **Data output**. If the **Data output** is present, it **MUST** have an **ItemDefinition** equivalent to the one defined by the associated **Message**. At execution time, when the **Receive Task** is executed, the data automatically moves from the **Message** to the **Data Output** on the **Receive Task**. If the **Data Output** is not present, the payload within the **Message** will not flow out of the **Receive Task** and into the **Process**.

Table 10.10 presents the additional attributes and model associations of the **Receive Task**.

Table 10.10 – Receive Task attributes and model associations

Attribute Name	Description/Usage
messageRef : Message [0..1]	A Message for the messageRef attribute MAY be entered. This indicates that the Message will be received by the Task . The Message in this context is equivalent to an <i>in-only</i> message pattern (Web service). One (1) or more corresponding <i>incoming Message Flows</i> MAY be shown on the diagram. However, the display of the Message Flows is NOT REQUIRED . The Message is applied to all <i>incoming Message Flows</i> , but can arrive for only one (1) of the <i>incoming Message Flows</i> for a single <i>instance</i> of the Task .
instantiate : boolean = false	Receive Tasks can be defined as the instantiation mechanism for the Process with the instantiate attribute. This attribute MAY be set to <i>true</i> if the Task is the first Activity (i.e., there are no <i>incoming Sequence Flows</i>). Multiple Tasks MAY have this attribute set to <i>true</i> .
operationRef : Operation	This attribute specifies the operation through which the Receive Task receives the Message .
implementation : string = ##webService	This attribute specifies the technology that will be used to send and receive the Messages . Valid values are "##unspecified" for leaving the implementation technology open, "##WebService" for the Web service technology or a URI identifying any other technology or coordination protocol A Web service is the default technology.

User Task

A **User Task** is a typical “workflow” **Task** where a human performer performs the **Task** with the assistance of a software application and is scheduled through a task list manager of some sort.

A **User Task** is a rounded corner rectangle that **MUST** be drawn with a single thin line and includes a human figure marker that distinguishes the shape from other **Task** types (as shown in Figure 10.17).

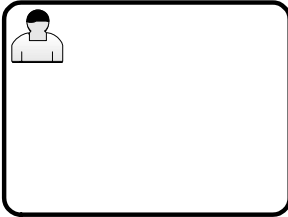

Figure 10.17 – A User Task Object

See “User Task” on page 160 within the larger section of “Human Interactions” for the details of **User Tasks**.

Manual Task

A **Manual Task** is a **Task** that is expected to be performed without the aid of any business process execution engine or any application. An example of this could be a telephone technician installing a telephone at a customer location.

A **Manual Task** is a rounded corner rectangle that **MUST** be drawn with a single thin line and includes a hand figure marker that distinguishes the shape from other **Task** types (as shown in Figure 10.17).

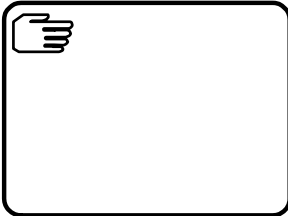

Figure 10.18 – A Manual Task Object

See “Manual Task” on page 163 within the larger section of “Human Interactions” for the details of **Manual Tasks**.

Business Rule

A **Business Rule Task** provides a mechanism for the **Process** to provide input to a Business Rules Engine and to get the output of calculations that the Business Rules Engine might provide. The `InputOutputSpecification` of the **Task** (see page 210) will allow the **Process** to send data to and receive data from the Business Rules Engine.

A **Business Rule Task** object shares the same shape as the **Task**, which is a rectangle that has rounded corners. However, there is a graphical marker in the upper left corner of the shape that indicates that the **Task** is a **Business Rule Task** (see Figure 10.11).

A **Business Rule Task** is a rounded corner rectangle that **MUST** be drawn with a single thin line and includes a marker that distinguishes the shape from other **Task** types (as shown in Figure 10.19).

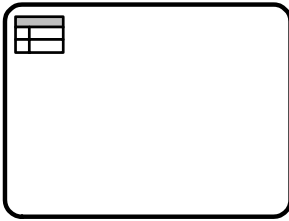

Figure 10.19 – A Business Rule Task Object

The **Business Rule Task** inherits the attributes and model associations of **Activity** (see Table 10.3). Table 10.11 presents the additional attributes of the **Business Rule Task**.

Table 10.11 – Business Rule Task attributes and model associations

Attribute Name	Description/Usage
implementation: string = ##unspecified	This attribute specifies the technology that will be used to implement the Business Rule Task . Valid values are "##unspecified" for leaving the implementation technology open, "##WebService" for the Web service technology or a URI identifying any other technology or coordination protocol. The default technology for this task is unspecified.

Script Task

A **Script Task** is executed by a business process engine. The modeler or implementer defines a script in a language that the engine can interpret. When the **Task** is ready to start, the engine will execute the script. When the script is completed, the **Task** will also be completed.

A **Script Task** object shares the same shape as the **Task**, which is a rectangle that has rounded corners. However, there is a graphical marker in the upper left corner of the shape that indicates that the **Task** is a **Script Task** (see Figure 10.11).

A **Script Task** is a rounded corner rectangle that **MUST** be drawn with a single thin line and includes a marker that distinguishes the shape from other **Task** types (as shown in Figure 10.20).

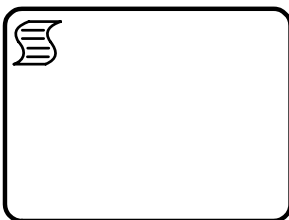

Figure 10.20 – A Script Task Object

The **Script Task** inherits the attributes and model associations of **Activity** (see Table 10.3). Table 10.12 presents the additional attributes of the **Script Task**.

Table 10.12 – Script Task attributes

Attribute Name	Description/Usage
scriptFormat : string [0..1]	Defines the format of the script. This attribute value MUST be specified with a mime-type format. And it MUST be specified if a script is provided.
script : string [0..1]	The modeler MAY include a script that can be run when the Task is performed. If a script is not included, then the Task will act as the equivalent of an Abstract Task .

10.3.4 Human Interactions

10.3.4.1 Tasks with Human involvement

In many business workflows, human involvement is needed to complete certain **Tasks** specified in the workflow model. **BPMN** specifies two different types of **Tasks** with human involvement, the **Manual Task** and the **User Task**.

A **User Task** is executed by and managed by a business process runtime. Attributes concerning the human involvement, like people assignments and UI rendering can be specified in great detail. A **Manual Task** is neither executed by nor managed by a business process runtime.

Notation

Both, the **Manual Task** and **User Task** share the same shape, which is a rectangle that has rounded corners. **Manual Tasks** and **User Tasks** have a person icon to indicate the human involvement is **REQUIRED** to complete the **Task** (see Figure 10.15 and Figure 10.17).

Manual Task

A **Manual Task** is a **Task** that is not managed by any business process engine. It can be considered as an unmanaged **Task**, unmanaged in the sense of that the business process engine doesn't track the start and completion of such a **Task**. An example of this could be a paper based instruction for a telephone technician to install a telephone at a customer location.

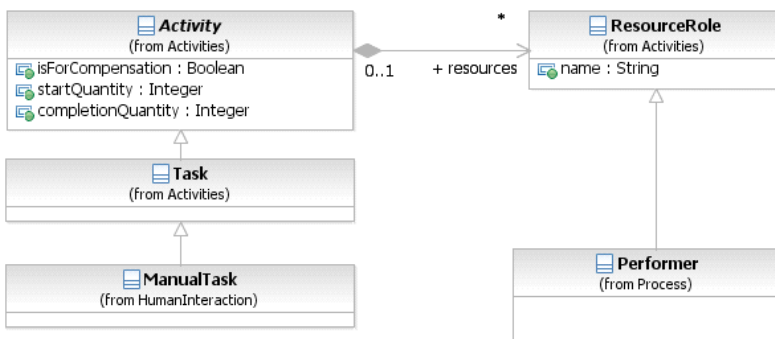

Figure 10.21 – Manual Task class diagram

The **User Task** inherits the attributes and model associations of **Activity** (see Table 10.3), but does not have any additional attributes or model associations.

User Task

A **User Task** is a typical “workflow” **Task** where a human performer performs the **Task** with the assistance of a software application. The lifecycle of the **Task** is managed by a software component (called task manager) and is typically executed in the context of a **Process**.

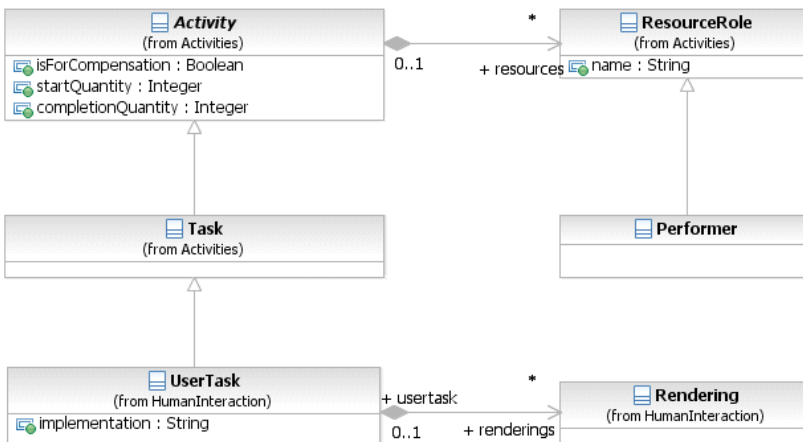

Figure 10.22 – User Task class diagram

The **User Task** can be implemented using different technologies, specified by the `implementation` attribute. Besides the Web service technology, any technology can be used. A **User Task** for instance can be implemented using WS-HumanTask by setting the `implementation` attribute to “`http://docs.oasis-open.org/ns/bpel4people/ws-humantask/protocol/200803.`”

The **User Task** inherits the attributes and model associations of **Activity** (see Table 10.3). Table 10.13 presents the additional attributes and model associations of the **User Task**. If implementations extend these attributes (e.g., to introduce subjects or descriptions with presentation parameters), they SHOULD use attributes defined by the OASIS WS-HumanTask specification.

Table 10.13 – User Task attributes and model associations

Attribute Name	Description/Usage
implementation: string = ##unspecified	This attribute specifies the technology that will be used to implement the User Task . Valid values are “##unspecified” for leaving the implementation technology open, “##WebService” for the Web service technology or a URI identifying any other technology or coordination protocol. The default technology for this task is unspecified.
renderings: Rendering [0..*]	This attributes acts as a hook which allows BPMN adopters to specify task rendering attributes by using the BPMN Extension mechanism.

The **User Task** inherits the *instance* attributes of **Activity** (see Table 8.49). Table 10.14 presents the *instance* attributes of the **User Task** element.

Table 10.14 – User Task instance attributes

Attribute Name	Description/Usage
actualOwner : string	Returns the “user” who picked/claimed the User task and became the actual owner of it. The value is a literal representing the user’s id, email address etc.
taskPriority : integer	Returns the priority of the User Task .

Rendering of User Tasks

BPMN User Tasks need to be rendered on user interfaces like forms clients, portlets, etc. The *Rendering* element provides an extensible mechanism for specifying UI renderings for **User Tasks** (Task UI). The element is optional. One or more rendering methods can be provided in a **Task** definition. A **User Task** can be deployed on any compliant implementation, irrespective of the fact whether the implementation supports specified rendering methods or not. The *Rendering* element is the extension point for renderings. Things like language considerations are opaque for the *Rendering* element because the rendering applications typically provide Multilanguage support. Where this is not the case, providers of certain rendering types can decide to extend the rendering type in order to provide language information for a given rendering. The content of the rendering element is not defined by this International Standard.

Human Performers

People can be assigned to **Activities** in various roles (called “generic human roles” in WS-HumanTask). **BPMN 1.2** traditionally only has the *Performer* role. In addition to supporting the *Performer* role, **BPMN 2.0** defines a specific *HumanPerformer* element allowing specifying more specific human roles as specialization of *HumanPerformer*, such as *PotentialOwner*.

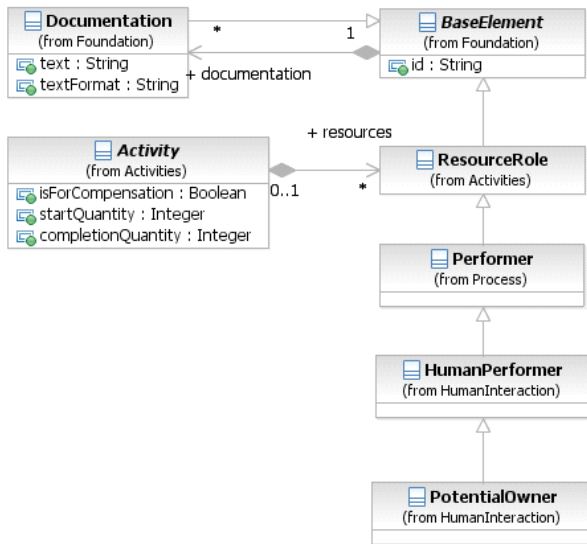

Figure 10.23 – HumanPerformer class diagram

The `HumanPerformer` element inherits the attributes and model associations of `ResourceRole` (see Table 10.5), through its relationship to `Performer`, but does not have any additional attributes or model associations.

Potential Owners

Potential owners of a **User Task** are persons who can claim and work on it. A potential owner becomes the actual owner of a **Task**, usually by explicitly claiming it.

XML Schema for Human Interactions

Table 10.15 – ManualTask XML schema

```
<xsd:element name="manualTask" type="tManualTask" substitutionGroup="flowElement"/>
<xsd:complexType name="tManualTask">
  <xsd:complexContent>
    <xsd:extension base="tTask"/>
  </xsd:complexContent>
</xsd:complexType>
```

Table 10.16 – UserTask XML schema

```
<xsd:element name="userTask" type="tUserTask" substitutionGroup="flowElement"/>
<xsd:complexType name="tUserTask">
  <xsd:complexContent>
    <xsd:extension base="tTask">
      <xsd:sequence>
        <xsd:element ref="rendering" minOccurs="0" maxOccurs="unbounded"/>
      </xsd:sequence>
      <xsd:attribute name="implementation" type="tImplementation"
        default="##unspecified"/>
    </xsd:extension>
  </xsd:complexContent>
</xsd:complexType>

<xsd:element name="rendering" type="tRendering"/>
<xsd:complexType name="tRendering">
  <xsd:complexContent>
    <xsd:extension base="tBaseElement"/>
  </xsd:complexContent>
</xsd:complexType>

  <xsd:simpleType name="tImplementation">
    <xsd:union memberTypes="xsd:anyURI">
      <xsd:simpleType>
        <xsd:restriction base="xsd:token">
          <xsd:enumeration value="##unspecified" />
          <xsd:enumeration value="##WebService" />
        </xsd:restriction>
      </xsd:simpleType>
    </xsd:union>
  </xsd:simpleType>
```

Table 10.17 – HumanPerformer XML schema

```

<xsd:element name="humanPerformer" type="tHumanPerformer" substitutionGroup="performer"/>
<xsd:complexType name="tHumanPerformer">
  <xsd:complexContent>
    <xsd:extension base="tPerformer">
      <xsd:sequence>
        <xsd:element ref="peopleAssignment" minOccurs="1" maxOccurs="1"/>
      </xsd:sequence>
    </xsd:extension>
  </xsd:complexContent>
</xsd:complexType>

```

Table 10.18 – PotentialOwner XML schema

```

<xsd:element name="potentialOwner" type="tPotentialOwner" substitutionGroup="performer"/>
<xsd:complexType name="tPotentialOwner">
  <xsd:complexContent>
    <xsd:extension base="tHumanPerformer"/>
  </xsd:complexContent>
</xsd:complexType>

```

Examples

Consider the following sample procurement **Process** from the Buyer perspective (see Figure 10.24).

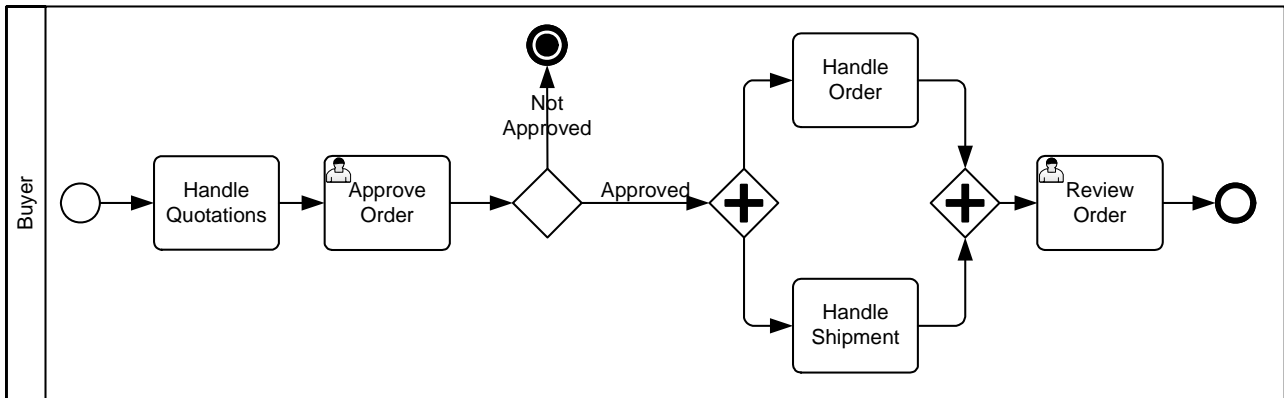

Figure 10.24 – Procurement Process Example

The **Process** comprises of two **User Tasks**

- **Approve Order:** After the quotation handling, the order needs to be approved by some regional manager to continue with the order and shipment handling.

- **Review Order:** Once the order has been shipped to the Buyer, the order and shipment documents will be reviewed again by someone.

The details of the Resource and resource assignments are not shown in the **BPMN** above. See below XML sample of the “Buyer” **Process** for the Resource usage and resource assignments for potential owners.

Table 10.19 – XML serialization of Buyer process

```
<?xml version="1.0" encoding="UTF-8"?>
<definitions id="Definition"
  targetNamespace="http://www.example.org/UserTaskExample"
  typeLanguage="http://www.w3.org/2001/XMLSchema"
  expressionLanguage="http://www.w3.org/1999/XPath"
  xmlns="http://www.w3.org/2001/XMLSchema"
  xmlns="http://www.omg.org/spec/BPMN/20100524/MODEL"
  xmlns:tns="http://www.example.org/UserTaskExample">
  <resource id="regionalManager" name="Regional Manager">
    <resourceParameter id="buyerName" isRequired="true" name="Buyer Name" type="xsd:string"/>
    <resourceParameter id="region" isRequired="false" name="Region" type="xsd:string"/>
  </resource>

  <resource id="departmentalReviewer" name="Departmental Reviewer">
    <resourceParameter id="buyerName" isRequired="true" name="Buyer Name" type="xsd:string"/>
  </resource>

  <collaboration id="BuyerCollaboration" name="Buyer Collaboration">
    <participant id="BuyerParticipant" name="Buyer" processRef="BuyerProcess"/>
  </collaboration>

  <!-- Process definition -->
  <process id="BuyerProcess" name="Buyer Process">

    <laneSet id="BuyerLaneSet">
      <lane id="BuyerLane">
        <flowNodeRef>StartProcess</flowNodeRef>
        <flowNodeRef>QuotationHandling</flowNodeRef>
        <flowNodeRef>ApproveOrder</flowNodeRef>
        <flowNodeRef>OrderApprovedDecision</flowNodeRef>
        <flowNodeRef>TerminateProcess</flowNodeRef>
        <flowNodeRef>OrderAndShipment</flowNodeRef>
        <flowNodeRef>OrderHandling</flowNodeRef>
        <flowNodeRef>ShipmentHandling</flowNodeRef>
        <flowNodeRef>OrderAndShipmentMerge</flowNodeRef>
        <flowNodeRef>ReviewOrder</flowNodeRef>
        <flowNodeRef>EndProcess</flowNodeRef>
      </lane>
    </laneSet>

    <startEvent id="StartProcess"/>
  </process>
</definitions>
```

```

<sequenceFlow sourceRef="StartProcess" targetRef="QuotationHandling"/>
<task id="QuotationHandling" name="Quotation Handling"/>
<sequenceFlow sourceRef="QuotationHandling" targetRef="ApproveOrder"/>
<userTask id="ApproveOrder" name="ApproveOrder">
  <potentialOwner>
    <resourceRef>tns:regionalManager</resourceRef>
    <resourceParameterBinding parameterRef="tns:buyerName">
      <formalExpression>getDataInput('order')/address/name</formalExpression>
    </resourceParameterBinding>
    <resourceParameterBinding parameterRef="tns:region">
      <formalExpression>getDataInput('order')/address/country</formalExpression>
    </resourceParameterBinding>
  </potentialOwner>
</userTask>
<sequenceFlow sourceRef="ApproveOrder" targetRef="OrderApprovedDecision"/>
<exclusiveGateway id="OrderApprovedDecision" gatewayDirection="Diverging"/>
<sequenceFlow sourceRef="OrderApprovedDecision" targetRef="OrderAndShipment">
  <conditionExpression>Was the Order Approved?</conditionExpression>
</sequenceFlow>
<sequenceFlow sourceRef="OrderApprovedDecision" targetRef="TerminateProcess">
  <conditionExpression>Was the Order NOT Approved?</conditionExpression>
</sequenceFlow>
<endEvent id="TerminateProcess">
  <terminateEventDefinition id="TerminateEvent"/>
</endEvent>
<parallelGateway id="OrderAndShipment" gatewayDirection="Diverging"/>
<sequenceFlow sourceRef="OrderAndShipment" targetRef="OrderHandling"/>
<sequenceFlow sourceRef="OrderAndShipment" targetRef="ShipmentHandling"/>
<task id="OrderHandling" name="Order Handling"/>
<task id="ShipmentHandling" name="Shipment Handling"/>
<sequenceFlow sourceRef="OrderHandling" targetRef="OrderAndShipmentMerge"/>
<sequenceFlow sourceRef="ShipmentHandling" targetRef="OrderAndShipmentMerge"/>
<parallelGateway id="OrderAndShipmentMerge" gatewayDirection="Converging"/>
<sequenceFlow sourceRef="OrderAndShipmentMerge" targetRef="ReviewOrder"/>
<userTask id="ReviewOrder" name="Review Order">
  <potentialOwner>
    <resourceRef>tns:departmentalReviewer</resourceRef>

```



```

    <resourceParameterBinding parameterRef="tns:buyerName">
      <formalExpression>getDataInput('order')/address/name</formalExpression>
    </resourceParameterBinding>
  </potentialOwner>
</userTask>

<sequenceFlow sourceRef="ReviewOrder" targetRef="EndProcess"/>

<endEvent id="EndProcess"/>

</process>
</definitions>

```

10.3.5 Sub-Processes

A **Sub-Process** is an **Activity** whose internal details have been modeled using **Activities, Gateways, Events, and Sequence Flows**. A **Sub-Process** is a graphical object within a **Process**, but it also can be “opened up” to show a lower-level **Process**. **Sub-Processes** define a contextual *scope* that can be used for attribute visibility, transactional *scope*, for the handling of *exceptions* (see page 274 for more details), of **Events**, or for *compensation* (see page 301 for more details).

There are different types of **Sub-Processes**, which will be described in the next five sub clauses.

Embedded Sub-Process (Sub-Process)

A **Sub-Process** object shares the same shape as the **Task** object, which is a rounded rectangle.

- ◆ A **Sub-Process** is a rounded corner rectangle that MUST be drawn with a single thin line.
- ◆ The use of text, color, size, and lines for a **Sub-Process** MUST follow the rules defined in “Use of Text, Color, Size, and Lines in a Diagram” on page 39 with the exception that:
 - ◆ A boundary drawn with a thick line SHALL be reserved for **Call Activity (Sub-Processes)** (see page 182).
 - ◆ A boundary drawn with a dotted line SHALL be reserved for **Event Sub-Processes** (see page 174).
 - ◆ A boundary drawn with a double line SHALL be reserved for **Transaction Sub-Processes** (see page 176).

The **Sub-Process** can be in a collapsed view that hides its details (see Figure 10.25) or a **Sub-Process** can be in an expanded view that shows its details within the view of the **Process** in which it is contained (see Figure 10.26). In the collapsed form, the **Sub-Process** object uses a marker to distinguish it as a **Sub-Process**, rather than a **Task**.

- ◆ The **Sub-Process** marker MUST be a small square with a plus sign (+) inside. The square MUST be positioned at the bottom center of the shape.

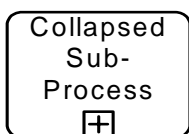

Figure 10.25 – A Sub-Process object (collapsed)

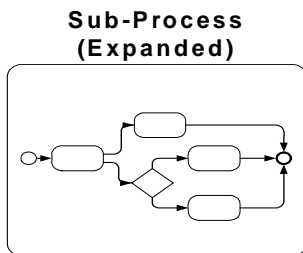

Figure 10.26 – A Sub-Process object (expanded)

They are used to create a context for exception handling that applies to a group of **Activities** (see page 274 for more details). *Compensations* can be handled similarly (see page 301 for more details).

Expanded **Sub-Processes** can be used as a mechanism for showing a group of parallel **Activities** in a less-cluttered, more compact way. In Figure 10.27, **Activities** “C” and “D” are enclosed in an unlabeled expanded **Sub-Process**. These two **Activities** will be performed in parallel. Notice that the expanded **Sub-Process** does not include a **Start Event** or an **End Event** and the **Sequence Flows** to/from these **Events**. This usage of expanded **Sub-Processes** for “parallel boxes” is the motivation for having **Start** and **End Events** being optional objects.

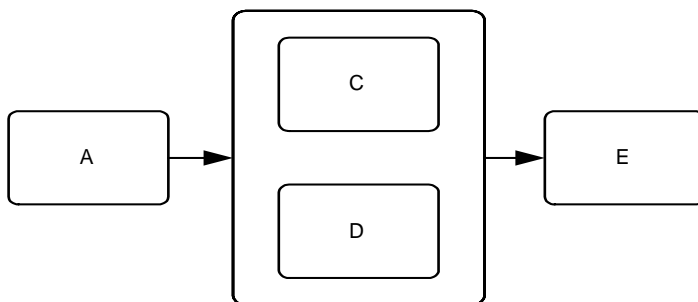

Figure 10.27 – Expanded Sub-Process used as a “Parallel Box”

BPMN specifies five types of standard markers for **Sub-Processes**. The (Collapsed) **Sub-Process** marker, seen in Figure 10.24, can be combined with four other markers: a *loop* marker or a *multi-instance* marker, a **Compensation** marker, and an **Ad-Hoc** marker. A collapsed **Sub-Process** **MAY** have one to three of these other markers, in all combinations except that *loop* and *multi-instance* cannot be shown at the same time (see Figure 10.28).

- ◆ The marker for a **Sub-Process** that *loops* **MUST** be a small line with an arrowhead that curls back upon itself.
- ◆ The *loop* marker **MAY** be used in combination with any of the other markers except the *multi-instance* marker.
- ◆ The marker for a **Sub-Process** that has multiple *instances* **MUST** be a set of three vertical lines in parallel.
- ◆ The *multi-instance* marker **MAY** be used in combination with any of the other markers except the *loop* marker.
- ◆ The marker for an *ad-hoc* **Sub-Process** **MUST** be a “tilde” symbol.
- ◆ The *ad-hoc* marker **MAY** be used in combination with any of the other markers.
- ◆ The marker for a **Sub-Process** that is used for *compensation* **MUST** be a pair of left facing triangles (like a tape player “rewind” button).
- ◆ The **Compensation** marker **MAY** be used in combination with any of the other markers.

- ◆ All the markers that are present **MUST** be grouped and the whole group centered at the bottom of the **Sub-Process**.

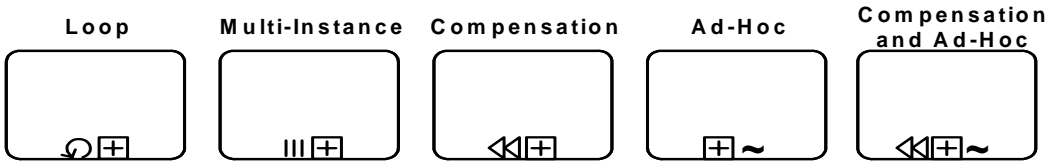

Figure 10.28 – Collapsed Sub-Process Markers

The **Sub-Process** now corresponds to the Embedded Sub-Process of BPMN 1.2. The Reusable Sub-Process of BPMN 1.2 corresponds to the Call Activity (calling a Process - see page 182). Figure 10.29 shows the class diagram related to Sub-Processes.

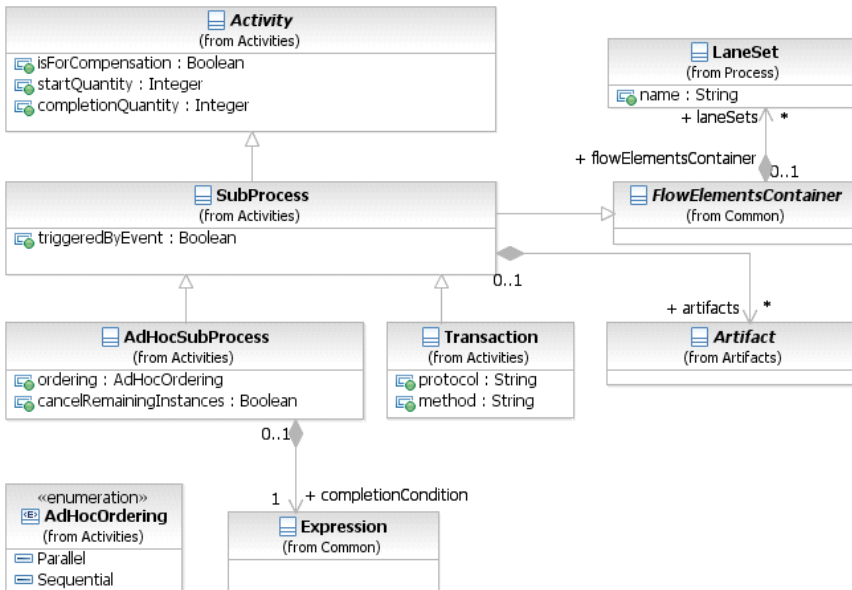

Figure 10.29– The Sub-Process class diagram

The **Sub-Process** element inherits the attributes and model associations of **Activity** (see Table 10.3) and of **FlowElementContainer** (see Table 8.45). Table 10.3 presents the additional attributes of the **Sub-Process** element.

Table 10.20 – Sub-Process attributes

Attribute Name	Description/Usage
triggeredByEvent : boolean = false	<p>A flag that identifies whether this Sub-Process is an Event Sub-Process.</p> <ul style="list-style-type: none"> • If <i>false</i>, then this Sub-Process is a normal Sub-Process. • If <i>true</i>, then this Sub-Process is an Event Sub-Process and is subject to additional constraints (see page 174).
artifacts : Artifact [0..*]	<p>This attribute provides the list of Artifacts that are contained within the Sub-Process.</p>

Reusable Sub-Process (Call Activity)

The *reusable* **Sub-Process** of **BPMN 1.2** corresponds to the **Call Activity** that calls a predefined **Process**. See details of a **Call Activity** on page 182.

Event Sub-Process

An **Event Sub-Process** is a specialized **Sub-Process** that is used within a **Process** (or **Sub-Process**). A **Sub-Process** is defined as an **Event Sub-Process** when its `triggeredByEvent` attribute is set to *true*.

An **Event Sub-Process** is not part of the *normal flow* of its parent **Process**—there are no *incoming* or *outgoing* **Sequence Flows**.

- ◆ An **Event Sub-Process** **MUST NOT** have any *incoming* or *outgoing* **Sequence Flows**.

An **Event Sub-Process** **MAY** or **MAY NOT** occur while the parent **Process** is active, but it is possible that it will occur many times. Unlike a standard **Sub-Process**, which uses the flow of the parent **Process** as a *trigger*, an **Event Sub-Process** has a **Start Event** with a *trigger*. Each time the **Start Event** is triggered while the parent **Process** is active, then the **Event Sub-Process** will start.

- ◆ The **Start Event** of an **Event Sub-Process** **MUST** have a defined *trigger*.
- ◆ The **Start Event** *trigger* (`EventDefinition`) **MUST** be from the following types: `Message`, `Error`, `Escalation`, `Compensation`, `Conditional`, `Signal`, and `Multiple` (see page 259 for more details).
- ◆ An **Event Sub-Process** **MUST** have one and only one **Start Event**.

An **Event Sub-Process** object shares the same basic shape as the **Sub-Process** object, which is a rounded rectangle.

- ◆ An **Event Sub-Process** is a rounded corner rectangle that **MUST** be drawn with a single thin dotted line (see Figure 10.30 and Figure 10.31).
- ◆ The use of text, color, size, and lines for an **Event Sub-Process** **MUST** follow the rules defined in “Use of Text, Color, Size, and Lines in a Diagram” on page 39 with the exception that:
 - ◆ If the **Event Sub-Process** is collapsed, then its **Start Event** will be used as a marker in the upper left corner of the shape (see Figure 10.30).

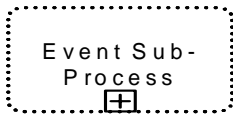

Figure 10.30 – An Event Sub-Process object (Collapsed)

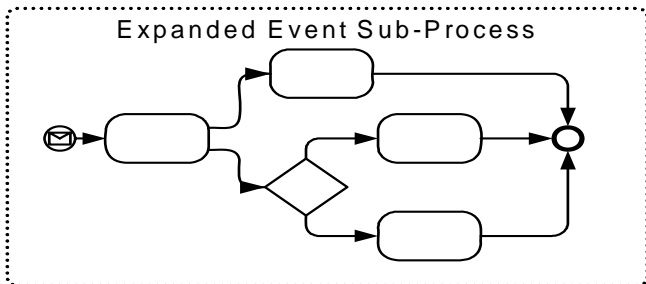

Figure 10.31 – An Event Sub-Process object (expanded)

There are two possible consequences to the parent **Process** when an **Event Sub-Process** is triggered: 1) the parent **Process** can be interrupted, and 2) the parent **Process** can continue its work (not interrupted). This is determined by the type of **Start Event** that is used. See page 241 for the list of interrupting and non-interrupting **Event Sub-Process Start Events**.

Figure 10.32 provides an example of a **Sub-Process** that includes three **Event Sub-Processes**. The first **Event Sub-Process** is triggered by a **Message**, does not interrupt the **Sub-Process**, and can occur multiple times. The second **Event Sub-Process** is used for *compensation* and will only occur after the **Sub-Process** has completed. The third **Event Sub-Process** handles errors that occur while the **Sub-Process** is active and will stop (interrupt) the **Sub-Process** if triggered.

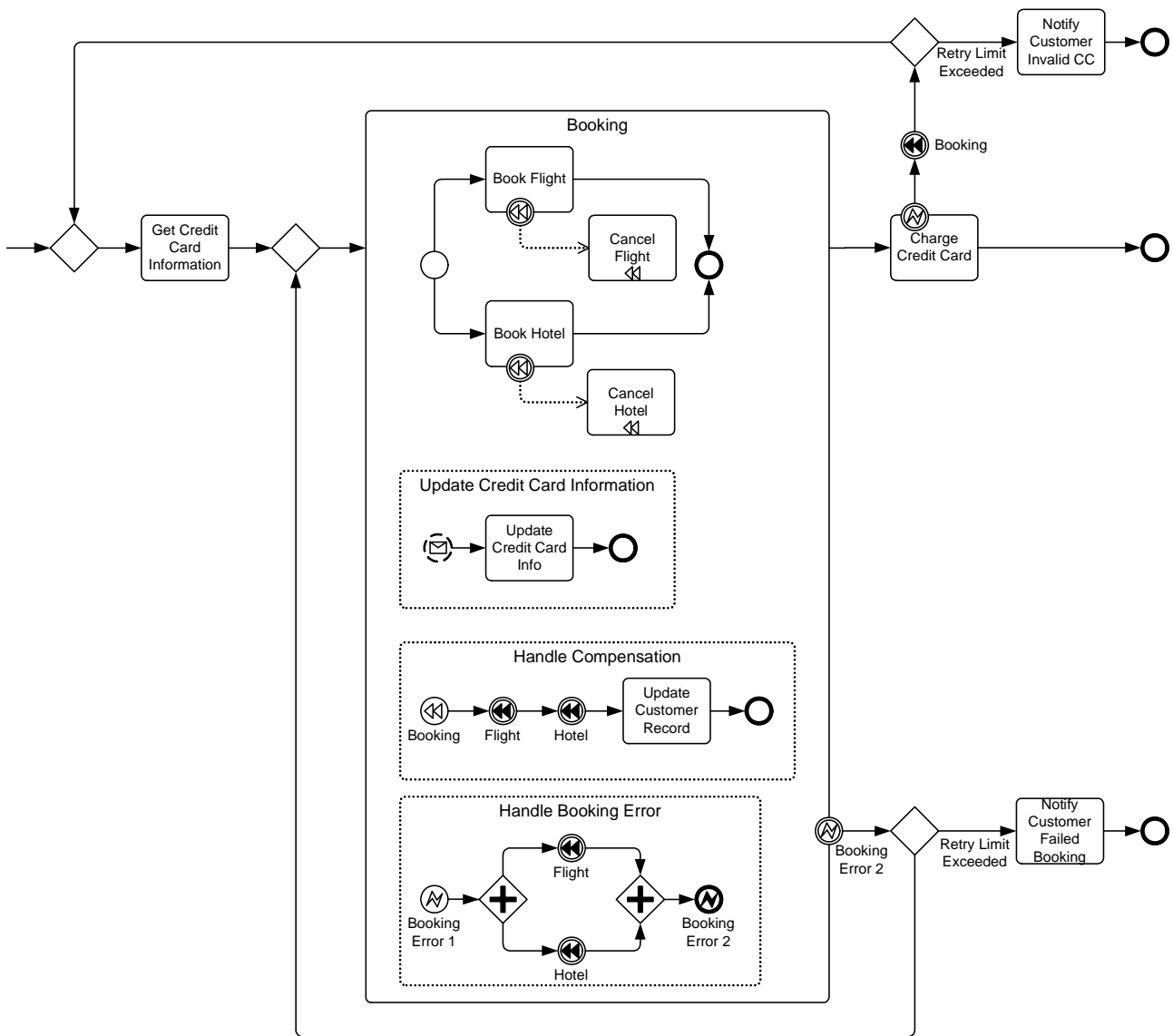

Figure 10.32 – An example that includes Event Sub-Processes

Transaction

A **Transaction** is a specialized type of **Sub-Process** that will have a special behavior that is controlled through a transaction protocol (such as WS-Transaction). The boundary of the **Sub-Process** will be double-lined to indicate that it is a **Transaction** (see Figure 10.33).

- ◆ A **Transaction Sub-Process** is a rounded corner rectangle that **MUST** be drawn with a double thin line.
- ◆ The use of text, color, size, and lines for a *transaction Sub-Process* **MUST** follow the rules defined in “Use of Text, Color, Size, and Lines in a Diagram” on page 39.

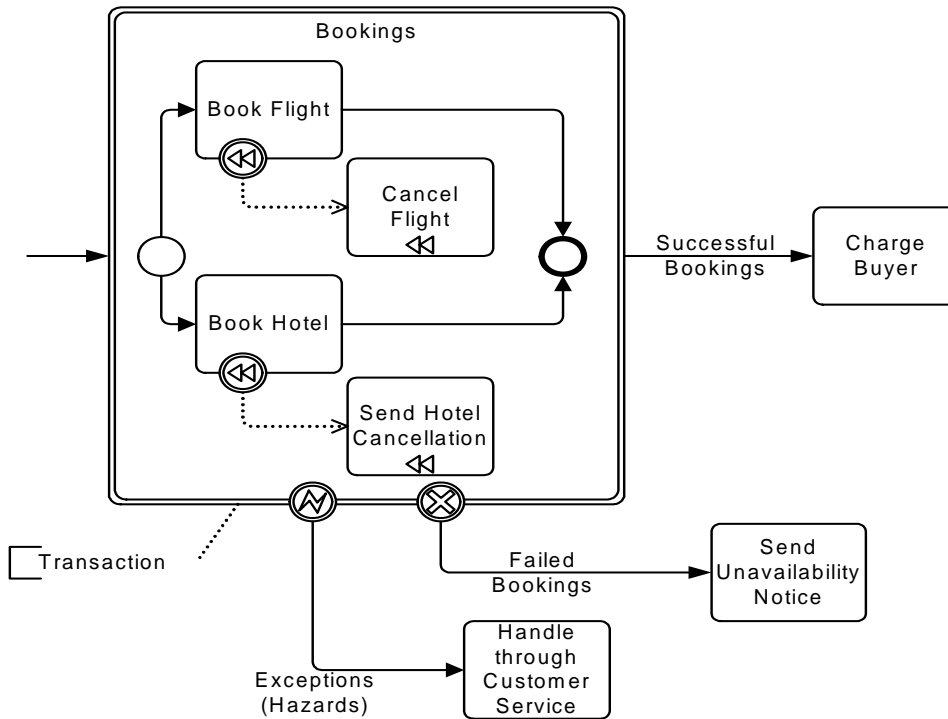

Figure 10.33 – A Transaction Sub-Process

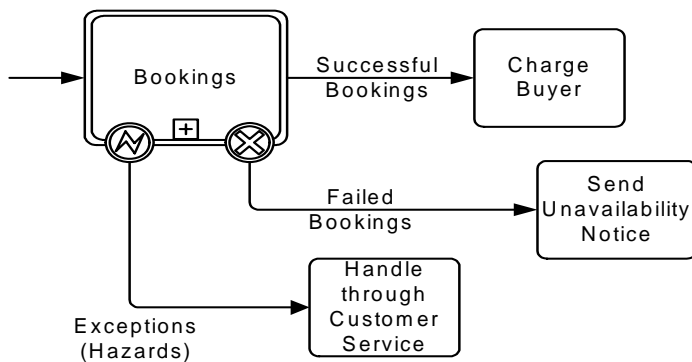

Figure 10.34 – A Collapsed Transaction Sub-Process

The **Transaction Sub-Process** element inherits the attributes and model associations of **Activities** (see Table 10.3) through its relationship to **Sub-Process**. Table 10.21 presents the additional attributes and model associations of the **Transaction Sub-Process**.

Table 10.21 – Transaction Sub-Process attributes and model associations

Attribute Name	Description/Usage
method: TransactionMethod	The method is an attribute that defines the Transaction method used to commit or cancel a Transaction . For executable Processes , it SHOULD be set to a technology specific URI, e.g., <code>http://schemas.xmlsoap.org/ws/2004/10/wsat</code> for WS-AtomicTransaction , or <code>http://docs.oasis-open.org/ws-tx/wsba/2006/06/AtomicOutcome</code> for WS-BusinessActivity . For compatibility with BPMN 1.1, it can also be set to <code>"##compensate," "##store,"</code> or <code>"##image."</code>

There are three basic outcomes of a **Transaction**:

1. **Successful completion:** this will be shown as a normal **Sequence Flow** that leaves the **Transaction Sub-Process**.
2. **Failed completion (Cancel):** When a **Transaction** is canceled, the **Activities** inside the **Transaction** will be subjected to the cancellation actions, which could include rolling back the **Process** and *compensation* (see page 301 for more information on *compensation*) for specific **Activities**. Note that other mechanisms for interrupting a **Transaction Sub-Process** will not cause *compensation* (e.g., Error, Timer, and anything for a non-Transaction **Activity**). A **Cancel Intermediate Event**, attached to the boundary of the **Activity**, will direct the flow after the **Transaction** has been rolled back and all *compensation* has been completed. The **Cancel Intermediate Event** can only be used when attached to the boundary of a **Transaction Sub-Process**. It cannot be used in any *normal flow* and cannot be attached to a non-**Transaction Sub-Process**. There are two mechanisms that can signal the cancellation of a **Transaction**:
 - A **Cancel End Event** is reached within the *transaction Sub-Process*. A **Cancel End Event** can only be used within a *transaction Sub-Process*.
 - A *cancel Message* can be received via the transaction protocol that is supporting the execution of the **Transaction Sub-Process**.
3. **Hazard:** This means that something went terribly wrong and that a normal success or cancel is not possible. **Error Intermediate Events** are used to show *Hazards*. When a *Hazard* happens, the **Activity** is interrupted (without *compensation*) and the flow will continue from the **Error Intermediate Event**.

The behavior at the end of a successful **Transaction Sub-Process** is slightly different than that of a normal **Sub-Process**. When each path of the **Transaction Sub-Process** reaches a non-**Cancel End Event(s)**, the flow does not immediately move back up to the higher-level *parent Process*, as does a normal **Sub-Process**. First, the transaction protocol needs to verify that all the *Participants* have successfully completed their end of the **Transaction**. Most of the time this will be true and the flow will then move up to the higher-level **Process**. But it is possible that one of the *Participants* can end up with a problem that causes a *Cancel* or a *Hazard*. In this case, the flow will then move to the appropriate **Intermediate Event**, even though it had apparently finished successfully.

Ad-Hoc Sub-Process

An **Ad-Hoc Sub-Process** is a specialized type of **Sub-Process** that is a group of **Activities** that have no **REQUIRED** sequence relationships. A set of **Activities** can be defined for the **Process**, but the sequence and number of performances for the **Activities** is determined by the performers of the **Activities**.

A **Sub-Process** is marked as being *ad-hoc* with a “tilde” symbol placed at the bottom center of the **Sub-Process** shape (see Figure 10.35 and Figure 10.36).

- ◆ The marker for an **Ad-Hoc Sub-Process** **MUST** be a “tilde” symbol.
- ◆ The **Ad-Hoc** Marker **MAY** be used in combination with any of the other markers.

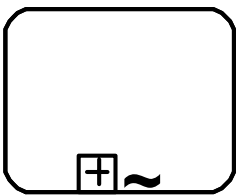

Figure 10.35 – A collapsed Ad-Hoc Sub-Process

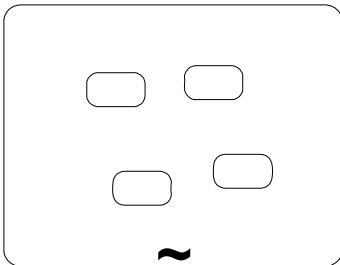

Figure 10.36 – An expanded Ad-Hoc Sub-Process

The **Ad-Hoc Sub-Process** element inherits the attributes and model associations of **Activities** (see Table 10.3) through its relationship to **Sub-Process**. Table 10.22 presents the additional model associations of the **Ad-Hoc Sub-Process**.

Table 10.22 – Ad-hoc Sub-Process model associations

Attribute Name	Description/Usage
completionCondition: Expression	This <i>Expression</i> defines the conditions when the Process will end. When the <i>Expression</i> is evaluated to <i>true</i> , the Process will be terminated.
ordering: AdHocOrdering = Parallel { Parallel Sequential }	This attribute defines if the Activities within the Process can be performed in parallel or MUST be performed sequentially. The default setting is <i>parallel</i> and the setting of <i>sequential</i> is a restriction on the performance that can be needed due to shared resources. When the setting is <i>sequential</i> , then only one Activity can be performed at a time. When the setting is <i>parallel</i> , then zero (0) to all the Activities of the Sub-Process can be performed in parallel.
cancelRemaining-Instances: boolean = true	This attribute is used only if ordering is parallel. It determines whether running <i>instances</i> are canceled when the <i>completionCondition</i> becomes <i>true</i> .

Activities within the **Process** are generally disconnected from each other. During execution of the **Process**, any one or more of the **Activities** MAY be active and they MAY be performed multiple times. The *performers* determine when **Activities** will start, what the next **Activity** will be, and so on.

Examples of the types of **Processes** that are **Ad-Hoc** include computer code development (at a low level), sales support, and writing a book chapter. If we look at the details of writing a book chapter, we could see that the **Activities** within this **Process** include: researching the topic, writing text, editing text, generating graphics, including graphics in the text, organizing references, etc. (see Figure 10.37). There MAY be some dependencies between **Tasks** in this **Process**, such as writing text before editing text, but there is not necessarily any correlation between an *instance* of writing text to an *instance* of editing text. Editing can occur infrequently and based on the text of many *instances* of the writing text **Task**.

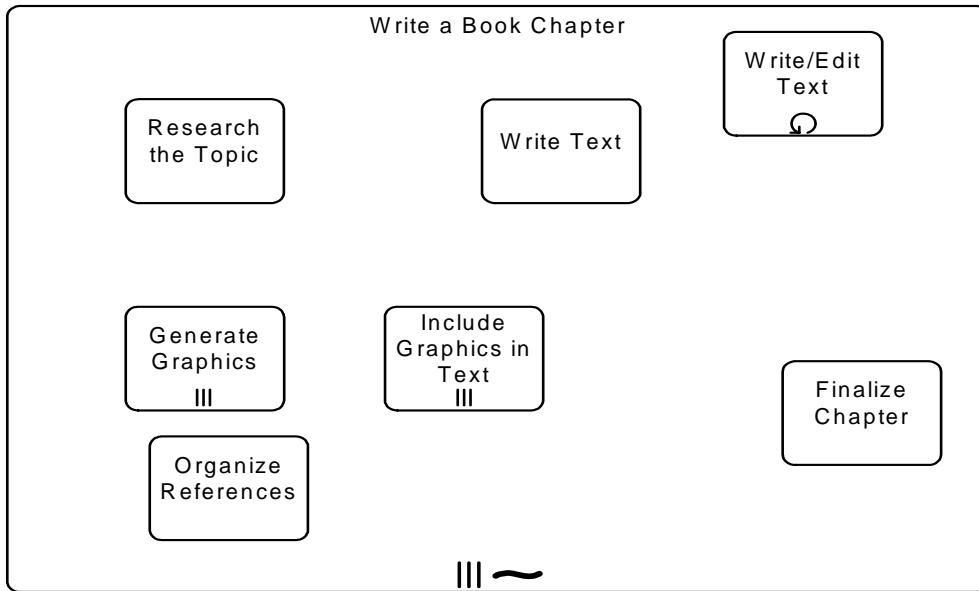

Figure 10.37 – An Ad-Hoc Sub-Process for writing a book chapter

Although there is no explicit **Process** structure, some sequence and data dependencies can be added to the details of the **Process**. For example, we can extend the book chapter **Ad-Hoc Sub-Process** shown above and add **Data Objects**, **Data Associations**, and even **Sequence Flows** (Figure 10.38).

Ad-Hoc Sub-Processes restrict the use of **BPMN** elements that would normally be used in **Sub-Processes**.

- ◆ The list of **BPMN** elements that **MUST** be used in an **Ad-Hoc Sub-Process: Activity**.
- ◆ The list of **BPMN** elements that **MAY** be used in an **Ad-Hoc Sub-Process: Data Object, Sequence Flow, Association, Data Association, Group, Message Flow** (as a *source* or *target*), **Gateway**, and **Intermediate Event**.
- ◆ The list of **BPMN** elements that **MUST NOT** be used in an **Ad-Hoc Sub-Process: Start Event, End Event, Conversations** (graphically), **Conversation Links** (graphically), and **Choreography Activities**.

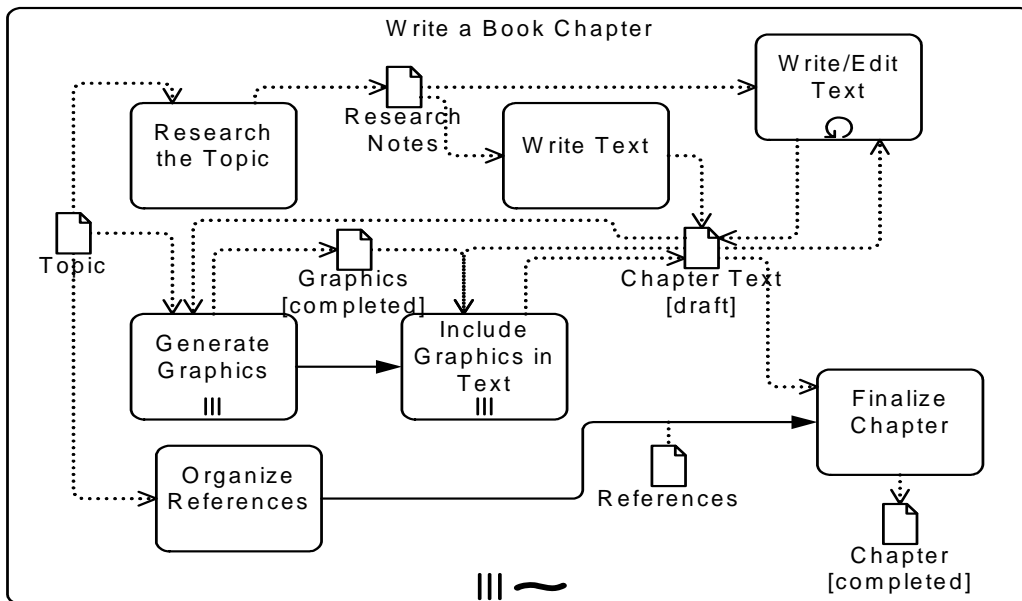

Figure 10.38 – An Ad-Hoc Sub-Process with data and sequence dependencies

The **Data Objects** as *inputs* into the **Tasks** act as an additional constraint for the performance of those **Tasks**. The *performers* still determine when the **Tasks** will be performed, but they are now constrained in that they cannot start the **Task** without the appropriate *input*. The addition of **Sequence Flows** between the **Tasks** (e.g., between “Generate Graphics” and “Include Graphics in Text”) creates a dependency where the performance of the first **Task** **MUST** be followed by a performance of the second **Task**. This does not mean that the second **Task** is to be performed immediately, but there **MUST** be a performance of the second **Task** after the performance of the first **Task**.

It is a challenge for a BPM engine to monitor the status of **Ad-Hoc Sub-Processes**, usually these kind of **Processes** are handled through groupware applications (such as e-mail), but **BPMN** allows modeling of **Processes** that are not necessarily executable, although there are some process engines that can follow an **Ad-Hoc Sub-Process**. Given this, at some point the **Ad-Hoc Sub-Process** will have complete and this can be determined by evaluating a `completionCondition` that evaluates **Process** attributes that will have been updated by an **Activity** in the **Process**.

10.3.6 Call Activity

A **Call Activity** identifies a point in the **Process** where a global **Process** or a Global Task is used. The **Call Activity** acts as a ‘wrapper’ for the invocation of a global **Process** or Global Task within the execution. The activation of a call **Activity** results in the transfer of control to the called global **Process** or Global Task.

The **BPMN 2.0 Call Activity** corresponds to the *Reusable Sub-Process* of **BPMN 1.2**. A **BPMN 2.0 Sub-Process** corresponds to the *Embedded Sub-Process* of **BPMN 1.2** (see the previous sub clause).

A **Call Activity** object shares the same shape as the **Task** and **Sub-Process**, which is a rectangle that has rounded corners. However, the target of what the **Activity** calls will determine the details of its shape.

- ◆ If the **Call Activity** calls a Global Task, then the shape will be the same as a **Task**, but the boundary of the shape will **MUST** have a thick line (see Figure 10.39).

- ◆ The **Call Activity** MUST display the marker of the type of Global Task (e.g., the **Call Activity** would display the **User Task** marker if calling a Global User Task).
- ◆ If the **Call Activity** calls a **Process**, then there are two options:
 - ◆ The details of the called **Process** can be hidden and the shape of the **Call Activity** will be the same as a *collapsed Sub-Process*, but the boundary of the shape MUST have a thick line (see Figure 10.40).

If the details of the called **Process** are available, then the shape of the **Call Activity** will be the same as a *expanded Sub-Process*, but the boundary of the shape MUST have a thick line (see Figure 10.41).

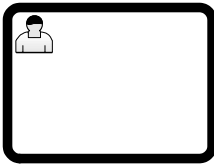

Figure 10.39 – A Call Activity object calling a Global Task

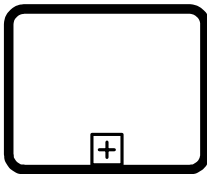

Figure 10.40 – A Call Activity object calling a Process (Collapsed)

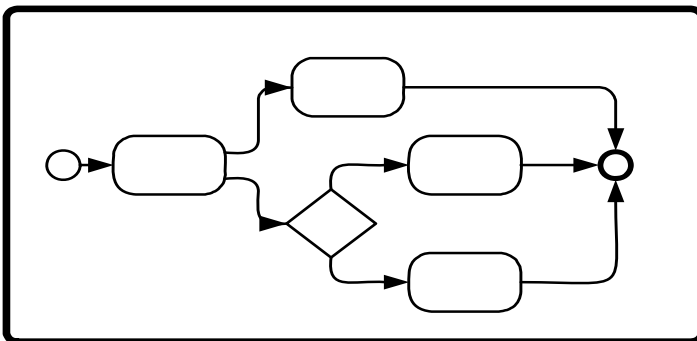

Figure 10.41 – A Call Activity object calling a Process (Expanded)

When a **Process** with a *definitional Collaboration*, calls a **Process** that also has a *definitional Collaboration*, the *Participants* of the two **Collaborations** can be matched to each other using *ParticipantAssociations* of the **Collaboration** of the calling **Process**.

A **Call Activity** MUST fulfill the data requirements, as well as return the data produced by the `CallableElement` being invoked (see Figure 10.41). This means that the elements contained in the **Call Activity**'s `InputOutputSpecification` MUST exactly match the elements contained in the referenced `CallableElement`. This includes `DataInputs`, `DataOutputs`, `InputSets`, and `OutputSets`.

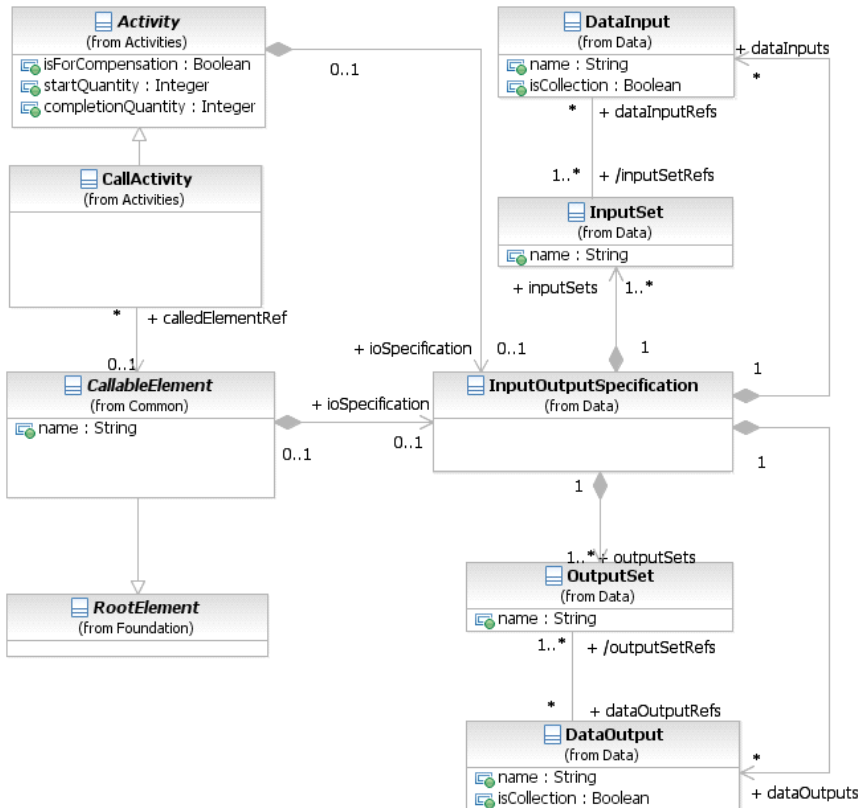

Figure 10.42 –The Call Activity class diagram

A **Call Activity** can override properties and attributes of the element being called, potentially changing the behavior of the called element based on the calling context. For example, when the **Call Activity** defines one or more `ResourceRole` elements, the elements defined by the `CallableElement` are ignored and the elements defined in the **Call Activity** are used instead. Also, **Events** that are propagated along the hierarchy (errors and escalations) are propagated from the called element to the **Call Activity** (and can be handled on its boundary).

The **Call Activity** inherits the attributes and model associations of **Activity** (see Table 10.3). Table 10.23 presents the additional model associations of the **Call Activity**.

Table 10.23 – CallActivity model associations

Attribute Name	Description/Usage
calledElement: CallableElement [0..1]	The element to be called, which will be either a Process or a GlobalTask . Other CallableElements, such as Choreography , GlobalChoreographyTask , Conversation , and GlobalCommunication MUST NOT be called by the Call Conversation element.

Callable Element

CallableElement is the abstract super class of all **Activities** that have been defined outside of a **Process** or **Choreography** but which can be called (or reused), by a **Call Activity**, from within a **Process** or **Choreography**. It MAY reference Interfaces that define the service operations that it provides. The **BPMN** elements that can be called by **Call Activities** (i.e., are CallableElements) are: **Process** and **GlobalTask** (see Figure 10.43). CallableElements are RootElements, which can be imported and used in other Definitions. When CallableElements (e.g., **Process**) are defined, they are contained within Definitions.

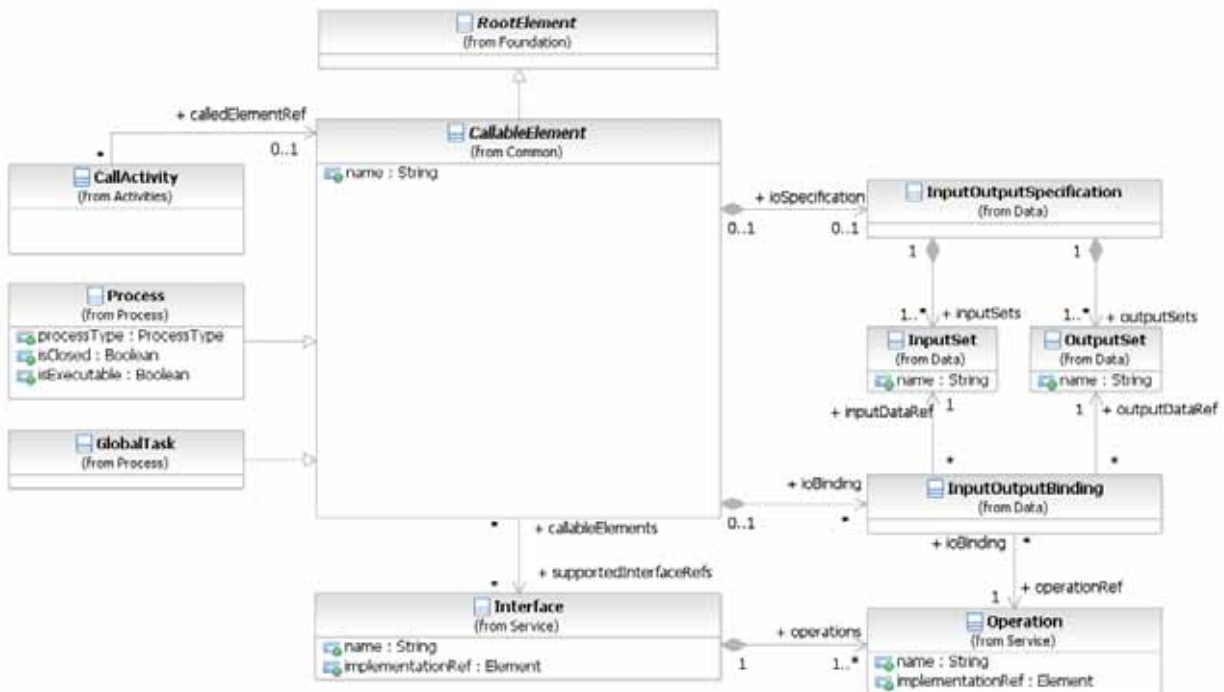

Figure 10.43 – CallableElement class diagram

The CallableElement inherits the attributes and model associations of BaseElement (see Table 8.5) through its relationship to RootElement. Table 10.24 presents the additional attributes and model associations of the CallableElement.

Table 10.24 – CallableElement attributes and model associations

Attribute Name	Description/Usage
name: string [0..1]	The descriptive name of the element.
supportedInterfaceRefs: Interface [0..*]	The Interfaces describing the external behavior provided by this element.
ioSpecification: Input OutputSpecification [0..1]	The InputOutputSpecification defines the <i>inputs</i> and <i>outputs</i> and the InputSets and OutputSets for the Activity .
ioBinding: InputOutput Binding [0..*]	The InputOutputBinding defines a combination of one InputSet and one OutputSet in order to bind this to an operation defined in an interface.

When a CallableElement is exposed as a Service, it has to define one or more InputOutputBinding elements. An InputOutputBinding element binds one *Input* and one *Output* of the InputOutputSpecification to an Operation of a Service Interface. Table 10.25 presents the additional model associations of the InputOutputBinding.

Table 10.25 – InputOutputBinding model associations

Attribute Name	Description/Usage
inputDataRef: DataInput	A reference to one specific DataInput defined as part of the InputOutputSpecification of the Activity .
outputDataRef: DataOutput	A reference to one specific DataOutput defined as part of the InputOutputSpecification of the Activity .
operationRef: Operation	A reference to one specific Operation defined as part of the Interface of the Activity .

10.3.7 Global Task

A Global Task is a reusable, *atomic* **Task** definition that can be called from within any **Process** by a **Call Activity**.

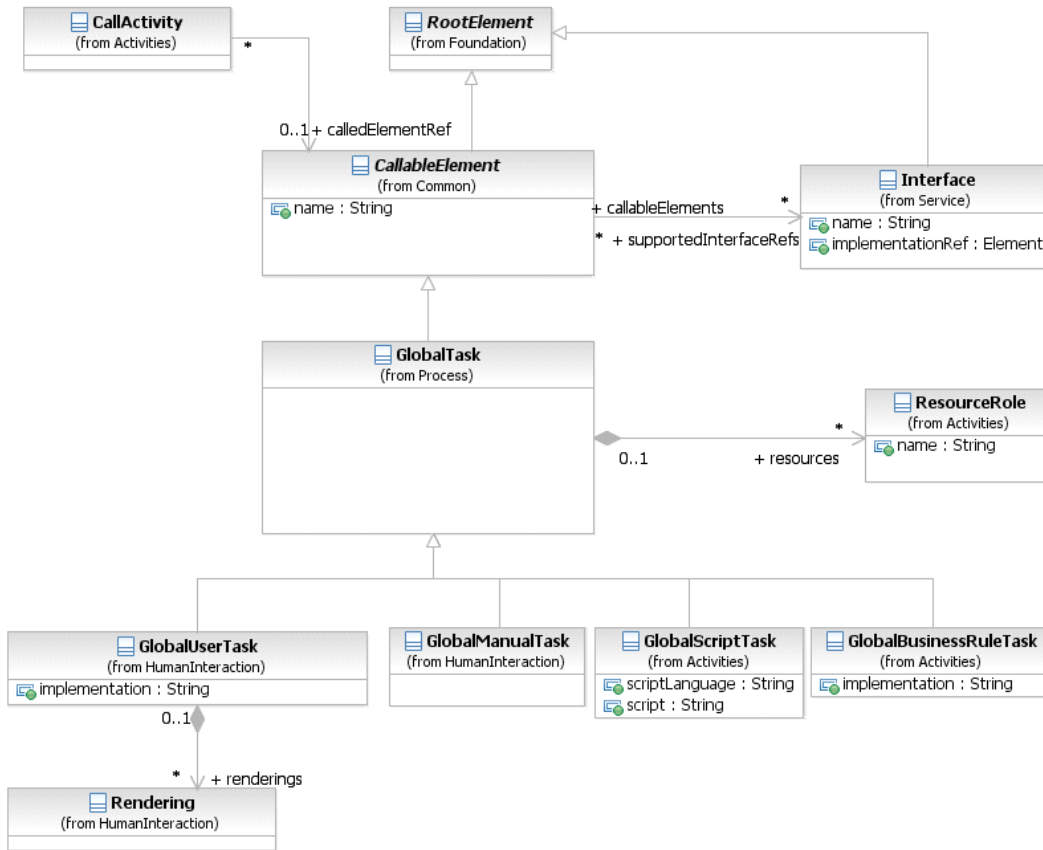

Figure 10.44 – Global Tasks class diagram

The `GlobalTask` inherits the attributes and model associations of `CallableElement` (see Table 10.24). Table 10.26 presents the additional model associations of the `GlobalTask`.

Table 10.26 – Global Task model associations

Attribute Name	Description/Usage
resources: ResourceRole [0..*]	Defines the resource that will perform or will be responsible for the <code>GlobalTask</code> . In the case where the Call Activity that references this <code>GlobalTask</code> defines its own resources, they will override the ones defined here.

Types of Global Task

There are different types of **Tasks** identified within **BPMN** to separate the types of inherent behavior that **Tasks** might represent. The types of `GlobalTasks` are only a subset of standard **Tasks** types. Only `GlobalUserTask`, `GlobalManualTask`, `GlobalScriptTask`, and `GlobalBusinessRuleTask` are defined in **BPMN**. For the sake of efficiency in this document, the list of **Task** types is presented once on page 154. The behavior, attributes, and model associations defined in that sub clause also apply to the corresponding types of **GlobalTasks**.

10.3.8 Loop Characteristics

Activities MAY be repeated sequentially, essentially behaving like a *loop*. The presence of `LoopCharacteristics` signifies that the **Activity** has looping behavior. `LoopCharacteristics` is an abstract class. Concrete subclasses define specific kinds of looping behavior.

The `LoopCharacteristics` inherits the attributes and model associations of `BaseElement` (see Table 8.5). There are no further attributes or model associations of the `LoopCharacteristics`.

However, each **Loop Activity** *instance* has attributes whose values MAY be referenced by `Expressions`. These values are only available when the **Loop Activity** is being executed.

Figure 10.45 displays the class diagram for an **Activity's** *loop* characteristics, including the details of both the standard *loop* and a *multi-instance*.

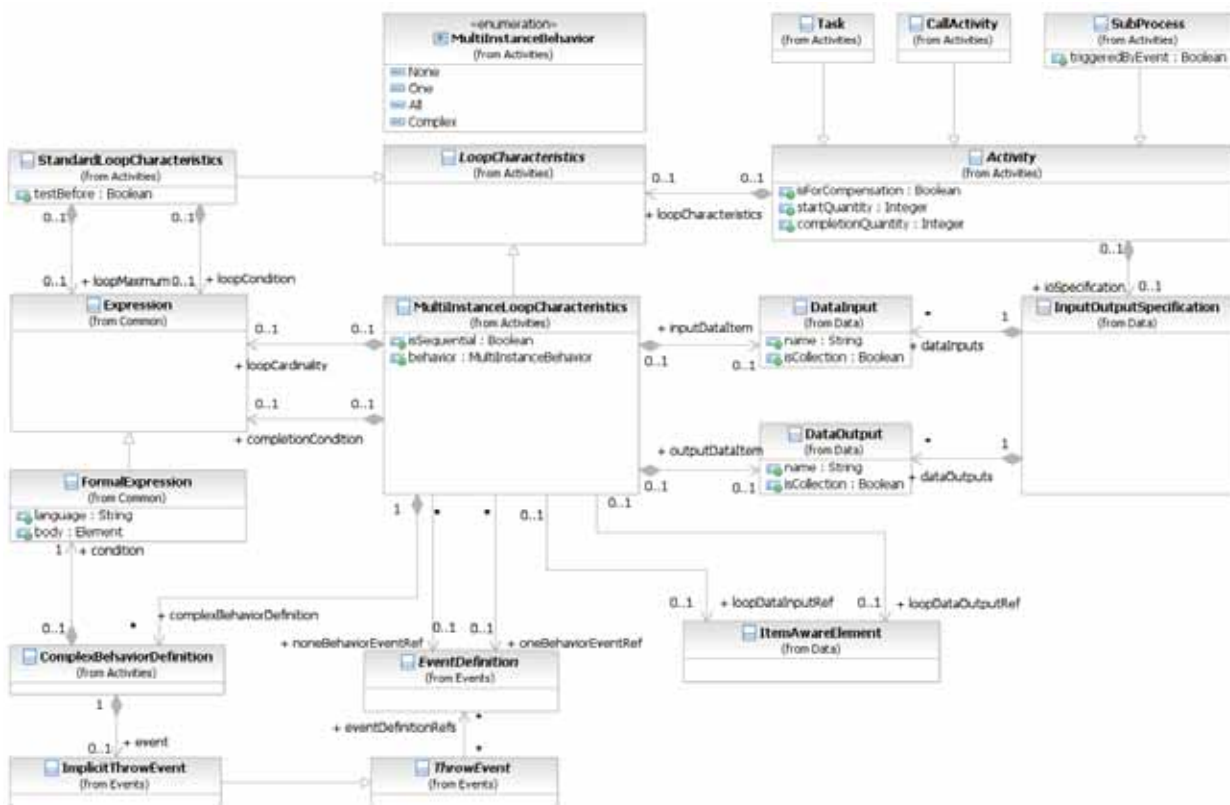

Figure 10.45 – LoopCharacteristics class diagram

The `LoopCharacteristics` element inherits the attributes and model associations of `BaseElement` (see Table 8.5), but does not have any further attributes or model associations. However, a **Loop Activity** does have additional *instance* attributes as shown in Table 10.27.

Table 10.27 – Loop Activity instance attributes

Attribute Name	Description/Usage
loopCounter: integer	The <code>loopCounter</code> attribute is used at runtime to count the number of loops and is automatically updated by the process engine.

Standard Loop Characteristics

The `StandardLoopCharacteristics` class defines looping behavior based on a `boolean` condition. The **Activity** will *loop* as long as the `boolean` condition is *true*. The condition is evaluated for every *loop* iteration, and MAY be evaluated at the beginning or at the end of the iteration. In addition, a numeric cap can be optionally specified. The number of iterations MAY NOT exceed this cap.

- ◆ The marker for a **Task** or a **Sub-Process** that is a standard *loop* MUST be a small line with an arrowhead that curls back upon itself (see Figure 10.46 and Figure 10.47).
- ◆ The **loop** Marker MAY be used in combination with the **Compensation** Marker.

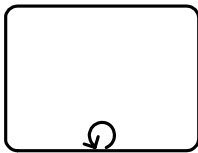

Figure 10.46 – A Task object with a Standard Loop Marker

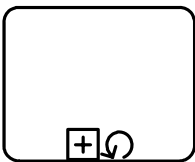

Figure 10.47 – A Sub-Process object with a Standard Loop Marker

The `StandardLoopCharacteristics` element inherits the attributes and model associations of `BaseElement` (see Figure 8.5), through its relationship to `LoopCharacteristics`. Table 10.28 presents the additional attributes and model associations for the `StandardLoopCharacteristics` element.

Table 10.28 – StandardLoopCharacteristics attributes and model associations

Attribute Name	Description/Usage
testBefore: boolean = false	Flag that controls whether the loop condition is evaluated at the beginning (<i>testBefore = true</i>) or at the end (<i>testBefore = false</i>) of the loop iteration.
loopMaximum: integer [0..1]	Serves as a cap on the number of iterations.
loopCondition: Expression [0..1]	A boolean Expression that controls the loop. The Activity will only loop as long as this condition is <i>true</i> . The looping behavior MAY be underspecified, meaning that the modeler can simply document the condition, in which case the loop cannot be formally executed.

Multi-Instance Characteristics

The `MultiInstanceLoopCharacteristics` class allows for creation of a desired number of **Activity instances**. The *instances* MAY execute in parallel or MAY be sequential. Either an Expression is used to specify or calculate the desired number of *instances* or a data driven setup can be used. In that case a data input can be specified, which is able to handle a collection of data. The number of items in the collection determines the number of **Activity instances**. This data input can be produced by an input **Data Association**. The modeler can also configure this *loop* to control the *tokens* produced.

- ◆ The marker for a **Task** or **Sub-Process** that is a *multi-instance* MUST be a set of three vertical lines.
- ◆ If the *multi-instance instances* are set to be performed in parallel rather than sequential (the `isSequential` attribute set to *false*), then the lines of the marker will be vertical (see Figure 10.48).
- ◆ If the *multi-instance instances* are set to be performed in sequence rather than parallel (the `isSequential` attribute set to *true*), then the marker will be horizontal (see Figure 10.49).
- ◆ The **Multi-Instance** marker MAY be used in combination with the **Compensation** marker.

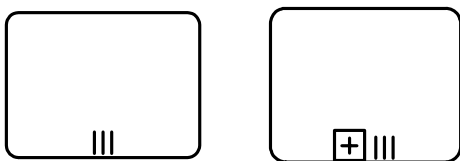

Figure 10.48 – Activity Multi-Instance marker for parallel instances

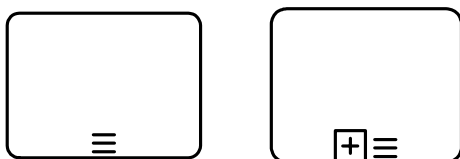

Figure 10.49 – Activity Multi-Instance marker for sequential instances

The `MultiInstanceLoopCharacteristics` element inherits the attributes and model associations of `BaseElement` (see Table 8.5), through its relationship to `LoopCharacteristics`. Table 10.29 presents the additional attributes and model associations for the `MultiInstanceLoopCharacteristics` element.

Table 10.29 – MultiInstanceLoopCharacteristics attributes and model associations

Attribute Name	Description/Usage
isSequential: boolean = false	This attribute is a flag that controls whether the Activity <i>instances</i> will execute sequentially or in parallel.
loopCardinality: Expression [0..1]	A numeric Expression that controls the number of Activity <i>instances</i> that will be created. This Expression MUST evaluate to an <i>integer</i> . This MAY be underspecified, meaning that the modeler MAY simply document the condition. In such a case the <i>loop</i> cannot be formally executed. In order to initialize a valid <i>multi-instance</i> , either the <code>loopCardinality</code> Expression or the <code>loopDataInput</code> MUST be specified.
loopDataInputRef: ItemAwareElement [0..1]	This ItemAwareElement is used to determine the number of Activity <i>instances</i> , one Activity <i>instance</i> per item in the collection of data stored in that ItemAwareElement element. For Tasks it is a reference to a Data Input which is part of the Activity 's InputOutputSpecification . For Sub-Processes it is a reference to a collection-valued Data Object in the context that is visible to the Sub-Processes . In order to initialize a valid <i>multi-instance</i> , either the <code>loopCardinality</code> Expression or the <code>loopDataInput</code> MUST be specified.
loopDataOutputRef: ItemAwareElement [0..1]	This ItemAwareElement specifies the collection of data, which will be produced by the <i>multi-instance</i> . For Tasks it is a reference to a Data Output which is part of the Activity 's InputOutputSpecification . For Sub-Processes it is a reference to a collection-valued Data Object in the context that is visible to the Sub-Processes .
inputDataItem: DataInput [0..1]	A Data Input , representing for every Activity <i>instance</i> the single item of the collection stored in the <code>loopDataInput</code> . This Data Input can be the source of DataInputAssociation to a data input of the Activity 's InputOutputSpecification . The type of this Data Input MUST be the scalar of the type defined for the <code>loopDataInput</code> .
outputDataItem: DataOutput [0..1]	A Data Output , representing for every Activity <i>instance</i> the single item of the collection stored in the <code>loopDataOutput</code> . This Data Output can be the target of DataOutputAssociation to a data output of the Activity 's InputOutputSpecification . The type of this Data Output MUST be the scalar of the type defined for the <code>loopDataOutput</code> .

Table 10.29 – MultiInstanceLoopCharacteristics attributes and model associations

<p>behavior: MultiInstanceBehavior = all { None One All Complex }</p>	<p>The attribute behavior acts as a shortcut for specifying when events SHALL be thrown from an Activity instance that is about to complete. It can assume values of None, One, All, and Complex, resulting in the following behavior:</p> <ul style="list-style-type: none"> • None: the EventDefinition which is associated through the noneEvent association will be thrown for each <i>instance</i> completing. • One: the EventDefinition referenced through the oneEvent association will be thrown upon the first <i>instance</i> completing. • All: no Event is ever thrown; a <i>token</i> is produced after completion of all <i>instances</i>. • Complex: the complexBehaviorDefinitions are consulted to determine if and which Events to throw. <p>For the behaviors of none and one, a default SignalEventDefinition will be thrown which automatically carries the current runtime attributes of the MI Activity. Any thrown Events can be caught by <i>boundary Events</i> on the Multi-Instance Activity.</p>
<p>complexBehaviorDefinition: ComplexBehaviorDefinition [0..*]</p>	<p>Controls when and which Events are thrown in case behavior is set to complex.</p>
<p>completionCondition: Expression [0..1]</p>	<p>This attribute defines a boolean Expression that when evaluated to <i>true</i>, cancels the remaining Activity instances and produces a <i>token</i>.</p>
<p>oneBehaviorEventRef: EventDefinition [0..1]</p>	<p>The EventDefinition which is thrown when behavior is set to one and the first internal Activity instance has completed.</p>
<p>noneBehaviorEventRef: EventDefinition [0..1]</p>	<p>The EventDefinition which is thrown when the behavior is set to none and an internal Activity instance has completed.</p>

Table 10.30 lists all *instance* attributes available at runtime. For each *instance* of the **Multi-Instance Activity** (outer *instance*), there exists a number of generated (inner) *instances* of the **Activity** at runtime.

Table 10.30 – Multi-instance Activity instance attributes

Attribute Name	Description/Usage
loopCounter: integer	This attribute is provided for each generated (inner) <i>instance</i> of the Activity . It contains the sequence number of the generated <i>instance</i> , i.e., if this value of some <i>instance</i> is n, the <i>instance</i> is the n-th <i>instance</i> that was generated.
numberOfInstances: integer	This attribute is provided for the outer <i>instance</i> of the Multi-Instance Activity only. This attribute contains the total number of inner <i>instances</i> created for the Multi-Instance Activity .
numberOfActiveInstances: integer	This attribute is provided for the outer <i>instance</i> of the Multi-Instance Activity only. This attribute contains the number of currently active inner <i>instances</i> for the Multi-Instance Activity . In case of a sequential Multi-Instance Activity , this value can't be greater than 1. For parallel Multi-Instance Activities , this value can't be greater than the value contained in <code>numberOfInstances</code> .
numberOfCompletedInstances: integer	This attribute is provided for the outer <i>instance</i> of the Multi-Instance Activity only. This attribute contains the number of already completed inner <i>instances</i> for the Multi-Instance Activity .
numberOfTerminatedInstances: integer	This attribute is provided for the outer <i>instance</i> of the Multi-Instance Activity only. This attribute contains the number of terminated inner <i>instances</i> for the Multi-Instance Activity . The sum of <code>numberOfTerminatedInstances</code> , <code>numberOfCompletedInstances</code> , and <code>numberOfActiveInstances</code> always sums up to <code>numberOfInstances</code> .

Complex Behavior Definition

This element controls when and which **Events** are thrown in case `behavior` of the **Multi-Instance Activity** is set to `complex`.

The `ComplexBehaviorDefinition` element inherits the attributes and model associations of `BaseElement` (see Table 8.5). Table 10.31 presents the additional attributes and model associations for the `ComplexBehaviorDefinition` element.

Table 10.31 – ComplexBehaviorDefinition attributes and model associations

Attribute Name	Description/Usage
condition: Formal Expression	This attribute defines a boolean <code>Expression</code> that when evaluated to <code>true</code> , cancels the remaining Activity <i>instances</i> and produces a <i>token</i> .
event: ImplicitThrowEvent	If the condition is <code>true</code> , this identifies the Event that will be thrown (to be caught by a <i>boundary Event</i> on the Multi-Instance Activity).

10.3.9 XML Schema for Activities

Table 10.32 – Activity XML schema

```

<xsd:element name="activity" type="tActivity"/>
<xsd:complexType name="tActivity" abstract="true">
  <xsd:complexContent>
    <xsd:extension base="tFlowNode">
      <xsd:sequence>
        <xsd:element ref="ioSpecification" minOccurs="0" maxOccurs="1"/>
        <xsd:element ref="property" minOccurs="0" maxOccurs="unbounded"/>
        <xsd:element ref="dataInputAssociation" minOccurs="0" maxOccurs="unbounded"/>
        <xsd:element ref="dataOutputAssociation" minOccurs="0" maxOccurs="unbounded"/>
        <xsd:element ref="resourceRole" minOccurs="0" maxOccurs="unbounded"/>
        <xsd:element ref="loopCharacteristics" minOccurs="0"/>
      </xsd:sequence>
      <xsd:attribute name="isForCompensation" type="xsd:boolean" default="false"/>
      <xsd:attribute name="startQuantity" type="xsd:integer" default="1"/>
      <xsd:attribute name="completionQuantity" type="xsd:integer" default="1"/>
      <xsd:attribute name="default" type="xsd:IDREF" use="optional"/>
    </xsd:extension>
  </xsd:complexContent>
</xsd:complexType>

```

Table 10.33 – AdHocSubProcess XML schema

```
<xsd:element name="adHocSubProcess" type="tAdHocSubProcess" substitutionGroup="flowElement"/>
<xsd:complexType name="tAdHocSubProcess">
  <xsd:complexContent>
    <xsd:extension base="tSubProcess">
      <xsd:sequence>
        <xsd:element name="completionCondition" type="tExpression" minOccurs="0"
          maxOccurs="1"/>
      </xsd:sequence>
      <xsd:attribute name="cancelRemainingInstances" type="xsd:boolean" default="true"/>
      <xsd:attribute name="ordering" type="tAdHocOrdering" default="Parallel"/>
    </xsd:extension>
  </xsd:complexContent>
</xsd:complexType>

<xsd:simpleType name="tAdHocOrdering">
  <xsd:restriction base="xsd:string">
    <xsd:enumeration value="Parallel"/>
    <xsd:enumeration value="Sequential"/>
  </xsd:restriction>
</xsd:simpleType>
```

Table 10.34 – BusinessRuleTask XML schema

```
<xsd:element name="businessRuleTask" type="tBusinessRuleTask" substitutionGroup="flowElement"/>
<xsd:complexType name="tBusinessRuleTask">
  <xsd:complexContent>
    <xsd:extension base="tTask">
      <xsd:attribute name="implementation" type="tImplementation" default="##unspecified"/>
    </xsd:extension>
  </xsd:complexContent>
</xsd:complexType>
```

Table 10.35 – CallableElement XML schema

```
<xsd:element name="callableElement" type="tCallableElement"/>
<xsd:complexType name="tCallableElement">
  <xsd:complexContent>
    <xsd:extension base="tRootElement">
      <xsd:sequence>
        <xsd:element name="supportedInterfaceRef" type="xsd:QName" minOccurs="0" maxOccurs="unbounded"/>
        <xsd:element ref="ioSpecification" minOccurs="0" maxOccurs="1"/>
        <xsd:element ref="ioBinding" minOccurs="0" maxOccurs="unbounded"/>
      </xsd:sequence>
      <xsd:attribute name="name" type="xsd:string"/>
    </xsd:extension>
  </xsd:complexContent>
</xsd:complexType>
```

Table 10.36 – CallActivity XML schema

```
<xsd:element name="callActivity" type="tCallActivity" substitutionGroup="flowElement"/>
<xsd:complexType name="tCallActivity">
  <xsd:complexContent>
    <xsd:extension base="tActivity">
      <xsd:attribute name="calledElement" type="xsd:QName" use="optional"/>
    </xsd:extension>
  </xsd:complexContent>
</xsd:complexType>
```

Table 10.37 – GlobalBusinessRuleTask XML schema

```
<xsd:element name="globalBusinessRuleTask" type="tGlobalBusinessRuleTask" substitutionGroup="rootElement"/>
<xsd:complexType name="tGlobalBusinessRuleTask">
  <xsd:complexContent>
    <xsd:extension base="tGlobalTask">
      <xsd:attribute name="implementation" type="tImplementation" default="##unspecified"/>
    </xsd:extension>
  </xsd:complexContent>
</xsd:complexType>
```

Table 10.38 – GlobalScriptTask XML schema

```
<xsd:element name="globalScriptTask" type="tGlobalScriptTask" substitutionGroup="rootElement"/>
<xsd:complexType name="tGlobalScriptTask">
  <xsd:complexContent>
    <xsd:extension base="tGlobalTask">
      <xsd:sequence>
        <xsd:element ref="script" minOccurs="0" maxOccurs="1"/>
      </xsd:sequence>
      <xsd:attribute name="scriptLanguage" type="xsd:anyURI"/>
    </xsd:extension>
  </xsd:complexContent>
</xsd:complexType>
```

Table 10.39 – GlobalTask XML schema

```
<xsd:element name="globalTask" type="tGlobalTask" substitutionGroup="rootElement"/>
<xsd:complexType name="tGlobalScriptTask">
  <xsd:complexContent>
    <xsd:extension base="tCallableElement">
      <xsd:sequence>
        <xsd:element ref="resourceRole" minOccurs="0" maxOccurs="unbounded"/>
      </xsd:sequence>
    </xsd:extension>
  </xsd:complexContent>
</xsd:complexType>
```

Table 10.40 – LoopCharacteristics XML schema

```
<xsd:element name="loopCharacteristics" type="tLoopCharacteristics"/>
<xsd:complexType name="tLoopCharacteristics" abstract="true">
  <xsd:complexContent>
    <xsd:extension base="tBaseElement"/>
  </xsd:complexContent>
</xsd:complexType>
```

Table 10.41 – MultiInstanceLoopCharacteristics XML schema

```
<xsd:element name="multiInstanceLoopCharacteristics" type="tMultiInstanceLoopCharacteristics"
  substitutionGroup="loopCharacteristics"/>
<xsd:complexType name="tMultiInstanceLoopCharacteristics">
  <xsd:complexContent>
    <xsd:extension base="tLoopCharacteristics">
      <xsd:sequence>
        <xsd:element name="loopCardinality" type="tExpression" minOccurs="0"
          maxOccurs="1"/>
        <xsd:element name="loopDataInputRef" type="xsd:QName" minOccurs="0"
          maxOccurs="1"/>
        <xsd:element name="loopDataOutputRef" type="xsd:QName" minOccurs="0"
          maxOccurs="1"/>
        <xsd:element name="inputDataItem" type="tDataInput" minOccurs="0" maxOccurs="1"/>
        <xsd:element name="outputDataItem" type="tDataOutput" minOccurs="0"
          maxOccurs="1"/>
        <xsd:element ref="complexBehaviorDefinition" minOccurs="0" maxOccurs="unbounded"/>
        <xsd:element name="completionCondition" type="tExpression" minOccurs="0"
          maxOccurs="1"/>
      </xsd:sequence>
      <xsd:attribute name="isSequential" type="xsd:boolean" default="false"/>
      <xsd:attribute name="behavior" type="tMultiInstanceFlowCondition" default="All"/>
      <xsd:attribute name="oneBehaviorEventRef" type="xsd:QName" use="optional"/>
      <xsd:attribute name="noneBehaviorEventRef" type="xsd:QName" use="optional"/>
    </xsd:extension>
  </xsd:complexContent>
</xsd:complexType>

<xsd:simpleType name="tMultiInstanceFlowCondition">
  <xsd:restriction base="xsd:string">
    <xsd:enumeration value="None"/>
    <xsd:enumeration value="One"/>
    <xsd:enumeration value="All"/>
    <xsd:enumeration value="Complex"/>
  </xsd:restriction>
</xsd:simpleType>
```

Table 10.42 – ReceiveTask XML schema

```
<xsd:element name="receiveTask" type="tReceiveTask" substitutionGroup="flowElement"/>
<xsd:complexType name="tReceiveTask">
  <xsd:complexContent>
    <xsd:extension base="tTask">
      <xsd:attribute name="implementation" type="tImplementation" default="##WebService"/>
      <xsd:attribute name="instantiate" type="xsd:boolean" default="false"/>
      <xsd:attribute name="messageRef" type="xsd:QName" use="optional"/>
      <xsd:attribute name="operationRef" type="xsd:QName" use="optional"/>
    </xsd:extension>
  </xsd:complexContent>
</xsd:complexType>
```

Table 10.43 – ResourceRole XML schema

```
<xsd:element name="resourceRole" type="tResourceRole"/>
<xsd:complexType name="tResourceRole">
  <xsd:complexContent>
    <xsd:extension base="tBaseElement">
      <xsd:choice>
        <xsd:sequence>
          <xsd:element name="resourceRef" type="xsd:QName" minOccurs="0"
            maxOccurs="1"/>
          <xsd:element ref="resourceParameterBinding" minOccurs="0"
            maxOccurs="unbounded"/>
        </xsd:sequence>
        <xsd:element ref="resourceAssignmentExpression" minOccurs="0" maxOccurs="1"/>
      </xsd:choice>
    </xsd:extension>
  </xsd:complexContent>
</xsd:complexType>
```

Table 10.44 – ScriptTask XML schema

```
<xsd:element name="scriptTask" type="tScriptTask" substitutionGroup="flowElement"/>
<xsd:complexType name="tScriptTask">
  <xsd:complexContent>
    <xsd:extension base="tTask">
      <xsd:sequence>
        <xsd:element ref="script" minOccurs="0" maxOccurs="1"/>
      </xsd:sequence>
      <xsd:attribute name="scriptFormat" type="xsd:anyURI"/>
    </xsd:extension>
  </xsd:complexContent>
</xsd:complexType>

<xsd:element name="script" type="tScript"/>
<xsd:complexType name="tScript" mixed="true">
  <xsd:sequence>
    <xsd:any namespace="##any" processContents="lax" minOccurs="0"/>
  </xsd:sequence>
</xsd:complexType>
```

Table 10.45 – SendTask XML schema

```
<xsd:element name="sendTask" type="tSendTask" substitutionGroup="flowElement"/>
<xsd:complexType name="tSendTask">
  <xsd:complexContent>
    <xsd:extension base="tTask">
      <xsd:attribute name="implementation" type="tImplementation" default="##WebService"/>
      <xsd:attribute name="messageRef" type="xsd:QName" use="optional"/>
      <xsd:attribute name="operationRef" type="xsd:QName" use="optional"/>
    </xsd:extension>
  </xsd:complexContent>
</xsd:complexType>
```

Table 10.46 – ServiceTask XML schema

```
<xsd:element name="serviceTask" type="tServiceTask" substitutionGroup="flowElement"/>
<xsd:complexType name="tServiceTask">
  <xsd:complexContent>
    <xsd:extension base="tTask">
      <xsd:attribute name="implementation" type="tImplementation" default="##WebService"/>
      <xsd:attribute name="operationRef" type="xsd:QName" use="optional"/>
    </xsd:extension>
  </xsd:complexContent>
</xsd:complexType>
```

Table 10.47– StandardLoopCharacteristics XML schema

```
<xsd:element name="standardLoopCharacteristics" type="tStandardLoopCharacteristics"/>
<xsd:complexType name="tStandardLoopCharacteristics">
  <xsd:complexContent>
    <xsd:extension base="tLoopCharacteristics">
      <xsd:sequence>
        <xsd:element name="loopCondition" type="tExpression" minOccurs="0"/>
      </xsd:sequence>
      <xsd:attribute name="testBefore" type="xsd:boolean" default="false"/>
      <xsd:attribute name="loopMaximum" type="xsd:integer" use="optional"/>
    </xsd:extension>
  </xsd:complexContent>
</xsd:complexType>
```

Table 10.48 – SubProcess XML schema

```
<xsd:element name="subProcess" type="tSubProcess" substitutionGroup="flowElement"/>
<xsd:complexType name="tSubProcess">
  <xsd:complexContent>
    <xsd:extension base="tActivity">
      <xsd:sequence>
        <xsd:element ref="laneSet" minOccurs="0" maxOccurs="unbounded"/>
        <xsd:element ref="flowElement" minOccurs="0" maxOccurs="unbounded"/>
        <xsd:element ref="artifact" minOccurs="0" maxOccurs="unbounded"/>
      </xsd:sequence>
      <xsd:attribute name="triggeredByEvent" type="xsd:boolean" default="false"/>
    </xsd:extension>
  </xsd:complexContent>
</xsd:complexType>
```

Table 10.49 – Task XML schema

```
<xsd:element name="task" type="tTask" substitutionGroup="flowElement"/>
<xsd:complexType name="tTask">
  <xsd:complexContent>
    <xsd:extension base="tActivity"/>
  </xsd:complexContent>
</xsd:complexType>
```

Table 10.50 – Transaction XML schema

```
<xsd:element name="transaction" type="tTransaction" substitutionGroup="flowElement"/>
<xsd:complexType name="tTransaction">
  <xsd:complexContent>
    <xsd:extension base="tSubProcess">
      <xsd:attribute name="method" type="tTransactionMethod" default="Compensate"/>
    </xsd:extension>
  </xsd:complexContent>
</xsd:complexType>

<xsd:simpleType name="tTransactionMethod">
  <xsd:restriction base="xsd:string">
    <xsd:enumeration value="Compensate"/>
    <xsd:enumeration value="Image"/>
    <xsd:enumeration value="Store"/>
  </xsd:restriction>
</xsd:simpleType>
```

10.4 Items and Data

A traditional requirement of **Process** modeling is to be able to model the items (physical or information items) that are created, manipulated, and used during the execution of a **Process**. An important aspect of this is the ability to capture the structure of that data and to query or manipulate that structure.

BPMN does not itself provide a built-in model for describing structure of data or an **Expression** language for querying that data. Instead it formalizes hooks that allow for externally defined data structures and **Expression** languages. In addition, **BPMN** allows for the co-existence of multiple data structure and **Expression** languages within the same model. The compatibility and verification of these languages is outside the scope of this International Standard and becomes the responsibility of the tool vendor.

BPMN designates XML Schema and XPath as its default data structure and **Expression** languages respectively, but vendors are free to substitute their own languages.

10.4.1 Data Modeling

A traditional requirement of **Process** modeling is to be able to model the items (physical or information items) that are created, manipulated, and used during the execution of a **Process**.

This requirement is realized in **BPMN** through various constructs: **Data Objects**, *ItemDefinition*, *Properties*, *Data Inputs*, *Data Outputs*, **Messages**, *Input Sets*, *Output Sets*, and **Data Associations**.

Item-Aware Elements

Several elements in **BPMN** are subject to store or convey items during process execution. These elements are referenced generally as “item-aware elements.” This is similar to the variable construct common to many languages. As with variables, these elements have an *ItemDefinition*.

The data structure these elements hold is specified using an associated `ItemDefinition`. An `ItemAwareElement` MAY be underspecified, meaning that the `structure` attribute of its `ItemDefinition` is optional if the modeler does not wish to define the structure of the associated data.

The elements in the specification defined as item-aware elements are: **Data Objects**, **Data Object References**, **Data Stores**, **Properties**, **DataInputs** and **DataOutputs**.

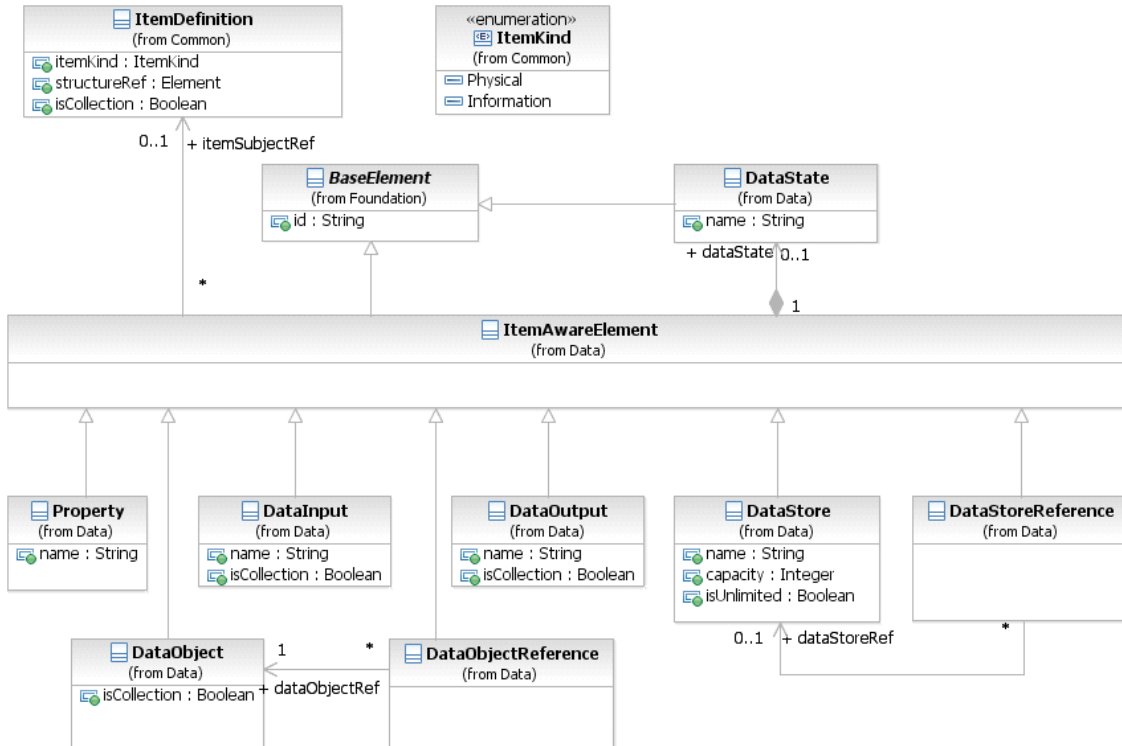

Figure 10.50 – ItemAware class diagram

The `ItemAwareElement` element inherits the attributes and model associations of `BaseElement` (see Table 8.5). Table 10.51 presents the additional model associations of the `ItemAwareElement` element.

Table 10.51 – ItemAwareElement model associations

Attribute Name	Description/Usage
itemSubjectRef: ItemDefinition [0..1]	Specification of the items that are stored or conveyed by the <code>ItemAwareElement</code> .
dataState: DataState [0..1]	A reference to the <code>DataState</code> , which defines certain states for the data contained in the Item.

Data Objects

The primary construct for modeling data within the **Process** flow is the **DataObject** element. A **DataObject** has a well-defined lifecycle, with resulting access constraints.

DataObject

The **Data Object** class is an item-aware element. **Data Object** elements **MUST** be contained within **Process** or **Sub-Process** elements. **Data Object** elements are visually displayed on a **Process** diagram. **Data Object References** are a way to reuse **Data Objects** in the same diagram. They can specify different *states* of the same **Data Object** at different points in a **Process**. **Data Object Reference** cannot specify item definitions, and **Data Objects** cannot specify states. The names of **Data Object References** are derived by concatenating the name of the referenced **Data Object** the state of the **Data Object Reference** in square brackets as follows: <Data Object Name> [<Data Object Reference State>].

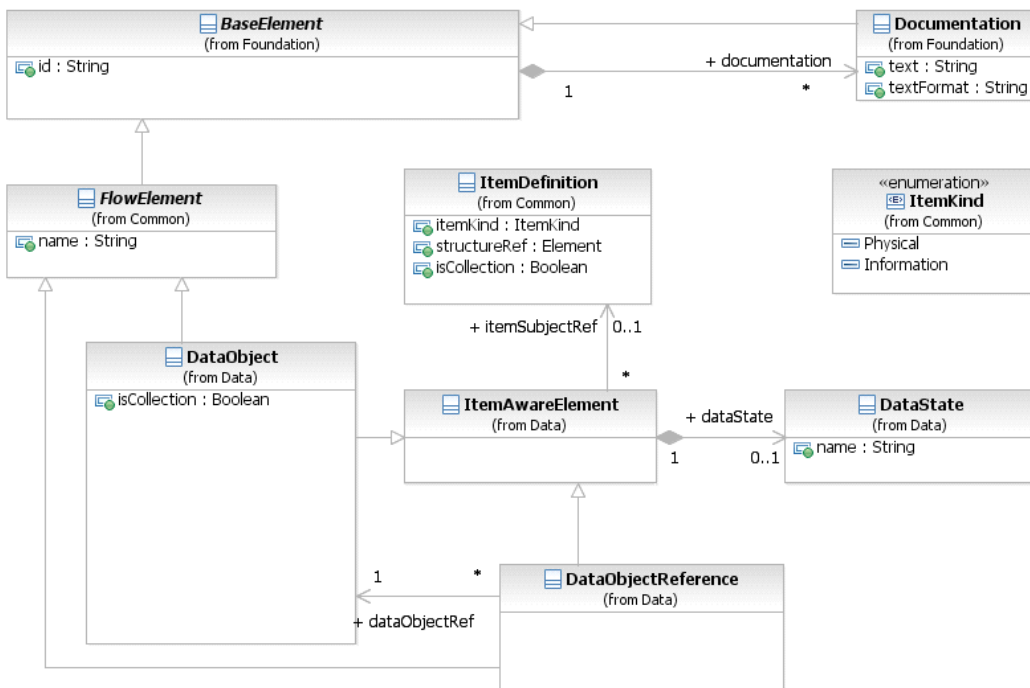

Figure 10.51 – DataObject class diagram

The **DataObject** element inherits the attributes and model associations of **FlowElement** (see Table 8.44) and **ItemAwareElement** (Table 10.52). Table 10.54 presents the additional attributes of the **DataObject** element.

Table 10.52 – DataObject attributes

Attribute Name	Description/Usage
isCollection : boolean = false	Defines if the Data Object represents a collection of elements. It is needed when no <i>itemDefinition</i> is referenced. If an <i>itemDefinition</i> is referenced, then this attribute MUST have the same value as the <i>isCollection</i> attribute of the referenced <i>itemDefinition</i> . The default value for this attribute is <i>false</i> .

The **Data Object Reference** element inherits the attributes and model associations of *ItemAwareElement* (Table 10.52) and *FlowElement* (see Table 8.44). Table 10.53 presents the additional attributes of the **Data Object Reference** element.

Table 10.53 – DataObjectReference attributes and model associations

Attribute Name	Description/Usage
dataObjectRef : <i>DataObject</i>	The Data Object referenced by the Data Object Reference .

States

Data Object elements can optionally reference a *DataState* element, which is the state of the data contained in the **Data Object** (see an example of *DataStates* used for **Data Objects** in Figure 7.8). The definition of these states, e.g., possible values and any specific semantic are out of scope of this International Standard. Therefore, **BPMN** adopters can use the *State* element and the **BPMN** extensibility capabilities to define their states.

The *DataState* element inherits the attributes and model associations of *BaseElement* (see Table 8.5). Table 10.54 presents the additional attributes and model associations of the **DataObject** element.

Table 10.54 – DataState attributes and model associations

Attribute Name	Description/Usage
name : string	Defines the name of the <i>DataState</i> .

Data Objects representing a Collection of Data

A **DataObject** element that references an *ItemDefinition* marked as *collection* has to be visualized differently, compared to single *instance* data structures. The notation looks as follows:

Single *instance* (see Figure 10.52)

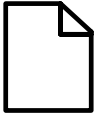

Figure 10.52 – A DataObject

Collection (see Figure 10.53)

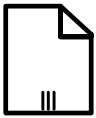

Figure 10.53 – A DataObject that is a collection

Visual representations of Data Objects

Data Object can appear multiple times in a **Process** diagram. Each of these appearances references the same **Data Object instance**. Multiple occurrences of a **Data Object** in a diagram are allowed to simplify diagram connections.

Lifecycle and Accessibility

The lifecycle of a **Data Object** is tied to the lifecycle of its parent **Process** or **Sub-Process**. When a **Process** or **Sub-Process** is instantiated, all **Data Objects** contained within it are also instantiated. When a **Process** or **Sub-Process instance** is disposed, all **Data Object instances** contained within it are also disposed. At this point the data within these *instances* are no longer available.

The accessibility of a **Data Object** is driven by its lifecycle. The data within a **Data Object** can only be accessed when there is guaranteed to be a live **Data Object instance** present. As a result, a **Data Object** can only be accessed by its immediate parent (**Process** or **Sub-Process**), or by its sibling Flow Elements and their children, including **Data Object References** referencing the **Data Object**.

For example - Consider the follow structure:

```
Process A
  Data object 1
  Task A
  Sub-process A
    Data object 2
    Task B
  Sub-process B
    Data object 3
    Sub-process C
      Data object 4
      Task C
    Task D
```

“Data object 1” can be accessed by “Process A,” “Task A,” “Sub-Process A,” “Task B,” “Sub-Process B,” “Sub-Process C,” “Task C,” and “Task D.”

“Data object 2” can be accessed by: “Sub-Process A” and “Task B.”

“Data object 3” can be accessed by: “Sub-Process B,” “Sub-Process C,” “Task C,” and “Task D.”

“Data object 4” can be accessed by: “Sub-Process C” and “Task C.”

Data Stores

A **DataStore** provides a mechanism for **Activities** to retrieve or update stored information that will persist beyond the scope of the **Process**. The same **DataStore** can be visualized, through a **Data Store Reference**, in one or more places in the **Process**.

The **Data Store Reference** is an **ItemAwareElement** and can thus be used as the source or target for a **Data Association**. When data flows into or out of a **Data Store Reference**, it is effectively flowing into or out of the **DataStore** that is being referenced.

The notation looks as follows (see Figure 10.54):



Figure 10.54 – A Data Store

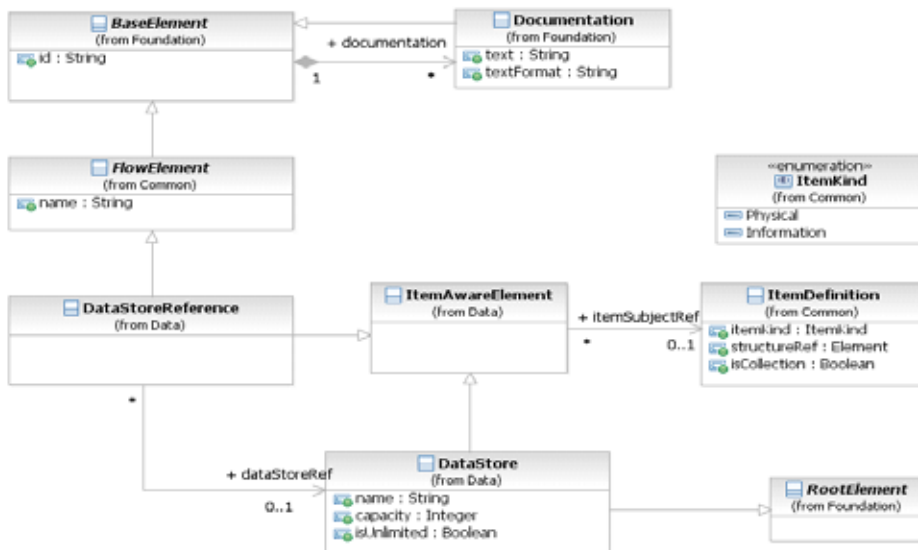

Figure 10.55 – DataStore class diagram

The `DataStore` element inherits the attributes and model associations of `FlowElement` (see Table 8.44) through its relationship to `RootElement`, and `ItemAwareElement` (see Table 10.51). Table 10.55 presents the additional attributes of the `DataStore` element.

Table 10.55 – Data Store attributes

Attribute Name	Description/Usage
<code>name</code> : string	A descriptive name for the element.
<code>capacity</code> : integer [0..1]	Defines the capacity of the Data Store . This is not needed if the <code>isUnlimited</code> attribute is set to <i>true</i> .
<code>isUnlimited</code> : boolean = false	If <code>isUnlimited</code> is set to <i>true</i> , then the capacity of a Data Store is set as unlimited and will override any value of the <code>capacity</code> attribute.

The **Data Store Reference** element inherits the attributes and model associations of `FlowElement` (see Table 8.44) and `ItemAwareElement` (see Table 10.51). Table 10.56 presents the additional model associations of the **Data Store Reference** element.

Table 10.56 – Data Store attributes

Attribute Name	Description/Usage
<code>dataStoreRef</code> : <code>DataStore</code>	Provides the reference to a global <code>DataStore</code> .

Properties

Properties, like **Data Objects**, are item-aware elements. But, unlike **Data Objects**, they are not visually displayed on a **Process** diagram. Certain *flow elements* MAY contain properties, in particular only **Processes**, **Activities**, and **Events** MAY contain Properties.

The `Property` class is a `DataElement` element that acts as a container for data associated with flow elements. `Property` elements MUST be contained within a `FlowElement`. `Property` elements are not visually displayed on a **Process** diagram.

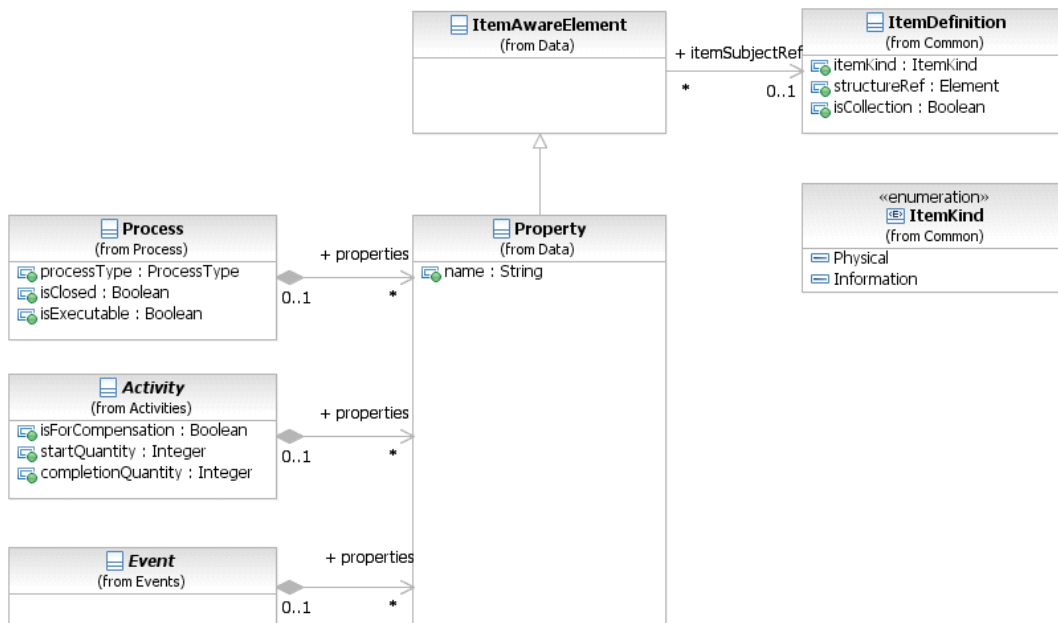

Figure 10.56 – Property class diagram

The `Property` element inherits the attributes and model associations of `ItemAwareElement` (Table 10.51). Table 10.54 presents the additional attributes of the `Property` element.

Table 10.57 – Property attributes

Attribute Name	Description/Usage
<code>name: string</code>	Defines the name of the <code>Property</code> .

Lifecycle and Accessibility

The lifecycle of a `Property` is tied to the lifecycle of its parent `Flow Element`. When a `Flow Element` is instantiated, all `Properties` contained by it are also instantiated. When a `Flow Element instance` is disposed, all `Property instances` contained by it are also disposed. At this point the data within these `instances` are no longer available.

The accessibility of a `Property` is driven by its lifecycle. The data within a `Property` can only be accessed when there is guaranteed to be a live `Property instance` present. As a result, a `Property` can only be accessed by its parent **Process, Sub-Process, or Flow Element**. In case the parent is a **Process or Sub-Process**, then a property can be accessed by the immediate children (including children elements) of that **Process or Sub-Process**. For example, consider the following structure:

```

Process A
  Task A
  Sub-Process A
    Task B
  Sub-Process B
  Sub-Process C
  
```

Task C
Task D

The Properties of “Process A” are accessible by: “Process A,” “Task A,” “Sub-Process A,” “Task B,” “Sub-Process B,” “Sub-Process C,” “Task C,” and “Task D.”

The Properties of “Sub-Process A” are accessible by: “Sub-Process A” and “Task B.”

The Properties of “Task C” are accessible by: “Task C.”

Data Inputs and Outputs

Activities and **Processes** often need data in order to execute. In addition they can produce data during or as a result of execution. Data requirements are captured as **Data Inputs** and `InputSets`. Data that is produced is captured using **Data Outputs** and `OutputSets`. These elements are aggregated in a `InputOutputSpecification` class.

Certain **Activities** and `CallableElements` contain a `InputOutputSpecification` element to describe their data requirements. Execution semantics are defined for the `InputOutputSpecification` and they apply the same way to all elements that extend it. Not every **Activity** type defines inputs and outputs, only **Tasks**, `CallableElements` (**Global Tasks** and **Processes**) *MAY* define their data requirements. Embedded **Sub-Processes** *MUST NOT* define **Data Inputs** and **Data Outputs** directly, however they *MAY* define them indirectly via `MultiInstanceLoopCharacteristics`.

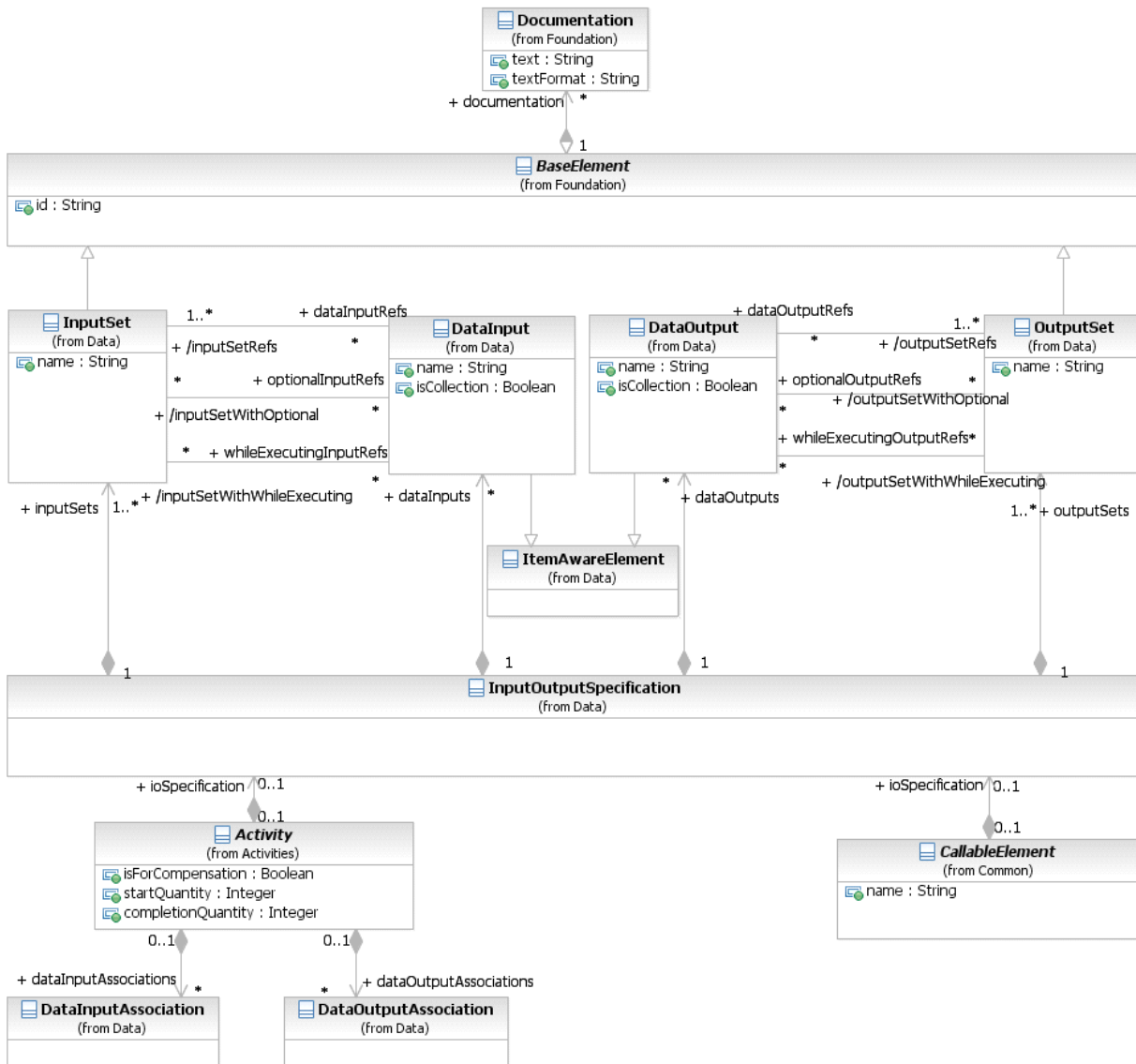

Figure 10.57 – InputOutputSpecification class diagram

The InputOutputSpecification element inherits the attributes and model associations of BaseElement (see Table 8.5). Figure 10.54 presents the additional attributes and model associations of the InputOutputSpecification element.

Table 10.58 – InputOutputSpecification Attributes and Model Associations

Attribute Name	Description/Usage
inputSets: InputSet [1..*]	A reference to the InputSets defined by the InputOutputSpecification. Every InputOutputSpecification MUST define at least one InputSet.
outputSets: OutputSet [1..*]	A reference to the OutputSets defined by the InputOutputSpecification. Every Data Interface MUST define at least one OutputSet.
dataInputs: DataInput [0..*]	An optional reference to the Data Inputs of the InputOutputSpecification. If the InputOutputSpecification defines no Data Input , it means no data is REQUIRED to start the Activity . This is an ordered set.
dataOutputs: DataOutput [0..*]	An optional reference to the Data Outputs of the InputOutputSpecification. If the InputOutputSpecification defines no Data Output , it means no data is REQUIRED to finish the Activity . This is an ordered set.

Data Input

A **Data Input** is a declaration that a particular kind of data will be used as input of the InputOutputSpecification. There may be multiple **Data Inputs** associated with an InputOutputSpecification.

The **Data Input** is an item-aware element. **Data Inputs** are visually displayed on a **Process** diagram to show the inputs to the top-level **Process** or to show the inputs of a called **Process** (i.e., one that is referenced by a **Call Activity**, where the **Call Activity** has been expanded to show the called **Process** within the context of a calling **Process**).

- ◆ Visualized **Data Inputs** have the same notation as **Data Objects**, except that they MUST contain a small, unfilled block arrow (see Figure 10.58).
- ◆ **Data Inputs** MAY have *incoming Data Associations*:
 - ◆ If the **Data Input** is directly contained by the top-level **Process**, it MUST not be the target of **Data Associations** within the underlying model. Only **Data Inputs** that are contained by **Activities** or **Events** MAY be the target of **Data Associations** in the model.
 - ◆ If the **Process** is being called from a **Call Activity**, the **Data Associations** that target the **Data Inputs** of the **Call Activity** in the underlying model MAY be visualized such that they connect to the corresponding **Data Inputs** of the called **Process**, visually crossing the **Call Activity** boundary. But note that this is visualization only. In the underlying model, the **Data Associations** target the **Data Inputs** of the **Call Activity** and not the **Data Inputs** of the called **Process**.

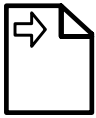

Figure 10.58 – A DataInput

The “optional” attribute defines if a **DataInput** is valid even if the state is “unavailable.” The default value is *false*. If the value of this attribute is *true*, then the execution of the **Activity** will not begin until a value is assigned to the **DataInput** element, through the corresponding **Data Associations**.

States

DataInput elements can optionally reference a `DataState` element, which is the state of the data contained in the **DataInput**. The definition of these states, e.g., possible values, and any specific semantics are out of scope of this International Standard. Therefore, **BPMN** adopters can use the `DataState` element and the **BPMN** extensibility capabilities to define their states.

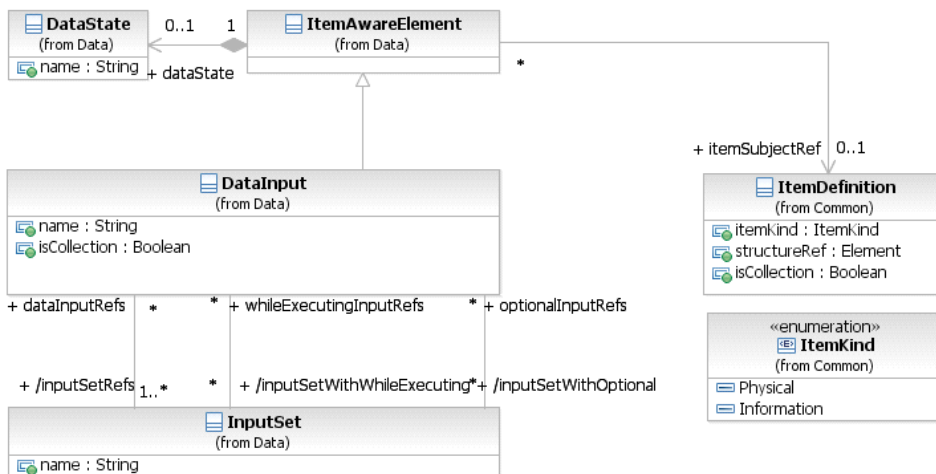

Figure 10.59 – Data Input class diagram

The **DataInput** element inherits the attributes and model associations of `BaseElement` (see Table 8.5) and `ItemAwareElement` (Table 10.52). Table 10.59 presents the additional attributes and model associations of the **DataInput** element.

Table 10.59 – DataInput attributes and model associations

Attribute Name	Description/Usage
name: string [0..1]	A descriptive name for the element.
inputSetRefs: InputSet [1..*]	A DataInput is used in one or more InputSets. This attribute is derived from the InputSets.
inputSetwithOptional: InputSet [0..*]	Each InputSet that uses this DataInput can determine if the Activity can start executing with this DataInput state in “ unavailable. ” This attribute lists those InputSets.
inputSetWithWhileExecuting: Inputset [0..*]	Each InputSet that uses this DataInput can determine if the Activity can evaluate this DataInput while executing. This attribute lists those InputSets.
isCollection: boolean = false	Defines if the DataInput represents a collection of elements. It is needed when no <i>itemDefinition</i> is referenced. If an <i>itemDefinition</i> is referenced, then this attribute MUST have the same value as the <i>isCollection</i> attribute of the referenced <i>itemDefinition</i> . The default value for this attribute is <i>false</i> .

Data Output

A **Data Output** is a declaration that a particular kind of data can be produced as output of the *InputOutputSpecification*. There **MAY** be multiple **Data Outputs** associated with a *InputOutputSpecification*.

The **Data Output** is an item-aware element. **Data Output** are visually displayed on a top-level **Process** diagram to show the outputs of the **Process** (i.e., one that is referenced by a **Call Activity**, where the **Call Activity** has been expanded to show the called **Process** within the context of a calling **Process**).

- ◆ Visualized **Data Outputs** have the same notation as **Data Objects**, except that they **MUST** contain a small, filled block arrow (see Figure 10.60).
- ◆ **Data Outputs** **MAY** have *outgoing* **DataAssociations**.
 - ◆ If the **Data Output** is directly contained by the top-level **Process**, it **MUST** not be the source of **Data Associations** within the underlying model. Only **Data Outputs** that are contained by **Activities** or **Events** **MAY** be the target of **Data Associations** in the model.
 - ◆ If the **Process** is being called from a **Call Activity**, the **Data Associations** that target the **Data Outputs** of the **Call Activity** in the underlying model **MAY** be visualized such that they connect to the corresponding **Data Outputs** of the called **Process**, visually crossing the **Call Activity** boundary. But note that this is visualization only. In the underlying model, the **Data Associations** originate the **Data Outputs** of the **Call Activity** and not the **Data Outputs** of the called **Process**.

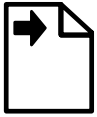

Figure 10.60 – A Data Output

States

DataOutput elements can optionally reference a **DataState** element, which is the state of the data contained in the **DataOutput**. The definition of these states, e.g., possible values, and any specific semantics are out of scope of this International Standard. Therefore, **BPMN** adopters can use the **DataState** element and the **BPMN** extensibility capabilities to define their states.

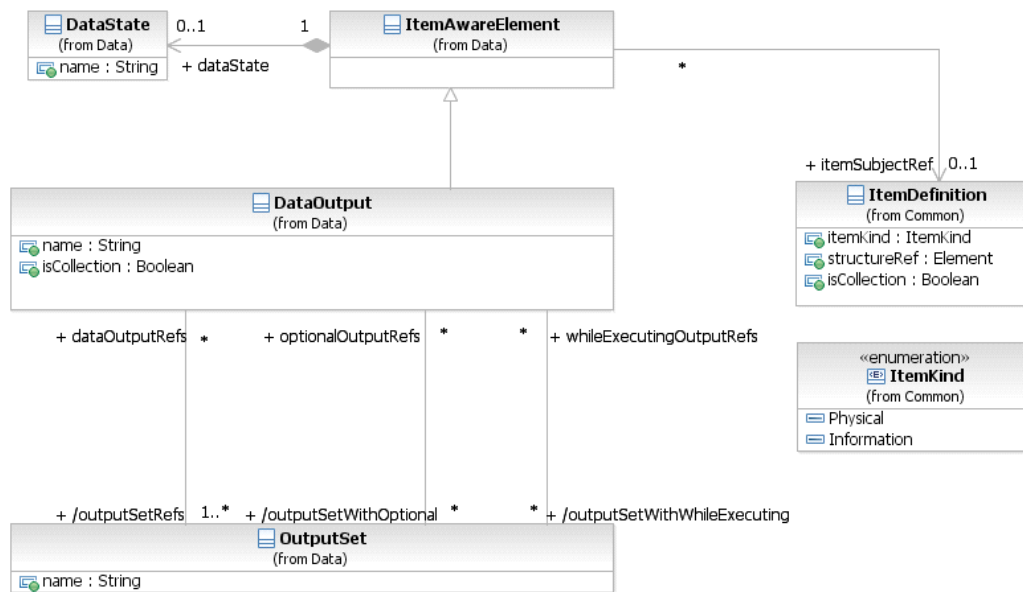

Figure 10.61 – Data Output class diagram

The **DataOutput** element inherits the attributes and model associations of **BaseElement** (see Table 8.5) and **ItemAwareElement** (Table 10.52). Table 10.60 presents the additional attributes and model associations of the **DataInput** element.

Table 10.60 – DataOutput attributes and associations

Attribute Name	Description/Usage
name: string [0..1]	A descriptive name for the element.
outputSetRefs: OutputSet [1..*]	A DataOutput is used in one or more OutputSets. This attribute is derived from the OutputSets.
outputSetwithOptional: OutputSet [0..*]	Each OutputSet that uses this DataOutput can determine if the Activity can complete executing without producing this DataInput. This attribute lists those OutputSets.
outputSetWithWhileExecuting: OutputSet [0..*]	Each OutputSet that uses this DataInput can determine if the Activity can produce this DataOutput while executing. This attribute lists those OutputSets.
isCollection: boolean = false	Defines if the DataOutput represents a collection of elements. It is needed when no <i>itemDefinition</i> is referenced. If an <i>itemDefinition</i> is referenced, then this attribute MUST have the same value as the <i>isCollection</i> attribute of the referenced <i>itemDefinition</i> . The default value for this attribute is <i>false</i> .

The following describes the mapping of data inputs and outputs to the specific **Activity** and **Event** implementations.

Service Task Mapping

If the **Service Task** is associated with an *Operation*, there **MUST** be a **Message Data Input** on the **Service Task** and it **MUST** have an *itemDefinition* equivalent to the one defined by the **Message** referred to by the *inMessageRef* attribute of the operation. If the operation defines output **Messages**, there **MUST** be a single **Data Output** and it **MUST** have an *itemDefinition* equivalent to the one defined by **Message** referred to by the *outMessageRef* attribute of the *Operation*.

Send Task Mapping

If the **Send Task** is associated with a **Message**, there **MUST** be at most *inputSet* set and at most one **Data Input** on the **Send Task**. If the **Data Input** is present, it **MUST** have an *itemDefinition* equivalent to the one defined by the associated **Message**. If the **Data Input** is not present, the **Message** will not be populated with data at execution time.

Receive Task Mapping

If the **Receive Task** is associated with a **Message**, there **MUST** be at most *outputSet* set and at most one **Data Output** on the **Receive Task**. If the **Data Output** is present, it **MUST** have an *itemDefinition* equivalent to the one defined by the associated **Message**. If the **Data Output** is not present, the payload within the **Message** will not flow out of the **Receive Task** and into the **Process**.

User Task Mapping

User Tasks have access to the **Data Input**, **Data Output** and the data aware elements available in the scope of the **User Task**.

Call Activity Mapping

The `DataInputs` and `DataOutputs` of the **Call Activity** are mapped to the corresponding elements in the `CallableElement` without any explicit `DataAssociation`.

Script Task Mapping

Script Tasks have access to the **Data Input**, **Data Output** and the data aware elements available in the scope of the **Script Task**.

Events

If any of the `EventDefinitions` for the **Event** is associated with an element that has an `ItemDefinition` (such as a `Message`, `Escalation`, `Error`, or `Signal`), the following constraints apply:

- If the **Event** is associated with multiple `EventDefinitions`, there **MUST** be one **Data Input** (in the case of *throw Events*) or one **Data Output** (in the case of *catch Event*) for each `EventDefinition`. The order of the `EventDefinitions` and the order of the **Data Inputs/Outputs** determine which **Data Input/Output** corresponds with which `EventDefinition`.
- For each `EventDefinition` and **Data Input/Output** pair, if the **Data Input/Output** is present, it **MUST** have an `ItemDefinition` equivalent to the one defined by the `Message`, `Escalation`, `Error`, or `Signal` on the associated `EventDefinition`. In the case of a *throw Event*, if the **Data Input** is not present, the `Message`, `Escalation`, `Error`, or `Signal` will not be populated with data. In the case of a *catch Event*, if the **Data Output** is not present, the payload within the `Message`, `Escalation`, `Error`, or `Signal` will not flow out of the **Event** and into the **Process**.

InputSet

An `InputSet` is a collection of `DataInput` elements that together define a valid set of data inputs for an `InputOutputSpecification`. An `InputOutputSpecification` **MUST** have at least one `InputSet` element. An `InputSet` **MAY** reference zero or more `DataInput` elements. A single `DataInput` **MAY** be associated with multiple `InputSet` elements, but it **MUST** always be referenced by at least one `InputSet`.

An “empty” `InputSet`, one that references no `DataInput` elements, signifies that the **Activity** requires no data to start executing (this implies that either there are no data inputs or they are referenced by another input set).

`InputSet` elements are contained by `InputOutputSpecification` elements; the order in which these elements are included defines the order in which they will be evaluated.

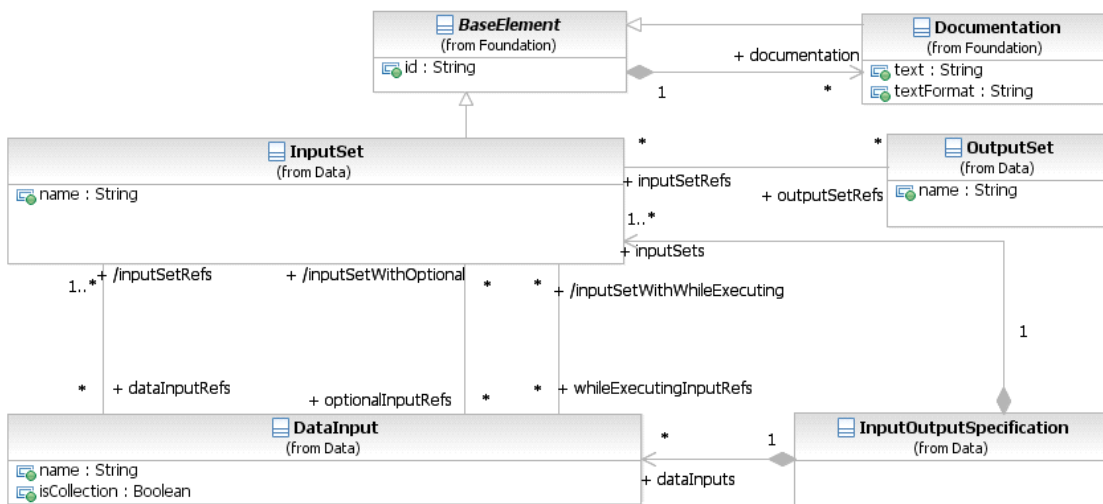

Figure 10.62 – InputSet class diagram

The InputSet element inherits the attributes and model associations of BaseElement (see Table 8.5). Table 10.61 presents the additional attributes and model associations of the InputSet element.

Table 10.61 – InputSet attributes and model associations

Attribute Name	Description/Usage
name: string [0..1]	A descriptive name for the input set.
dataInputRefs: DataInput [0..*]	The DataInput elements that collectively make up this data requirement.
optionalInputRefs: DataInput [0..*]	The DataInput elements that are a part of the InputSet that can be in the state of “unavailable” when the Activity starts executing. This association MUST NOT reference a DataInput that is not listed in the dataInputRefs.
whileExecutingInputRefs: DataInput [0..*]	The DataInput elements that are a part of the InputSet that can be evaluated while the Activity is executing. This association MUST NOT reference a DataInput that is not listed in the dataInputRefs.
outputSetRefs: OutputSet [0..*]	Specifies an Input/Output rule that defines which OutputSet is expected to be created by the Activity when this InputSet became valid. This attribute is paired with the inputSetRefs attribute of OutputSets. This combination replaces the IORules attribute for Activities in BPMN 1.2 .

OutputSet

An OutputSet is a collection of DataOutputs elements that together can be produced as output from an **Activity** or Event. An InputOutputSpecification element **MUST** define at least OutputSet element. An OutputSet **MAY** reference zero or more DataOutput elements. A single DataOutput **MAY** be associated with multiple OutputSet elements, but it **MUST** always be referenced by at least one OutputSet.

An “empty” OutputSet, one that is associated with no DataOutput elements, signifies that the **ACTIVITY** produces no data.

The implementation of the element where the OutputSet is defined determines the OutputSet that will be produced. So it is up to the **Activity** implementation or the **Event**, to define which OutputSet will be produced.

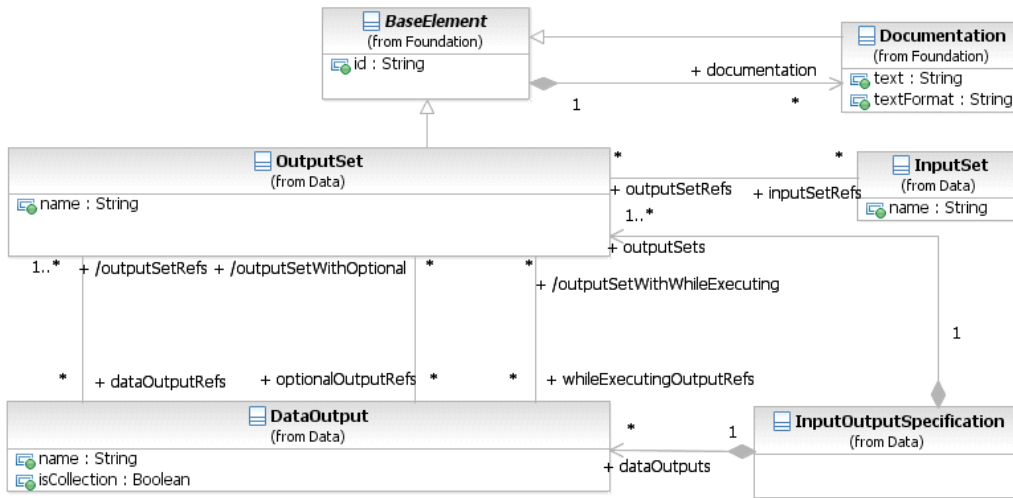

Figure 10.63 – OutputSet class diagram

The OutputSet element inherits the attributes and model associations of BaseElement (see Table 8.5). Table 10.62 presents the additional attributes and model associations of the OutputSet element.

Table 10.62 – OutputSet attributes and model associations

Attribute Name	Description/Usage
name: string [0..1]	A descriptive name for the input set.
dataOutputRefs: DataOutput [0..*]	The DataOutput elements that MAY collectively be outputted.
optionalOutputRefs: DataOutput [0..*]	The DataOutput elements that are a part of the OutputSet that do not have to be produced when the Activity completes executing. This association MUST NOT reference a DataOutput that is not listed in the dataOutputRefs.
whileExecutingOutputRefs: DataOutput [0..*]	The DataOutput elements that are a part of the OutputSet that can be produced while the Activity is executing. This association MUST NOT reference a DataOutput that is not listed in the dataOutputRefs.
inputSetRefs: InputSet [0..*]	Specifies an Input/Output rule that defines which InputSet has to become valid to expect the creation of this OutputSet. This attribute is paired with the outputSetRefs attribute of InputSets. This combination replaces the IORules attribute for Activities in BPMN 1.2 .

Data Associations

Data Associations are used to move data between **Data Objects**, *Properties*, and *inputs* and *outputs* of **Activities**, **Processes**, and *GlobalTasks*. *Tokens* do not flow along a **Data Association**, and as a result they have no direct effect on the flow of the **Process**.

The purpose of retrieving data from **Data Objects** or **Process Data Inputs** is to fill the **Activities** *inputs* and later push the *output* values from the execution of the **Activity** back into **Data Objects** or **Process Data Outputs**.

DataAssociation

The DataAssociation class is a BaseElement contained by an **Activity** or **Event**, used to model how data is pushed into or pulled from item-aware elements. DataAssociation elements have one or more sources and a target; the source of the association is copied into the target.

The ItemDefinition from the sourceRef and targetRef MUST have the same ItemDefinition or the **DataAssociation** MUST have a transformation Expression that transforms the source ItemDefinition into the target ItemDefinition.

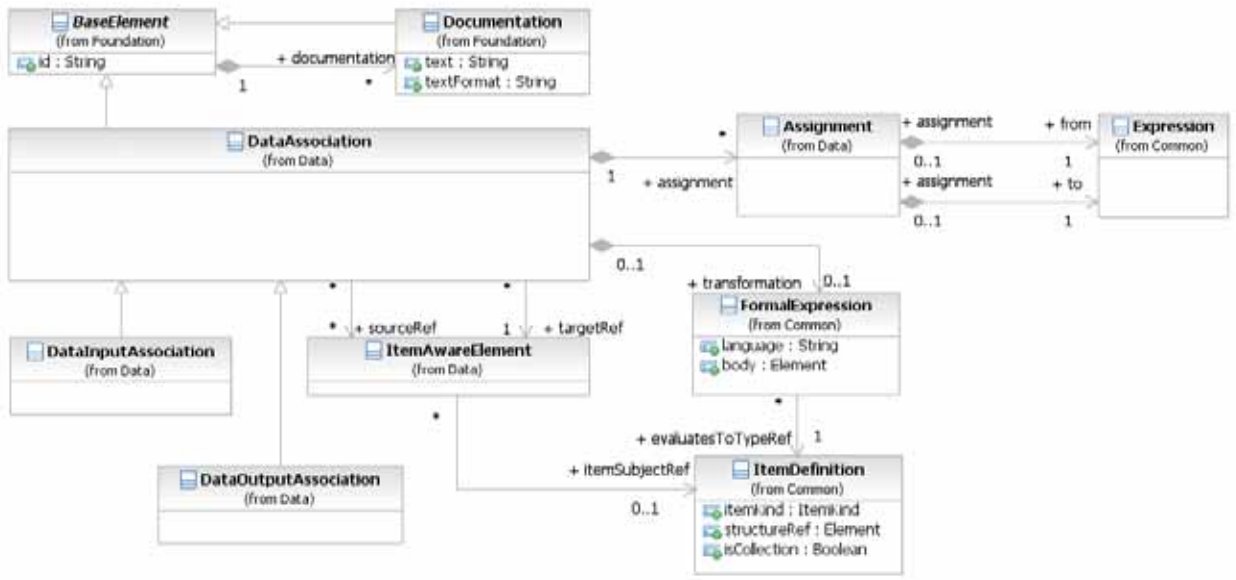

Figure 10.64 – DataAssociation class diagram

Optionally, **Data Associations** can be visually represented in the diagram by using the Association connector style (see Figure 10.65 and Figure 10.66).



Figure 10.65 – A Data Association

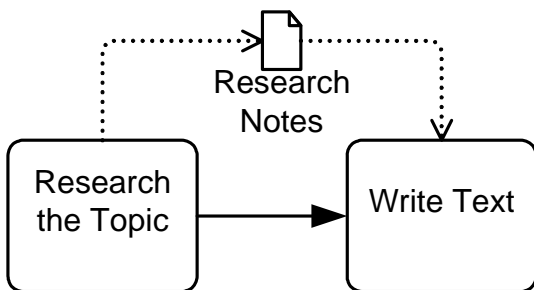

Figure 10.66 – A Data Association used for an Outputs and Inputs into an Activities

The core concepts of a DataAssociation are that they have sources, a target, and an optional transformation.

When a data association is “executed,” data is copied to the target. What is copied depends if there is a transformation defined or not.

If there is no transformation defined or referenced, then only one source **MUST** be defined, and the contents of this source will be copied into the target.

If there is a transformation defined or referenced, then this transformation **Expression** will be evaluated and the result of the evaluation is copied into the target. There can be zero (0) to many sources defined in this case, but there is no requirement that these sources are used inside the **Expression**.

In any case, sources are used to define if the data association can be “executed,” if any of the sources is in the state of “unavailable,” then the data association cannot be executed, and the **Activity** or **Event** where the data association is defined **MUST** wait until this condition is met.

Data Associations are always contained within another element that defines when these data associations are going to be executed. **Activities** define two sets of data associations, while **Events** define only one.

For **Events**, there is only one set, but they are used differently for *catch* or *throw* **Events**. For a *catch* **Event**, data associations are used to push data from the **Message** received into **Data Objects** and properties. For a *throw* **Event**, data associations are used to fill the **Message** that is being thrown.

As **DataAssociations** are used in different stages of the **Process** and **Activity** lifecycle, the possible sources and targets vary according to that stage. This defines the scope of possible elements that can be referenced as source and target. For example: when an **Activity** starts executing, the scope of valid targets include the **Activity** data inputs, while at the end of the **Activity** execution, the scope of valid sources include **Activity** data outputs.

The **DataAssociation** element inherits the attributes and model associations of **BaseElement** (see Table 8.5). Table 10.63 presents the additional model associations of the **DataAssociation** element.

Table 10.63 – DataAssociation model associations

Attribute Name	Description/Usage
transformation: Expression [0..1]	Specifies an optional transformation Expression . The actual scope of accessible data for that Expression is defined by the source and target of the specific Data Association types.
assignment: Assignment [0..*]	Specifies one or more data elements Assignments . By using an Assignment , single data structure elements can be assigned from the source structure to the target structure.
sourceRef: ItemAwareElement [0..*]	Identifies the source of the Data Association . The source MUST be an ItemAwareElement .
targetRef: ItemAwareElement	Identifies the target of the Data Association . The target MUST be an ItemAwareElement .

Assignment

The **Assignment** class is used to specify a simple mapping of data elements using a specified **Expression** language.

The default **Expression** language for all **Expressions** is specified in the **Definitions** element, using the **expressionLanguage** attribute. It can also be overridden on each individual **Assignment** using the same attribute.

The **Assignment** element inherits the attributes and model associations of **BaseElement** (see Table 8.5). Table 10.64 presents the additional attributes of the **Assignment** element.

Table 10.64 – Assignment attributes

Attribute Name	Description/Usage
from: Expression	The Expression that evaluates the source of the Assignment.
to: Expression	The Expression that defines the actual Assignment operation and the target data element.

DataInputAssociation

The DataInputAssociation can be used to associate an ItemAwareElement element with a DataInput contained in an **Activity**. The source of such a **DataAssociation** can be every ItemAwareElement accessible in the current scope, e.g., a **Data Object**, a Property, or an Expression.

The DataInputAssociation element inherits the attributes and model associations of DataAssociation (see Table 10.64), but does not contain any additional attributes or model associations.

DataOutputAssociation

The DataOutputAssociation can be used to associate a DataOutput contained within an **ACTIVITY** with any ItemAwareElement accessible in the scope the association will be executed in. The target of such a **DataAssociation** can be every ItemAwareElement accessible in the current scope, e.g., a **Data Object**, a Property, or an Expression.

The DataOutputAssociation element inherits the attributes and model associations of DataAssociation (see Table 10.64), but does not contain any additional attributes or model associations.

Data Objects associated with a Sequence Flow

Figure 10.67 repeats Figure 10.66, above, and shows how **Data Associations** are used to represent inputs and outputs of **Activities**.

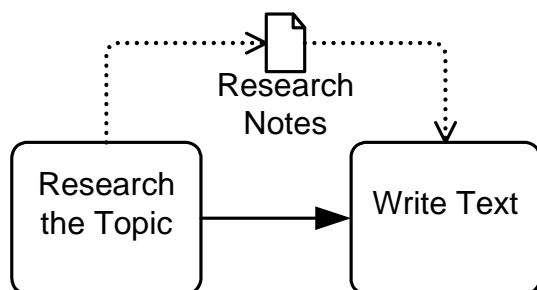

Figure 10.67 – A Data Object shown as an output and an inputs

Alternatively, **Data Objects** MAY be directly associated with a **Sequence Flow** connector (see Figure 10.68) to represent the same input/output relationships. This is a visual short cut that normalizes two **Data Associations** (e.g., as seen in Figure 10.67): one from an item-aware element (e.g., an **Activity**) contained by the source of the **Sequence Flow**, connecting to the **Data Object**; and the other from the **Data Object** connecting to a item-aware element contained by the target of the **Sequence Flow**.

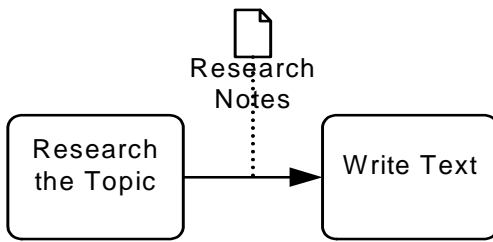

Figure 10.68 – A Data Object associated with a Sequence Flow

10.4.2 Execution Semantics for Data

When an element that defines an `InputOutputSpecification` is ready to begin execution by means of **Sequence Flow** or **Event** being caught, the inputs of the interface are filled with data coming from elements in the context, such as **Data Objects** or Properties. The way to represent these assignments is the **Data Association** elements.

Each defined `InputSet` element will be evaluated in the order they are included in the `InputOutputSpecification`.

For each `InputSet`, the data inputs it references will be evaluated if it is valid.

All data associations that define as target the data input will be evaluated, and if any of the sources of the data association is “**unavailable**,” then the `InputSet` is “**unavailable**” and the next `InputSet` is evaluated.

The first `InputSet` where all data inputs are “available” (by means of data associations) is used to start the execution of the **Activity**. If no `InputSet` is “available,” then the execution will wait until this condition is met.

The time and frequency of when and how often this condition is evaluated is out of scope for this International Standard. Implementations will wait for the sources of data associations to become available and then re-evaluate the `InputSets`.

In the case of *throw* and *catch* **Events**, given their nature, the execution semantics for data is different.

When a *throw* **Event** is activated, all `DataInputAssociations` of the event are executed, filling the **Data Inputs** of the **Event**. Finally, `DataInputs` are then copied to the elements thrown by the **Event** (**Messages**, **Signals**, etc.). Since there are no `InputSets` defined for **Events**, the execution will never wait.

When a *catch* **Event** is activated, **Data Outputs** of the event are filled with the element that triggered the **Event**. Then all `DataOutputAssociations` of the **Event** are executed. There are no `OutputSets` defined for **Events**.

To allow invoking a **Process** from both a **Call Activity** and via **Message Flow**, the **Start Event** and **End Event** support an additional case.

In the case of a **Start Event**, the **Data Inputs** of the enclosing process are available as targets to the `DataOutputAssociations` of the **Event**. This way the **Process Data Inputs** can be filled using the elements that triggered the **Start Event**.

In the case of an **End Event**, the **Data Outputs** of the enclosing process are available as sources to the `DataInputAssociations` of the **Event**. This way the resulting elements of the **End Event** can use the **Process Data Outputs** as sources.

Once an **InputSet** becomes “available,” all **Data Associations** whose target is any of the **Data Inputs** of the **InputSet** are executed. These executions fill the Activity **Data Inputs** and the execution of the **Activity** can begin. When an **Activity** finishes execution, all **Data Associations** whose sources are any of the **Data Outputs** of the **OutputSet** are executed. These executions copy the values from the **Data Outputs** back to the container’s context (**Data Object**, **Properties**, etc.).

Execution Semantics for DataAssociation

The execution of any **Data Associations** MUST follow these semantics:

- If the **Data Association** specifies a “transformation” Expression, this expression is evaluated and the result is copied to the **targetRef**. This operation replaces completely the previous value of the **targetRef** element.
- For each “assignment” element specified:
 - Evaluate the Assignment’s “from” expression and obtain the **source value**.
 - Evaluate the Assignment’s “to” expression and obtain the **target element**. The **target element** can be any element in the context or a sub-element of it (e.g., a **DataObject** or a sub-element of it).
 - Copy the **source value** to the **target element**.
- If no “transformation” Expression nor any “assignment” elements are defined in the **Data Association**:
 - Copy the **Data Association** “sourceRef” value into the “targetRef.” Only one **sourceRef** element is allowed in this case.

10.4.3 Usage of Data in XPath Expressions

BPMN extensibility mechanism enables the usage of various languages for Expressions and queries. This sub clause describes how XPath is used in **BPMN**. It introduces a mechanism to access **BPMN Data Objects**, **BPMN Properties**, and various *instance* attributes from XPath Expressions. The accessibility by the Expression language is defined based on the entities accessibility by the **Activity** that contains the Expression. All elements accessible from the enclosing element of an XPath Expression MUST be made available to the XPath processor.

BPMN Data Objects and **BPMN Properties** are defined using **ItemDefinition**. The XPath binding assumes that the **ItemDefinition** is either an XSD complex type or an XSD element. If XSD element is used, it MUST be manifested as a node-set XPath variable with a single member node. If XSD complex type is used, it MUST be manifested as a node-set XPath variable with one member node containing the anonymous document element that contains the actual value of the **BPMN Data Object** or *Property*.

Access to BPMN Data Objects

Table 10.65 introduces an XPath function used to access **BPMN Data Objects**. Argument **processName** names **Process** and is of type string. Argument **dataObjectName** names **Data Object** and is of type string. It MUST be a literal string.

Table 10.65 – XPath Extension Function for Data Objects

XPath Extension Function	Description/Usage
Element getDataObject ('processName', 'dataObjectName')	This extension function returns value of submitted Data Object . Argument <code>processName</code> is optional. If omitted, the process enclosing the Activity that contains the <code>Expression</code> is assumed. In order to access Data Objects defined in a parent process the <code>processName</code> MUST be used. Otherwise it MUST be omitted.

Because XPath 1.0 functions do not support returning faults, an empty node set is returned in the event of an error.

Access to BPMN Data Input and Data Output

Table 10.66 introduces XPath functions used to access **BPMN Data Inputs** and **BPMN Data Outputs**. Argument `dataInputName` names a **Data Input** and is of type `string`. Argument `dataOutput` names a **Data Output** and is of type `string`.

Table 10.66 – XPath Extension Function for Data Inputs and Data Outputs

XPath Extension Function	Description/Usage
Element getDataInput ('dataInputName')	This extension function returns the value of the submitted Data Input .
Element getDataOutput ('dataOutputName')	This extension function returns the value of the submitted Data Output .

Access to BPMN Properties

Table 10.67 introduces XPath functions used to access **BPMN Properties**.

Argument `processName` names **Process** and is of type `string`. Argument `propertyName` names property and is of type `string`. Argument `activityName` names **Activity** and is of type `string`. Argument `eventName` names **Event** and is of type `string`. These strings **MUST** be literal strings. The XPath extension functions return value of the submitted property. Because XPath 1.0 functions do not support returning faults, an empty node set is returned in the event of an error.

Table 10.67 – XPath Extension Functions for Properties

XPath Extension Function	Description/Usage
Element getProcessProperty (‘processName’, ‘propertyName’)	This extension function returns value of submitted Process property. Argument <code>processName</code> is optional. If omitted, the Process enclosing the Activity that contains the Expression is assumed. In order to access Properties defined in a parent Process the <code>processName</code> MUST be used. Otherwise it MUST be omitted.
Element getActivityProperty (‘activityName’, ‘propertyName’)	This extension function returns value of submitted Activity property.
Element getEventProperty (‘eventName’, ‘propertyName’)	This extension function returns value of submitted Event property.

For BPMN Instance Attributes

Table 10.68 introduces XPath functions used to access **BPMN instance Attributes**.

Argument `processName` names **Process** and is of type `string`. Argument `attributeName` names *instance* attribute and is of type `string`. Argument `activityName` names **Activity** and is of type `string`. These strings MUST be literal strings.

These functions return value of the submitted *instance* **Activity**. Because XPath 1.0 functions do not support returning faults, an empty node set is returned in the event of an error.

Table 10.68 – XPath extension functions for instance attributes

XPath Extension Function	Description/Usage
Element getProcessInstanceAttribute (‘processName’, ‘attributeName’)	This extension function returns value of submitted Process instance attribute. Argument <code>processName</code> is optional. If omitted, the Process enclosing the Activity that contains the Expression is assumed. In order to access <i>instance</i> Attributes of a parent Process the <code>processName</code> MUST be used. Otherwise it MUST be omitted.
Element getChoreographyInstanceAttribute (‘attributeName’)	This extension function returns value of submitted Choreography instance attribute.
Element getActivityInstanceAttribute (‘activityName’, ‘attributeName’)	This extension function returns value of submitted Activity instance attribute. User Task and loop are examples of Activities .

10.4.4 XML Schema for Data

Table 10.69 – Assignment XML schema

```

<xsd:element name="assignment" type="tAssignment" />
<xsd:complexType name="tAssignment">
  <xsd:complexContent>
    <xsd:extension base="tBaseElement">
      <xsd:sequence>
        <xsd:element name="from" type="tExpression" minOccurs="1" maxOccurs="1"/>
        <xsd:element name="to" type="tExpression" minOccurs="1" maxOccurs="1"/>
      </xsd:sequence>
    </xsd:extension>
  </xsd:complexContent>
</xsd:complexType>

```

Table 10.70 – DataAssociation XML schema

```
<xsd:element name="dataAssociation" type="tDataAssociation" />
<xsd:complexType name="tDataAssociation" abstract="true">
  <xsd:complexContent>
    <xsd:extension base="tBaseElement">
      <xsd:sequence>
        <xsd:element name="sourceRef" type="xsd:IDREF" minOccurs="0" maxOccurs="unbounded"/>
        >
        <xsd:element name="targetRef" type="xsd:IDREF" minOccurs="1" maxOccurs="1"/>
        <xsd:element name="transformation" type="tFormalExpression" minOccurs="0" maxOccurs="1"/>
        <xsd:element ref="assignment" minOccurs="0" maxOccurs="unbounded"/>
      </xsd:sequence>
    </xsd:extension>
  </xsd:complexContent>
</xsd:complexType>
```

Table 10.71 – DataInput XML schema

```
<xsd:element name="dataInput" type="tDataInput" />
<xsd:complexType name="tDataInput">
  <xsd:complexContent>
    <xsd:extension base="tBaseElement">
      <xsd:attribute name="name" type="xsd:string" use="optional" />
      <xsd:attribute name="itemSubjectRef" type="xsd:QName" />
      <xsd:attribute name="isCollection" type="xsd:boolean" default="false"/>
      <xsd:attribute name="dataState" type="xsd:IDREF"/>
    </xsd:extension>
  </xsd:complexContent>
</xsd:complexType>
```

Table 10.72 – DataInputAssociation XML schema

```
<xsd:element name="dataInputAssociation" type="tDataInputAssociation" />
<xsd:complexType name="tDataInputAssociation">
  <xsd:complexContent>
    <xsd:extension base="tDataAssociation"/>
  </xsd:complexContent>
</xsd:complexType>
```

Table 10.73 – DataObject XML schema

```
<xsd:element name="dataObject" type="tDataObject" />
<xsd:complexType name="tDataObject">
  <xsd:complexContent>
    <xsd:extension base="tFlowElement">
      <xsd:sequence>
        <xsd:element ref="dataState" minOccurs="0" maxOccurs="1"/>
      </xsd:sequence>
      <xsd:attribute name="itemSubjectRef" type="xsd:QName"/>
      <xsd:attribute name="isCollection" type="xsd:boolean"/>
    </xsd:extension>
  </xsd:complexContent>
</xsd:complexType>
```

Table 10.74 – DataState XML schema

```
<xsd:element name="dataState" type="tDataState" />
<xsd:complexType name="tDataState">
  <xsd:complexContent>
    <xsd:extension base="tBaseElement">
      <xsd:attribute name="name" type="xsd:string"/>
    </xsd:extension>
  </xsd:complexContent>
</xsd:complexType>
```

Table 10.75 – DataOutput XML schema

```
<xsd:element name="dataOutput" type="tDataOutput" />
<xsd:complexType name="tDataOutput">
  <xsd:complexContent>
    <xsd:extension base="tBaseElement">
      <xsd:attribute name="name" type="xsd:string" use="optional"/>
      <xsd:attribute name="itemSubjectRef" type="xsd:QName"/>
      <xsd:attribute name="isCollection" type="xsd:boolean" default="false"/>
      <xsd:attribute name="dataState" type="xsd:IDREF"/>
    </xsd:extension>
  </xsd:complexContent>
</xsd:complexType>
```

Table 10.76 – DataOutputAssociation XML schema

```
<xsd:element name="dataOutputAssociation" type="tDataOutputAssociation" />
<xsd:complexType name="tDataOutputAssociation">
  <xsd:complexContent>
    <xsd:extension base="tDataAssociation"/>
  </xsd:complexContent>
</xsd:complexType>
```

Table 10.77 – InputOutputSpecification XML schema

```
<xsd:element name="ioSpecification" type="tInputOutputSpecification" />
<xsd:complexType name="tInputOutputSpecification">
  <xsd:complexContent>
    <xsd:extension base="tBaseElement">
      <xsd:sequence>
        <xsd:element ref="dataInput" minOccurs="0" maxOccurs="unbounded"/>
        <xsd:element ref="dataOutput" minOccurs="0" maxOccurs="unbounded"/>
        <xsd:element ref="inputSet" minOccurs="1" maxOccurs="unbounded"/>
        <xsd:element ref="outputSet" minOccurs="1" maxOccurs="unbounded"/>
      </xsd:sequence>
    </xsd:extension>
  </xsd:complexContent>
</xsd:complexType>
```

Table 10.78 – InputSet XML schema

```
<xsd:element name="inputSet" type="tInputSet" />
<xsd:complexType name="tInputSet">
  <xsd:complexContent>
    <xsd:extension base="tBaseElement">
      <xsd:sequence>
        <xsd:element name="dataInputRefs" type="xsd:IDREF" minOccurs="0" maxOccurs="unbounded"/>
        <xsd:element name="optionalInputRefs" type="xsd:IDREF" minOccurs="0" maxOccurs="unbounded"/>
        <xsd:element name="whileExecutingInputRefs" type="xsd:IDREF" minOccurs="0" maxOccurs="unbounded"/>
        <xsd:element name="outputSetRefs" type="xsd:IDREF" minOccurs="0" maxOccurs="unbounded"/>
      </xsd:sequence>
      <xsd:attribute name="name" type="xsd:string" />
    </xsd:extension>
  </xsd:complexContent>
</xsd:complexType>
```

Table 10.79 – OutputSet XML schema

```
<xsd:element name="outputSet" type="tOutputSet" />
<xsd:complexType name="tOutputSet">
  <xsd:complexContent>
    <xsd:extension base="tBaseElement">
      <xsd:sequence>
        <xsd:element name="dataOutputRefs" type="xsd:IDREF" minOccurs="0" maxOccurs="unbounded"/>
        <xsd:element name="optionalOutputRefs" type="xsd:IDREF" minOccurs="0" maxOccurs="unbounded"/>
        <xsd:element name="whileExecutingOutputRefs" type="xsd:IDREF" minOccurs="0" maxOccurs="unbounded"/>
        <xsd:element name="inputSetRefs" type="xsd:IDREF" minOccurs="0" maxOccurs="unbounded"/>
      </xsd:sequence>
      <xsd:attribute name="name" type="xsd:string"/>
    </xsd:extension>
  </xsd:complexContent>
</xsd:complexType>
```

Table 10.80 – Property XML schema

```
<xsd:element name="property" type="tProperty" />
<xsd:complexType name="tProperty">
  <xsd:complexContent>
    <xsd:extension base="tBaseElement">
      <xsd:attribute name="name" type="xsd:string"/>
      <xsd:attribute name="itemSubjectRef" type="xsd:QName"/>
    </xsd:extension>
  </xsd:complexContent>
</xsd:complexType>
```

10.5 Events

An **Event** is something that “happens” during the course of a **Process**. These **Events** affect the flow of the **Process** and usually have a cause or an impact and in general require or allow for a reaction. The term “event” is general enough to cover many things in a **Process**. The start of an **Activity**, the end of an **Activity**, the change of state of a document, a **Message** that arrives, etc., all could be considered **Events**.

Events allow for the description of “event-driven” **Processes**. In these **Processes**, there are three main types of **Events**:

1. **Start Events** (see page 237), which indicate where a **Process** will start.
2. **End Events** (see page 245), which indicate where a path of a **Process** will end.
3. **Intermediate Events** (see page 248), which indicate where something happens somewhere between the start and end of a **Process**.

Within these three types, **Events** come in two flavors:

1. **Events** that *catch a trigger*. All **Start Events** and some **Intermediate Events** are *catching Events*.
2. **Events** that *throw a Result*. All **End Events** and some **Intermediate Events** are *throwing Events* that MAY eventually be *caught* by another **Event**. Typically the *trigger* carries information out of the scope where the *throw Event* occurred into the scope of the catching **Events**. The *throwing* of a *trigger* MAY be either implicit as defined by this standard or an extension to it or explicit by a *throw Event*.

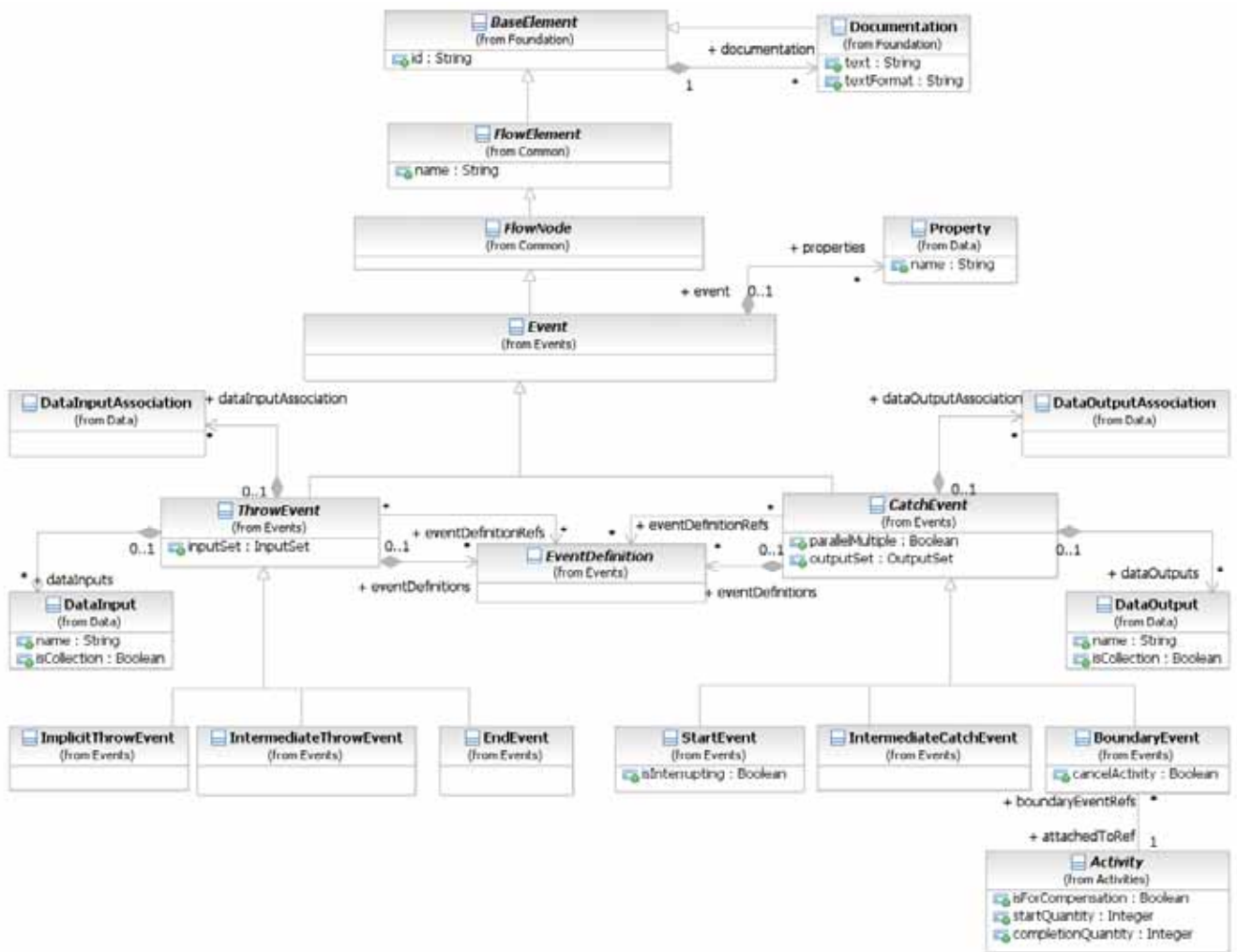

Figure 10.69 – The Event Class Diagram

10.5.1 Concepts

Depending on the type of the **Event** there are different strategies to forward the *trigger* to catching **Events**: publication, direct resolution, propagation, *cancellations*, and *compensations*.

With publication a *trigger* MAY be received by any catching **Events** in any scope of the system where the *trigger* is published. **Events** for which publication is used are grouped to **Conversations**. Published **Events** MAY participate in several **Conversations**. **Messages** are *triggers*, which are generated outside of the **Pool** they are published in. They typically describe B2B communication between different **Processes** in different **Pools**. When **Messages** need to reach a specific **Process** *instance*, *correlation* is used to identify the particular *instance*. **Signals** are *triggers* generated in the **Pool** they are published. They are typically used for broadcast communication within and across **Processes**, across **Pools**, and between **Process** diagrams.

Timer and **Conditional** *triggers* are implicitly thrown. When they are activated they wait for a time based or status based condition respectively to trigger the *catch* **Event**.

A *trigger* that is propagated is forwarded from the location where the **Event** has been thrown to the innermost enclosing scope *instance* (e.g., **Process** level) which has an attached **Event** being able to catch the *trigger*. **Error** *triggers* are critical and suspend execution at the location of throwing. **Escalations** are non critical and execution continues at the location of throwing. If no catching **Event** is found for an error or escalation *trigger*, this *trigger* is unresolved. Termination, *compensation*, and *cancellation* are directed towards a **Process** or a specific **Activity** *instance*. Termination indicates that all **Activities** in the **Process** or **Activity** should be immediately ended. This includes all *instances* of *multi-instances*. It is ended without *compensation* or *Event handling*.

Compensation of a successfully completed **Activity** triggers its *compensation handler*. The *compensation handler* is either user defined or implicit. The implicit *compensation handler* of a **Sub Process** calls all *compensation handlers* of its enclosed **Activities** in the reverse order of **Sequence Flow** dependencies. If *compensation* is invoked for an **Activity** that has not yet completed, or has not completed successfully, nothing happens (in particular, no error is raised).

Cancellation will terminate all running **Activities** and *compensate* all successfully completed **Activities** in the **Sub-Process** it is applied to. If the **Sub-Process** is a *Transaction*, the *Transaction* is rolled back.

Data Modeling and Events

Some **Events** (like the **Message**, **Escalation**, **Error**, **Signal**, and **Multiple Event**) have the capability to carry data. **Data Association** is used to push data from a *Catch Event* to a data element. For such **Events**, the following constraints apply:

- ◆ If the **Event** is associated with multiple *EventDefinitions*, there MUST be one **Data Input** (in the case of *throw Events*) or one **Data Output** (in the case of *catch Events*) for each *EventDefinition*. The order of the *EventDefinitions* and the order of the **Data Inputs/Outputs** determine which **Data Input/Output** corresponds with which *EventDefinition*.
- ◆ For each *EventDefinition* and **Data Input/Output** pair, if the **Data Input/Output** is present, it MUST have an *ItemDefinition* equivalent to the one defined by the **Message**, **Escalation**, **Error**, or **Signal** on the associated *EventDefinition*. In the case of a *throw Event*, if the **Data Input** is not present, the **Message**, **Escalation**, **Error**, or **Signal** will not be populated with data. In the case of a *catch Event*, if the **Data Output** is not present, the payload within the **Message**, **Escalation**, **Error**, or **Signal** will not flow out of the **Event** and into the **Process**.

The execution behavior is then as follows:

- ◆ For *throw Events*: When the **Event** is activated, the data in the **Data Input** is assigned automatically to the **Message**, **Escalation**, **Error**, or **Signal** referenced by the corresponding *EventDefinition*.
- ◆ For *catch Events*: When the *trigger* of the **Event** occurs (for example, the **Message** is received), the data is assigned automatically to the **Data Output** that corresponds to the *EventDefinition* that described that trigger.

Common Event attributes

The **Event** element inherits the attributes and model associations of `FlowElement` (see Table 8.44). Table 10.81 presents the additional model associations of the **Event** element.

Table 10.81 – Event model associations

Attribute Name	Description/Usage
properties: Property [0..*]	Modeler-defined <i>properties</i> MAY be added to an Event . These <i>properties</i> are contained within the Event .

Common Catch Event attributes

The `CatchEvent` element inherits the attributes and model associations of **Event** element (see Table 10.81). Table 10.82 presents the additional attributes and model associations of the `CatchEvent` element.

Table 10.82 – CatchEvent attributes and model associations

Attribute Name	Description/Usage
eventDefinitionRefs: EventDefinition [0..*]	<p>References the reusable <code>EventDefinitions</code> that are <i>triggers</i> expected for a <i>catch Event</i>. Reusable <code>EventDefinitions</code> are defined as top-level elements. These <code>EventDefinitions</code> can be shared by different <i>catch</i> and <i>throw Events</i>.</p> <ul style="list-style-type: none"> • If there is no <code>EventDefinition</code> defined, then this is considered a <i>catch None Event</i> and the Event will not have an internal marker (see Figure 10.91). • If there is more than one <code>EventDefinition</code> defined, this is considered a <i>Catch Multiple Event</i> and the Event will have the pentagon internal marker (see Figure 10.90). <p>This is an ordered set.</p>
eventDefinitions: EventDefinition [0..*]	<p>Defines the event <code>EventDefinitions</code> that are <i>triggers</i> expected for a <i>catch Event</i>. These <code>EventDefinitions</code> are only valid inside the current Event.</p> <ul style="list-style-type: none"> • If there is no <code>EventDefinition</code> defined, then this is considered a <i>catch None Event</i> and the Event will not have an internal marker (see Figure 10.91). • If there is more than one <code>EventDefinition</code> defined, this is considered a <i>catch Multiple Event</i> and the Event will have the pentagon internal marker (see Figure 10.90). <p>This is an ordered set.</p>

Table 10.82 – CatchEvent attributes and model associations

dataOutputAssociations: DataOutputAssociation [0..*]	The Data Associations of the <i>catch Event</i> . The dataOutputAssociation of a <i>catch Event</i> is used to assign data from the Event to a data element that is in the scope of the Event . For a <i>catch Multiple Event</i> , multiple Data Associations might be REQUIRED, depending on the individual <i>triggers</i> of the Event .
dataOutputs: DataOutput [0..*]	The Data Outputs for the <i>catch Event</i> . This is an ordered set.
outputSet: OutputSet [0..1]	The OutputSet for the <i>catch Event</i> .
parallelMultiple: boolean = false	This attribute is only relevant when the <i>catch Event</i> has more than EventDefinition (Multiple). If this value is true, then all of the types of triggers that are listed in the <i>catch Event</i> MUST be triggered before the Process is instantiated.

Common Throw Event Attributes

The ThrowEvent element inherits the attributes and model associations of **Event** element (see Table 10.81). Table 10.83 presents the additional attributes and model associations of the ThrowEvent element.

Table 10.83 – ThrowEvent attributes and model associations

Attribute Name	Description/Usage
eventDefinitionRefs: EventDefinition [0..*]	References the reusable EventDefinitions that are <i>results</i> expected for a <i>throw Event</i> . Reusable EventDefinitions are defined as top-level elements. These EventDefinitions can be shared by different <i>catch</i> and <i>throw Events</i> . <ul style="list-style-type: none"> • If there is no EventDefinition defined, then this is considered a <i>throw None Event</i> and the Event will not have an internal marker (see Figure 10.91). • If there is more than one EventDefinition defined, this is considered a <i>throw Multiple Event</i> and the Event will have the pentagon internal marker (see Figure 10.90). <p>This is an ordered set.</p>

Table 10.83 – ThrowEvent attributes and model associations

eventDefinitions: EventDefinition [0..*]	Defines the event EventDefinitions that are <i>results</i> expected for a <i>throw Event</i> . These EventDefinitions are only valid inside the current Event . <ul style="list-style-type: none"> • If there is no EventDefinition defined, this is considered a <i>throw None Event</i> and the Event will not have an Internal marker (see Figure 10.91). • If there is more than one EventDefinition defined, this is considered a <i>throw Multiple Event</i> and the Event will have the pentagon internal marker (see Figure 10.90). This is an ordered set.
dataInputAssociations: DataInput Association [0..*]	The Data Associations of the <i>throw Event</i> . The dataInputAssociation of a <i>throw Event</i> is responsible for the assignment of a data element that is in scope of the Event to the Event data. For a <i>throw Multiple Event</i> , multiple Data Associations might be REQUIRED, depending on the individual <i>results</i> of the Event .
dataInputs: DataInput [0..*]	The Data Inputs for the <i>throw Event</i> . This is an ordered set.
inputSet: InputSet [0..1]	The InputSet for the <i>throw Event</i> .

Implicit Throw Event

A sub-type of *throw Event* is the ImplicitThrowEvent. This is a non-graphical Event that is used for **Multi-Instance Activities** (see page 190). The ImplicitThrowEvent element inherits the attributes and model associations of ThrowEvent (see Table 10.84), but does not have any additional attributes or model associations.

10.5.2 Start Event

As the name implies, the **Start Event** indicates where a particular **Process** will start. In terms of **Sequence Flows**, the **Start Event** starts the flow of the **Process**, and thus, will not have any *incoming Sequence Flows*—no **Sequence Flow** can connect to a **Start Event**.

The **Start Event** shares the same basic shape of the **Intermediate Event** and **End Event**, a circle with an open center so that markers can be placed within the circle to indicate variations of the **Event**.

- ◆ A **Start Event** is a circle that MUST be drawn with a single thin line (see Figure 10.70).
- ◆ The use of text, color, size, and lines for a **Start Event** MUST follow the rules defined in “Use of Text, Color, Size, and Lines in a Diagram” on page 39 with the exception that:
 - ◆ The thickness of the line MUST remain thin so that the **Start Event** can be distinguished from the **Intermediate** and **End Events**.

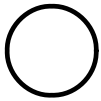

Figure 10.70 – Start Event

Throughout this document, we discuss how **Sequence Flows** are used within a **Process**. To facilitate this discussion, we employ the concept of a *token* that will traverse the **Sequence Flows** and pass through the elements in the **Process**. A *token* is a theoretical concept that is used as an aid to define the behavior of a **Process** that is being performed. The behavior of **Process** elements can be defined by describing how they interact with a *token* as it “traverses” the structure of the **Process**.

NOTE: A *token* does not traverse a **Message Flow** since it is a **Message** that is passed down a **Message Flow** (as the name implies).

Semantics of the **Start Event** include:

- ◆ A **Start Event** is OPTIONAL: a **Process** level—a top-level **Process**, a **Sub-Process** (embedded), or a Global **Process** (called **Process**)—MAY (is NOT REQUIRED to) have a **Start Event**.

NOTE: A **Process** MAY have more than one **Process** level (i.e., it can include Expanded **Sub-Processes** or **Call Activities** that call other **Processes**). The use of **Start** and **End Events** is independent for each level of the Diagram.

- ◆ If a **Process** is complex and/or the starting conditions are not obvious, then it is RECOMMENDED that a **Start Event** be used.
- ◆ If a **Start Event** is not used, then the implicit **Start Event** for the **Process** SHALL NOT have a *trigger*.
- ◆ If there is an **End Event**, then there MUST be at least one **Start Event**.
- ◆ All *Flow Objects* that do not have an *incoming Sequence Flow* (i.e., are not a target of a **Sequence Flow**) SHALL be instantiated when the **Process** is instantiated.
 - ◆ Exceptions to this are **Activities** that are defined as being **Compensation Activities** (it has the **Compensation** marker). **Compensation Activities** are not considered a part of the *normal flow* and MUST NOT be instantiated when the **Process** is instantiated. See page 301 for more information on **Compensation Activities**.
 - ◆ An exception to this is a catching **Link Intermediate Event**, which is not allowed to have *incoming Sequence Flows*. See page 266 for more information on **Link Intermediate Events**.
 - ◆ An exception to this is an **Event Sub-Process**, which is not allowed to have *incoming Sequence Flows* and will only be instantiated when its **Start Event** is triggered. See page 174 for more information on **Event Sub-Processes**.
- ◆ There MAY be multiple **Start Events** for a given **Process** level.
 - ◆ Each **Start Event** is an independent **Event**. That is, a **Process** *instance* SHALL be generated when the **Start Event** is triggered.

If the **Process** is used as a global **Process** (a callable **Process** that can be invoked from **Call Activities** of other **Processes**) and there are multiple **None Start Events**, then when flow is transferred from the parent **Process** to the global **Process**, only one of the global **Process**’s **Start Events** will be triggered. The `targetRef` attribute of a **Sequence Flow** *incoming* to the **Call Activity** object can be extended to identify the appropriate **Start Event**.

NOTE: The behavior of **Process** can be harder to understand if there are multiple **Start Events**. It is RECOMMENDED that this feature be used sparingly and that the modeler be aware that other readers of the Diagram could have difficulty understanding the intent of the Diagram.

When the *trigger* for a **Start Event** occurs, a new **Process** will be instantiated and a *token* will be generated for each *outgoing Sequence Flow* from that **Event**.

Start Event Triggers

Start Events can be used for these types of **Processes**:

- *Top-level Processes*
- **Sub-Processes** (*embedded*)
- Global **Process** (*called*)
- **Event Sub-Processes**

The next three sub clauses describe the types of **Start Events** that can be used for each of these three types of **Processes**.

Start Events for Top-level Processes

There are many ways that *top-level Processes* can be started (instantiated). The *trigger* for a **Start Event** is designed to show the general mechanisms that will instantiate that particular **Process**. There are seven (7) types of **Start Events** for *top-level Processes* in **BPMN** (see Table 10.84): *None*, **Message**, **Timer**, **Conditional**, **Signal**, **Multiple**, and **Parallel**.

A top-level **Process** that has at least one **None Start Event** MAY be called by a **Call Activity** in another **Process**. The **None Start Event** is used for invoking the **Process** from the **Call Activity**. All other types of **Start Events** are only applicable when the **Process** is used as a top-level **Process**.

Table 10.84 – Top-Level Process Start Event Types







Trigger	Description	Marker
None	The None Start Event does not have a defined <i>trigger</i> . There is no specific <code>EventDefinition</code> subclass (see page 259) for None Start Events . If the Start Event has no associated <code>EventDefinition</code> , then the Event MUST be displayed without a marker (see the figure on the right).	
Message	A Message arrives from a <i>Participant</i> and triggers the start of the Process . See page 91 for more details on Messages . If there is only one <code>EventDefinition</code> associated with the Start Event and that <code>EventDefinition</code> is of the subclass <code>MessageEventDefinition</code> , then the Event is a Message Start Event and MUST be displayed with an envelope marker (see the figure to the right). The actual <i>Participant</i> from which the Message is received can be identified by connecting the Event to a <i>Participant</i> using a Message Flow within the definitional Collaboration of the Process – see Table 10.1.	

Table 10.84 – Top-Level Process Start Event Types

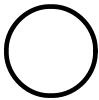
<p>Timer</p>	<p>A specific time-date or a specific cycle (e.g., every Monday at 9am) can be set that will trigger the start of the Process. If there is only one EventDefinition associated with the Start Event and that EventDefinition is of the subclass TimerEventDefinition, then the Event is a Timer Start Event and MUST be displayed with a clock marker (see the figure to the right).</p>	
<p>Conditional</p>	<p>This type of event is triggered when a condition such as “S&P 500 changes by more than 10% since opening,” or “Temperature above 300C” become <i>true</i>. The condition Expression for the Event MUST become <i>false</i> and then <i>true</i> before the Event can be triggered again. The Condition Expression of a Conditional Start Event MUST NOT refer to the data context or instance attribute of the Process (as the Process instance has not yet been created). Instead, it MAY refer to static Process attributes and states of entities in the environment. The specification of mechanisms to access such states is out of scope of the standard. If there is only one EventDefinition associated with the Start Event and that EventDefinition is of the subclass ConditionalEventDefinition, then the Event is a Conditional Start Event and MUST be displayed with a lined paper marker (see the figure to the right).</p>	
<p>Signal</p>	<p>A Signal arrives that has been broadcast from another Process and triggers the start of the Process. Note that the Signal is not a Message, which has a specific target for the Message. Multiple Processes can have Start Events that are triggered from the same broadcasted Signal. If there is only one EventDefinition associated with the Start Event and that EventDefinition is of the subclass SignalEventDefinition, then the Event is a Signal Start Event and MUST be displayed with a triangle marker (see the figure to the right).</p>	
<p>Multiple</p>	<p>This means that there are multiple ways of triggering the Process. Only one of them is REQUIRED. There is no specific EventDefinition subclass for Multiple Start Events. If the Start Event has more than one associated EventDefinition, then the Event MUST be displayed with the Multiple Event marker (a pentagon—see the upper figure to the right).</p>	
<p>Parallel Multiple</p>	<p>This means that there are multiple <i>triggers</i> REQUIRED before the Process can be instantiated. All of the types of <i>triggers</i> that are listed in the Start Event MUST be triggered before the Process is instantiated. There is no specific EventDefinition subclass for Parallel Multiple Start Events. If the Start Event has more than one associated EventDefinition <u>and</u> the parallelMultiple attribute of the Start Event is <i>true</i>, then the Event MUST be displayed with the Parallel Multiple Event marker (an open plus sign—see the figure to the right).</p>	

Start Events for Sub-Processes

There is only one type of **Start Event** for **Sub-Processes** in **BPMN** (see Figure 10.82): None.

Table 10.85 – Sub-Process Start Event Types

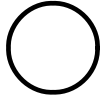
Trigger	Description	Marker
None	The None Start Event is used for all Sub-Processes , either embedded or called (reusable). Other types of <i>triggers</i> are not used for a Sub-Process , since the flow of the Process (a <i>token</i>) from the <i>parent Process</i> is the <i>trigger</i> of the Sub-Process . If the Sub-Process is called (reusable) and has multiple Start Events , some of the other Start Events MAY have <i>triggers</i> , but these Start Events would not be used in the context of a Sub-Process . When the other Start Events are triggered, they would instantiate top-level Processes .	

Start Events for Event Sub-Processes

A **Start Event** can also initiate an inline **Event Sub-Process** (see page 174). In that case, the same **Event** types as for boundary **Events** are allowed (see Table 10.86), namely: **Message**, **Timer**, **Escalation**, **Error**, **Compensation**, **Conditional**, **Signal**, **Multiple**, and **Parallel**.

- ◆ An **Event Sub-Process** MUST have a single **Start Event**.

Table 10.86 – Event Sub-Process Start Event Types



Trigger	Description	Marker
Message	<p>If there is only one <code>EventDefinition</code> associated with the Start Event and that <code>EventDefinition</code> is of the subclass <code>MessageEventDefinition</code>, then the Event is a Message Start Event and uses an envelope marker (see the figures to the right).</p> <ul style="list-style-type: none"> • For a Message Event Sub-Process that interrupts its containing Process, the boundary of the Event is solid (see the upper figure to the right). • For a Message Event Sub-Process that does not interrupt its containing Process, the boundary of the Event is dashed (see the lower figure on the right). <p>The actual <i>Participant</i> from which the Message is received can be identified by connecting the Event to a <i>Participant</i> using a Message Flow within the <i>definitional Collaboration</i> of the Process – see Table 10.1.</p>	<p><i>Interrupting</i></p>  <p><i>Non-Interrupting</i></p> 

Table 10.86 – Event Sub-Process Start Event Types







<p>Timer</p>	<p>If there is only one <code>EventDefinition</code> associated with the Start Event and that <code>EventDefinition</code> is of the subclass <code>TimerEventDefinition</code>, then the Event is a Timer Start Event and uses a clock marker (see the figures to the right).</p> <ul style="list-style-type: none"> • For a Timer Event Sub-Process that interrupts its containing Process, the boundary of the Event is solid (see the upper figure to the right). • For a Timer Event Sub-Process that does not interrupt its containing Process, the boundary of the Event is dashed (see the lower figure on the right). 	<p><i>Interrupting</i></p>  <p><i>Non-Interrupting</i></p> 
<p>Escalation</p>	<p>Escalation Event Sub-Processes implement measures to expedite the completion of a business Activity, should it not satisfy a constraint specified on its execution (such as a time-based deadline). The Escalation Start Event is only allowed for triggering an in-line Event Sub-Process.</p> <p>If there is only one <code>EventDefinition</code> associated with the Start Event and that <code>EventDefinition</code> is of the subclass <code>EscalationEventDefinition</code>, then the Event is an Escalation Start Event and uses an arrowhead marker (see the figures to the right).</p> <p>For an Escalation Event Sub-Process that interrupts its containing Process, the boundary of the Event is solid (see the upper figure to the right).</p> <p>For an Escalation Event Sub-Process that does not interrupt its containing Process, the boundary of the Event is dashed (see the lower figure on the right).</p>	<p><i>Interrupting</i></p>  <p><i>Non-Interrupting</i></p> 
<p>Error</p>	<p>The Error Start Event is only allowed for triggering an in-line Event Sub-Process.</p> <p>If there is only one <code>EventDefinition</code> associated with the Start Event and that <code>EventDefinition</code> is of the subclass <code>ErrorEventDefinition</code>, then the Event is an Error Start Event and uses a lightning marker (see the figures to the right).</p> <p>Given the nature of Errors, an Event Sub-Process with an Error <i>trigger</i> will always interrupt its containing Process.</p>	<p><i>Interrupting</i></p> 
<p>Compensation</p>	<p>The Compensation Start Event is only allowed for triggering an in-line Compensation Event Sub-Process (see “Compensation Handler” on page 302). This type of Event is triggered when <i>compensation</i> occurs.</p> <p>If there is only one <code>EventDefinition</code> associated with the Start Event and that <code>EventDefinition</code> is of the subclass <code>CompensationEventDefinition</code>, then the Event is a Compensation Start Event and uses a double triangle marker (see the figure to the right). This Event does not interrupt the Process since the Process has to be completed before this Event can be triggered.</p>	

Table 10.86 – Event Sub-Process Start Event Types









<p>Conditional</p>	<p>If there is only one <code>EventDefinition</code> associated with the Start Event and that <code>EventDefinition</code> is of the subclass <code>ConditionalEventDefinition</code>, then the Event is a Conditional Start Event and uses an lined page marker (see the figures to the right). For a Conditional Event Sub-Process that interrupts its containing Process, then the boundary of the Event is solid (see the upper figure to the right). For a Conditional Event Sub-Process that does not interrupt its containing Process, the boundary of the Event is dashed (see the lower figure on the right).</p>	<p><i>Interrupting</i></p>  <p><i>Non-Interrupting</i></p> 
<p>Signal</p>	<p>If there is only one <code>EventDefinition</code> associated with the Start Event and that <code>EventDefinition</code> is of the subclass <code>SignalEventDefinition</code>, then the Event is a Signal Start Event and uses an triangle marker (see the figures to the right). For a Signal Event Sub-Process that interrupts its containing Process, then the boundary of the Event is solid (see the upper figure to the right). For a Signal Event Sub-Process that does not interrupt its containing Process, the boundary of the Event is dashed (see the lower figure on the right).</p>	<p><i>Interrupting</i></p>  <p><i>Non-Interrupting</i></p> 
<p>Multiple</p>	<p>A Multiple Event indicates that there are multiple ways of triggering the Event Sub-Process. Only one of them is REQUIRED to actually start the Event Sub-Process. There is no specific <code>EventDefinition</code> subclass (see page 259) for Multiple Start Events. If the Start Event has more than one associated <code>EventDefinition</code>, then the Event MUST be displayed with the Multiple Event marker (a pentagon—see the figures on the right). For a Multiple Event Sub-Process that interrupts its containing Process, the boundary of the Event is solid (see the upper figure to the right). For a Multiple Event Sub-Process that does not interrupt its containing Process, the boundary of the Event is dashed (see the lower figure on the right).</p>	<p><i>Interrupting</i></p>  <p><i>Non-Interrupting</i></p> 

Table 10.86 – Event Sub-Process Start Event Types

<p>Parallel Multiple</p>	<p>A Parallel Multiple Event indicates that there are multiple ways of triggering the Event Sub-Process. All of them are REQUIRED to actually start the Event Sub-Process. There is no specific <code>EventDefinition</code> subclass (see page 259) for Parallel Multiple Start Events. If the Start Event has more than one associated <code>EventDefinition</code> and the <code>parallelMultiple</code> attribute of the Start Event is <i>true</i>, then the Event MUST be displayed with the Parallel Multiple Event marker (an open plus sign—see the figures to the right). For a Parallel Multiple Event Sub-Process that interrupts its containing Process, the boundary of the Event is solid (see the upper figure to the right). For a Parallel Multiple Event Sub-Process that does not interrupt its containing Process, the boundary of the Event is dashed (see the lower figure on the right).</p>	<p><i>Interrupting</i></p>  <p><i>Non-Interrupting</i></p> 
--------------------------	---	---

Attributes for Start Events

For **Start Events**, the following additional attribute exists:

- The **Start Event** element inherits the attributes and model associations of `CatchEvent` (see Table 10.82). Table 10.87 presents the additional attributes of the **Start Event** element:

Table 10.87 – Start Event attributes

Attribute Name	Description/Usage
<p>isInterrupting: boolean = true</p>	<p>This attribute only applies to Start Events of Event Sub-Processes; it is ignored for other Start Events. This attribute denotes whether the Sub-Process encompassing the Event Sub-Process should be canceled or not. If the encompassing Sub-Process is not canceled, multiple <i>instances</i> of the Event Sub-Process can run concurrently. This attribute cannot be applied to Error Events (where it's always <i>true</i>), or Compensation Events (where it doesn't apply).</p>

Sequence Flow Connections

See “Sequence Flow Connections Rules” on page 40 for the entire set of objects and how they *MAY* be a *source* or *target* of a **Sequence Flow**.

- ◆ A **Start Event** **MUST NOT** be a target for **Sequence Flows**; it **MUST NOT** have *incoming* **Sequence Flows**.
 - ◆ An exception to this is when a **Start Event** is used in an Expanded **Sub-Process** and is attached to the boundary of that **Sub-Process**. In this case, a **Sequence Flow** from the higher-level **Process** *MAY* connect to that **Start Event** in lieu of connecting to the actual boundary of the **Sub-Process**.
- ◆ A **Start Event** **MUST** be a source for a **Sequence Flow**.
- ◆ Multiple **Sequence Flows** *MAY* originate from a **Start Event**. For each **Sequence Flow** that has the **Start Event** as a source, a new parallel path **SHALL** be generated.
 - ◆ The `conditionExpression` attribute for all *outgoing* **Sequence Flows** **MUST** be set to `None`.

- ◆ When a **Start Event** is not used, then all Flow Objects that do not have an *incoming* **Sequence Flow** SHALL be the start of a separate parallel path.
- ◆ Each path will have a separate unique *token* that will traverse the **Sequence Flow**.

Message Flow Connections

NOTE: All **Message Flows** MUST connect two separate **Pools**. They MAY connect to the **Pool** boundary or to *Flow Objects* within the **Pool** boundary. They MUST NOT connect two objects within the same **Pool**.

See “Message Flow Connection Rules” on page 41 for the entire set of objects and how they MAY be a source or targets of a **Message Flow**.

- ◆ A **Start Event** MAY be the target for a **Message Flow**; it can have zero (0) or more *incoming* **Message Flows**. Each **Message Flow** targeting a **Start Event** represents an instantiation mechanism (a *trigger*) for the **Process**. Only one of the *triggers* is REQUIRED to start a new **Process**.
- ◆ A **Start Event** MUST NOT be a source for a **Message Flow**; it MUST NOT have *outgoing* **Message Flows**.

10.5.3 End Event

As the name implies, the **End Event** indicates where a **Process** will end. In terms of **Sequence Flows**, the **End Event** ends the flow of the **Process**, and thus, will not have any *outgoing* **Sequence Flows**—no **Sequence Flow** can connect from an **End Event**.

The **End Event** shares the same basic shape of the **Start Event** and **Intermediate Event**, a circle with an open center so that markers can be placed within the circle to indicate variations of the **Event**.

- ◆ An **End Event** is a circle that MUST be drawn with a single thick line (see Figure 10.71).
- ◆ The use of text, color, size, and lines for an **End Event** MUST follow the rules defined in “Use of Text, Color, Size, and Lines in a Diagram” on page 39 with the exception that:
 - ◆ The thickness of the line MUST remain thick so that the **End Event** can be distinguished from the **Intermediate** and **Start Events**.



Figure 10.71 – End Event

To continue discussing how flow proceeds throughout the **Process**, an **End Event** consumes a *token* that had been generated from a **Start Event** within the same level of **Process**. If parallel **Sequence Flows** targets the **End Event**, then the *tokens* will be consumed as they arrive. All the *tokens* that were generated within the **Process** MUST be consumed by an **End Event** before the **Process** has been completed. In other circumstances, if the **Process** is a **Sub-Process**, it can be stopped prior to normal completion through interrupting **Intermediate Events** (See 10.2.2, “exception flow,” on page 274 for more details). In this situation the *tokens* will be consumed by an **Intermediate Event** attached to the boundary of the **Sub-Process**.

Semantics of the **End Event** include:

- ◆ There MAY be multiple **End Events** within a single level of a **Process**.

- ◆ An **End Event** is OPTIONAL: a given **Process** level—a **Process** or an expanded **Sub-Process**—MAY (is NOT REQUIRED to) have this shape:
 - ◆ If an **End Event** is not used, then the implicit **End Event** for the **Process** SHALL NOT have a Result.
 - ◆ If there is a **Start Event**, then there MUST be at least one **End Event**.
 - ◆ If the **End Event** is not used, then all *Flow Objects* that do not have any *outgoing Sequence Flow* (i.e., are not a source of a **Sequence Flow**) mark the end of a path in the **Process**. However, the **Process** MUST NOT end until all parallel paths have completed.

NOTE: A **Process** MAY have more than one **Process** level (i.e., it can include *Expanded Sub-Processes* or a **Call Activity** that call other **Processes**). The use of **Start** and **End Events** is independent for each level of the Diagram.

For **Processes** without an **End Event**, a *token* entering a path-ending Flow Object will be consumed when the processing performed by the object is completed (i.e., when the path has completed), as if the *token* had then gone on to reach an **End Event**. When all *tokens* for a given *instance* of the **Process** are consumed, then the **Process** will reach a state of being completed.

End Event Results

There are nine types of **End Events** in **BPMN**: *None*, **Message**, **Escalation**, **Error**, **Cancel**, **Compensation**, **Signal**, **Terminate**, and **Multiple**. These types define the consequence of reaching an **End Event**. This will be referred to as the **End Event Result**.

Table 10.88 – End Event Types



Trigger	Description	Marker
None	The None End Event does not have a defined <i>result</i> . There is no specific <i>EventDefinition</i> subclass (see page 259) for None End Events . If the End Event has no associated <i>EventDefinition</i> , then the Event will be displayed without a marker (see the figure on the right).	
Message	This type of End indicates that a Message is sent to a <i>Participant</i> at the conclusion of the Process . See page 91 for more details on Messages . The actual <i>Participant</i> from which the Message is received can be identified by connecting the Event to a <i>Participant</i> using a Message Flow within the definitional Collaboration of the Process – see Table 10.1.	
Error	This type of End indicates that a named Error should be generated. All currently active threads in the particular Sub-Process are terminated as a result. The Error will be caught by a <i>Catch Error Intermediate Event</i> with the same <i>errorCode</i> or no <i>errorCode</i> which is on the boundary of the nearest enclosing parent Activity (hierarchically). The behavior of the Process is unspecified if no Activity in the hierarchy has such an Error Intermediate Event . The system executing the process can define additional <i>Error</i> handling in this case, a common one being termination of the Process instance .	

Table 10.88 – End Event Types







Escalation	<p>This type of End indicates that an <i>Escalation</i> should be triggered. Other active threads are not affected by this and continue to be executed. The <i>Escalation</i> will be caught by a Catch Escalation Intermediate Event with the same <code>escalationCode</code> or no <code>escalationCode</code> which is on the boundary of the nearest enclosing parent Activity (hierarchically). The behavior of the Process is unspecified if no Activity in the hierarchy has such an Escalation Intermediate Event.</p>	
Cancel	<p>This type of End is used within a Transaction Sub-Process. It will indicate that the Transaction should be canceled and will trigger a Cancel Intermediate Event attached to the Sub-Process boundary. In addition, it will indicate that a <code>TransactionProtocol Cancel Message</code> should be sent to any Entities involved in the Transaction.</p>	
Compensation	<p>This type of End indicates that compensation is necessary. If an Activity is identified, and it was successfully completed, then that Activity will be compensated. The Activity MUST be visible from the Compensation End Event, i.e., one of the following MUST be true:</p> <ul style="list-style-type: none"> • The Compensation End Event is contained in <i>normal flow</i> at the same level of Sub-Process. • The Compensation End Event is contained in a Compensation Event Sub-Process that is contained in the Sub-Process containing the Activity. • If no Activity is identified, all successfully completed Activities visible from the Compensation End Event are compensated, in reverse order of their Sequence Flows. Visible means one of the following: <ul style="list-style-type: none"> • The Compensation End Event is contained in <i>normal flow</i> and at the same level of Sub-Process as the Activities. • The Compensation End Event is contained in a Compensation Event Sub-Process that is contained in the Sub-Process containing the Activities. <p>To be compensated, an Activity MUST have a boundary Compensation Event or contain a Compensation Event Sub-Process.</p>	
Signal	<p>This type of End indicates that a Signal will be broadcasted when the End has been reached. Note that the Signal, which is broadcast to any Process that can receive the Signal, can be sent across Process levels or Pools, but is not a Message (that has a specific <i>source</i> and <i>target</i>). The attributes of a Signal can be found on page 272.</p>	
Terminate	<p>This type of End indicates that all Activities in the Process should be immediately ended. This includes all <i>instances</i> of <i>multi-instances</i>. The Process is ended without <i>compensation</i> or <i>event handling</i>.</p>	

Table 10.88 – End Event Types

Multiple	This means that there are multiple consequences of ending the Process . All of them will occur (e.g., there might be multiple Messages sent). There is no specific EventDefinition subclass (see page 259) for Multiple End Events . If the End Event has more than one associated EventDefinition , then the Event will be displayed with the Multiple Event marker (a pentagon—see the figure on the right).	
----------	--	---

Sequence Flow Connections

See “Sequence Flow Connections Rules” on page 40 for the entire set of objects and how they **MAY** be a *source* or *target* of a **Sequence Flow**.

- ◆ An **End Event** **MUST** be a target for a **Sequence Flow**.
- ◆ An **End Event** **MAY** have multiple *incoming* **Sequence Flows**.

The Flow **MAY** come from either alternative or parallel paths. For modeling convenience, each path **MAY** connect to a separate **End Event** object. The **End Event** is used as a Sink for all *tokens* that arrive at the **Event**. All *tokens* that are generated at the **Start Event** for that **Process** **MUST** eventually arrive at an **End Event**. The **Process** will be in a running state until all *tokens* are consumed.

- ◆ An **End Event** **MUST NOT** be a source for **Sequence Flows**; that is, there **MUST NOT** be *outgoing* **Sequence Flows**.
- ◆ An exception to this is when an **End Event** is used in an Expanded **Sub-Process** and is attached to the boundary of that **Sub-Process**. In this case, a **Sequence Flow** from the higher-level **Process** **MAY** connect from that **End Event** in lieu of connecting from the actual boundary of the **Sub-Process**.

Message Flow Connections

See “Message Flow Connection Rules” on page 41 for the entire set of objects and how they **MAY** be a *source* or *target* of a **Message Flow**.

NOTE: All **Message Flows** **MUST** connect two separate **Pools**. They **MAY** connect to the **Pool** boundary or to *Flow Objects* within the **Pool** boundary. They **MUST NOT** connect two objects within the same **Pool**.

- ◆ An **End Event** **MUST NOT** be the target of a **Message Flow**; it can have no *incoming* **Message Flows**.
- ◆ An **End Event** **MAY** be the source of a **Message Flow**; it can have zero (0) or more *outgoing* **Message Flows**. Each **Message Flow** leaving the **End Event** will have a **Message** sent when the **Event** is triggered.
- ◆ The Result attribute of the **End Event** **MUST** be set to `Message` or `Multiple` if there are any *outgoing* **Message Flows**.
- ◆ The Result attribute of the **End Event** **MUST** be set to `Multiple` if there is more than one *outgoing* **Message Flows**.

10.5.4 Intermediate Event

As the name implies, the **Intermediate Event** indicates where something happens (an **Event**) somewhere between the start and end of a **Process**. It will affect the flow of the **Process**, but will not start or (directly) terminate the **Process**. **Intermediate Events** can be used to:

- Show where **Messages** are expected or sent within the **Process**,
- Show delays are expected within the **Process**,
- Disrupt the *normal flow* through *exception handling*, or
- Show the extra work needed for *compensation*.

The **Intermediate Event** shares the same basic shape of the **Start Event** and **End Event**, a circle with an open center so that markers can be placed within the circle to indicate variations of the **Event**.

- ◆ An **Intermediate Event** is a circle that **MUST** be drawn with a double thin line (see Figure 10.72).
- ◆ The use of text, color, size, and lines for an **Intermediate Event** **MUST** follow the rules defined in “Use of Text, Color, Size, and Lines in a Diagram” on page 39 with the exception that the thickness of the line **MUST** remain double so that the **Intermediate Event** can be distinguished from the **Start** and **End Events**.



Figure 10.72 – Intermediate Event

One use of **Intermediate Events** is to represent exception or *compensation handling*. This will be shown by placing the **Intermediate Event** on the boundary of a **Task** or **Sub-Process** (either collapsed or expanded). The **Intermediate Event** can be attached to any location of the **Activity** boundary and the *outgoing Sequence Flows* can flow in any direction. However, in the interest of clarity of the Diagram, we **RECOMMEND** that the modeler choose a consistent location on the boundary. For example, if the Diagram orientation is horizontal, then the **Intermediate Events** can be attached to the bottom of the **Activity** and the **Sequence Flows** directed down, then to the right. If the Diagram orientation is vertical, then the **Intermediate Events** can be attached to the left or right side of the **Activity** and the **Sequence Flows** directed to the left or right, then down.

Intermediate Event Triggers

There are twelve types of **Intermediate Events** in **BPMN**: *None*, **Message**, **Timer**, **Escalation**, **Error**, **Cancel**, **Compensation**, **Conditional**, **Link**, **Signal**, **Multiple**, and **Parallel Multiple**. Each type of **Intermediate Event** will have a different icon placed in the center of the **Intermediate Event** shape to distinguish one from another.

There are two ways that **Intermediate Events** are used in **BPMN**:

1. An **Intermediate Event** that is placed within the *normal flow* of a **Process** can be used for one of two purposes. The **Event** can respond to (“catch”) the **Event trigger** or the **Event** can be used to set off (“throw”) the **Event trigger**.
2. An **Intermediate Event** that is attached to the boundary of an **Activity** can only be used to “catch” the **Event trigger**.





Intermediate Events in Normal Flow



When a *token* arrives at an **Intermediate Event** that is placed within the *normal flow* of a **Process**, one of two things will happen.







- If the **Event** is used to “throw” the **Event trigger**, then *trigger* of the **Event** will immediately occur (e.g., the **Message** will be sent) and the *token* will move down the *outgoing Sequence Flow*.
- If the **Event** is used to “catch” the **Event trigger**, then the *token* will remain at the **Event** until the *trigger* occurs (e.g., the **Message** is received). Then the *token* will move down the *outgoing Sequence Flow*.

Ten of the twelve **Intermediate Events** can be used in *normal flow* as shown in Table 10.89.

Table 10.89 – Intermediate Event Types in Normal Flow

Trigger	Description	Marker
None	<p>The None Intermediate Event is only valid in <i>normal flow</i>, i.e., it MAY NOT be used on the boundary of an Activity. Although there is no specific <i>trigger</i> for this Event, it is defined as <i>throw Event</i>. It is used for modeling methodologies that use Events to indicate some change of state in the Process.</p> <p>There is no specific <i>EventDefinition</i> subclass (see page 259) for None Intermediate Events. If the (throw) Intermediate Event has no associated <i>EventDefinition</i>, then the Event MUST be displayed without a marker (see the figure on the right).</p>	<p>Throw</p> 
Message	<p>A Message Intermediate Event can be used to either send a Message or receive a Message.</p> <p>When used to “throw” the Message, the Event marker MUST be filled (see the upper figure on the right). When used to “catch” the Message, then the Event marker MUST be unfilled (see the lower figure on the right). This causes the Process to continue if it was waiting for the Message, or changes the flow for <i>exception handling</i>.</p> <p>The actual <i>Participant</i> from which the Message is received can be identified by connecting the Event to a <i>Participant</i> using a Message Flow within the <i>definitional Collaboration</i> of the Process – see Table 10.1. See page 91 for more details on Messages.</p>	<p>Throw</p>  <p>Catch</p> 
Timer	<p>In <i>normal flow</i> the Timer Intermediate Event acts as a delay mechanism based on a specific time-date or a specific cycle (e.g., every Monday at 9am) can be set that will trigger the Event. This Event MUST be displayed with a clock marker (see the figure on the right).</p>	<p>Catch</p> 

Trigger	Description	Marker
Escalation	<p>In <i>normal flow</i>, the Escalation Intermediate Event raises an Escalation. Since this is a Throw Event, the arrowhead marker will be filled (see the figure to the right).</p>	<p>Throw</p> 
Compensation	<p>In <i>normal flow</i>, this Intermediate Event indicates that <i>compensation</i> is necessary. Thus, it is used to "throw" the Compensation Event, and the Event marker MUST be filled (see figure on the right). If an Activity is identified, and it was successfully completed, then that Activity will be compensated. The Activity MUST be visible from the Compensation Intermediate Event, i.e., one of the following MUST be true:</p> <ul style="list-style-type: none"> • The Compensation Intermediate Event is contained in <i>normal flow</i> at the same level of Sub-Process. • The Compensation Intermediate Event is contained in a Compensation Event Sub-Process which is contained in the Sub-Process containing the Activity. <p>If no Activity is identified, all successfully completed Activities visible from the Compensation Intermediate Event are compensated, in reverse order of their Sequence Flows. Visible means one of the following:</p> <ul style="list-style-type: none"> • The Compensation Intermediate Event is contained in <i>normal flow</i> and at the same level of Sub-Process as the Activities. • The Compensation Intermediate Event is contained in a Compensation Event Sub-Process which is contained in the Sub-Process containing the Activities. <p>To be compensated, an Activity MUST have a <i>boundary Compensation Event</i>, or contain a Compensation Event Sub-Process.</p>	<p>Throw</p> 
Conditional	<p>This type of Event is triggered when a condition becomes <i>true</i>. A condition is a type of <i>Expression</i>. The attributes of an <i>Expression</i> can be found on page 82.</p>	<p>Catch</p> 

Link	<p>The Link Intermediate Events are only valid in <i>normal flow</i>, i.e., they MAY NOT be used on the boundary of an Activity. A Link is a mechanism for connecting two sections of a Process. Link Events can be used to create looping situations or to avoid long Sequence Flow lines. Link Event uses are limited to a single Process level (i.e., they cannot link a <i>parent Process</i> with a Sub-Process). Paired Intermediate Events can also be used as “Off-Page Connectors” for printing a Process across multiple pages. They can also be used as generic “Go To” objects within the Process level. There can be multiple source Link Events, but there can only be one <i>target Link Event</i>. When used to “throw” to the <i>target Link</i>, the Event marker will be filled (see the top figure on the right). When used to “catch” from the <i>source Link</i>, the Event marker will be unfilled (see the bottom figure on the right).</p>	<p>Throw</p>  <p>Catch</p> 
Signal	<p>This type of Event is used for sending or receiving Signals. A Signal is for general communication within and across Process levels, across Pools, and between Business Process Diagrams. A BPMN Signal is similar to a signal flare that shot into the sky for anyone who might be interested to notice and then react. Thus, there is a source of the Signal, but no specific intended target. This type of Intermediate Event can send or receive a Signal if the Event is part of a <i>normal flow</i>. The Event can only receive a Signal when attached to the boundary of an Activity. The Signal Event differs from an Error Event in that the Signal defines a more general, non-error condition for interrupting Activities (such as the successful completion of another Activity) as well as having a larger scope than Error Events. When used to “catch” the Signal, the Event marker will be unfilled (see the middle figure on the right). When used to “throw” the Signal, the Event marker will be filled (see the top figure on the right). The attributes of a Signal can be found on page 272.</p>	<p>Throw</p>  <p>Catch</p> 
Multiple	<p>This means that there are multiple <i>triggers</i> assigned to the Event. If used within <i>normal flow</i>, the Event can “catch” the <i>trigger</i> or “throw” the <i>triggers</i>. When attached to the boundary of an Activity, the Event can only “catch” the <i>trigger</i>. When used to “catch” the <i>trigger</i>, only one of the assigned <i>triggers</i> is REQUIRED and the Event marker will be unfilled (see the middle figure on the right). When used to “throw” the <i>trigger</i> (the same as a Multiple End Event), all the assigned <i>triggers</i> will be thrown and the Event marker will be filled (see the top figure on the right). There is no specific EventDefinition subclass (see page 259) for Multiple Intermediate Events. If the Intermediate Event has more than one associated EventDefinition, then the Event will be displayed with the Multiple Event marker.</p>	<p>Throw</p>  <p>Catch</p> 

Parallel Multiple	<p>This means that there are multiple <i>triggers</i> assigned to the Event. If used within <i>normal flow</i>, the Event can only “catch” the <i>trigger</i>. When attached to the boundary of an Activity, the Event can only “catch” the <i>trigger</i>. Unlike the normal Multiple Intermediate Event, all of the assigned <i>triggers</i> are REQUIRED for the Event to be triggered. The Event marker will be an unfilled plus sign (see the figure on the right). There is no specific <code>EventDefinition</code> subclass (see page 259) for Parallel Multiple Intermediate Events. If the Intermediate Event has more than one associated <code>EventDefinition</code> and the <code>parallelMultiple</code> attribute of the Intermediate Event is <i>true</i>, then the Event will be displayed with the Parallel Multiple Event marker.</p>	<p>Catch</p> 
-------------------	---	---

Intermediate Events Attached to an Activity Boundary

Table 10.90 describes the **Intermediate Events** that can be attached to the boundary of an **Activity**.

Table 10.90 – Intermediate Event Types Attached to an Activity Boundary





Trigger	Description	Marker
Message	<p>A Message arrives from a participant and triggers the Event. If a Message Event is attached to the boundary of an Activity, it will change the <i>normal flow</i> into an <i>exception flow</i> upon being triggered. For a Message Event that interrupts the Activity to which it is attached, the boundary of the Event is solid (see upper figure on the right). Note that if using this notation, the attribute <code>cancelActivity</code> of the Activity to which the Event is attached is implicitly set to <i>true</i>. For a Message Event that does not interrupt the Activity to which it is attached, the boundary of the Event is dashed (see lower figure on the right). Note that if using this notation, the attribute <code>cancelActivity</code> of the Activity to which the Event is attached is implicitly set to <i>false</i>. The actual <i>Participant</i> from which the Message is received can be identified by connecting the Event to a <i>Participant</i> using a Message Flow within the definitional Collaboration of the Process – see Table 10.1.</p>	<p>Interrupting</p>  <p>Non-Interrupting</p> 
Timer	<p>A specific time-date or a specific cycle (e.g., every Monday at 9am) can be set that will trigger the Event. If a Timer Event is attached to the boundary of an Activity, it will change the <i>normal flow</i> into an <i>exception flow</i> upon being triggered. For a Timer Event that interrupts the Activity to which it is attached, the boundary of the Event is solid (see upper figure on the right). Note that if using this notation, the attribute <code>cancelActivity</code> of the Activity to which the Event is attached is implicitly set to <i>true</i>. For a Timer Event that does not interrupt the Activity to which it is attached, the boundary of the Event is dashed (see lower figure on the right). Note that if using this notation, the attribute <code>cancelActivity</code> of the Activity to which the Event is attached is implicitly set to <i>false</i>.</p>	<p>Interrupting</p>  <p>Non-Interrupting</p> 

Table 10.90 – Intermediate Event Types Attached to an Activity Boundary





<p>Escalation</p>	<p>This type of Event is used for handling a named <i>Escalation</i>. If attached to the boundary of an Activity, the Intermediate Event catches an <i>Escalation</i>. In contrast to an <i>Error</i>, an <i>Escalation</i> by default is assumed to not abort the Activity to which the <i>boundary Event</i> is attached. However, a modeler can decide to override this setting by using the notation described in the following:</p> <ul style="list-style-type: none"> • For an Escalation Event that interrupts the Activity to which it is attached, the boundary of the Event is solid (see upper figure on the right). Note that if using this notation, the attribute <i>cancelActivity</i> of the Activity to which the Event is attached is implicitly set to <i>true</i>. • For an Escalation Event that does not interrupt the Activity to which it is attached, the boundary of the Event is dashed (see lower figure on the right). Note that if using this notation, the attribute <i>cancelActivity</i> of the Activity to which the Event is attached is implicitly set to <i>false</i>. 	<p><i>Interrupting</i></p>  <p><i>Non-Interrupting</i></p> 
<p>Error</p>	<p>A <i>catch Intermediate Error Event</i> can only be attached to the boundary of an Activity, i.e., it MAY NOT be used in <i>normal flow</i>. If used in this context, it reacts to (catches) a named <i>Error</i>, or to any <i>Error</i> if a name is not specified. Note that an Error Event always interrupts the Activity to which it is attached, i.e., there is not a non-interrupting version of this Event. The boundary of the Event thus always solid (see figure on the right).</p>	<p><i>Interrupting</i></p> 
<p>Cancel</p>	<p>This type of Intermediate Event is used within a Transaction Sub-Process. This type of Event MUST be attached to the boundary of a Sub-Process. It SHALL be triggered if a Cancel End Event is reached within the Transaction Sub-Process. It also SHALL be triggered if a <i>TransactionProtocol</i> "Cancel" Message has been received while the <i>transaction</i> is being performed. Note that a Cancel Event always interrupts the Activity to which it is attached, i.e., there is not a non-interrupting version of this Event. The boundary of the Event thus always solid (see figure on the right).</p>	<p><i>Interrupting</i></p> 
<p>Compensation</p>	<p>When attached to the boundary of an Activity, this Event is used to "catch" the Compensation Event, thus the Event marker MUST be unfilled (see figure on the right). The Event will be triggered by a thrown <i>compensation</i> targeting that Activity. When the Event is triggered, the Compensation Activity that is associated to the Event will be performed (see page 301). Note that the interrupting a non-interrupting aspect of other Events does not apply in the case of a Compensation Event. <i>Compensations</i> can only be triggered after completion of the Activity to which they are attached. Thus they cannot interrupt the Activity. The boundary of the Event is always solid.</p>	

Table 10.90 – Intermediate Event Types Attached to an Activity Boundary









<p>Conditional</p>	<p>This type of Event is triggered when a condition becomes <i>true</i>. A condition is a type of Expression. The attributes of an Expression can be found page 82. If a Conditional Event is attached to the boundary of an Activity, it will change the <i>normal flow</i> into an <i>exception flow</i> upon being triggered.</p> <p>For a Conditional Event that interrupts the Activity to which it is attached, the boundary of the Event is solid (see upper figure on the right). Note that if using this notation, the attribute <code>cancelActivity</code> of the Activity to which the Event is attached is implicitly set to <i>true</i>.</p> <p>For a Conditional Event that does not interrupt the Activity to which it is attached, the boundary of the Event is dashed (see lower figure on the right). Note that if using this notation, the attribute <code>cancelActivity</code> of the Activity to which the Event is attached is implicitly set to <i>false</i>.</p>	<p><i>Interrupting</i></p>  <p><i>Non-Interrupting</i></p> 
<p>Signal</p>	<p>The Signal Event can receive a Signal when attached to the boundary of an Activity. In this context, it will change the <i>normal flow</i> into an <i>exception flow</i> upon being triggered. The Signal Event differs from an Error Event in that the Signal defines a more general, non-error condition for interrupting Activities (such as the successful completion of another Activity) as well as having a larger scope than Error Events. When used to “catch” the Signal, the Event marker will be unfilled. The attributes of a Signal can be found on page 272.</p> <p>For a Signal Event that interrupts the Activity to which it is attached, the boundary of the Event is solid (see upper figure on the right). Note that if using this notation, the attribute <code>cancelActivity</code> of the Activity to which the Event is attached is implicitly set to <i>true</i>.</p> <p>For a Signal Event that does not interrupt the Activity to which it is attached, the boundary of the Event is dashed (see lower figure on the right). Note that if using this notation, the attribute <code>cancelActivity</code> of the Activity to which the Event is attached is implicitly set to <i>false</i>.</p>	<p><i>Interrupting</i></p>  <p><i>Non-Interrupting</i></p> 

Table 10.90 – Intermediate Event Types Attached to an Activity Boundary

<p>Multiple</p>	<p>A Multiple Event indicates that there are multiple <i>triggers</i> assigned to the Event. When attached to the boundary of an Activity, the Event can only “catch” the <i>trigger</i>. In this case, only one of the assigned <i>triggers</i> is REQUIRED and the Event marker will be unfilled upon being triggered, the Event that occurred will change the <i>normal flow</i> into an <i>exception flow</i>.</p> <p>There is no specific EventDefinition subclass (see page 259) for Multiple Intermediate Events. If the Intermediate Event has more than one associated EventDefinition, then the Event will be displayed with the Multiple Event marker.</p> <p>For a Multiple Event that interrupts the Activity to which it is attached, the boundary of the Event is solid (see upper figure on the right). Note that if using this notation, the attribute <code>cancelActivity</code> of the Activity to which the Event is attached is implicitly set to <i>true</i>.</p> <p>For a Multiple Event that does not interrupt the Activity to which it is attached, the boundary of the Event is dashed (see lower figure on the right). Note that if using this notation, the attribute <code>cancelActivity</code> of the Activity to which the Event is attached is implicitly set to <i>false</i>.</p>	<p>Interrupting</p>  <p>Non-Interrupting</p> 
<p>Parallel Multiple</p>	<p>This means that there are multiple <i>triggers</i> assigned to the Event. When attached to the boundary of an Activity, the Event can only “catch” the <i>trigger</i>. Unlike the normal Multiple Intermediate Event, all of the assigned <i>triggers</i> are REQUIRED for the Event to be triggered. The Event marker will be an unfilled plus sign (see the figures on the right). There is no specific EventDefinition subclass (see page 259) for Parallel Multiple Intermediate Events. If the Intermediate Event has more than one associated EventDefinition and the <code>parallelMultiple</code> attribute of the Intermediate Event is <i>true</i>, then the Event will be displayed with the Parallel Multiple Event marker.</p> <p>For a Parallel Multiple Event that interrupts the Activity to which it is attached, the boundary of the Event is solid (see the upper figure to the right). Note that if using this notation, the attribute <code>cancelActivity</code> of the Activity to which the Event is attached is implicitly set to <i>true</i>.</p> <p>For a Parallel Multiple Event that does not interrupt the Activity to which it is attached, the boundary of the Event is dashed (see the lower figure to the right). Note that if using this notation, the attribute <code>cancelActivity</code> of the Activity to which the Event is attached is implicitly set to <i>false</i>.</p>	<p>Interrupting</p>  <p>Non-Interrupting</p> 

Attributes for Boundary Events

For boundary **Events**, the following additional attributes exist:

- The BoundaryEvent element inherits the attributes and model associations of CatchEvent (see Table 8.44). Table 8.46 presents the additional attributes and model associations of the Boundary Event element.

Table 10.91 – Boundary Event attributes

Attribute Name	Description/Usage
attachedTo: Activity	Denotes the Activity that boundary Event is attached to.
cancelActivity: boolean	Denotes whether the Activity should be canceled or not, i.e., whether the <i>boundary catch Event</i> acts as an Error or an Escalation . If the Activity is not canceled, multiple <i>instances</i> of that handler can run concurrently. This attribute cannot be applied to Error Events (where it's always <i>true</i>), or Compensation Events (where it doesn't apply).

Table 10.92 specifies whether the cancel **Activity** attribute can be set on a boundary **Event** depending on the **EventDefinition** it catches.

Table 10.92 – Possible Values of the cancelActivity Attribute

Trigger	Possible Values for the cancelActivity Attribute
None	N/A as this event cannot be attached to the Activity border.
Message	<i>True/false</i>
Timer	<i>True/false</i>
Escalation	<i>True/false</i>
Error	<i>True</i>
Cancel	<i>True</i>
Compensation	N/A as the scope was already executed and can no longer be canceled when <i>compensation</i> is triggered.
Conditional	<i>True/false</i>
Signal	<i>True/false</i>
Multiple	<i>True/false</i> if all Event triggers allow this option (see this table for details). Otherwise the more restrictive option, i.e., Yes in case any Error or cancel triggers are used.

Activity Boundary Connections

An **Intermediate Event** can be attached to the boundary of an **Activity** under the following conditions:

- ◆ (One or more) **Intermediate Events** MAY be attached directly to the boundary of an **Activity**.
 - ◆ To be attached to the boundary of an **Activity**, an **Intermediate Event** MUST be one of the following *triggers* (**EventDefinition**): **Message**, **Timer**, **Error**, **Escalation**, **Cancel**, **Compensation**, **Conditional**, **Signal**, **Multiple**, and **Parallel Multiple**.
 - ◆ An **Intermediate Event** with a **Cancel trigger** MAY be attached to a **Sub-Process** boundary only if the **Transaction** attribute of the **Sub-Process** is set to *true*.

Sequence Flow Connections

See “Sequence Flow Connections Rules” on page 40 for the entire set of objects and how they MAY be a *source* or *target* of a **Sequence Flow**.

- ◆ If the **Intermediate Event** is attached to the boundary of an **Activity**:
 - ◆ The **Intermediate Event** MUST NOT be a target for a **Sequence Flow**; it cannot have an *incoming Sequence Flows*.
 - ◆ The **Intermediate Event** MUST be a source for a **Sequence Flow**.
 - ◆ Multiple **Sequence Flows** MAY originate from an **Intermediate Event**. For each **Sequence Flow** that has the **Intermediate Event** as a source, a new parallel path SHALL be generated.
 - ◆ An exception to this: an **Intermediate Event** with a *Compensation trigger* MUST NOT have an *outgoing Sequence Flow* (it MAY have an *outgoing Association*).
- ◆ The **Intermediate Events** with the following *triggers* (EventDefinition) MAY be used in *normal flow*: None, Message, Timer, Escalation, Compensation, Conditional, Link, Signal, Multiple, and ParallelMultiple. Thus, the following MUST NOT: Cancel and Error.
- ◆ If the **Intermediate Event** is used within *normal flow*:
 - ◆ **Intermediate Events** MUST be a target of a **Sequence Flow**.

NOTE: This is a change from **BPMN 1.2** semantics, which allowed some **Intermediate Events** to not have an *incoming Sequence Flow*.

- ◆ An **Intermediate Event** MAY have multiple *incoming Sequence Flows*.

NOTE: If the **Event** has multiple *incoming Sequence Flows*, then this is considered *uncontrolled flow*. This means that when a *token* arrives from one of the Paths, the **Event** will be enabled (to *catch* or *throw*). It will not wait for the arrival of *tokens* from the other paths. If another *token* arrives from the same path or another path, then a separate *instance* of the **Event** will be created. If the flow needs to be controlled, then the flow should converge with a **Gateway** that precedes the **Event** (see page 286 for more information on **Gateways**).

- ◆ An **Intermediate Event** MUST be a source for a **Sequence Flow**.
- ◆ Multiple **Sequence Flows** MAY originate from an **Intermediate Event**. For each **Sequence Flow** that has the **Intermediate Event** as a source, a new parallel path SHALL be generated.
- ◆ An exception to this: a *source Link Intermediate Event* (as defined below), it is NOT REQUIRED to have an *outgoing Sequence Flow*.
- ◆ A **Link Intermediate Event** MUST NOT be both a *target* and a *source* of a **Sequence Flow**.

To define the use of a **Link Intermediate Event** as an “Off-Page Connector” or a “Go To” object:

- ◆ A **Link Intermediate Event** MAY be the target (*target Link*) or a source (*source Link*) of a **Sequence Flow**, but MUST NOT be both a *target* and a *source*.
- ◆ If there is a *source Link*, there MUST be a matching *target Link* (they have the same name).
 - ◆ There MAY be multiple *source Links* for a single *target Link*.
 - ◆ There MUST NOT be multiple *target Links* for a single *source Link*.

Message Flow Connections

See “Message Flow Connection Rules” on page 41 for the entire set of objects and how they MAY be a *source* or *target* of a **Message Flow**.

NOTE: All **Message Flows** MUST connect two separate **Pools**. They MAY connect to the **Pool** boundary or to Flow Objects within the **Pool** boundary. They MUST NOT connect two objects within the same **Pool**.

- ◆ A **Message Intermediate Event** MAY be the *target* for a **Message Flow**; it can have one *incoming* **Message Flow**.
- ◆ A **Message Intermediate Event** MAY be a *source* for a **Message Flow**; it can have one *outgoing* **Message Flow**.
- ◆ A **Message Intermediate Event** MAY have an *incoming* **Message Flow** or an *outgoing* **Message Flow**, but not both.

10.5.5 Event Definitions

Event Definitions refers to the *triggers* of **Catch Events (Start and receive Intermediate Events)** and the Results of **Throw Events (End Events and send Intermediate Events)**. The types of **Event** Definitions are: **CancelEventDefinition**, **CompensationEventDefinition**, **ConditionalEventDefinition**, **ErrorEventDefinition**, **EscalationEventDefinition**, **MessageEventDefinition**, **LinkEventDefinition**, **SignalEventDefinition**, **TerminateEventDefinition**, and **TimerEventDefinition** (see Table 10.93). A **None Event** is determined by an **Event** that does not specify an **Event** Definition. A **Multiple Event** is determined by an **Event** that specifies more than one **Event** Definition. The different types of **Events (Start, End, and Intermediate)** utilize a subset of the available types of **Event** Definitions.

Table 10.93 – Types of Events and their Markers

Types	Start			Intermediate				End
	Top-Level	Event Sub-Process <i>Interrupting</i>	Event Sub-Process <i>Non-Interrupting</i>	Catching	Boundary <i>Interrupting</i>	Boundary <i>Non-Interrupting</i>	Throwing	
None								
Message								
Timer								
Error								
Escalation								
Cancel								

Table 10.93 – Types of Events and their Markers

Types	Start			Intermediate				End
	Top-Level	Event Sub-Process Interrupting	Event Sub-Process Non-Interrupting	Catching	Boundary Interrupting	Boundary Non-Interrupting	Throwing	
Compensation								
Conditional								
Link								
Signal								
Terminate								
Multiple								
Parallel Multiple								

The following sub clauses will present the attributes common to all **Event** Definitions and the specific attributes for the **Event** Definitions that have additional attributes. Note that the Cancel and Terminate **Event** Definitions do not have additional attributes.

Event Definition Metamodel

Figure 10.73 shows the class diagram for the abstract class EventDefinition. When one of the EventDefinition sub-types (e.g., TimerEventDefinition) is defined it is contained in Definitions, or a contained EventDefinition contained in a *throw/catch Event*.

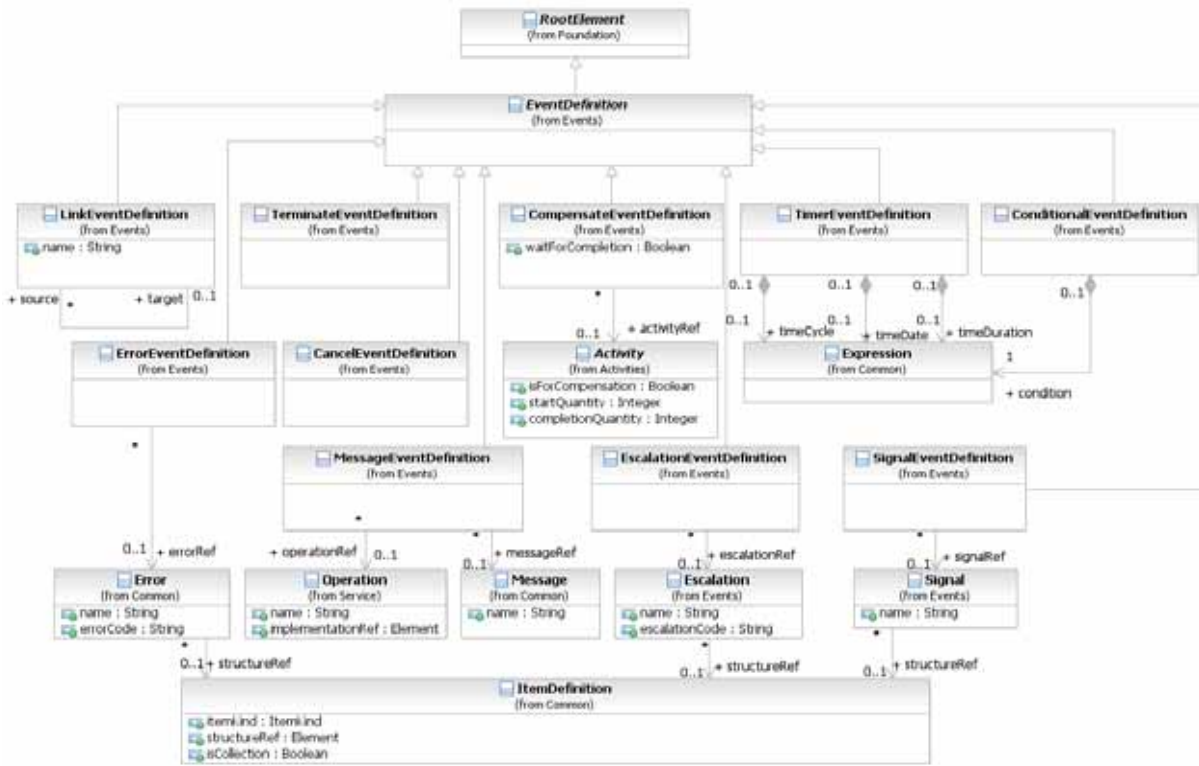

Figure 10.73 – EventDefinition Class Diagram

The EventDefinition element inherits the attributes and model associations of BaseElement (see Table 8.5) through its relationship to RootElement, but does not contain any additional attributes or model associations.

The ErrorEventDefinition, EscalationEventDefinition, and SignalEventDefinition subclasses comprise of attributes to carry data. The data is defined as part of the **Events** package. The MessageEventDefinition subclass comprises of an attribute that refers to a **Message** which is defined as part of the **Collaboration** package.

The following sub clauses will present the sub-types of EventDefinitions.

Cancel Event

Cancel Events are only used in the context of modeling **Transaction Sub-Processes** (see page 176 for more details on *Transactions*). There are two variations: a **catch Intermediate Event** and an **End Event**.

- ◆ The **catch Cancel Intermediate Event** MUST only be attached to the boundary of a **Transaction Sub-Process** and, thus, MAY NOT be used in *normal flow*.
- ◆ The **Cancel End Event** MUST only be used within a **Transaction Sub-Process** and, thus, MAY NOT be used in any other type of **Sub-Process** or **Process**.

Figure 10.74 shows the variations of **Cancel Events**.



Figure 10.74 – Cancel Events

The `CancelEventDefinition` element inherits the attributes and model associations of `BaseElement` (see Table 8.5) through its relationship to the `EventDefinition` element (see page 259).

Compensation Event

Compensation Events are used in the context of triggering or handling *compensation* (see page 301 for more details on *compensation*). There are four variations: a **Start Event**, both a *catch* and *throw* **Intermediate Event**, and an **End Event**.

- ◆ The **Compensation Start Event** MAY NOT be used for a *top-level Process*.
- ◆ The **Compensation Start Event** MAY be used for an **Event Sub-Process**.
- ◆ The *catch* **Compensation Intermediate Event** MUST only be attached to the boundary of an **Activity** and, thus, MAY NOT be used in *normal flow*.
- ◆ The *throw* **Compensation Intermediate Event** MAY be used in *normal flow*.
- ◆ The **Compensation End Event** MAY be used within any **Sub-Process** or **Process**.

Figure 10.75 shows the variations of **Compensation Events**.

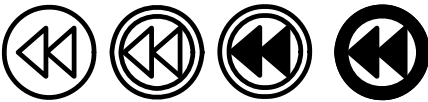

Figure 10.75 – Compensation Events

Figure 10.76 displays the class diagram for the `CompensationEventDefinition`.

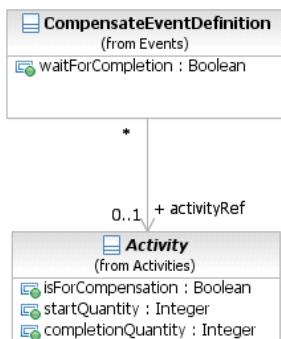

Figure 10.76 – CompensationEventDefinition Class Diagram

The `CompensationEventDefinition` element inherits the attributes and model associations of `BaseElement` (see Table 8.5) through its relationship to the `EventDefinition` element (see page 259). Table 10.94 presents the additional attributes and model associations of the `CompensationEventDefinition` element.

Table 10.94 – CompensationEventDefinition attributes and model associations

Attribute Name	Description/Usage
activityRef: Activity [0..1]	<p>For a Start Event:</p> <p>This Event “catches” the <i>compensation</i> for an Event Sub-Process. No further information is REQUIRED. The Event Sub-Process will provide the Id necessary to match the Compensation Event with the Event that <i>threw</i> the <i>compensation</i>, or the <i>compensation</i> will have been a broadcast.</p> <p>For an End Event:</p> <p>The Activity to be compensated MAY be supplied. If an Activity is not supplied, then the <i>compensation</i> is broadcast to all completed Activities in the current Sub-Process (if present), or the entire Process instance (if at the global level).</p> <p>For an Intermediate Event within <i>normal flow</i>:</p> <p>The Activity to be compensated MAY be supplied. If an Activity is not supplied, then the <i>compensation</i> is broadcast to all completed Activities in the current Sub-Process (if present), or the entire Process instance (if at the global level). This “throws” the <i>compensation</i>.</p> <p>For an Intermediate Event attached to the boundary of an Activity:</p> <p>This Event “catches” the <i>compensation</i>. No further information is REQUIRED. The Activity the Event is attached to will provide the Id necessary to match the Compensation Event with the Event that <i>threw</i> the <i>compensation</i>, or the <i>compensation</i> will have been a broadcast.</p>
waitForCompletion: boolean = true	<p>For a throw Compensation Event, this flag determines whether the <i>throw Intermediate Event</i> waits for the triggered <i>compensation</i> to complete (the default), or just triggers the <i>compensation</i> and immediately continues (the BPMN 1.2 behavior).</p>

Conditional Event

Figure 10.77 shows the variations of **Conditional Events**.



Figure 10.77 – Conditional Events

The ConditionalEventDefinition element inherits the attributes and model associations of BaseElement (see Table 8.5) through its relationship to the EventDefinition element (see page 259). Table 10.95 presents the additional model associations of the ConditionalEventDefinition element.

Figure 10.78 displays the class diagram for the ConditionalEventDefinition.

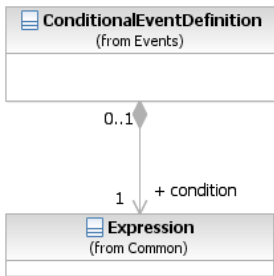

Figure 10.78 – ConditionalEventDefinition Class Diagram

The ConditionalEventDefinition element inherits the attributes and model associations of BaseElement (see Table 8.5) through its relationship to the EventDefinition element (see page 259). Table 10.95 presents the additional model associations of the ConditionalEventDefinition element.

Table 10.95 – ConditionalEventDefinition model associations

Attribute Name	Description/Usage
condition: Expression	The Expression might be underspecified and provided in the form of natural language. For executable Processes (<code>isExecutable = true</code>), if the <i>trigger</i> is Conditional, then a FormalExpression MUST be entered.

Error Event

Figure 10.79 shows the variations of **Conditional Events**.



Figure 10.79 – Error Events

Figure 10.80 displays the class diagram for the ErrorEventDefinition.

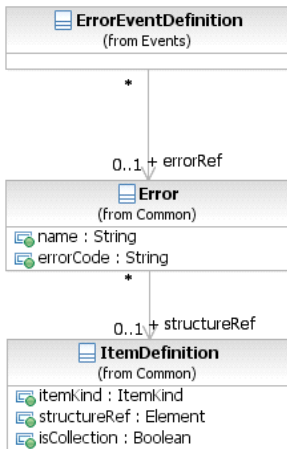

Figure 10.80 – ErrorEventDefinition Class Diagram

The `ErrorEventDefinition` element inherits the attributes and model associations of `BaseElement` (see Table 8.5) through its relationship to the `EventDefinition` element (see page 259). Table 10.96 presents the additional attributes and model associations of the `ErrorEventDefinition` element.

Table 10.96 – ErrorEventDefinition attributes and model associations

Attribute Name	Description/Usage
<code>error: Error [0..1]</code>	If the <i>trigger</i> is an <code>Error</code> , then an <code>Error</code> payload MAY be provided.

Escalation Event Definition

Figure 10.81 shows the variations of **Escalation Events**.



Figure 10.81 – Escalation Events

Figure 10.82 displays the class diagram for the `EscalationEventDefinition`.

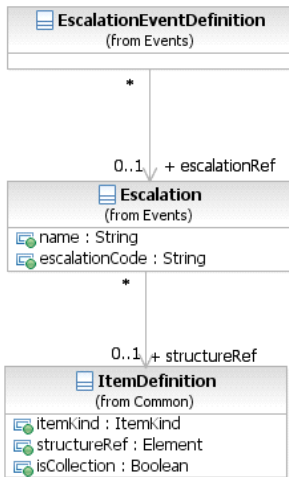

Figure 10.82 – EscalationEventDefinition Class Diagram

The `EscalationEventDefinition` element inherits the attributes and model associations of `BaseElement` (see Table 8.5) through its relationship to the `EventDefinition` element (see page 259). Table 10.97 presents the additional attributes and model associations of the `EscalationEventDefinition` element.

Table 10.97 – EscalationEventDefinition attributes and model associations

Attribute Name	Description/Usage
<code>escalationRef: Escalation</code> [0..1]	If the <i>trigger</i> is an <code>Escalation</code> , then an <code>Escalation</code> payload MAY be provided.

Link Event Definition

A **Link Event** is a mechanism for connecting two sections of a **Process**. **Link Events** can be used to create looping situations or to avoid long **Sequence Flow** lines. The use of **Link Events** is limited to a single **Process** level (i.e., they cannot link a *parent Process* with a **Sub-Process**).

Figure 10.83 shows the variations of **Link Events**.

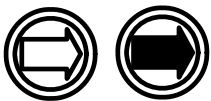

Figure 10.83 – Link Events

Paired **Link Events** can also be used as “Off-Page Connectors” for printing a **Process** across multiple pages. They can also be used as generic “Go To” objects within the **Process** level. There can be multiple *source Link Events*, but there can only be one *target Link Event*. When used to “catch” from the *source Link*, the **Event** marker will be unfilled (see Figure 10.84: upper right). When used to “throw” to the *target Link*, the **Event** marker will be filled (see Figure 10.84: upper: lower Left).

Since **Process** models often extend beyond the length of one printed page, there is often a concern about showing how **Sequence Flow** connections extend across the page breaks. One solution that is often employed is the use of Off-Page connectors to show where one page leaves off and the other begins. **BPMN** provides **Intermediate Events** of type **Link** for use as Off-Page connectors (see Figure 10.84 --Note that the figure shows two different printed pages, not two **Pools** in one diagram). A pair of **Link Events** is used. One of the pair is shown at the end of one page. This **Event** is named and has an *incoming* **Sequence Flow** and no *outgoing* **Sequence Flows**. The second **Link Event** is at the beginning of the next page, shares the same name, and has an *outgoing* **Sequence Flow** and no *incoming* **Sequence Flow**.

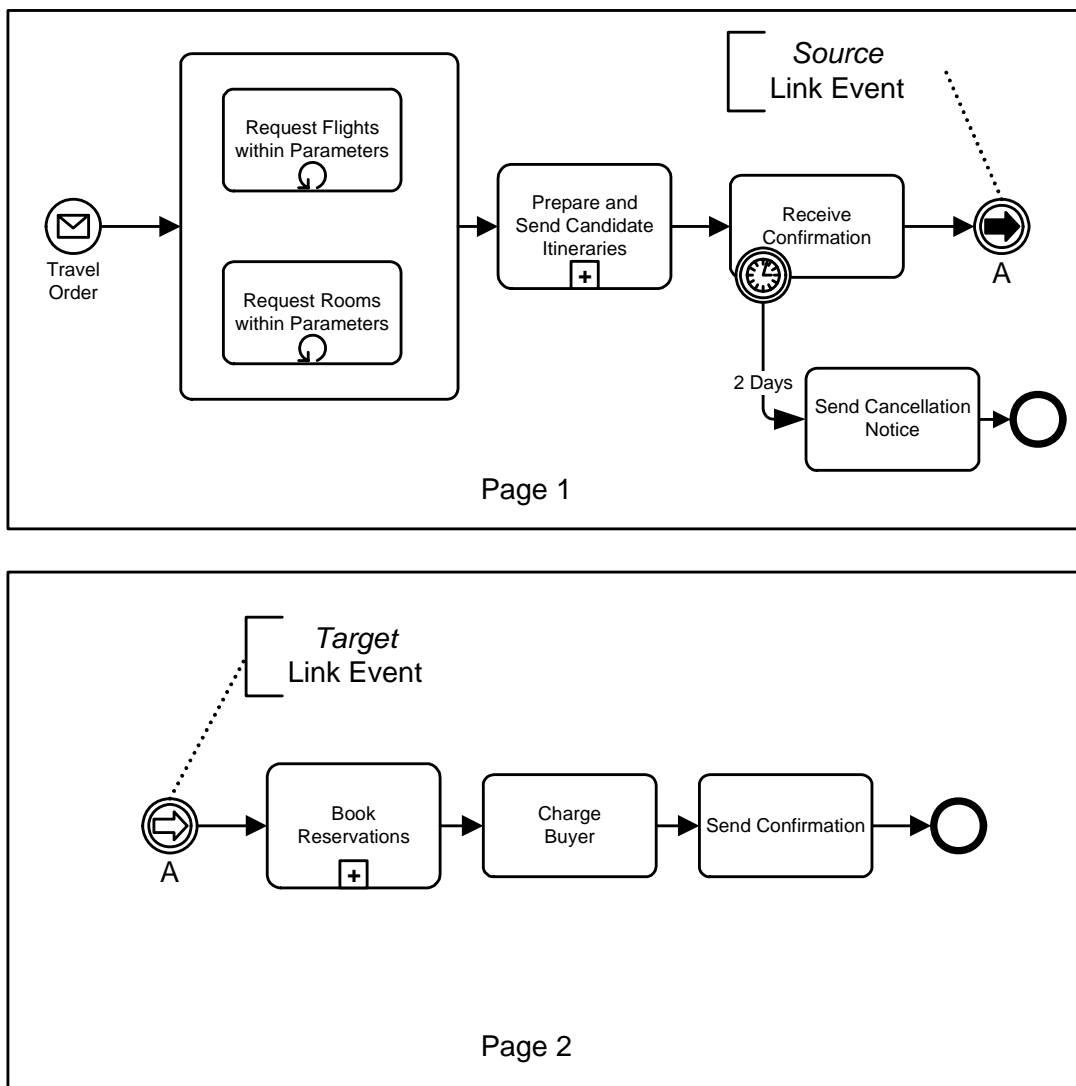

Figure 10.84 – Link Events Used as Off-Page Connector

Another way that **Link Events** can be used is as “Go To” objects. Functionally, they would work the same as for Off-Page Connectors (described above), except that they could be used anywhere in the diagram on the same page or across multiple pages. The general idea is that they provide a mechanism for reducing the length of **Sequence Flow** lines. Some modelers can consider long lines as being hard to follow or trace. Go To Objects can be used to avoid very long

Sequence Flows (see Figure 10.85 and Figure 10.86). Both diagrams will behave equivalently. For Figure 10.86, if the “Order Rejected” path is taken from the Decision, then the *token* traversing the **Sequence Flow** would reach the *source Link Event* and then “jump” to the *target Link Event* and continue down the **Sequence Flow**. The **Process** would continue as if the **Sequence Flow** had directly connected the two objects.

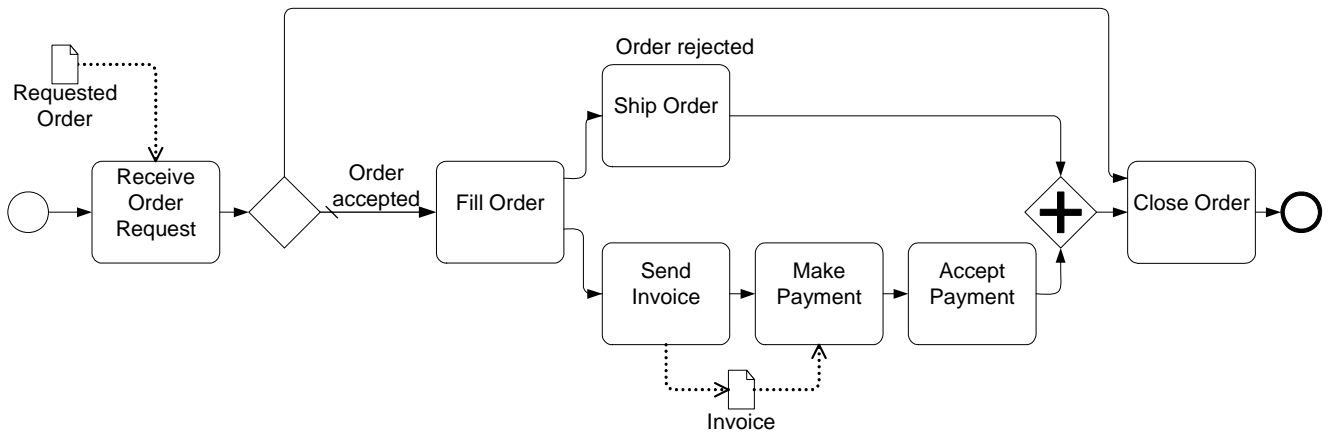

Figure 10.85 – A Process with a long Sequence Flow

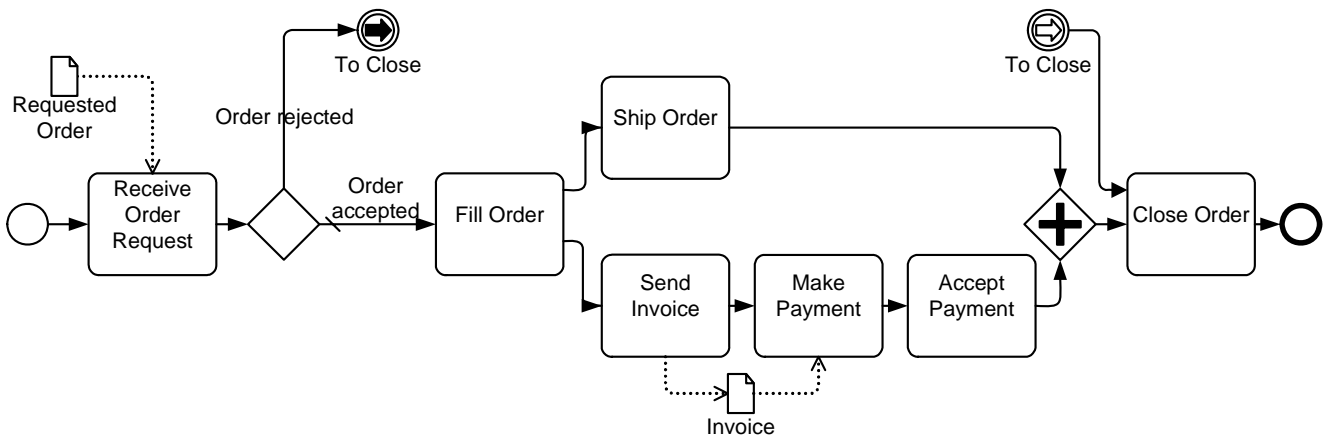

Figure 10.86 – A Process with Link Intermediate Events used as Go To Objects

Some methodologies prefer that all **Sequence Flows** only move in one direction; that is, forward in time. These methodologies do not allow **Sequence Flows** to connect directly to upstream objects. Some consistency in modeling can be gained by such a methodology, but situations that require looping become a challenge. **Link Events** can be used to make upstream connections and create *loops* without violating the **Sequence Flow** direction restriction (see Figure 10.87).

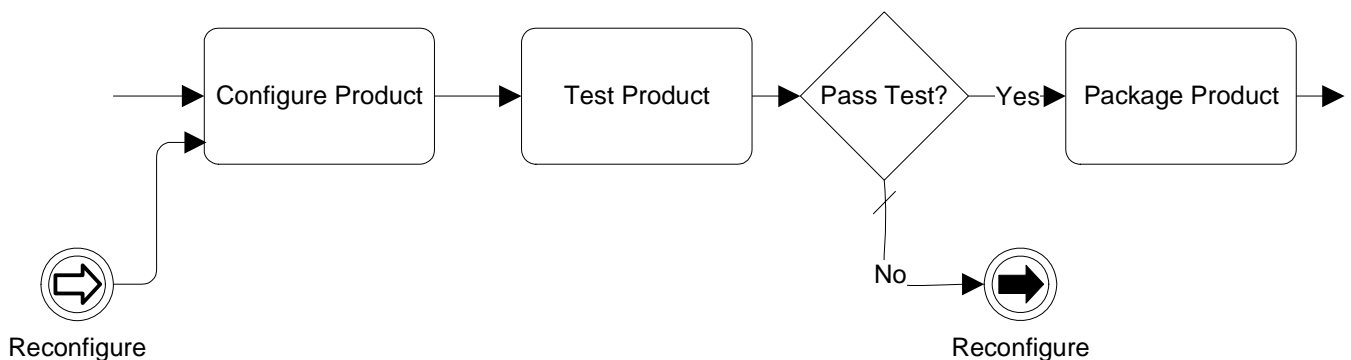

Figure 10.87 – Link Events Used for looping

The `LinkEventDefinition` element inherits the attributes and model associations of `BaseElement` (see Table 8.5) through its relationship to the `EventDefinition` element (see page 259). Table 10.98 presents the additional attributes of the `LinkEventDefinition` element.

Table 10.98 – LinkEventDefinition attributes

Attribute Name	Description/Usage
name: string	If the <i>trigger</i> is a <i>Link</i> , then the <code>name</code> MUST be entered.
sources: LinkEventDefinition [1..*]	Used to reference the corresponding 'catch' or 'target' LinkEventDefinition, when this LinkEventDefinition represents a 'throw' or 'source' LinkEventDefinition.
target: LinkEventDefinition [1]	Used to reference the corresponding 'throw' or 'source' LinkEventDefinition, when this LinkEventDefinition represents a 'catch' or 'target' LinkEventDefinition.

Message Event Definition

Figure 10.88 shows the variations of **Message Events**.



Figure 10.88 – Message Events

Figure 10.89 displays the class diagram for the MessageEventDefinition.

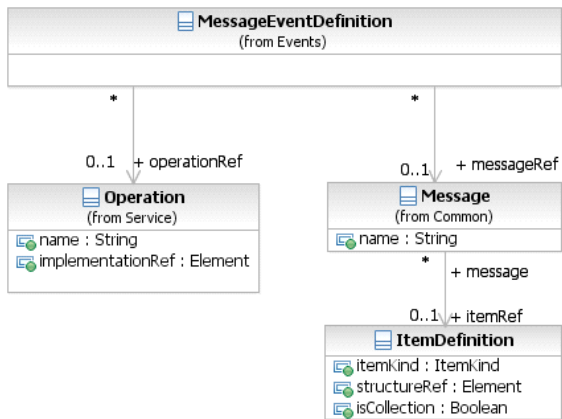

Figure 10.89 – MessageEventDefinition Class Diagram

The MessageEventDefinition element inherits the attributes and model associations of BaseElement (see Table 8.5) through its relationship to the EventDefinition element (see page 259). Table 10.99 presents the additional model associations of the MessageEventDefinition element.

Table 10.99 – MessageEventDefinition model associations

Attribute Name	Description/Usage
messageRef: Message [0..1]	The Message MUST be supplied (if the isExecutable attribute of the Process is set to <i>true</i>).
operationRef: Operation [0..1]	This attribute specifies the Operation that is used by the Message Event . It MUST be specified for executable Processes .

Multiple Event

For a **Start Event**:

If the *trigger* is Multiple, there are multiple ways of starting the **Process**. Only one of them is necessary to trigger the start of the **Process**. The EventDefinition subclasses will define which *triggers* apply

For an **End Event**:

If the *Result* is Multiple, there are multiple consequences of ending the **Process**. All of them will occur. The EventDefinition subclasses will define which *Results* apply.

For an **Intermediate Event** within *normal flow*:

If the *trigger* is Multiple, only one EventDefinition is REQUIRED to *catch* the *trigger*. When used to *throw*, all of the EventDefinitions are considered and the subclasses will define which *Results* apply.

For an **Intermediate Event** attached to the boundary of an **Activity**:

If the *trigger* is **Multiple**, only one **EventDefinition** is **REQUIRED** to “catch” the *trigger*.

Figure 10.90 shows the variations of **Multiple Events**.



Figure 10.90 – Multiple Events

None Event

None Events are **Events** that do not have a defined **EventDefinition**. There are three (3) variations of **None Events**: a **Start Event**, a *catch* **Intermediate Event**, and an **End Event** (see Figure 10.91).

- ◆ The **None Start Event** **MAY** be used for a *top-level* **Process** or any type of **Sub-Process** (except an **Event Sub-Process**).
- ◆ The **None Start Event** **MAY NOT** be used for an **Event Sub-Process**.
- ◆ The *catch* **None Intermediate Event** **MUST** only be used in *normal flow* and, thus, **MAY NOT** be attached to the boundary of an **Activity**.
- ◆ The **None End Event** **MAY** be used within any **Sub-Process** or **Process**.

Figure 10.91 shows the variations of **None Events**.



Figure 10.91 – None Events

Parallel Multiple Event

For a **Start Event**:

- If the *trigger* is **Multiple**, there are multiple *triggers* **REQUIRED** to start the **Process**. All of them are necessary to trigger the start of the **Process**. The **EventDefinition** subclasses will define which *triggers* apply. In addition, the **parallelMultiple** attribute of the **Start Event** **MUST** be set to *true*.

For an **Intermediate Event** within *normal flow*:

- If the *trigger* is **Multiple**, all of the defined **EventDefinitions** are **REQUIRED** to trigger the **Event**. In addition, the **parallelMultiple** attribute of the **Intermediate Event** **MUST** be set to *true*.

For an **Intermediate Event** attached to the boundary of an **Activity**:

- If the *trigger* is **Multiple**, all of the defined **EventDefinitions** are **REQUIRED** to trigger the **Event**. In addition, the **parallelMultiple** attribute of the **Intermediate Event** **MUST** be set to *true*.

Figure 10.92 shows the variations of **Parallel Multiple Events**.

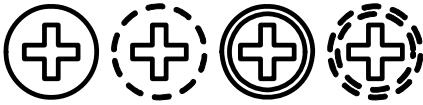

Figure 10.92 – Multiple Events

Signal Event

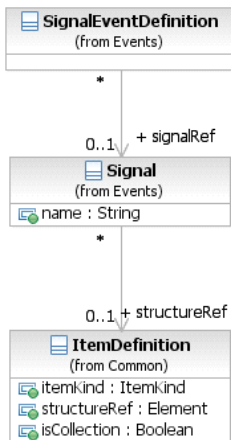

Figure 10.93 – SignalEventDefinition Class Diagram

Figure 10.94 shows the variations of **Signal Events**.



Figure 10.94 – Signal Events

The `SignalEventDefinition` element inherits the attributes and model associations of `BaseElement` (see Table 8.5) through its relationship to the `EventDefinition` element (see page 259). Table 10.100 presents the additional model associations of the `ConditionalSignalDefinition` element.

Table 10.100 – SignalEventDefinition model associations

Attribute Name	Description/Usage
<code>signalRef: Signal [0..1]</code>	If the <i>trigger</i> is a <code>Signal</code> , then a <code>Signal</code> is provided.

Terminate Event

Figure 10.95 shows the **Terminate Event**.



Figure 10.95 – Terminate Event

The `TerminateEventDefinition` element inherits the attributes and model associations of `BaseElement` (see Table 8.5) through its relationship to the `EventDefinition` element (see page 259).

Timer Event

Figure 10.96 shows the variations of **Timer Events**.



Figure 10.96 – Timer Events

The `TimerEventDefinition` element inherits the attributes and model associations of `BaseElement` (see Table 8.5) through its relationship to the `EventDefinition` element (see page 259). Table 10.101 presents the additional model associations of the `TimerEventDefinition` element.

Table 10.101 – TimerEventDefinition model associations

Attribute Name	Description/Usage
timeDate: Expression [0..1]	If the <i>trigger</i> is a Timer, then a <code>timeDate</code> MAY be entered. Timer attributes are mutually exclusive and if any of the other Timer attributes is set, <code>timeDate</code> MUST NOT be set (if the <code>isExecutable</code> attribute of the Process is set to <i>true</i>). The return type of the attribute <code>timeDate</code> MUST conform to the ISO-8601 format for date and time representations.
timeCycle: Expression [0..1]	If the <i>trigger</i> is a Timer, then a <code>timeCycle</code> MAY be entered. Timer attributes are mutually exclusive and if any of the other Timer attributes is set, <code>timeCycle</code> MUST NOT be set (if the <code>isExecutable</code> attribute of the Process is set to <i>true</i>). The return type of the attribute <code>timeCycle</code> MUST conform to the ISO-8601 format for recurring time interval representations.
timeDuration: Expression [0..1]	If the <i>trigger</i> is a Timer, then a <code>timeDuration</code> MAY be entered. Timer attributes are mutually exclusive and if any of the other Timer attributes is set, <code>timeDuration</code> MUST NOT be set (if the <code>isExecutable</code> attribute of the Process is set to <i>true</i>). The return type of the attribute <code>timeDuration</code> MUST conform to the ISO-8601 format for time interval representations.

10.5.6 Handling Events

BPMN provides advanced constructs for dealing with **Events** that occur during the execution of a **Process** (i.e., the “catching” of an **Event**). Furthermore, **BPMN** supports the explicit creation of an **Event** in the **Process** (i.e., the “throwing” of an **Event**). Both *catching* and *throwing* of an **Event** as well as the resulting **Process** behavior is referred to as *Event handling*. There are three types of *Event handlers*: those that start a **Process**, those that are part of the normal **Sequence Flow**, and those that are attached to **Activities**, either via boundary **Events** or via separate *inline handlers* in case of an **Event Sub-Process**.

Handling Start Events

There are multiple ways in which a **Process** can be started. For single **Start Events**, handling consists of starting a new **Process instance** each time the **Event** occurs. **Sequence Flows** leaving the **Event** are then followed as usual. For multiple **Start Events**, **BPMN** supports several modeling scenarios that can be applied depending on the scenario.

Exclusive start: the most common scenario for starting a **Process** is its instantiation by exactly one out of many possible **Start Events**. Each occurrence of one of these **Events** will lead to the creation of a new **Process instance**. The following example shows two **Events** connected to a single **Activity** (see Figure 10.97). At runtime, each occurrence of one of the **Events** will lead to the creation of a new *instance* of the **Process instance** and activation of the **Activity**. Note that a single **Multiple Start Event** that contains the Message Event Definitions would behave in the same way.

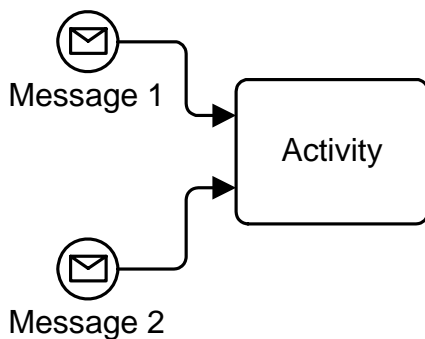

Figure 10.97 – Exclusive start of a Process

A **Process** can also be started via an Event-Based Gateway, as in the following example (Figure 10.98).

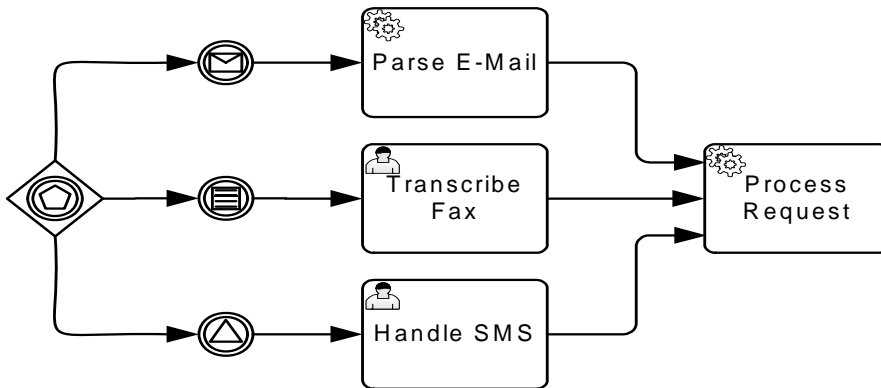

Figure 10.98 – A Process initiated by an Event-Based Gateway

In that case, the first matching **Event** will create a new *instance* of the **Process**, and waiting for the other **Events** originating from the same decision stops, following the usual semantics of the **Event-Based Exclusive Gateway**. Note that this is the only scenario where a **Gateway** can exist without an *incoming Sequence Flows*.

It is possible to have multiple groups of **Event-Based Gateways** starting a **Process**, provided they participate in the same **Conversation** and hence share the same correlation information. In that case, one **Event** out of each group needs to arrive; the first one creates a new **Process instance**, while the subsequent ones are routed to the existing *instance*, which is identified through its correlation information.

Event synchronization: if the modeler requires several disjoint **Start Events** to be merged into a single **Process instance**, then the following notation **MUST** be applied (Figure 10.99).

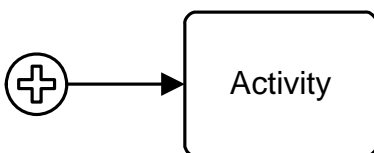

Figure 10.99 – Event synchronization at Process start

The **Parallel Start Event** **MAY** group several disjoint **Start Events** each of which **MUST** occur once in order for an *instance* of the **Process** to be created. **Sequence Flows** leaving the **Event** are then followed as usual.

See page 439 for the execution semantics for the *Event Handling* of **Start Events**.

Handling Events within normal Sequence Flow (Intermediate Events)

For **Intermediate Events**, the handling consists of waiting for the **Event** to occur. Waiting starts when the **Intermediate Event** is reached. Once the **Event** occurs, it is consumed. **Sequence flows** leaving the **Event** are followed as usual.

Handling Events attached to an Activity (Intermediate boundary Events and Event Sub-Processes)

For boundary **Events**, handling consists of consuming the **Event** occurrence and either canceling the **Activity** the **Event** is attached to, followed by normal **Sequence Flows** leaving that **Activity**, or by running an *Event Handler* without canceling the **Activity** (only for **Message**, **Signal**, **Timer** and **Conditional Events**, not for **Error Events**).

An interrupting boundary **Event** is defined by a *true* value of its `cancelActivity` attribute. Whenever the **Event** occurs, the associated **Activity** is terminated. A downstream *token* is then generated, which activates the next element of the **Process** (connected to the **Event** by an unconditional **Sequence Flow** called an *exception flow*).

For non-interrupting boundary **Events**, the `cancelActivity` attribute is set to *false*. Whenever the **Event** occurs, the associated **Activity** continues to be active. As a *token* is generated for the **Sequence Flow** from the boundary **Event** in parallel to the continuing execution of the **Activity**, care **MUST** be taken when this flow is merged into the main flow of the **Process** – typically it should be ended with its own **End Event**.

The following example shows a fragment (see Figure 10.100) from a trip booking **Process**. It contains a **Sub-Process** that consists of a main part, and three **Event Sub-Processes** to deal with **Events** within the same context: an error **Event Sub-Process** that cancels the **Sub-Process**, a **Message Event Sub-Process** that updates the state of the **Sub-Process** while allowing it to continue, and a **Compensation Event Sub-Process**.

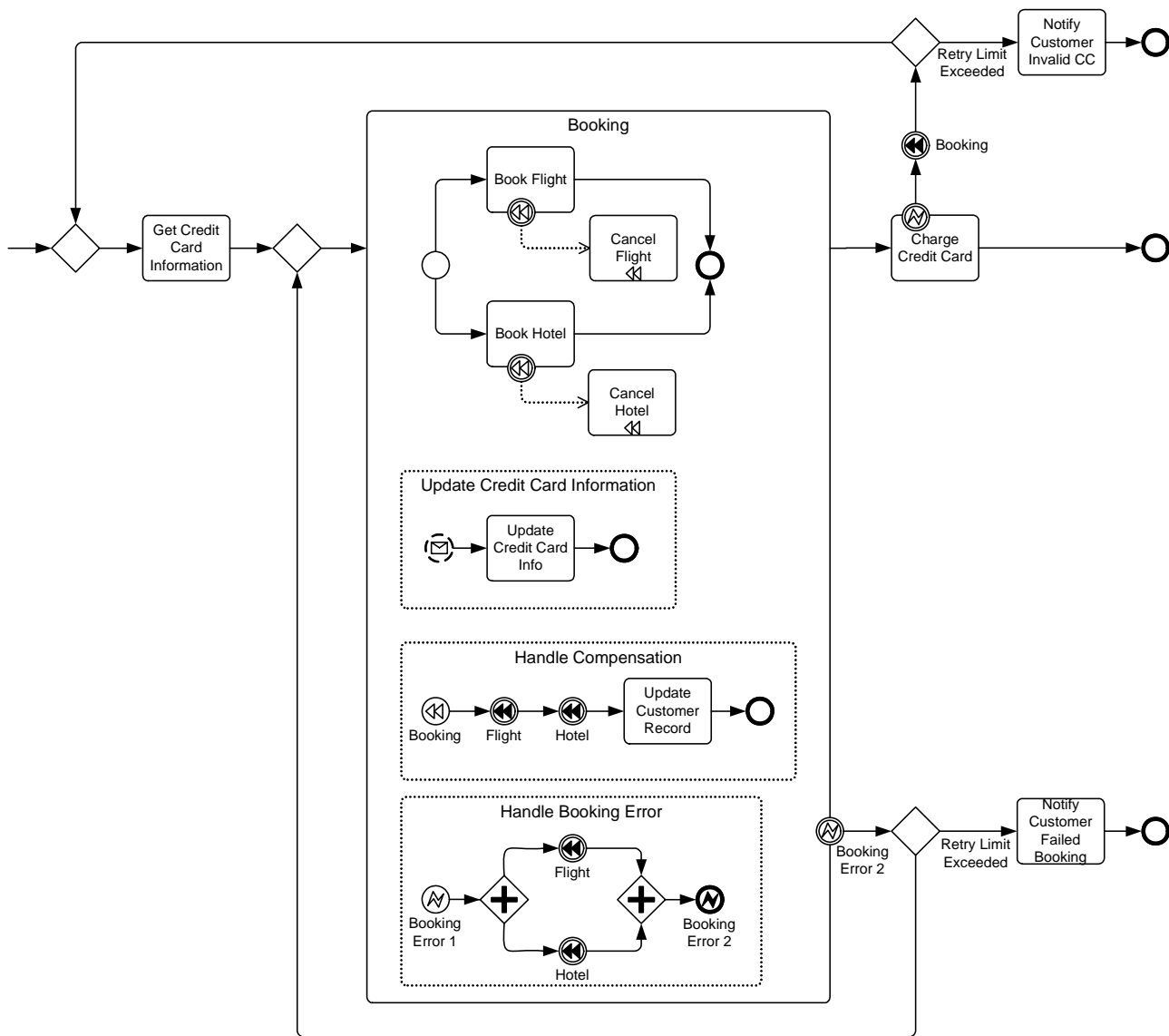

Figure 10.100 – Example of inline *Event Handling* via *Event Sub-Processes*

The following example (see Figure 10.101) shows the same fragment of that **Process**, using boundary **Event** handlers rather than inline **Event Sub-Processes**. Note that in this example, the handlers do not have access to the context of the “Booking” **Sub-Process**, as they run outside of it. Therefore, the actually *compensation* logic is shown as a black box.

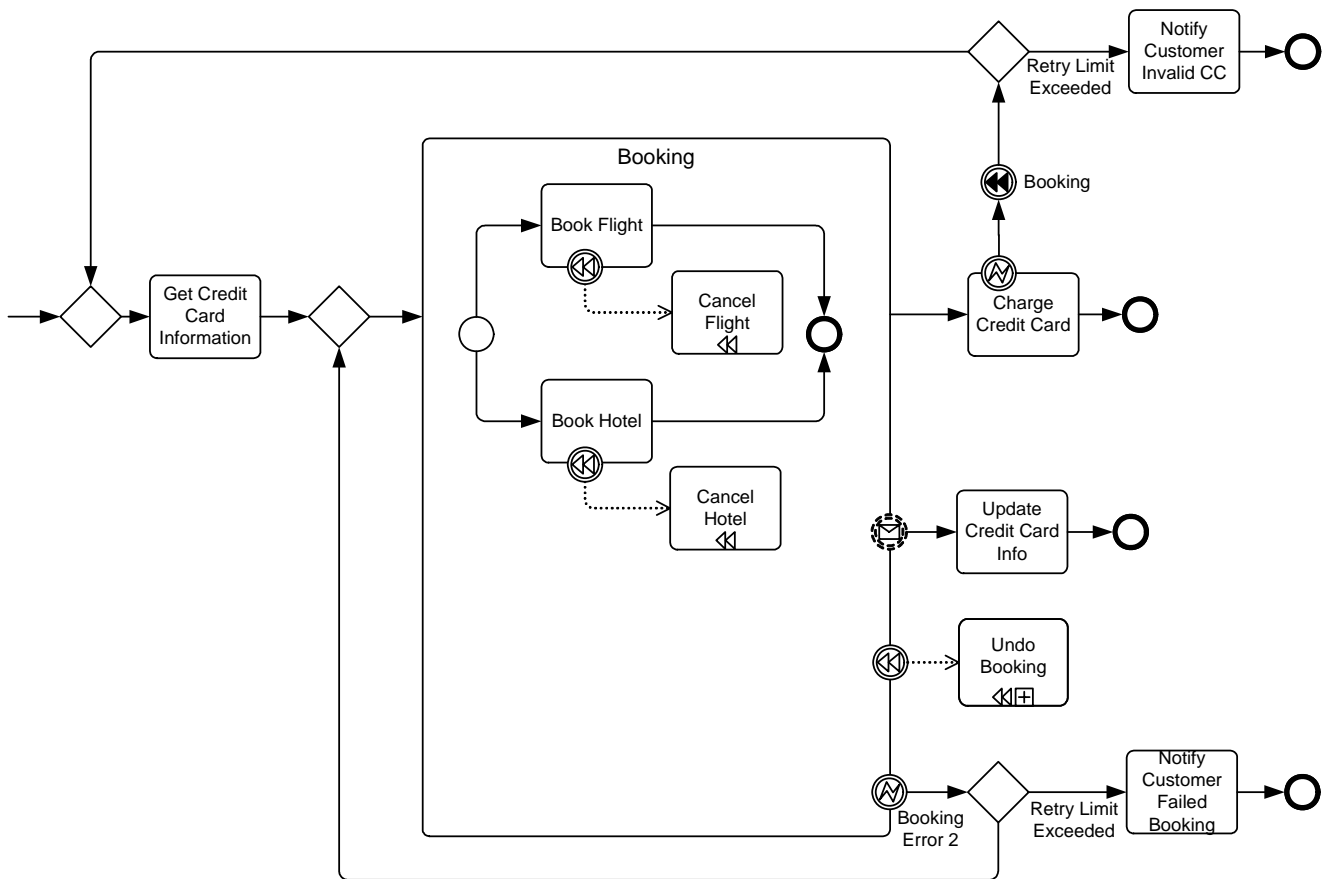

Figure 10.101 – Example of boundary Event Handling

Note that there is a distinction between *interrupting* and *non-interrupting* **Events** and the handling of these **Events**, which is described in the sub clauses below. For an interrupting **Event** (**Error**, **Escalation**, **Message**, **Signal**, **Timer**, **Conditional**, **Multiple**, and **Parallel Multiple**), only one **Event Sub-Process** for the same **Event Declaration** MUST be modeled. This excludes any further non-interrupting handlers for that **Event Declaration**.

The reason for this restriction lies in the nature of interrupting **Event Sub-Processes** and boundary **Events**. They interrupt normal execution of the parent **Activity** and after their completion, the parent **Activity** is immediately terminated. This implies that only one such handler can be executed at a time. However, this does not restrict the modeler in specifying several interrupting handlers, if each handler refers to a different Event Declaration.

For non-interrupting **Events** (**Escalation**, **Message**, **Signal**, **Timer**, **Conditional**, **Multiple**, and **Parallel Multiple**), an unlimited number of **Event Sub-Processes** for the same **Event Declaration** can be modeled and executed in parallel. At runtime, they will be invoked in a non-deterministic order. The same restrictions apply for boundary **Events**. During execution of a non-interrupting Event Sub-Process, execution of the parent Activity continues as normal.

If for a given **Sub-Process**, both an inline **Event Sub-Process** and a boundary **Event** handler are modeled that **Process** the same **EventDefinition**, the following semantics apply:

- ◆ If the inline **Event Sub-Process** “re-throws” the **Event** after completion, the boundary **Event** is triggered.

- ◆ If the inline **Event Sub-Process** completes without “re-throwing” the **Event**, the **Activity** is considered to have completed and normal **Sequence Flow** resumes. In other terms, the **Event Sub-Process** “absorbs” the **Event**.

Interrupting Event Handlers (Error, Escalation, Message, Signal, Timer, Conditional, Multiple, and Parallel Multiple)

Interrupting *Event Handlers* are those that have the `cancelActivity` attribute is set to *true*. Whenever the **Event** occurs, regardless of whether the **Event** is handled inline or on the boundary, the associated **Activity** is interrupted. If an inline error handler is specified (in case of a **Sub-Process**), it is run within the context of that **Sub-Process**. If a boundary **Error Event** is present, **Sequence Flows** from that boundary **Event** are then followed. The parent **Activity** is canceled after either the error handler completes or **Sequence Flow** from the boundary **Event** is followed.

In the example above, the “Booking” **Sub-Process** has an *Error handler* that defines what should happen in case a “Booking” **Error** occurs within the **Sub-Process**, namely, the already performed bookings are canceled using *compensation*. The *Error handler* is then continued outside the **Sub-Process** through a boundary **Error Event**.

Non-interrupting Event Handlers (Escalation, Message, Signal, Timer, Conditional, Multiple, and Parallel Multiple)

Interrupting *Event Handlers* are those that have the `cancelActivity` attribute is set to *false*.

For **Event Sub-Processes**, whenever the **Event** occurs it is consumed and the associated **Event Sub-Process** is performed. If there are several **Events** that happen in parallel, then they are handled concurrently, i.e., several **Event Sub-Process instances** are created concurrently. The *non-interrupting Start Event* indicates that the **Event Sub-Process instance** runs concurrently to the **Sub-Process** proper.

For boundary **Events**, whenever the **Event** occurs the handler runs concurrently to the **Activity**. If an **Event Sub-Process** is also specified for that **Event** (in case of a **Sub-Process**), it is run within the context of that **Sub-Process**. Then, **Sequence Flows** from the boundary **Event** are followed. As a *token* is generated for the **Sequence Flow** from the boundary **Event** in parallel to the continuing execution of the **Activity**, care **MUST** be taken when this flow is merged into the main flow of the **Process** – typically it should be ended with its own **End Event**.

In the example above, an *Event Handler* allows to update the credit card information during the “Booking” **Sub-Process**. It is triggered by a credit card information **Message**: such a **Message** can be received whenever the control flow is within the main body of the **Sub-Process**. Once such a **Message** is received, the **Activities** within the corresponding *Event Handler* run concurrently with the **Activities** within the body of the **Sub-Process**.

See “Intermediate Events” on page 440 for the exact semantics of boundary **Intermediate Events** and “Event Sub-Processes” on page 440 for the operational semantics of non-interrupting **Event Sub-Processes**.

Handling End Events

For a **Terminate End Event**, all remaining active **Activities** within the **Process** are terminated.

A **Cancel End Event** is only allowed in the context of a **Transaction Sub-Process** and, as such, cancels the **Sub-Process** and aborts an associated *Transaction* of the **Sub-Process**.

For all other **End Events**, the behavior associated with the `EventDefinition` is performed. When there are no further active **Activities**, then the **Sub-Process** or **Process instance** is completed. See page 443 for exact semantics.

10.5.7 Scopes

A *scope* describes the context in which execution of an **Activity** happens. This consists of the set of:

- **Data Objects** available (including **DataInput** and **DataOutput**)
- **Events** available for *catching* or *throwing triggers*
- **Conversations** going on in that *scope*

In general, a *scope* contains exactly one main flow of **Activities** which is started, when the *scope* gets activated. Vice versa, all **Activities** are enclosed by a *scope*. *Scopes* are hierarchically nested.

Scopes can have several *scope instances* at runtime. They are also hierarchically nested according to their generation. In a *scope instance* several *tokens* can be active.

Scope instances in turn have a **lifecycle** containing among others the states:

- Activated
- In execution
- Completed
- In Compensation
- Compensation
- In Error
- In Cancellation
- Cancelled

BPMN has the following model elements with *scope* characteristics:

- **Choreography**
- **Pool**
- **Sub-Process**
- **Task**
- **Activity**
- *Multi-instances* body

Scopes are used to define the semantics of:

- Visibility of **Data Objects** (including **DataInput** and **DataOutput**)
- **Event** resolution
- Starting/stopping of *token* execution

The **Data Objects**, **Events**, and correlation keys described by a *scope* can be explicitly modeled or implicitly defined.

10.5.8 Events Package XML Schemas

Table 10.102 – BoundaryEvent XML schema

```
<xsd:element name="boundaryEvent" type="tBoundaryEvent" substitutionGroup="flowElement"/>
<xsd:complexType name="tBoundaryEvent">
  <xsd:complexContent>
    <xsd:extension base="tCatchEvent">
      <xsd:attribute name="cancelActivity" type="xsd:boolean" default="true"/>
      <xsd:attribute name="attachedToRef" type="xsd:QName"/>
    </xsd:extension>
  </xsd:complexContent>
</xsd:complexType>
```

Table 10.103 – CancelEventDefinition XML schema

```
<xsd:element name="cancelEventDefinition" type="tCancelEventDefinition" substitutionGroup="eventDefinition"/>
<xsd:complexType name="tCancelEventDefinition">
  <xsd:complexContent>
    <xsd:extension base="tEventDefinition"/>
  </xsd:complexContent>
</xsd:complexType>
```

Table 10.104 – CatchEvent XML schema

```
<xsd:element name="catchEvent" type="tCatchEvent"/>
<xsd:complexType name="tCatchEvent" abstract="true">
  <xsd:complexContent>
    <xsd:extension base="tEvent">
      <xsd:sequence>
        <xsd:element ref="dataOutput" minOccurs="0" maxOccurs="unbounded"/>
        <xsd:element ref="dataOutputAssociation" minOccurs="0" maxOccurs="unbounded"/>
        <xsd:element ref="outputSet" minOccurs="0" maxOccurs="1"/>
        <xsd:element ref="eventDefinition" minOccurs="0" maxOccurs="unbounded"/>
        <xsd:element name="eventDefinitionRef" type="xsd:QName" minOccurs="0" maxOccurs="unbounded"/>
      </xsd:sequence>
      <xsd:attribute name="parallelMultiple" type="xsd:boolean" default="false"/>
    </xsd:extension>
  </xsd:complexContent>
</xsd:complexType>
```

Table 10.105 – CancelEventDefinition XML schema

```
<xsd:element name="cancelEventDefinition" type="tCancelEventDefinition" substitutionGroup="eventDefinition"/>
<xsd:complexType name="tCancelEventDefinition">
  <xsd:complexContent>
    <xsd:extension base="tEventDefinition"/>
  </xsd:complexContent>
</xsd:complexType>
```

Table 10.106 – CompensateEventDefinition XML schema

```
<xsd:element name="compensateEventDefinition" type="tCompensateEventDefinition" substitutionGroup="event-
  Definition"/>
<xsd:complexType name="tCompensateEventDefinition">
  <xsd:complexContent>
    <xsd:extension base="tEventDefinition">
      <xsd:attribute name="waitForCompletion" type="xsd:boolean"/>
      <xsd:attribute name="activityRef" type="xsd:QName"/>
    </xsd:extension>
  </xsd:complexContent>
</xsd:complexType>
```

Table 10.107 – ConditionalEventDefinition XML schema

```
<xsd:element name="conditionalEventDefinition" type="tConditionalEventDefinition" substitutionGroup="eventDef-
  inition"/>
<xsd:complexType name="tConditionalEventDefinition">
  <xsd:complexContent>
    <xsd:extension base="tEventDefinition">
      <xsd:sequence>
        <xsd:element name="condition" type="tExpression"/>
      </xsd:sequence>
    </xsd:extension>
  </xsd:complexContent>
</xsd:complexType>
```

Table 10.108 – ErrorEventDefinition XML schema

```
<xsd:element name="errorEventDefinition" type="tErrorEventDefinition" substitutionGroup="eventDefinition"/>
<xsd:complexType name="tErrorEventDefinition">
  <xsd:complexContent>
    <xsd:extension base="tEventDefinition">
      <xsd:attribute name="errorRef" type="xsd:QName"/>
    </xsd:extension>
  </xsd:complexContent>
</xsd:complexType>
```

Table 10.109 – EscalationEventDefinition XML schema

```
<xsd:element name="escalationEventDefinition" type="tEscalationEventDefinition"
  substitutionGroup="eventDefinition"/>
<xsd:complexType name="tEscalationEventDefinition">
  <xsd:complexContent>
    <xsd:extension base="tEventDefinition">
      <xsd:attribute name="escalationRef" type="xsd:QName"/>
    </xsd:extension>
  </xsd:complexContent>
</xsd:complexType>
```

Table 10.110 – Event XML schema

```
<xsd:element name="event" type="tEvent" substitutionGroup="flowElement"/>
<xsd:complexType name="tEvent" abstract="true">
  <xsd:complexContent>
    <xsd:extension base="tFlowNode"/>
  </xsd:complexContent>
</xsd:complexType>
```

Table 10.111 – EventDefinition XML schema

```
<xsd:element name="eventDefinition" type="tEventDefinition"/>
<xsd:complexType name="tEventDefinition" abstract="true">
  <xsd:complexContent>
    <xsd:extension base="tBaseElement"/>
  </xsd:complexContent>
</xsd:complexType>
```

Table 10.112 – ImplicitThrowEvent XML schema

```
<xsd:element name="implicitThrowEvent" type="tImplicitThrowEvent" substitutionGroup="flowElement"/>
<xsd:complexType name="tImplicitThrowEvent">
  <xsd:complexContent>
    <xsd:extension base="tThrowEvent"/>
  </xsd:complexContent>
</xsd:complexType>
```

Table 10.113 – IntermediateCatchEvent XML schema

```
<xsd:element name="intermediateCatchEvent" type="tIntermediateCatchEvent" substitutionGroup="flowElement"/>
<xsd:complexType name="tIntermediateCatchEvent">
  <xsd:complexContent>
    <xsd:extension base="tCatchEvent"/>
  </xsd:complexContent>
</xsd:complexType>
```

Table 10.114 – IntermediateThrowEvent XML schema

```
<xsd:element name="intermediateThrowEvent" type="tIntermediateThrowEvent" substitutionGroup="flowElement"/>
<xsd:complexType name="tIntermediateThrowEvent">
  <xsd:complexContent>
    <xsd:extension base="tThrowEvent"/>
  </xsd:complexContent>
</xsd:complexType>
```

Table 10.115 – LinkEventDefinition XML schema

```
<xsd:element name="linkEventDefinition" type="tLinkEventDefinition" substitutionGroup="eventDefinition"/>
<xsd:complexType name="tLinkEventDefinition">
```

```

<xsd:complexContent>
  <xsd:extension base="tEventDefinition">
    <xsd:sequence>
      <xsd:element name="source" type="xsd:QName" minOccurs="0" maxOccurs="unbounded"/>
      <xsd:element name="target" type="xsd:QName" minOccurs="0" maxOccurs="1"/>
    </xsd:sequence>
    <xsd:attribute name="name" type="xsd:string" use="required"/>
  </xsd:extension>
</xsd:complexContent>
</xsd:complexType>

```

Table 10.116 – MessageEventDefinition XML schema

```

<xsd:element name="messageEventDefinition" type="tMessageEventDefinition" substitutionGroup="eventDefinition"/>
<xsd:complexType name="tMessageEventDefinition">
  <xsd:complexContent>
    <xsd:extension base="tEventDefinition">
      <xsd:sequence>
        <xsd:element name="operationRef" type="xsd:QName" minOccurs="0" maxOccurs="1"/>
      </xsd:sequence>
      <xsd:attribute name="messageRef" type="xsd:QName"/>
    </xsd:extension>
  </xsd:complexContent>
</xsd:complexType>

```

Table 10.117 – Signal XML schema

```

<xsd:element name="signal" type="tSignal" substitutionGroup="reusableElement"/>
<xsd:complexType name="tSignal">
  <xsd:complexContent>
    <xsd:extension base="tRootElement">
      <xsd:attribute name="name" type="xsd:string"/>
      <xsd:attribute name="structureRef" type="xsd:QName"/>
    </xsd:extension>
  </xsd:complexContent>
</xsd:complexType>

```

Table 10.118 – SignalEventDefinition XML schema

```

<xsd:element name="signalEventDefinition" type="tSignalEventDefinition" substitutionGroup="eventDefinition"/>
<xsd:complexType name="tSignalEventDefinition">
  <xsd:complexContent>
    <xsd:extension base="tEventDefinition">
      <xsd:attribute name="signalRef" type="xsd:QName"/>
    </xsd:extension>
  </xsd:complexContent>
</xsd:complexType>

```

Table 10.119 – StartEvent XML schema

```

<xsd:element name="startEvent" type="tStartEvent" substitutionGroup="flowElement"/>
<xsd:complexType name="tStartEvent">
  <xsd:complexContent>
    <xsd:extension base="tCatchEvent">
      <xsd:attribute name="isInterrupting" type="xsd:boolean" default="true"/>
    </xsd:extension>
  </xsd:complexContent>
</xsd:complexType>

```

Table 10.120 – TerminateEventDefinition XML schema

```

<xsd:element name="terminateEventDefinition" type="tTerminateEventDefinition" substitutionGroup="eventDefinition"/>
<xsd:complexType name="tTerminateEventDefinition">
  <xsd:complexContent>
    <xsd:extension base="tEventDefinition"/>
  </xsd:complexContent>
</xsd:complexType>

```

Table 10.121 – ThrowEvent XML schema

```

<xsd:element name="throwEvent" type="tThrowEvent"/>
<xsd:complexType name="tThrowEvent" abstract="true">
  <xsd:complexContent>
    <xsd:extension base="tEvent">
      <xsd:sequence>
        <xsd:element ref="dataInput" minOccurs="0" maxOccurs="unbounded"/>
        <xsd:element ref="dataInputAssociation" minOccurs="0" maxOccurs="unbounded"/>
        <xsd:element ref="inputSet" minOccurs="0" maxOccurs="1"/>
        <xsd:element ref="eventDefinition" minOccurs="0" maxOccurs="unbounded"/>
        <xsd:element name="eventDefinitionRef" type="xsd:QName" minOccurs="0" maxOccurs="unbounded"/>
      </xsd:sequence>
    </xsd:extension>
  </xsd:complexContent>
</xsd:complexType>

```

Table 10.122 – TimerEventDefinition XML schema

```

<xsd:element name="timerEventDefinition" type="tTimerEventDefinition" substitutionGroup="eventDefinition"/>
<xsd:complexType name="tTimerEventDefinition">
  <xsd:complexContent>
    <xsd:extension base="tEventDefinition">
      <xsd:choice>
        <xsd:element name="timeDate" type="tExpression" minOccurs="0" maxOccurs="1"/>
        <xsd:element name="timeDuration" type="tExpression" minOccurs="0" maxOccurs="1"/>
        <xsd:element name="timeCycle" type="tExpression" minOccurs="0" maxOccurs="1"/>
      </xsd:choice>
    </xsd:extension>
  </xsd:complexContent>
</xsd:complexType>

```

```
</xsd:complexContent>  
</xsd:complexType>
```

10.6 Gateways

Gateways are used to control how **Sequence Flows** interact as they converge and diverge within a **Process**. If the flow does not need to be controlled, then a **Gateway** is not needed. The term “Gateway” implies that there is a gating mechanism that either allows or disallows passage through the **Gateway**. As *tokens* arrive at a **Gateway** they can be merged together on input and/or split apart on output as the **Gateway** mechanisms are invoked.

A **Gateway** is a diamond, which has been used in many flow chart notations for exclusive branching and is familiar to most modelers.

- ◆ A **Gateway** is a diamond that **MUST** be drawn with a single thin line (see Figure 10.102).

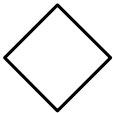

Figure 10.102 – A Gateway

- ◆ The use of text, color, size, and lines for a **Gateway** **MUST** follow the rules defined in “Use of Text, Color, Size, and Lines in a Diagram” on page 39 with the exception that:

Gateways, like **Activities**, are capable of consuming or generating additional *tokens*, effectively controlling the execution semantics of a given **Process**. The main difference is that **Gateways** do not represent ‘work’ being done and they are considered to have zero effect on the operational measures of the **Process** being executed (cost, time, etc.).

Gateways can define all the types of **Business Process Sequence Flow** behavior: Decisions/branching (exclusive, inclusive, and complex), merging, forking, and joining. Thus, while the diamond has been used traditionally for exclusive decisions, **BPMN** extends the behavior of the diamonds to reflect any type of **Sequence Flow** control. Each type of **Gateway** will have an internal indicator or marker to show the type of **Gateway** that is being used (see Figure 10.103).

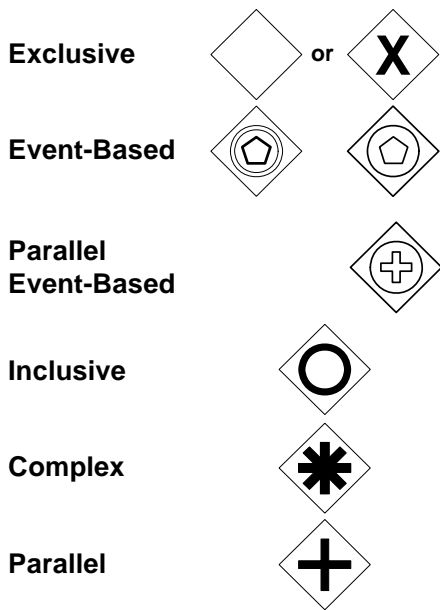

Figure 10.103 – The Different types of Gateways

The **Gateway** controls the flow of both diverging and converging **Sequence Flows**. That is, a single **Gateway** could have multiple input and multiple output flows. Modelers and modeling tools might want to enforce a best practice of a **Gateway** only performing one of these functions. Thus, it would take two sequential **Gateways** to first converge and then to diverge the **Sequence Flows**.

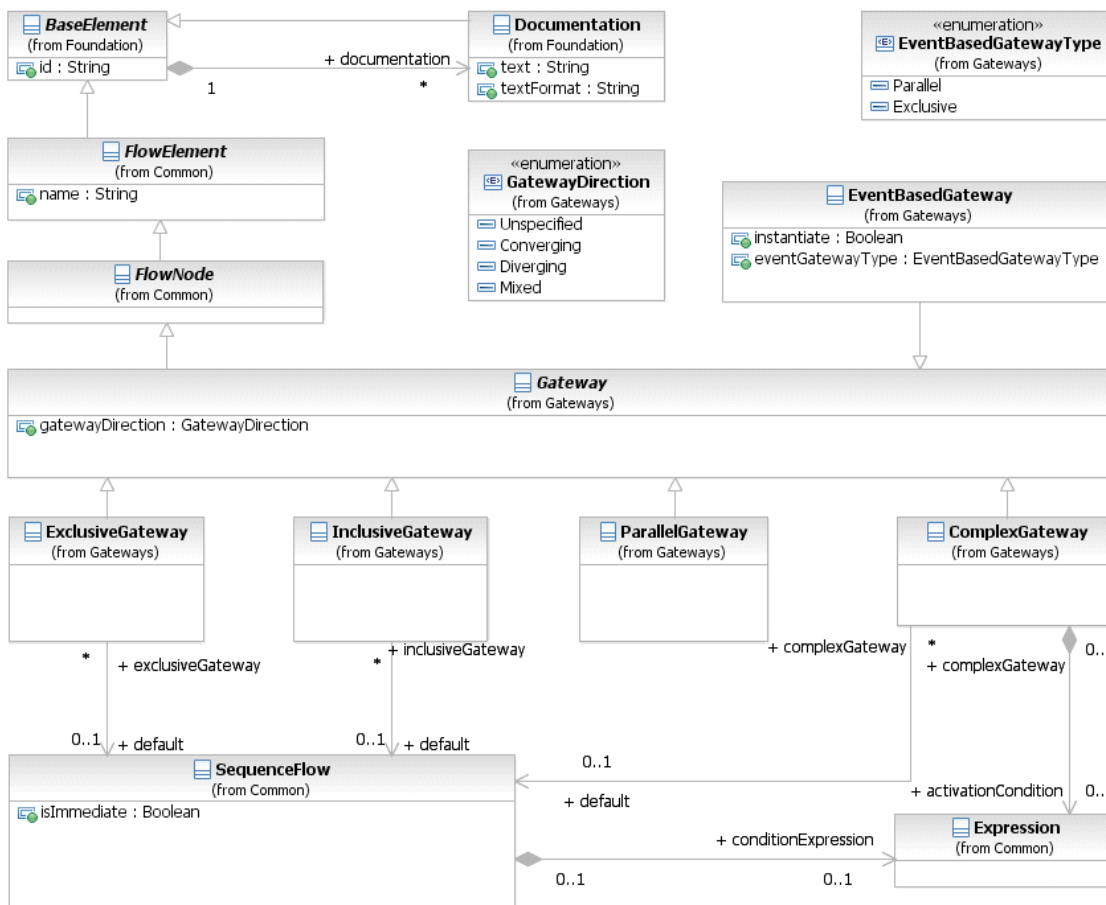

Figure 10.104 – Gateway class diagram

Gateways are described in this sub clause on an abstract level. The execution semantics of **Gateways** is detailed on page 434.

10.6.1 Sequence Flow Considerations

NOTE: Although the shape of a **Gateway** is a diamond, it is not a requirement that *incoming* and *outgoing* **Sequence Flows** **MUST** connect to the corners of the diamond. **Sequence Flows** can connect to any position on the boundary of the **Gateway** shape.

This sub clause applies to all **Gateways**. Additional **Sequence Flow** Connection rules are specified for each type of **Gateway** in the sub clauses below.

- ◆ A **Gateway** **MAY** be a target for a **Sequence Flow**. It can have zero (0), one (1), or more *incoming* **Sequence Flows**.
- ◆ If the **Gateway** does not have an *incoming* **Sequence Flow**, and there is no **Start Event** for the **Process**, then the **Gateway's** divergence behavior, depending on the type of **Gateway** (see below), **SHALL** be performed when the **Process** is instantiated.

- ◆ A **Gateway** MAY be a source of a **Sequence Flow**; it can have zero, one, or more *outgoing Sequence Flows*.
- ◆ A **Gateway** MUST have either multiple *incoming Sequence Flows* or multiple *outgoing Sequence Flows* (i.e., it MUST merge or split the flow).
 - ◆ A **Gateway** with a *gatewayDirection* of unspecified MAY have both multiple *incoming* and *outgoing Sequence Flows*.
 - ◆ A **Gateway** with a *gatewayDirection* of mixed MUST have both multiple *incoming* and *outgoing Sequence Flows*.
 - ◆ A **Gateway** with a *gatewayDirection* of converging MUST have multiple *incoming Sequence Flows*, but MUST NOT have multiple *outgoing Sequence Flows*.
 - ◆ A **Gateway** with a *gatewayDirection* of diverging MUST have multiple *outgoing Sequence Flows*, but MUST NOT have multiple *incoming Sequence Flows*.

10.6.2 Exclusive Gateway

A diverging **Exclusive Gateway (Decision)** is used to create alternative paths within a **Process** flow. This is basically the “diversion point in the road” for a **Process**. For a given *instance* of the **Process**, only one of the paths can be taken.

A Decision can be thought of as a question that is asked at a particular point in the **Process**. The question has a defined set of alternative answers. Each answer is associated with a condition *Expression* that is associated with a **Gateway’s outgoing Sequence Flows**.

- ◆ The **Exclusive Gateway** MAY use a marker that is shaped like an “X” and is placed within the **Gateway** diamond (see Figure 10.106) to distinguish it from other **Gateways**. This marker is NOT REQUIRED (see Figure 10.105).
- ◆ A diagram SHOULD be consistent in the use of the “X” internal indicator. That is, a diagram SHOULD NOT have some **Gateways** with an indicator and other **Gateways** without an indicator.

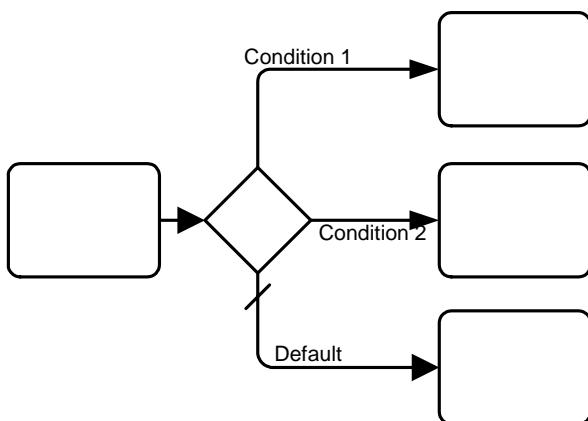

Figure 10.105 – An Exclusive Data-Based Decision (Gateway) Example without the Internal Indicator

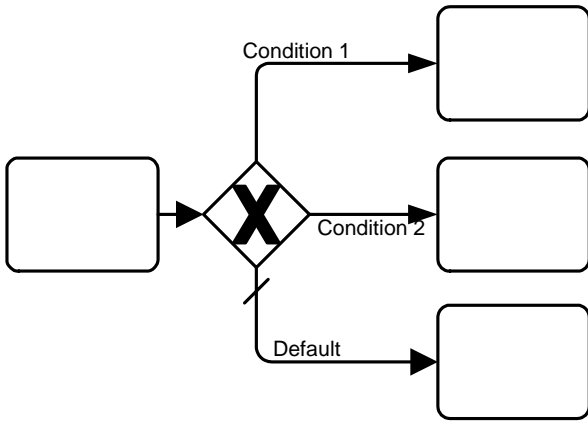

Figure 10.106 – A Data-Based Exclusive Decision (Gateway) Example with the Internal Indicator

NOTE: as a modeling preference, the **Exclusive Gateways** shown in examples within this document will be shown without the internal indicator.

A default path can optionally be identified, to be taken in the event that none of the conditional Expressions evaluate to *true*. If a default path is not specified and the **Process** is executed such that none of the conditional Expressions evaluates to *true*, a runtime exception occurs.

A converging **Exclusive Gateway** is used to merge alternative paths. Each *incoming Sequence Flow token* is routed to the *outgoing Sequence Flow* without synchronization.

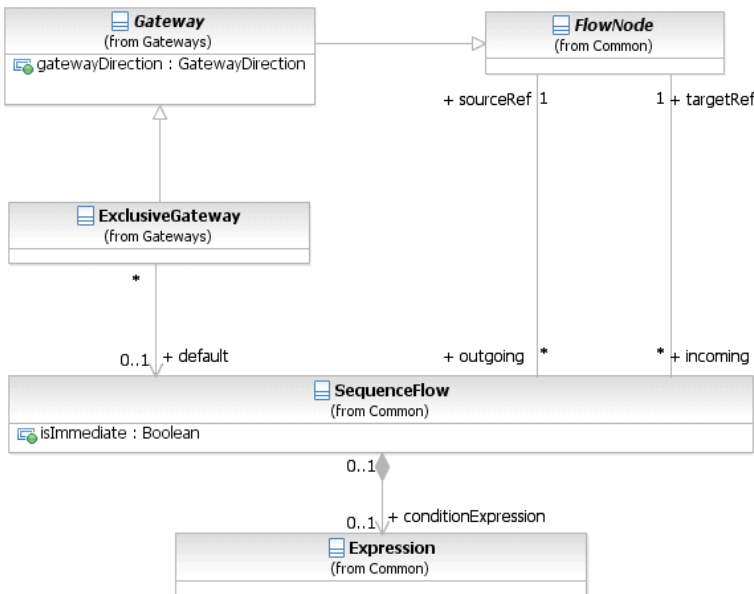

Figure 10.107 – Exclusive Gateway class diagram

The **Exclusive Gateway** element inherits the attributes and model associations of **Gateway** (see Table 8.46). Table 10.123 presents the additional attributes and model associations of the **Exclusive Gateway** element.

Table 10.123 – ExclusiveGateway Attributes & Model Associations

Attribute Name	Description/Usage
default: SequenceFlow [0..1]	The Sequence Flow that will receive a <i>token</i> when none of the <i>conditionExpressions</i> on other <i>outgoing Sequence Flows</i> evaluate to <i>true</i> . The <i>default Sequence Flow</i> should not have a <i>conditionExpression</i> . Any such <i>Expression</i> SHALL be ignored.

10.6.3 Inclusive Gateway

A diverging **Inclusive Gateway** (Inclusive Decision) can be used to create alternative but also parallel paths within a **Process** flow. Unlike the **Exclusive Gateway**, all condition Expressions are evaluated. The *true* evaluation of one condition Expression does not exclude the evaluation of other condition Expressions. All **Sequence Flows** with a *true* evaluation will be traversed by a *token*. Since each path is considered to be independent, all combinations of the paths **MAY** be taken, from zero to all. However, it should be designed so that at least one path is taken.

- ◆ The **Inclusive Gateway** **MUST** use a marker that is in the shape of a circle or an “O” and is placed within the **Gateway** diamond (see Figure 10.108) to distinguish it from other **Gateways**.

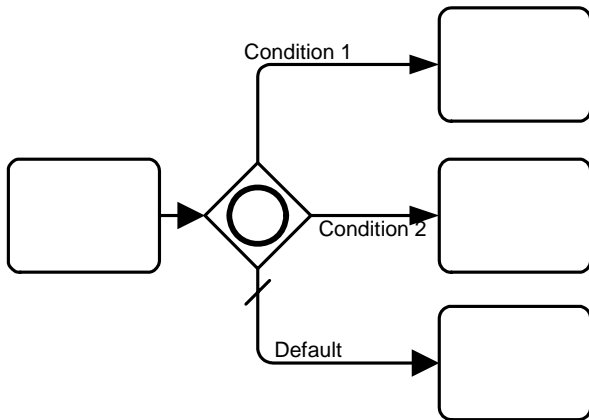

Figure 10.108 – An example using an Inclusive Gateway

A default path can optionally be identified, to be taken in the event that none of the conditional Expressions evaluate to *true*. If a default path is not specified and the **Process** is executed such that none of the conditional Expressions evaluates to *true*, a runtime exception occurs.

A converging **Inclusive Gateway** is used to merge a combination of alternative and parallel paths. A control flow *token* arriving at an **Inclusive Gateway** **MAY** be synchronized with some other *tokens* that arrive later at this **Gateway**. The precise synchronization behavior of the **Inclusive Gateway** can be found on page 291.

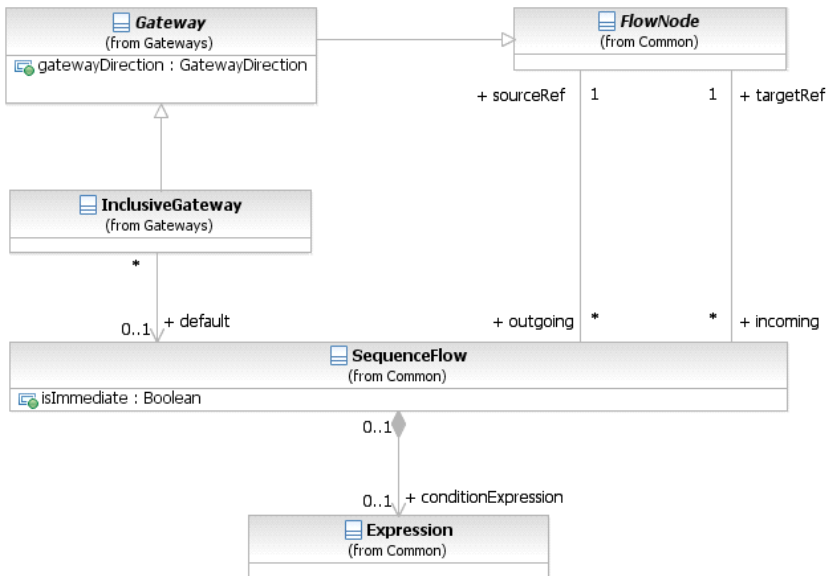

Figure 10.109 – Inclusive Gateway class diagram

The **Inclusive Gateway** element inherits the attributes and model associations of **Gateway** (see Table 8.46). Table 10.124 presents the additional attributes and model associations of the **Inclusive Gateway** element.

Table 10.124 – InclusiveGateway Attributes & Model Associations

Attribute Name	Description/Usage
default: SequenceFlow [0..1]	The Sequence Flow that will receive a <i>token</i> when none of the conditionExpressions on other Sequence Flows evaluate to <i>true</i> . The <i>default Sequence Flow</i> should not have a conditionExpression . Any such Expression SHALL be ignored.

10.6.4 Parallel Gateway

A **Parallel Gateway** is used to synchronize (combine) parallel flows and to create parallel flows.

- ◆ The **Parallel Gateway** MUST use a marker that is in the shape of a plus sign and is placed within the **Gateway** diamond (see Figure 10.110) to distinguish it from other **Gateways**.

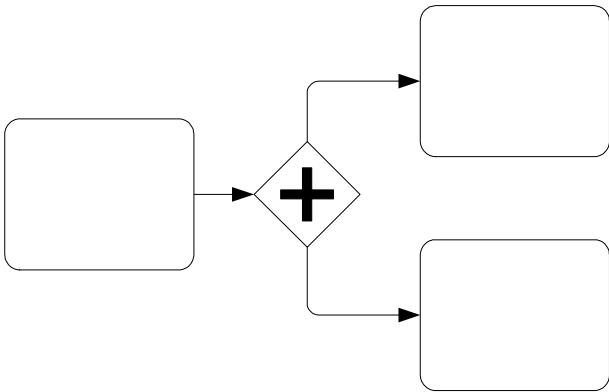

Figure 10.110 – An example using an Parallel Gateway

Parallel Gateways are used for synchronizing parallel flow (see Figure 10.111).

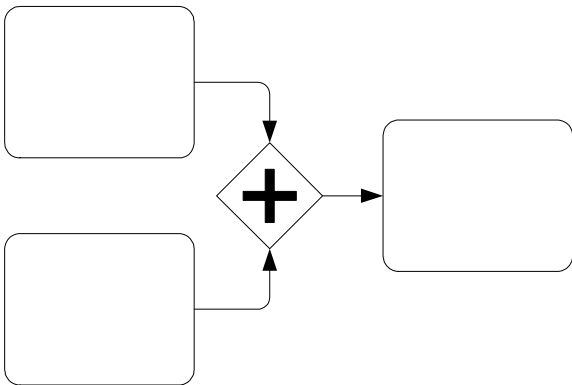

Figure 10.111 – An example of a synchronizing Parallel Gateway

A **Parallel Gateway** creates parallel paths without checking any conditions; each *outgoing Sequence Flow* receives a *token* upon execution of this **Gateway**. For *incoming* flows, the **Parallel Gateway** will wait for all *incoming* flows before triggering the flow through its *outgoing Sequence Flows*.

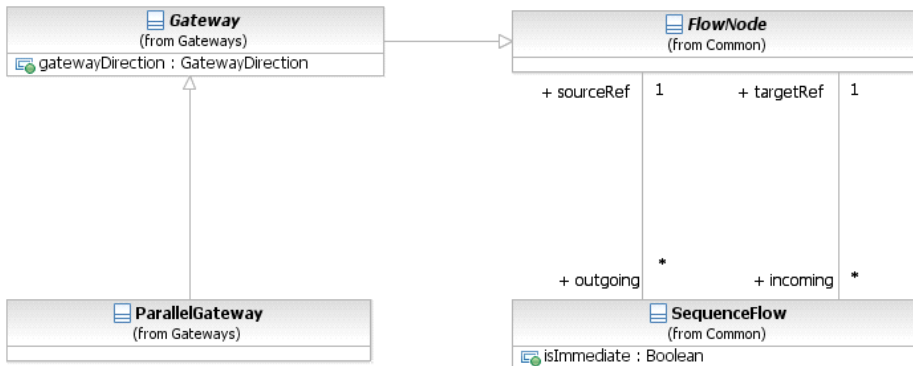

Figure 10.112 – Parallel Gateway class diagram

The **Parallel Gateway** element inherits the attributes and model associations of **Gateway** (see Table 8.46), but adds no additional attributes or model associations.

10.6.5 Complex Gateway

The **Complex Gateway** can be used to model complex synchronization behavior. An *Expression* activationCondition is used to describe the precise behavior. For example, this *Expression* could specify that *tokens* on three out of five *incoming Sequence Flows* are needed to activate the **Gateway**. What *tokens* are produced by the **Gateway** is determined by conditions on the *outgoing Sequence Flows* as in the split behavior of the **Inclusive Gateway**. If *tokens* arrive later on the two remaining *Sequence Flows*, those *tokens* cause a reset of the **Gateway** and new *token* can be produced on the *outgoing Sequence Flows*. To determine whether it needs to wait for additional *tokens* before it can reset, the **Gateway** uses the synchronization semantics of the **Inclusive Gateway**.

- ◆ The **Complex Gateway** MUST use a marker that is in the shape of an asterisk and is placed within the **Gateway** diamond (see Figure 10.113) to distinguish it from other **Gateways**.

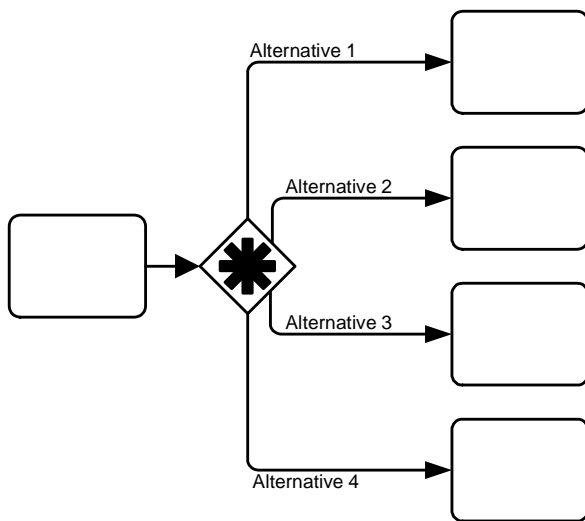

Figure 10.113 – An example using a Complex Gateway

The **Complex Gateway** has, in contrast to other **Gateways**, an internal state, which is represented by the boolean *instance* attribute `waitingForStart`, which is initially *true* and becomes *false* after activation. This attribute can be used in the conditions of the *outgoing Sequence Flows* to specify where *tokens* are produced upon activation and where *tokens* are produced upon reset. It is RECOMMENDED that each *outgoing Sequence Flow* either get a *token* upon activation or upon reset but not both. At least one *outgoing Sequence Flow* should receive a *token* upon activation but a *token* MUST NOT be produced upon reset.

Figure 10.114 shows the class diagram for the **Complex Gateway**.

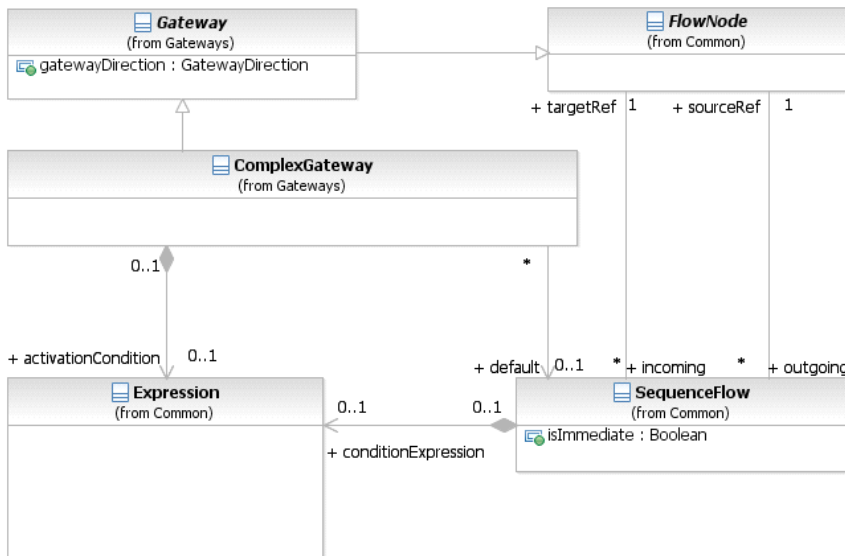

Figure 10.114 – Complex Gateway class diagram

The **Complex Gateway** element inherits the attributes and model associations of **Gateway** (see Table 8.46). Table 10.125 presents the additional model associations of the **Complex Gateway** element.

Table 10.125 – Complex Gateway model associations

Attribute Name	Description/Usage
activationCondition : Expression [0..1]	Determines which combination of <i>incoming tokens</i> will be synchronized for activation of the Gateway .
default : SequenceFlow [0..1]	The Sequence Flow that will receive a <i>token</i> when none of the <i>conditionExpressions</i> on other Sequence Flows evaluate to <i>true</i> . The <i>default Sequence Flow</i> should not have a <i>conditionExpression</i> . Any such Expression SHALL be ignored.

Table 10.126 – Instance attributes related to the Complex Gateway

Attribute Name	Description/Usage
activationCount: integer	Refers at runtime to the number of <i>tokens</i> that are present on an <i>incoming Sequence Flow</i> of the Complex Gateway .
waitingForStart: boolean = true	Represents the internal state of the Complex Gateway . It is either waiting for start (=true) or waiting for reset (=false).

10.6.6 Event-Based Gateway

The **Event-Based Gateway** represents a branching point in the **Process** where the alternative paths that follow the **Gateway** are based on **Events** that occur, rather than the evaluation of **Expressions** using **Process** data (as with an **Exclusive** or **Inclusive Gateway**). A specific **Event**, usually the receipt of a **Message**, determines the path that will be taken. Basically, the *decision* is made by another *Participant*, based on data that is not visible to **Process**, thus, requiring the use of the **Event-Based Gateway**.

For example, if a company is waiting for a response from a customer they will perform one set of **Activities** if the customer responds “Yes” and another set of **Activities** if the customer responds “No.” The customer’s response determines which path is taken. The identity of the **Message** determines which path is taken. That is, the “Yes” **Message** and the “No” **Message** are different **Messages**—i.e., they are not the same **Message** with different values within a property of the **Message**. The receipt of the **Message** can be modeled with an **Intermediate Event** with a **Message trigger** or a **Receive Task**. In addition to **Messages**, other *triggers* for **Intermediate Events** can be used, such as Timers.

The **Event Gateway** shares the same basic shape of the **Gateways**, a diamond, with a marker placed within the diamond to indicate variations of the **Gateway**.

- ◆ An **Event Gateway** is a diamond that **MUST** be drawn with a single thin line.
- ◆ The use of text, color, size, and lines for an **Event Gateway** **MUST** follow the rules defined in “Use of Text, Color, Size, and Lines in a Diagram” on page 39.
- ◆ The marker for the **Event Gateway** **MUST** look like a *catch Multiple Intermediate Event* (see Figure 10.115).



Figure 10.115 – Event-Based Gateway

Unlike other **Gateways**, the behavior of the **Event Gateway** is determined by a configuration of elements, rather than the single **Gateway**.

- ◆ An **Event Gateway** **MUST** have two or more *outgoing Sequence Flows*.
- ◆ The *outgoing Sequence Flows* of the **Event Gateway** **MUST NOT** have a `conditionExpression`.

The objects that are on the target end of the **Gateway's outgoing Sequence Flows** are part of the configuration of the **Gateway**.

- ◆ **Event-Based Gateways** are configured by having *outgoing Sequence Flows* target an **Intermediate Event** or a **Receive Task** in any combination (see Figure 10.116 and Figure 10.117) except that:
 - ◆ If **Message Intermediate Events** are used in the configuration, then **Receive Tasks** MUST NOT be used in that configuration and vice versa.
 - ◆ **Receive Tasks** used in an **Event Gateway** configuration MUST NOT have any attached **Intermediate Events**.
 - ◆ Only the following **Intermediate Event triggers** are valid: Message, Signal, Timer, Conditional, and Multiple (which can only include the previous *triggers*). Thus, the following **Intermediate Event triggers** are not valid: Error, Cancel, Compensation, and Link.
- ◆ Target elements in an **Event Gateway** configuration MUST NOT have any additional *incoming Sequence Flows* (other than that from the **Event Gateway**).

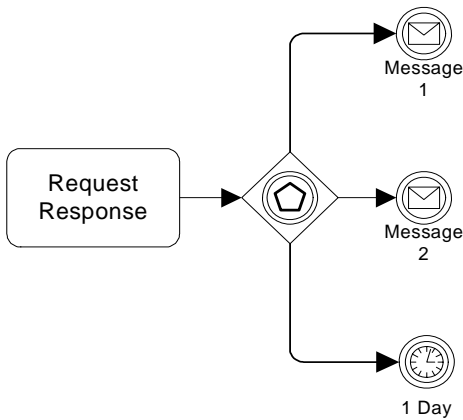

Figure 10.116 – An Event-Based Gateway example using Message Intermediate Events

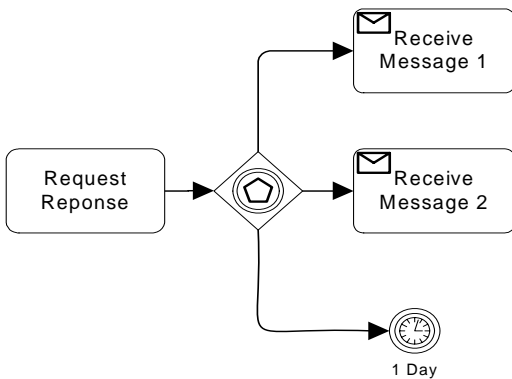

Figure 10.117 – An Event-Based Gateway example using Receive Tasks

When the first **Event** in the **Event Gateway** configuration is triggered, then the path that follows that **Event** will be used (a *token* will be sent down the **Event's** outgoing **Sequence Flows**). All the remaining paths of the **Event Gateway** configuration will no longer be valid. Basically, the **Event Gateway** configuration is a race condition where the first **Event** that is triggered wins.

There are variations of the **Event Gateway** that can be used at the start of the **Process**. The behavior and marker of the **Gateway** will change.

Event Gateways can be used to instantiate a **Process**. By default the **Gateway's** `instantiate` attribute is *false*, but if set to *true*, then the **Process** is instantiated when the first **Event** of the **Gateway's** configuration is triggered.

- ◆ If the **Event Gateway's** `instantiate` attribute is set to *true*, then the marker for the **Event Gateway** looks like a **Multiple Start Event** (see Figure 10.118).



Figure 10.118 – Exclusive Event-Based Gateway to start a Process

In order for an **Event Gateway** to instantiate a **Process**, it **MUST** not have any *incoming* **Sequence Flows**.

In some situations a modeler might want the **Process** to be instantiated by one of a set of **Messages** while still requiring all of the **Messages** for the working of the same **Process instance**. To handle this, there is another variation of the **Event Gateway**.

- ◆ If the **Event Gateway's** `instantiate` attribute is set to *true* and the `eventGatewayType` attribute is set to `Parallel`, then the marker for the **Event Gateway** looks like a **Parallel Multiple Start Event** (see Figure 10.119).
- ◆ The **Event Gateway's** `instantiate` attribute **MUST** be set to *true* in order for the `eventGatewayType` attribute to be set to `Parallel` (i.e., for **Event Gateway's** that do not instantiate the **Process** **MUST** be `Exclusive`—a standard **Parallel Gateway** can be used to include parallel **Events** in the middle of a **Process**).



Figure 10.119 – Parallel Event-Based Gateway to start a Process

The **Parallel Event Gateway** is also a type of race condition. In this case, however, when the first **Event** is triggered and the **Process** is instantiated, the other **Events** of the **Gateway** configuration are not disabled. The other **Events** are still waiting and are expected to be triggered before the **Process** can (normally) complete. In this case, the **Messages** that trigger the **Events** of the **Gateway** configuration **MUST** share the same correlation information.

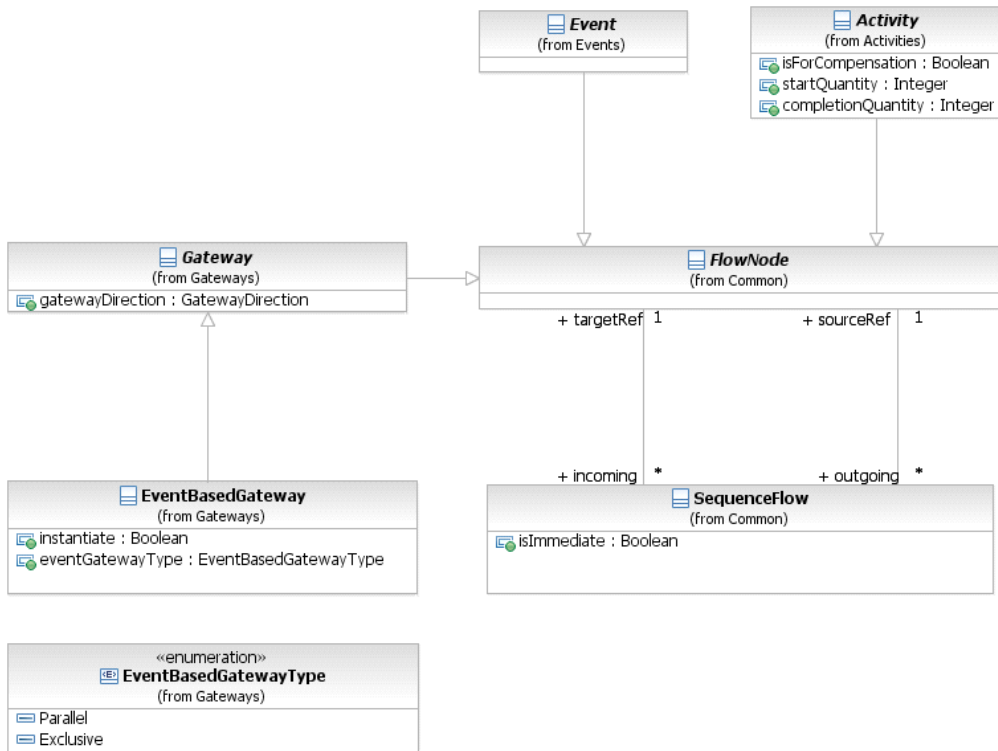

Figure 10.120 – Event-Based Gateway class diagram

The **Event-Based Gateway** element inherits the attributes and model associations of **Gateway** (see Table 8.46). Table 10.127 presents the additional attributes and model associations of the **Event-Based Gateway** element.

Table 10.127 – EventBasedGateway Attributes & Model Associations

Attribute Name	Description/Usage
instantiate: boolean = false	When <i>true</i> , receipt of one of the Events will instantiate the Process instance.
eventGatewayType: EventGatewayType = Exclusive { Exclusive Parallel }	The eventGatewayType determines the behavior of the Gateway when used to instantiate a Process (as described above). The attribute can only be set to <code>parallel</code> when the <code>instantiate</code> attribute is set to <i>true</i> .

Event-Based Gateways can be used at the start of a **Process**, without having to be a target of **Sequence Flows**. There can be multiple such **Event-Based Gateways** at the start of a **Process**. Ordinary **Start Events** and **Event-Based Gateways** can be used together.

10.6.7 Gateway Package XML Schemas

Table 10.128 – ComplexGateway XML schema

```
<xsd:element name="complexGateway" type="tComplexGateway" substitutionGroup="flowElement"/>
<xsd:complexType name="tComplexGateway">
  <xsd:complexContent>
    <xsd:extension base="tGateway">
      <xsd:sequence>
        <xsd:element name="activationCondition" type="tExpression" minOccurs="0" maxOccurs="1"/>
      </xsd:sequence>
      <xsd:attribute name="default" type="xsd:IDREF"/>
    </xsd:extension>
  </xsd:complexContent>
</xsd:complexType>
```

Table 10.129 – EventBasedGateway XML schema

```
<xsd:element name="eventBasedGateway" type="tEventBasedGateway" substitutionGroup="flowElement"/>
<xsd:complexType name="tEventBasedGateway">
  <xsd:complexContent>
    <xsd:extension base="tGateway">
      <xsd:attribute name="instantiate" type="xsd:boolean" default="false"/>
      <xsd:attribute name="eventGatewayType" type="tEventBasedGatewayType" default="Exclusive"/>
    </xsd:extension>
  </xsd:complexContent>
</xsd:complexType>

<xsd:simpleType name="tEventBasedGatewayType">
  <xsd:restriction base="xsd:string">
    <xsd:enumeration value="Exclusive"/>
    <xsd:enumeration value="Parallel"/>
  </xsd:restriction>
</xsd:simpleType>
```

Table 10.130 – ExclusiveGateway XML schema

```
<xsd:element name="exclusiveGateway" type="tExclusiveGateway" substitutionGroup="flowElement"/>
<xsd:complexType name="tExclusiveGateway">
  <xsd:complexContent>
    <xsd:extension base="tGateway">
      <xsd:attribute name="default" type="xsd:IDREF" use="optional"/>
    </xsd:extension>
  </xsd:complexContent>
</xsd:complexType>
```

Table 10.131 – Gateway XML schema

```
<xsd:element name="gateway" type="tGateway" abstract="true"/>
<xsd:complexType name="tGateway">
  <xsd:complexContent>
    <xsd:extension base="tFlowElement">
      <xsd:attribute name="gatewayDirection" type="tGatewayDirection" default="Unspecified"/>
    </xsd:extension>
  </xsd:complexContent>
</xsd:complexType>
```

```

</xsd:complexContent>
</xsd:complexType>

<xsd:simpleType name="tGatewayDirection">
  <xsd:restriction base="xsd:string">
    <xsd:enumeration value="Unspecified"/>
    <xsd:enumeration value="Converging"/>
    <xsd:enumeration value="Diverging"/>
    <xsd:enumeration value="Mixed"/>
  </xsd:restriction>
</xsd:simpleType>

```

Table 10.132 – InclusiveGateway XML schema

```

<xsd:element name="inclusiveGateway" type="tInclusiveGateway" substitutionGroup="flowElement"/>
<xsd:complexType name="tInclusiveGateway">
  <xsd:complexContent>
    <xsd:extension base="tGateway">
      <xsd:attribute name="default" type="xsd:IDREF" use="optional"/>
    </xsd:extension>
  </xsd:complexContent>
</xsd:complexType>

```

Table 10.133 – ParallelGateway XML schema

```

<xsd:element name="parallelGateway" type="tParallelGateway" substitutionGroup="flowElement"/>
<xsd:complexType name="tParallelGateway">
  <xsd:complexContent>
    <xsd:extension base="tGateway"/>
  </xsd:complexContent>
</xsd:complexType>

```

10.7 Compensation

Compensation is concerned with undoing steps that were already successfully completed, because their results and possibly side effects are no longer desired and need to be reversed. If an **Activity** is still active, it cannot be compensated, but rather needs to be canceled. Cancellation in turn can result in *compensation* of already successfully completed portions of an active **Activity**, in case of a **Sub-Process**.

Compensation is performed by a *compensation handler*. A *compensation handler* performs the steps necessary to reverse the effects of an **Activity**. In case of a **Sub-Process**, the *compensation handler* has access to **Sub-Process** data at the time of its completion (“snapshot data”).

Compensation is triggered by a *throw Compensation Event*, which typically will be raised by an *error handler*, as part of cancellation, or recursively by another *compensation handler*. That **Event** specifies the **Activity** for which *compensation* is to be performed, either explicitly or implicitly.

10.7.1 Compensation Handler

A *compensation handler* is a set of **Activities** that are not connected to other portions of the **BPMN** model. The *compensation handler* starts with a *catch Compensation Event*. That *catch Compensation Event* either is a boundary **Event**, or, in case of a **Compensation Event Sub-Process**, the *handler's Start Event*.

A *compensation handler* connected via a boundary **Event** can only perform “black-box” *compensation* of the original **Activity**. This *compensation* is modeled with a specialized **Compensation Activity**, which is connected to the boundary **Event** through an **Association** (see Figure 10.121). The **Compensation Activity**, which can be either a **Task** or a **Sub-Process**, has a marker to show that it is used for *compensation* only and is outside the *normal flow* of the **Process**.

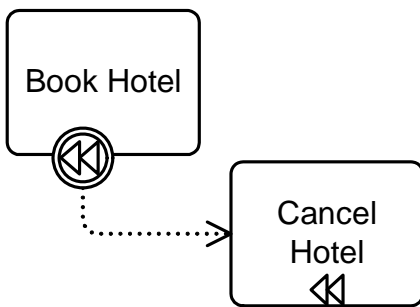

Figure 10.121– *Compensation* through a boundary **Event**

A **Compensation Event Sub-Process** is contained within a **Process** or a **Sub-Process** (see Figure 10.122). Like the **Compensation Activity**, the **Compensation Event Sub-Process** is outside the *normal flow* of the **Process**. The **Event Sub-Process**, which is marked with a dotted line boundary, can access data that is part of its parent, a snapshot at the point in time when its parent completed. A **Compensation Event Sub-Process** can recursively trigger *compensation* for **Activities** contained in its parent.

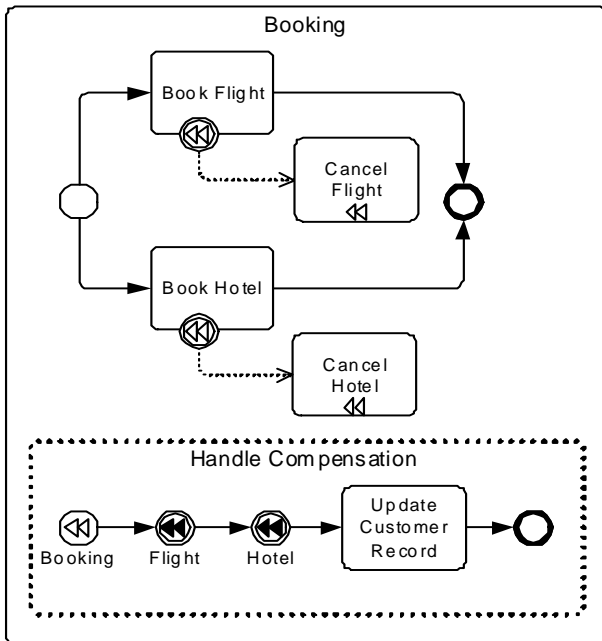

Figure 10.122 – Monitoring Class Diagram

It is possible to specify that a **Sub-Process** can be compensated without having to define the *compensation handler*. The **Sub-Process** attribute `compensable`, when set, specifies that default *compensation* is implicitly defined, which recursively compensates all successfully completed **Activities** within that **Sub-Process**.

The example in 10.122, above contains a custom **Compensation Event Sub-Process**, triggered by a **Compensation Start Event**. Note that this *compensation handler* deviates from default *compensation* in that it runs **Compensation Activities** in an order different from the order in the forward case; it also contains an additional **Activity** adding **Process** logic that cannot be derived from the body of the **Sub-Process** itself.

10.7.2 Compensation Triggering

Compensation is triggered using a *compensation throw Event*, which can either be an **Intermediate** or an **End Event**. The **Activity** that needs to be compensated is referenced. If the **Activity** is clear from the context, it doesn't have to be specified and defaults to the current **Activity**. A typical scenario for that is an inline *error handler* of a **Sub-Process** that cannot recover the *error*, and as a result would trigger *compensation* for that **Sub-Process**. If no **Activity** is specified in a "global" context, all completed **Activities** in the **Process** are compensated.

By default, *compensation* is triggered synchronously, that is, the *compensation throw Event* waits for the completion of the triggered *compensation handler*. Alternatively, *compensation* can just be triggered without waiting for its completion, by setting the *throw Compensation Event's* `waitForCompletion` attribute to *false*.

Multiple *instances* typically exist for **Loop** or **Multi-Instance Sub-Processes**. Each of these has its own *instance* of its **Compensation Event Sub-Process**, which has access to the specific snapshot data that was current at the time of completion of that particular *instance*. Triggering *compensation* for the **Multi-Instance Sub-Process** individually

triggers *compensation* for all *instances* within the current *scope*. If *compensation* is specified via a boundary *compensation handler*, this boundary *compensation handler* also is invoked once for each *instance* of the **Multi-Instance Sub-Process** in the current *scope*.

10.7.3 Relationship between Error Handling and Compensation

The following items define the relationship between *error handling* and *compensation*:

- *Compensation* employs a “presumed abort principle,” with the following consequences: *Compensation* of a failed **Activity** results in a null operation.
- When an **Activity** fails, i.e., is left because an *error* has been thrown, it’s the *error handlers* responsibility to ensure that no further *compensation* will be necessary once the *error handler* has completed.
- If no *error Event Sub-Process* is specified for a particular **Sub-Process** and a particular *error*, the default behavior is to automatically call *compensation* for all contained **Activities** of that **Sub-Process** if that *error* is thrown, ensuring the behavior for *auditing* and *monitoring*.

10.8 Lanes

A **Lane** is a sub-partition within a **Process** (often within a **Pool**) and will extend the entire length of the **Process** level, either vertically (see Figure 10.122) or horizontally (see Figure 10.123). Text associated with the **Lane** (e.g., its name and/or that of any **Process** element attribute) can be placed inside the shape, in any direction or location, depending on the preference of the modeler or modeling tool vendor. Our examples place the name as a banner on the left side (for horizontal **Pools**) or at the top (for vertical **Pools**) on the other side of the line that separates the **Pool** name, however, this is not a requirement.

- ◆ A **Lane** is a square-cornered rectangle that **MUST** be drawn with a solid single line (see Figure 10.123 and Figure 10.124).
- ◆ The label for the **Lane** **MAY** be placed in any location and direction within the **Lane**, but **MUST NOT** be separated from the contents of the **Lane** by a single line (except in the case that there are sub-**Lanes** within the **Lane**).

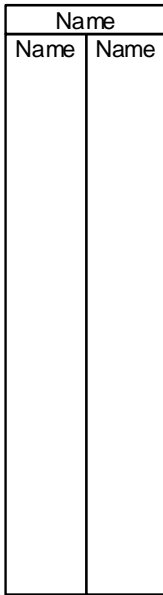

Figure 10.123 – Two Lanes in a Vertical Pool



Figure 10.124 – Two Lanes in a horizontal Pool

Lanes are used to organize and categorize **Activities** within a **Pool**. The meaning of the **Lanes** is up to the modeler. **BPMN** does not specify the usage of **Lanes**. **Lanes** are often used for such things as internal roles (e.g., Manager, Associate), systems (e.g., an enterprise application), an internal department (e.g., shipping, finance), etc. In addition, **Lanes** can be nested (see Figure 10.125) or defined in a matrix. For example, there could be an outer set of **Lanes** for company departments and then an inner set of **Lanes** for roles within each department.

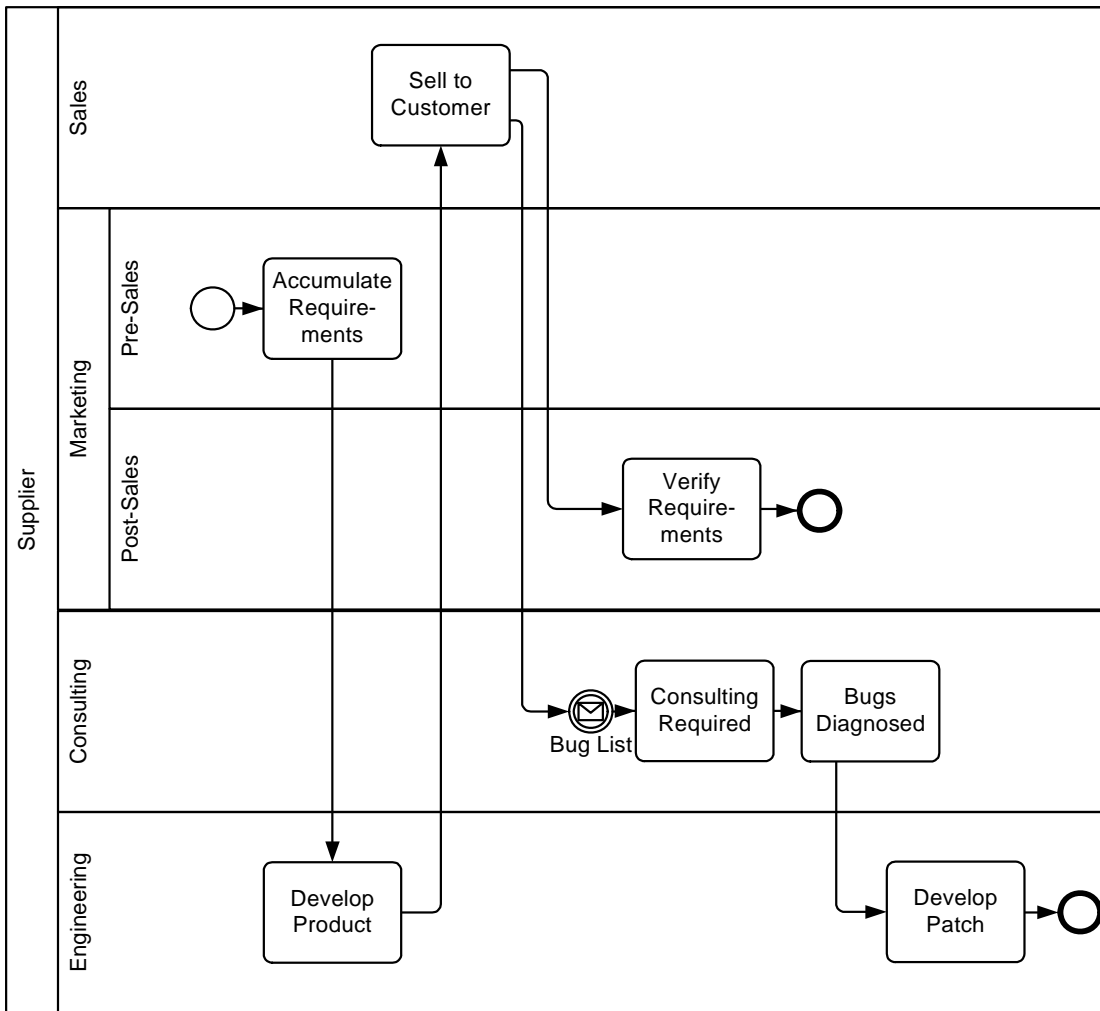

Figure 10.125 – An Example of Nested Lanes

Figure 10.126 shows the **Lane** class diagram. When a **Lane** is defined it is contained within a LaneSet, which is contained within a **Process**.

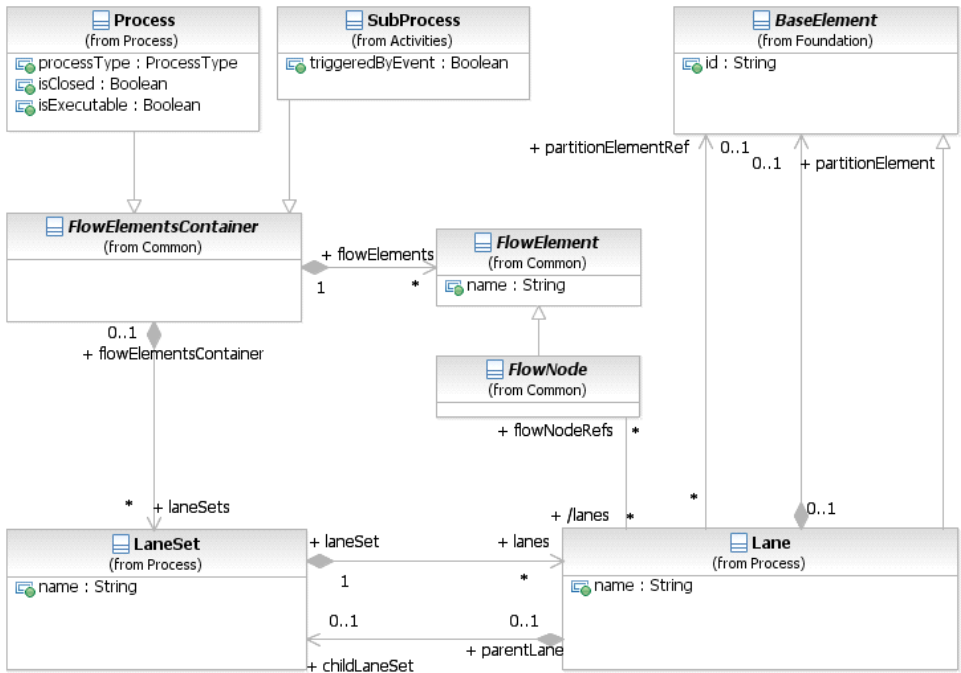

Figure 10.126 – The Lane class diagram

The LaneSet element defines the container for one or more **Lanes**. A **Process** can contain one or more LaneSets. Each LaneSet and its **Lanes** can partition the *Flow Nodes* in a different way.

The LaneSet element inherits the attributes and model associations of BaseElement (see Table 8.5). Table 10.134 presents the additional attributes and model associations of the LaneSet element.

Table 10.134 – LaneSet attributes and model associations

Attribute Name	Description/Usage
name: sting [0..1]	The name of the LaneSet. A LaneSet is not visually displayed on a BPMN diagram. Consequently, the name of the LaneSet is not displayed as well.
process: Process	The Process owning the LaneSet
lanes: Lane [0..*]	One or more Lane elements, which define a specific partition in the LaneSet.
parentLane: Lane [0..1]	The reference to a Lane element which is the parent of this LaneSet.

A **Lane** element defines one specific partition in a LaneSet. The **Lane** can define a partition element that specifies the value and element type, a tool can use to determine the list of *Flow Nodes* to be partitioned into this **Lane**. All **Lanes** in a single LaneSet **MUST** define partition element of the same type, e.g., all **Lanes** in a LaneSet reference a Resource as the partition element, but each Lane references a different Resource instance.

The **Lane** element inherits the attributes and model associations of BaseElement (see Table 8.5). Table 10.135 presents the additional attributes and model associations of the **Lane** element.

Table 10.135 – Lane attributes and model associations

Attribute Name	Description/Usage
name: string	The name of the Lane
partitionElement: BaseElement [0..1]	A reference to a BaseElement that specifies the partition value and partition type. Using this partition element a BPMN compliant tool can determine the FlowElements that have to be partitioned in this Lane .
partitionElementRef: BaseElement [0..1]	A reference to a BaseElement that specifies the partition value and partition type. Using this partition element a BPMN compliant tool can determine the FlowElements that have to be partitioned in this Lane .
childLaneSet: LaneSet [0..1]	A reference to a LaneSet element for embedded Lanes .
flowNodeRefs: FlowNode [0..*]	The list of FlowNodes partitioned into this Lane according to the partitionElement defined as part of the Lane element.

10.9 Process Instances, Unmodeled Activities, and Public Processes

A **Process** can be executed or performed many times, but each time is expected to follow the steps laid out in the **Process** model. For example, the **Process** in Figure 10.1 will occur every Friday, but each *instance* is expected to perform **Task** “Receive Issue List,” then **Task** “Review Issue List,” and so on, as specified in the model. Each *instance* of a **Process** is expected to be valid for the model, but some *instances* might not, for example if the **Process** has manual **Activities**, and the performers have not had proper instruction on how to carry out the **Process**.

In some applications it is useful to allow more **Activities** and **Events** to occur when a **Process** is executed or performed than are contained in the **Process** model. This enables other steps to be taken as needed without changing the **Process**. For example, *instances* of the **Process** in Figure 10.1 might execute or perform an extra **Activity** between **Task** “Receive Issue List” and **Task** “Review Issue List.” These *instances* are still valid for the **Process** model in Figure 10.1, because the *instances* still execute or perform the **Activities** in the **Process**, in the order they are modeled and under conditions specified for them.

There are two ways to specify whether unmodeled **Activities** are allowed to occur in **Process instances**:

- If the `isClosed` attribute of a **Process** has a value of *false* or no value, then interactions, such as sending and receiving **Messages** and **Events**, **MAY** occur in an *instance* without additional flow elements in the **Process**. Unmodeled interactions can still be restricted on particular **Sequence Flow** in the **Process** (see next bullet). If the `isClosed` attribute of a **Process** has a value of *true*, then interactions, such as sending and receiving **Messages** and **Events**, **MAY NOT** occur without additional flow elements in the **Process**. This restriction overrides any unmodeled interactions allowed by **Sequence Flows** in the next bullet.
- If the `isImmediate` attribute of a **Sequence Flow** in a **Process** has a value of *false*, then other **Activities** and interactions not modeled in the **Process** **MAY** be executed or performed during the **Sequence Flow**. If the `isImmediate` attribute has a value of *true*, then **Activities** and interactions not modeled in the **Process** **MAY NOT** be executed or performed during **Sequence Flow**. In *non-executable Processes* (`isExecutable` attribute has value *false*, or defaults to *false*), **Sequence Flows** with no value for `isImmediate` are treated as if the

value were *false*. In *executable Processes* (`isExecutable` attribute has value `true`, or defaults to `true`), **Sequence Flows** with no value for `isImmediate` are treated as if the value were *true*. *Executable Processes* cannot have a *false* value for the `isImmediate` attribute.

Restrictions on unmodeled **Activities** specified with `isClosed` and `isImmediate` apply only under executions or performances (*instances*) of the **Process** containing the restriction. These **Activities** MAY occur in *instances* of other **Processes**.

When a **Process** allows **Activities** to occur that the **Process** does not model, those **Activities** might appear in other **Process** models. The executions or performances (*instances*) of these other **Processes** might be valid for the original **Process**. For example, a **Process** might be defined similar to the one in Figure 10.1 that adds an extra **Activity** between **Task** “Receive Issue List” and **Task** “Review Issue List.” The **Process** in Figure 10.1 might use `isClosed` or `isImmediate` to allow other **Activities** to occur in between **Task** “Receive Issue List” and **Task** “Review Issue List.” When the **Process** is executed or performed, then *instances* of the other **Process** (the one with the extra step in between **Task** “Receive Issue List” and **Task** “Review Issue List”) will be valid for the **Process** in Figure 10.1. Modelers can declare that they intend all *instances* of one **Process** will be valid for another **Process** using the supports association between the **Processes**. During development of these **Processes**, support might not actually hold, because the association just expresses modeler intent.

A common use for model support is between *private* and *public Processes*, see “Overview” (page 21). A *public Process* contains **Activities** visible to external parties, such as *Participants* in a **Collaboration**, while a *private Process* includes other **Activities** that are not visible to external parties. The hidden **Activities** in a *private Process* are not modeled in the *public Process*. However, it is expected that *instances* of the *private Process* will appear to external parties as if they could be *instances* of the *public Process*. This means the *private Process* supports the *public Process* (it is expected that all *instances* of the *private Process* will be valid for the *public* one).

A **Process** that supports another, as a *private Process* can to a *public Process*, does not need to be entirely similar to the other **Process**. It is only REQUIRED that *instances* of the **Process** appear as if they could be *instance* of the other **Process**. For example Figure 10.127 shows a *public Process* at the top with a **Send Task** and **Receive Task**. A supporting *private Process* is shown at the bottom. The *private Process* sends and receives the same **Messages**, but using **Events** instead of **Tasks**. It also introduces **Activities** not modeled in the *public Process*. However all *instances* of the *private Process* will appear as if they could be *instances* of the *public* one, because the **Messages** are sent and received in the order REQUIRED by the *public Process*, and the *public Process* allows unmodeled **Activities** to occur.

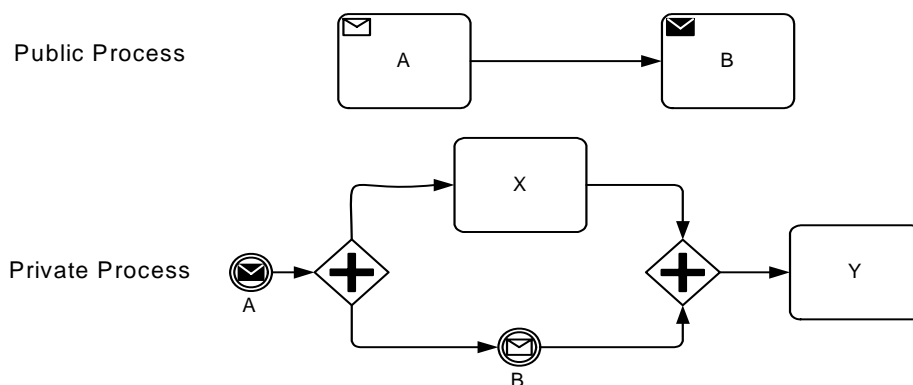

Figure 10.127 – One Process supporting to another

In practice, a *public* **Process** looks like an underspecified *private* **Process**. Anything not specified in the *public* **Process** is determined by the *private* one. For example, if none of the *outgoing* **Sequence Flows** for an **Exclusive Gateway** have `conditionExpressions`, the *private* **Process** will determine which one of the **Activities** targeted by the **Sequence Flows** will occur. Another example is a **Timer Event** with no `EventDefinition`. The *private* **Process** will determine when the timer goes off.

10.10 Auditing

The `Auditing` element and its model associations allow defining attributes related to auditing. It leverages the **BPMN** extensibility mechanism. This element is used by `FlowElements` and **Process**. The actual definition of auditing attributes is out of scope of this International Standard. **BPMN 2.0** implementations can define their own set of attributes and their intended semantics.

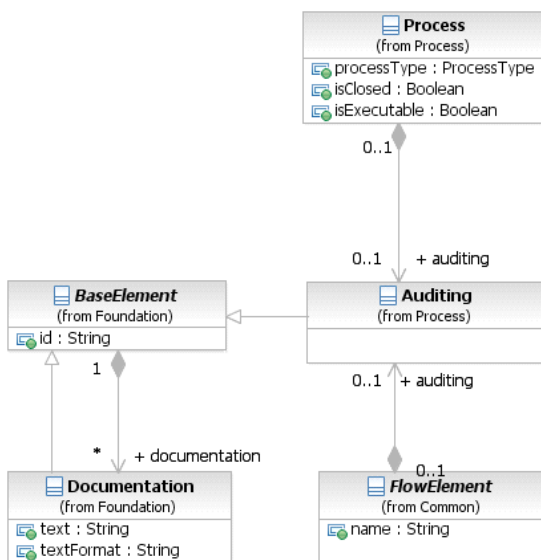

Figure 10.128 – Auditing Class Diagram

10.11 Monitoring

The `Monitoring` and its model associations allow defining attributes related to monitoring. It leverages the **BPMN** extensibility mechanism. This element is used by `FlowElements` and **Process**. The actual definition of monitoring attributes is out of scope of this International Standard. **BPMN 2.0.1** implementations can define their own set of attributes and their intended semantics.

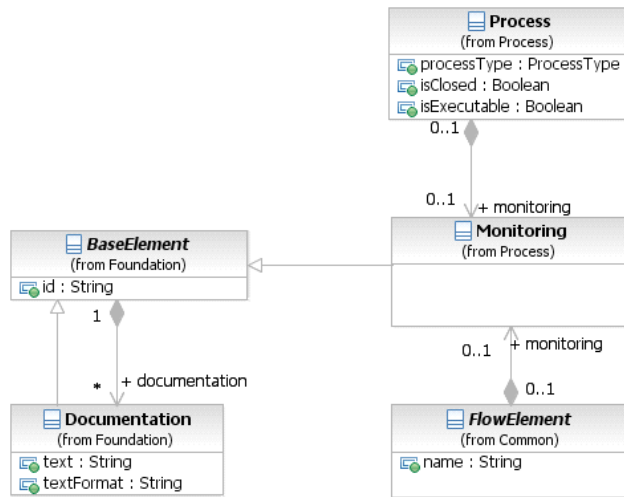

Figure 10.129 – Monitoring Class Diagram

10.12 Process Package XML Schemas

Table 10.136 – Process XML schema

```

<xsd:element name="process" type="tProcess" substitutionGroup="rootElement"/>
<xsd:complexType name="tProcess">
  <xsd:complexContent>
    <xsd:extension base="tCallableElement">
      <xsd:sequence>
        <xsd:element ref="auditing" minOccurs="0" maxOccurs="1"/>
        <xsd:element ref="monitoring" minOccurs="0" maxOccurs="1"/>
        <xsd:element ref="processRole" minOccurs="0" maxOccurs="unbounded"/>
        <xsd:element ref="property" minOccurs="0" maxOccurs="unbounded"/>
        <xsd:element ref="laneSet" minOccurs="0" maxOccurs="unbounded"/>
        <xsd:element ref="flowElement" minOccurs="0" maxOccurs="unbounded"/>
        <xsd:element ref="artifact" minOccurs="0" maxOccurs="unbounded"/>
        <xsd:element ref="resourceRole" minOccurs="0" maxOccurs="unbounded"/>
        <xsd:element ref="correlationSubscription" minOccurs="0" maxOccurs="unbounded"/>
        <xsd:element name="supports" type="xsd:QName" minOccurs="0" maxOccurs="unbounded"/>
      </xsd:sequence>
      <xsd:attribute name="processType" type="tProcessType" default="None"/>
      <xsd:attribute name="isExecutable" type="xsd:boolean" use="optional"/>
      <xsd:attribute name="isClosed" type="xsd:boolean" default="false"/>
      <xsd:attribute name="definitionalCollaborationRef" type="xsd:QName" use="optional"/>
    </xsd:extension>
  </xsd:complexContent>
</xsd:complexType>
<xsd:simpleType name="tProcessType">
  <xsd:restriction base="xsd:string">
    <xsd:enumeration value="None"/>
    <xsd:enumeration value="Public"/>
    <xsd:enumeration value="Private"/>
  </xsd:restriction>
</xsd:simpleType>
  
```

Table 10.137 – Auditing XML schema

```
<xsd:element name="auditing" type="tAuditing"/>
<xsd:complexType name="tAuditing">
  <xsd:complexContent>
    <xsd:extension base="tBaseElement"/>
  </xsd:complexContent>
</xsd:complexType>
```

Table 10.138 – GlobalTask XML schema

```
<xsd:element name="globalTask" type="tGlobalTask" substitutionGroup="rootElement"/>
<xsd:complexType name="tGlobalTask">
  <xsd:complexContent>
    <xsd:extension base="tCallableElement">
      <xsd:sequence>
        <xsd:element ref="resourceRole" minOccurs="0" maxOccurs="unbounded"/>
      </xsd:sequence>
    </xsd:extension>
  </xsd:complexContent>
</xsd:complexType>
```

Table 10.139 – Lane XML schema

```
<xsd:element name="lane" type="tLane"/>
<xsd:complexType name="tLane">
  <xsd:complexContent>
    <xsd:extension base="tBaseElement">
      <xsd:sequence>
        <xsd:element name="partitionElement" type="tBaseElement" minOccurs="0" maxOccurs="1"/>
        <xsd:element name="flowNodeRef" type="xsd:IDREF" minOccurs="0" maxOccurs="unbounded"/>
        <xsd:element name="childLaneSet" type="tLaneSet" minOccurs="0" maxOccurs="1"/>
      </xsd:sequence>
      <xsd:attribute name="name" type="xsd:string"/>
      <xsd:attribute name="partitionElementRef" type="xsd:QName"/>
    </xsd:extension>
  </xsd:complexContent>
</xsd:complexType>
```

Table 10.140 – LaneSet XML schema

```
<xsd:element name="laneSet" type="tLaneSet"/>
<xsd:complexType name="tLaneSet">
  <xsd:complexContent>
    <xsd:extension base="tBaseElement">
      <xsd:sequence>
        <xsd:element ref="lane" minOccurs="0" maxOccurs="unbounded"/>
      </xsd:sequence>
      <xsd:attribute name="name" type="xsd:string"/>
    </xsd:extension>
  </xsd:complexContent>
</xsd:complexType>
```

Table 10.141– Monitoring XML schema

```
<xsd:element name="monitoring" type="tMonitoring"/>
<xsd:complexType name="tMonitoring">
  <xsd:complexContent>
    <xsd:extension base="tBaseElement"/>
  </xsd:complexContent>
</xsd:complexType>
```

Table 10.142 – Performer XML schema

```
<xsd:element name="performer" type="tPerformer" substitutionGroup="resourceRole"/>
<xsd:complexType name="tPerformer">
  <xsd:complexContent>
    <xsd:extension base="tResourceRole"/>
  </xsd:complexContent>
</xsd:complexType>
```

11 Choreography

11.1 General

NOTE: The content of this clause is REQUIRED for **BPMN Choreography Modeling Conformance** or for **BPMN Complete Conformance**. However, this clause is NOT REQUIRED for **BPMN Process Modeling Conformance**, **BPMN Process Execution Conformance**, or **BPMN BPEL Process Execution Conformance**. For more information about **BPMN** conformance types, see page 1.

A **Choreography** is a type of process, but differs in purpose and behavior from a standard **BPMN Process**. A standard **Process**, or an *Orchestration Process* (see page 143), is more familiar to most process modelers and defines the flow of **Activities** of a specific **PartnerEntity** or organization. In contrast, **Choreography** formalizes the way business *Participants* coordinate their interactions. The focus is not on orchestrations of the work performed *within* these *Participants*, but rather on the exchange of information (**Messages**) *between* these *Participants*.

Another way to look at Choreography is to view it as a type of business contract between two or more organizations.

This entails **Message** (document) exchanges in an orderly fashion: e.g., first a retailer sends a purchase order request to a supplier; next the supplier either confirms or rejects intention to investigate the order; then supplier proceeds to investigate stock for line-items and seeks outside suppliers if necessary; accordingly the supplier sends a confirmation or rejection back; during this period the retailer can send requests to vary the order, etc.

Message exchanges between partners go beyond simple request-response interactions into multi-cast, contingent requests, competing receives, streaming, and other service interaction patterns (REF for SIP). Moreover, they cluster around distinct scenarios such as: creation of sales orders; assignment of carriers of shipments involving different sales orders; managing the “red tape” of crossing customs and quarantine; processing payment and investigating exceptions. A **Choreography** is a definition of expected behavior, basically a procedural business contract, between interacting *Participants* (see page 111 for more information on *Participants*). It brings **Message** exchanges and their logical relation as **Conversations** into view. This allows partners to plan their **Business Processes** for inter-operation without introducing conflicts. An example of a conflict could arise if a retailer was allowed to send a variation on a purchase order immediately after sending the initial request. The **Message** exchange sequences in **Choreography** models need to be reflected in the orchestration **Processes** of participants. A **Choreography** model makes it possible to derive the **Process** interfaces of each partner’s **Process** (REF: Decker & Weske, 2007).

To leverage the familiarity of flow charting types of **Process** models, **BPMN Choreographies** also have “activities” that are ordered by **Sequence Flows**. These “activities” consist of one or more *interactions* between *Participants*. These *interactions* are often described as being *message exchange patterns* (MEPs). A MEP is the atomic unit (“**Activity**”) of a **Choreography**.

Some MEPs involve a single **Message** (e.g., a “Customer” requests an “Order” from a “Supplier”). Other MEPs will involve two **Messages** in a request and response format (e.g., a “Supplier” request a “Credit Rating” from a “Financial Institution,” who then returns the “Credit Rating” to the “Supplier”). There can be even more complex MEPs that involve error **Messages**, for example.

A single MEP can be defined as a **BPMN Choreography Task** (see page 323). Thus, a **Choreography** defines the order in which **Choreography Tasks** occur. **Sub-Choreographies** allow the composition/decomposition of **Choreographies**.

Choreographies are designed in **BPMN** to allow stand-alone, scalable models of these *Participant interactions*. However, since **BPMN** provides other **Business Process** modeling views, **Choreographies** are designed to fit within **BPMN Collaboration** diagrams to display the relationship between the **Choreography** and *Orchestration Processes* thus expanding **BPMN 1.2** capabilities (see page 107 for more information on **Collaborations**, and page 361 for **Choreographies** within **Collaborations**).

Figure 11.1 displays the metamodel of the key **BPMN** elements that contribute to **Choreography** modeling. The sub clauses of this clause will describe the characteristics of these elements and how they are used in a **Choreography**.

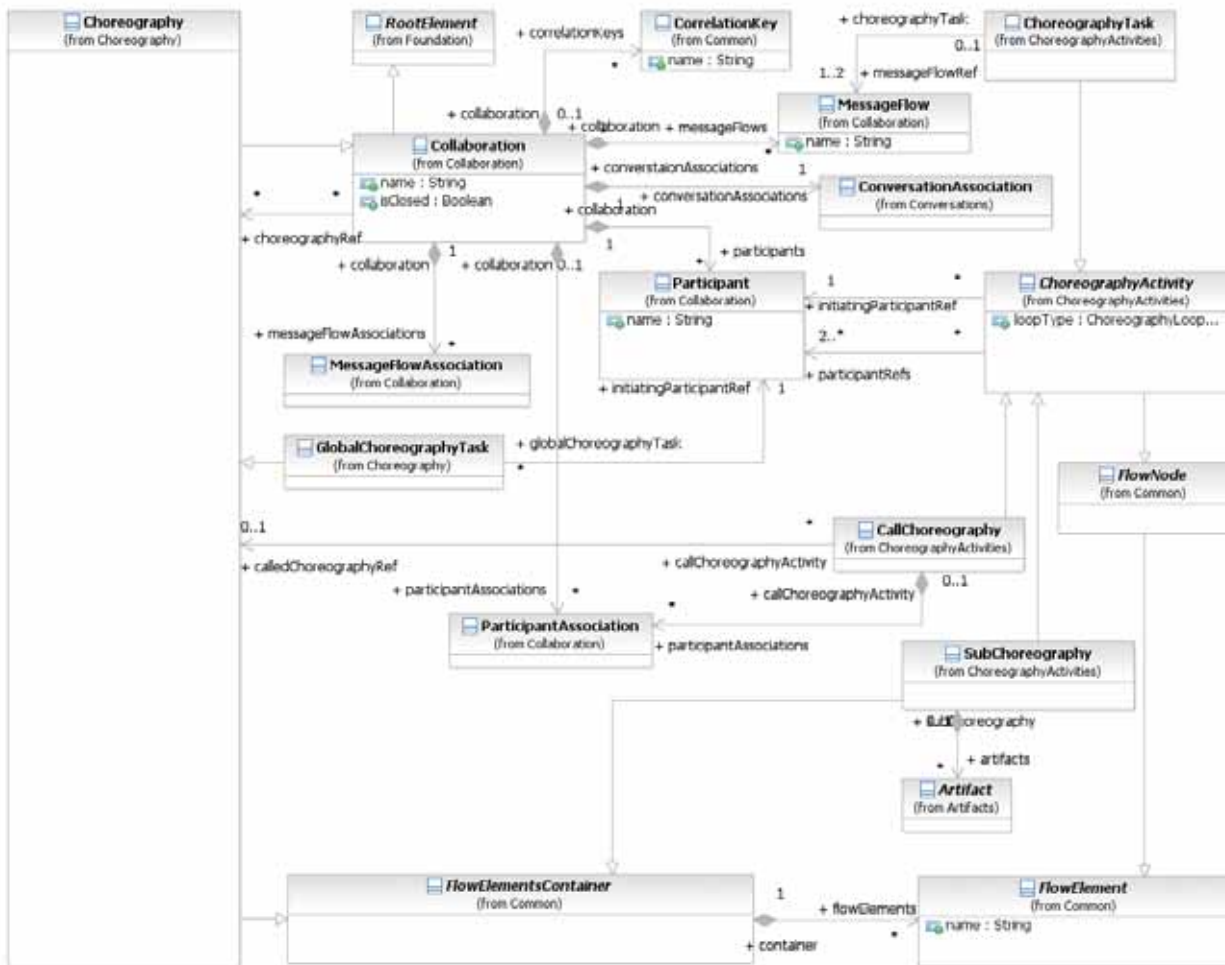

Figure 11.1 – The Choreography metamodel

The **Choreography** element inherits the attributes and model associations of **Collaboration** (see Table 9.1) and of **FlowElementContainer** (see Table 8.45), but does not have any additional attributes or model associations.

NOTE: The **Collaboration** attribute `choreographyRef` is not applicable to **Choreography**.

11.2 Basic Choreography Concepts

A key to understanding **Choreographies** and how they are used in **BPMN** is their relationship to **Pools** (see page 111 for more information on **Pools**). **Choreographies** exist outside of or in between **Pools**. A **Process**, within a **Pool**, represents the work of a specific **PartnerEntity** (e.g., “FedEx”), often substituted by a **PartnerRole** (e.g., “Shipper”) when a **PartnerEntity** is not identified and can be decided later. The **PartnerEntity/PartnerRole** is called a **Participant** in **BPMN**. **Pools** are the graphical representation of **Participants**. A **Choreography**, on the other hand, is a different kind of process. A **Choreography** defines the sequence of *interactions* between **Participants**. Thus, a **Choreography** does not exist in a single **Pool**, it is not the purview of a single **Participant**. Each step in the **Choreography** involves two or more **Participants** (these steps are called **Choreography Activities**, see below). This means that the **Choreography**, in **BPMN** terms, is defined outside of any particular **Pool**.

The key question that needs to be continually asked during the development of a **Choreography** is “what information do the **Participants** in the **Choreography** have?” Basically, each **Participant** can only understand the status of the **Choreography** through observable behavior of the other **Participants**; which are the **Messages** that have been sent and received. If there are only two **Participants** in the **Choreography**, then it is very simple; both **Participants** will be aware of who is responsible for sending the next **Message**. However, if there are more than two **Participants**, then the modeler needs to be careful to sequence the **Choreography Activities** in such a way that the **Participants** know when they are responsible for initiating the *interactions*.

Figure 11.2 presents a sample **Choreography**. The details of **Choreography** behavior and elements will be described in the sub clause below.

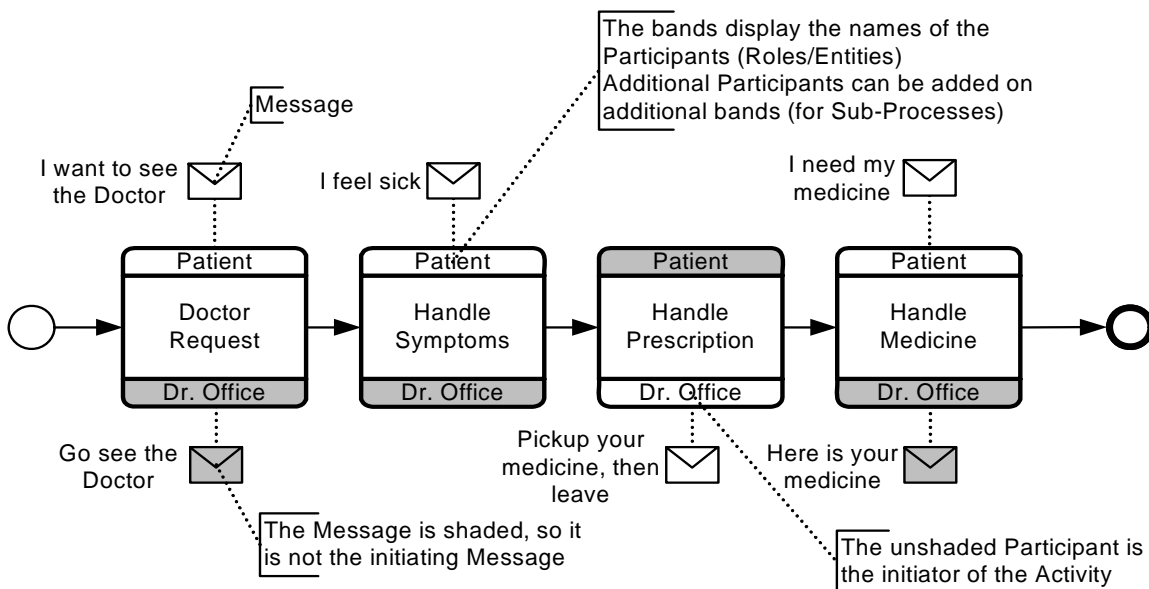

Figure 11.2 – An example of a Choreography

To illustrate the correspondence between **Collaboration** and **Choreography**, consider an example from logistics. Figure 11.3 shows a **Collaboration** where the **Pools** are expanded to reveal orchestration details per participant (for *Shipper, Retailer* etc.). **Message Flows** connect the elements in the different **Pools** related to different participants, indicating **Message** exchanges. For example, a *Planned Order Variations* **Message** is sent by the *Supplier* to the *Retailer*; the corresponding send and receive have been modeled using regular **BPMN** messaging **Activities**. Also, a

number of **Messages** of the same type being sent. For example, a number of *Retailer Order and Delivery Variations Messages* can be sent from the *Retailer* to the *Supplier*, indicated by respective *multi-instances* constructs (for brevity, the actual elements for sending/receiving inside the *multi-instances* construct have been omitted).

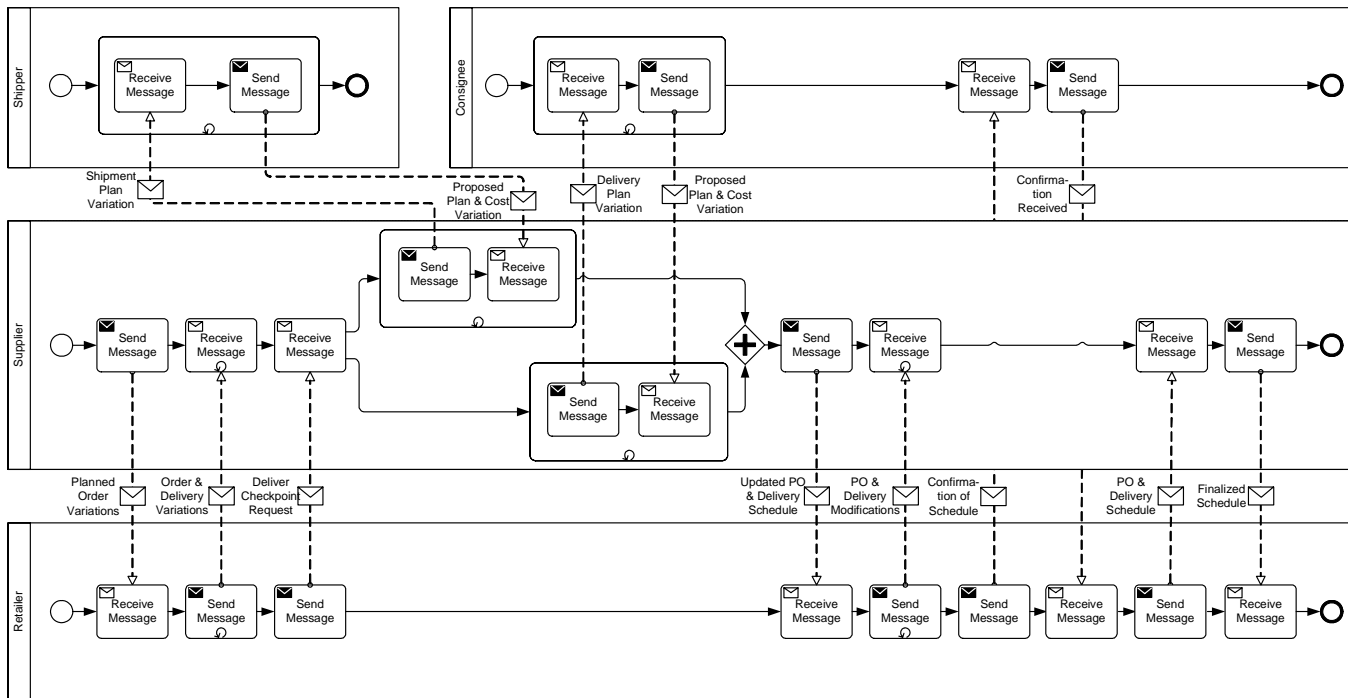

Figure 11.3 – A Collaboration diagram logistics example

The scenario modeled in Figure 11.3 entails shipment planning for the next supply replenishment variations: the *Supplier* confirms all previously accepted variations for delivery with the *Retailer*; the *Retailer* sends back a number of further possible variations; the *Supplier* requests to the *Shipper* and *Consignee* possible changes in delivery; accordingly, the *Retailer* interacts with the *Consignee* and *Supplier* for final confirmations.

A problem with model interconnections for complex **Choreographies** is that they are vulnerable to errors. Interconnections might not be sequenced correctly, since the logic of **Message** exchanges is considered from each partner at a time. This in turn leads to deadlocks. For example, consider the `PartnerRole` of *Retailer* in Figure 11.3 and assume that, by error, the order of *Confirmation Delivery Schedule* and *Retailer Confirmation received* (far right) were swapped. This would result in a deadlock since both *Retailer* and *Consignee* would wait for the other to send a **Message**. Deadlocks in general, however, are not that obvious and might be difficult to recognize in a **Collaboration**.

Figure 11.4 shows the **Choreography** corresponding to the **Collaboration** of Figure 11.3.

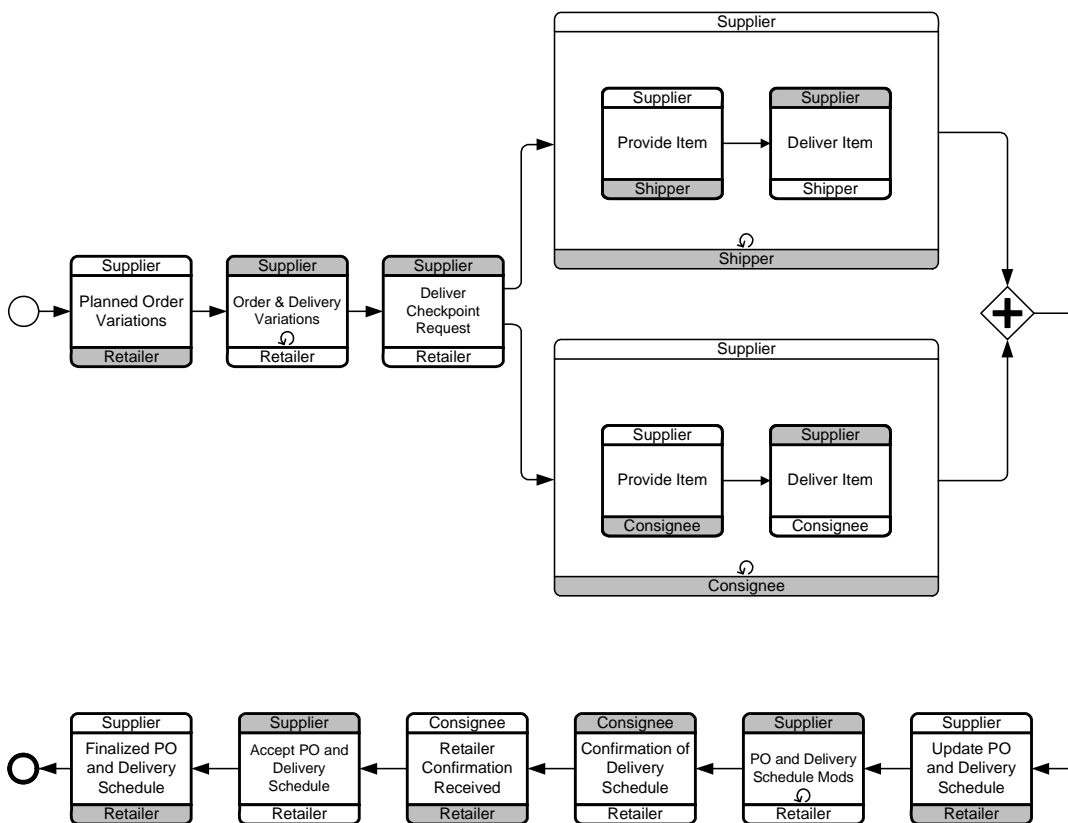

Figure 11.4 – The corresponding Choreography diagram logistics example

11.3 Data

A **Choreography** does not have a central control mechanism and there is no mechanism for maintaining any central **Process (Choreography)** data. Thus, any element in a **Process** that would normally depend on conditional or assignment expressions, would not have any central source for this data to be maintained and understood by all the *Participants* involved in the **Choreography**.

As mentioned above, neither **Data Objects** nor **Repositories** are used in **Choreographies**. Both of these elements are used exclusively in **Processes** and require the concept of a central locus of control. **Data Objects** are basically variables and there would be no central system to manage them. *Data* can be used in *expressions* that are used in **Exclusive Gateways**, but only that data which has been sent through a **Message** in the **Choreography**.

11.4 Use of BPMN Common Elements

Some **BPMN** elements are common to both **Process** and **Choreography** diagrams, as well as **Collaboration**; they are used in these diagrams. The next few sub clauses will describe the use of **Messages**, **Message Flows**, *Participants*, **Sequence Flows**, *Artifacts*, *Correlations*, *Expressions*, and *Services* in **Choreography**.

The key graphical elements of **Gateways** and **Events** are also common to both **Choreography** and **Process**. Since their usage has a large impact, they are described in major sub clauses of this clause (see page 339 for **Events** and page 344 for **Gateways**).

11.4.1 Sequence Flow

Sequence Flows are used within **Choreographies** to show the sequence of the **Choreography Activities**, which can have intervening **Gateways**. They are used in the same way as they are in **Processes**. They are only allowed to connect with other *Flow Objects*. For **Processes**, they can only connect **Events**, **Gateways**, and **Activities**. For **Choreographies**, they can only connect **Events**, **Gateways**, and **Choreography Activities** (see Figure 11.5).

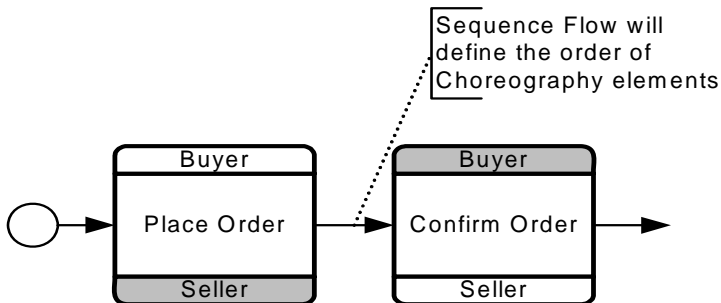

Figure 11.5 – The use of Sequence Flows in a Choreography

There are two additional variations of **Sequence Flows**:

- **Conditional Sequence Flows:** *Conditions* can be added to **Sequence Flows** in two situations:
 - From **Gateways:** *Outgoing Sequence Flows* have *conditions* for **Exclusive** and **Inclusive Gateways**. The data referenced in the *conditions* need to be visible to two or more *Participants* in the **Choreography**. The data becomes visible if it is part of a **Message** that had been sent (previously) within the **Choreography**. See page 344 and page 351 for more information about how **Exclusive** and **Inclusive Gateways** are used in **Choreography**.
 - From **Choreography Activities:** *Outgoing Sequence Flows* MAY have *conditions* for **Choreography Activities**. Since these act similar to **Inclusive Gateways**, the **Conditional Sequence Flows** can be used in **Choreographies**. The *conditions* have the same restrictions that apply to the visibility of the data for **Gateways**.
- **Default Sequence Flows:** For **Exclusive Gateways**, **Inclusive Gateways**, and **Choreography Activities** that have *Conditional Sequence Flows*, one of the *outgoing Sequence Flows* MAY be a **Default Sequence Flow**. Because the other *outgoing Sequence Flows* will have appropriately visible of data as described above, the *Participants* would know if all the other *conditions* would be *false*, thus the **Default Sequence Flow** would be selected and the **Choreography** would move down that **Sequence Flow**.

In some applications it is useful to allow additional **Messages** that are not part of the defined **Choreography** model to be sent between *Participants* when the **Choreography** is carried out. This enables *Participants* to exchange other **Messages** as needed without changing the **Choreography**. There are two ways to specify this:

- If the *isClosed* attribute (from **Collaboration**) of a **Choreography** has a value of *false* or no value, then *Participants* MAY send **Messages** to each other without additional **Choreography Activities** in the **Choreography**. Unmodeled messaging can be restricted on particular **Sequence Flows** in the **Choreography**, see next bullet. If the *isClosed* attribute of a **Choreography** has a value of *true*, then *Participants* MAY NOT send **Messages** to each other without additional **Choreography Activities** in the **Choreography**. This restriction overrides any unmodeled messaging allowed by **Sequence Flows** in the next bullet.

- If the `isImmediate` attribute of a **Sequence Flow** has a value of *false* or no value, then *Participants* MAY send **Messages** to each other between the elements connected by the **Sequence Flow** without additional **Choreography Activities** in the **Choreography**. If the `isImmediate` attribute of a **Sequence Flow** has a value of *true*, then *Participants* MAY NOT send **Messages** to each other between the elements connected by the **Sequence Flow** without additional **Choreography Activities** in the **Choreography**. The value of `isImmediate` attribute of a **Sequence Flow** has no effect if the `isClosed` attribute of the containing **Choreography** has a value of *true*.

Restrictions on unmodeled messaging specified with `isClosed` and `isImmediate` applies only under the **Choreography** containing the restriction. `PartnerEntities` and `PartnerRoles` of the *Participants* MAY send **Messages** to each other under other **Choreographies**, **Collaborations**, and **Conversations**.

11.4.2 Artifacts

Both **Text Annotations** and **Groups** can be used within **Choreographies** and all **BPMN** diagrams. There are no restrictions on their use.

11.5 Choreography Activities

A **Choreography Activity** represents a point in a **Choreography** flow where an *interaction* occurs between two or more *Participants*.

The **Choreography Activity** class is an abstract element, sub-classing from `FlowElement` (as shown in Figure 11.6). When **Choreography Activities** are defined they are contained within a **Choreography** or a **Sub-Choreography**, which are `FlowElementContainers` (other `FlowElementContainers` are not allowed to contain **Choreography Activities**).



Figure 11.6 – The metamodel segment for a Choreography Activity

The **Choreography Activity** element inherits the attributes and model associations of **FlowElement** (see Table 8.44) through its relationship to **FlowNode**. Table 11.1 presents the additional model associations of the **Choreography Activity** element.

Table 11.1 – Choreography Activity Model Associations

Attribute Name	Description/Usage
participantRefs: Participant [2..*]	A Choreography Activity has two or more <i>Participants</i> (see page 113 for more information on <i>Participants</i>).
initiatingParticipantRef: Participant	One of the <i>Participants</i> will be the one that initiates the Choreography Activity .
loopType: ChoreographyLoopType = None	A Choreography Activity MAY be performed once or MAY be repeated. The <code>loopType</code> attribute will determine the appropriate marker for the Choreography Activity (see below).
correlationKeys: CorrelationKey [0..*]	This association specifies <code>correlationKeys</code> used by the Message Flow in the Choreography Activity , including Sub-Choreographies and called Choreographies .

11.5.1 Choreography Task

A **Choreography Task** is an atomic **Activity** in a **Choreography Process**. It represents an *Interaction*, which is one or two **Message** exchanges between two *Participants*. Using a **Collaboration** diagram to view these elements (see page 107 for more information on **Collaboration**), we would see the two **Pools** representing the two *Participants* of the *Interaction* (see Figure 11.7). The communication between the *Participants* is shown as a **Message Flow**.

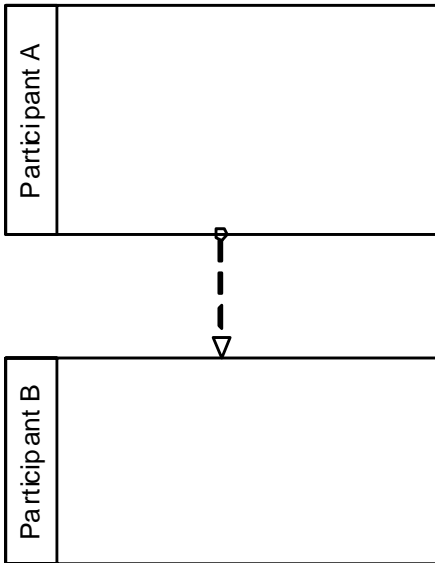

Figure 11.7 – A Collaboration view of Choreography Task elements

In a **Choreography** diagram, this *Interaction* is collapsed into a single object, a **Choreography Task**. The name of the **Choreography Task** and each of the *Participants* are all displayed in the different bands that make up the shape’s graphical notation. There are two or more **Participant Bands** and one **Task Name Band** (see Figure 11.8).

- ◆ The **Participant Band** of the *Participant* that does not initiate the interaction **MUST** be shaded with a light fill.

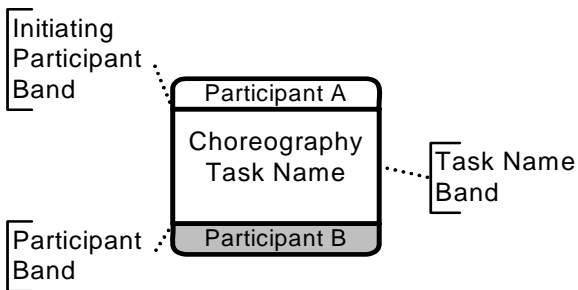

Figure 11.8 – A Choreography Task

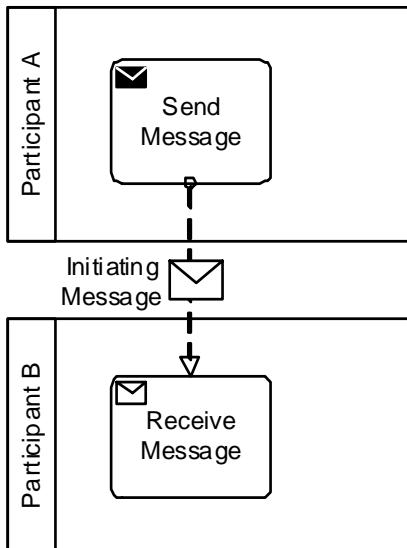

Figure 11.9 – A Collaboration view of a Choreography Task

The interaction defined by a **Choreography Task** can be shown in an expanded format through a **Collaboration** diagram (see Figure 11.9 and see page 107 for more information on **Collaborations**). In the **Collaboration** view, the *Participants* of the **Choreography Task Participant Band's** will be represented by **Pools**. The interaction between them will be a **Message Flow**.

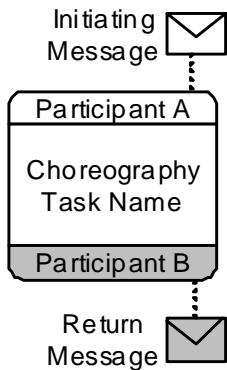

Figure 11.10 – A two-way Choreography Task

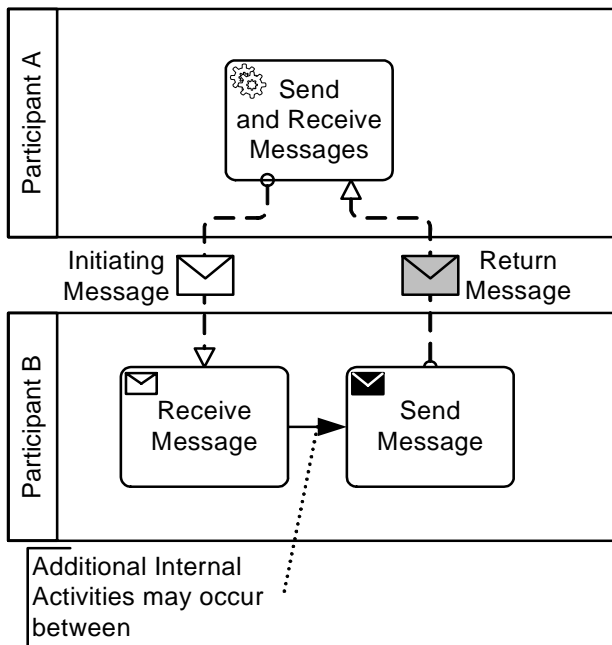

Figure 11.11 – A Collaboration view of a two-way Choreography Task

In a **Choreography** Diagram, the **Choreography Task** object shares the same shape as a **Task** or any other **BPMN Activity**, which is a rectangle that has rounded corners.

- ◆ A **Choreography Task** is a rounded corner rectangle that **MUST** be drawn with a single line.
- ◆ The use of text, color, size, and lines for a **Choreography Task** **MUST** follow the rules defined in “Use of Text, Color, Size, and Lines in a Diagram” on page 39.

The three bands in the **Choreography Task** shape provide the distinction between this type of **Task** and an **Orchestration Task** (in a traditional **BPMN** diagram).

The **Message** sent by either one or both of the *Participants* of the **Choreography Task** can be displayed (see Figure 11.10, above). The **Message** icon is shown tethered to the *Participant* that is the sender of the **Message**.

- ◆ If the **Message** is the initiating **Message** of the **Choreography Task**, then the **Message** icon **MUST** be unfilled.
- ◆ If the **Message** is a return **Message** for the **Choreography Task**, then the **Message** icon **MUST** have a light fill.

Note that **Messages** can be tethered to a **Call Choreography** that references a `GlobalChoreographyTask`, but cannot be used for **Sub-Choreographies** or **Call Choreography** that references another **Choreography**.

As with a standard **Orchestration Task**, the **Choreography Task** **MAY** have internal markers to show how the **Choreography Task** **MAY** be repeated. There are two types of internal markers (see Figure 11.12):

- ◆ A **Choreography Task** **MAY** have only one of the three markers at one time.
- ◆ The marker for a **Choreography Task** that is a standard *loop* **MUST** be a small line with an arrowhead that curls back upon itself. The `loopType` of the **Choreography Task** **MUST** be `Standard`.

- ◆ The marker for a **Choreography Task** that is parallel *multi-instance* MUST be a set of three vertical lines. The `loopType` of the **Choreography Task** MUST be `MultiInstanceParallel`.
- ◆ The marker for a **Choreography Task** that is sequential *multi-instance* MUST be a set of three horizontal lines. The `loopType` of the **Choreography Task** MUST be `MultiInstanceSequential`.

The marker that is present MUST be centered at the bottom of the **Task Name Band** of the shape.

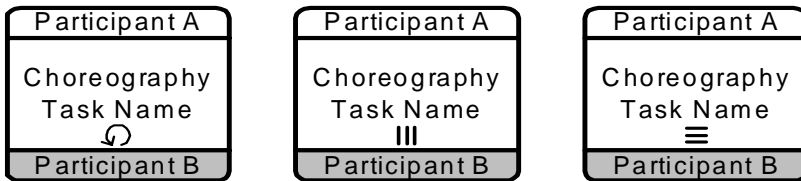

Figure 11.12 – Choreography Task Markers

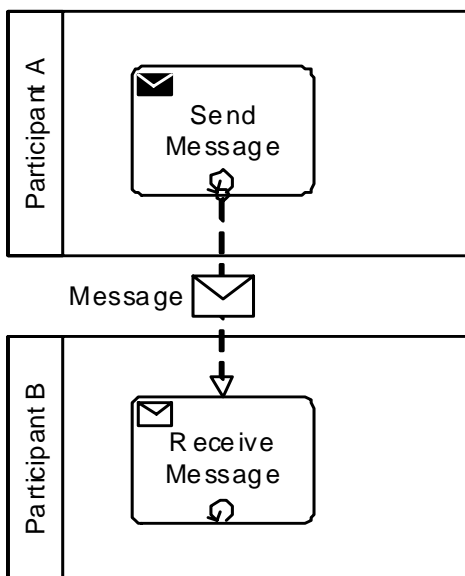

Figure 11.13 – The Collaboration view of a *looping* Choreography Task

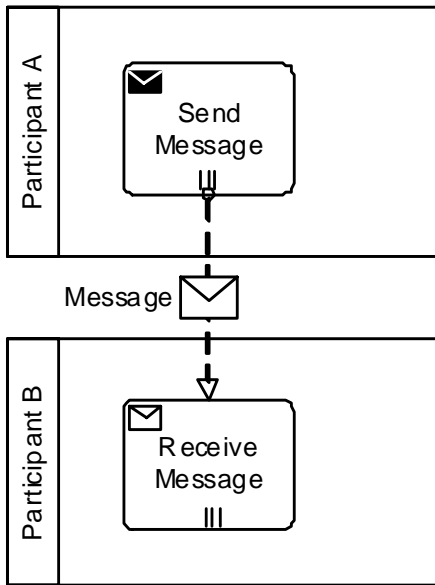

Figure 11.14 – The Collaboration view of a Parallel *Multi-Instance* Choreography Task

There are situations when a *Participant* for a **Choreography Task** is actually a *multi-instance Participant*. A *multi-instance Participant* represents a situation where there are more than one possible related *Participants* (*PartnerRoles/ PartnerEntities*) that might be involved in the **Choreography**. For example, in a **Choreography** that involves the shipping of a product, there can be more than one type of shipper used, depending on the destination. When a *Participant* in a **Choreography** contains multiple *instances*, then a *multi-instance* marker will be added to the **Participant Band** for that *Participant* (see Figure 11.15).

- ◆ The marker for a **Choreography Task** that is *multi-instance* MUST be a set of three vertical lines.
- ◆ The marker that is present MUST be centered at the bottom of the **Participant Band** of the shape.

The width of the **Participant Band** will be expanded to contain both the name of the *Participant* and the *multi-instance* marker.

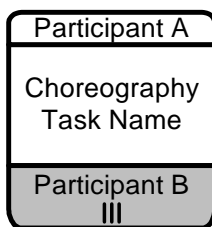

Figure 11.15 – A Choreography Task with a multiple *Participant*

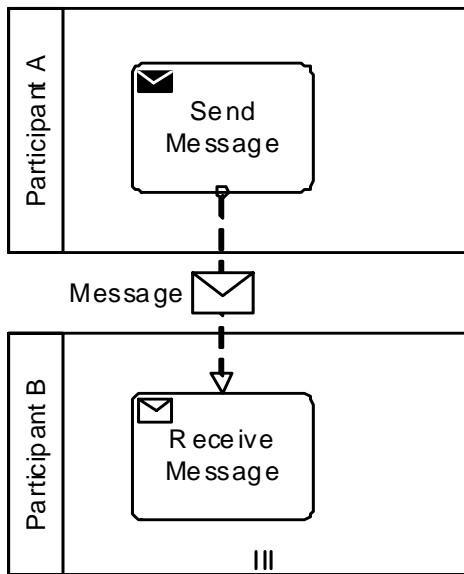

Figure 11.16 – A Collaboration view of a Choreography Task with a multiple *Participant*

The **Choreography Task** element inherits the attributes and model associations of **Choreography Activity** (see Table 11.1). Table 11.2 presents the additional model associations of the **Choreography Task** element.

Table 11.2 – Choreography Task Model Associations

Attribute Name	Description/Usage
messageFlowRef: Message Flow [1..*]	Although not graphical represented, Choreography Task contains one or more Message Flows that represent the interaction(s) between the <i>Participants</i> referenced by the Choreography Task .

11.5.2 Sub-Choreography

A **Sub-Choreography** is a compound **Activity** in that it has detail that is defined as a flow of other **Activities**, in this case, a **Choreography**. Each **Sub-Choreography** involves two or more *Participants*. The name of the **Sub-Choreography** and each of the *Participants* are all displayed in the different bands that make up the shape's graphical notation. There are two or more **Participant Bands** and one **Sub-Process Name Band**.

The **Sub-Choreography** can be in a collapsed view that hides its details (see Figure 11.17) or a **Sub-Choreography** can be expanded to show its details (a **Choreography Process**) within the **Choreography Process** in which it is contained (see Figure 11.19). In the collapsed form, the **Sub-Process** object uses a marker to distinguish it as a **Sub-Choreography**, rather than a **Choreography Task**.

The **Sub-Process** marker **MUST** be a small square with a plus sign (+) inside. The square **MUST** be positioned at the bottom center of the **Sub-Process Name Band** within the shape.

- ◆ The **Participant Band** of the *Participant* that does not initiate the interaction **MUST** be shaded with a light fill.

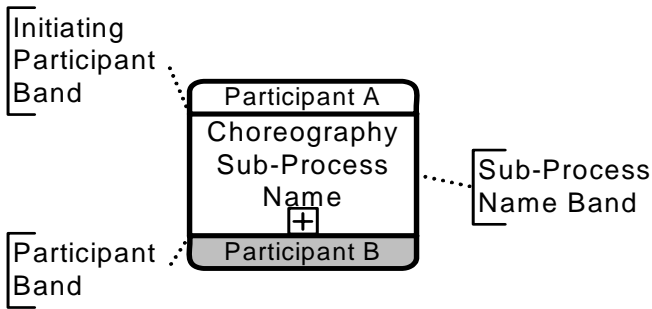

Figure 11.17– A Sub-Choreography

Figure 11.18 shows an example of a potential **Collaboration** view of the above **Sub-Choreography**.

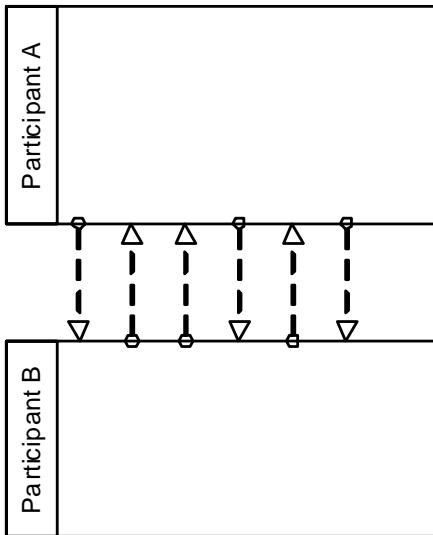

Figure 11.18 – A Collaboration view of a Sub-Choreography

Figure 11.19 shows an example of an expanded Sub-Choreography.

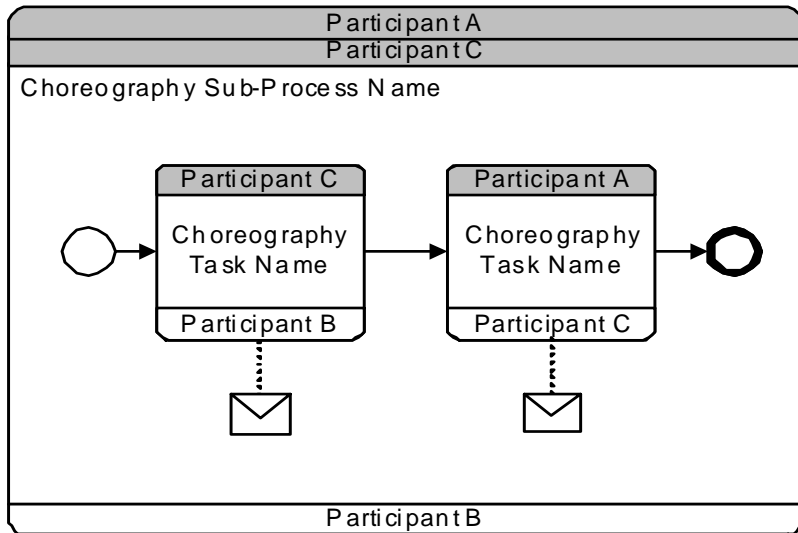

Figure 11.19 – An expanded Sub-Choreography

Figure 11.20 shows an example of a potential **Collaboration** view of the above **Sub-Choreography**.

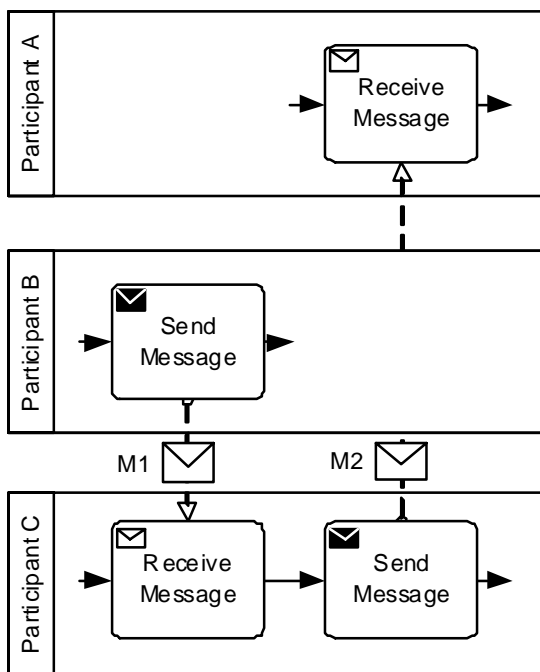

Figure 11.20 – A Collaboration view of an expanded Sub-Choreography

The *Parent* Sub-Choreography (Expanded)

The **Choreography Activity** shares the same shape as a **Sub-Process** or any other **BPMN Activity**, which is in this state.

- ◆ A **Sub-Choreography** is a rounded corner rectangle that **MUST** be drawn with a single thin line.
- ◆ The use of text, color, size, and lines for a **Sub-Choreography** **MUST** follow the rules defined in “Use of Text, Color, Size, and Lines in a Diagram” on page 39.

The three or more partitions in the **Sub-Choreography** shape provide the distinction between this type of **Task** and an Orchestration **Sub-Process** (in a traditional **BPMN** diagram).

It is possible for a **Sub-Choreography** to involve more than two *Participants*. In this case, an additional **Participant Band** will be added to the shape for each additional *Participant* (see Figure 11.21). The ordering and position of the **Participant Band** (either in the upper or lower positions) is up to the modeler or modeling tool. In addition, any **Participant Band** beyond the first two optional; it is displayed at the discretion of the modeler or modeling tool. However, each **Participant Band** that is added **MUST** be added to the upper and lower sections of the **Sub-Choreography** in an alternative manner.

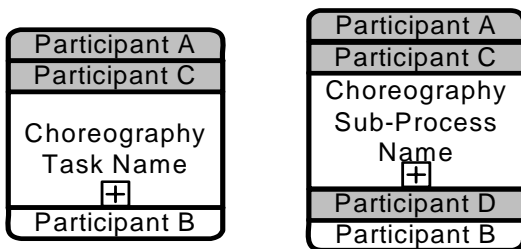

Figure 11.21 – Sub-Choreography (Collapsed) with More than Two *Participants*

As with a standard Orchestration **Sub-Process**, the **Sub-Choreography** **MAY** have internal markers to show how the **Sub-Choreography** **MAY** be repeated. There are two types of internal markers (see Figure 11.22):

- ◆ A **Sub-Choreography** **MAY** have only one of the three markers at one time.
 - ◆ The marker for a **Sub-Choreography** that is a standard *loop* **MUST** be a small line with an arrowhead that curls back upon itself. The `loopType` of the **Sub-Choreography** **MUST** be `Standard`.
 - ◆ The marker for a **Sub-Choreography** that is parallel *multi-instance* **MUST** be a set of three vertical lines. The `loopType` of the **Sub-Choreography** **MUST** be `MultiInstanceParallel`.
 - ◆ The marker for a **Sub-Choreography** that is sequential *multi-instance* **MUST** be a set of three horizontal lines. The `loopType` of the **Sub-Choreography** **MUST** be `MultiInstanceSequential`.
- ◆ The marker that is present **MUST** be centered at the bottom of the **Sub-Process Name Band** of the shape.

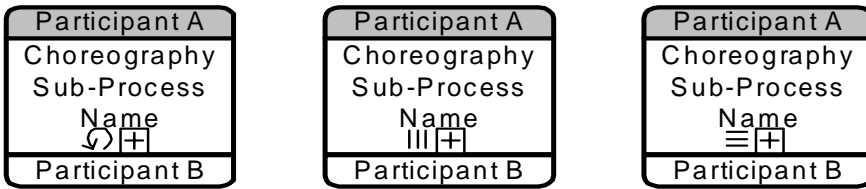

Figure 11.22 – Sub-Choreography Markers

There are situations when a *Participant* for a **Sub-Choreography** is actually a *multi-instance Participant*. A *multi-instance Participant* represents a situation where there are more than one possible related *Participants* (*PartnerRoles/PartnerEntities*) that can be involved in the **Choreography**. For example, in a **Choreography** that involves the shipping of a product, there can be more than one type of shipper used, depending on the destination. When a *Participant* in a **Choreography** contains multiple *instances*, then a *multi-instance* marker will be added to the **Participant Band** for that *Participant* (see Figure 11.23).

- ◆ The marker for a **Sub-Choreography** that is *multi-instance* MUST be a set of three vertical lines.
- ◆ The marker that is present MUST be centered at the bottom of the **Participant Band** of the shape.
- ◆ The width of the **Participant Band** will be expanded to contain both the name of the *Participant* and the *multi-instance* marker.

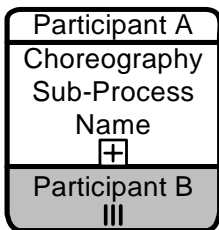

Figure 11.23 – Sub-Choreography Markers with a multi-instance Participant

This includes **Compensation Event Sub-Processes** (contained within a **Sub-Choreography**) as well as the external **Compensation Activity** connected through an **Association**.

The **Sub-Choreography** element inherits the attributes and model associations of **Choreography Activity** (see Table 11.1) and **FlowElementsContainer** (see Table 8.45). Table 11.3 presents the additional model associations of the **GlobalChoreographyTask** element:

Table 11.3 – Sub-Choreography Model Associations

Attribute Name	Description/Usage
artifacts: Artifact [0..*]	This attribute provides the list of Artifacts that are contained within the Sub-Choreography .

11.5.3 Call Choreography

A **Call Choreography** identifies a point in the **Process** where a global **Choreography** or a **Global Choreography Task** is used. The **Call Choreography** acts as a place holder for the inclusion of the **Choreography** element it is calling. This pre-defined called **Choreography** element becomes a part of the definition of the *parent* **Choreography**.

A **Call Choreography** object shares the same shape as the **Choreography Task** and **Sub-Choreography**, which is a rectangle that has rounded corners, two or more **Participant Bands**, and an **Activity Name Band**. However, the target of what the **Choreography Activity** calls will determine the details of its shape.

- ◆ If the **Call Choreography** calls a **Global Choreography Task**, then the shape will be the same as a **Choreography Task**, but the boundary of the shape **MUST** have a thick line (see Figure 11.24).
- ◆ If the **Call Choreography** calls a **Choreography**, then there are two options:
 - ◆ The details of the called **Choreography** can be hidden and the shape will be the same as a *collapsed Sub-Choreography*, but the boundary of the shape **MUST** have a thick line (see Figure 11.25).
 - ◆ The details of the called **Choreography** can be shown and the shape will be the same as an *expanded Sub-Choreography*, but the boundary of the shape **MUST** have a thick line (see Figure 11.26).

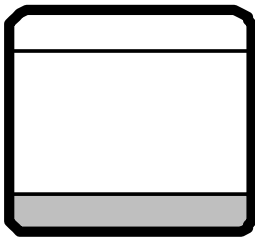

Figure 11.24 – A Call Choreography calling a Global Choreography Task

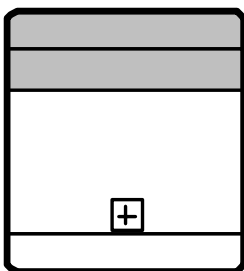

Figure 11.25 – A Call Choreography calling a Choreography (Collapsed)

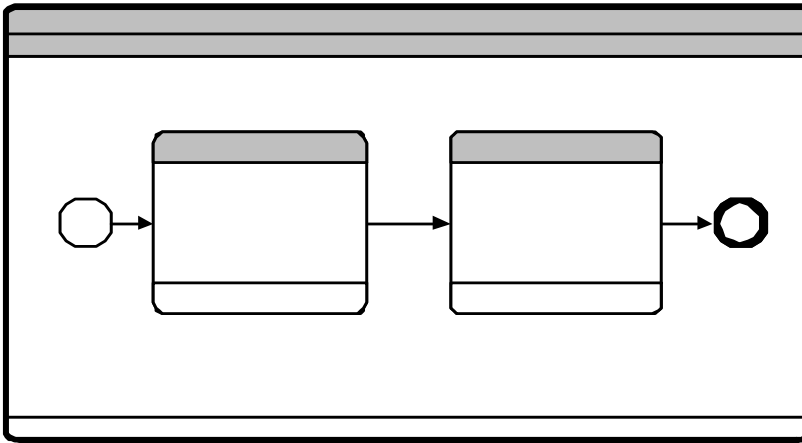

Figure 11.26 – A Call Choreography calling a Choreography (expanded)

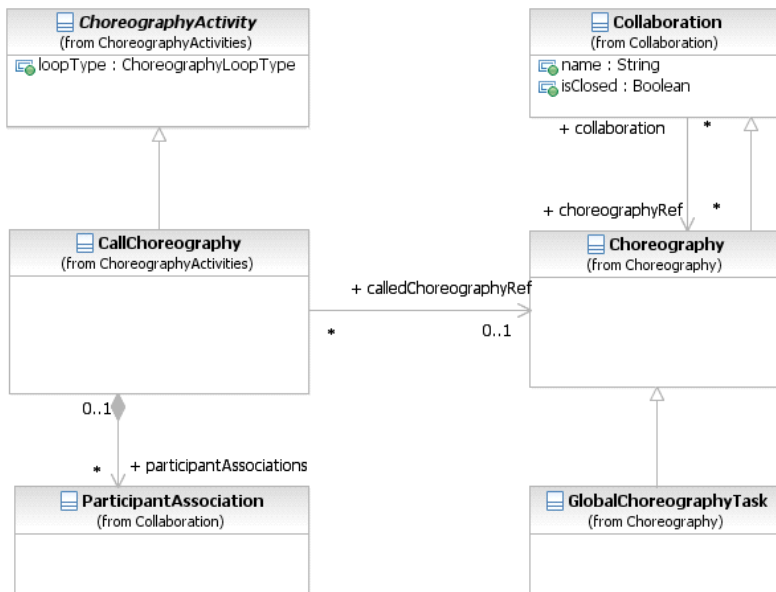

Figure 11.27– The Call Choreography class diagram

The **Call Choreography** element inherits the attributes and model associations of `ChoreographyActivity` (see Figure 11.27 and Table 11.1). Table 11.4 presents the additional model associations of the **Call Choreography** element.

Table 11.4 – Call Choreography Model Associations

Attribute Name	Description/Usage
calledChoreographyRef: CallableElement [0..1]	The element to be called, which will be either a Choreography or a GlobalChoreographyTask .
participantAssociations: ParticipantAssociation [0..*]	Specifies how <i>Participants</i> in a nested Choreography or GlobalChoreographyTask match up with the <i>Participants</i> in the Choreography referenced by the Call Choreography .

11.5.4 Global Choreography Task

A **GlobalChoreographyTask** is a reusable, atomic **Choreography Task** definition that can be called from within any **Choreography** by a **Call Choreography**.

The **GlobalChoreographyTask** element inherits the attributes and model associations of **Collaboration** (see Table 9.1), through its relationship to **Choreography**. Table 11.5 presents the additional model associations of the **GlobalChoreographyTask** element.

Table 11.5 – Global Choreography Task Model Associations

Attribute Name	Description/Usage
initiatingParticipantRef: Participant	One of the <i>Participants</i> will be the one that initiates the Global Choreography Task .

A **GlobalChoreographyTask** is a restricted type of **Choreography**, it is an “empty” **Choreography**.

- ◆ A **GlobalChoreographyTask** MUST NOT contain any *Flow Elements*.

Since a **GlobalChoreographyTask** does not have any *Flow Elements*, it does not require **MessageFlowAssociations**, **ParticipantAssociations**, **ConversationAssociations**, or **Artifacts**. It is basically a set of *Participants* and **Message Flows** intended for reuse.

11.5.5 Looping Activities

Both **Sub-Choreographies** can have *standard loops* and *multi-instances*. Examples of **Choreography Activities** with the appropriate markers can be seen in Figure 11.12 and Figure 11.22.

11.5.6 The Sequencing of Activities

There are constraints on how **Choreography Activities** can be sequenced (through **Sequence Flows**) in a **Choreography**. These constraints are due to the limited visibility of the *Participants*, which only know of the progress of the **Choreography** by the **Messages** that occur. When a *Participant* sends or receives a **Message**, then that

Participant knows exactly how far the **Choreography** has progressed. This means that the ordering of **Choreography Activities** need to take into account when the *Participants* send or receive **Messages** so that they *Participants* are NOT REQUIRED to guess about when it is their turn to send a **Message**.

The basic rule of **Choreography Activity** sequencing is this:

- ◆ The *Initiator* of a **Choreography Activity** MUST have been involved (as *Initiator* or *Receiver*) in the previous **Choreography Activity**.

Of course, the first **Choreography Activity** in a **Choreography** does not have this constraint.

Figure 11.28 shows a sequence of two **Choreography Activities** that follow this constraint. “Participant B” is the *Initiator* of “Choreography Task 2” after being the *Receiver* in “Choreography Task 1.” While there is no requirement that “Participant B” sends the **Message** immediately, since there can be internal work that the *Participant* needs to do prior to the **Message**. But in this situation there is no ambiguity that “Participant B” will be the *Initiator* of the next **Choreography Task**. “Participant C” does not know exactly when the **Message** will arrive from “Participant B,” but “Participant C” knows that one will arrive and there are not any additional requirements on the *Participant* until the **Message** arrives.

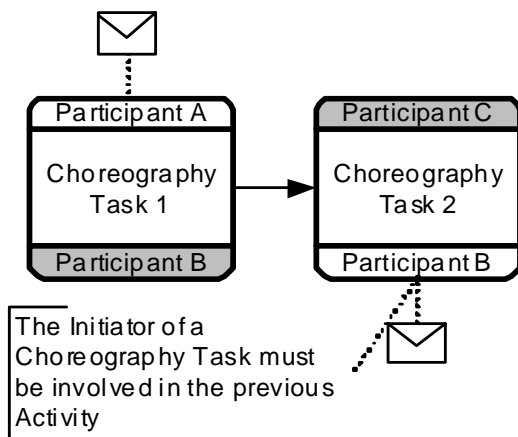

Figure 11.28 – A valid sequence of Choreography Activities

Naturally, the sequence of **Choreography Activities** shown in Figure 11.28, above can be expanded into a **Collaboration** diagram to show how the sequence can be enforced. Figure 11.29 shows the corresponding **Collaboration**. The diagram shows how the **Activities** within the individual **Pools** fit with the design of the **Choreography**.

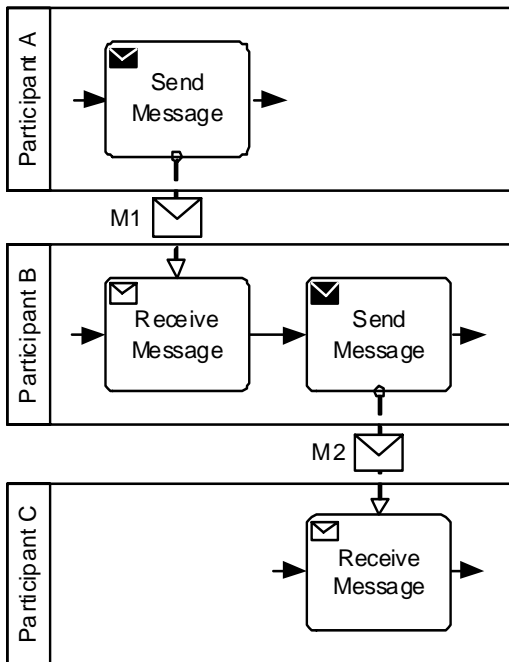

Figure 11.29 – The corresponding Collaboration for a valid Choreography sequence

When determining a valid sequence of **Choreography Tasks**, it is important to consider the type of **Choreography Tasks** that are being used. A single **Choreography Task** can be used for one or two **Messages**. Most of the time there will be one or two **Messages** for a **Choreography Task**. Figure 11.30 shows a sequence of **Choreography Tasks**, the first one being a two-way interaction, where the initiator sends a **Message** and gets a response from the other *Participant*.

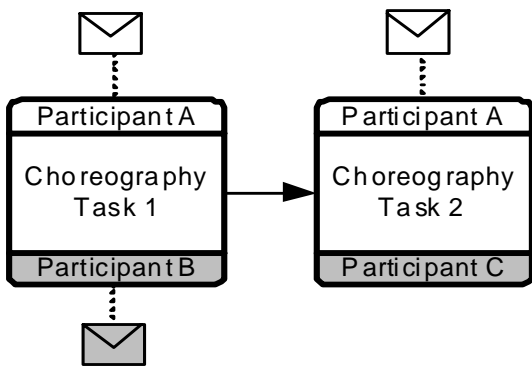

Figure 11.30 – A valid sequence of Choreography Activities with a two-way Activity

Figure 11.31 shows the corresponding **Collaboration** and how the two **Choreography Tasks** are reflected in the **Processes** within the **Pools**. The **Choreography Task** that has two **Messages** is reflected by three **Process Tasks**. Usually in these cases, the initiating Participant will use a single **Activity** to handle both the sending and receiving of the **Messages**. A **BPMN Service Task** can be used for this purpose and these types of **Tasks** are often referred to as “request-response” **Tasks** for **Choreography** modelers.

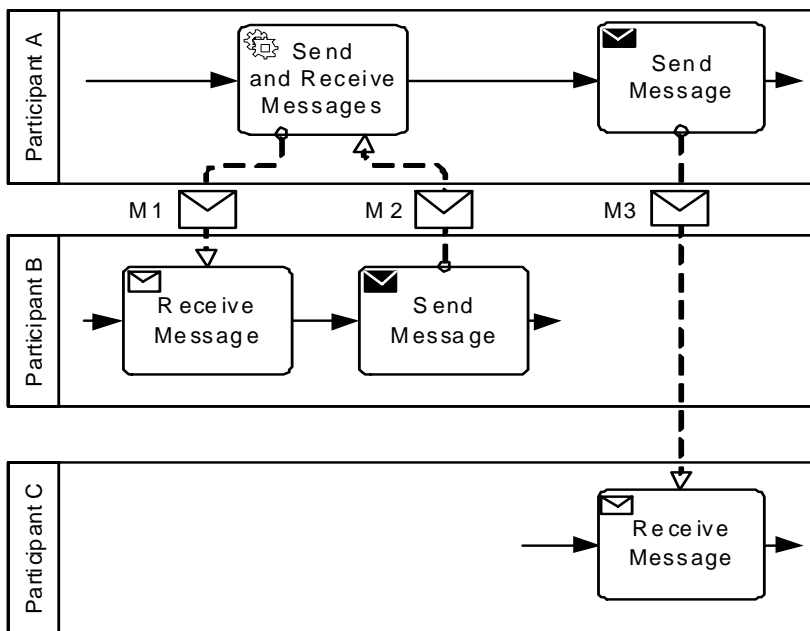

Figure 11.31 – The corresponding Collaboration for a valid Choreography sequence with a two-way Activity

Figure 11.32 shows how a sequence of **Choreography Activities** can be designed that would be invalid in the sense that an *Initiating Participant* would not know when the appropriate time would be to send a **Message**. In this example, “Participant A” is scheduled to send a **Message** to “Participant C” after “Participant B” sends a **Message** to “Participant C.” However, “Participant A” will not know when the **Message** from “Participant B” has been sent. So, there is no way to enforce the sequence that is modeled in the **Choreography**.

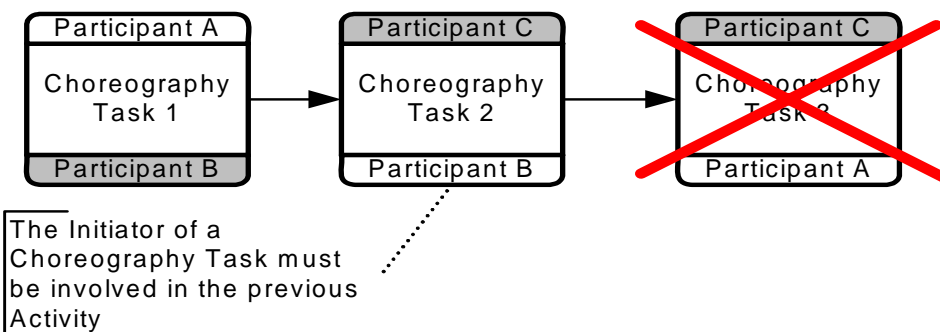

Figure 11.32 – An invalid “sequence of Choreography Activities”

Figure 11.33 shows the **Collaboration** view of the above **Choreography** diagram. It becomes clear that “Participant A” will not know the appropriate time to send **Message** “M3” to “Participant C.” If the **Message** is sent too soon, then “Participant C” will not be prepared to receive it. Thus, as a **Choreography**, the model in Figure 11.32, above, cannot be enforced.

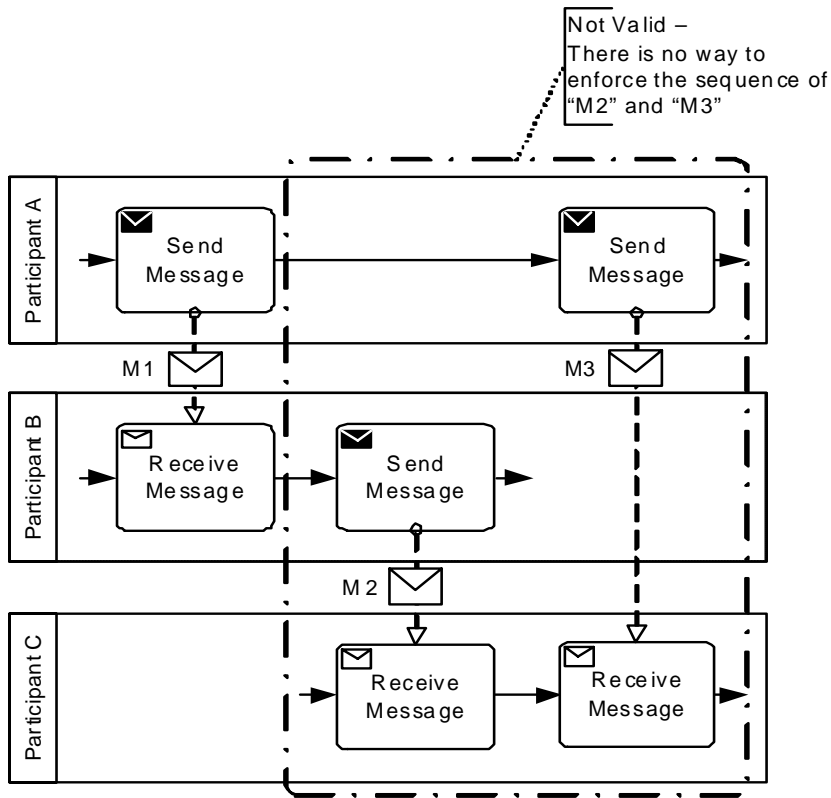

Figure 11.33 – The corresponding Collaboration for an invalid Choreography sequence

11.6 Events

11.6.1 Start Events

Start Events provide the graphical marker for the start of a **Choreography**. They are used much in the same way as they are used for a **Process** (see “Start Event” on page 237). This table shows how the types of **Start Events** are applied to **Choreography**.

Table 11.6 – Use of Start Events in Choreography

Type of Event	Usage in Choreography?
None	Yes. This is really just a graphical marker since the arrival of the first Message in the Choreography is really the <i>Trigger</i> for the Choreography . Sub-Processes , however, we should look at. The <i>Parent Process</i> can be considered the <i>trigger</i> .
Message	No. A Message Start Event , in a stand-alone Choreography , has no way to show who the senders or receivers of the Message should be. A Choreography Task should be used instead. Thus, a None Start Event should be used as a graphical marker for the “start” of the Choreography .
Timer	Yes. All <i>Participants</i> have to have an agreement to the approximate time.
Escalation	No. An Escalation is only visible to a single <i>Participant</i> . That <i>Participant</i> will have to send a Message to the other <i>Participants</i> .
Error	No. An Error is only visible to a single <i>Participant</i> . That <i>Participant</i> will have to send a Message to the other <i>Participants</i> .
Compensation	No. Compensation is handled within a single <i>Participant</i> (an orchestration Process).
Conditional	Yes. This is actually determined internal to <i>Participant</i> , but then the other <i>Participants</i> know this has happened based the first interaction that follows.
Signal	Yes. The source of the <i>Signal</i> is NOT REQUIRED (and might not even be a <i>Participant</i> in the Choreography). There are no specific recipients of a <i>Signal</i> . All <i>Participants</i> of the Choreography (to comply) MUST be able to see the <i>Signal</i> .
Multiple	Yes. But they can only be Multiple <i>Signals</i> or <i>Timers</i> . As in <i>Orchestration</i> , this acts like an OR. Any one of the incoming <i>Signals</i> will Trigger the Choreography . Any <i>Signal</i> that follows would create a separate instance of the Choreography .

11.6.2 Intermediate Events

Table 11.7– Use of Intermediate Events in Choreography

Type of Event	Usage in Choreography?
None: in Normal Flow	Yes. However, this really doesn’t have much meaning other than just documenting that a specific point has been reached in the Choreography . There would be no Message exchange or any delay in the Choreography .
None: Attached to Activity boundary	No. There would be no way for <i>Participants</i> to know when the Activity should be interrupted.

Table 11.7– Use of Intermediate Events in Choreography

<p>Message: in Normal Flow</p>	<p>No. A Message Intermediate Event, in a stand-alone Choreography, has no way to show who the senders or receivers of the Message should be. A Choreography Task should be used instead. Also, would the Event be a <i>Catch</i> or a <i>Throw</i>?</p>
<p>Message: Attached to Activity boundary</p>	<p>Yes. Only for Choreography Tasks. The Intermediate Event has to be attached to the Participant Band of the receiver of the Message (since it is a catch Event). The sender of the message has to be the other <i>Participant</i> of the Choreography Task.</p>
<p>Message: Use in Event Gateway</p>	<p>No. A Message Intermediate Event, in a stand-alone Choreography, has no way to show who the senders or receivers of the Message should be. A Choreography Task should be used instead.</p>
<p>Timer: in Normal Flow</p>	<p>Yes. Time is not precise in Choreography. It is established by the last visible Choreography Activity. The <i>Participants</i> involved in the Choreography Activity that immediately precedes will have a rough approximation of the time—there will be no exact synchronization.</p> <p>For relative timers: Only the <i>Participants</i> involved in the Choreography Activity that immediately precedes the Event would know the time. The sender of the Choreography Activity that immediately follows the timer MUST be involved in the Choreography Activity that immediately precedes the timer.</p> <p>For absolute timers (full time/date): All <i>Participants</i> would know the time. There does not have to be a relationship between the <i>Participants</i> of the Choreography Activities that are on either side the timer.</p> <p>The sender of the Choreography Activity that immediately follows the timer is the <i>Participant</i> that enforces the timer.</p>
<p>Timer: Attached to Activity boundary</p>	<p>Yes. Time is not exact in this case. It is established by the last visible Event. All <i>Participants</i> will have a rough approximation of the time—there will be no exact synchronization. This includes both interrupting and escalation Events. The <i>Participants</i> of the Choreography Activity that has the attached timer all enforce the timer.</p> <p>For relative timers: They all have to be involved in the Choreography Activity that immediately precedes the Activity with the attached timer.</p> <p>For absolute timers (full time/date): All <i>Participants</i> would know the time. They all have to be involved in the Choreography Activity that immediately precedes the Activity with the attached timer.</p>
<p>Timer: Used in Event Gateway</p>	<p>Yes. See Event-Based Gateway below.</p>
<p>Error: Attached to Activity boundary</p>	<p>No. An Error is only visible to a single <i>Participant</i>. That <i>Participant</i> will have to send a Message to the other <i>Participants</i>.</p>
<p>Escalation: Used in Normal Flow</p>	<p>No. An Escalation is only visible to a single <i>Participant</i>. That <i>Participant</i> will have to send a Message to the other <i>Participants</i>.</p>

Table 11.7– Use of Intermediate Events in Choreography

Escalation: Attached to Activity boundary	No. An Escalation is only visible to a single <i>Participant</i> . That <i>Participant</i> will have to send a Message to the other <i>Participants</i> .
Cancel: in Normal Flow	No. These are <i>Throw Events</i> . As with a Message Event , there would be no indicator as to who is the source of the <i>Cancel</i> .
Cancel: Attached to Activity boundary	Yes. These are <i>Catch Events</i> . As with a Message Event , they would be attached to the Choreography Activity on the Participant Band that is receiving the <i>Cancel</i> . These would only be interrupting Events .
Compensation: in Normal Flow	No. These are <i>Throw Events</i> . As with a Message , there would be no indicator as to who is the source of the <i>Cancel</i> .
Compensation: Attached to Activity boundary	Yes. These are <i>Catch Events</i> . As with a Message Event , they would be attached to the Choreography Activity on the Participant Band that is receiving the <i>Cancel</i> .
Conditional: in Normal Flow	Yes. This is a delay that waits for a change in data to trigger the Event . The data are to be visible to the <i>Participants</i> as it was data of a previously sent Message .
Conditional: Attached to Activity boundary	Yes. This is an interruption that waits for a change in data to trigger the Event . The data are to be visible to the <i>Participants</i> as it was data of a previously sent Message .
Conditional: Used in Event Gateway	Yes. This is a delay that waits for a change in data to trigger the Event . The data are to be visible to the <i>Participants</i> as it was data of a previously sent Message .
Link: in Normal Flow	Yes. These types of Events merely create a virtual Sequence Flows . Thus, as long as a Sequence Flow between two elements is valid (and within a Choreography Process level), then a pair of Link Events can interrupt that Sequence Flow .
Signal: in Normal Flow	Yes. Only <i>Catch Events</i> can be used. For <i>Throw Signal Events</i> , there would be no indicator of who is the source <i>Participant</i> . This would be a delay in the Choreography that waits for the <i>Signal</i> . The source of the <i>Signal</i> is NOT REQUIRED (and might not even be a <i>Participant</i> in the Choreography). There are no specific recipients of a <i>Signal</i> . All <i>Participants</i> of the Choreography (to comply) MUST be able to see the <i>Signal</i> .
Signal: Attached to Activity boundary	Yes. These are <i>Catch Events</i> . This would be an interruption in the Choreography that waits for the <i>Signal</i> . The source of the <i>Signal</i> is NOT REQUIRED (and might not even be a <i>Participant</i> in the Choreography). There are no specific recipients of a <i>Signal</i> . All <i>Participants</i> of the Choreography (to comply) MUST be able to see the <i>Signal</i> . This Event MUST NOT be attached to a Participant Band or this would suggest that <i>Participant</i> is a specific recipient of the <i>Signal</i> .

Table 11.7– Use of Intermediate Events in Choreography

Signal: Used in Event Gateway	Yes. These are <i>Catch Events</i> . This would be a delay in the Choreography that waits for the <i>Signal</i> . The source of the <i>Signal</i> is NOT REQUIRED (and might not even be a <i>Participant</i> in the Choreography). There are no specific recipients of a <i>Signal</i> . All <i>Participants</i> of the Choreography (to comply) MUST be able to see the <i>Signal</i> .
Multiple: in Normal Flow	Yes. But they can only be a collection of valid <i>Catch Events</i> . As in <i>Orchestration</i> , this acts like an OR. Any one of the incoming triggers will continue the Choreography .
Multiple: Attached to Activity Boundary	Yes. But they can only be a collection of valid <i>Catch Events</i> . As in <i>Orchestration</i> , this acts like an OR. Any one of the incoming triggers will interrupt the Choreography Activity .

11.6.3 End Events

End Events provide a graphical marker for the end of a path within the **Choreography**.

Table 11.8 – Use of End Events in Choreography

Type of Event	Usage in Choreography?
None	Yes. This is really just a graphical marker since the sending of the previous Message in the Choreography is really the end of the Choreography . The <i>Participants</i> of the Choreography would understand that they would not expect any further Message at that point.
Message	No. A Message End Event , in a stand-alone Choreography , has no way to show who the senders or receivers of the Message should be. A Choreography Task should be used instead. Thus, a None End Event should be used as a graphical marker for the “end” of the Choreography .
Error	No. These are <i>Throw Events</i> and there would be no way to indicate the <i>Participant</i> that is the source of the Error.
Escalation	No. These are <i>Throw Events</i> and there would be no way to indicate the <i>Participant</i> that is the source of the Escalation.
Cancel	No. These are <i>Throw Events</i> . As with a Message Event , there would be no indicator as to who is the source of the <i>Cancel</i> .
Compensation	No. These are <i>Throw Events</i> . As with a Message Event , there would be no indicator as to who is the source of the <i>compensation</i> .
Signal	No. These are <i>Throw Events</i> . As with a Message Event , there would be no indicator as to who is the source of the <i>Signal</i> .

Table 11.8 – Use of End Events in Choreography

Multiple	No. Since there are no valid End Event Results (Terminate doesn't count) in Choreography , there cannot be multiple of them.
Terminate	Yes. However, there would be no specific ability to terminate the Choreography , since there is no controlling system. In this case, all <i>Participants</i> in the Choreography would understand that when the Terminate End Event is reached (actually when the Message that precedes it occurs), then no further messages will be expected in the Choreography , even if there were parallel paths. The use of the Terminate End Event really only works when there are only two <i>Participants</i> . If there are more than two <i>Participants</i> , then any <i>Participant</i> that was not involved in the last Choreography Task would not necessarily know that the Terminate End Event had been reached.

11.7 Gateways

In an *Orchestration Process*, **Gateways** are used to create alternative and/or parallel paths for that **Process**. **Choreography** has the same requirement of alternative and parallel paths. That is, interactions between *Participants* can happen in sequence, in parallel, or through exclusive selection. While the paths of **Choreography** follow the same basic patterns as that of an *Orchestration Process*, the lack of a central mechanism to maintain data visibility, and that there is no central evaluation, there are constraints as to how the **Gateways** are used in conjunction with the **Choreography Activities** that precede and follow the **Gateways**. These constraints are an extension of the basic sequencing constraints that was defined on page 335. The six (6) sub clauses that follow will define how the types of **Gateways** are used in **Choreography**.

11.7.1 Exclusive Gateway

Exclusive Gateways (Decisions) are used to create alternative paths within a **Process** or a **Choreography**. For details of how **Exclusive Gateways** are used within an *Orchestration Process* see page 289.

Exclusive Gateways are used in **Choreography**, but they are constrained by the lack of a central mechanism to store the data that will be used in the *Condition* expressions of the **Gateway's outgoing Sequence Flows**.

Choreographies MAY contain natural language descriptions of the **Gateway's Conditions** to document the alternative paths of the **Choreography** (e.g., “large orders” will go down one path while “small orders” will go down another path), but such **Choreographies** would be underspecified and would not be *enforceable*. To create an *enforceable* **Choreography**, the **Gateway Conditions** MUST be formal *Condition Expressions*. However:

- ◆ The data used for **Gateway Conditions** MUST have been in a **Message** that was sent prior to (upstream from) the **Gateway**.
- ◆ More specifically, all *Participants* that are directly affected by the **Gateway** MUST have either sent or received the **Message(s)** that contained the data used in the *Conditions*.
- ◆ Furthermore, all these *Participants* MUST have the same understanding of the data. That is, the actual values of the data cannot selectively change after a *Participant* has seen a **Message**. Changes to data during the course of the **Choreography** MUST be visible to all the *Participants* affected by the **Gateway**.

These constraints ensure that the *Participants* in the **Choreography** understand the basis (the actual value of the data) for the decision behind the **Gateway**.

One (1) or more *Participants* will actually “control” the **Gateway** decision; that is, these *Participants* make the decision through the internal *Orchestration Processes*. The decision is manifested by the particular **Message** that occurs in the **Choreography** (after the **Gateway**). This **Message** is the *initiating Message* of a **Choreography Activity** that follows the **Gateway**. Thus, only the *Participants* that are the *initiators* of the **Messages** that follow the **Gateway** are the ones that control the decision. This means that:

- ◆ The *initiating Participants* of the **Choreography Activities** that follow the **Gateway** **MUST** have sent or received the **Message** that provided the data upon which the decision is made.
- ◆ The **Message** that provides the data for the **Gateway** **MAY** be in any **Choreography Activity** prior to the **Gateway** (i.e., it does not have to immediately precede **Gateway**).

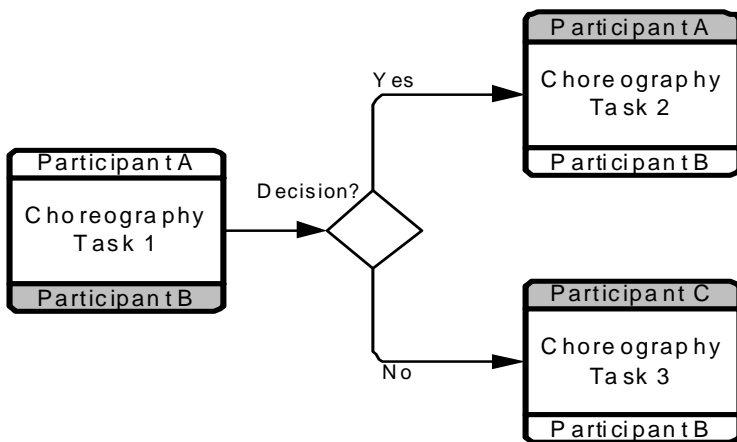

Figure 11.34 – An example of the Exclusive Gateway

Figure 11.35 shows the **Collaboration** that demonstrates how the above **Choreography** that includes an **Exclusive Gateway** can be enforced.

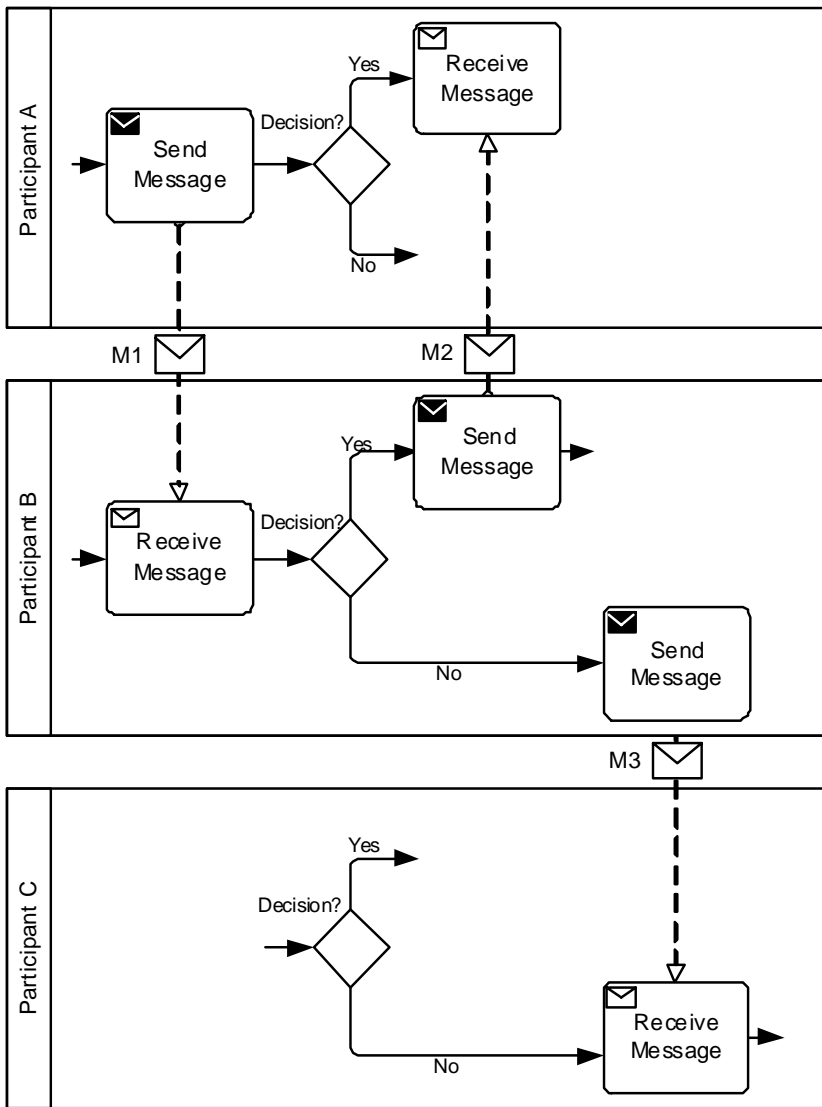

Figure 11.35 – The relationship of Choreography Activity *Participants* across the sides of the Exclusive Gateway shown through a Collaboration

Usually, the *initiators* for the **Choreography Activities** that follow the **Gateway** will be the same *Participant*. That is, there is only one *Participant* controlling the decision. Often, the receivers of the *initiating Message* for those Choreography Activities will be the same Participant. However, it is possible that there could be different Participants receiving the initiating Message for each Choreography Activity (see Figure 11.36).

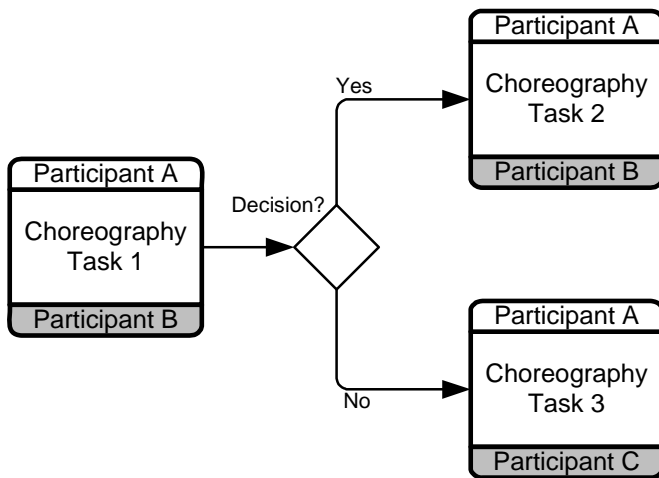

Figure 11.36 – Different Receiving Choreography Activity Participants on the output sides of the Exclusive Gateway

This configuration can only be valid if all the *Participants* in the **Choreography Activities** that follow the **Gateway** have seen the data upon which the decision is made. If either “Participant B” or “Participant C” had not sent or received a **Message** with the appropriate data, then that *Participant* would not be able to know if they are suppose to receive a **Message** at that point in the **Choreography**. There is also the assumption that the value of the data is consistent from the point of view of all *Participants*.

Figure 11.37 displays the corresponding **Collaboration** view of the above **Choreography Exclusive Gateway** configuration.

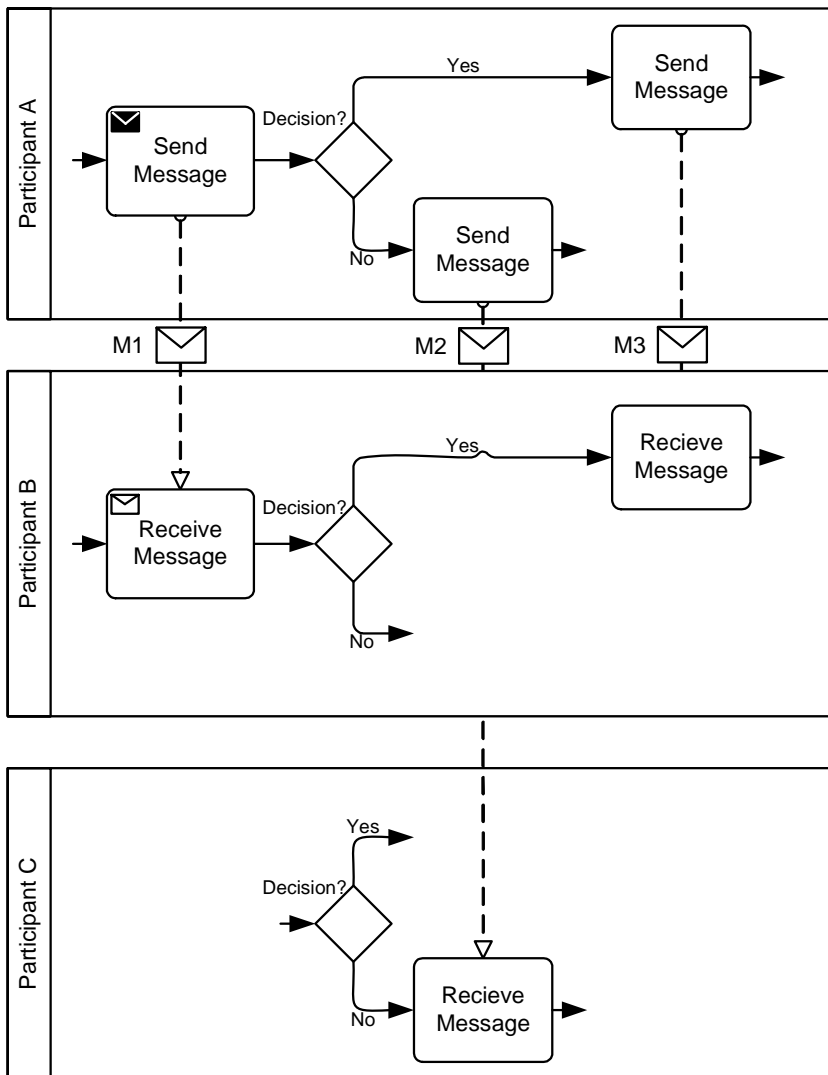

Figure 11.37 – The corresponding Collaboration view of the above Choreography Exclusive Gateway configuration

The **REQUIRED** execution behavior of the **Gateway** and associated **Choreography Activities** are enforced through the **Business Processes** of the *Participants* as follows:

- ◆ Each **Choreography Activity** and the **Sequence Flow** connections are reflected in each *Participant Process*.
- ◆ The **Gateway** is reflected in the **Process** of each *Participant Process* that is an initiator of **Choreography Activities** that follow the **Gateway**.
- ◆ For the receivers in **Choreography Activities** that follow the **Gateway**, an **Event-Based Gateway** is used to consume the associated **Message** (sent as an outcome of the **Gateway**). When a *Participant* is the receiver of more than one of the alternative **Messages**, the corresponding receives follow the **Event-Based Gateway**.

If the *Participant* is the receiver of only one such **Message**, that is also consumed through a receive following the **Event-Based Gateway**. This is because the *Participant Process* does not know whether it will receive a **Message** (since the **Gateway** entails a choice of outcomes).

11.7.2 Event-Based Gateway

As described above, the **Event-Based Gateway** represents a branching point in the **Process** where the alternatives are based on **Events** that occur at that point in the **Process**, rather than the evaluation of expressions using **Process** data. For details of how **Event-Based Gateways** are used within an *Orchestration Process* see “Event-Based Gateway” on page 296.

These **Gateways** are used in **Choreography** when the data used to make the decision is only visible to the internal **Processes** of one *Participant*. That is, there has been no **Message** sent within the **Choreography** that would expose the data used to make the *decision*. Thus, the only way that the other *Participants* can be aware of the results of the decision is by the particular **Message** that arrives next.

- ◆ On the right side of the **Gateway**: either
 - ◆ the senders **MUST** to be the same; or
 - ◆ the receivers **MUST** to be the same.
 - ◆ After the first **Choreography Activity** occurs, the other **Choreography Activities** for the **Gateway** **MUST NOT** occur.
- ◆ **Message Intermediate Events** **MUST NOT** be used in the **Event-Based Gateway**.
- ◆ **Timer Intermediate Events** **MAY** be used, but they restrict the participation in the **Gateway**.
 - ◆ For relative timers: All *Participants* on the right side of the **Gateway** **MUST** be involved in the **Choreography Activity** that immediately precedes the **Gateway**.
 - ◆ For absolute timers (full time/date): All *Participants* on the right side of the **Gateway** **MUST** be involved in the **Choreography Activity** that immediately precedes the **Gateway**.
- ◆ **Signal Intermediate Events** **MAY** be used (they are visible to all *Participants*).
- ◆ No other types of **Intermediate Events** are allowed.

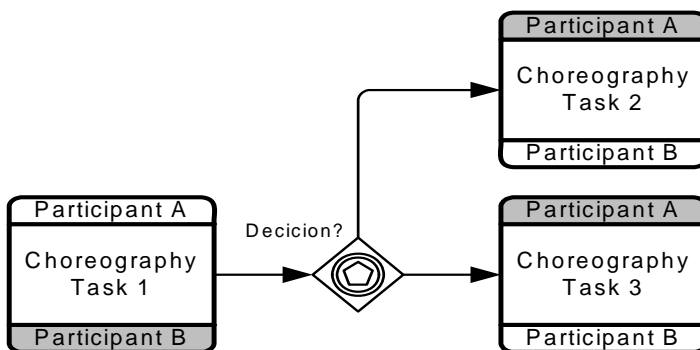

Figure 11.38 – An example of an Event Gateway

Figure 11.39 displays the corresponding Collaboration view of the above Choreography Event Gateway configuration.

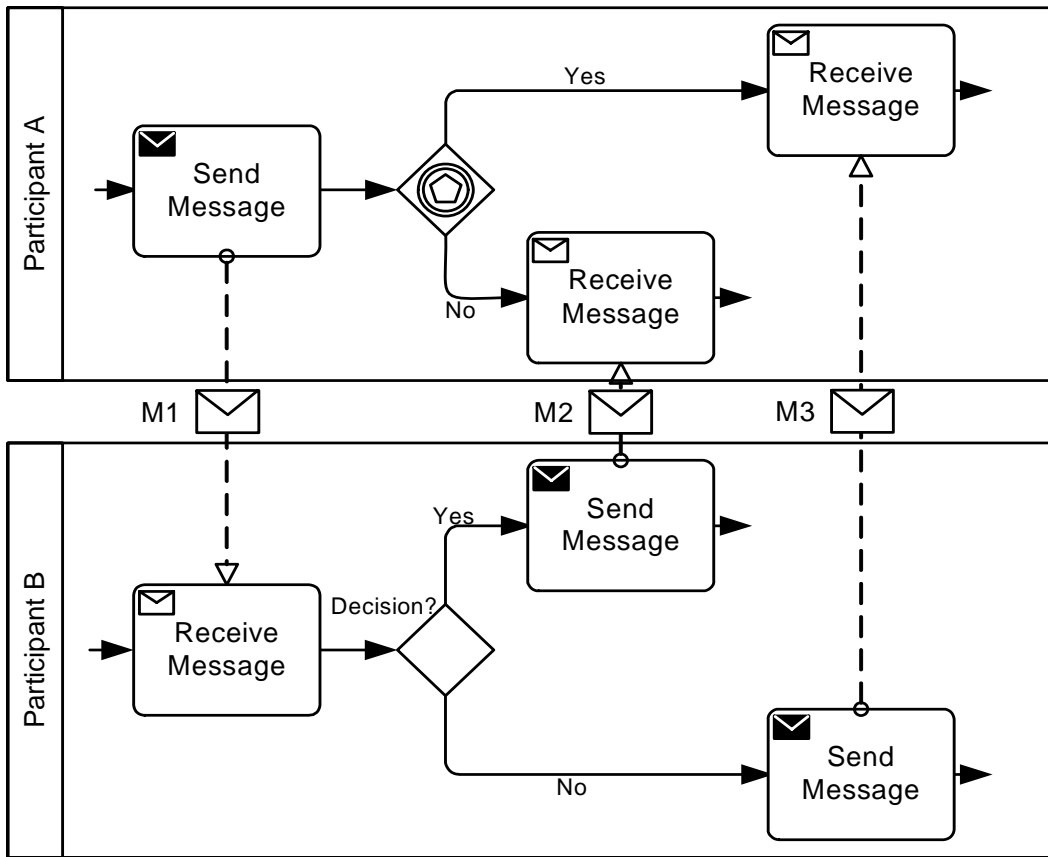

Figure 11.39 – The corresponding Collaboration view of the above Choreography Event Gateway configuration

The REQUIRED execution behavior of the **Event-Based Gateway** and associated **Choreography Activities** are enforced through the **Business Processes** of the *Participants* as follows:

- Each **Choreography Activity** and the **Sequence Flow** connections is reflected in each *Participant Process*.
- If the senders following the **Gateway** are the same, the **Event-Based Gateway** is reflected as an **Exclusive Gateway** in that *Participant's Process*. This is because the choice of which **Message** to send is determined by the same Participant. If the senders are different, sending occurs through different **Processes**.
- If the receivers are the same, the senders can be the same or different. In this case, the **Event-Based Gateway** is reflected in the receiver's **Process**, with the different **Message** receives following the **Gateway**.
- If the receivers are different, the senders need to be the same. The **Event-Based Gateway** is reflected for different receiver **Processes** such that the respective receive follows the **Gateway**. A time-out can be used to ensure that the **Gateway** does not wait indefinitely.

11.7.3 Inclusive Gateway

Inclusive Gateways are used for modeling points of synchronization of a number of branches, not all of which are active, after which one or more alternative branches are chosen within a **Choreography** flow. For example, one of more branches **MAY** be activated upstream, in parallel, depending on the nature of goods in an order (e.g., large orders, fragile goods orders, orders belonging to pre-existing shipment contracts), and these are subsequently merged. The point of merge results in one or more risk mitigating outcomes (e.g., special insurance protection needed, special packaging needed, and different container categories needed). **Inclusive Gateways** are also used within an *Orchestration Process* see page 291.

Like **Exclusive Gateways**, **Inclusive Gateways** are used in a **Choreography**, but they are constrained by the lack of a central mechanism to store the data that will be used in the *Condition* expressions of the **Gateway's outgoing Sequence Flows**. **Choreographies** **MAY** contain natural language descriptions of the **Gateway's Conditions** to document the one more alternative paths of the **Choreography** (e.g., “special insurance protection needed,” “special packaging needed,” and different “container category needed”), but such **Choreographies** would be underspecified and would not be *enforceable*. To create an *enforceable Choreography*, the **Gateway Conditions** **MUST** be formal *Condition Expressions*. In general the following rules apply for the *Expressions*.

Like the enforceability of the **Exclusive Gateway**, the **Inclusive Gateway** in a **Choreography** requires that the data in the *Expressions* of the outgoing **Sequence Flows** of the **Gateway** be available to the initiators of the **Choreography Activities** of *outgoing Sequence Flows*. This means that the initiators of these **Choreography Activities** should also be senders or receivers of **Messages** in **Choreography Activities** immediately preceding the **Gateway**. The major difference, however, is that the synchronizing behavior of the **Inclusive Gateway** can only be enforced through one participant. Hence, the rules for enforceability are as follows:

- ◆ The data used for **Gateway Conditions** **MUST** have been in a **Message** that was sent prior to (upstream from) the **Gateway**.
- ◆ More specifically, all *Participants* that are directly affected by the **Gateway** **MUST** have either sent or received the **Message(s)** that contained the data used in the *Conditions*.
 - ◆ Furthermore, all these *Participants* **MUST** have the same understanding of the data. That is, the actual values of the data cannot selectively change after a *Participant* has seen a **Message**. Changes to data during the course of the **Choreography** **MUST** be visible to all the *Participants* affected by the **Gateway**.
- ◆ Merge: In order to enforce the synchronizing merge of the **Gateway**, the sender of the **Choreography Activity** after the **Gateway** **MUST** participate in the **Gateway** immediately preceding the **Gateway**. This ensures that the merge can be enforced. (This relies on the assumption of logical atomicity of a **Choreography Activity**, otherwise the rule would require that all receivers are the same so that the **Gateway** is enforced in the receiver's **Process** only).
- ◆ Split: In order to enforce the split side of the **Gateway**, the initiators of all **Choreography Activities** immediately following the **Gateway** **MUST** be the same as the common sender or receiver of **Choreography Activities** preceding the **Gateway**. The sender(s) of all the **Choreography Activities** after the **Gateway** **MUST** be involved in all the **Choreography Activities** that immediately precede the **Gateway**.

Figure 11.40 shows an example of a **Choreography** with an **Inclusive Gateway**. The **Gateway** is enforced in the corresponding **Business Processes** of the *Participants* involved. For the merge behavior to be enforced, the initiator of **Choreography Activities** immediately following the **Gateway** participates in the **Choreography Activities** immediately preceding the **Gateway**.

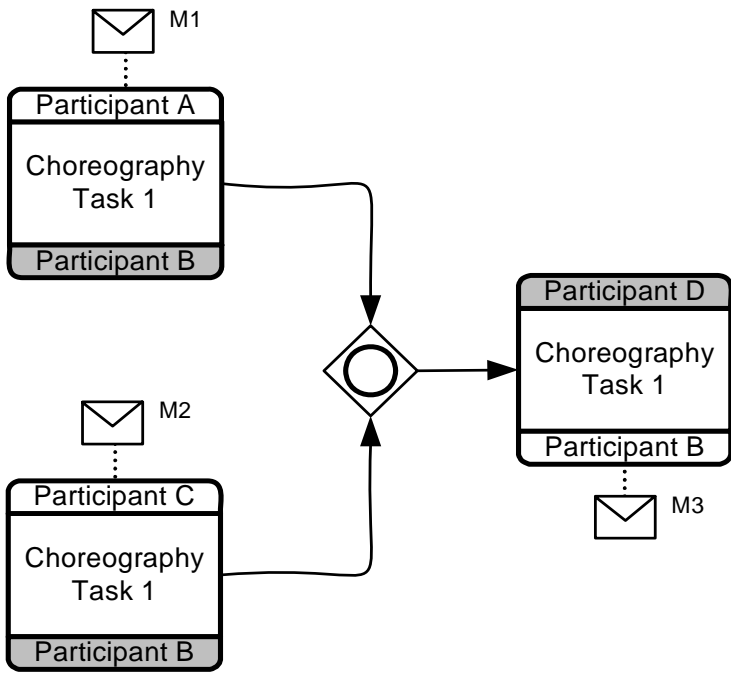

Figure 11.40 – An example of a Choreography Inclusive Gateway configuration

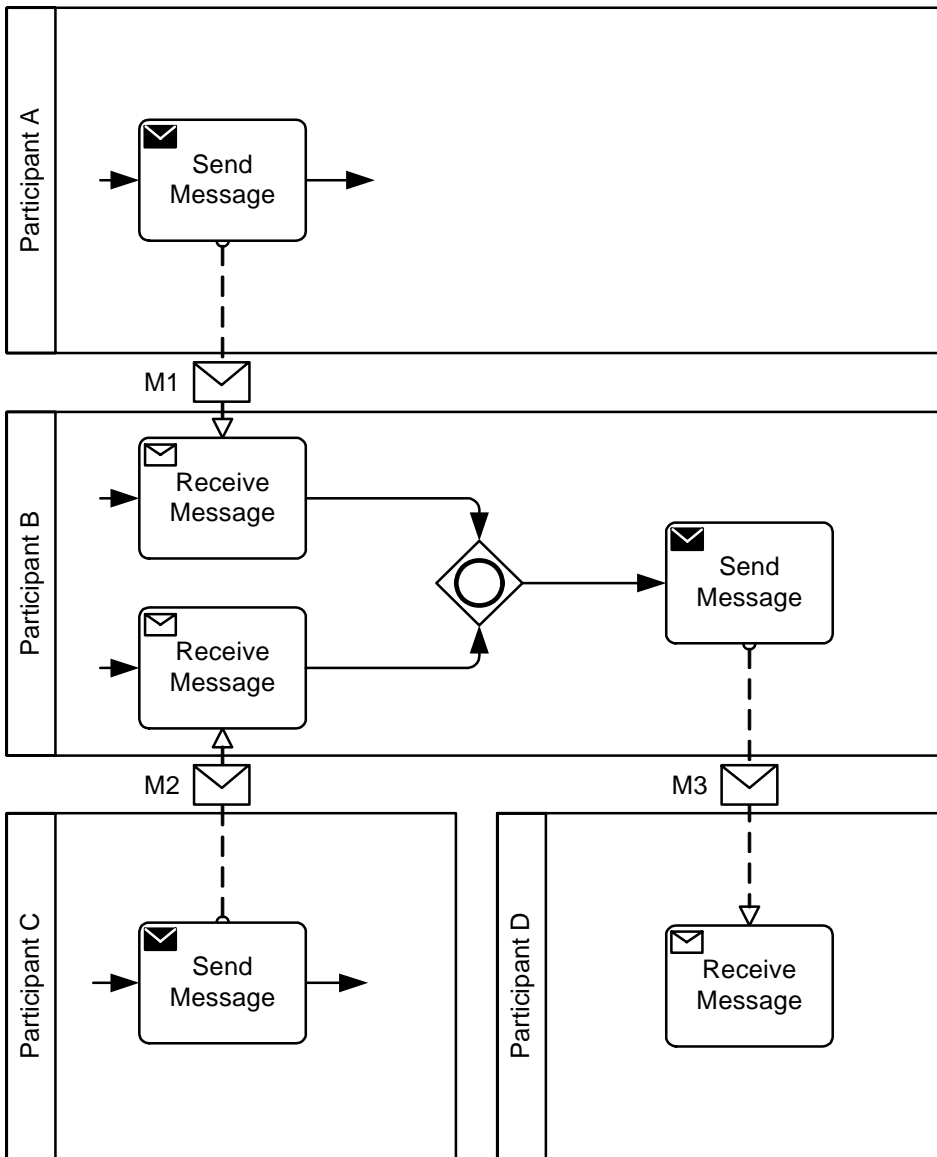

Figure 11.41 – The corresponding Collaboration view of the above Choreography Inclusive Gateway configuration

Figure 11.42, a variation of Figure 11.40 above, shows an example of a **Choreography** illustrating the enforcement of the split behavior of the **Inclusive Gateway**. For the split behavior to be enforced, the initiators of **Choreography Activities** immediately following the **Gateway** and the receiver of **Choreography Activities** immediately preceding the **Gateway** are the same Participant (i.e., A).

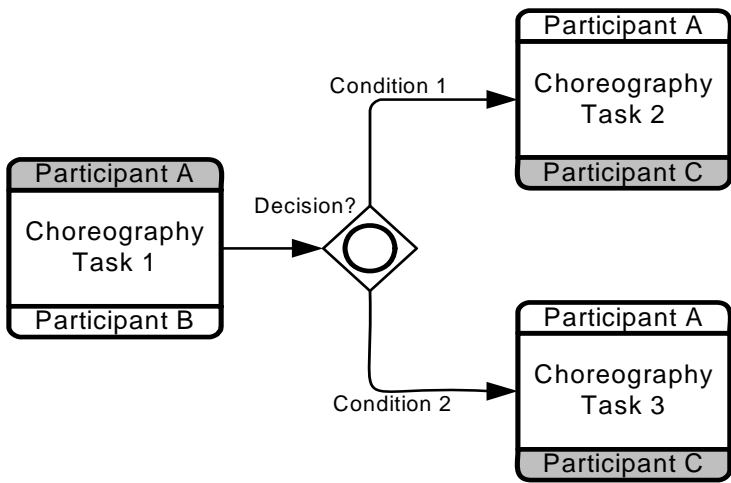

Figure 11.42 – An example of a Choreography Inclusive Gateway configuration

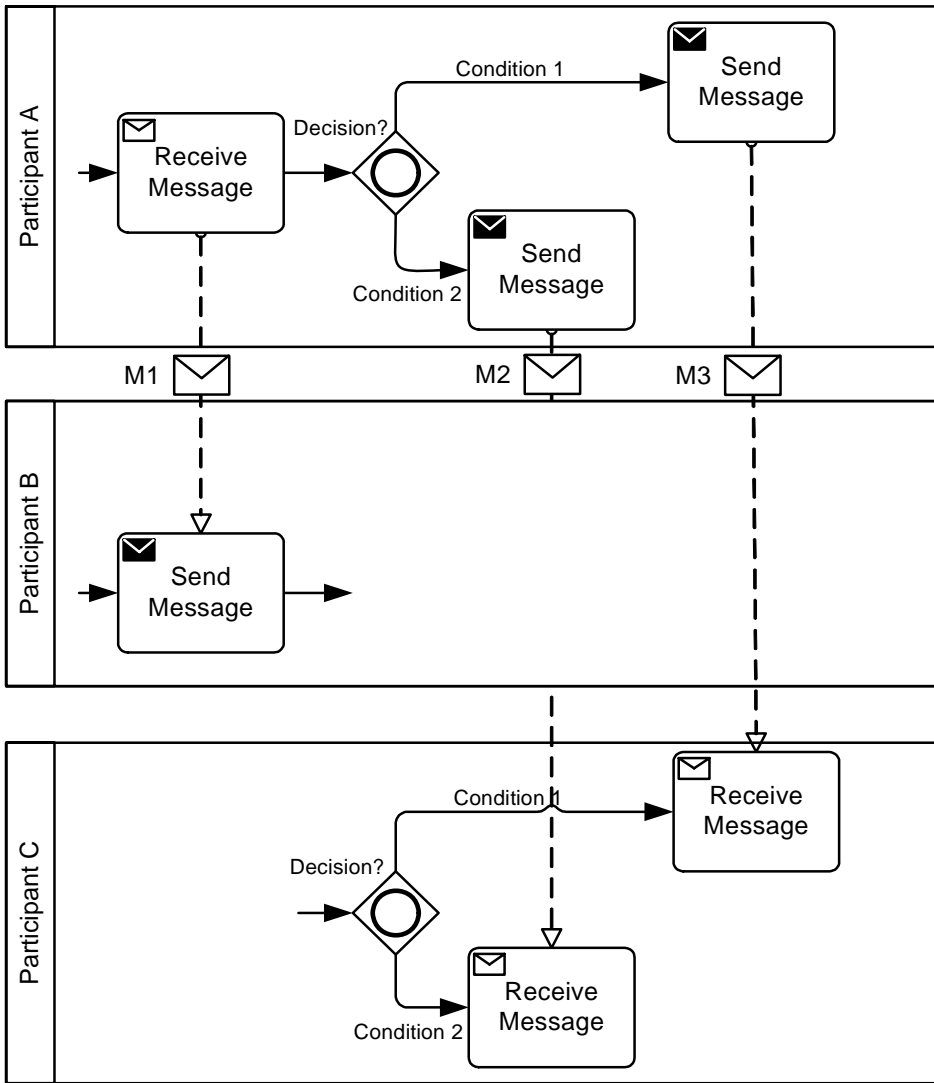

Figure 11.43 – The corresponding Collaboration view of the above Choreography Inclusive Gateway configuration

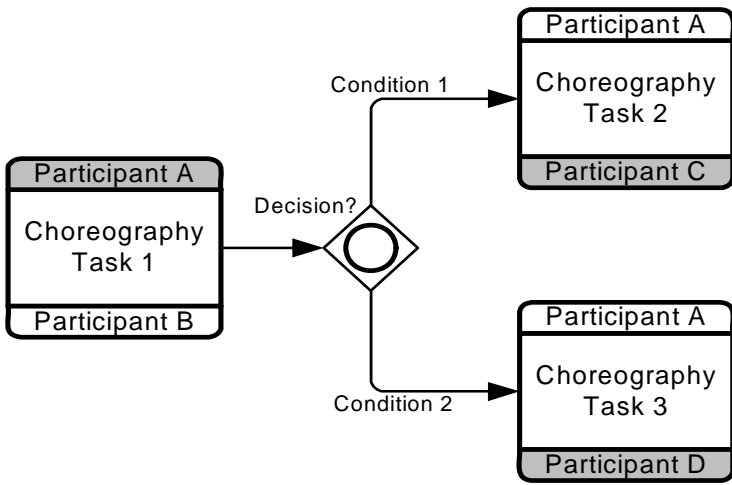

Figure 11.44 – Another example of a Choreography Inclusive Gateway configuration

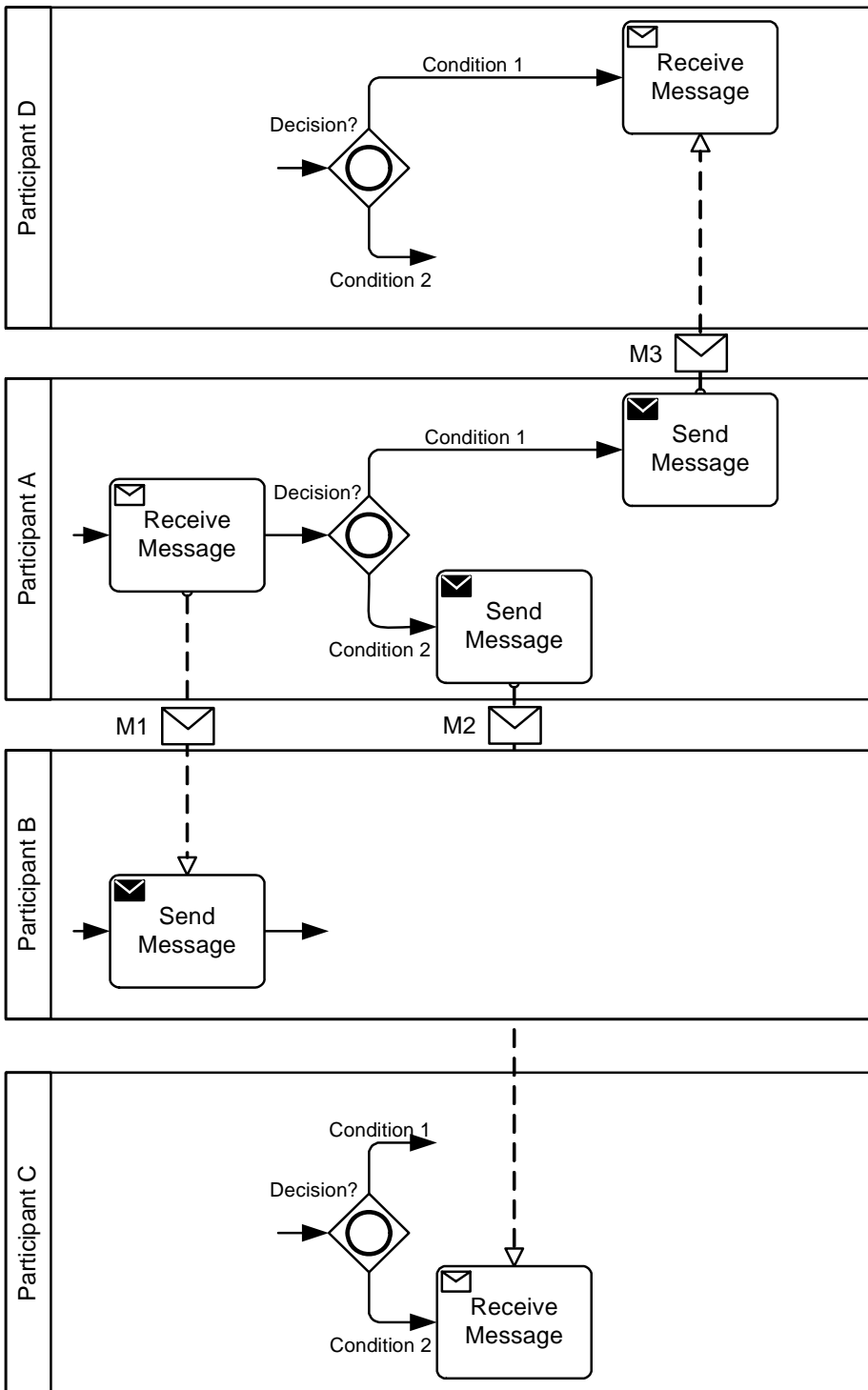

Figure 11.45 – The corresponding Collaboration view of the above Choreography Inclusive Gateway configuration

11.7.4 Parallel Gateway

Parallel Gateways are used to create paths and are performed at the same time, within a **Choreography** flow. For details of how **Parallel Gateways** are used within an *Orchestration Process* see page 292.

Since there is no conditionality for these **Gateways**, they are available as-is in **Choreography**. They create parallel paths of the **Choreography** that all *Participants* are aware of.

- ◆ The sender(s) of all the **Activities** after the **Gateway** **MUST** be involved in all the **Activities** that immediately precede the **Gateway**.
- ◆ If there is a chain of **Gateways** with no **Choreography Activities** in between, the **Choreography Activity** that precedes the chain satisfies the above constraint.

Figure 11.46 shows the relationship of **Choreography Activity Participants** across the sides of the **Parallel Gateway**.

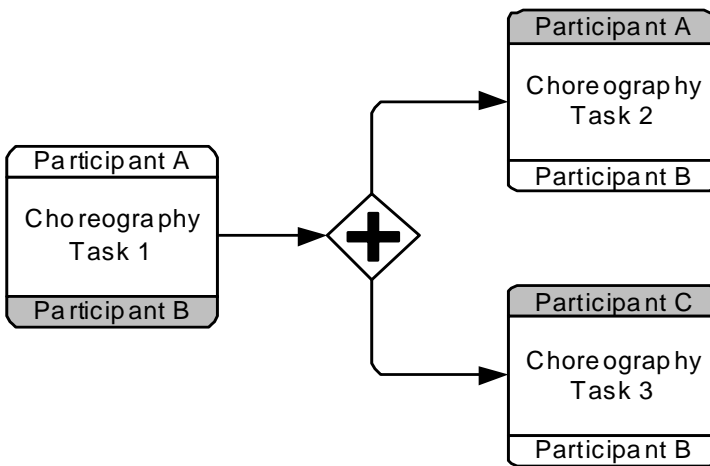

Figure 11.46 – The relationship of Choreography Activity Participants across the sides of the Parallel Gateway

Figure 11.47 shows the corresponding **Collaboration** view of the above **Choreography Parallel Gateway** configuration.

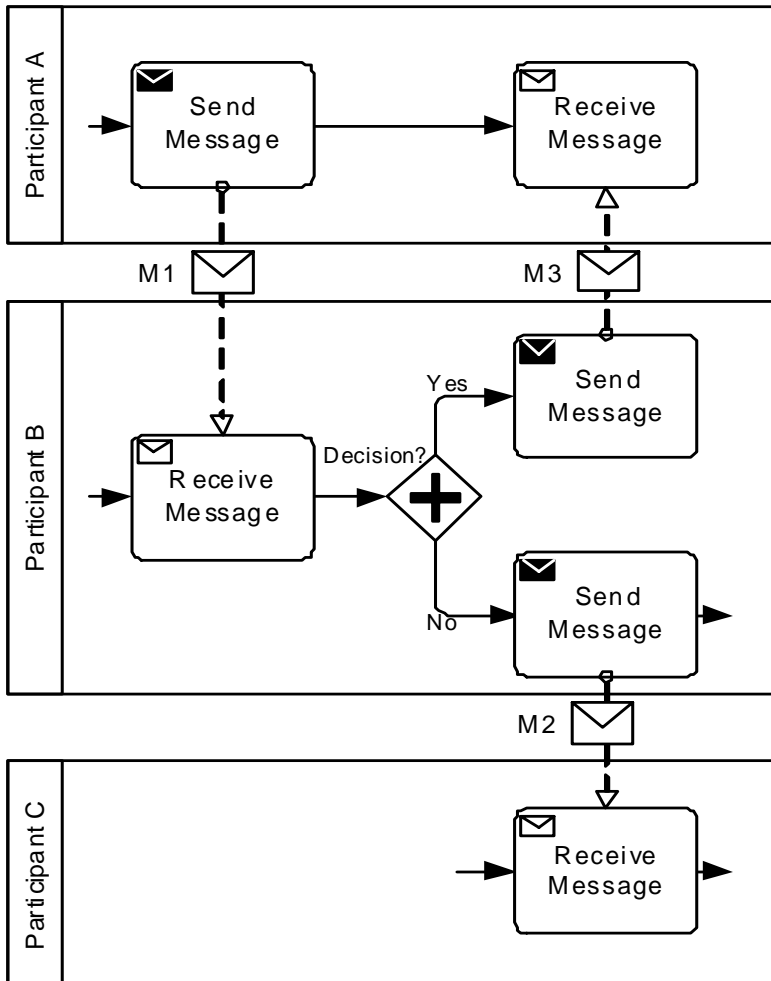

Figure 11.47 – The corresponding Collaboration view of the above Choreography Parallel Gateway configuration

The REQUIRED execution behavior of the **Parallel Gateway** and associated **Choreography Activities** are enforced through the **Business Processes** of the *Participants* as follows:

- ◆ Each **Choreography Activity** and the **Sequence Flow** connections is reflected in each *Participant Process*.
- ◆ If the senders following the **Parallel Gateway** are the same, a **Parallel Gateway** is reflected in the sender's **Process** followed by **Message** sending actions to the corresponding receivers.
- ◆ If the senders are different, the **Parallel Gateway** is manifested by **Sequence Flows** followed by the sending action in each **Process**.

11.7.5 Complex Gateway

Complex Gateways can model partial merges in **Business Processes** where when some but not all of a set of preceding branches complete, the **Gateway** fires. This can be considered the discriminator/n-of-m join pattern¹ and is not supported through the inclusive OR merge since it is not concerned with sets of branches, but rather branches that have *tokens*. Applied in **Choreographies**, **Complex Gateways** can model tendering and information canvassing use cases where requests are sent to participants who respond at different times.

Consider an e-tender that sends a request for quote to multiple service providers (e.g., warehouse storage) in a marketplace. The e-tender **Process** sends out requests to each service provider and anticipates their response through three **Choreography Activities**. The response branches merge at a **Complex Gateway** to model the requirement that when 66% responses have arrived, an assessment of the tender can proceed. The assessment occurs after the **Complex Gateway**. If the assessment reports that the reserve amount indicated by the customer cannot be met, a new iteration of the tender is made. A **Terminate End Event** ensures that all **Activities** are terminated, when a tender has been successful.

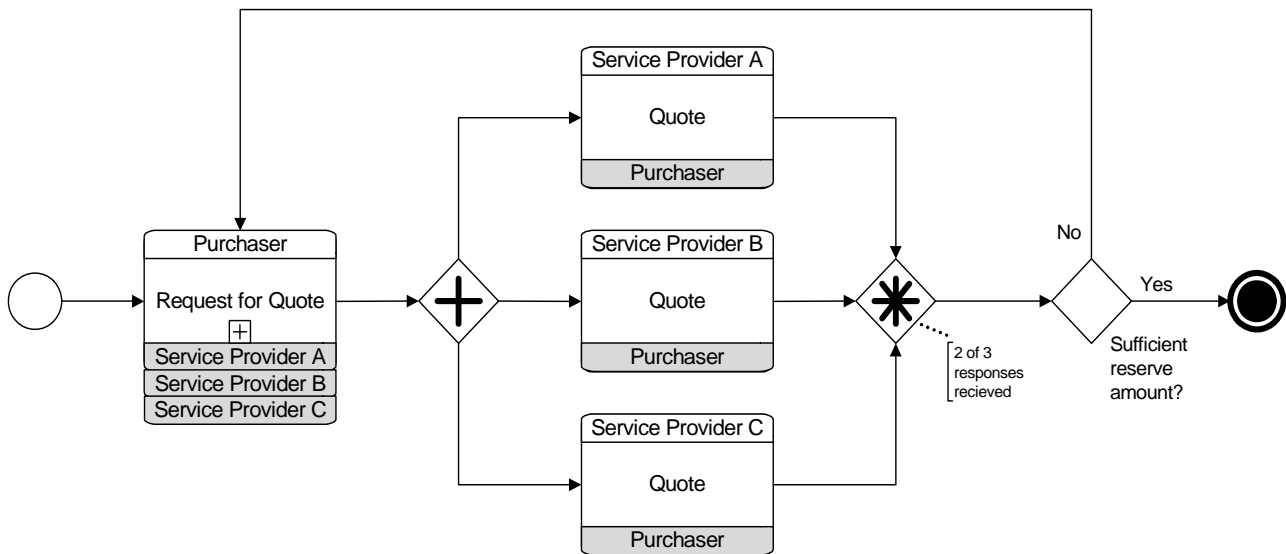

Figure 11.48 – An example of a Choreography Complex Gateway configuration

1. http://www.workflowpatterns.com/patterns/control/advanced_branching/wcp9.php

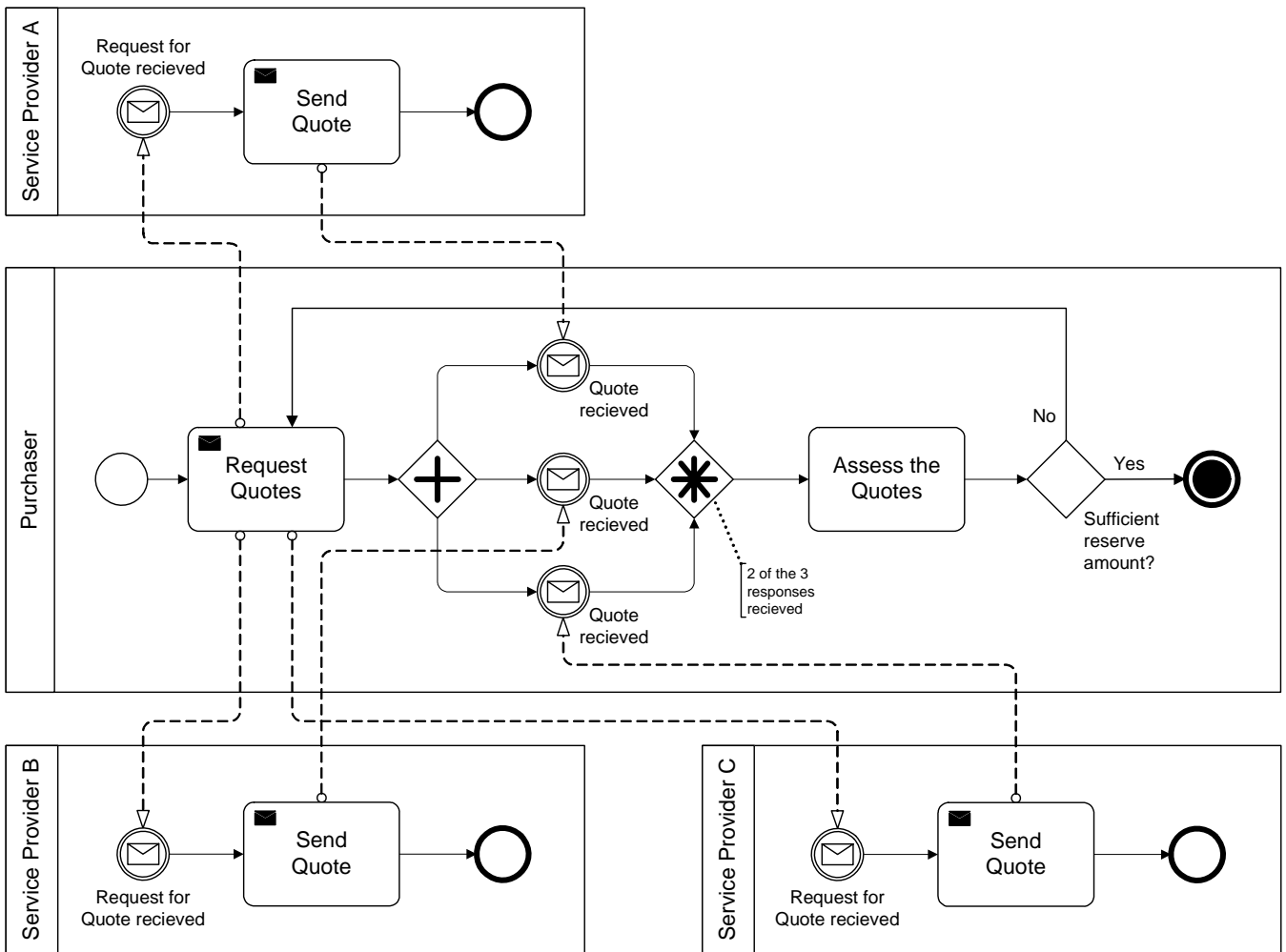

Figure 11.49 – The corresponding Collaboration view of the above Choreography Complex Gateway configuration

11.7.6 Chaining Gateways

It is possible to chain **Gateways**. This means that a modeler can sequence two or more **Gateways** without any intervening **Choreography Activities**, however the constraints on what participants can appear before and after the chain **MUST** be observed.

11.8 Choreography within Collaboration

11.8.1 Participants

Participants are used in both **Collaborations** and **Choreographies**.

11.8.2 Swimlanes

Swimlanes, both **Pools** and **Lanes**, are not used in **Choreographies**. **Pools** are used exclusively in **Collaborations** (see page 113). *Participants*, which can be associated to **Pools**, however, are used in the *Participant Bands* of **Choreography Tasks** (see page 323) and **Sub-Choreographies** (see page 328). **Pools** can be used with **Choreography** diagrams when in the context of a **Collaboration** diagram (see page 361).

Lanes are not used in **Choreography** diagrams since **Lanes** are sub-partitions of a **Pool** and **Choreographies** are placed in between the **Pools** (if used in a **Collaboration**).

Figure 11.50 shows an example of a **Choreography Process** combined with Black Box **Pools**.

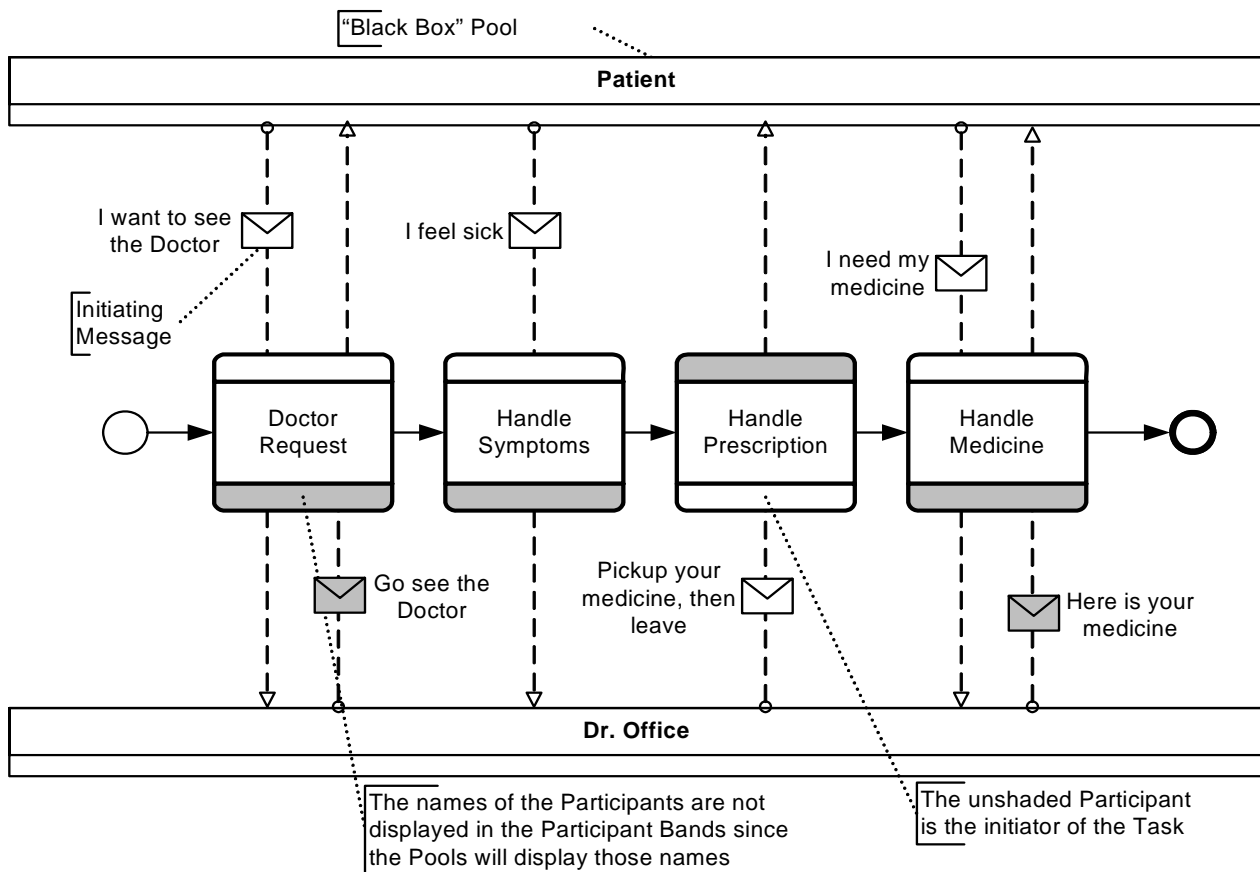

Figure 11.50 – An example of a Choreography Process combined with Black Box Pools

Figure 11.51 shows an example of a **Choreography Process** combined with **Pools** that contain **Processes**.

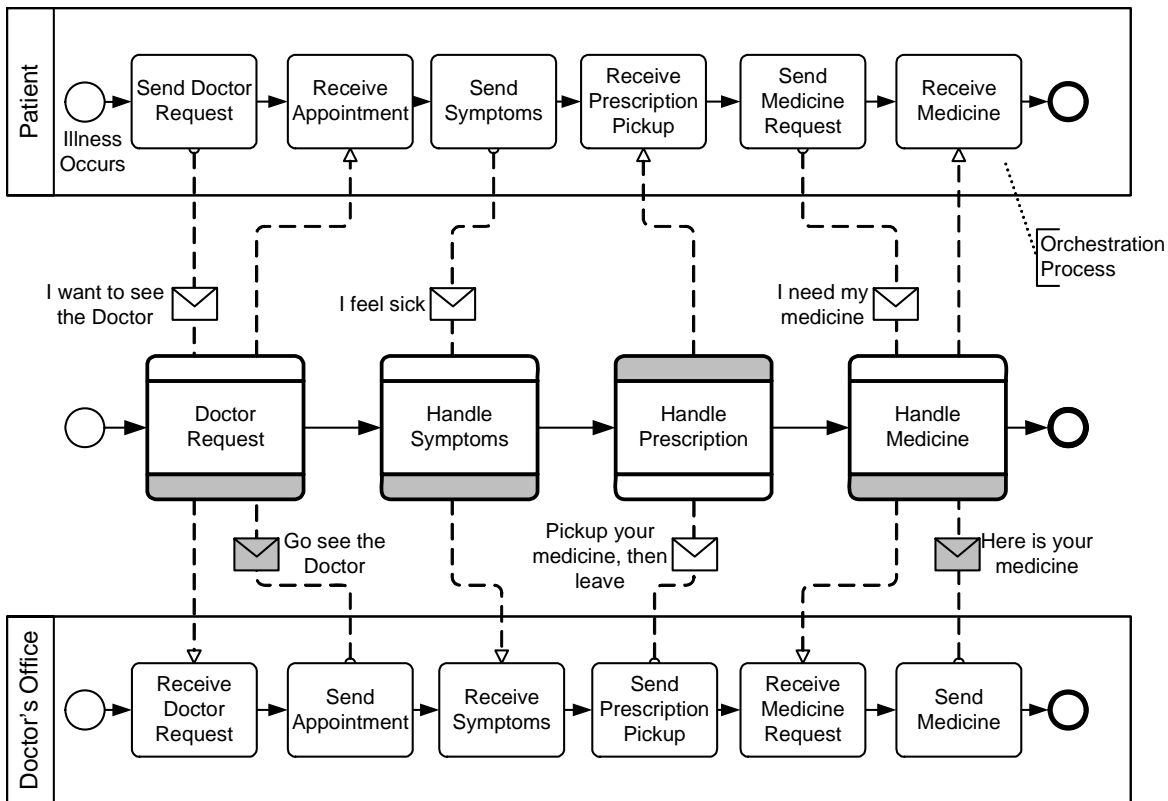

Figure 11.51 – An example of a Choreography Process combined with Pools that contain Processes

Choreography Task in Combined View

Sub-Choreography in Combined View

11.9 XML Schema for Choreography

Table 11.9 – Choreography XML schema

```

<xsd:element name="choreography" type="tChoreography" substitutionGroup="collaboration"/>
<xsd:complexType name="tChoreography">
  <xsd:complexContent>
    <xsd:extension base="tCollaboration">
      <xsd:sequence>
        <xsd:element ref="flowElement" minOccurs="0" maxOccurs="unbounded"/>
      </xsd:sequence>
    </xsd:extension>
  </xsd:complexContent>
</xsd:complexType>

```

Table 11.10 – GlobalChoreographyTask XML schema

```
<xsd:element name="globalChoreographyTask" type="tGlobalChoreographyTask"
  substitutionGroup="choreography"/>
<xsd:complexType name="tGlobalChoreographyTask">
  <xsd:complexContent>
    <xsd:extension base="tChoreography">
      <xsd:attribute name="initiatingParticipantRef" type="xsd:QName"/>
    </xsd:extension>
  </xsd:complexContent>
</xsd:complexType>
```

Table 11.11 – ChoreographyActivity XML schema

```
<xsd:element name="choreographyActivity" type="tChoreographyActivity"/>
<xsd:complexType name="tChoreographyActivity" abstract="true">
  <xsd:complexContent>
    <xsd:extension base="tFlowNode">
      <xsd:sequence>
        <xsd:element name="participantRef" type="xsd:QName" minOccurs="2"
          maxOccurs="unbounded"/>
        <xsd:element name="correlationKey" minOccurs="0" maxOccurs="unbounded"/>
      </xsd:sequence>
      <xsd:attribute name="initiatingParticipantRef" type="xsd:QName" use="required"/>
      <xsd:attribute name="loopType" type="tChoreographyLoopType" default="None"/>
    </xsd:extension>
  </xsd:complexContent>
<xsd:complexType>
<xsd:simpleType name="tChoreographyLoopType">
  <xsd:restriction base="xsd:string">
    <xsd:enumeration value="None">
    <xsd:enumeration value="Standard">
    <xsd:enumeration value="MultiInstanceSequential">
    <xsd:enumeration value="MultiInstanceParallel">
  </xsd:restriction>
</xsd:simpleType>
```

Table 11.12 – ChoreographyTask XML schema

```
<xsd:element name="choreographyTask" type="tChoreographyTask" substitutionGroup="flowElement"/>
<xsd:complexType name="tChoreographyTask">
  <xsd:complexContent>
    <xsd:extension base="tChoreographyActivity">
      <xsd:sequence>
        <xsd:element name="messageFlowRef" type="xsd:QName" minOccurs="1" maxOccurs="2"/>
      </xsd:sequence>
    </xsd:extension>
  </xsd:complexContent>
</xsd:complexType>
```

Table 11.13 – CallChoreography XML schema

```
<xsd:element name="callChoreography" type="tCallChoreography" substitutionGroup="flowElement"/>
<xsd:complexType name="tCallChoreography">
  <xsd:complexContent>
    <xsd:extension base="tChoreographyActivity">
      <xsd:sequence>
        <xsd:element ref="participantAssociation" minOccurs="0" maxOccurs="unbounded"/>
      </xsd:sequence>
      <xsd:attribute name="calledChoreographyRef" type="xsd:QName" use="optional"/>
    </xsd:extension>
  </xsd:complexContent>
</xsd:complexType>
```

Table 11.14 – SubChoreography XML schema

```
<xsd:element name="subChoreography" type="tSubChoreography" substitutionGroup="flowElement"/>
<xsd:complexType name="tSubChoreography">
  <xsd:complexContent>
    <xsd:extension base="tChoreographyActivity">
      <xsd:sequence>
        <xsd:element ref="flowElement" minOccurs="0" maxOccurs="unbounded"/>
        <xsd:element ref="artifact" minOccurs="0" maxOccurs="unbounded"/>
      </xsd:sequence>
    </xsd:extension>
  </xsd:complexContent>
</xsd:complexType>
```

12 BPMN Notation and Diagrams

12.1 BPMN Diagram Interchange (BPMN DI)

12.1.1 Scope

This clause specifies the meta-model and schema for **BPMN 2.0.1** Diagram Interchange (**BPMN DI**). The **BPMN DI** is meant to facilitate interchange of **BPMN** diagrams between tools rather than being used for internal diagram representation by the tools. The simplest interchange approach to ensure the unambiguous rendering of a **BPMN** diagram was chosen for **BPMN DI**. As such, **BPMN DI** does not aim to preserve or interchange any “tool smarts” between the source and target tools (e.g., layout smarts, efficient styling, etc.).

BPMN DI does not address or define the interchange of color information. The use of alternative colors in **BPMN** is non normative. The meaning or semantic of colors might vary from tool to tool or, from user to user, potentially leading to miss-interpretations.

BPMN DI does not ascertain that the **BPMN** diagram is syntactically or semantically correct.

12.1.2 Diagram Definition and Interchange

The **BPMN DI** meta-model, similar to the **BPMN** abstract syntax meta-model, is defined as a MOF-based meta-model. As such, its instances can be serialized and interchanged using XML. **BPMN DI** is also defined by an XML schema. Thus its instances can also be serialized and interchanged using XML.

Both **BPMN DI** meta-model and schema are harmonized with a draft version of the **OMG** Diagram Definition (**DD**) standard. Annex B contains the relevant parts of the referenced **DD** specifications that were used as foundation for the **BPMN DI** model and schema. The provided **DD** contains two main parts: the Diagram Commons (**DC**) and the Diagram Interchange (**DI**). The **DC** defines common types like bounds and fonts, while the **DI** provides a framework for defining domain specific diagram models. As a domain specific **DI**, **BPMN DI** defines a few new meta-model classes that derive from the abstract classes from **DI**.

The focus of **BPMN DI** is the interchange of laid out shapes and edges that constitute a **BPMN** diagram. Each shape and edge references a particular **BPMN** model element. The referenced **BPMN** model elements are all part of the actual **BPMN** model. As such, **BPMN DI** is meant to only contain information that is neither present, nor derivable, from the **BPMN** model whenever possible. Simply put, to render a **BPMN** diagram both the **BPMN DI** instance(s) and the referenced **BPMN** model are **REQUIRED**.

From the **BPMN DI** perspective, a **BPMN** diagram is a particular snapshot of a **BPMN** model at a certain point in time. Multiple **BPMN** diagrams can be exchanged referencing model elements from the same **BPMN** model. Each diagram may provide an incomplete or partial depiction of the content of the **BPMN** model. **BPMN DI** does not ascertain that the **BPMN** diagram is syntactically or semantically correct.

As described in Clause 15, a **BPMN** model package consists of one or more files. Each file may contain any number of **BPMN** diagrams. The exporting tool is free to decide how many diagrams are exported and the importing tool is free to decide if and how to present the contained diagrams to the user.

12.1.3 How to Read this Clause

The normative BPMN 2.0 Diagram Interchange (BPMN DI) specification has three parts. Sub clause 12.2 defines BPMN DI; an instance of the DI meta-model provided at Annex B. Sub clause 12.3 provides a library of the BPMN element depictions and an unambiguous resolution between a referenced BPMN model element and its depiction. Finally, sub clause 12.4 provides examples to support the interpretation of the specification. Some BPMN diagram depictions along with their XML BPMN DI serializations are provided.

12.2 BPMN Diagram Interchange (DI) Meta-model

12.2.1 Overview

The BPMN DI is an instance of the DI meta-model provided at Annex B. The basic concept of BPMN DI, as with DI in general, is that serializing a diagram [BPMNDiagram] for interchange requires the specification of a collection of shapes [BPMNShape] and edges [BPMNEdge] on a plane [BPMNPlane].

BPMNPlane, BPMNShape, and BPMNEdge MUST reference exactly one abstract syntax BPMN element from the BPMN model using the bpmnElement attribute. The only exception is for a Data Association connected to a Sequence Flow (See Figure 10.68). This is a visual short cut that actually normalizes two Data Associations within the BPMN model. In this case, the resolution is made from the BPMN DI attributes rather than the abstract syntax reference [bpmnElement] (See Table 12.35).

The BPMN DI classes only define the visual properties used for depiction. All other properties that are REQUIRED for the unambiguous depiction of the BPMN element are derived from the referenced bpmnElement.

Multiple depictions of a specific BPMN element in a single diagram is NOT allowed, except for Participants in a choreography (i.e., Participant Bands). For example, it is not allowed to depict a Task twice in the same diagram, but it is allowed to depict the same Task in two different diagrams.

BPMN diagrams may be an incomplete or partial depiction of the content of the BPMN model. Some BPMN elements from a BPMN model may not be present in any of the diagram instances being interchanged.

BPMN DI does not provide for any containment concept. The BPMNPlane is an ordered collection of mixed BPMNShape(s) and BPMNEdge(s). The order of the BPMNShape(s) and BPMNEdge(s) inside a BPMNPlane determines their Z-order (i.e., what is in front of what). BPMNShape(s) and BPMNEdge(s) that are meant to be depicted “on top” of other BPMNShape(s) and BPMNEdge(s) MUST appear after them in the BPMNPlane. Therefore, the exporting tool MUST order all BPMNShape(s) and BPMNEdge(s) such that the desired depiction can be rendered.

12.2.2 Abstract Syntax

This sub clause introduces the Abstract Syntax of BPMN DI. BPMN DI is an instance of the DI meta-model provided at Annex B.

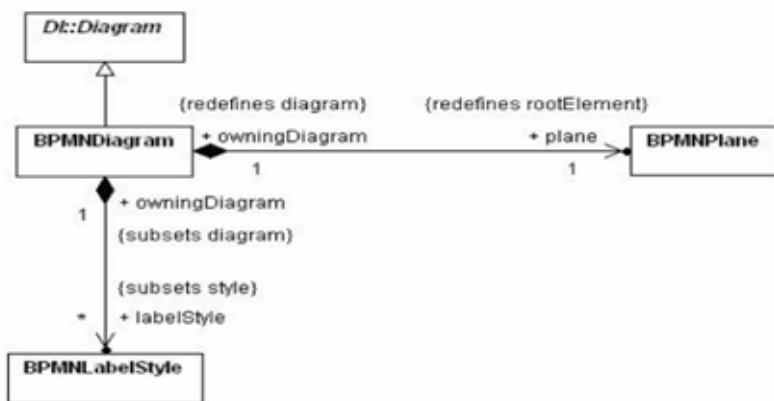

Figure 12.1 – BPMN Diagram

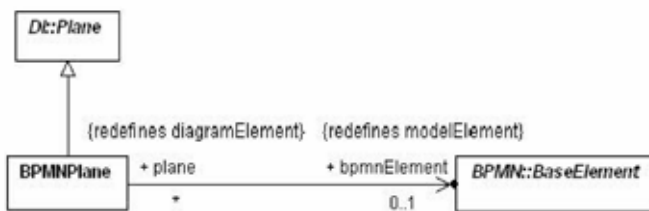

Figure 12.2 – BPMN Plane

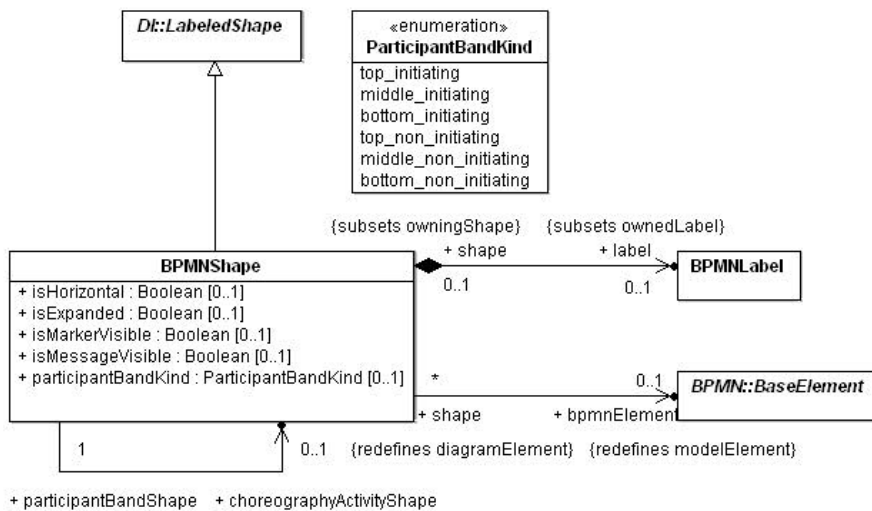

Figure 12.3 – BPMN Shape

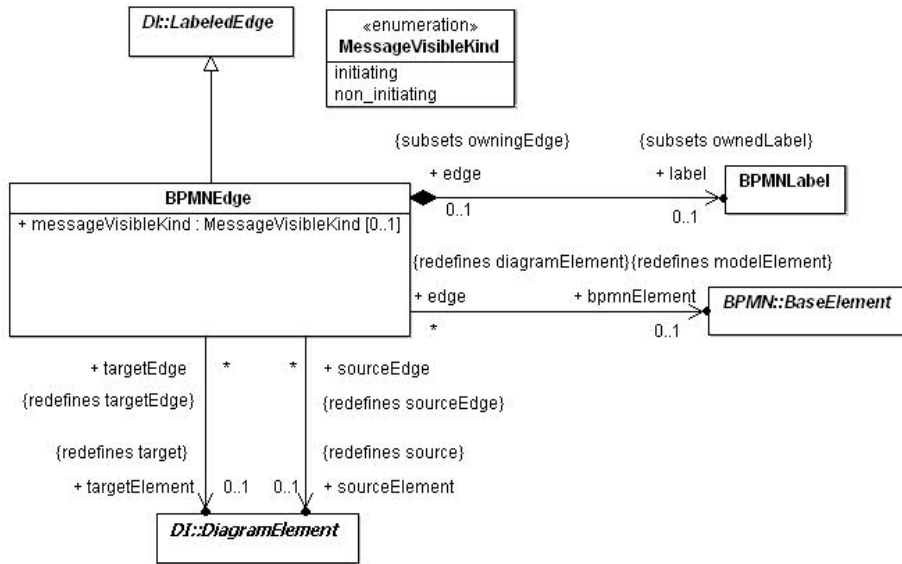

Figure 12.4 – BPMN Edge



Figure 12.5 – BPMN Label

12.2.3 Classifier Descriptions

12.2.3.1 BPMNDiagram [Class]

BPMNDiagram is a kind of diagram that depicts all or part of a BPMN model.

Description

BPMNDiagram represents a depiction of all or part of a BPMN model. It specializes `DI::Diagram` and redefines the root element (the top most diagram element) to be of type `BPMNPlane`. A BPMN diagram can also own a collection of `BPMNStyle` elements that are referenced by `BPMNLabel` elements in the diagram. These style elements represent the unique appearance styles used in the diagram.

Abstract Syntax

- Figure 12.1 - BPMN Diagram

Generalizations

- DI::Diagram

Associations

- + plane : BPMNPlane [1] {redefines rootElement}
a BPMN plane element that is the container of all diagram elements in this diagram.
- + labelStyle : BPMNLabelStyle [*] {subsets style}
a collection of BPMN label styles that are owned by the diagram and referenced by label elements.

Table 12.1 – BPMNDiagram XML schema

```
<xsd:complexType name="BPMNDiagram">
  <xsd:complexContent>
    <xsd:extension base="di:Diagram">
      <xsd:sequence>
        <xsd:element ref="bpmndi:BPMNPlane"/>
        <xsd:element ref="bpmndi:BPMNLabelStyle" minOccurs="0" maxOccurs="unbounded"/>
      </xsd:sequence>
    </xsd:extension>
  </xsd:complexContent>
</xsd:complexType>
```

12.2.3.2 BPMNPlane [Class]

A BPMNPlane is the BPMNDiagram container of BPMNShape and BPMNEdge.

Description

A BPMNPlane specializes DI::Plane and redefines its model element reference to be of type (BPMN) BaseElement. A BPMNPlane can only reference a BaseElement of the types: Process, SubProcess, AdHocSubProcess, Transaction, Collaboration, Choreography or SubChoreography.

BPMNPlane element is always owned by a BPMNDiagram and represents the root diagram element of that diagram. The plane represents a 2 dimensional surface with an origin at (0, 0) along the x and y axes with increasing coordinates to the right and bottom. Only positive coordinates are allowed for diagram elements that are nested in a BPMNPlane. This means that the union of all the nested elements' bounds is deemed to be located at the plane's origin point.

Abstract Syntax

- Figure 12.1 - BPMN Diagram
- Figure 12.2 - BPMN Plane

Generalizations

- DI::Plane

Associations

- + bpmnElement : BaseElement [0..1] {redefines modelElement}

a reference to either a Process, SubProcess, AdHocSubProcess, Transaction, Collaboration, Choreography or SubChoreography in a BPMN model.

Table 12.2 – BPMNPlane XML schema

```
<xsd:complexType name="BPMNPlane">
  <xsd:complexContent>
    <xsd:extension base="di:Plane">
      <xsd:attribute name="bpmnElement" type="xsd:QName"/>
    </xsd:extension>
  </xsd:complexContent>
</xsd:complexType>
```

12.2.3.3 BPMNShape [Class]

BPMNShape is a kind of shape that can depict a BPMN model element.

Description

BPMNShape represents a depiction of a (typically a node) BPMN model element. It specializes DI::LabeledShape and redefines its model element reference to be of type (BPMN) BaseElement, allowing it to reference an element from a BPMN model.

BPMNShape also contains an optional label of type BPMNLabel that can be nested in the shape when it has a visible textual label with its own bounding box.

The shape also contains a number of normative notational options that can be specified for different types of BPMN elements depicted by the shape. Those options, each represented by a separate property, and described below, allow for recording the specific notational style desired for the shape.

All BPMNShape elements are owned directly by a BPMNPlane (that is the root element in a BPMNDiagram), i.e., shapes are not nested within each other in the BPMN DI model although they may appear that way when depicted. The bounds of a BPMNShape are always relative to that plane's origin point and are REQUIRED to be positive coordinates. Note that the bounds' x and y coordinates are the position of the upper left corner of the shape (relative to the upper left corner of the plane).

Abstract Syntax

- Figure 12.3 - BPMN Shape
- Figure 12.4 - BPMN Edge

Generalizations

- DI::LabeledShape

Attributes

- + isHorizontal : Boolean [0..1]
an optional attribute that should be used only for Pools and Lanes. It determines if it should be depicted horizontally (true) or vertically (false).
- + isExpanded : Boolean [0..1]
an optional attribute that should be used only for SubProcess, AdHocSubProcess, Transaction, SubChoreographies, CallActivities, and CallChoreographies. It determines if it should be depicted expanded (true) or collapsed (false).
- + isMarkerVisible : Boolean [0..1]
an optional attribute that should be used only for Exclusive Gateway. It determines if the marker should be depicted on the shape (true) or not (false).
- + participantBandKind : ParticipantBandKind [0..1]
an optional attribute that should only be used for Participant Bands. If this attribute is present, it means that the participant should be depicted as a Participant Band instead of as a Pool.
- + isMessageVisible : Boolean [0..1]
an optional attribute that should only be used for Participant Bands. It determines if an envelope decorator should be depicted linked to the Participant Band.
- + choreographyActivityShape : BPMNShape [0..1]
an optional attribute that should only be used for Participant Bands. It is REQUIRED for a BPMNShape depicting a Participant Band. This is REQUIRED in order to relate the Participant Band to the BPMNShape depicting the Choreography Activity that this Participant Band is related to.

Associations

- + bpmnElement : BaseElement [0..1] {redefines modelElement}
a reference to a BPMN node element that this shape depicts. Note that although optional a bpmnElement must be provided for a BPMNShape.
- + label : BPMNLabel [0..1] {subsets ownedLabel}
an optional label that is nested when the shape has a visible text label with its own bounding box.

Table 12.3 – BPMNShape XML schema

```
<xsd:complexType name="BPMNShape">
  <xsd:complexContent>
    <xsd:extension base="di:LabeledShape">
      <xsd:sequence>
        <xsd:element ref="bpmndi:BPMNLabel" minOccurs="0"/>
      </xsd:sequence>
      <xsd:attribute name="bpmnElement" type="xsd:QName"/>
      <xsd:attribute name="isHorizontal" type="xsd:boolean"/>
      <xsd:attribute name="isExpanded" type="xsd:boolean"/>
      <xsd:attribute name="isMarkerVisible" type="xsd:boolean"/>
      <xsd:attribute name="isMessageVisible" type="xsd:boolean"/>
      <xsd:attribute name="participantBandKind" type="bpmndi:ParticipantBandKind"/>
      <xsd:attribute name="choreographyActivityShape" type="xsd:QName"/>
    </xsd:extension>
  </xsd:complexContent>
</xsd:complexType>
```

12.2.3.4 ParticipantBandKind [Enumeration]

ParticipantBandKind defines the type of Participant Band to depict.

Description

Participant bands can be depicted in 3 ways:

1. a top band is rectangular with rounded corners at the top
2. a middle band is rectangular
3. a bottom band is rectangular with rounded corners at the bottom

Participant bands can be depicted in 2 shadings:

1. initiating (the band should not be shaded)
2. non_initiating (the band should be shaded)

Abstract Syntax

- Figure 12.3 - BPMN Shape

Literals

- top_initiating - the band should be depicted as a non shaded top band
- middle_initiating - the band should be depicted as a non shaded middle band
- bottom_initiating - the band should be depicted as a non shaded bottom band
- top_non_initiating - the band should be depicted as a shaded top band
- middle_non_initiating - the band should be depicted as a shaded middle band
- bottom_non_initiating - the band should be depicted as a shaded bottom band

12.2.3.5 BPMNEdge [Class]

BPMNEdge is a kind of edge that can depict a relationship between two BPMN model elements.

Description

BPMNEdge represents a depiction of a relationship between two (source and target) BPMN model elements. It specializes DI::LabeledEdge and redefines its model element reference to be of type (BPMN) BaseElement, allowing it to reference a relationship element from a BPMN model.

BPMNEdge also redefines its source and target references to be of type DiagramElement (either BPMNShape or BPMNEdge).

The source or target definition should only be present if the edge is depicted between a different source or target than the one referenced by the BPMN model element of the BPMNEdge. Only the different source or target is REQUIRED. Both attributes should be present only if both are different. This is the case, for instance, if a Message Flow target is not depicted in the current diagram because it is inside a black box Pool. The Message Flow could then define its target as being the BPMNShape depicting the Pool to connect it to the boundary of that black box Pool.

BPMNEdge also contains an optional label of type BPMNLabel that can be nested in the edge when it has a visible textual label with its own bounding box.

All BPMNEdge elements are owned directly by a BPMNPlane (that is the root element in a BPMNDiagram). The waypoints of BPMNEdge are always relative to that plane's origin point and are REQUIRED to be positive coordinates.

Abstract Syntax

- Figure 12.4 - BPMN Edge

Generalizations

- DI::LabeledEdge

Associations

- + label : BPMNLabel [0..1] {subsets ownedLabel}
an optional label that is nested when the edge has a visible text label with its own bounding box.
- + bpmnElement : BaseElement [0..1] {redefines modelElement}
a reference to a connecting BPMN element that this edge depicts. Note that this reference is only optional for the specific case of a Data Association connected to a Sequence Flow; in all other cases a referenced element must be provided.
- + sourceElement : DiagramElement [0..1] {redefines source}
an optional reference to the edge's source element if it is different from the source inferred from the bpmnElement association.
- + targetElement : DiagramElement [0..1] {redefines target}
an optional reference to the edge's target element if it is different from the target inferred from the bpmnElement association.
- messageVisibleKind : MessageVisibleKind [0..1]
an optional attribute that should be used only for Message Flow. It determines if an envelope decorator should be depicted and the kind of envelope to be depicted.

Table 12.4 – BPMNEdge XML schema

```
<xsd:complexType name="BPMNEdge">
  <xsd:complexContent>
    <xsd:extension base="di:LabeledEdge">
      <xsd:sequence>
        <xsd:element ref="bpmndi:BPMNLabel" minOccurs="0" />
      </xsd:sequence>
      <xsd:attribute name="bpmnElement" type="xsd:QName" />
      <xsd:attribute name="sourceElement" type="xsd:QName" />
      <xsd:attribute name="targetElement" type="xsd:QName" />
      <xsd:attribute name="messageVisibleKind" type="bpmndi:MessageVisibleKind" />
    </xsd:extension>
  </xsd:complexContent>
</xsd:complexType>
```

12.2.3.6 MessageVisibleKind [Enumeration]

MessageVisibleKind defines the type of envelope that is visible.

Description

MessageVisibleKind is applicable only to Participant Band and Message Flow.

For Message Flow, the envelope should be positioned in the middle of the edge.

For Participant Band, the envelope should be positioned over (for top band) or under (for bottom band) and connected to the band using an association. Note that only Choreography Task Participant Bands are allowed to show the envelope. Middle bands being only used for a SubChoreography can thus not have envelope showing.

Abstract Syntax

- Figure 12.3 - BPMN Shape

Literals

- initiating - The envelope should not be shaded.
- non_initiating - The envelope should be shaded.

12.2.3.7 BPMNLabel [Class]

BPMNLabel is a kind of label that depicts textual info about a BPMN element.

Description

BPMNLabel represents a depiction of some textual information about a BPMN element. It specializes DI::Label and redefines its style reference to be of type BPMNLabelStyle, which contains information about the appearance of the label (e.g., the chosen font). The referenced style is owned by the diagram that nests the label.

A BPMN label is not a top-level element but is always nested inside either a BPMNShape or a BPMNEdge. It does not have its own reference to a BPMN element but rather inherits that reference (if any) from its parent shape or edge. The textual info depicted by the label is derived from that referenced BPMN element.

The bounds of BPMNLabel are always relative to the containing plane's origin point. Note that the bounds' x and y coordinates are the position of the upper left corner of the label (relative to the upper left corner of the plane).

Abstract Syntax

- Figure 12.3 - BPMN Shape
- Figure 12.4 - BPMN Edge
- Figure 12.5 - BPMN Label

Generalizations

- DI::Label

Associations

- + labelStyle : BPMNLabelStyle [0..1] {redefines style}
an optional reference to a label style (owned by the diagram) that gives the appearance options for the label. If not specified, the style of the label can be assumed by a tool.

Table 12.5 – BPMNLabel XML schema

```
<xsd:complexType name="BPMNLabel">
  <xsd:complexContent>
    <xsd:extension base="di:Label">
      <xsd:attribute name="labelStyle" type="xsd:QName" />
    </xsd:extension>
  </xsd:complexContent>
</xsd:complexType>
```

12.2.3.8 BPMNLabelStyle [Class]

BPMNLabelStyle is a kind of style that gives the appearance options for a BPMNLabel.

Description

BPMNLabelStyle represents the appearance options for elements of type BPMNLabel. It specializes DI::Style and contains a description of a font that is used in depicting a BPMNLabel. One or more labels may reference the same BPMNLabelStyle element, which must be owned by a BPMNDiagram.

Abstract Syntax

- Figure 12.1 - BPMN Diagram
- Figure 12.5 - BPMN Label

Generalizations

- DI::Style

Attributes

- + font : Font[1] - a font object that describes the properties of the font used for depicting the labels that reference this style.

Table 12.6 – BPMNLabelStyle XML schema

```
<xsd:complexType name="BPMNLabelStyle">
  <xsd:complexContent>
    <xsd:extension base="di:Style">
      <xsd:sequence>
        <xsd:element ref="dc:Font"/>
      </xsd:sequence>
    </xsd:extension>
  </xsd:complexContent>
</xsd:complexType>
```

12.2.4 Complete BPMN DI XML Schema

Table 12.7 – Complete BPMN DI XML schema

```
<xsd:schema xmlns:xsd="http://www.w3.org/2001/XMLSchema" xmlns:bpmndi="http://www.omg.org/spec/BPMN/
  20100524/DI" xmlns:dc="http://www.omg.org/spec/DD/20100524/DC" xmlns:di="http://www.omg.org/spec/
  DD/20100524/DI" targetNamespace="http://www.omg.org/spec/BPMN/20100524/DI"
  elementFormDefault="qualified" attributeFormDefault="unqualified">
  <xsd:import namespace="http://www.omg.org/spec/DD/20100524/DC" schemaLocation="DC.xsd" />
  <xsd:import namespace="http://www.omg.org/spec/DD/20100524/DI" schemaLocation="DI.xsd" />
  <xsd:element name="BPMNDiagram" type="bpmndi:BPMNDiagram" />
  <xsd:element name="BPMNPlane" type="bpmndi:BPMNPlane" />
  <xsd:element name="BPMNLabelStyle" type="bpmndi:BPMNLabelStyle" />
  <xsd:element name="BPMNShape" type="bpmndi:BPMNShape" substitutionGroup="di:DiagramElement" />
  <xsd:element name="BPMNLabel" type="bpmndi:BPMNLabel" />
  <xsd:element name="BPMNEdge" type="bpmndi:BPMNEdge" substitutionGroup="di:DiagramElement" />

  <xsd:complexType name="BPMNDiagram">
    <xsd:complexContent>
      <xsd:extension base="di:Diagram">
        <xsd:sequence>
          <xsd:element ref="bpmndi:BPMNPlane" />
          <xsd:element ref="bpmndi:BPMNLabelStyle" maxOccurs="unbounded" minOccurs="0" />
        </xsd:sequence>
      </xsd:extension>
    </xsd:complexContent>
  </xsd:complexType>
```

Table 12.7 – Complete BPMN DI XML schema

```
<xsd:complexType name="BPMNPlane">
  <xsd:complexContent>
    <xsd:extension base="di:Plane">
      <xsd:attribute name="bpmnElement" type="xsd:QName" />
    </xsd:extension>
  </xsd:complexContent>
</xsd:complexType>

<xsd:complexType name="BPMNEdge">
  <xsd:complexContent>
    <xsd:extension base="di:LabeledEdge">
      <xsd:sequence>
        <xsd:element ref="bpmndi:BPMNLabel" minOccurs="0" />
      </xsd:sequence>
      <xsd:attribute name="bpmnElement" type="xsd:QName" />
      <xsd:attribute name="sourceElement" type="xsd:QName" />
      <xsd:attribute name="targetElement" type="xsd:QName" />
      <xsd:attribute name="messageVisibleKind" type="bpmndi:MessageVisibleKind" />
    </xsd:extension>
  </xsd:complexContent>
</xsd:complexType>

<xsd:complexType name="BPMNShape">
  <xsd:complexContent>
    <xsd:extension base="di:LabeledShape">
      <xsd:sequence>
        <xsd:element ref="bpmndi:BPMNLabel" minOccurs="0" />
      </xsd:sequence>
      <xsd:attribute name="bpmnElement" type="xsd:QName" />
      <xsd:attribute name="isHorizontal" type="xsd:boolean" />
      <xsd:attribute name="isExpanded" type="xsd:boolean" />
      <xsd:attribute name="isMarkerVisible" type="xsd:boolean" />
      <xsd:attribute name="isMessageVisible" type="xsd:boolean" />
      <xsd:attribute name="participantBandKind" type="bpmndi:ParticipantBandKind" />
      <xsd:attribute name="choreographyActivityShape" type="xsd:QName"/>
    </xsd:extension>
  </xsd:complexContent>
</xsd:complexType>
```

Table 12.7 – Complete BPMN DI XML schema

```
<xsd:complexType name="BPMNLabel">
  <xsd:complexContent>
    <xsd:extension base="di:Label">
      <xsd:attribute name="labelStyle" type="xsd:QName" />
    </xsd:extension>
  </xsd:complexContent>
</xsd:complexType>

<xsd:complexType name="BPMNLabelStyle">
  <xsd:complexContent>
    <xsd:extension base="di:Style">
      <xsd:sequence>
        <xsd:element ref="dc:Font" />
      </xsd:sequence>
    </xsd:extension>
  </xsd:complexContent>
</xsd:complexType>

<xsd:simpleType name="ParticipantBandKind">
  <xsd:restriction base="xsd:string">
    <xsd:enumeration value="top_initiating" />
    <xsd:enumeration value="middle_initiating" />
    <xsd:enumeration value="bottom_initiating" />
    <xsd:enumeration value="top_non_initiating" />
    <xsd:enumeration value="middle_non_initiating" />
    <xsd:enumeration value="bottom_non_initiating" />
  </xsd:restriction>
</xsd:simpleType>

<xsd:simpleType name="MessageVisibleKind">
  <xsd:restriction base="xsd:string">
    <xsd:enumeration value="initiating" />
    <xsd:enumeration value="non_initiating" />
  </xsd:restriction>
</xsd:simpleType>

</xsd:schema>
```

12.3 Notational Depiction Library and Abstract Element Resolutions

As a notation, BPMN specifies the depiction for each of the BPMN elements.

Serializing a BPMN diagram for interchange requires the specification of a collection of BPMNShape(s) (see page 372) and BPMNEdge(s) (see page 375) on the BPMNPlane (see page 371) of the BPMNDiagram (see page 370). The BPMNShape(s) and BPMNEdge(s) attributes must be populated in such a way as to allow the unambiguous rendering of the BPMN diagram by the receiving party. More specifically, the BPMNShape(s) and BPMNEdge(s) must reference BPMN model element [bpmnElement]. If no bpmnElement is referenced or if the reference is invalid, it is expected that

this shape or edge should not be depicted. The only exception is for a Data Association connected to a Sequence Flow (See Figure 10.68). This is a visual short cut that actually normalizes two Data Associations within the BPMN model. In this case, the resolution is made from the BPMN DI attributes rather than the abstract syntax reference [bpmnElement] (See Table 12.35 - Depiction Resolution for Connecting Objects).

When rendering a BPMN diagram, the correct depiction of a BPMNShape or BPMNEdge depends mainly on the referenced BPMN model element [bpmnElement] and its particular attributes and/or references.

The purpose of this sub clause is to: provide a library of the BPMN element depictions, and to provide an unambiguous resolution between the referenced BPMN model element [bpmnElement], BPMNShape or BPMNEdge and their depiction. Depiction resolution tables are provided below for both BPMNShape (sub clause 12.3.2) and BPMNEdge (sub clause 12.3.3).

12.3.1 Labels

Both BPMNShape and BPMN Edge may have labels (e.g., its name) placed inside the shape/edge, or above or below the shape/edge, in any direction or location, depending on the preference of the modeler or modeling tool vendor.

Labels are optional for BPMNShape and BPMNEdge. When there is a label, the position of the label is specified by the bounds of the BPMNLabel of the BPMNShape or BPMNEdge. Simply put, label visibility is defined by the presence of the BPMNLabel element. The bounds of the BPMNLabel are optional and always relative to the containing BPMNPlane's origin point (see page 376). The depiction resolution tables provided below exemplify default label positions for BPMNShape kinds (sub clause 12.3.2) and BPMNEdge kinds (sub clause 12.3.3) if no BPMNLabel bounds are provided.

The text of the label to be rendered is obtained by resolving the name attribute of the referenced BPMN model element [bpmnElement] from the BPMNShape or BPMNEdge. In the particular case when the referenced BPMN model element [bpmnElement] is a DataObjectReference, the text of the label to be rendered is obtained by concatenating the name attribute of the referenced BPMN model element [bpmnElement] and the name attribute of the dataState attribute of this DataObjectReference (see Figure 12.6 - Depicting a Label for a DataObjectReference with its state).

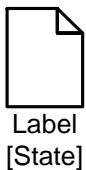

Figure 12.6 – Depicting a Label for a DataObjectReference with its state

The properties of the font to be used for rendering the label are optional and provided by the labelStyle of the BPMNLabel. If not provided, the tool should use its default style to depict the label.

12.3.2 BPMNShape

Markers for Activities

Various BPMN Activities can be decorated with markers at the bottom center of the shape.

Loop Characteristic markers may need to be rendered when the referenced BPMN model element [bpmnElement] of a BPMNShape is a Task, ServiceTask, SendTask, ReceiveTask, UserTask, ManualTask, BusinessRuleTask, ScriptTask, SubProcess, AdHocSubProcess, Transaction or CallActivity. Note that Loop Characteristic Markers (Loop, Multi-Instance

- Parallel, and Multi-Instance - Sequential) are mutually exclusive markers. That is, only one of them can be present on a single shape (see Table 10.8). Note that the patterns of Markers depicted in Table 10.8 also apply to Transaction and Call Activity which have different border depictions (i.e., double border or thick border).

A Compensation marker may need to be rendered when the referenced BPMN model element [bpmnElement] of a BPMNShape is a Task, ServiceTask, SendTask, ReceiveTask, UserTask, ManualTask, BusinessRuleTask, ScriptTask, SubProcess, AdHocSubProcess, Transaction or CallActivity (see Table 12.8).

In the case of expandable kind of shapes, the markers (Compensation or Loop Characteristic) are placed to the left of the + on the shape.

The Compensation marker may be combined with a Loop Characteristic Marker. All the markers that are present must be grouped and the whole group centered to the bottom of the shape (see Figure 12.7).

Note that in the case where the referenced BPMN model element [bpmnElement] of a BPMNShape is an AdHocSubProcess, the shape has its tilde marker to the right of the + (See page 386).

Table 12.8- Depiction Resolution for Loop Compensation Marker

Loop Characteristic Marker:	Depiction:	Specific Depiction Resolution:	
		bpmnElement:	BPMNShape Attributes:
Standard Loop		[Task, ServiceTask, SendTask, ReceiveTask, UserTask, ManualTask, BusinessRuleTask, ScriptTask, SubProcess, AdHocSubProcess, Transaction or CallActivity] where loopCharacteristics is of type StandardLoopCharacteristics	None

Table 12.8 - Depiction Resolution for Loop Compensation Marker

Loop Characteristic Marker:	Depiction:	Specific Depiction Resolution:	
		bpmnElement:	BPMNShape Attributes:
Multi-Instance - Parallel		[Task, ServiceTask, SendTask, ReceiveTask, UserTask, ManualTask, BusinessRuleTask, ScriptTask, SubProcess, AdHocSubProcess, Transaction or CallActivity] where loopCharacteristics is of type MultipleLoopCharacteristics with attribute isSequential to false.	None
Multi-Instance - Sequential		[Task, ServiceTask, SendTask, ReceiveTask, UserTask, ManualTask, BusinessRuleTask, ScriptTask, SubProcess, AdHocSubProcess, Transaction or CallActivity] where loopCharacteristics is of type MultipleLoopCharacteristics with attribute isSequential to true.	None

Table 12.8 – Depiction Resolution for Compensation Marker

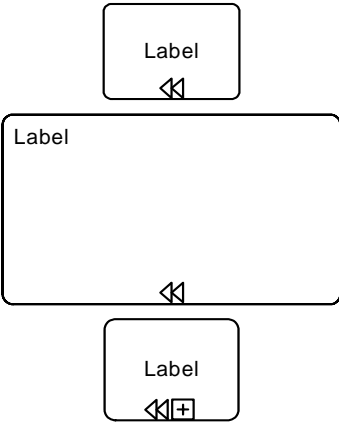
Compensation Marker:	Depiction:	Specific Depiction Resolution:	
		bpmnElement:	BPMNShape Attributes:
Compensation		[Task, ServiceTask, SendTask, ReceiveTask, UserTask, ManualTask, BusinessRuleTask, ScriptTask, SubProcess, AdHocSubProcess, Transaction or CallActivity] where isForCompensation is true.	None

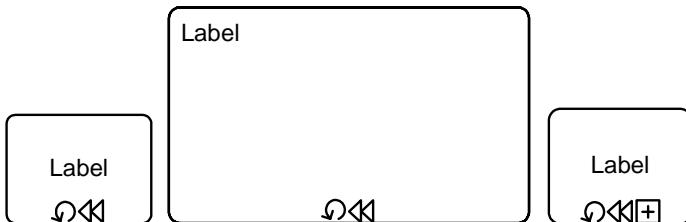







Figure 12.7 – Combined Compensation and Loop Characteristic Marker Example

Tasks [BPMNShape]

There are different types of Tasks identified within BPMN. The specific Task type depiction is obtained by placing a Task type marker in the upper left corner of the Task shape. A Task that is no further specified is called an Abstract Task.

Tasks (Abstract, Service, Send, Receive, User, Manual, Business Rule or Script) can also have Compensation and/or Loop Characteristic markers at the bottom center of the shape as defined above (see page 381).

Table 12.9 – Depiction Resolution for Tasks

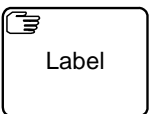
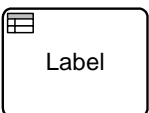
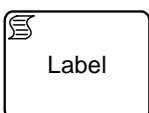
Kind:	Depiction:	Specific Depiction Resolution:	
		bpmnElement:	BPMNShape Attributes:
Abstract Task		Task	None
Service Task		ServiceTask	None
Send Task		SendTask	None
Receive Task		ReceiveTask	None
User Task		UserTask	None
Manual Task		ManualTask	None
Business Rule Task		BusinessRuleTask	None
Script Task		ScriptTask	None

Collapsed Sub-Processes [BPMNShape]

Collapsed Sub-Processes can also have Compensation and/or Loop Characteristic markers at the bottom center of the shape as defined above (see page 381).

Table 12.10 – Depiction Resolution for Collapsed Sub-Processes

Kind:	Depiction:	Specific Depiction Resolution:	
		bpmnElement:	BPMNShape Attributes:
Sub-Process - Collapsed		SubProcess where triggeredByEvent is false.	None or isExpanded is false

Expanded Sub-Processes [BPMNShape]

Expanded Sub-Processes can also have Compensation and/or Loop Characteristic markers at the bottom center of the shape as defined above (see page 381).

Table 12.11 – Depiction Resolution for Expanded Sub-Processes

Kind:	Depiction:	Specific Depiction Resolution:	
		bpmnElement:	BPMNShape Attributes:
Sub-Process - Expanded		SubProcess where triggeredByEvent is false.	isExpanded is true

Collapsed Ad Hoc Sub-Processes [BPMNShape]

Collapsed Ad Hoc Sub-Processes can also have a Compensation marker at the bottom center of the shape as defined above (see page 381).

Table 12.12 – Depiction Resolution for Collapsed Ad Hoc Sub-Processes

Kind:	Depiction:	Specific Depiction Resolution:	
		bpmnElement:	BPMNShape Attributes:
Ad Hoc Sub-Process - Collapsed		AdHocSubProcess	None or isExpanded is false

Expanded Ad Hoc Sub-Processes [BPMNShape]

Expanded Ad Hoc Sub-Processes can also have a Compensation marker at the bottom center of the shape as defined above (see page 381).

Table 12.13 – Depiction Resolution for Expanded Ad Hoc Sub-Processes

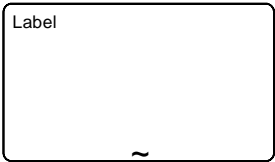
Kind:	Depiction:	Specific Depiction Resolution:	
		bpmnElement:	BPMNShape Attributes:
Ad Hoc Sub-Process - Expanded		AdHocSubProcess	None or isExpanded is true

Collapsed Transactions [BPMNShape]

Collapsed Transactions can also have Compensation and/or Loop Characteristic markers at the bottom center of the shape as defined above (see page 381).

Table 12.14 – Depiction Resolution for Collapsed Transactions

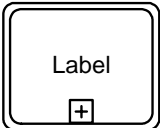
Kind:	Depiction:	Specific Depiction Resolution:	
		bpmnElement:	BPMNShape Attributes:
Transaction - Collapsed		Transaction	None or isExpanded is false

Expanded Transactions [BPMNShape]

Expanded Transactions can also have Compensation and/or Loop Characteristic markers at the bottom center of the shape as defined above (see page 381).

Table 12.15 – Depiction Resolution for Tasks

Kind:	Depiction:	Specific Depiction Resolution:	
		bpmnElement:	BPMNShape Attributes:
Transaction - Expanded		Transaction	None or isExpanded is true

Collapsed Event Sub-Processes [BPMNShape]

Table 12.16 – Depiction Resolution for Collapsed Event Sub-Processes

Kind:	Depiction:	Specific Depiction Resolution:	
		bpmnElement:	BPMNShape Attributes:
Non-interrupting Message - Event Sub-Process - Collapsed		SubProcess where triggeredByEvent is true and the one-and-only start event has one EventDefinition of type MessageEventDefinition and isInterrupting is false.	None or isExpanded is false
Interrupting - Message - Event Sub-Process - Collapsed		SubProcess where triggeredByEvent is true and the one-and-only start event has one EventDefinition of type MessageEventDefinition and isInterrupting is true.	None or isExpanded is false
Non-interrupting - Timer - Event Sub-Process - Collapsed		SubProcess where triggeredByEvent is true and the one-and-only start event has one EventDefinition of type TimerEventDefinition and isInterrupting is false.	None or isExpanded is false

Table 12.16 – Depiction Resolution for Collapsed Event Sub-Processes







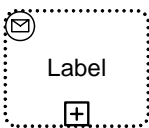
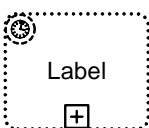



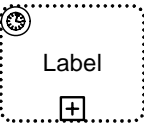

<p>Interrupting - Timer - Event Sub-Process - Collapsed</p>		<p>SubProcess where triggeredByEvent is true and the one-and-only start event has one EventDefinition of type TimerEventDefinition and isInterrupting is true.</p>	<p>None or isExpanded is false</p>
<p>Non-interrupting - Conditional - Event Sub-Process - Collapsed</p>		<p>SubProcess where triggeredByEvent is true and the one-and-only start event has one EventDefinition of type ConditionalEventDefinition and isInterrupting is false.</p>	<p>None or isExpanded is false</p>
<p>Interrupting - Conditional - Event Sub-Process - Collapsed</p>		<p>SubProcess where triggeredByEvent is true and the one-and-only start event has one EventDefinition of type ConditionalEventDefinition and isInterrupting is true.</p>	<p>None or isExpanded is false</p>
<p>Non-interrupting - Signal - Event Sub-Process - Collapsed</p>		<p>SubProcess where triggeredByEvent is true and the one-and-only start event has one EventDefinition of type SignalEventDefinition and isInterrupting is false.</p>	<p>None or isExpanded is false</p>
<p>Interrupting - Signal - Event Sub-Process - Collapsed</p>		<p>SubProcess where triggeredByEvent is true and the one-and-only start event has one EventDefinition of type SignalEventDefinition and isInterrupting is true.</p>	<p>None or isExpanded is false</p>
<p>Non-interrupting- Multiple - Event Sub-Process - Collapsed</p>		<p>SubProcess where triggeredByEvent is true and the one-and-only start event has multiple EventDefinitions and isInterrupting is false.</p>	<p>None or isExpanded is false</p>
<p>Interrupting - Multiple - Event Sub-Process - Collapsed</p>		<p>SubProcess where triggeredByEvent is true and the one-and-only start event has multiple EventDefinitions and isInterrupting is true.</p>	<p>None or isExpanded is false</p>

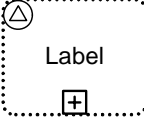
Table 12.16 – Depiction Resolution for Collapsed Event Sub-Processes

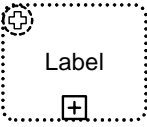
<p>Non-interrupting - Parallel Multiple - Event Sub-Process - Collapsed</p>		<p>SubProcess where triggeredByEvent is true and the one-and-only start event has multiple EventDefinitions and isInterrupting is false and isParallelMultiple is true.</p>	<p>None or isExpanded is false</p>
<p>Interrupting - Parallel Multiple - Event Sub-Process - Collapsed</p>		<p>SubProcess where triggeredByEvent is true and the one-and-only start event has multiple EventDefinitions and isInterrupting is true and isParallelMultiple is true.</p>	<p>None or isExpanded is false</p>
<p>Non-interrupting - Escalation - Event Sub-Process - Collapsed</p>		<p>SubProcess where triggeredByEvent is true and the one-and-only start event has one EventDefinition of type EscalationEventDefinition and isInterrupting is false.</p>	<p>None or isExpanded is false</p>
<p>Interrupting - Escalation Event Sub-Process - Collapsed</p>		<p>SubProcess where triggeredByEvent is true and the one-and-only start event has one EventDefinition of type EscalationEventDefinition and isInterrupting is true.</p>	<p>None or isExpanded is false</p>
<p>Interrupting - Error - Event Sub-Process - Collapsed</p>		<p>SubProcess where triggeredByEvent is true and the one-and-only start event has one EventDefinition of type ErrorEventDefinition and isInterrupting is true.</p>	<p>None or isExpanded is false</p>
<p>Interrupting - Compensation - Event Sub-Process - Collapsed</p>		<p>SubProcess where triggeredByEvent is true and the one-and-only start event has one EventDefinition of type CompensationEventDefinition and isInterrupting is true.</p>	<p>None or isExpanded is false</p>

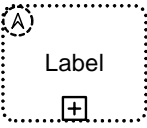
Expanded Event Sub-Processes [BPMNShape]

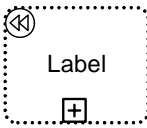
Table 12.17 – Depiction Resolution for Expanded Event Sub-Processes

Kind:	Depiction:	Specific Depiction Resolution:	
		bpmnElement:	BPMNShape Attributes:
Event Sub-Process - Expanded		SubProcess where triggeredByEvent is true.	isExpanded is true

Call Activities (Calling a Global Task) [BPMNShape]

A Call Activity (Calling a Global Task) must display the Task type marker of the Global Task it calls.

Call Activities (Calling a Global Task) can also have Compensation and/or Loop Characteristic markers at the bottom center of the shape as defined above (see page 381).

Table 12.18 – Depiction Resolution for Call Activities (Calling a Global Task)





Kind:	Depiction:	Specific Depiction Resolution:	
		bpmnElement:	BPMNShape Attributes:
Call Activity		CallActivity where calledElement is unspecified or of type GlobalTask.	None
User Call Activity		CallActivity where calledElement is of type GlobalUserTask.	None
Manual Call Activity		CallActivity where calledElement is of type GlobalManualTask.	None
Business Rule Call Activity		CallActivity where calledElement is of type GlobalBusinessRuleTask.	None

Table 12.18 – Depiction Resolution for Call Activities (Calling a Global Task)

Script Call Activity		CallActivity where calledElement is of type GlobalScriptTask.	None
----------------------	---	---	------

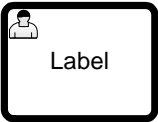
Collapsed Call Activities (Calling a Process) [BPMNShape]

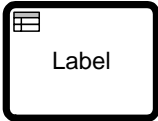
Table 12.19 – Depiction Resolution for Collapsed Call Activities (Calling a Process)

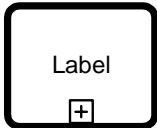
Kind:	Depiction:	Specific Depiction Resolution:	
		bpmnElement:	BPMNShape Attributes:
Call Activity - Collapsed		CallActivity where calledElement is of type Process.	None or isExpanded is false

Expanded Call Activities (Calling a Process) [BPMNShape]







Table 12.20 – Depiction Resolution for Expanded Call Activities (Calling a Process)

Kind:	Depiction:	Specific Depiction Resolution:	
		bpmnElement:	BPMNShape Attributes:
Call Activity - Expanded		CallActivity where calledElement is of type Process.	None or isExpanded is true

Data [BPMNShape]

Data Inputs and Data Outputs rendering are optional and only allowed for Processes.

Table 12.21 – Depiction Resolution for Data

Kind:	Depiction:	Specific Depiction Resolution:	
		bpmnElement:	BPMNShape Attributes:
Data Object	 Label	DataObjectReference where dataObjectRef unspecified or is pointing to a DataObject where isCollection is false.	None
Data Object Collection	 Label	DataObjectReference where dataObjectRef is pointing to a DataObject where isCollection is true.	None
Data Input	 Label	DataInput where isCollection is false.	None
Data Input Collection	 Label	DataInput where isCollection is true.	None
Data Output	 Label	DataOutput where isCollection is false.	None
Data Output Collection	 Label	DataOutput where isCollection is true.	None
Data Store	 Label	DataStoreReference	None

Events [BPMNShape]

Table 12.22 – Depiction Resolution for Events









Kind:	Depiction:	Specific Depiction Resolution:	
		bpmnElement:	BPMNShape Attributes:
None Start Event	 Label	StartEvent with no EventDefinition	None
Interrupting - Message Start Event	 Label	StartEvent with one EventDefinition of type MessageEventDefinition and isInterrupting is true.	None
Non-interrupting - Message Start Event	 Label	StartEvent with one EventDefinition of type MessageEventDefinition and isInterrupting is false.	None
Interrupting - Timer Start Event	 Label	StartEvent with one EventDefinition of type TimerEventDefinition and isInterrupting is true.	None
Non-interrupting - Timer Start Event	 Label	StartEvent with one EventDefinition of type TimerEventDefinition and isInterrupting is false.	None
Interrupting - Conditional Start Event	 Label	StartEvent with one EventDefinition of type ConditionalEventDefinition and isInterrupting is true.	None
Non-interrupting -Conditional Start Event	 Label	StartEvent with one EventDefinition of type ConditionalEventDefinition and isInterrupting is false.	None
Interrupting Signal Start Event	 Label	StartEvent One EventDefinition of type SignalEventDefinition and isInterrupting is true.	None
Non-interrupting -Signal Start Event	 Label	StartEvent with one EventDefinition of type SignalEventDefinition and isInterrupting is false.	None

Table 12.22 – Depiction Resolution for Events





Interrupting Multiple Start Event		StartEvent with more than one EventDefinition, parallelMultiple is false and isInterrupting is true.	None
Non-interrupting Multiple Start Event		StartEvent with more than one EventDefinition, parallelMultiple is false and isInterrupting is false.	None
Interrupting - Parallel Multiple Start Event		StartEvent with more than one EventDefinition, parallelMultiple is true and isInterrupting is true.	None
Non-interrupting - Parallel Multiple Start Event		StartEvent with more than one EventDefinition, parallelMultiple is true and isInterrupting is false.	None
Interrupting - Escalation Start Event		StartEvent with one EventDefinition of type EscalationEventDefinition and isInterrupting is true.	None
Non-interrupting - Escalation Start Event		StartEvent with one EventDefinition of type EscalationEventDefinition and isInterrupting is false.	None
Interrupting - Error Start Event		StartEvent with one EventDefinition of type ErrorEventDefinition.	None
Interrupting - Compensation Start Event		StartEvent with one EventDefinition of type CompensationEventDefinition.	None
Interrupting - None Intermediate Event		IntermediateThrowEvent with no EventDefinition.	None
Catch - Message Intermediate Event		IntermediateCatchEvent with one EventDefinition of type MessageEventDefinition.	None

Table 12.22 – Depiction Resolution for Events



Interrupting - Boundary - Catch - Message Intermediate Event	 Label	BoundaryEvent with one EventDefinition of type MessageEventDefinition and cancelActivity is true.	None
Non-interrupting - Boundary - Catch - Message Intermediate Event	 Label	BoundaryEvent with one EventDefinition of type MessageEventDefinition and cancelActivity is false.	None
Throw - Message Intermediate Event	 Label	IntermediateThrowEvent with one EventDefinition of type MessageEventDefinition.	None
Timer Intermediate Event	 Label	IntermediateCatchEvent with one EventDefinition of type TimerEventDefinition.	None
Interrupting - Boundary - Timer Intermediate Event	 Label	BoundaryEvent with one EventDefinition of type TimerEventDefinition and cancelActivity is true.	None
Non-interrupting Boundary - Timer Intermediate Event	 Label	IntermediateCatchEvent with one EventDefinition of type TimerEventDefinition and cancelActivity is false.	None
Conditional Intermediate Event	 Label	IntermediateCatchEvent with one EventDefinition of type ConditionalEventDefinition.	None
Interrupting - Boundary - Conditional Intermediate Event	 Label	BoundaryEvent with one EventDefinition of type ConditionalEventDefinition and cancelActivity is true.	None
Non-interrupting - Boundary - Conditional Intermediate Event	 Label	BoundaryEvent with one EventDefinition of type ConditionalEventDefinition and cancelActivity is false.	None
Catch - Signal Intermediate Event	 Label	IntermediateCatchEvent with one EventDefinition of type MessageEventDefinition.	None

Table 12.22 – Depiction Resolution for Events











Interrupting - Boundary - Catch - Signal Intermediate Event	 Label	BoundaryEvent with one EventDefinition of type SignalEventDefinition and cancelActivity is true.	None
Non-interrupting-Boundary - Catch - Signal Intermediate Event	 Label	BoundaryEvent with one EventDefinition of type SignalEventDefinition and cancelActivity is false.	None
Interrupting - Boundary - Throw - Signal Intermediate Event	 Label	IntermediateThrowEvent with one EventDefinition of type SignalEventDefinition.	None
Catch - Multiple Intermediate Event	 Label	IntermediateCatchEvent with more than one EventDefinition and parallelMultiple is false.	None
Interrupting - Boundary - Catch - Multiple Intermediate Event	 Label	BoundaryEvent with more than one EventDefinition, parallelMultiple is false and cancelActivity is true.	None
Non-interrupting Boundary - Catch - Multiple Intermediate Event	 Label	BoundaryEvent with more than one EventDefinition, parallelMultiple is false and cancelActivity is false.	None
Throw - Multiple Intermediate Event	 Label	IntermediateThrowEvent with more than one EventDefinition and parallelMultiple is false.	None
Catch - Parallel Multiple Intermediate Event	 Label	IntermediateCatchEvent with more than one EventDefinition and parallelMultiple is true.	None
Interrupting - Boundary - Catch -Parallel Multiple Intermediate Event	 Label	BoundaryEvent with more than one EventDefinition, parallelMultiple is true and cancelActivity is true.	None
Non-interrupting Boundary - Catch -Parallel Multiple Intermediate Event	 Label	BoundaryEvent with more than one EventDefinition, parallelMultiple is true and cancelActivity is false.	None

Table 12.22 – Depiction Resolution for Events



















Catch -Escalation Intermediate Event	 Label	IntermediateCatchEvent with one EventDefinition of type EscalationEventDefinition.	None
Interrupting - Boundary - Catch -Escalation Intermediate Event	 Label	BoundaryEvent with one EventDefinition of type EscalationEventDefinition and cancelActivity is true.	None
Non-interrupting -Boundary - Catch -Escalation Intermediate Event	 Label	BoundaryEvent with one EventDefinition of type EscalationEventDefinition and cancelActivity is false.	None
Throw - Escalation Intermediate Event	 Label	IntermediateThrowEvent with one EventDefinition of type EscalationEventDefinition.	None
Boundary - Catch - Error Intermediate Event	 Label	BoundaryEvent with one EventDefinition of type ErrorEventDefinition	None
Boundary - Catch - Compensation Intermediate Event	 Label	BoundaryEvent with one EventDefinition of type CompensateEventDefinition	None
Throw - Compensation Intermediate Event	 Label	IntermediateThrowEvent with one EventDefinition of type CompensateEventDefinition	None
Catch - Link Intermediate Event	 Label	IntermediateCatchEvent with one EventDefinition of type LinkEventDefinition\	None
Throw - Link Intermediate Event	 Label	IntermediateThrowEvent with one EventDefinition of type LinkEventDefinition	None
Boundary - Catch - Cancel Intermediate Event	 Label	BoundaryEvent with one EventDefinition of type CancelEventDefinition	None

Table 12.22 – Depiction Resolution for Events

None End Event	 Label	EndEvent with no EventDefinition	None
Message End Event	 Label	EndEvent with one EventDefinition of type MessageEventDefiniton	None
Signal End Event	 Label	EndEvent with one EventDefinition of type SignalEventDefiniton	None
Multiple End Event	 Label	EndEvent with more than one EventDefinition	None
Escalation End Event	 Label	EndEvent with one EventDefinition of type EscalationEventDefiniton	None
Error End Event	 Label	EndEvent with one EventDefinition of type ErrorEventDefiniton	None
Compensation End Event	 Label	EndEvent with one EventDefinition of type CompensateEventDefiniton	None
Cancel End Event	 Label	EndEvent with one EventDefinition of type CancelEventDefiniton	None
Terminate End Event	 Label	EndEvent with one EventDefinition of type TerminateEventDefiniton	None

Gateways [BPMNShape]

Table 12.23 – Depiction Resolution for Gateways











Kind:	Depiction:	Specific Depiction Resolution:	
		bpmnElement:	BPMNShape Attributes:
Exclusive Gateway - without Marker	 Label	ExclusiveGateway	None or isMarkerVisible is false
Exclusive Gateway - with Marker	 Label	ExclusiveGateway	isMarkerVisible is true
Inclusive Gateway	 Label	InclusiveGateway	None
Parallel Gateway	 Label	ParallelGateway	None
Complex Gateway	 Label	ComplexGateway	None
Event-Based Gateway	 Label	EventBasedGateway where instantiate is false.	None
Event-Based Gateway to Start a Process	 Label	EventBasedGateway where instantiate is true and eventGatewayType is exclusive.	None

Table 12.23 – Depiction Resolution for Gateways

Parallel Event-Based Gateway to Start a Process		EventBasedGateway where instantiate is true and eventGatewayType is parallel.	
---	---	---	--



Artifacts [BPMNShape]

Table 12.24 – Depiction Resolution for Artifacts

Kind:	Depiction:	Specific Depiction Resolution:	
		bpmnElement:	BPMNShape Attributes:
Group		Group	None
Text Annotation		Text Annotation	None



Lanes [BPMNShape]

Table 12.25 – Depiction Resolution for Lanes

Kind:	Depiction:	Specific Depiction Resolution:	
		bpmnElement:	BPMNShape Attributes:
Horizontal Lane		Lane	None or isVertical is false
Vertical Lane		Lane	isVertical is true

Pools [BPMNShape]

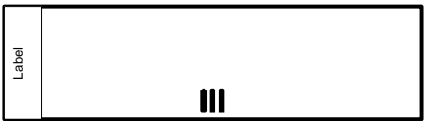

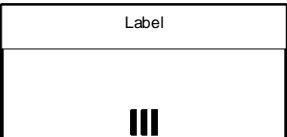
Table 12.26 – Depiction Resolution for Pools

Kind:	Depiction:	Specific Depiction Resolution:	
		bpmnElement:	BPMNShape Attributes:
Horizontal Pool		Participant where ParticipantMultiplicity is unspecified or set and its maximum attribute is 1.	None or isVertical is false
Horizontal Pool - with Multi Instance Participant		Participant where ParticipantMultiplicity is set and its maximum attribute is > 1..	None or isVertical is false
Vertical Pool		Participant where ParticipantMultiplicity is unspecified or set and its maximum attribute is 1.	isVertical is true
Vertical Pool - with Multi Instance Participant		Participant where ParticipantMultiplicity is set and its maximum attribute is > 1.	isVertical is true

Choreography Tasks [BPMNShape]

While the depictions provided in Table 12.27 - Depiction Resolution for Choreography Tasks contain Participant Bands, Participant Bands are separate shapes that need to be separately defined. Individual Participant Bands are rendered by separate BPMNShape(s), each Participant Band referencing the corresponding participant. See page 407.

Table 12.27 – Depiction Resolution for Choreography Tasks

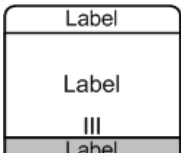
Kind:	Depiction:	Specific Depiction Resolution:	
		bpmnElement:	BPMNShape Attributes:
Choreography Task		ChoreographyTask where loopType is None.	None
Choreography Task - Loop		ChoreographyTask where loopType is Standard.	None
Choreography Task - Sequential Multi Instance		ChoreographyTask where loopType is MultiInstanceSequential.	None
Choreography Task - Parallel Multi Instance		ChoreographyTask where loopType is MultiInstanceParallel.	None

Collapsed Sub-Choreographies [BPMNShape]

While the depictions provided in Table 12.28 - Depiction Resolution for Collapsed Sub-Choreographies contain Participant Bands, Participant Bands are separate shapes that need to be separately defined. Individual Participant Bands are rendered by separate BPMNShape(s), each Participant Band referencing the corresponding participant (see page 407).

Table 12.28 – Depiction Resolution for Sub-Choreographies (Collapsed)

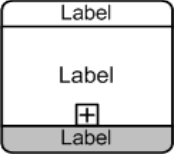
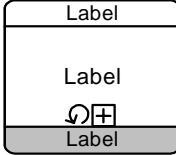
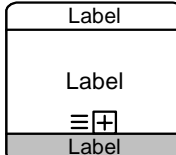
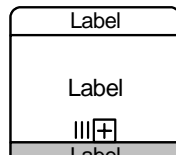
Kind:	Depiction:	Specific Depiction Resolution:	
		bpmnElement:	BPMNShape Attributes:
Sub-Choreography - Collapsed		SubChoreography where loopType is None.	None or isExpanded is false
Sub-Choreography - Loop - Collapsed		SubChoreography where loopType is Standard.	None or isExpanded is false
Sub-Choreography - Sequential Multi Instance - Collapsed		SubChoreography where loopType is MultiInstanceSequential.	None or isExpanded is false
Sub-Choreography - Parallel Multi Instance - Collapsed		SubChoreography where loopType is MultiInstanceParallel.	None or isExpanded is false

Expanded Sub-Choreographies [BPMNShape]

While the depiction provided in Table 12.29 - Depiction Resolution for Expanded Sub-Choreographies contains Participant Bands, Participant Bands are separate shapes that need to be separately defined. Individual Participant Bands are rendered by separate BPMNShape(s), each Participant Band referencing the corresponding participant (see page 407).

An expanded Sub Choreography has a loop type that is depicted exactly like the collapsed version in Table 12.28.

Table 12.29 – Depiction Resolution for Sub-Choreographies (Expanded)

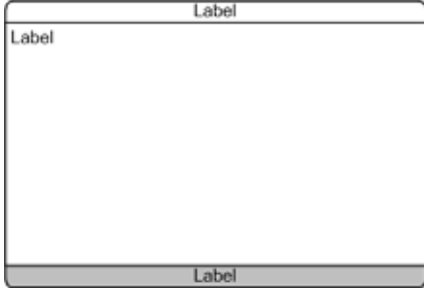
Kind:	Depiction:	Specific Depiction Resolution:	
		bpmnElement:	BPMNShape Attributes:
Sub-Choreography - Expanded		SubChoreography	isExpanded is true

Call Choreographies (Calling a Global Choreography Task) [BPMNShape]

While the depictions provided in Table 12.30 - Depiction Resolution for Call Choreographies (Calling a Global Choreography Task) contain Participant Bands, Participant Bands are separate shapes that need to be separately defined. Individual Participant Bands are rendered by separate BPMNShape(s), each Participant Band referencing the corresponding participant (see page 407).

Table 12.30 – Depiction Resolution for Call Choreographies (Calling a Global Choreography Task)

Kind:	Depiction:	Specific Depiction Resolution:	
		bpmnElement:	BPMNShape Attributes:
Call Choreography Activity calling a Global Choreography Task		CallChoreography where calledChoreographyRef is unspecified or of type GlobalChoreographyTask and loopType is None.	None
Call Choreography Activity calling a Global Choreography Task - Loop		CallChoreography where calledChoreographyRef is of type GlobalChoreographyTask and loopType is Standard.	None

Table 12.30 – Depiction Resolution for Call Choreographies (Calling a Global Choreography Task)

Call Choreography Activity calling a Global Choreography Task - Sequential Multi Instance		CallChoreography where calledChoreographyRef is of type GlobalChoreographyTask and loopType is MultiInstanceSequential.	None
Call Choreography Activity calling a Global Choreography Task - Parallel Multi Instance		CallChoreography where calledChoreographyRef is of type GlobalChoreographyTask and loopType is MultiInstanceParallel.	None

Collapsed Call Choreographies (Calling a Choreography) [BPMNShape]

While the depictions provided in Table 12.31 contain Participant Bands, Participant Bands are separate shapes that need to be separately defined. Individual Participant Bands are rendered by separate BPMNShape(s), each Participant Band referencing the corresponding participant (see page 407).

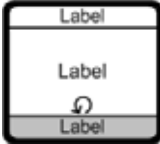
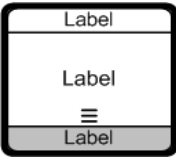
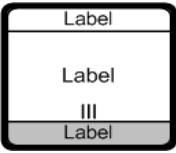
Table 12.31 – Depiction Resolution for Collapsed Call Choreographies (Calling a Choreography)

Kind:	Depiction:	Specific Depiction Resolution:	
		bpmnElement:	BPMNShape Attributes:
Call Choreography Activity calling a Choreography		CallChoreography where calledChoreographyRef is of type Choreography and loopType is None.	None or isExpanded is false
Call Choreography Activity calling a Choreography - Loop		CallChoreography where calledChoreographyRef is of type Choreography and loopType is Standard.	None or isExpanded is false
Call Choreography Activity calling a Choreography - Sequential Multi Instance		CallChoreography where calledChoreographyRef is of type Choreography and loopType is MultiInstanceSequential.	None or isExpanded is false

Table 12.31 – Depiction Resolution for Collapsed Call Choreographies (Calling a Choreography)

Call Choreography Activity calling a Choreography - Parallel Multi Instance		CallChoreography where calledChoreographyRef is of type Choreography and loopType is MultiInstanceParallel.	None or isExpanded is false.
---	---	---	------------------------------

Expanded Call Choreographies (Calling a Choreography) [BPMNShape]

While the depiction provided in Table 12.32 contains Participant Bands, Participant Bands are separate shapes that need to be separately defined. Individual Participant Bands are rendered by separate BPMNShape(s), each Participant Band referencing the corresponding participant (see page 407).

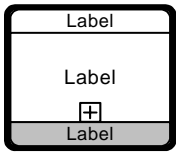
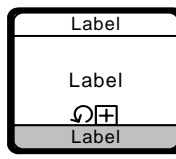
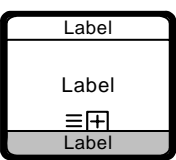
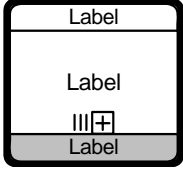
An expanded Use Sub Choreography has a loop type that is depicted exactly like the collapsed version in Table 12.31.

Table 12.32 – Depiction Resolution for Expanded Call Choreographies (Calling a Choreography)

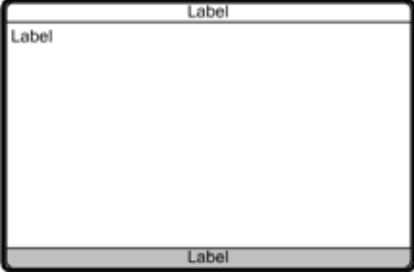
Kind:	Depiction:	Specific Depiction Resolution:	
		bpmnElement:	BPMNShape Attributes:
Call Choreography Activity calling a Choreography		CallChoreography where calledChoreographyRef is of type Choreography.	isExpanded is true.

Choreography Participant Bands [BPMNShape]

Participant Bands (used in Choreography shapes) are separate shapes that need to be separately defined. Individual Participant Bands are rendered by separate BPMNShape. Each Participant Band referencing the corresponding participant.

Note that for Participant Bands with the envelope decorator, the envelope decorator should be depicted close to the band, vertically centered with the band, and linked to the band using a dotted line. The name of the message may be used as a label for the envelop decorator. BPMN DI does not provide an interchange of the bounds of the label of the envelope decorator.

The bounds of the BPMNShape representing the band do not include the envelope decorator. The envelope decorator is therefore outside of the BPMNShape bounds. BPMN DI does not provide an interchange of the bounds of the envelope decorator.

Table 12.33 – Depiction Resolution for Choreography Participant Bands



Kind:	Depiction:	Specific Depiction Resolution:	
		bpmnElement:	BPMNShape Attributes:
Initiating Participant - Top		Participant where participantMultiplicity is unspecified or is set and its maximum attribute is 1.	participantBandKind is top_initiating and isMessageVisible is unspecified or false.
Initiating Participant - Top with Decorator		Participant where participantMultiplicity is unspecified or set and its maximum attribute is 1.	participantBandKind is top_initiating and isMessageVisible is true.
Initiating - Additional Participant		Participant where participantMultiplicity is unspecified or set and its maximum attribute is 1.	participantBandKind is middle_initiating.
Initiating Participant - Bottom		Participant where participantMultiplicity is unspecified or set and its maximum attribute is 1.	participantBandKind is bottom_initiating and isMessageVisible is unspecified or false.
Initiating Participant - Bottom with Decorator		Participant where participantMultiplicity is unspecified or set and its maximum attribute is 1.	participantBandKind is bottom_initiating and isMessageVisible is true.
Initiating - Top - Multi-Instance Participant		Participant where participantMultiplicity is unspecified or set and its maximum attribute is > 1.	participantBandKind is top_initiating and isMessageVisible is unspecified or false.
Initiating - Top - Multi-Instance Participant with Decorator		Participant where participantMultiplicity is unspecified or set and its maximum attribute is > 1.	participantBandKind is top_initiating and isMessageVisible is true.
Initiating - Additional Multi-Instance Participant		Participant where participantMultiplicity is unspecified or set and its maximum attribute is > 1.	participantBandKind is middle_initiating.

Table 12.33 – Depiction Resolution for Choreography Participant Bands





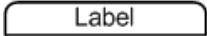
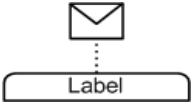
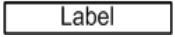
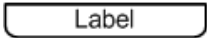

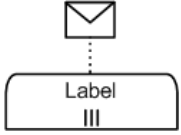
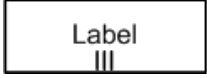

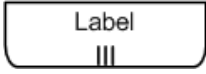
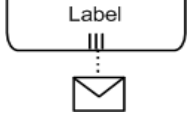
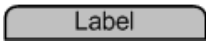
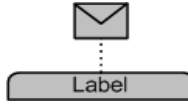

Initiating - Bottom - Multi-Instance Participant		Participant where participantMultiplicity is unspecified or set and its maximum attribute is > 1.	participantBandKind is bottom_initiating and isMessageVisible is unspecified or false.
Initiating - Bottom - Multi-Instance Participant with Decorator		Participant where participantMultiplicity is unspecified or set and its maximum attribute is > 1.	participantBandKind is bottom_initiating and isMessageVisible is true.
Non Initiating Participant - Top		Participant where participantMultiplicity is set and its maximum attribute is 1.	participantBandKind is top_non_initiating and isMessageVisible is unspecified or false.
Non Initiating Participant - Top with Decorator		Participant where participantMultiplicity is set and its maximum attribute is 1.	participantBandKind is top_non_initiating and isMessageVisible is true.
Non Initiating - Additional Participant		Participant where participantMultiplicity is set and its maximum attribute is 1.	participantBandKind is middle_non_initiating.
Non Initiating Participant - Bottom		Participant where participantMultiplicity is set and its maximum attribute is 1.	participantBandKind is bottom_non_initiating and isMessageVisible is unspecified or false.
Non Initiating Participant - Bottom with Decorator		Participant where participantMultiplicity is set and its maximum attribute is 1.	participantBandKind is bottom_non_initiating and isMessageVisible is true.
Non Initiating - Top - Multi-Instance Participant		Participant where participantMultiplicity is set and its maximum attribute is > 1.	participantBandKind is top_non_initiating and isMessageVisible is unspecified or false.
Non Initiating - Top - Multi-Instance Participant with Decorator		Participant where ParticipantMultiplicity is set and its maximum attribute is > 1.	participantBandKind is top_non_initiating and isMessageVisible is true.
Non Initiating - Additional Multi-Instance Participant		Participant where participantMultiplicity is set and its maximum attribute is > 1.	participantBandKind is middle_non_initiating.

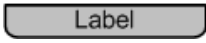
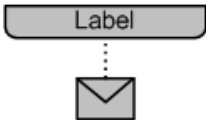
Table 12.33 – Depiction Resolution for Choreography Participant Bands

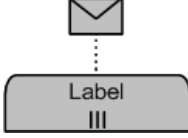
Non Initiating - Bottom - Multi-Instance Participant		Participant where ParticipantMultiplicity is set and its maximum attribute is > 1.	participantBandKind is bottom_non_initiating and isMessageVisible is unspecified or false.
Non Initiating - Bottom - Multi-Instance Participant with Decorator		Participant where participantMultiplicity is set and its maximum attribute is > 1.	participantBandKind is bottom_non_initiating and isMessageVisible is true.

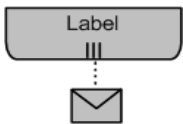
Conversations [BPMNShape]

Table 12.34 – Depiction Resolution for Conversations

Kind:	Depiction:	Specific Depiction Resolution:	
		bpmnElement:	BPMNShape Attributes:
Conversation		Conversation	None
Sub-Conversation		SubConversation	None
Call Conversation		CallConversation where calledCollaborationRef is a GlobalConversation.	None
Call Conversation		CallConversation where calledCollaborationRef is a Collaboration.	None

12.3.3 BPMNEdge

Connecting Objects [BPMNEdge]

The target [targetElement] and source [sourceElement] of a BPMNEdge may be redefined when the depiction of the source or target of the edge is different than the target [targetRef] and source [sourceRef] of the referenced model element [bpmnElement] (e.g., Message flow finishing on the border of a black box Pool or a collapsed Sub-Process rather than the actual Flow Node within the Pool or Sub-Process). In such case, the targetElement and/or sourceElement of the BPMNEdge must point to the appropriate BPMNShape or BPMNEdge.

The source [sourceElement] and target [targetElement] of a BPMNEdge can never be a BPMNShape with participantBandKind set (i.e., only Choreography Activity can be source or target of the BPMNEdge not the Participant Bands).

Note that for Message Flow with an envelope decorator, the envelope decorator should be at the midpoint of the message flow. BPMN DI does not provide an interchange of the bounds of the envelope decorator.

The “diamond” at the source of the Conditional Sequence Flow should not be depicted when the source of a Conditional Sequence Flow is a Gateway. In other words, when the source of a Conditional Sequence Flow is a Gateway, the Conditional Sequence Flow looks like a Sequence Flow.

Even though DataInputAssociation(s) and DataOutputAssociation(s) (Directed Data Associations) always point to DataInput(s) or DataOutput(s) as sources or targets within the BPMN model, they are mostly depicted as starting or finishing on the border of a different depicted element and thus, the target [targetElement] or source [sourceElement] of the BPMNEdge must be specified.

Table 12.35 – Depiction Resolution for Connecting Objects





Kind:	Depiction:	Specific Depiction Resolution:	
		bpmnElement:	BPMNShape Attributes:
Sequence Flow		SequenceFlow where default is false and conditionExpression is unspecified.	None
Conditional Sequence Flow		SequenceFlow where default is false and conditionExpression is specified (exception when source is a Gateway).	None
Default Sequence Flow		SequenceFlow where default is true and conditionExpression is unspecified.	None
Message Flow		MessageFlow	messageVisibleKind is unspecified.
Initiating Message Flow with Decorator		MessageFlow	messageVisibleKind is initiating.
Non-Initiating Message Flow with Decorator		MessageFlow	messageVisibleKind is non-initiating.
Association		Association where associationDirection is none.	None
Directional Association		Association where associationDirection is one.	None

Table 12.35 – Depiction Resolution for Connecting Objects

Bi -Directional Association	◀.....Label.....▶	Association where associationDirection is both.	None
Data AssociationLabel.....	None	The targetElement of the BPMNEdge is itself of type BPMNEdge where bpmnElement is of type SequenceFlow
Directed Data AssociationLabel.....▶	DataInputAssociation or DataOutputAssociation	None
Conversation Link	====Label====	ConversationLink	None

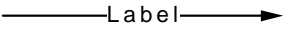
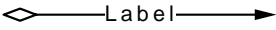
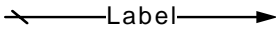
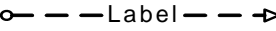
12.4 Example(s)

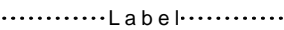
This sub clause provides examples to support interpretation of the BPMN DI specification. Some BPMN diagram depictions along with their XML BPMN DI serializations are provided. The XML samples provided in this sub clause present only BPMN DI instances and omit the BPMN 2.0 abstract syntax.

For readability purposes, the bpmnElement that is referenced by the BPMNPlane, BPMNShape, and BPMNEdge use a representative string pattern. This string pattern is:

BPMNModelClassName_BPMNModelNameAttributeValue

For example: “Task_Activity” for a Task named “Activity.”

In the provided XML serializations, the di namespace refers to the Diagram Interchange namespace defined in Annex B, and the dc namespace refers to the Diagram Common namespace also defined in Annex B.

12.4.1 Depicting Content in a Sub-Process

This sub clause shows various ways of depicting the content of a Sub-Process of the same BPMN model.

The BPMN model contains a process composed of a none start event (named “StartEvent”), a sub-process (named “SubProcess”) and a none end event (named “EndEvent”). There is a sequence flow (named “a”) between the start event (named “StartEvent”) and the sub-process (named “SubProcess”) and a sequence flow (named “d”) between the sub-process (named “SubProcess”) and the end event (named “EndEvent”).

The sub-process (named “SubProcess”) is composed of a none start event (named “SubProcessStart”), an abstract task (named “Activity”) and a none end event (named “SubProcessEnd”). There is a sequence flow (named “b”) between the start event (named “SubProcessStart”) and the task (named “Activity”) and a sequence flow (named “c”) between the task (named “Activity”) and the end event (named “SubProcessEnd”).

Expanded Sub-Process

First, a BPMN diagram depicts the BPMN model with the expanded sub-process showing its content (see Figure 12.8). This leads to a BPMN DI serialization of a single diagram that depicts this process (see Table 12.37).

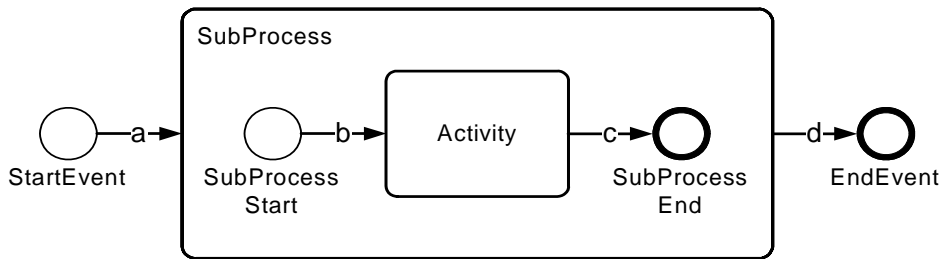

Figure 12.8 – Expanded Sub-Process Example

Table 12.36- Expanded Sub-Process BPMN DI instance

```

<BPMNDiagram name=" Events Inside the Sub Process " resolution="72">
  <BPMNPlane bpmnElement="Process_Process">
    <BPMNShape bpmnElement="StartEvent_StartEvent" >
      <dc:Bounds height="30.0" width="30.0" x="120.0" y="225.0"/>
      <BPMNLabel/>
    </BPMNShape>
    <BPMNShape bpmnElement="SubProcess_SubProcess" isExpanded="true">
      <dc:Bounds height="168.0" width="348.0" x="192.0" y="156.0"/>
      <BPMNLabel/>
    </BPMNShape>
    <BPMNShape bpmnElement="StartEvent_SubProcessStart" id="BorderStart" >
      <dc:Bounds height="30.0" width="30.0" x="228.0" y="225.0"/>
      <BPMNLabel/>
    </BPMNShape>
    <BPMNShape bpmnElement="Task_Activity">
      <dc:Bounds height="68.0" width="83.0" x="324.0" y="206.0"/>
      <BPMNLabel/>
    </BPMNShape>
    <BPMNShape bpmnElement="EndEvent_SubProcessEnd">
      <dc:Bounds height="32.0" width="32.0" x="468.0" y="224.0" id ="BorderEnd" />
      <BPMNLabel/>
    </BPMNShape>
    <BPMNShape bpmnElement="EndEvent_EndEvent">
      <dc:Bounds height="32.0" width="32.0" x="604.0" y="224.0"/>
      <BPMNLabel/>
    </BPMNShape>
    <BPMNEdge bpmnElement="SequenceFlow_a" targetElement="BorderStart" >
      <di:waypoint x="150.0" y="240.0"/>
      <di:waypoint x="192.0" y="240.0"/>
      <BPMNLabel/>
    </BPMNEdge>
    <BPMNEdge bpmnElement="SequenceFlow_b" sourceElement="BorderStart" >
      <di:waypoint x="258.0" y="240.0"/>
      <di:waypoint x="324.0" y="240.0"/>
      <BPMNLabel/>
    </BPMNEdge>
  </BPMNPlane>
</BPMNDiagram>
  
```

```

<BPMNEdge bpmnElement="SequenceFlow_c" targetElement="BorderEnd" >
  <di:waypoint x="407.0" y="240.0"/>
  <di:waypoint x="468.0" y="240.0"/>
  <BPMNLabel/>
</BPMNEdge>
<BPMNEdge bpmnElement="SequenceFlow_d" sourceElement="BorderEnd" >
  <di:waypoint x="540.0" y="240.0"/>
  <di:waypoint x="604.0" y="240.0"/>
  <BPMNLabel/>
</BPMNEdge>
</BPMNPlane>
</BPMNDiagram>

```

Expanded Sub-Process with Start and End Events on Border

An alternative to depicting the same BPMN model of 12.4.1 would be to place the sub-process start and end events on the border of the sub-process (see Figure 12.9). In the BPMN DI serialization of this diagram (see Table 12.40), the target of the sequence flow named “a” and the source of the sequence flow named “d” are the start and end events on the boundary of the sub-process.

Compare the target of the sequence flow named “a” and the source of the sequence flow named “d” of Table 12.37 with that of Table 12.38.

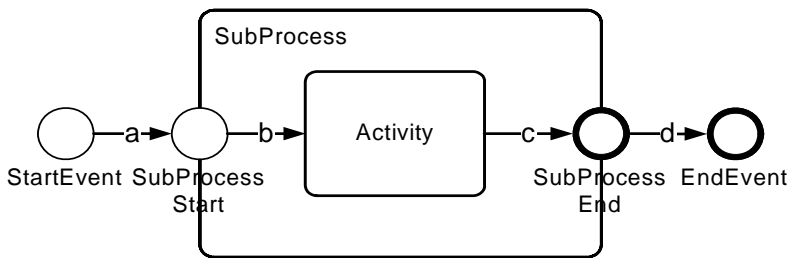

Figure 12.9 – Start and End Events on the Border Example

Table 12.37 - Start and End Events on the Border BPMN DI instance

```

<BPMNDiagram name=" StartAndEdnEventsOnTheBorder " resolution="72">
  <BPMNPlane bpmnElement="Process_Process">
    <BPMNShape bpmnElement="StartEvent_StartEvent" >
      <dc:Bounds height="30.0" width="30.0" x="120.0" y="225.0"/>
      <BPMNLabel/>
    </BPMNShape>
    <BPMNShape bpmnElement="SubProcess_SubProcess" isExpanded="true">
      <dc:Bounds height="168.0" width="348.0" x="192.0" y="156.0"/>
      <BPMNLabel/>
    </BPMNShape>
    <BPMNShape bpmnElement="StartEvent_SubProcessStart">
      <dc:Bounds height="30.0" width="30.0" x="177.0" y="225.0"/>
      <BPMNLabel/>
    </BPMNShape>
  </BPMNPlane>
</BPMNDiagram>

```

```

</BPMNShape>
<BPMNShape bpmnElement="Task_Activity">
  <dc:Bounds height="68.0" width="83.0" x="324.0" y="206.0"/>
  <BPMNLabel/>
</BPMNShape>
<BPMNShape bpmnElement="EndEvent_SubProcessEnd">
  <dc:Bounds height="32.0" width="32.0" x="524.0" y="224.0"/>
  <BPMNLabel/>
</BPMNShape>
<BPMNShape bpmnElement="EndEvent_EndEvent">
  <dc:Bounds height="32.0" width="32.0" x="604.0" y="224.0"/>
  <BPMNLabel/>
</BPMNShape>
<BPMNEdge bpmnElement="SequenceFlow_a">
  <di:waypoint x="150.0" y="240.0"/>
  <di:waypoint x="177.0" y="240.0"/>
  <BPMNLabel/>
</BPMNEdge>
<BPMNEdge bpmnElement="SequenceFlow_b">
  <di:waypoint x="207.0" y="240.0"/>
  <di:waypoint x="324.0" y="240.0"/>
  <BPMNLabel/>
</BPMNEdge>
<BPMNEdge bpmnElement="SequenceFlow_c">
  <di:waypoint x="407.0" y="240.0"/>
  <di:waypoint x="524.0" y="240.0"/>
  <BPMNLabel/>
</BPMNEdge>
<BPMNEdge bpmnElement="SequenceFlow_d">
  <di:waypoint x="556.0" y="240.0"/>
  <di:waypoint x="604.0" y="240.0"/>
  <BPMNLabel/>
</BPMNEdge>
</BPMNPlane>
</BPMNDiagram>

```

Collapsed Sub-Process

Alternatively, one could depict the same BPMN model of 12.4.1 as two diagrams. A first diagram (Figure 12.10) depicts the process with the sub-process collapsed, while a second diagram (Figure 12.11) depicts the content of the sub-process.

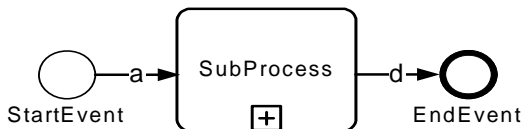

Figure 12.10 – Collapsed Sub-Process



Figure 12.11 – Contents of Collapsed Sub-Process

Table 12.38- Collapsed Sub-Process BPMN DI instance

```

<BPMNDiagram name="Collapsed Sub-Process" resolution="72">
  <BPMNPlane bpmnElement="Process_Process">
    <BPMNShape bpmnElement="StartEvent_StartEvent">
      <dc:Bounds height="30.0" width="30.0" x="96.0" y="189.0"/>
      <BPMNLabel/>
    </BPMNShape>
    <BPMNShape bpmnElement="EndEvent_EndEvent">
      <dc:Bounds height="32.0" width="32.0" x="308.0" y="188.0"/>
      <BPMNLabel/>
    </BPMNShape>
    <BPMNShape bpmnElement="SubProcess_SubProcess" isExpanded="false">
      <dc:Bounds height="68.0" width="83.0" x="168.0" y="170.0"/>
      <BPMNLabel/>
    </BPMNShape>
    <BPMNEdge bpmnElement="SequenceFlow_a">
      <di:waypoint x="126.0" y="204.0"/>
      <di:waypoint x="168.0" y="204.0"/>
      <BPMNLabel/>
    </BPMNEdge>
    <BPMNEdge bpmnElement="SequenceFlow_d">
      <di:waypoint x="251.0" y="204.0"/>
      <di:waypoint x="308.0" y="204.0"/>
      <BPMNLabel/>
    </BPMNEdge>
  </BPMNPlane>
</BPMNDiagram>

```

Table 12.39- Sub-Process Content BPMN DI instance

```

<BPMNDiagram name="SubProcess" resolution="72">
  <BPMNPlane bpmnElement="SubProcess_SubProcess">
    <BPMNShape bpmnElement="StartEvent_SubProcessStart">
      <dc:Bounds height="30.0" width="30.0" x="208.0" y="219.0"/>
      <BPMNLabel/>
    </BPMNShape>
    <BPMNShape bpmnElement="Task_Activity">
      <dc:Bounds height="68.0" width="83.0" x="304.0" y="200.0"/>
      <BPMNLabel/>
    </BPMNShape>
  </BPMNPlane>
</BPMNDiagram>

```

```

<BPMNShape bpmnElement="EndEvent_SubProcessEnd">
  <dc:Bounds height="32.0" width="32.0" x="448.0" y="218.0"/>
  <BPMNLabel/>
</BPMNShape>
<BPMNEdge bpmnElement="SequenceFlow_b">
  <di:waypoint x="238.0" y="234.0"/>
  <di:waypoint x="304.0" y="234.0"/>
  <BPMNLabel/>
</BPMNEdge>
<BPMNEdge bpmnElement="SequenceFlow_c">
  <di:waypoint x="387.0" y="234.0"/>
  <di:waypoint x="448.0" y="234.0"/>
  <BPMNLabel/>
</BPMNEdge>
</BPMNPlane>
</BPMNDiagram>

```

12.4.2 Multiple Lanes and Nested Lanes

In this next example, a diagram depicting a BPMN Process is composed of a LaneSet that contains 2 lanes is presented. The second lane contains 2 sub lanes (See Figure 12.12).

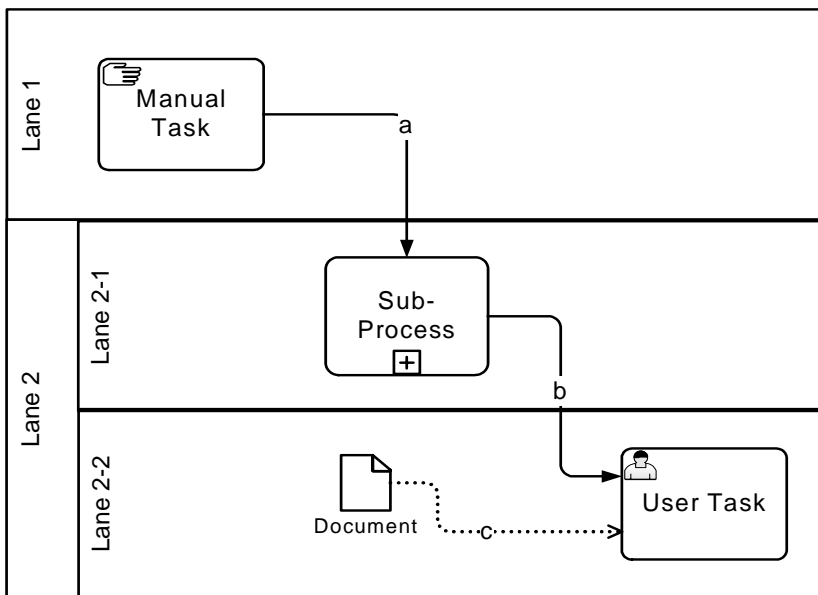

Figure 12.12 – Nested Lanes Example

Table 12.40 – Multiple Lanes and Nested Lanes BPMN DI instance

```

<BPMNDiagram name="Lanes and Nested Lanes" resolution="72">
  <BPMNPlane bpmnElement="Process_LanesAndNestedLanes">
    <BPMNShape bpmnElement="Lane_Lane1" isHorizontal="true">

```

```

    <dc:Bounds height="144.0" width="498.0" x="87.0" y="144.0"/>
    <BPMNLabel/>
  </BPMNShape>
  <BPMNShape bpmnElement="Lane_Lane2" isHorizontal="true">
    <dc:Bounds height="162.0" width="498.0" x="87.0" y="288.0"/>
    <BPMNLabel/>
  </BPMNShape>
  <BPMNShape bpmnElement="Lane_Lane2_2" isHorizontal="true">
    <dc:Bounds height="78.0" width="474.0" x="111.0" y="372.0"/>
    <BPMNLabel/>
  </BPMNShape>
  <BPMNShape bpmnElement="Lane_Lane2_1" isHorizontal="true">
    <dc:Bounds height="84.0" width="474.0" x="111.0" y="288.0"/>
    <BPMNLabel/>
  </BPMNShape>

```

12.4.3 Vertical Collaboration

In this example, a Collaboration between two Participants (Pool A and Pool B) is depicted. The first Participant is depicted with a white box Pool and the second Participant is depicted with a black box Pool. This diagram also depicts message flows that are decorated with message envelopes (See Figure 12.13).

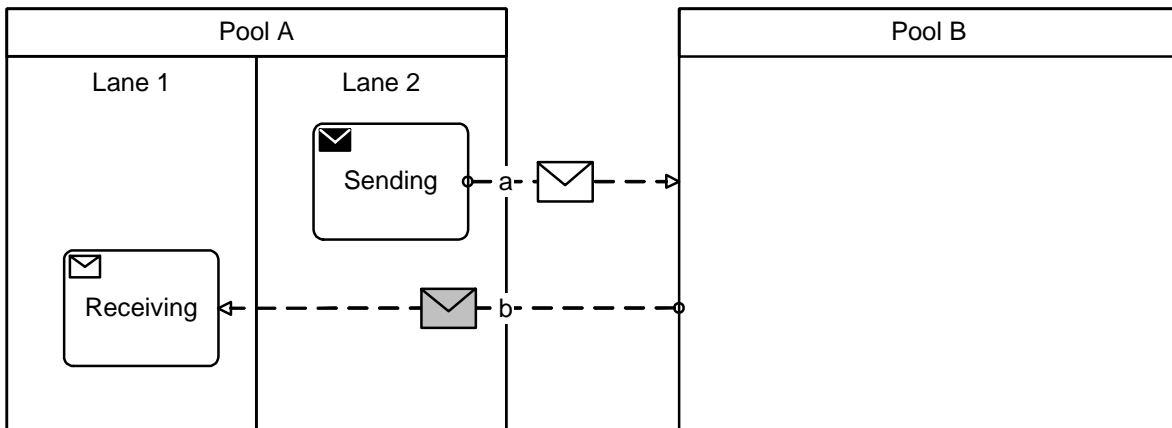

Figure 12.13 – Vertical Collaboration Example

Table 12.41 – Vertical Collaboration BPMN DI instance

```

<BPMNDiagram name="Vertical Collaboration" resolution="72">
  <BPMNPlane bpmnElement="Collaboration_Vertical_Collaboration">
    <BPMNShape bpmnElement="Participant_Pool_A" isHorizontal="false">
      <dc:Bounds height="258.0" width="336.0" x="96.0" y="276.0"/>
      <BPMNLabel/>
    </BPMNShape>
    <BPMNShape bpmnElement="Lane_Lane1" isHorizontal="false">
      <dc:Bounds height="228.0" width="168.0" x="96.0" y="306.0"/>
      <BPMNLabel/>

```



```

</BPMNShape>
  <BPMNShape bpmnElement="Lane_Lane2" isHorizontal="false">
    <dc:Bounds height="228.0" width="168.0" x="264.0" y="306.0"/>
  </BPMNShape>
  <BPMNLabel/>
</BPMNShape>
  <BPMNShape bpmnElement="Participant_Pool_B" isHorizontal="false">
    <dc:Bounds height="258.0" width="336.0" x="624.0" y="279.0"/>
  </BPMNShape>
  <BPMNLabel/>
</BPMNShape>
  <BPMNShape bpmnElement="TaskReceiving_Receiving">
    <dc:Bounds height="68.0" width="83.0" x="145.0" y="436.0"/>
  </BPMNShape>
  <BPMNLabel/>
</BPMNShape>
  <BPMNShape bpmnElement="TaskSending_Sending">
    <dc:Bounds height="68.0" width="83.0" x="282.0" y="338.0"/>
  </BPMNShape>
  <BPMNLabel/>
</BPMNShape>
<BPMNEdge bpmnElement="MessageFlow_a" messageVisibleKind="initiating">
  <di:waypoint x="366.0" y="372.0"/>
  <di:waypoint x="624.0" y="374.0"/>
  <BPMNLabel/>
</BPMNEdge>
<BPMNEdge bpmnElement="MessageFlow_b" messageVisibleKind="non_initiating">
  <di:waypoint x="624.0" y="470.0"/>
  <di:waypoint x="228.0" y="470.0"/>
  <BPMNLabel/>
</BPMNEdge>
</BPMNPlane>
</BPMNDiagram>

```

12.4.4 Conversation

The following diagram depicts a Collaboration between 3 Participants (Participants 1, 2, and 3) including two Conversations. The diagram also has an annotation connected to a message flow (see Figure 12.14).

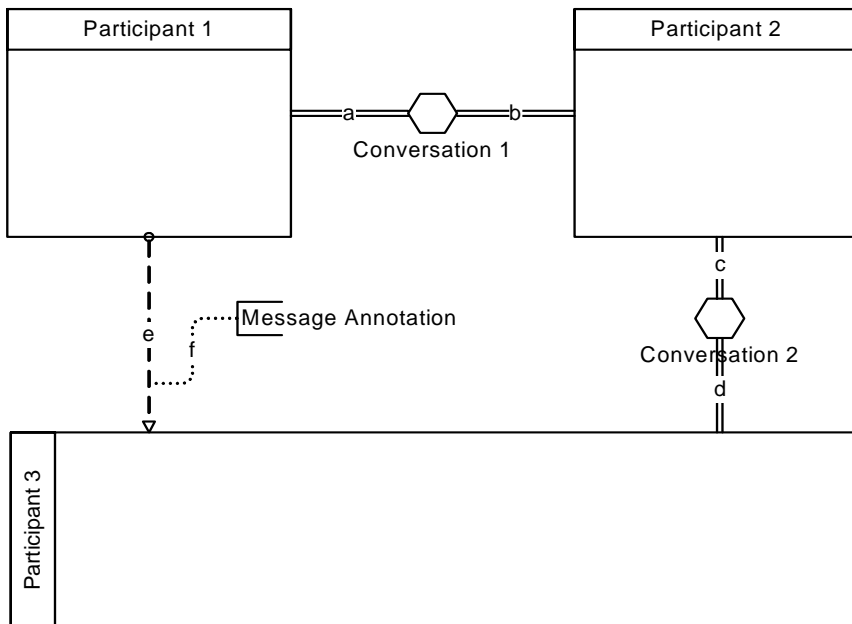

Figure 12.14 – Conversation Example

Table 12.42 – Conversation BPMN DI instance

```

<bpmndi:BPMNDiagram name="Conversation " resolution="72">
  <bpmndi:BPMNPlane bpmnElement="Collaboration_Conversation">
    <bpmndi:BPMNShape bpmnElement="Participant_Participant_1" isHorizontal="false">
      <dc:Bounds height="144.0" width="132.0" x="97.0" y="108.0"/>
      <bpmndi:BPMNLabel/>
    </bpmndi:BPMNShape>
    <bpmndi:BPMNShape bpmnElement="Participant_Participant_2" isHorizontal="false">
      <dc:Bounds height="144.0" width="120.0" x="360.0" y="108.0"/>
      <bpmndi:BPMNLabel/>
    </bpmndi:BPMNShape>
    <bpmndi:BPMNShape bpmnElement="Conversation_Conversation_1">
      <dc:Bounds height="38.0" width="38.0" x="274.0" y="168.0"/>
      <bpmndi:BPMNLabel/>
    </bpmndi:BPMNShape>
    <bpmndi:BPMNEdge bpmnElement="ConversationLink_A">
      <di:waypoint x="229.0" y="187.0"/>
      <di:waypoint x="274.0" y="187.0"/>
      <bpmndi:BPMNLabel/>
    </bpmndi:BPMNEdge>
    <bpmndi:BPMNEdge bpmnElement="ConversationLink_B">
      <di:waypoint x="312.0" y="187.0"/>
      <di:waypoint x="360.0" y="187.0"/>
      <bpmndi:BPMNLabel/>
    </bpmndi:BPMNEdge>
  </bpmndi:BPMNPlane>
</bpmndi:BPMNDiagram>

```

```

<bpmndi:BPMNShape bpmnElement="Participant_Participant_3" isHorizontal="true">
  <dc:Bounds height="108.0" width="384.0" x="96.0" y="396.0"/>
  <bpmndi:BPMNLabel/>
</bpmndi:BPMNShape>
<bpmndi:BPMNShape bpmnElement="Conversation_Conversation_2">
  <dc:Bounds height="38.0" width="38.0" x="406.0" y="305.0"/>
  <bpmndi:BPMNLabel/>
</bpmndi:BPMNShape>
<bpmndi:BPMNEdge bpmnElement="ConversationLink_C">
  <di:waypoint x="425.0" y="252.0"/>
  <di:waypoint x="425.0" y="305.0"/>
  <bpmndi:BPMNLabel/>
</bpmndi:BPMNEdge>
<bpmndi:BPMNEdge bpmnElement="ConversationLink_D">
  <di:waypoint x="425.0" y="343.0"/>
  <di:waypoint x="425.0" y="396.0"/>
  <bpmndi:BPMNLabel/>
</bpmndi:BPMNEdge>
<bpmndi:BPMNShape bpmnElement="TextAnnotation_MessageAnnotation">
  <dc:Bounds height="23.0" width="108.0" x="210.0" y="313.0"/>
  <bpmndi:BPMNLabel/>
</bpmndi:BPMNShape>
<bpmndi:BPMNEdge bpmnElement="MessageFlow_E">
  <di:waypoint x="164.0" y="252.0"/>
  <di:waypoint x="163.0" y="396.0"/>
  <bpmndi:BPMNLabel/>
</bpmndi:BPMNEdge>
<bpmndi:BPMNEdge bpmnElement="Association_F">
  <di:waypoint x="163.0" y="360.0"/>
  <di:waypoint x="181.0" y="360.0"/>
  <di:waypoint x="181.0" y="324.0"/>
  <di:waypoint x="210.0" y="324.0"/>
  <bpmndi:BPMNLabel/>
</bpmndi:BPMNEdge>
</bpmndi:BPMNPlane>
</bpmndi:BPMNDiagram>

```

12.4.5 Choreography

The following diagram depicts a Choreography consisting of 3 Choreography Activities (2 Choreography Tasks and 1 SubChoreography). This diagram also depicts Participant Bands with and without envelope decorator.

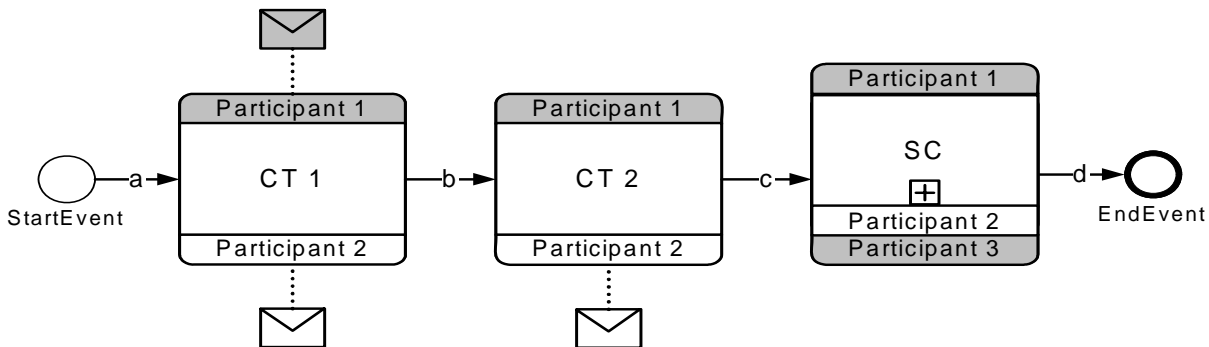

Figure 12.15 – Choreography Example

Table 12.43 – Choreography BPMN DI instance

```

<bpmndi:BPMNDiagram name="Choreography" resolution="72">
  <bpmndi:BPMNPlane bpmnElement="Choreography_Choreography">
    <bpmndi:BPMNShape bpmnElement="StartEvent_StartEvent">
      <dc:Bounds height="30.0" width="30.0" x="72.0" y="138.0"/>
      <bpmndi:BPMNLabel/>
    </bpmndi:BPMNShape>
    <bpmndi:BPMNShape bpmnElement="ChoreographyTask_CT1" id="DI_ChoreographyTask_CT1">
      <dc:Bounds height="114.0" width="96.0" x="156.0" y="96.0"/>
      <bpmndi:BPMNLabel/>
    </bpmndi:BPMNShape>
    <bpmndi:BPMNShape bpmnElement="Participant_Participant1"
      choreographyActivityShape="DI_ChoreographyTask_CT1" isMessageVisible="true"
      participantBandKind="top_non_initiating">
      <dc:Bounds height="20.0" width="96.0" x="156.0" y="96.0"/>
      <bpmndi:BPMNLabel/>
    </bpmndi:BPMNShape>
    <bpmndi:BPMNShape bpmnElement="Participant_Participant2"
      choreographyActivityShape="DI_ChoreographyTask_CT1" isMessageVisible="true"
      participantBandKind="bottom_initiating">
      <dc:Bounds height="20.0" width="96.0" x="156.0" y="190.0"/>
      <bpmndi:BPMNLabel/>
    </bpmndi:BPMNShape>
    <bpmndi:BPMNShape bpmnElement="ChoreographyTask_CT2" id="DI_ChoreographyTask_CT2">
      <dc:Bounds height="114.0" width="96.0" x="312.0" y="96.0"/>
      <bpmndi:BPMNLabel/>
    </bpmndi:BPMNShape>
    <bpmndi:BPMNShape bpmnElement="Participant_Participant1"
      choreographyActivityShape="DI_ChoreographyTask_CT2" isMessageVisible="false"
      participantBandKind="top_non_initiating">
      <dc:Bounds height="20.0" width="96.0" x="312.0" y="96.0"/>
      <bpmndi:BPMNLabel/>
    </bpmndi:BPMNShape>
    <bpmndi:BPMNShape bpmnElement="Participant_Participant2">

```

```

        choreographyActivityShape="DI_ChoreographyTask_CT2" isMessageVisible="true"
        participantBandKind="bottom_initiating">
        <dc:Bounds height="20.0" width="96.0" x="312.0" y="190.0"/>
        <bpmndi:BPMNLabel/>
    </bpmndi:BPMNShape>
    <bpmndi:BPMNShape bpmnElement="SubChoreography_SC" isExpanded="false">
        <dc:Bounds height="117.0" width="96.0" x="468.0" y="94.0"/>
        <bpmndi:BPMNLabel/>
    </bpmndi:BPMNShape>
    <bpmndi:BPMNShape bpmnElement="Participant_Participant1"
        choreographyActivityShape="DI_SubChoreography_SC" isMessageVisible="false"
        participantBandKind="top_non_initiating">
        <dc:Bounds height="20.0" width="96.0" x="468.0" y="94.0"/>
        <bpmndi:BPMNLabel/>
    </bpmndi:BPMNShape>
    <bpmndi:BPMNShape bpmnElement="Participant_Participant3"
        choreographyActivityShape="DI_SubChoreography_SC" isMessageVisible="false"
        participantBandKind="bottom_non_initiating">
        <dc:Bounds height="20.0" width="96.0" x="468.0" y="191.0"/>
        <bpmndi:BPMNLabel/>
    </bpmndi:BPMNShape>
    <bpmndi:BPMNShape bpmnElement="Participant_Participant2"
        choreographyActivityShape="DI_SubChoreography_SC" isMessageVisible="false"
        participantBandKind="middle_initiating">
        <dc:Bounds height="20.0" width="96.0" x="468.0" y="171.0"/>
        <bpmndi:BPMNLabel/>
    </bpmndi:BPMNShape>
    <bpmndi:BPMNShape bpmnElement="EndEvent_EndEvent">
        <dc:Bounds height="32.0" width="32.0" x="624.0" y="137.0"/>
        <bpmndi:BPMNLabel/>
    </bpmndi:BPMNShape>
    <bpmndi:BPMNEdge bpmnElement="SequenceFlow_a">
        <di:waypoint x="102.0" y="153.0"/>
        <di:waypoint x="156.0" y="153.0"/>
        <bpmndi:BPMNLabel/>
    </bpmndi:BPMNEdge>
    <bpmndi:BPMNEdge bpmnElement="SequenceFlow_b">
        <di:waypoint x="252.0" y="153.0"/>
        <di:waypoint x="312.0" y="153.0"/>
        <bpmndi:BPMNLabel/>
    </bpmndi:BPMNEdge>
    <bpmndi:BPMNEdge bpmnElement="SequenceFlow_c">
        <di:waypoint x="408.0" y="153.0"/>
        <di:waypoint x="468.0" y="153.0"/>
        <bpmndi:BPMNLabel/>
    </bpmndi:BPMNEdge>
    <bpmndi:BPMNEdge bpmnElement="SequenceFlow_d">
        <di:waypoint x="564.0" y="153.0"/>
        <di:waypoint x="624.0" y="153.0"/>
        <bpmndi:BPMNLabel/>
    </bpmndi:BPMNEdge>

```

```
</bpmndi:BPMNPlane>  
</bpmndi:BPMNDiagram>
```

13 BPMN Execution Semantics

13.1 General

NOTE: The content of this clause is REQUIRED for BPMN Process Execution Conformance or for BPMN Complete Conformance. However, this clause is NOT REQUIRED for BPMN Process Modeling Conformance, BPMN Choreography Conformance, or BPMN BPEL Process Execution Conformance. For more information about BPMN conformance types, see page 1.

This sub clause defines the execution semantics for orchestrations in **BPMN 2.0.1**. The purpose of this execution semantics is to describe a clear and precise understanding of the operation of the elements. However, for some elements only conceptual model is provided which does not specify details needed to execute them on an engine. These elements are called non-operational. Implementations MAY extend the semantics of non-operational elements to make them executable, but this is considered to be an optional extension to **BPMN**. Non-operational elements MAY be ignored by implementations conforming to **BPMN Process Execution Conformance** type. The following elements are non-operational:

- **Manual Task**
- **Abstract Task**
- `DataState`
- `IORules`
- **Ad-Hoc Process**
- `ItemDefinitions` with an `itemKind` of `Physical`
- the `inputSetWithWhileExecuting` attribute of **DataInput**
- the `outputSetWithWhileExecuting` attribute of **DataOutput**
- the `isClosed` attribute of **Process**
- the `isImmediate` attribute of **Sequence Flow**

The execution semantics are described informally (textually), and this is based on prior research involving the formalization of execution semantics using mathematical formalisms.

This sub clause provides the execution semantics of elements through the following structure:

- A description of the operational semantics of the element.
- Exception issues for the element where relevant.
- List of workflow patterns¹ supported by the element where relevant.

1. <http://www.workflowpatterns.com/patterns/control/index.php>

13.2 Process Instantiation and Termination

A **Process** is instantiated when one of its **Start Events** occurs. Each occurrence of a **Start Event** creates a new **Process Instance** unless the **Start Event** participates in a **Conversation** that includes other **Start Events**. In that case, a new **Process instance** is only created if none already exists for the specific **Conversation** (identified through its associated correlation information) of the **Event** occurrence. Subsequent **Start Events** that share the same correlation information as a **Start Event** that created a **Process instance** are routed to that **Process instance**. Note that a *global Process* **MUST** neither have any empty **Start Event** nor any **Gateway** or **Activity** without *incoming Sequence Flows*. An exception is the **Event Gateway**.

A **Process** can also be started via an **Event-Based Gateway** or a **Receive Task** that has no *incoming Sequence Flows* and its *instantiate* flag set to *true*. If the **Event-Based Gateway** is *exclusive*, the first matching **Event** will create a new *instance* of the **Process**. The **Process** then does not wait for the other **Events** originating from the same **Event-Based Gateway** (see also semantics of the **Event-Based Exclusive Gateway** on page 437). If the **Event-Based Gateway** is *parallel*, also the first matching **Event** creates a new **Process instance**. However, the **Process** then waits for the other **Events** to arrive. As stated above, those **Events** **MUST** have the same correlation information as the **Event** that arrived first. A **Process instance** completes only if all **Events** that succeed a **Parallel Event-Based Gateway** have occurred.

To specify that the instantiation of a **Process** waits for multiple **Start Events** to happen, a **Multiple Parallel Start Event** can be used.

Note that two **Start Events** are alternative, A **Process instance** triggered by one of the **Start Events** does not wait for an alternative **Start Event** to occur. Note that there **MAY** be multiple instantiating **Parallel Event-Based Gateways**. This allows the modeler to express that either all the **Events** after the first **Gateway** occur or all the **Events** after the second **Gateway** and so forth.

Each **Start Event** that occurs creates a *token* on its *outgoing Sequence Flows*, which is followed as described by the semantics of the other **Process** elements.

- ◆ A **Process instance** is completed, if and only if the following three conditions hold:
 - ◆ If the *instance* was created through an instantiating **Parallel Gateway**, then all subsequent **Events** (of that **Gateway**) **MUST** have occurred.
 - ◆ There is no *token* remaining within the **Process instance**.
 - ◆ No **Activity** of the **Process** is still active.

For a **Process instance** to become completed, all *tokens* in that *instance* **MUST** reach an end node, i.e., a node without *outgoing Sequence Flows*. A *token* reaching an **End Event** triggers the behavior associated with the **Event** type, e.g., the associated **Message** is sent for a **Message End Event**, the associated *Signal* is sent for a **Signal End Event**, and so on. If a *token* reaches a **Terminate End Event**, the entire **Process** is abnormally terminated.

13.3 Activities

This sub clause specifies the semantics of **Activities**. First the semantics that is common to all **Activities** is described. Subsequently the semantics of special types of **Activities** is described.

13.3.1 Sequence Flow Considerations

The nature and behavior of **Sequence Flows** is described in “Sequence Flow” on page 95. But there are special considerations relative to **Sequence Flows** when applied to **Activities**. An **Activity** that is the target of multiple **Sequence Flows** participates in “uncontrolled flow.”

To facilitate the definition of **Sequence Flow** (and other **Process** elements) behavior, we employ the concept of a *token* that will traverse the **Sequence Flows** and pass through the elements in the **Process**. A *token* is a theoretical concept that is used as an aid to define the behavior of a **Process** that is being performed. The behavior of **Process** elements can be defined by describing how they interact with a *token* as it “traverses” the structure of the **Process**. However, modeling and execution tools that implement **BPMN** are NOT REQUIRED to implement any form of *token*.

Uncontrolled flow means that, for each *token* arriving on any *incoming Sequence Flows* into the **Activity**, the **Task** will be enabled independently of the arrival of *tokens* on other *incoming Sequence Flows*. The presence of multiple *incoming Sequence Flows* behaves as an **exclusive gateway**. If the flow of *tokens* into the **Task** needs to be ‘controlled,’ then **Gateways** (other than **Exclusive**) should be explicitly included in the **Process** flow prior to the **Task** to fully eliminate semantic ambiguities.

If an **Activity** has no *incoming Sequence Flows*, the **Activity** will be instantiated when the containing **Process** or **Sub-Process** is instantiated. Exceptions to this are **Compensation Activities**, as they have specialized instantiation behavior.

Activities can also be source of **Sequence Flows**. If an **Activity** has multiple *outgoing Sequence Flows*, all of them will receive a *token* when the **Activity** transitions to the *Completed* state. Semantics for *token* propagation for other termination states is defined below. Thus, multiple *outgoing Sequence Flows* behaves as a parallel split. Multiple *outgoing Sequence Flows* with conditions behaves as an inclusive split. A mix of multiple *outgoing Sequence Flows* with and without conditions is considered as a combination of a parallel and an inclusive split as shown in the Figure 13.1.



Figure 13.1 – Behavior of multiple outgoing Sequence Flows of an Activity

If the **Activity** has no *outgoing Sequence Flows*, the **Activity** will terminate without producing any *tokens* and termination semantics for the container is then applied.

Token movement across a **Sequence Flow** does not have any timing constraints. A *token* might take a long or short time to move across the **Sequence Flow**. If the `isImmediate` attribute of a **Sequence Flow** has a value of *false*, or has no value and is taken to mean *false*, then **Activities** not in the model MAY be executed while the *token* is moving along the **Sequence Flow**. If the `isImmediate` attribute of a **Sequence Flow** has a value of *true*, or has no value and is taken to mean *true*, then **Activities** not in the model MAY NOT be executed while the *token* is moving along the **Sequence Flow**.

13.3.2 Activity

An **Activity** is a **Process** step that can be atomic (**Tasks**) or decomposable (**Sub-Processes**) and is executed by either a system (automated) or humans (manual). All **Activities** share common attributes and behavior such as states and state transitions. An **Activity**, regardless of type, has lifecycle generally characterizing its operational semantics. The lifecycle, described as a UML state diagram in Figure 13.2, entails states and transitions between the states.

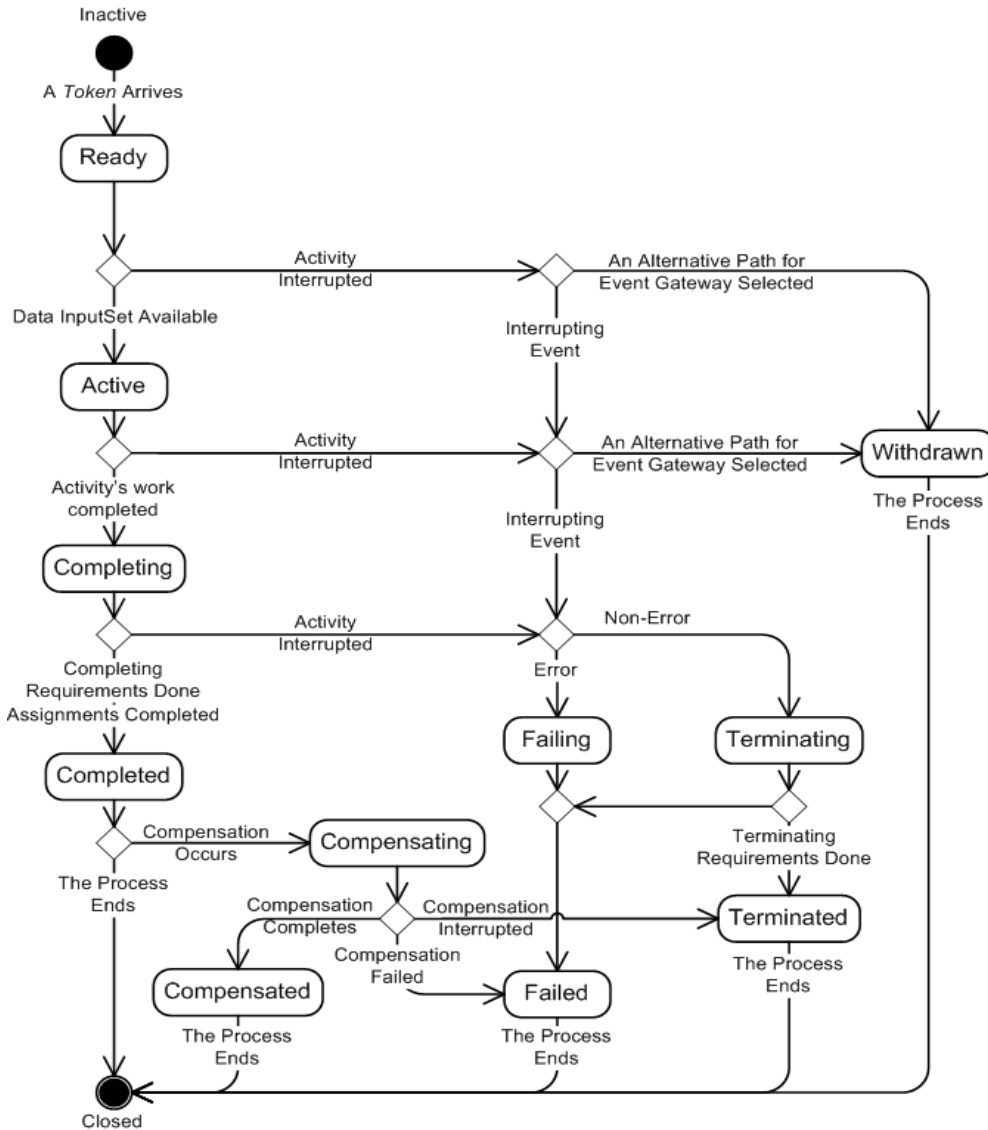

Figure 13.2 – The Lifecycle of a BPMN Activity

The lifecycle of an **Activity** is described as follows:

- ◆ An **Activity** is *Ready* for execution if the REQUIRED number of *tokens* is available to activate the **Activity**. The REQUIRED number of *tokens* (one or more) is indicated by the attribute **StartQuantity**. If the **Activity** has more than one *Incoming Sequence Flows*, there is an implied **Exclusive Gateway** that defines the behavior.
- ◆ When some data *InputSet* becomes available, the **Activity** changes from *Ready* to the *Active* state. The availability of a data *InputSet* is evaluated as follows. The data *InputSets* are evaluated in order. For each *InputSet*, the data inputs are filled with data coming from the elements of the context such as **Data Objects** or *Properties* by triggering the input **Data Associations**. An *InputSet* is *available* if each of its REQUIRED **Data Inputs** is available. A data input is REQUIRED by a data *InputSet* if it is not optional in that *InputSet*. If an *InputSet* is available, it is used to start the **Activity**. Further *InputSets* are not evaluated. If an *InputSet* is not available, the next *InputSet* is evaluated. The **Activity** waits until one *InputSet* becomes available. Please refer to 10.4.2 on page 224 for a description of the execution semantics for **Data Associations**.
- ◆ An **Activity**, if *Ready* or *Active*, can be *Withdrawn* from being able to complete in the context of a race condition. This situation occurs for **Tasks** that are attached after an **Event-Based Exclusive Gateway**. The first element (**Task** or **Event**) that completes causes all other **Tasks** to be withdrawn.
- ◆ If an **Activity** fails during execution, it changes from the state *Active* to *Failed*.
 - ◆ If a fault happens in the environment of the **Activity**, termination of the **Activity** is triggered, causing the **Activity** to go into the state *Terminated*.
- ◆ If an **Activity**'s execution ends without anomalies, the **Activity**'s state changes to *Completing*. This intermediate state caters for processing steps prior to completion of the **Activity**. An example of where this is useful is when non-interrupting *Event Handlers* (proposed for **BPMN 2.0**) are attached to an **Activity**. They need to complete before the **Activity** to which it is attached can complete. The state *Completing* of the main **Activity** indicates that the execution of the main **Activity** has been completed, however, the main **Activity** is not allowed to be in the state *Completed*, as it still has to wait for all non-interrupting *Event Handlers* to complete. The state *Completing* does not allow further processing steps, otherwise allowed during the execution of the **Activity**. For example, new attached non-interrupting *Event Handlers* MAY be created as long as the main **Activity** is in state *Active*. However, once in the state *Completing*, running handlers should be completed with no possibility to create new ones.
- ◆ An **Activity**'s execution is interrupted if an interrupting **Event** is raised (such as an *error*) or if an interrupting **Event Sub-Process** is initiated. In this case, the **Activity**'s state changes to *Failing* (in case of an *error*) or *Terminating* (in case any other interrupting **Event**). All nested **Activities** that are not in *Ready*, *Active* or a final state (*Completed*, *Compensated*, *Failed*, etc.) and non-interrupting **Event Sub-Processes** are terminated. The data context of the **Activity** is preserved in case an interrupting **Event Sub-Process** is invoked. The data context is released after the **Event Sub-Process** reaches a final state.
- ◆ After all completion dependencies have been fulfilled, the state of the **Activity** changes to *Completed*. The *outgoing Sequence Flows* becomes active and a number of *tokens*, indicated by the attribute **CompletionQuantity**, is placed on it. If there is more than one outbound *Sequence Flows* for an **Activity**, it behaves like an implicit **Parallel Gateway**. Upon completion, also a data *OutputSet* of the **Activity** is selected as follows. All *OutputSets* are checked for availability in order. An *OutputSet* is available if all its REQUIRED **Data Outputs** are available. A data output is REQUIRED by an *OutputSet* if it is not optional in that *OutputSet*. If the data *OutputSet* is available, data is pushed into the context of the **Activity** by triggering the output **Data Associations** of all its data outputs. Further *OutputSets* are not evaluated. If the data *OutputSet* is not available, the next data *OutputSet* is checked. If no *OutputSet* is available, a runtime exception is thrown. If the **Activity** has an associated *IORule*, the chosen *OutputSet* is checked against that *IORule*, i.e., it is checked whether the *InputSet* that was used in starting the **Activity** *instance* is together with the chosen *OutputSet* compliant with the *IORule*. If not, a runtime exception is thrown.

- ◆ Only completed **Activities** could, in principle, be compensated, however, the **Activity** can end in state *Completed*, as *compensation* might not be triggered or there might be no *compensation handler* specified. If the *compensation handler* is invoked, the **Activity** changes to state *Compensating* until either *compensation* finishes successfully (state *Compensated*), an exception occurs (state *Failed*), or controlled or uncontrolled termination is triggered (state *Terminated*).

13.3.3 Task

Task execution and completion for the different **Task** types are as follows:

- ◆ **Service Task:** Upon activation, the data in the `inMessage` of the `Operation` is assigned from the data in the **Data Input** of the **Service Task** the `Operation` is invoked. On completion of the service, the data in the **Data Output** of the **Service Task** is assigned from the data in the `outMessage` of the `Operation`, and the **Service Task** completes. If the invoked service returns a *fault*, that *fault* is treated as interrupting *error*, and the **Activity** fails.
- ◆ **Send Task:** Upon activation, the data in the associated **Message** is assigned from the data in the **Data Input** of the **Send Task**. The **Message** is sent and the **Send Task** completes.
- ◆ **Receive Task:** Upon activation, the **Receive Task** begins waiting for the associated **Message**. When the **Message** arrives, the data in the **Data Output** of the **Receive Task** is assigned from the data in the **Message**, and **Receive Task** completes. For key-based *correlation*, only a single receive for a given `CorrelationKey` can be active, and thus the **Message** matches at most one **Process instance**. For predicate-based *correlation*, the **Message** can be passed to multiple **Receive Tasks**. If the **Receive Task**'s `instantiate` attribute is set to *true*, the **Receive Task** itself can start a new **Process instance**.
- ◆ **User Task:** Upon activation, the **User Task** is distributed to the assigned person or group of people. When the work has been done, the **User Task** completes.
- ◆ **Manual Task:** Upon activation, the manual task is distributed to the assigned person or group of people. When the work has been done, the **Manual Task** completes. This is a conceptual model only; a **Manual Task** is never actually executed by an IT system.
- ◆ **Business Rule Task:** Upon activation, the associated business rule is called. On completion of the business rule, the **Business Rule Task** completes.
- ◆ **Script Task:** Upon activation, the associated script is invoked. On completion of the script, the **Script Task** completes.
- ◆ **Abstract Task:** Upon activation, the **Abstract Task** completes. This is a conceptual model only; an **Abstract Task** is never actually executed by an IT system.

13.3.4 Sub-Process/Call Activity

A **Sub-Process** is an **Activity** that encapsulates a **Process** that is in turn modeled by **Activities**, **Gateways**, **Events**, and **Sequence Flows**. Once a **Sub-Process** is instantiated, its elements behave as in a normal **Process**. The instantiation and completion of a **Sub-Process** is defined as follows:

- ◆ A **Sub-Process** is instantiated when it is reached by a **Sequence Flow token**. The **Sub-Process** has either a unique empty **Start Event**, which gets a *token* upon instantiation, or it has no **Start Event** but **Activities** and **Gateways** without *incoming Sequence Flows*. In the latter case all such **Activities** and **Gateways** get a *token*. A **Sub-Process** MUST not have any non-empty **Start Events**.

- ◆ If the **Sub-Process** does not have incoming **Sequence Flows** but **Start Events** that are target of **Sequence Flows** from outside the **Sub-Process**, the **Sub-Process** is instantiated when one of these **Start Events** is reached by a *token*. Multiple such **Start Events** are alternative, i.e., each such **Start Event** that is reached by a *token* generates a new *instance*.
- ◆ A **Sub-Process instance** completes when there are no more *tokens* in the **Sub-Process** and none of its **Activities** is still active.
- ◆ If a “terminate” **End Event** is reached, the **Sub-Process** is abnormally terminated. For a “cancel” **End Event**, the **Sub-Process** is abnormally terminated and the associated *Transaction* is aborted. Control leaves the **Sub-Process** through a cancel intermediate boundary **Event**. For all other **End Events**, the behavior associated with the **Event** type is performed, e.g., the associated **Message** is sent for a **Message End Event**, the associated signal is sent for a signal **End Event**, and so on.
- ◆ If a global **Process** is called through a **Call Activity**, then the **Call Activity** has the same instantiation and termination semantics as a **Sub-Process**. However, in contrast to a **Sub-Process**, the global **Process** that is called MAY also have non-empty **Start Events**. These non-empty **Start Events** are alternative to the empty **Start Event** and hence they are ignored when the **Process** is called from another **Process**.

13.3.5 Ad-Hoc Sub-Process

An **Ad-Hoc Sub-Process** or **Process** contains a number of embedded inner **Activities** and is intended to be executed with a more flexible ordering compared to the typical routing of **Processes**. Unlike regular **Processes**, it does not contain a complete, structured **BPMN** diagram description—i.e., from **Start Event** to **End Event**. Instead the **Ad-Hoc Sub-Process** contains only **Activities**, **Sequence Flows**, **Gateways**, and **Intermediate Events**. An **Ad-Hoc Sub-Process** MAY also contain **Data Objects** and **Data Associations**. The **Activities** within the **Ad-Hoc Sub-Process** are not **REQUIRED** to have *incoming* and *outgoing* **Sequence Flows**. However, it is possible to specify **Sequence Flows** between some of the contained **Activities**. When used, **Sequence Flows** will provide the same ordering constraints as in a regular **Process**. To have any meaning, **Intermediate Events** will have *outgoing* **Sequence Flows** and they can be triggered multiple times while the **Ad-Hoc Sub-Process** is active.

The contained **Activities** are executed sequentially or in parallel, they can be executed multiple times in an order that is only constrained through the specified **Sequence Flows**, **Gateways**, and data connections.

Operational semantics

- ◆ At any point in time, a subset of the embedded **Activities** is *enabled*. Initially, all **Activities** without *incoming* **Sequence Flows** are enabled. One of the enabled **Activities** is selected for execution. This is not done by the implementation but usually by a *Human Performer*. If the *ordering* attribute is set to sequential, another enabled **Activity** can be selected for execution only if the previous one has terminated. If the *ordering* attribute is set to parallel, another enabled **Activity** can be selected for execution at any time. This implies the possibility of the multiple parallel *instances* of the same inner **Activity**.
- ◆ After each completion of an inner **Activity**, a condition specified through the `completionCondition` attribute is evaluated:
 - ◆ If *false*, the set of enabled inner **Activities** is updated and new **Activities** can be selected for execution.
 - ◆ If *true*, the **Ad-Hoc Sub-Process** completes without executing further inner **Activities**. In case the *ordering* attribute is set to parallel and the attribute `cancelRemainingInstances` is *true*, running *instances* of inner **Activities** are canceled. If `cancelRemainingInstances` is set to *false*, the **Ad-Hoc Sub-Process** completes after all remaining inner *instances* have completed or terminated.

- ◆ When an inner **Activity** with *outgoing Sequence Flows* completes, a number of *tokens* are produced on its *outgoing Sequence Flows*. This number is specified through its attribute *completionQuantity*. The resulting state MAY contain also other *tokens* on *incoming Sequence Flows* of either **Activities**, converging **Parallel** or **Complex Gateways**, or an **Intermediate Event**. Then all *tokens* are propagated as far as possible, i.e., all activated **Gateways** are executed until no **Gateway** and **Intermediate Event** is activated anymore. Consequently, a state is obtained where each *token* is on an *incoming Sequence Flow* of either an inner **Activity**, a converging **Parallel** or **Complex Gateway** or an **Intermediate Event**. An inner **Activity** is now enabled if it has either no *incoming Sequence Flows* or there are sufficiently many *tokens* on its *incoming Sequence Flows* (as specified through *startQuantity*).

Workflow patterns: WCP-17 Interleaved parallel routing.

13.3.6 Loop Activity

The **Loop Activity** is a type of **Activity** that acts as a wrapper for an inner **Activity** that can be executed multiple times in sequence.

Operational semantics: Attributes can be set to determine the behavior. The **Loop Activity** executes the inner **Activity** as long as the *loopCondition* evaluates to *true*. A *testBefore* attribute is set to decide when the *loopCondition* should be evaluated: either *before* the **Activity** is executed or *after*, corresponding to a pre- and post-tested *loop* respectively. A *loopMaximum* attribute can be set to specify a maximal number of iterations. If it is not set, the number is unbounded.

Workflow Patterns Support: WCP-21 Structured Loop.

13.3.7 Multiple Instances Activity

The *multi-instance* (MI) **Activity** is a type of **Activity** that acts as a wrapper for an **Activity** which has multiple *instances* spawned in parallel or sequentially.

Operational semantics: The MI specific attributes are used to configure specific behavior. The attribute *isSequential* determines whether *instances* are generated sequentially (*true*) or in parallel (*false*). The number of *instances* to be generated is either specified by the integer-valued Expression *loopCardinality* or as the cardinality of a specific collection-valued data item of the data input of the MI **Activity**. The latter is described in detail below.

The number of *instances* to be generated is evaluated once. Subsequently the number of *instances* are generated. If the *instances* are generated sequentially, a new *instance* is generated only after the previous has been completed. Otherwise, multiple *instances* to be executed in parallel are generated.

Attributes are available to support the different possibilities of behavior. The *completionCondition* Expression is a boolean predicate that is evaluated every time an *instance* completes. When evaluated to *true*, the remaining *instances* are canceled, a *token* is produced for the *outgoing Sequence Flows*, and the **MI Activity** completes.

The attribute *behavior* defines if and when an **Event** is thrown from an **Activity** *instance* that is about to complete. It has values of *none*, *one*, *all*, and *complex*, assuming the following behavior:

- ◆ **none:** an **EventDefinition** is thrown for all *instances* completing.
- ◆ **one:** an **EventDefinition** is thrown upon the first *instance* completing.
- ◆ **all:** no **Event** is ever thrown.
- ◆ **complex:** the *complexBehaviorDefinitions* are consulted to determine if and which **Events** to throw.

For the behaviors of none and one, an EventDefinition (which is referenced from MultipleInstanceLoopCharacteristics through the noneEvent and oneEvent associations, respectively) is thrown which automatically carries the current runtime attributes of the **MI Activity**. That is, the ItemDefinition of these SignalEventDefinitions is implicitly given by the specific runtime attributes of the **MI Activity**.

The complexBehaviorDefinition association references multiple ComplexBehaviorDefinition entities which each point to a boolean condition being a FormalExpression and an Event which is an ImplicitThrowEvent. Whenever an **Activity instance** completes, the conditions of all ComplexBehaviorDefinitions are evaluated. For each ComplexBehaviorDefinition whose condition is evaluated to *true*, the associated **Event** is automatically thrown. That is, a single **Activity** completion can lead to multiple different **Events** that are thrown. The **Events** can then be caught on the boundary of the **MI Activity**. Multiple ComplexBehaviorDefinitions offer an easy way of implicitly spawning different flow at the **MI Activity** boundary for different situations indicating different states of progress in the course of executing the **MI Activity**.

The completionCondition, the condition in the ComplexBehaviorDefinition, and the DataInputAssociation of the **Event** in the ComplexBehaviorDefinition can refer to the **MI Activity instance** attributes and the loopDataInput, loopDataOutput, inputDataItem, and outputDataItem that are referenced from the MultiInstanceLoopCharacteristics.

In practice, an **MI Activity** is executed over a data *collection*, processing as input the data values in the *collection* and producing as *output* data values in a *collection*. The *input* data collection is passed to the **MI Activity's** loopDataInput from a **Data Object** in the **Process scope** of the **MI Activity**. Under **BPMN** data flow constraints, the **Data Object** is linked to **MI activity's** loopDataInput through a DataInputAssociation. To indicate that the **Data Object** is a *collection*, its respective symbol is marked with the MI indicator (three-bar). The items of the loopDataInput *collection* are used to determine the number of *instances* REQUIRED to be executed (whether sequentially or in parallel). Accordingly, the inner *instances* are created and data values from the loopDataInput are extracted and assigned to the respective *instances*. Specifically, the values from the loopDataInput items are passed to an inputDataItem, created in the scope of the outer **Activity**. The value in the inputDataItem can be passed to the loopDataInput of each inner *instance*, where a DataInputAssociation links both. The process of extraction is left under-specified. In practice, it would entail a special-purpose mediator that not only provides the extraction and data assignment, but also any necessary data transformation.

Each *instance* processes the data value of its DataInput. It produces a value in its DataOutput if it completes successfully. The DataOutput value of the *instance* is passed to a corresponding outputDataItem in the outer **Activity**, where a DataOutputAssociation links both. Each outputDataItem value is updated in the loopDataOutput *collection*, in the corresponding item. The mechanism of this update is left underspecified, and again would be implemented through a special purpose mediator. The loopDataOutput is passed to the **MI Activity's Process scope** through a **Data Object** that has a DataOutputAssociation linking both.

It should be noted that the *collection* in the **Process scope** should not be accessible until all its items have been written to. This is because, it could be accessed by an **Activity** running concurrently, and therefore control flow through *token* passing cannot guarantee that the *collection* is fully written before it is accessed.

The **MI Activity** is *compensated* only if all its *instances* have completed successfully.

Workflow Patterns Support: WCP-21 Structured Loop, Multiple Instance Patterns WCP 13, 14, 34, 36

13.4 Gateways

This sub clause describes the behavior of **Gateways**.

13.4.1 Parallel Gateway (Fork and Join)

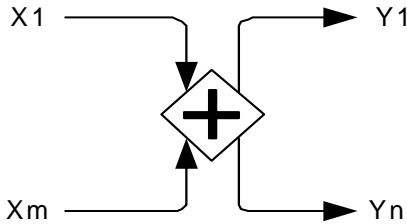

Figure 13.3 – Merging and Branching Sequence Flows for a Parallel Gateway

On the one hand, the **Parallel Gateway** is used to synchronize multiple concurrent branches (merging behavior). On the other hand, it is used to spawn new concurrent threads on parallel branches (branching behavior).

Table 13.1 – Parallel Gateway Execution Semantic

Operational Semantics	The Parallel Gateway is activated if there is at least one <i>token</i> on each incoming Sequence Flow . The Parallel Gateway consumes exactly one <i>token</i> from each incoming Sequence Flow and produces exactly one <i>token</i> at each outgoing Sequence Flow . If there are excess <i>tokens</i> at an incoming Sequence Flow , these <i>tokens</i> remain at this Sequence Flow after execution of the Gateway .
Exception Issues	The Parallel Gateway cannot throw any exception.
Workflow Patterns Support	Parallel Split (WCP-2) Synchronization (WCP-3)

13.4.2 Exclusive Gateway (Exclusive Decision (data-based) and Exclusive Merge)

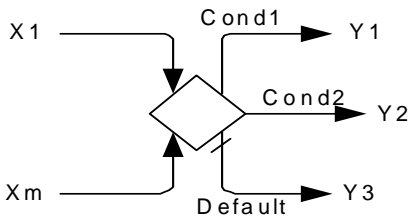

Figure 13.4 – Merging and Branching Sequence Flows for an Exclusive Gateway

The **Exclusive Gateway** has pass-through semantics for a set of incoming branches (merging behavior). Further on, each activation leads to the activation of exactly one out of the set of outgoing branches (branching behavior).

Table 13.2 – Exclusive Gateway Execution Semantics

Operational Semantics	Each <i>token</i> arriving at any incoming Sequence Flows activates the gateway and is routed to exactly one of the outgoing Sequence Flows . In order to determine the outgoing Sequence Flows that receives the <i>token</i> , the conditions are evaluated in order. The first condition that evaluates to true determines the Sequence Flow the <i>token</i> is sent to. No more conditions are henceforth evaluated. If and only if none of the conditions evaluates to true, the <i>token</i> is passed on the default Sequence Flow . In case all conditions evaluate to false and a default flow has not been specified, an exception is thrown.
Exception Issues	The exclusive gateway throws an exception in case all conditions evaluate to false and a default flow has not been specified.
Workflow Patterns Support	Exclusive Choice (WCP-4) Simple Merge (WCP-5) Multi-Merge (WCP-8)

13.4.3 Inclusive Gateway (Inclusive Decision and Inclusive Merge)

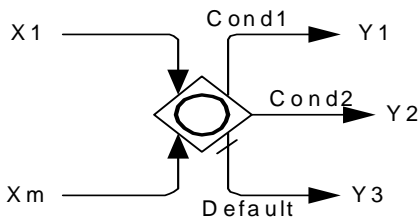

Figure 13.5 – Merging and Branching Sequence Flows for an Inclusive Gateway

The **Inclusive Gateway** synchronizes a certain subset of branches out of the set of concurrent incoming branches (merging behavior). Further on, each firing leads to the creation of threads on a certain subset out of the set of outgoing branches (branching behavior).

Table 13.3 – Inclusive Gateway Execution Semantics

Operational Semantics	<p>The Inclusive Gateway is activated if</p> <ul style="list-style-type: none"> • At least one incoming Sequence Flow has at least one <i>token</i> and • For every directed path formed by sequence flow that <ul style="list-style-type: none"> - starts with a Sequence Flow <i>f</i> of the diagram that has a <i>token</i>, - ends with an <i>incoming Sequence Flow</i> of the inclusive gateway that has no <i>token</i>, and - does not visit the Inclusive Gateway. • There is also a directed path formed by Sequence Flow that <ul style="list-style-type: none"> - starts with <i>f</i>, - ends with an <i>incoming Sequence Flow</i> of the inclusive gateway that has a <i>token</i>, and - does not visit the Inclusive Gateway. <p>Upon execution, a <i>token</i> is consumed from each incoming Sequence Flow that has a <i>token</i>. A <i>token</i> will be produced on some of the outgoing Sequence Flows.</p> <p>In order to determine the outgoing Sequence Flows that receive a <i>token</i>, all conditions on the outgoing Sequence Flows are evaluated. The evaluation does not have to respect a certain order.</p> <p>For every condition which evaluates to <i>true</i>, a <i>token</i> MUST be passed on the respective Sequence Flow.</p> <p>If and only if none of the conditions evaluates to <i>true</i>, the <i>token</i> is passed on the default Sequence Flow.</p> <p>In case all conditions evaluate to <i>false</i> and a default flow has not been specified, the Inclusive Gateway throws an exception.</p>
Exception Issues	<p>The inclusive gateway throws an exception in case all conditions evaluate to false and a default flow has not been specified.</p>
Workflow Patterns Support	<p>Multi-Choice (WCP-6) Structured Synchronizing Merge (WCP-7) Acyclic Synchronizing Merge (WCP-37) General Synchronizing Merge (WCP-38)</p>

13.4.4 Event-based Gateway (Exclusive Decision (event-based))

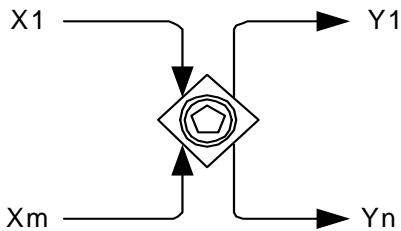

Figure 13.6 – Merging and branching Sequence Flows for an Event-Based Gateway

The **Event-Based Gateway** has pass-through semantics for a set of incoming branches (merging behavior). Exactly one of the outgoing branches is activated afterwards (branching behavior), depending on which of **Events** of the **Gateway** configuration is first triggered. The choice of the branch to be taken is deferred until one of the subsequent **Tasks** or **Events** completes. The first to complete causes all other branches to be withdrawn.

When used at the **Process** start as a **Parallel Event Gateway**, only message-based triggers are allowed. The *Message triggers* that are part of the **Gateway** configuration **MUST** be part of a **Conversation** with the same correlation information. After the first *trigger* instantiates the **Process**, the remaining *Message triggers* will be a part of the **Process instance** that is already active (rather than creating new **Process instances**).

Table 13.4 – Event-Based Gateway Execution Semantics

Exception Issues	The event-based gateway cannot throw any exception.
Workflow Patterns Support	Deferred Choice (WCP-16)

13.4.5 Complex Gateway (related to Complex Condition and Complex Merge)

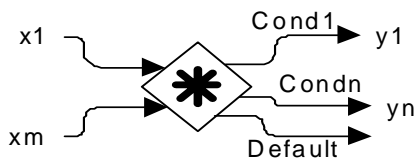

Figure 13.7 – Merging and branching Sequence Flows for a Complex Gateway

The **Complex Gateway** facilitates the specification of complex synchronization behavior, in particular race situations. The diverging behavior is similar to the **Inclusive Gateway**. Each incoming gate of the **Complex Gateway** has an attribute `activationCount`, which can be used in an `Expression` as an integer-valued variable. This variable represents the number of *tokens* that are currently on the respective *incoming Sequence Flows*. The **Complex Gateway** has an attribute `activationExpression`. An `activationExpression` is a boolean `Expression` that refers to data and to the `activationCount` of incoming gates. For example, an `activationExpression` could be `x1+x2+...+xm >= 3` stating that it needs 3 out of the *m* incoming gates to have a *token* in order to proceed. To

prevent undesirable oscillation of activation of the **Complex Gateway**, `ActivationCount` variables should only be used in subexpressions of the form `expr >= const` where `expr` is an arithmetic Expression that uses only addition and `const` is an Expression whose evaluation remains constant during execution of the **Process**.

Each *outgoing Sequence Flow* of the **Complex Gateway** has a boolean condition that is evaluated to determine whether that **Sequence Flow** receives a *token* during the execution of the **Gateway**. Such a condition MAY refer to internal state of the **Complex Gateway**. There are two states: waiting for start (represented by the runtime attribute `waitingForStart = true`) and waiting for reset (`waitingForStart=false`).

Table 13.5 – Semantics of the Complex Gateway

Operational Semantics	<p>The Complex Gateway is in one of the two states: <i>waiting for start</i> or <i>waiting for reset</i>, initially it is in <i>waiting for start</i>. If it is <i>waiting for start</i>, then it waits for the <code>activationExpression</code> to become <i>true</i>. The <code>activationExpression</code> is not evaluated before there is at least one <i>token</i> on some <i>incoming Sequence Flow</i>. When it becomes <i>true</i>, a <i>token</i> is consumed from each <i>incoming Sequence Flow</i> that has a <i>token</i>. To determine which <i>outgoing Sequence Flows</i> receive a <i>token</i>, all conditions on the <i>outgoing Sequence Flows</i> are evaluated (in any order). Those and only those that evaluate to <i>true</i> receive a <i>token</i>. If no condition evaluates to <i>true</i>, and only then, the <i>default Sequence Flow</i> receives a <i>token</i>. If no default flow is specified an exception is thrown. The Gateway changes its state to <i>waiting for reset</i>. The Gateway remembers from which of the <i>incoming Sequence Flows</i> it consumed <i>tokens</i> in the first phase.</p> <p>When <i>waiting for reset</i>, the Gateway waits for a <i>token</i> on each of those <i>incoming Sequence Flows</i> from which it has not yet received a <i>token</i> in the first phase unless such a <i>token</i> is not expected according to the join behavior of an inclusive Gateway.</p> <p>More precisely, the Gateway being <i>waiting for reset</i>, <i>resets</i> when for every directed path formed by sequence flow that</p> <ul style="list-style-type: none"> - starts with a Sequence Flow <i>f</i> of the diagram that has a <i>token</i>, - ends with an <i>incoming Sequence Flow</i> of the Complex Gateway that has no <i>token</i> and has not consumed a <i>token</i> in the first phase, and that - does not visit the Complex Gateway.
-----------------------	---

Table 13.5 – Semantics of the Complex Gateway

Operational Semantics	<ul style="list-style-type: none"> • There is also a directed path formed by Sequence Flow that <ul style="list-style-type: none"> - starts with <i>f</i>, - ends with an <i>incoming Sequence Flow</i> of the Complex Gateway that has a <i>token</i> or from which a <i>token</i> was consumed in the first phase, and that, - does not visit the Complex Gateway. <p>If the Complex Gateway is contained in a Sub-Process, then no paths are considered that cross the boundary of that Sub-Process.</p> <p>When the Gateway resets, it consumes a <i>token</i> from each <i>incoming Sequence Flow</i> that has a <i>token</i> and from which it had not yet consumed a <i>token</i> in the first phase. It then evaluates all conditions on the <i>outgoing Sequence Flows</i> (in any order) to determine which Sequence Flows receives a <i>token</i>. Those and only those that evaluate to <i>true</i> receive a <i>token</i>. If no condition evaluates to <i>true</i>, and only then, the <i>default Sequence Flow</i> receives a <i>token</i>. The Gateway changes its state back to the state <i>waiting for start</i>. Note that the Gateway might not produce any <i>tokens</i> in this phase and no exception is thrown. Note that the conditions on the <i>outgoing Sequence Flows</i> MAY evaluate differently in the two phases, e.g., by referring to the state of the Gateway (runtime attribute <code>waitingForStart</code>).</p> <p>Note that if the <code>activationCondition</code> never becomes <i>true</i> in the first phase, <i>tokens</i> are blocked indefinitely at the Complex Gateway, which MAY cause a deadlock of the entire Process.</p>
Exception issues	<p>The Complex Gateway throws an exception when it is activated in the state <i>waiting for start</i>, no condition on any <i>outgoing Sequence Flow</i> evaluates to <i>true</i> and no <i>default Sequence Flow</i> is specified.</p>
Workflow Patterns Support	<p>Structured Discriminator (WCP-9) Blocking Discriminator (WCP-28) Structured Partial Join (WCP-30) Blocking Partial Join (WCP-31)</p>

13.5 Events

This sub clause describes the handling of **Events**.

13.5.1 Start Events

For single **Start Events**, handling consists of starting a new **Process instance** each time the **Event** occurs. **Sequence Flows** leaving the **Event** are then followed as usual.

If the **Start Event** participates in a **Conversation** that includes other **Start Events**, a new **Process instance** is only created if none already exists for the specific **Conversation** (identified through its associated correlation information) of the **Event** occurrence.

A **Process** can also be started via an **Event-Based Gateway**. In that case, the first matching **Event** will create a new *instance* of the **Process**, and waiting for the other **Events** originating from the same decision stops, following the usual semantics of the **Event-Based Exclusive Gateway**. Note that this is the only scenario where a **Gateway** can exist without *incoming Sequence Flows*.

It is possible to have multiple groups of **Event-Based Gateways** starting a **Process**, provided they participate in the same **Conversation** and hence share the same correlation information. In that case, one **Event** out of each group needs to arrive; the first one creates a new **Process instance**, while the subsequent ones are routed to the existing *instance*, which is identified through its correlation information.

13.5.2 Intermediate Events

For **Intermediate Events**, the handling consists of waiting for the **Event** to occur. Waiting starts when the **Intermediate Event** is reached. Once the **Event** occurs, it is consumed. **Sequence Flows** leaving the **Event** are followed as usual. For *catch Message Intermediate Events*, the **Message correlation** behavior is the same as for **Receive Tasks** (see sub clause 13.3.3).

13.5.3 Intermediate Boundary Events

For boundary **Events**, handling first consists of consuming the **Event** occurrence. If the `cancelActivity` attribute is set, the **Activity** the **Event** is attached to is then cancelled (in case of a multi-instance, all its *instances* are cancelled); if the attribute is not set, the **Activity** continues execution (only possible for **Message, Signal, Timer, and Conditional Events**, not for **Error Events**). Execution then follows the **Sequence Flow** connected to the boundary **Event**. For *boundary Message Intermediate Events*, the **Message correlation** behavior is the same as for **Receive Tasks** (see sub clause 13.3.3).

13.5.4 Event Sub-Processes

Event Sub-Processes allow to handle an **Event** within the context of a given **Sub-Processes** or **Process**. An **Event Sub-Process** always begins with a **Start Event**, followed by **Sequence Flows**. **Event Sub-Processes** are a special kind of **Sub-Process**: they create a scope and are instantiated like a **Sub-Process**, but they are not instantiated by normal control flow but only when the associated **Start Event** is triggered. **Event Sub-Processes** are self-contained and **MUST** not be connected to the rest of the **Sequence Flows** in the **Sub-Processes**; also they cannot have attached boundary **Events**. They run in the context of the **Sub-Process**, and thus have access to its context.

An **Event Sub-Process** cancels execution of the enclosing **Sub-Process**, if the `isInterrupting` attribute of its **Start Event** is set; for a multi-instance **Activity** this cancels only the affected *instance*. If the `isInterrupting` attribute is not set (not possible for **Error Event Sub-Processes**), execution of the enclosing **Sub-Process** continues in parallel to the **Event Sub-Process**.

An **Event Sub-Process** can optionally re-trigger the **Event** through which it was triggered, to cause its continuation outside the boundary of the associated **Sub-Process**. In that case the **Event Sub-Process** is performed when the **Event** occurs; then control passes to the boundary **Event**, possibly canceling the **Sub-Process** (including running handlers).

Operational semantics

- ◆ An **Event Sub-Process** becomes initiated, and thus *Enabled* and *Running*, through the **Activity** to which it is attached. The *Event Handler* **MAY** only be initiated after the parent **Activity** is *Running*.

- ◆ More than one non-interrupting *Event Handler* MAY be initiated and they MAY be initiated at different times. There might be multiple instances of the non-interrupting *Event Handler* at a time. For **Event Sub-Processes** triggered by a **Message**, the **Message correlation** behavior is the same as for **Receive Tasks** -- see sub clause 13.3.3.
- ◆ Only one interrupting *Event Handler* MAY be initiated for a given *EventDefinition* within the context of the parent **Activity**. Once the interrupting *Event Handler* is started, the parent **Activity** is interrupted and no new *Event Handlers* can be initiated or started. An **Event Sub-Process** completes when all *tokens* have reached an **End Event**, like any other **Sub-Process**. If the parent **Activity** enters the state *Completing*, it remains in that state until all contained active **Event Sub-Processes** have completed. While the parent **Activity** is in the *Completing* state, no new **Event Sub-Processes** can be initiated.
- ◆ If an interrupting **Event Sub-Process** is started by an *error*, then the parent **Activity** enters the state *Failing* and remains in this state until the interrupting *Event Handler* reaches a final state. During this time, the running *Event Handler* can access to the context of the parent **Activity**. However, new *Event Handlers* MUST NOT be started.
- ◆ Similarly, if an interrupting **Event Sub-Process** is started by a non *error* (e.g., *Escalation*), then the parent **Activity** enters the state *Terminating* and remains in this state until the interrupting *Event Handler* reaches a final state. During this time, the running *Event Handler* can access to the context of the parent **Activity**. However, new *Event Handlers* MUST NOT be started.

13.5.5 Compensation

Compensation is concerned with undoing steps that were already successfully completed, because their results and possibly side effects are no longer desired and need to be reversed. If an **Activity** is still active, it cannot be compensated, but rather needs to be canceled. Cancellation in turn can result in *compensation* of already successfully completed portions of an active **Activity**, in case of a **Sub-Process**.

Compensation is performed by a *compensation handler*. A *compensation handler* can either be a **Compensation Event Sub-Process** (for a **Sub-Process** or **Process**), or an associated **Compensation Activity** (for any **Activity**). A *compensation handler* performs the steps necessary to reverse the effects of an **Activity**. In case of a **Sub-Process**, its **Compensation Event Sub-Process** has access to **Sub-Process** data at the time of its completion (“snapshot data”).

Compensation is triggered by a *throw Compensation Event*, which typically will be raised by an *error handler*, as part of cancellation, or recursively by another *compensation handler*. That **Event** specifies the **Activity** for which *compensation* is to be performed, either explicitly or implicitly.

Compensation Handler

A *compensation handler* is a set of **Activities** that are not connected to other portions of the **BPMN** model. The *compensation handler* starts with a *catch Compensation Event*. That *catch Compensation Event* either is a boundary **Event**, or, in case of a **Compensation Event Sub-Process**, the handler’s **Start Event**.

A *compensation handler* connected via a boundary **Event** can only perform “black-box” *compensation* of the original **Activity**. This *compensation* is modeled with a specialized **Compensation Activity**.

A **Compensation Event Sub-Process** is contained within a **Process** or **Sub-Processes**. It can access data that is part of its parent, snapshot at the point in time when its parent has completed. A *compensation Event Sub-Process* can in particular recursively trigger *compensation* for **Activities** contained in that its parent.

It is possible to specify that a **Sub-Process** can be compensated without having to define the *compensation handler*. The **Sub-Process** attribute *compensable*, when set, specifies that default *compensation* is implicitly defined, which recursively compensates all successfully completed **Activities** within that **Sub-Process**, invoking them in reverse order of their forward execution.

Compensation Triggering

Compensation is triggered using a *throw Compensation Event*, which can either be an **Intermediate** or an **End Event**. The **Activity** that needs to be compensated is referenced. If the **Activity** is clear from the context, it doesn't have to be specified and defaults to the current **Activity**. A typical scenario for that is an inline *error handler* of a **Sub-Process** that cannot recover the *error*, and as a result would trigger *compensation* for that **Sub-Process**. If no **Activity** is specified in a "global" context, all completed **Activities** in the **Process** are compensated.

By default, *compensation* is triggered synchronously, that is, the *throw Compensation Event* waits for the completion of the triggered *compensation handler*. Alternatively, *compensation* can just be triggered without waiting for its completion, by setting the *throw Compensation Event*'s `waitForCompletion` attribute to *false*.

Multiple *instances* typically exist for **Loop** or **Multi-Instance Sub-Processes**. Each of these has its own *instance* of its **Compensation Event Sub-Process**, which has access to the specific snapshot data that was current at the time of completion of that particular *instance*. Triggering *compensation* for the **Multi-Instance Sub-Process** individually triggers *compensation* for all *instances* within the current *scope*. If *compensation* is specified via a boundary *compensation handler*, this boundary *compensation handler* also is invoked once for each *instance* of the **Multi-Instance Sub-Process** in the current *scope*.

Relationship between Error Handling and Compensation

Compensation employs a "presumed abort principle," which has a number of consequences. First, only completed **Activities** are compensated; *compensation* of a failed **Activity** results in an empty operation. Thus, when an **Activity** fails, i.e., is left because an *error* has been thrown, it's the *error handler*'s responsibility to ensure that no further *compensation* will be necessary once the *error handler* has completed. Second, if no *error Event Sub-Process* is specified for a particular **Sub-Process** and a particular *error*, the default behavior is to automatically call *compensation* for all contained **Activities** of that **Sub-Process** if that *error* occurs, thus ensuring the "presumed abort" invariant.

Operational Semantics

- ◆ A **Compensation Event Sub-Process** becomes enabled when its *parent Activity* transitions into state *Completed*. At that time, a snapshot of the data associated with the parent **Activity** is taken and kept for later usage by the **Compensation Event Sub-Process**. In case the *parent Activity* is a *multi-instance* or *loop*, for each *instance* a separate data snapshot is taken, which is used when its associated **Compensation Event Sub-Process** is triggered.
- ◆ When *compensation* is triggered for the *parent Activity*, its **Compensation Event Sub-Process** is activated and runs. The original context data of the *parent Activity* is restored from the data snapshot. In case the *parent Activity* is a *multi-instance* or *loop*, for each *instance* the dedicated snapshot is restored and a dedicated **Compensation Event Sub-Process** is activated.
- ◆ An associated **Compensation Activity** becomes enabled when the **Activity** it is associated with transitions into state *Completed*. When *compensation* is triggered for that **Activity**, the associated **Compensation Activity** is activated. In case the **Activity** is a *multi-instance* or *loop*, the **Compensation Activity** is triggered only once, too, and thus has to compensate the effects of all *instances*.
- ◆ Default compensation ensures that **Compensation Activities** are performed in reverse order of the execution of the original **Activities**, allowing for concurrency when there was no dependency between the original **Activities**. Dependencies between original **Activities** that default compensation MUST consider are the following:
 - ◆ A **Sequence Flow** between **Activities** A and B results in compensation of B to be performed before compensation of A.

- ◆ A data dependency between **Activities** A and B, e.g., through an `IORules` specification in B referring to data produced by A, results in compensation of B to be performed before compensation of A.
- ◆ If A and B are two **Activities** that were active as part of an **Ad-Hoc Sub-Process**, then compensation of B **MUST** be performed before compensation of A if A completed before B started.
- ◆ *Instances* of a loop or sequential multi-instance are compensated in reverse order of their forward completion. *Instances* of a parallel multi-instance can be compensated in parallel.
- ◆ If a **Sub-Process** A has a *boundary Event* connected to **Activity** B, then compensation of B **MUST** be performed before compensation of A if that particular **Event** occurred. This also applies to multi-instances and loops.

13.5.6 End Events

Process level end events

For a “terminate” **End Event**, the **Process** is abnormally terminated—no other ongoing **Process** *instances* are affected.

For all other **End Events**, the behavior associated with the **Event** type is performed, e.g., the associated **Message** is sent for a **Message End Event**, the associated signal is sent for a **Signal End Event**, and so on. The **Process** *instance* is then completed, if and only if the following two conditions hold:

- ◆ All start nodes of the **Process** have been visited. More precisely, all **Start Events** have been triggered, and for all starting **Event-Based Gateways**, one of the associated **Events** has been triggered.
- ◆ There is *no token* remaining within the **Process** *instance*.

Sub-process level end events

For a “terminate” **End Event**, the **Sub-Process** is abnormally terminated. In case of a multi-instance **Sub-Process**, only the affected *instance* is terminated—no other ongoing **Sub-Process** *instances* or higher-level **Sub-Process** or **Process** *instances* are affected.

For a “cancel” **End Event**, the **Sub-Process** is abnormally terminated and the associated transaction is aborted. Control leaves the **Sub-Process** through a cancel intermediate boundary **Event**.

For all other **End Events**, the behavior associated with the **Event** type is performed, e.g., the associated **Message** is sent for a **Message End Event**, the associated signal is sent for a signal **End Event**, and so on. The **Sub-Process** *instance* is then completed, if and only if the following two conditions hold:

- ◆ All start nodes of the **Sub-Process** have been visited. More precisely, all **Start Events** have been triggered, and for all starting **Event-Based Gateways**, one of the associated **Events** has been triggered.
- ◆ There is *no token* remaining within the **Sub-Process** *instance*.

14 Mapping BPMN Models to WS-BPEL

14.1 General

NOTE: The contents of this clause is REQUIRED for BPMN BPEL Process Execution Conformance or for BPMN Complete Conformance. However, this clause is NOT REQUIRED for BPMN Process Modeling Conformance, BPMN Process Choreography Conformance, or BPMN Process Execution Conformance. For more information about BPMN conformance types, see page 1.

This clause covers a mapping of a **BPMN** model to WS-BPEL that is derived by analyzing the **BPMN** objects and the relationships between these objects.

A **Business Process Diagram** can be made up of a set of (semi-) independent components, which are shown as separate **Pools**, each of which represents an orchestration **Process**. There is not a specific mapping of the diagram itself, but rather, each of these *orchestration Processes* maps to an individual WS-BPEL *process*.

Not all **BPMN orchestration Processes** can be mapped to WS-BPEL in a straight-forward way. That is because **BPMN** allows the modeler to draw almost arbitrary graphs to model control flow, whereas in WS-BPEL, there are certain restrictions such as control-flow being either block-structured or not containing cycles. For example, an unstructured *loop* cannot directly be represented in WS-BPEL.

To map a **BPMN** orchestration **Process** to WS-BPEL it MUST be *sound*, that is it MUST contain neither a *deadlock* nor a *lack of synchronization*. A deadlock is a reachable state of the **Process** that contains a *token* on some **Sequence Flow** that cannot be removed in any possible future. A lack of synchronization is a reachable state of the **Process** where there is more than one *token* on some **Sequence Flow**. For further explanation of these terms, we refer to the literature. To define the structure of **BPMN Processes**, we introduce the following concepts and terminology. The **Gateways** and the **Sequence Flows** of the **BPMN** orchestration **Process** form a directed graph. A *block* of the diagram is a connected sub-graph that is connected to the rest of the graph only through exactly two **Sequence Flows**: exactly one **Sequence Flow** entering the block and exactly one **Sequence Flow** leaving the block. A *block hierarchy* for a **Process** model is a set of blocks of the **Process** model in which each pair of blocks is either nested or disjoint and which contains the maximal block (i.e., the whole **Process** model) A block that is nested in another block B is also called a *subblock* of B (cf. Figure 14.1). Each block of the block hierarchy of a given **BPMN** orchestration **Process** has a certain structure (or pattern) that provides the basis for defining the BPEL mapping.

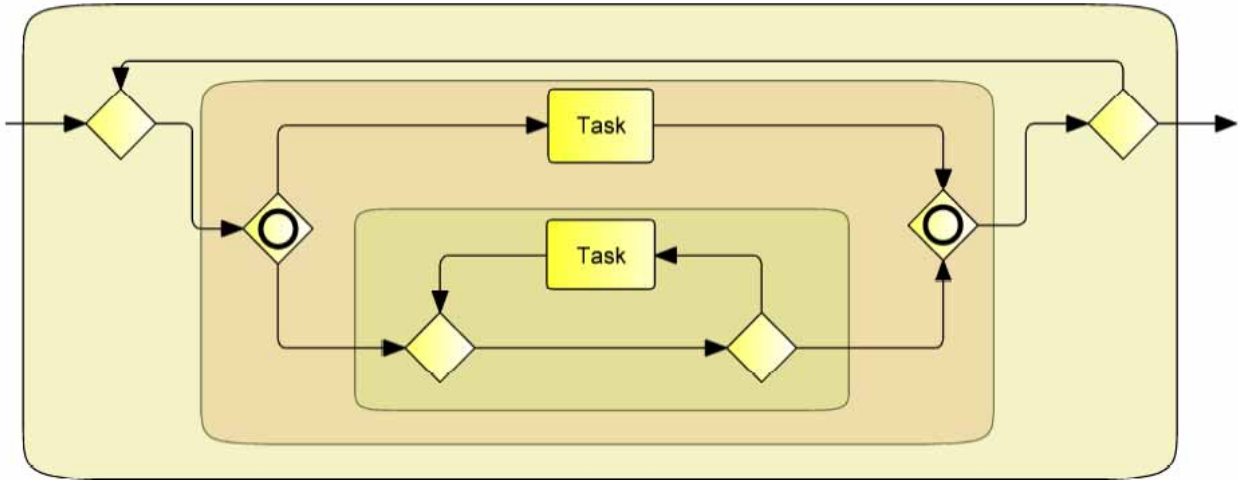

Figure 14.1 – A BPMN orchestration process and its block hierarchy

The following sub clauses define a syntactical BPEL mapping prescribing the resulting BPEL model at the syntactical level, and a semantic BPEL mapping prescribing the resulting BPEL model in terms of its observable behavior. The syntactical BPEL mapping is defined for a subset of **BPMN** models based on certain patterns of **BPMN** blocks, whereas the semantical BPEL mapping (which extends the syntactical mapping) does not enforce block patterns, allowing for the mapping of a larger class of **BPMN** models without prescribing the exact syntactical representation in BPEL.

14.2 Basic BPMN-BPEL Mapping

This sub clause introduces a partial mapping function from **BPMN** orchestration **Process** models to WS-BPEL executable **Process** models by recursively defining the mapping for elementary **BPMN** constructs such as **Tasks** and **Events**, and for blocks following the patterns described here. Mapping a **BPMN** block to WS-BPEL includes mapping all of its associated attributes. The observable behavior of a WS-BPEL process resulting from a BPEL mapping is the same as that of the original **BPMN** orchestration **Process**.

We use the notation [**BPMN** construct] to denote the WS-BPEL construct resulting from mapping the **BPMN** construct.

Examples are

[ServiceTask] = Invoke Activity

which says that a **BPMN Service Task** is mapped to a WS-BPEL Invoke Activity, or

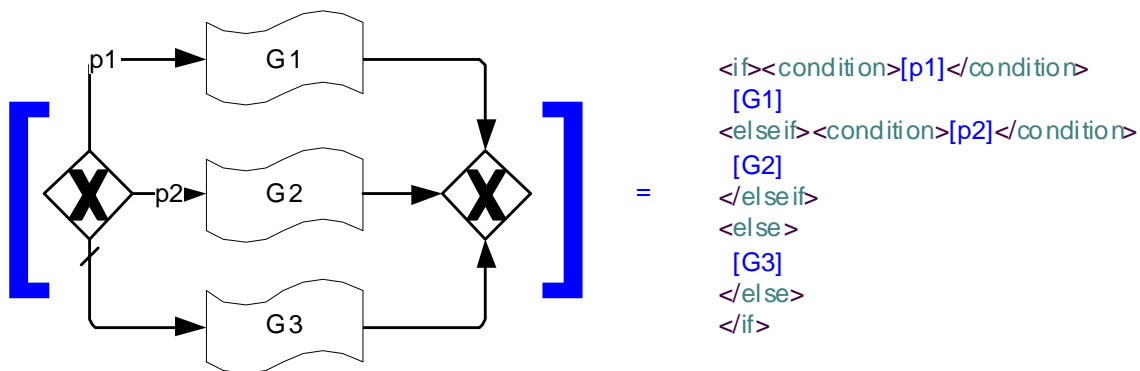

which says that the data-based exclusive choice controlled by the two predicates p1 and p2, containing the three **BPMN** blocks G1, G2, and G3 is mapped to the WS-BPEL on the right hand side, which recursively uses the mappings of those predicates and those sub-graphs. Note that we use the “waved rectangle” symbol throughout this sub clause to denote **BPMN** blocks.

14.2.1 Process

The following figure describes the mapping of a **Process**, represented by its defining **Collaboration**, to WS-BPEL. The process itself is described by a contained graph G of flow elements to WS-BPEL. The **Process** interacts with *Participants* Q1...Qn via **Conversations** C1...Cm:

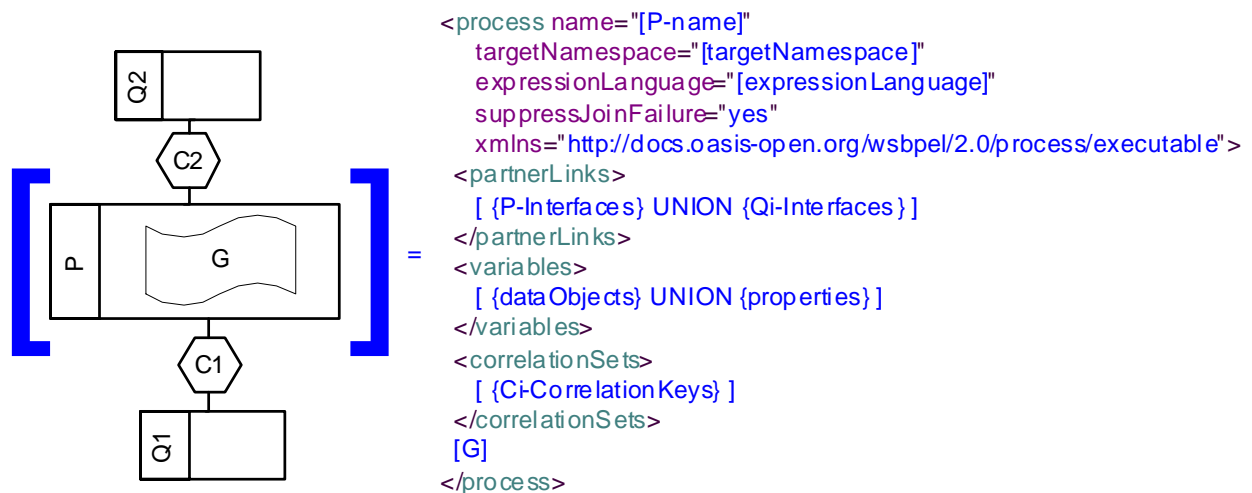

The partner links of the corresponding WS-BPEL process are derived from the set of interfaces associated with each participant. Each *interface* of the *Participant* P itself is mapped to a WS-BPEL partner link with a “myRole” specification, each interface of each other *Participant* Qi is mapped to a WS-BPEL partner link with a “partnerRole” specification.

The variables of the corresponding WS-BPEL process are derived from the set “{dataObjects}” of all **Data Objects** occurring within G, united with the set “{properties}” of all properties occurring within G, without **Data Objects** or properties contained in nested **Sub-Processes**. See “Handling Data” on page 465 for more details of this mapping.

The `correlation` sets of the corresponding WS-BPEL process are derived from the `CorrelationKeys` of the set of **Conversations** C1...Cn (see page 452 for more details of this mapping).

14.2.2 Activities

Common Activity Mappings

The following table displays a set of mappings of general **BPMN Activity** attributes to WS-BPEL activity attributes.

Table 14.1 – Common Activity Mappings to WS-BPEL

Activity	Mapping to WS-BPEL
name	The name attribute of a BPMN activity is mapped to the name attribute of a WS-BPEL activity by removing all characters not allowed in an XML NCName, and ensuring uniqueness by adding an appropriate suffix. In the subsequent diagrams, this mapping is represented as [name].

Task Mappings

The following sub clauses contain the mappings of the variations of a **Task** to WS-BPEL.

Service Task

The following figure shows the mapping of a **Service Task** to WS-BPEL.

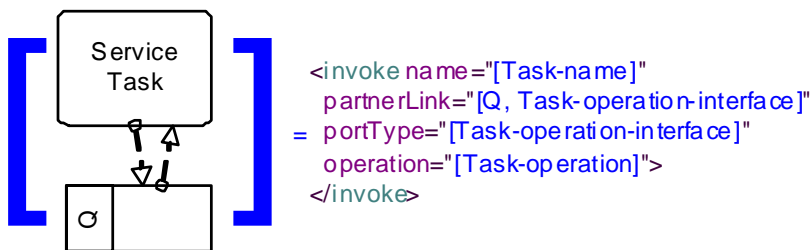

The partner link associated with the WS-BPEL `invoke` is derived from both the participant Q that the **Service Task** is connected to by **Message Flows**, and from the interface referenced by the operation of the **Service Task**.

Receive Task

The following figure shows the mapping of a **Receive Task** to WS-BPEL.

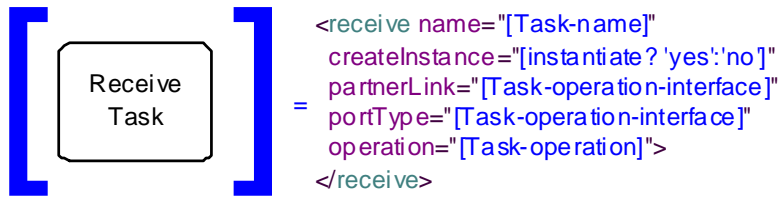

The partner link associated with the WS-BPEL receive is derived from the interface referenced by the operation of the **Receive Task**.

Send Task

The following figure shows the mapping of a **Send Task** to WS-BPEL.

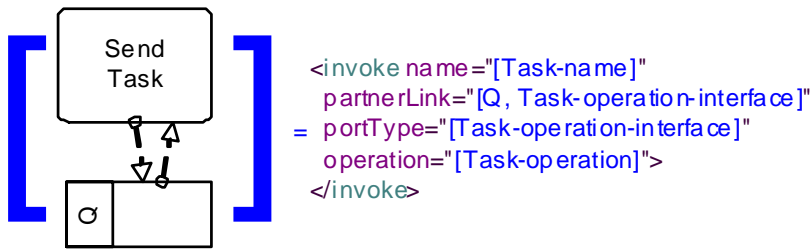

The partner link associated with the WS-BPEL invoke is derived from both the participant Q that the **Send Task** is connected to by a **Message Flow**, and from the interface referenced by the operation of the **Send Task**.

Abstract Task

The following figure shows the mapping of an **Abstract Task** to WS-BPEL.

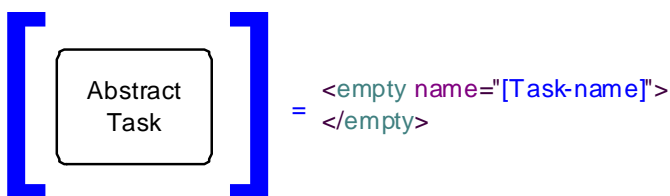

Service Package

Message

For **Messages** with a scalar data item definition typed by an XML schema definition, the following figure shows the mapping to WS-BPEL, using WSDL 1.1.

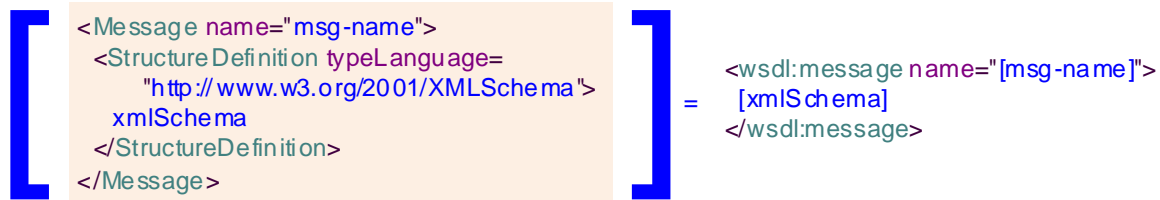

The top-level child elements of the XML schema defining the structure of the **BPMN Message** are mapped to the WSDL's message's parts.

Interface and Operation

The following figure shows the mapping of a **BPMN** interface with its operations to WS-BPEL, using WSDL 1.1.

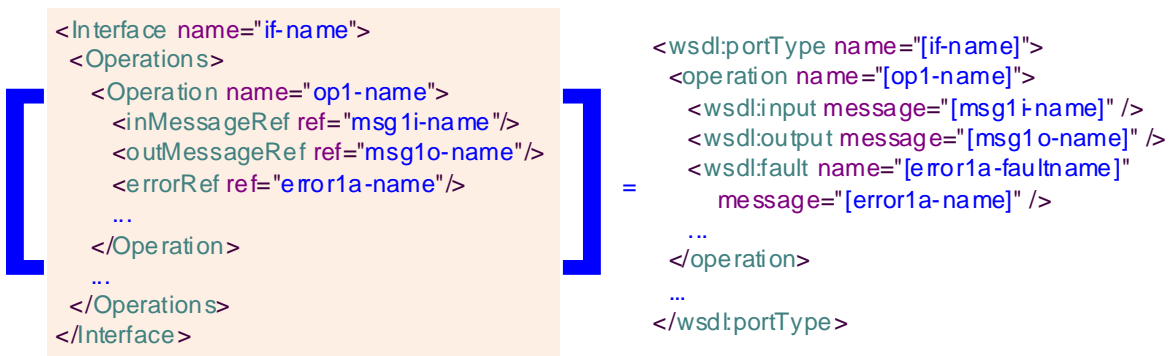

Conversations and Correlation

For those **BPMN** nodes sending or receiving **Messages** (i.e., **Message Events**, **Service**, send or **Receive Tasks**) that have an associated key-based **Correlation Key**, the mapping of that key-based **Correlation Key** is as follows.

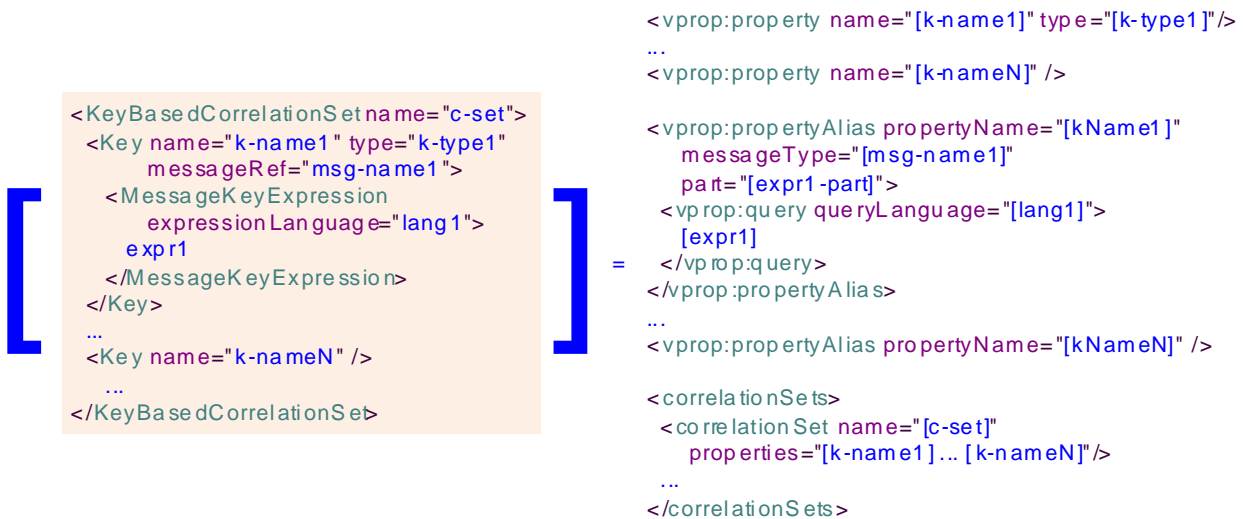

The `messageType` of the BPEL property alias is appropriately derived from the `itemDefinition` of the **Message** referenced by the **BPMN Message** key Expression. The name of the **Message** part is derived from the **Message** key Expression. The **Message** key Expression itself is transformed into an Expression relative to that part.

The mapping of **Activities** with an associated key-based Correlation Key is extended to reference the above BPEL correlation set in the corresponding BPEL `correlations` element. The following figure shows that mapping in the case of a **Service Task** with an associated key-based Correlation Key.

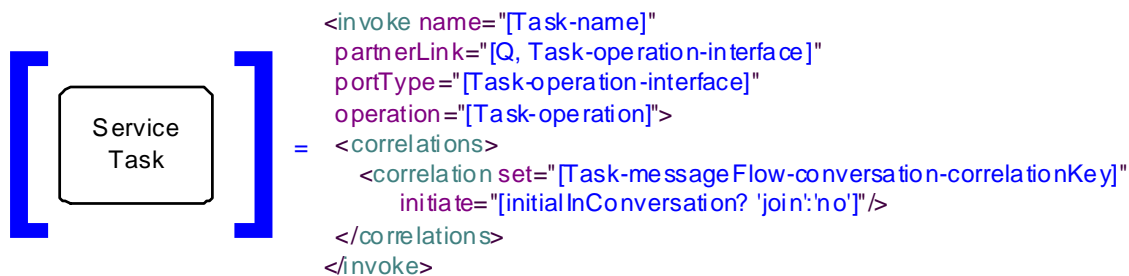

The `initiate` attribute of the BPEL `correlation` element is set depending on whether or not the associated **Message Flow** initiates the associated **Conversations**, or participates in an already existing **Conversation**. If there are multiple `CorrelationKeys` associated with the **Conversation**, multiple `correlation` elements are used.

Sub-Process Mappings

The following table displays the mapping of an embedded **Sub-Process** with `Adhoc="False"` to a WS-BPEL scope. (This extends the mappings that are defined for all **Activities**--see page 448).

The following figure shows the mapping of a **BPMN Sub-Process** without an **Event Sub-Process**.

The following figure shows the mapping of a **BPMN Sub-Process** with an **Event Sub-Process**. (**Event Sub-Processes** could also be added to a top-level **Process**, in which case their mapping extends correspondingly.)

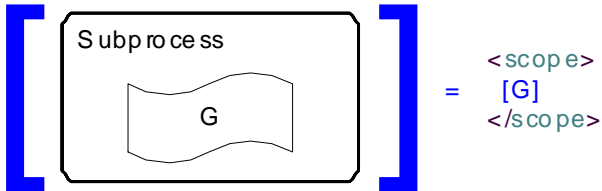

Note that in case of multiple **Event Sub-Processes**, there would be multiple WS-BPEL handlers.

Mapping of Event Sub-Processes

Note that if a **Sub-Process** contains multiple **Event Sub-Processes**, all become handlers of the associated WS-BPEL scope, ordered and grouped as specified by WS-BPEL.

Non-interrupting **Message Event Sub-Processes** are mapped to WS-BPEL event handlers as follows.

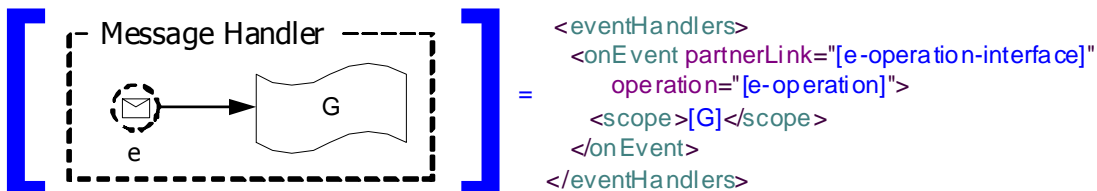

Timer **Event Sub-Processes** are mapped to WS-BPEL event handlers as follows.

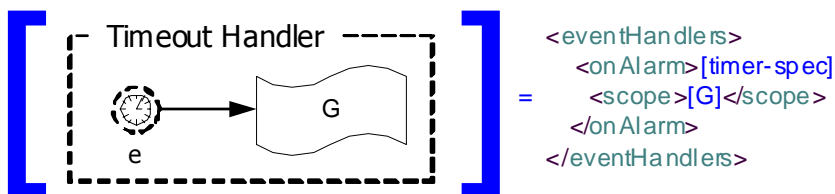

Error **Event Sub-Processes** are mapped to WS-BPEL fault handlers as follows.

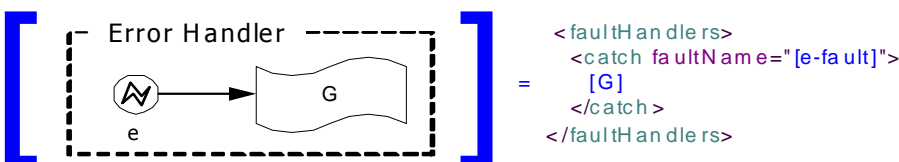

A **Compensation Event Sub-Process** is mapped to a WS-BPEL compensation handler as follows.

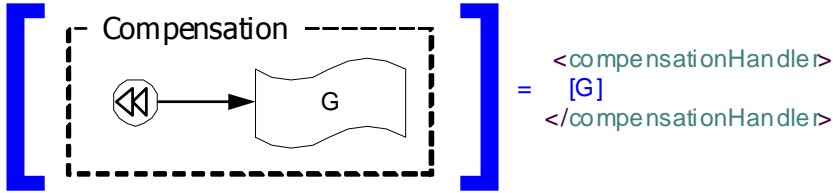

Activity Loop Mapping

Standard *loops* with a testTime attribute “Before” or “After” execution of the **Activity** map to WS-BPEL `while` and `repeatUntil` activities in a straight-forward manner. When the `LoopMaximum` attribute is used, additional activities are used to maintain a *loop* counter.

Multi-instance Activities map to WS-BPEL `forEach` activities in a straight-forward manner.

Standard Loops

The mappings for standard *loops* to WS-BPEL are described in the following.

A standard *loop* with testTime= “Before” maps to WS-BPEL as follows, where *p* denotes the *loop* condition.

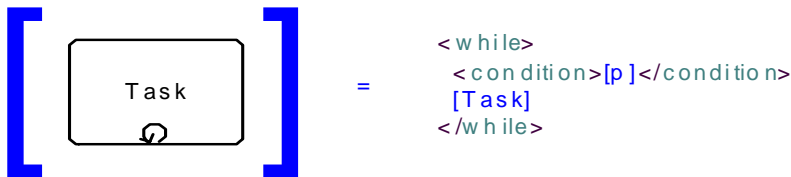

A standard *loop* with testTime= “After” maps as follows, where *p* denotes the *loop* condition.

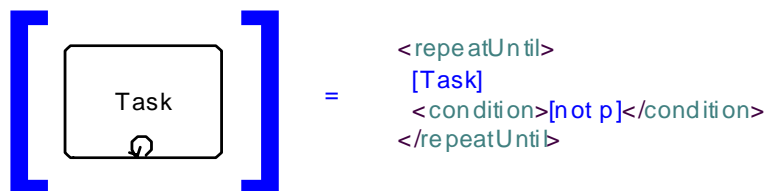

Dealing with LoopMaximum

When the `LoopMaximum` attribute is specified for an **Activity**, the *loop* requires additional set up for maintaining a counter.

A standard *loop* with testTime="Before" and a LoopMaximum attribute maps to WS-BPEL as follows (again, *p* denotes the loopCondition).

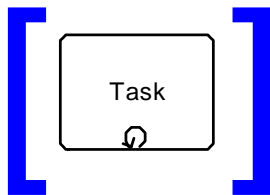

```

<variable name="[counter]" type="xsd:integer"/>
...
<sequence>
  <assign>
    <copy>
      <from><literal>0</literal></from>
      <to variable="[counter]"/>
    </copy>
  </assign>
  <while>
    <condition>[p] and $('[counter]' < [LoopMaximum]</condition>
    <sequence>
      [G]
      <assign>
        <copy>
          <from expression=" $('[counter]+1'"/>
          <to variable="[counter]" />
        </copy>
      </assign>
    </sequence>
  </while>
</sequence>

```

(The notation [counter] denotes the unique name of a variable used to hold the counter value; the actual name is immaterial.)

A standard *loop* with testTime="After" and a LoopMaximum attribute maps as follows:

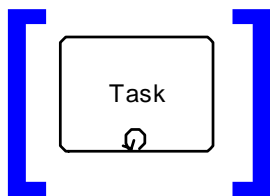

```

<variable name="[counter]" type="xsd:integer"/>
...
<sequence>
  <assign>
    <copy>
      <from><literal>0</literal></from>
      <to variable="[counter]"/>
    </copy>
  </assign>
  <repeatUntil>
    <sequence>
      [G]
      <assign>
        <copy>
          <from expression=" $('[counter]+1'"/>
          <to variable="[counter]" />
        </copy>
      </assign>
    </sequence>
    <condition>[not p] or $('[counter]' > [LoopMaximum]</condition>
  </repeatUntil>
</sequence>

```

(The notation [counter] denotes the unique name of a variable used to hold the counter value; the actual name is immaterial.)

Multi-Instance Activities

A **BPMN Multi-Instance Task** with a multiInstanceFlowCondition of “All” is mapped to WS-BPEL as follows.

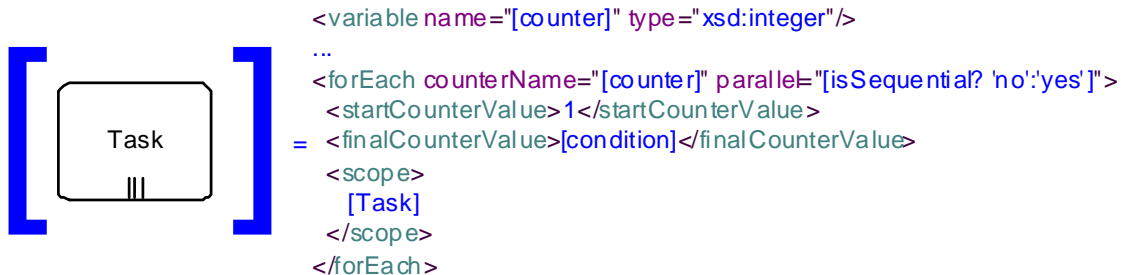

(The notation [counter] denotes the unique name of a variable used to hold the counter value; the actual name is immaterial.)

14.2.3 Events

Start Event Mappings

The following sub clauses detail the mapping of **Start Events** to WS-BPEL.

Message Start Events

A **Message Start Event** is mapped to WS-BPEL as shown in the following figure.

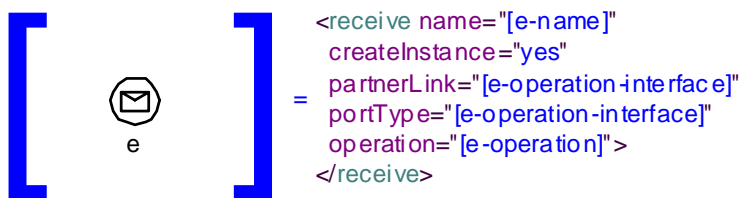

The partner link associated with the WS-BPEL receive is derived from the interface referenced by the operation of the **Message Start Event**.

Error Start Events

An **Error Start Event** can only occur in **Event Sub-Processes**. This mapping is described on page 455.

Compensation Start Events

A **Compensation Start Event** can only occur in **Event Sub-Processes**. This mapping is described on page 455.

Intermediate Event Mappings (Non-boundary)

The following sub clauses detail the mapping of intermediate non-boundary **Events** to WS-BPEL.

Message Intermediate Events (Non-boundary)

A **Message Intermediate Event** can either be used in normal control flow, similar to a **Send** or **Receive Task** (for *throw* or *catch* **Message Intermediate Events**, respectively), or it can be used in an **Event Gateway**. The latter is described in more detail in “Gateways and Sequence Flows” on page 461.

The following figure describes the mapping of **Message Intermediate Events** to WS-BPEL.

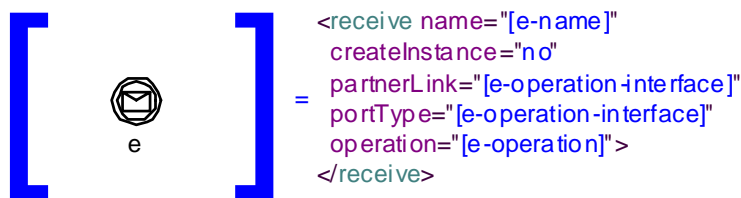

The partner link associated with the WS-BPEL receive is derived from the interface referenced by the operation of the **Message Intermediate Event**.

Timer Intermediate Events (Non-boundary)

A **Timer Intermediate Event** can either be used in normal control flow, or it can be used in an **Event Gateway**. The latter is described in more detail in “Gateways and Sequence Flows” on page 461.

The following figure describes the mapping of a **Timer Intermediate Event** to WS-BPEL – note that one of the mappings shown is chosen depending on whether the **Timer Event’s** `TimeCycle` or `TimeDate` attribute is used.

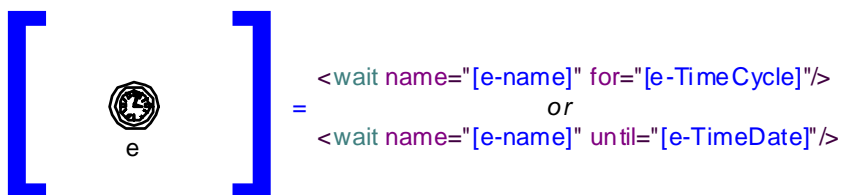

Compensation Intermediate Events (Non-boundary)

A **Compensation Intermediate Event** with its `waitForCompletion` property set to *true*, that is used within an **Event Sub-Process** triggered through an *error* or through *compensation*, is mapped to WS-BPEL as follows.



The first mapping is used if the **Compensation Event** does not reference an **Activity**, the second mapping is used otherwise.

End Event Mappings

The following sub clauses detail the mapping of **End Events** to WS-BPEL.

None End Events

A “none” **End Event** marking the end of a **Process** is mapped to WS-BPEL as shown in the following figure.

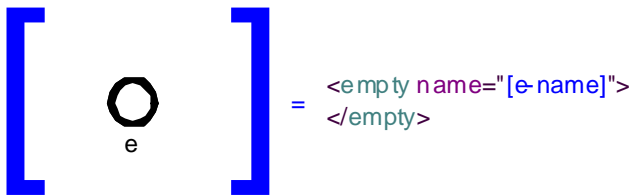

Message End Events

A **Message Start Event** is mapped to WS-BPEL as shown in the following figure.

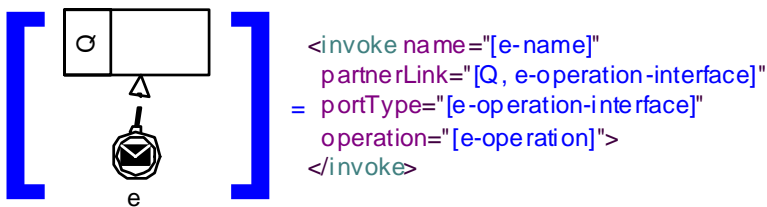

The partner link associated with the WS-BPEL invoke is derived from both the participant Q that the **Message Intermediate Event** is connected to by a **Message Flow**, and from the interface referenced by the operation of the **Message Intermediate Event**.

Error End Events

An **Error End Event** is mapped to WS-BPEL as shown in the following figure.

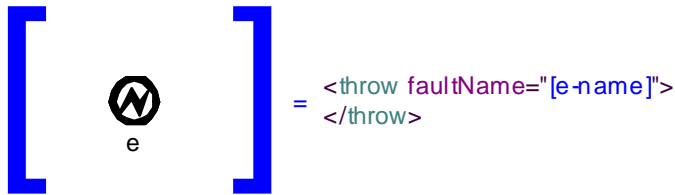

Compensation End Events

A **Compensation End Event** with its `waitForCompletion` property set to `true`, that is used within an **Event Sub-Process** triggered through an *error* or through *compensation*, is mapped to WS-BPEL as follows.



The first mapping is used if the **Compensation Event** does not reference an **Activity**, the second mapping is used otherwise.

Terminate End Events

A **Terminate End Event** is mapped to WS-BPEL as shown in the following figure.

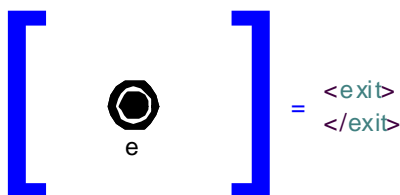

Boundary Intermediate Events

Message Boundary Events

A **BPMN Activity** with a non-interrupting **Message** boundary **Event** is mapped to a WS-BPEL scope with an event handler as follows.

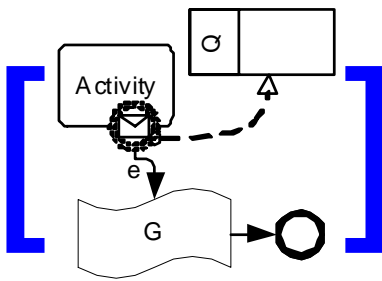

```

<scope>
  <eventHandlers>
    <onEvent partnerLink="[Q, e-operation-interface]"
      operation="[e-operation]">
      <scope>[G]</scope>
    </onEvent>
  </eventHandlers>
  [Activity]
</scope>

```

The partner link associated with the WS-BPEL onEvent is derived from the interface referenced by the operation of the boundary **Message Event**.

The same mapping applies to a non-interrupting boundary **Timer Event**, using a WS-BPEL onAlarm handler instead.

Error Boundary Events

A **BPMN Activity** with a boundary **Error Event** according to the following pattern is mapped as shown.

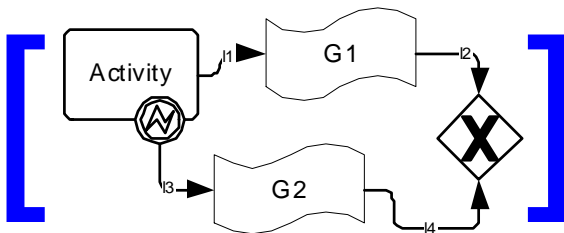

```

<flow>
  <links>
    <link name="[1]" />
    ...
    <link name="[4]" />
  </links>
  <scope>
    <sources><source linkName="[1]" /></sources>
    <faultHandlers>
      <catch faultName="[e-error]">
        <empty>
          <sources><source linkName="[3]" /></sources>
        </empty>
      </catch>
    </faultHandlers>
    [Activity]
  </scope>
  <flow>
    <targets><target linkName="[1]" /></targets>
    <sources><source linkName="[2]" /></sources>
    [G1]
  </flow>
  <flow>
    <targets><target linkName="[3]" /></targets>
    <sources><source linkName="[4]" /></sources>
    [G2]
  </flow>
  <empty>
    <sources><source linkName="[2]" />
    <source linkName="[4]" /></sources>
  </empty>
</flow>

```

Note that the case where the error handling path doesn't join the main control flow again, is still mapped using this pattern, by applying the following model equivalence.

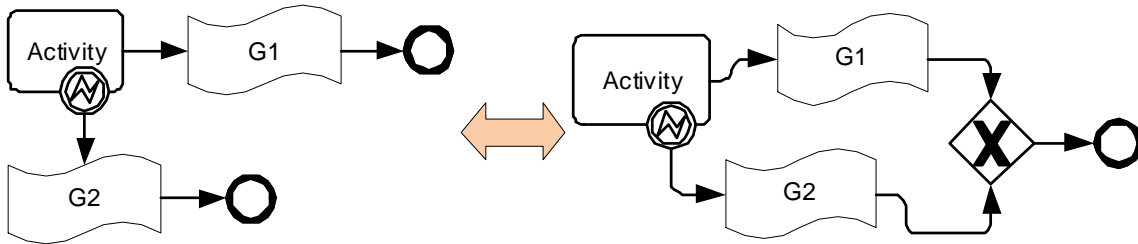

Compensation Boundary Events

A **BPMN Activity** with a *boundary Compensation Event* is similarly mapped as shown.

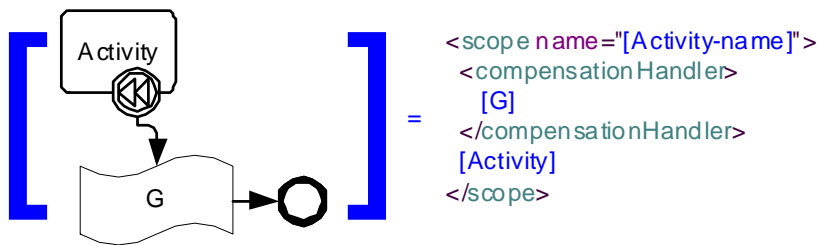

Multiple Boundary Events, and Boundary Events with Loops

If there are multiple boundary **Events** for an **Activity**, their WS-BPEL mappings are super-imposed on the single WS-BPEL scope wrapping the mapping of the **Activity**.

When the **Activity** is a standard *loop* or a *multi-instance* and has one or more boundary **Events**, the WS-BPEL *loop* resulting from mapping the **BPMN loop** is nested inside the WS-BPEL scope resulting from mapping the **BPMN boundary Events**.

The following example shows that mapping for a **Sub-Process** with a nested **Event Sub-Process** that has a standard *loop* with `TestTime="Before,"` a boundary **Error Intermediate Event**, and a boundary **Compensation Intermediate Event**.

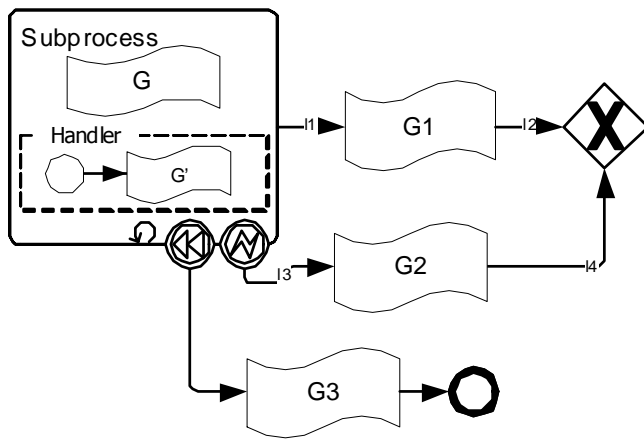

```

<flow>
  <links>
    <link name="[1]" />
    ...
    <link name="[4]" />
  </links>
  <scope>
    <sources><source linkName="[1]" /></sources>
    <faultHandlers>
      <catch faultName="[e-error]">
        <empty>
          <sources><source linkName="[3]" /></sources>
        </empty>
      </catch>
    </faultHandlers>
    <compensationHandler>
      [G3]
    </compensationHandler>
    <while>
      <condition>[p]</condition>
      <scope>
        [Handler]
        [G]
      </scope>
    </while>
  </scope>
  <flow>
    <targets><target linkName="[1]" /></targets>
    <sources><source linkName="[2]" /></sources>
    [G1]
  </flow>
  <flow>
    <targets><target linkName="[3]" /></targets>
    <sources><source linkName="[4]" /></sources>
    [G2]
  </flow>
  <empty>
    <sources><source linkName="[2]" />
    <source linkName="[4]" /></sources>
  </empty>
</flow>

```

14.2.4 Gateways and Sequence Flows

The mapping of **BPMN Gateways** and **Sequence Flows** is described using **BPMN** blocks following particular patterns.

Exclusive (Data-based) Decision Pattern

An exclusive data-based decision is mapped as follows.

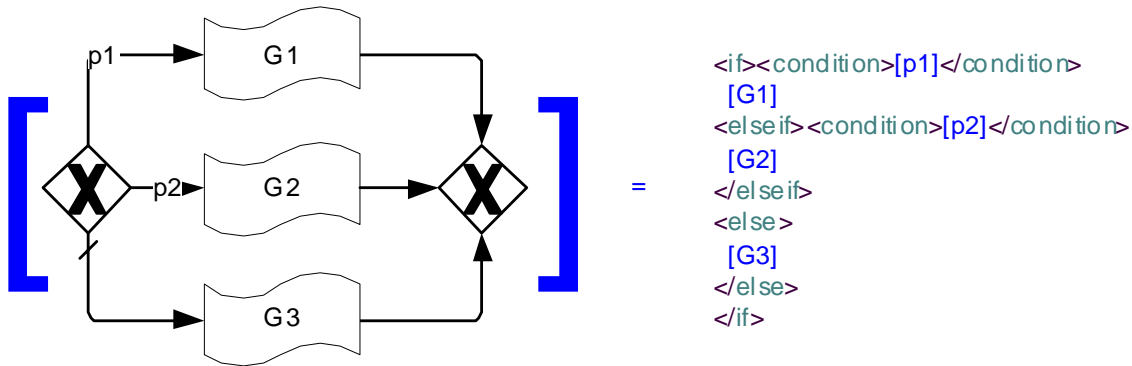

While this figure shows three branches, the pattern is generalized to n branches in an obvious manner.

Exclusive (Event-based) Decision Pattern

An **Event Gateway** is mapped as follows.

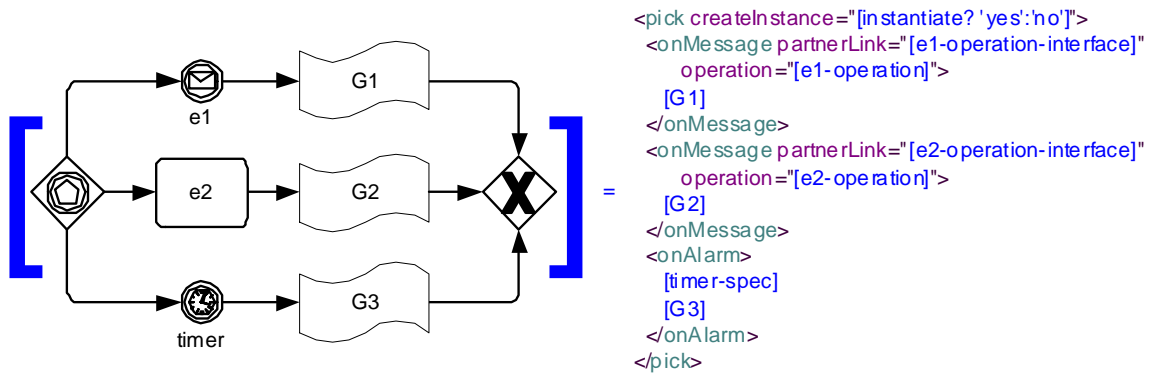

While this figure shows three branches with one **Message Intermediate Event**, one **Receive Task** and one **Timer Intermediate Event**, the pattern is generalized to n branches with any combination of the former in an obvious manner. The handling of *Participants* (BPEL partnerLinks), **Event** (operation) and timer details is as specified for **Message Intermediate Events**, **Receive Tasks**, and **Timer Intermediate Events**, respectively. The data flow and associated variables (not shown) are handled as for **Receive Tasks/Message Intermediate Events**.

Inclusive Decision Pattern

An inclusive decision pattern without an otherwise gate is mapped as follows:

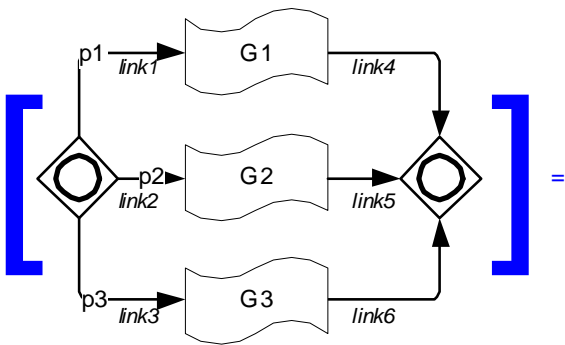

```

<flow>
  <links>
    <link name="[link1]"/>
    ...
    <link name="[link6]"/>
  </links>

  <empty>
    <sources>
      <source linkName="[link1]">
        <transitionCondition>[p1]</transitionCondition>
      </source>
      <source linkName="[link2]">
        <transitionCondition>[p2]</transitionCondition>
      </source>
      <source linkName="[link3]">
        <transitionCondition>[p3]</transitionCondition>
      </source>
    </sources>
  </empty>

  <flow>
    <targets><target linkName="[link1]"/></targets>
    <sources><source linkName="[link4]"/></sources>
    [G1]
  </flow>

  <flow>
    <targets><target linkName="[link2]"/></targets>
    <sources><source linkName="[link5]"/></sources>
    [G2]
  </flow>

  <flow>
    <targets><target linkName="[link3]"/></targets>
    <sources><source linkName="[link6]"/></sources>
    [G3]
  </flow>

  <empty>
    <targets>
      <target linkName="[link4]"/>
      <target linkName="[link5]"/>
      <target linkName="[link6]"/>
    </targets>
  </empty>
</flow>

```

While this figure shows three branches, the pattern is generalized to n branches in an obvious manner.

Note that link names in WS-BPEL MUST follow the rules of an XML NCName. Thus, the mapping of the **BPMN Sequence Flow** name attribute MUST appropriately canonicalize that name, possibly ensuring uniqueness, e.g., by appending a unique suffix. This is captured by the [linkName] notation.

Parallel Pattern

A parallel fork-join pattern is mapped as follows.

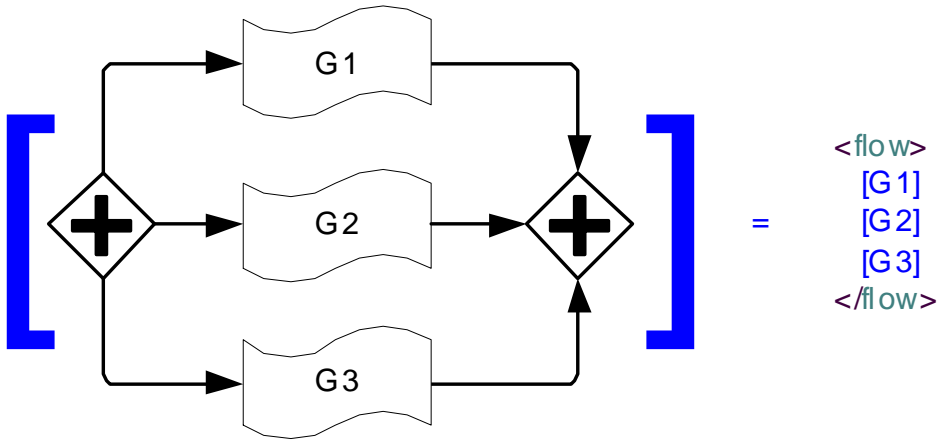

Sequence Pattern

A **BPMN** block consisting of a series of **Activities** connected via (unconditional) **Sequence Flows** is mapped to a WS-BPEL sequence:

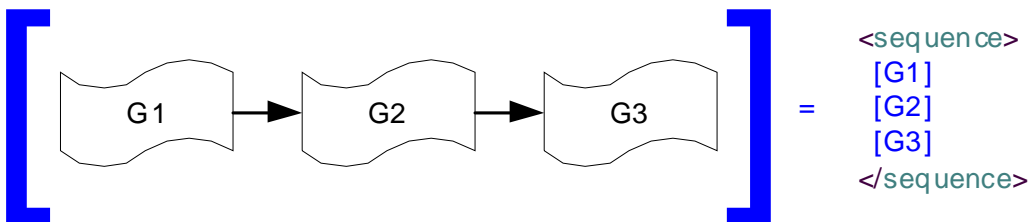

Structured Loop Patterns

A **BPMN** block consisting of a structured *loop* of the following pattern is mapped to a WS-BPEL `while`.

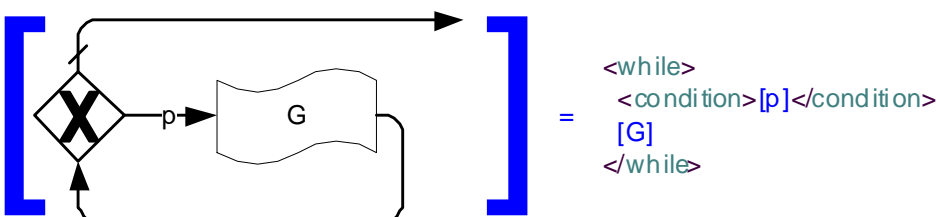

A **BPMN** block consisting of a structured *loop* of the following pattern is mapped to a WS-BPEL `repeatUntil`.

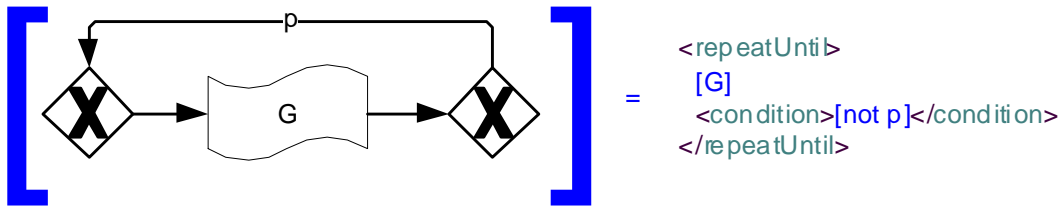

Handling Loops in Sequence Flows

Loops are created when the flow of the **Process** moves from a downstream object to an upstream object. There are two types of *loops* that are WS-BPEL mappable: *while loops* and *repeat loops*.

A *while loop* has the following structure in **BPMN** and is mapped as shown.

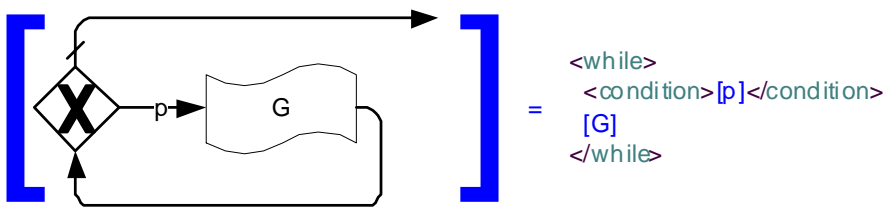

A *repeat loop* has the following structure in **BPMN** and is mapped as shown.

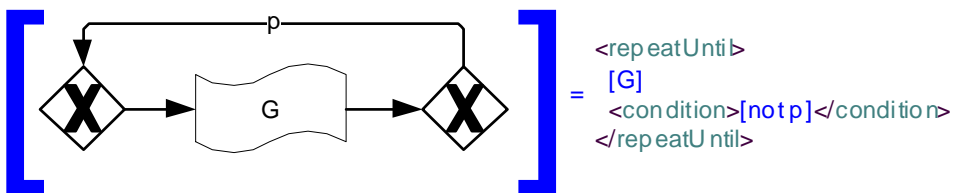

14.2.5 Handling Data

Data Objects

BPMN Data Objects are mapped to WS-BPEL variables. The **itemDefinition** of the **Data Object** determines the XSD type of that variable.

Data Objects occur in the context of a **Process** or **Sub-Process**. For the associated WS-BPEL process or WS-BPEL scope, a variable is added for each **Data Object** in the corresponding WS-BPEL `variables` sub clause, as follows:

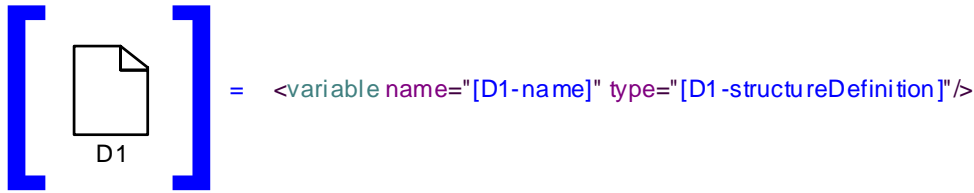

Properties

BPMN properties can be contained in a **Process**, **Activity**, or an **Event**, here named the “container” of the property. A **BPMN** property is mapped to a WS-BPEL variable. Its name is derived from the name of its container and the name of the property. Note that in the case of different containers with the same name and a contained property of the same name, the mapping to WS-BPEL ensures the names of the associated WS-BPEL variables are unique. The `itemDefinition` of the property determines the XSD type of that variable.

A **BPMN Process** property is mapped to a WS-BPEL global variable. A **BPMN Event** property is mapped to a WS-BPEL variable contained in the WS-BPEL scope representing the immediately enclosing **Sub-Process** of the **Event** (or a global variable in case the **Event** is an immediate child of the **Process**). For a **BPMN Activity** property, two cases are distinguished: In case of a **Sub-Process**, the WS-BPEL variable is contained in the WS-BPEL scope representing the **Sub-Process**. For all other **BPMN Activity** properties, the WS-BPEL variable is contained in the WS-BPEL scope representing the immediately enclosing **Sub-Process** of the **Activity** (or a global variable in case the **Activity** is an immediate child of the **Process**).

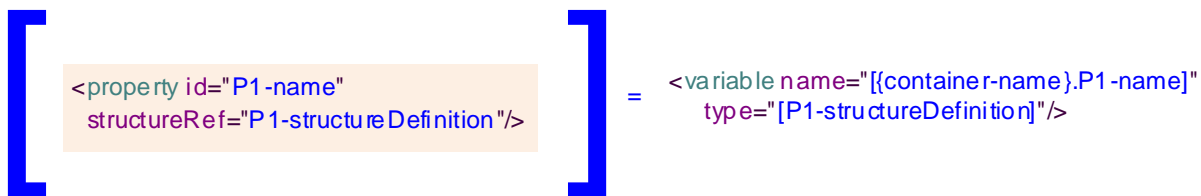

Input and Output Sets

For a **Send Task** and a **Service Task**, the single input set is mapped to a WSDL message defining the input of the associated WS-BPEL activity. The inputs map to the message parts of the WSDL message. For a **Receive Task** and a **Service Task**, the single output set is mapped to a WSDL message defining the output of the associated WS-BPEL activity. The outputs map to the message parts of the WSDL message.

The structure of the WSDL message is defined by the `itemDefinitions` of the data inputs of the input set.

```

<inputSet name="iset">
  <dataInput name="input1">
    <structureDefinition structure="type1"/>
  </dataInput>
  ...
</inputSet>

```

=

```

<wsdl:message name="[iset-name]">
  <part name="[input1-name]" type="[type1]"/>
  ...
</wsdl:message>

```

For the data outputs of the output set, the WSDL message looks as follows.

```

<outputSet name="oSet">
  <dataOutput name="output1">
    <structureDefinition structure="type3"/>
  </dataOutput>
  ...
</outputSet>

```

=

```

<wsdl:message name="[oSet-name]">
  <part name="[output1-name]" type="[type3]"/>
  ...
</wsdl:message>

```

Data Associations

In this sub clause, we assume that the input set of the **Service Task** has the same structure as its referenced input **Message**, and the output set of the **Service Task** has the same structure as its reference output **Message**. If this is not the case, assignments are needed, and the mapping is as described in the next sub clause.

Data associations to and from a **Service Task** are mapped as follows.

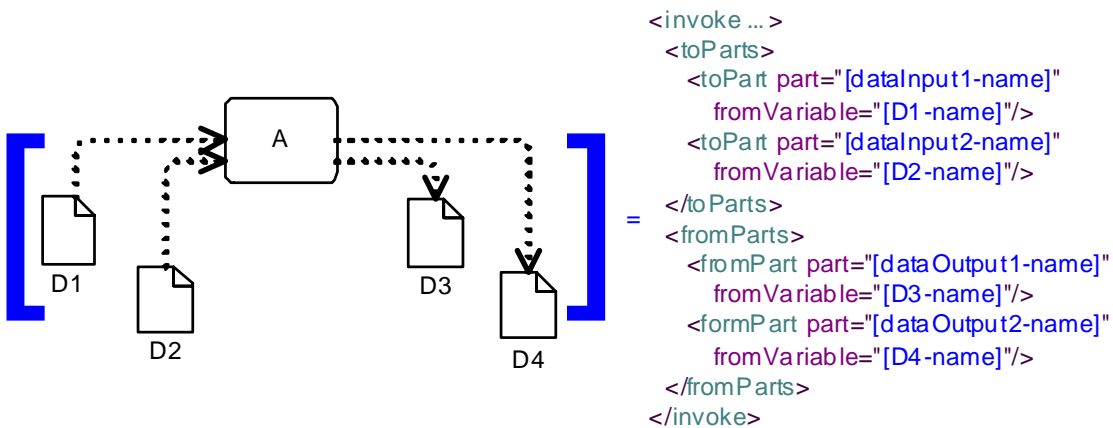

Data associations from a **Receive Task** are mapped as follows.

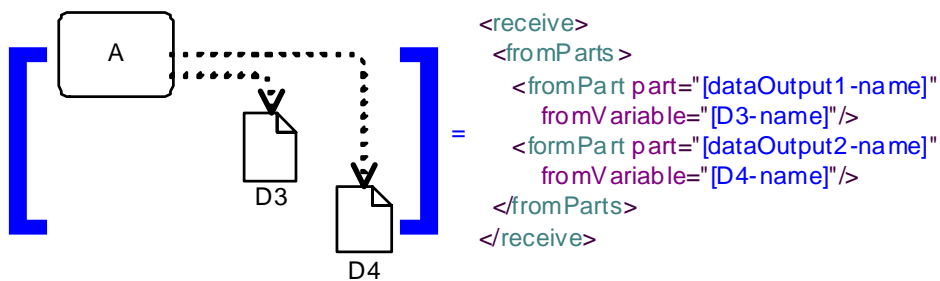

Data associations to a **Send Task** are mapped as follows.

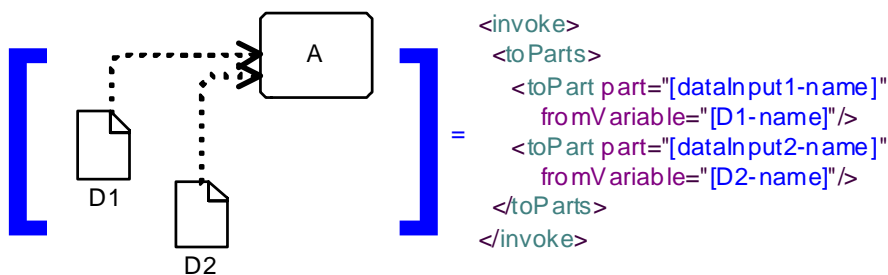

Expressions

BPMN Expressions specified using XPath (e.g., a condition Expression of a **Sequence Flow**, or a timer cycle Expression of a **Timer Intermediate Event**) are used as specified in **BPMN**, rewriting access to **BPMN** context to refer to the mapped BPEL context.

The **BPMN** XPath functions for accessing context from the perspective of the current **Process** are mapped to BPEL XPath functions for context access as shown in the following table. This is possible because the arguments **MUST** be literal strings.

Table 14.2 – Expressions mapping to WS-BPEL

BPMN context access	BPEL context access
getDataobject(dataObjectName)	`\${dataObjectName}`
getProcessProperty(propertyName)	`\${{processName}.propertyName}` where the right processName is statistically derived.
getActivityProperty(activityName, propertyName)	`\${activityName.propertyName}`
getEventProperty(eventName, propertyName)	`\${eventName.propertyName}`

Assignments

For a **Service Task** with assignments, the WS-BPEL mapping results in a sequence of an assign activity, an invoke activity and another assign activity. The first assign deals with creating the service request **Message** from the data inputs of the **Task**, the second assign deals with creating the data outputs of the **Task** from the service response **Message**.

14.3 Extended BPMN-BPEL Mapping

Additional sound **BPMN Process** models whose block hierarchy contains blocks that have not been addressed in the previous sub clause can be mapped to WS-BPEL. For such **BPMN Process** models, in many cases there is no preferred single mapping of a particular block, but rather, multiple WS-BPEL patterns are possible to map that block to. Also, additional **BPMN** constructs can be mapped by using capabilities not available at the time of producing this specification, such as the upcoming OASIS BPEL4People standard to map **BPMN User Tasks**, or other WS-BPEL extensions.

Rather than describing or even mandating the mapping of such **BPMN** blocks, this specification allows for a semantic mapping of a **BPMN Process** model to an executable WS-BPEL process: The observable behavior of the target WS-BPEL process **MUST** match the operational semantics of the mapped **BPMN Process**. Also, the mappings described in sub clause 15.1 **SHOULD** be used where applicable.

14.3.1 End Events

End Events can be combined with other **BPMN** objects to complete the merging or joining of the paths of a WS-BPEL structured element (see Figure 7.3).

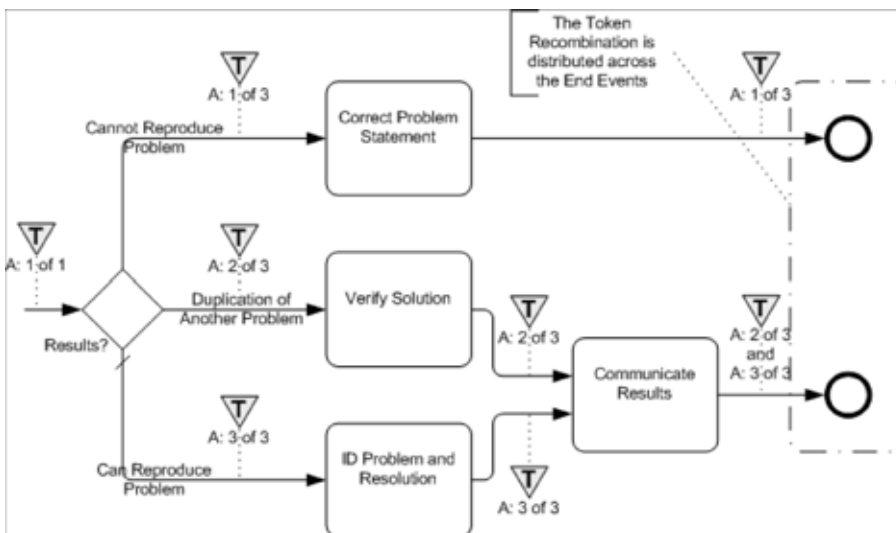

Figure 14.2 – An example of distributed *token* recombination

14.3.2 Loop/Switch Combinations From a Gateway

This type of *loop* is created by a **Gateway** that has three or more *outgoing* **Sequence Flows**. One **Sequence Flow** *loops back upstream* while the others continue *downstream* (see Figure 14.3). Note that there might be intervening **Activities** prior to when the **Sequence Flow** *loops back upstream*.

- This maps to both a WSBPEL *while* and a *switch*. Both activities will be placed within a *sequence*, with the *while* preceding the *switch*.
- For the *while*:
 - The *Condition* for the **Sequence Flow** that *loops back upstream* will map to the *condition* of the *while*.
 - All the **Activities** that span the distance between where the *loop* starts and where it ends, will be mapped and placed within the **Activity** for the *while*, usually within a *sequence*.
- For the *switch*:
 - For each additional *outgoing Sequence Flows* there will be a *case* for the *switch*.

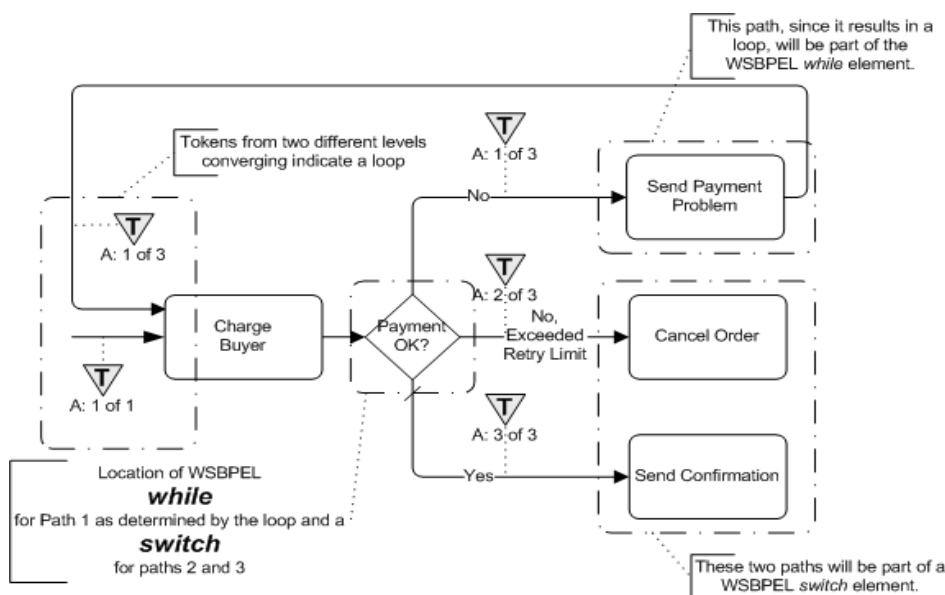

Figure 14.3 – An example of a loop from a decision with more than two alternative paths

14.3.3 Interleaved Loops

This is a situation where there are at least two *loops* involved and they are not nested (see Figure 14.4). Multiple looping situations can map, as described above, if they are in a sequence or are fully nested (e.g., one *while* inside another *while*). However, if the *loops* overlap in a non-nested fashion, as shown in the figure, then the structured element *while* cannot be used to handle the situation. Also, since a *flow* is acyclic, it cannot handle the behavior either.

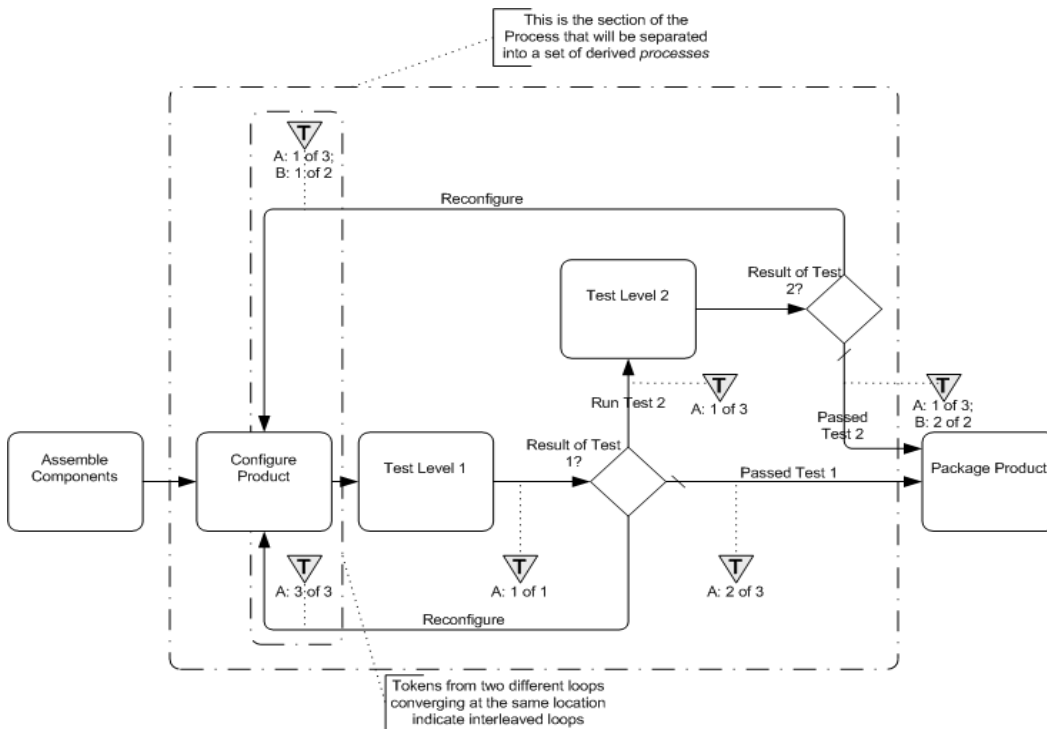

Figure 14.4 – An example of interleaved loops

To handle this type of behavior, parts of the WSBPEL *process* will have to be separated into one or more derived *processes* that are spawned from the main *process* and will also spawn or call each other (note that the examples below are using a spawning technique). Through this mechanism, the linear and structured elements of WSBPEL can provide the same behavior that is shown through a set of cycles in a single **BPMN** diagram. To do this:

- The looping section of the **Process**, where the *loops* first merge back (*upstream*) into the flow until all the paths have merged back to *Normal Flow*, SHALL be separated from the main WSBPEL *process* into a set of derived *processes* that will spawn each other until all the looping conditions are satisfied.
- The section of the *process* that is removed will be replaced by a (one-way) *invoke* to spawn the derived *process*, followed by a *receive* to accept the *message* that the looping sections have completed and the main *process* can continue (see Figure 14.5).
- The name of the *invoke* will be in the form of:
 - “Spawn_[(loop target)activity.Name]_Derived_Process”
 - The name of the *receive* will be in the form of:
 - [(loop target)activity.Name]_Derived_Process_Completed”



Figure 14.5 – An example of the WSBPEL pattern for substituting for the derived *Process*

For each location in the **Process** where a **Sequence Flow** connects *upstream*, there will be a separate derived WSBPEL *process*.

- The name of the derived *process* will be in the form of:
 - “[*(loop target)activity.Name*]_Derived_Process”
- All **Gateways** in this sub clause will be mapped to *switch* elements, instead of *while* elements (see Figure below).
- Each time there is a **Sequence Flow** that *loops back upstream*, the **Activity** for the *switch case* will be a (one-way) *invoke* that will spawn the appropriate derived *process*, even if the *invoke* spawns the same *process* again.
- The name of the *invoke* will be the same as the one described above.
- At the end of the derived *process* a (one-way) *invoke* will be used to signal the main *process* that all the derived activities have completed and the main *process* can continue.
- The name of the *invoke* will be in the form of:
 - “[*(loop target)activity.Name*]_Derived_Process_Completed”

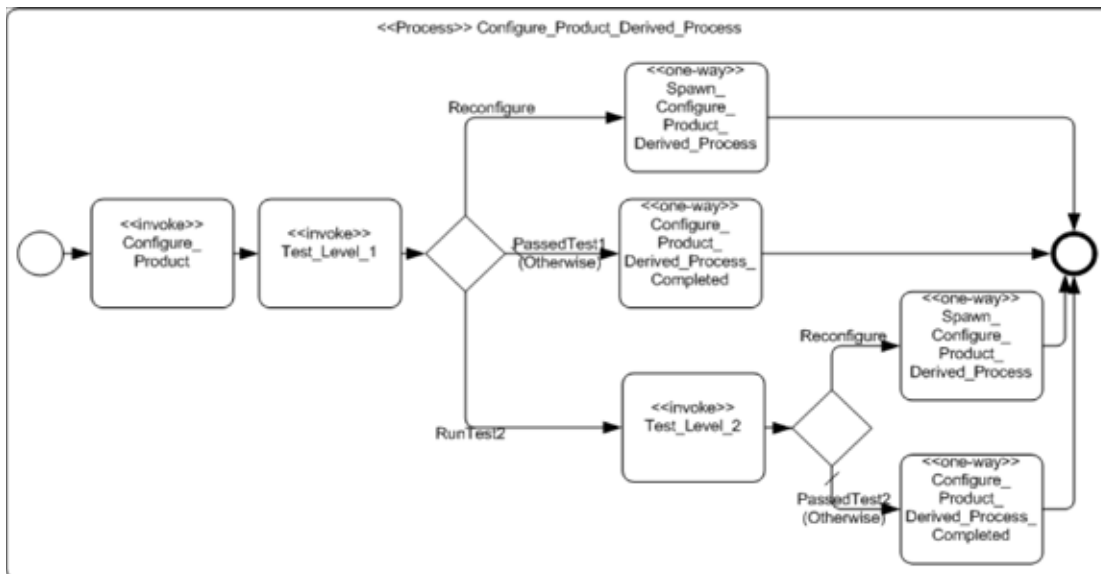

Figure 14.6 – An example of a WSBPEL pattern for the derived *Process*

14.3.4 Infinite Loops

This type of *loop* is created by a **Sequence Flow** that *loops* back without an intervening **Gateway** to create alternative paths (see Figure 14.7). While this can be a modeling error most of the time, there can be situations where this type of *loop* is desired, especially if it is placed within a larger **Activity** that will eventually be interrupted.

- This will map to a *while* activity.
- The condition of the *while* will be set to an Expression that will never evaluate to *true*, such as *condition* "1 = 0."
- All the activities that span the distance between where the *loop* starts and where it ends, will be mapped and placed within the activity for the *while*, usually within a *sequence*.

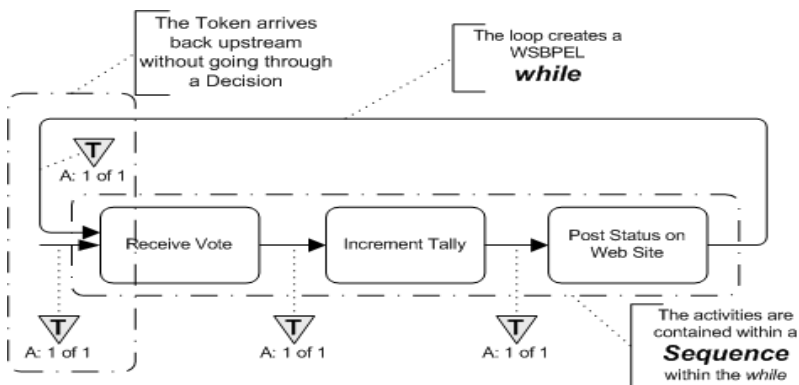

Figure 14.7 – An example: An infinite loop

14.3.5 BPMN Elements that Span Multiple WSBPEL Sub-Elements

Figure 14.8 illustrates how **BPMN** objects can exist in two separate sub-elements of a WSBPEL structured element at the same time. Since **BPMN** allows free form connections of **Activities** and **Sequence Flows**, it is possible that two (or more) **Sequence Flows** will merge before all the **Sequence Flows** that map to a WSBPEL structure element have merged. The sub-elements of a WSBPEL structured elements are also self-contained and there is no cross sub-element flow. For example, the *cases* of a *switch* cannot interact; that is, they cannot share activities. Thus, one **BPMN Activity** will need to appear in two (or more) WSBPEL structured elements. There are two possible mechanisms to deal with the situation:

- First, the activities are simply duplicated in all appropriate WSBPEL elements.
- Second, the activities that need to be duplicated can be removed from the main **Process** and placed in a derived process that is called (*invoked*) from all locations in the WSBPEL elements as needed.
 - The name of the derived process will be in the form of:
 - “[target]object.Name]_Derived_Process”

Figure 14.8 displays this issue with an example. In that example, two **Sequence Flows** merge into the “Include History of Transactions” **Task**. However, the Decision that precedes the **Task** has three alternatives. Thus, the Decision maps to a WSBPEL *switch* with three *cases*. The three *cases* are not closed until the “Include Standard Text” **Task**, downstream. This means that the “Include History of Transactions” **Task** will actually appear in two of the three *cases* of the *switch*.

Note – the use of a WSBPEL *flow* will be able to handle the behavior without duplicating activities, but a *flow* will not always be available for use in these situations, particularly if a WSBPEL *pick* is requested.

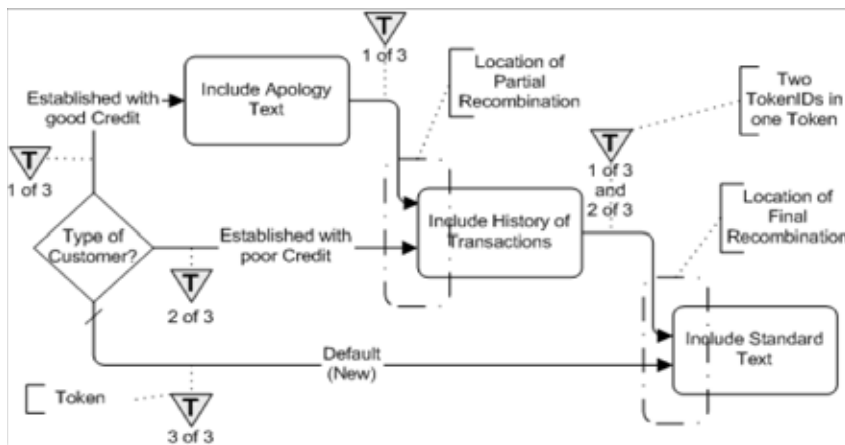

Figure 14.8 – An example: Activity that spans two paths of a WSBPEL structured element

15 Exchange Formats

15.1 Interchanging Incomplete Models

In practice, it is common for models to be interchanged before they are complete. This occurs frequently when doing iterative modeling, where one user (such as a subject matter expert or business person) first defines a high-level model, and then passes it on to another user to be completed and refined.

Such “incomplete” models are ones in which all of the mandatory attributes have not yet been filled in, or the cardinality lowerbound of attributes and associations has not been satisfied.

XMI allows for the interchange of such incomplete models. In **BPMN**, we extend this capability to interchange of XML files based on the **BPMN XSD**. In such XML files, implementers are expected to support this interchange by:

- Disregarding missing attributes that are marked as ‘required’ in the XSD.
- Reducing the lower bound of elements with ‘minOccurs’ greater than 0.

15.2 Machine Readable Files

BPMN 2.0.1 machine readable files, including XSD, XMI, and XSLT files can be found in OMG Document dtc/2010-05-04, which is a zip file containing all the files:

- XSD files are found under the XSD folder of the zip file, and the main file is XSD/BPMN20.xsd.
- XMI files are found under the XMI folder of the zip file, and the main file is XSD/BPMN20.cmof.
- XSLT files are found under the XSLT folder of the zip file.

15.3 XSD

15.3.1 Document Structure

A domain-specific set of model elements is interchanged in one or more **BPMN** files. The root element of each file **MUST** be <bpmn:definitions>. The set of files **MUST** be self-contained, i.e., all definitions that are used in a file **MUST** be imported directly or indirectly using the <bpmn:import> element.

Each file **MUST** declare a “targetNamespace” that **MAY** differ between multiple files of one model.

BPMN files **MAY** import non-**BPMN** files (such as XSDs and WSDLs) if the contained elements use external definitions.

Example:

main.bpmn

```
<?xml version="1.0" encoding="UTF-8"?>
<bpmn:definitions xmlns:bpmn="http://www.omg.org/spec/BPMN/20100524/MODEL"
  targetNamespace="sample1.main" xmlns:main="sample1.main" xmlns:s1="sample1.semantic1">
  <bpmn:import location="semantic1.bpmn" namespace="sample1.semantic1"
    importType="http://www.omg.org/spec/BPMN/20100524/MODEL" />
  <bpmn:import location="diagram1.bpmn" namespace="sample1.diagram1"
```

```

        importType="http://www.omg.org/spec/BPMN/20100524/MODEL" />
    <bpmn:collaboration>
        <bpmn:participant processRef="s1:process1" id="collaboration1"></bpmn:participant>
        <!--more content here -->
    </bpmn:collaboration>
</bpmn:definitions>

```

semantic1.bpmn

```

<?xml version="1.0" encoding="UTF-8"?>
<bpmn:definitions xmlns:bpmn="http://www.omg.org/spec/BPMN/20100524/MODEL"
    targetNamespace="sample1.semantic1"
    xmlns:s1="sample1.semantic1">
    <bpmn:process id="process1">
        <!-- content here -->
    </bpmn:process>
</bpmn:definitions>

```

diagram1.bpmn

```

<?xml version="1.0" encoding="UTF-8"?>
<bpmn:definitions xmlns:bpmn="http://www.omg.org/spec/BPMN/20100524/DI"
    targetNamespace="sample1.diagram1"
    xmlns:bpmndi="http://www.omg.org/spec/BPMNDI/1.0.0"
    xmlns:d1="sample1.diagram1" xmlns:s1="sample1.semantic1"
    xmlns:main="sample1.main">
    <bpmndi:BPMNDiagram scale="1.0" unit="Pixel">
        <bpmndi:BPMNPlane element="main:collaboration1">
            <!-- content here -->
        </bpmndi:BPMNPlane>
    </bpmndi:BPMNDiagram>
</bpmn:definitions>

```

15.3.2 References within the BPMN XSD

All **BPMN** elements contain IDs and within the **BPMN** XSD, references to elements are expressed via these IDs. The XSD IDREF type is the traditional mechanism for referencing by IDs, however it can only reference an element within the same file. The **BPMN** XSD supports referencing by ID, across files, by utilizing QNames. A QName consists of two parts: an optional namespace prefix and a local part. When used to reference a **BPMN** element, the local part is expected to be the ID of the element.

For example, consider the following **Process**

```
<process name="Patient Handling" id="Patient_Handling_Process_ID1"> ... </process>
```

When this **Process** is referenced from another file, the reference would take the following form:

```
processRef="process_ns:Patient_Handling_Process_ID1"
```

where “process_ns” is the namespace prefix associated with the process namespace upon import, and “Patient_Handling_Process_ID1” is the value of the id attribute for the **Process**.

The **BPMN** XSD utilizes IDREFs wherever possible and resorts to QName only when references can span files. In both situations however, the reference is still based on IDs.

15.4 XMI

XMI allows the use of tags to tailor the documents that are produced using XMI. The following tags have been explicitly set for serializing BPMN 2.0 models; the others are left at their default values:

- tag nsURI set to "http://www.omg.org/spec/BPMN/20100524/XMI"
- tag nsPrefix set to "bpmn"

The **BPMN 2.0 XMI** for the interchange of diagram information will be published once the OMG Diagram Definition RFP process has produced a specification that is sufficiently complete such that a future BPMN RFP/FTF/RTF can align the BPMN specification with the Diagram Definition specification.

15.5 XSLT Transformation between XSD and XMI

- The XSLT transformation from XSD to XMI is in the file XSLT/BPMN20-ToXMI.xslt
- The XSLT transformation from XMI to XSD is in the file XSLT/BPMN20-FromXMI.xslt

Annex A

Changes from v1.2

(informative)

A.1 Changes from BPMN, v1.2

There have been notational and technical changes to the BPMN International Standard.

The major notational changes include:

- The addition of a Choreography diagram
- The addition of a Conversation diagram
- Non-interrupting Events for a Process
- Event Sub-Processes for a Process

The major technical changes include:

- A formal metamodel as shown through the class diagram figures
- Interchange formats for abstract syntax model interchange in both XMI and XSD
- Interchange formats for diagram interchange in both XMI and XSD
- XSLT transformations between the XMI and XSD formats

Other technical changes include:

- Reference Tasks are removed. These provided reusability within a single diagram, as compared to GlobalTasks, which are reusable across multiple diagrams. GlobalTasks can be used instead of Reference Tasks, to simplify the language and implementations.

Annex B Diagram Interchange

(non-normative)

B.1 Scope

This annex provides documentation for a relevant subset of an alpha version of a Diagram Definition (DD) specification that is being referenced by this International Standard (in Clause 13 - BPMN DI). The (complete version of the) DD specification is still going through a separate submission/approval process and once finalized and adopted, a future revision of this specification may replace this annex by a reference to that adopted DD specification.

The Diagram Definition specification provides a basis for modeling and interchanging graphical notations, specifically node and edge style diagrams as found in BPMN, UML and SysML, for example, where the notations are tied to abstract language syntaxes defined with MOF. The specification addresses the requirements in the Diagram Definition RFP (ad/2007-09-02).

B.2 Architecture

The DD architecture distinguishes two kinds of graphical information, depending on whether language users have control over it. Graphics that users have control over, such as position of nodes and line routing points, are captured for interchange between tools. Graphics that users do not have control over, such as shape and line styles defined by language standards are not interchanged because they are the same in all diagrams conforming to the language. The DD architecture has two models to enable specification of these two kinds of graphical information, Diagram Interchange (DI) and Diagram Graphics (DG). (both models share common elements from a Diagram Common (DC) model). The DI and DG models are shown in Figure B.1 by bold outlined boxes on the left and right, respectively.

The DD architecture expects language specification to define mappings between interchanged and non-interchanged graphical information, but does not restrict how it is done. This is shown in Figure B.1 by a shaded box labeled “CS Mapping Specification” in the middle section. The DD specification gives examples of mappings in QVT, but does not define or recommend any particular mapping language. The overall architecture resembles typical model-view-controllers, which separate visual rendering from underlying models, and provide a way to keep visuals and models consistent.

The first few steps of using the DD architecture are:

1. An abstract language syntax is defined separately from DD by instantiating MOF (abstract syntaxes are sometimes called “metamodels”). This is shown in Figure B.1 by a shaded box labeled “AS” at the far middle left (the “M” levels in the figure are described in the UML 2 Infrastructure (formal/2009-02-04)).
2. Language users model their applications by instantiating elements of abstract syntax, usually through tooling for the language. This is shown in Figure B.1 by the dashed arrow on the far lower left linked to a box labeled “Model.”
3. Users typically see graphical depictions of their models in tools. This is shown in Figure B.1 by a box on the lower right labeled “Graphics.”

Users expect their graphics to appear again in other tools after models are interchanged. The DD architecture enables this in two parts, one for graphical information that is interchanged, and another for graphical information that is not. The interchanged information is captured in the next few steps:

4. The portion of graphics that users have control over is captured for interchange, such as node position and line routing points. This is shown in Figure B.1 by a box labeled “Diagram” on the lower left. This information is linked to user models (instances of abstract syntax), as shown by the arrow to the Model box.
5. User diagram interchange information is instantiated from a model defined along with the abstract syntax. This is shown in Figure B.1 by a shaded box labeled “AS DI” on the left. Elements of this model are linked to elements of abstract syntax, specifying which kinds of diagram interchange information depict which kinds of user model elements. Diagram interchange models would typically be defined by the same community that defines the abstract syntax, as part of the overall language specification.
6. Elements of language-specific diagram interchange models (AS DI) specialize elements of the Diagram Interchange (DI), which is a model provided by this specification for typically needed diagram interchange information, as node position and line routing points. This is shown in Figure B.1 by the bold box labeled “DI” on the left, with specialization shown with a hollow headed arrow (specialization here is MOF generalization and property subsetting and redefinition, or XSD subclassing, where DI has the general elements, and AS DI has the specific elements). DI elements cannot be instantiated to capture diagram interchange information by themselves, they are almost entirely abstract. This specification provides normative CMOF and XSD artifacts for DI.

The final part of using the DD architecture captures graphical information that is not interchanged:

7. Language specifications specify mappings from their diagram interchange models (instances of AS DI) to instances of Diagram Graphics (DG), which is a model provided by this specification for typically needed graphical information that is not interchanged, such as shape and line styles. This shown in Figure B.1 by the box labeled “DG” on the right, and by the box labeled “CS Mapping Specification” in the middle section. The arrow at the bottom of the middle section illustrates mappings being carried out according to the specification above it, producing a model of diagram visuals, or directly rendering the visuals on a display. Languages specifying this mapping reduce ambiguity and non uniformity in how their abstract syntax appears visually. The DG model is not expected to be specialized, enabling implementations to render instances of DG elements for all applications of the DD architecture. This specification provides normative CMOF and XSD artifacts for DG.

In the BPMN specification, the only realized part of the DD architecture so far is diagram interchange. Hence the only documentation provided by this annex is for the Diagram Interchange (DI) package, in addition to the relevant subset of Diagram Common (DC) package, which captures common data structure definitions. The documentation for the Diagram Graphics (DG) package is not provided here.

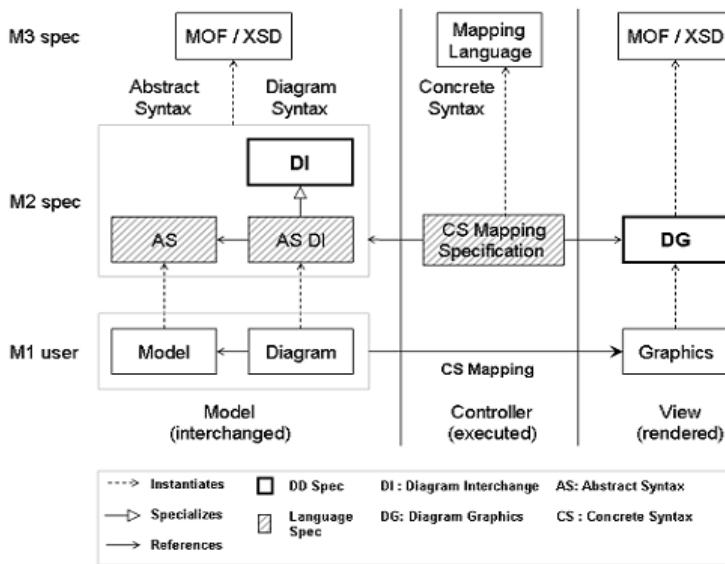

Figure B.1 – Diagram Definition Architecture

B.3 Diagram Common

The Diagram Common (DC) package contains abstractions shared by the Diagram Interchange and the Diagram Graphics packages.

B.3.1 Overview

The Diagram Common (DC) package contains a number of common primitive types as well as structured data types that are used in the definition of the Diagram Interchange (DG) package (see “Diagram Interchange” on page 487). The DC package itself does not depend on other packages. Some of the types defined in this package are defined based on similar ones in other related specifications including Cascading Style Sheets (CSS), Scalable Vector Graphics (SVG), and Office Document Format (ODF).

B.3.2 Abstract Syntax



Figure B.2 – The Primitive Types

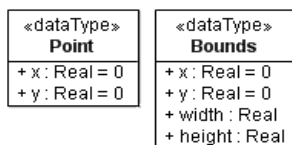

Figure B.3 – Diagram Definition Architecture

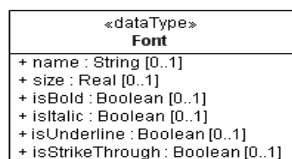

Figure B.4 – Diagram Definition Architecture

B.3.3 Classifier Descriptions

B.3.3.1 Boolean [PrimitiveType]

Boolean is a primitive data type having one of two values: true or false, intended to represent the truth value of logical expressions.

Description

Boolean is used as a type for typed elements that represent logical expressions. There are only two possible values for Boolean:

- true - The Boolean expression is satisfied.
- false - The Boolean expression is not satisfied.

Abstract Syntax

- Figure B.2 The primitive types

B.3.3.2 Bounds [PrimitiveType]

Bounds specifies an area in some (x, y) coordinate system that is enclosed by a bounded element's top-left point, its width, and its height.

Description

Bounds is used to specify the area of an element in some (x, y) coordinate system. The area is specified with a top-left point, representing the element's location (distance from the origin in logical units of length), in addition to the element's width and height (in logical units of length).

Abstract Syntax

- Figure B.3 (Layout Types)

Attributes

- + x : Real [1] = 0
a real number that represents the x-coordinate of the rectangle.
- + y : Real [1] = 0
a real number that represents the y-coordinate of the rectangle.
- + width : Real [1]
a real number that represents the width of the rectangle.
- + height : Real [1]
a real number that represents the height of the rectangle.

B.3.3.3 Font [PrimitiveType]

Font specifies the characteristics of a given font through a set of font properties.

Description

Font specifies a set of properties for a given font that is used when rendering text on a diagram

Abstract Syntax

- Figure B.4 The font type

Attributes

- + name : String [0..1]
the name of the font (e.g., “Times New Roman,” “Arial,” and “Helvetica”).
- + size : Real [0..1]
a non-negative real number representing the size of the font (expressed in the used unit of length).
- + isBold : Boolean [0..1]
whether the font has a **bold** style.
- + isItalic : Boolean [0..1]
whether the font has an *italic* style.
- + isUnderline : Boolean [0..1]
whether the font has an underline style.
- + isStrikeThrough : Boolean [0..1]
whether the font has a ~~strike through~~ style.

B.3.3.4 Integer [PrimitiveType]

Integer is a primitive data type used to represent the mathematical concept of integer.

Description

Integer is used as a type for typed elements whose values are in the infinite set of integer numbers.

Abstract Syntax

- Figure B.2 The primitive types

B.3.3.5 Point [DataType]

A Point specifies an location in some (x, y) coordinate system.

Description

Point is used to specify a location in logical unit of length from the origin of some (x, y) coordinate system. The point (0, 0) is considered to be at the origin of that coordinate system.

Abstract Syntax

- Figure B.3 The layout types

Attributes

- + x : Real [1] = 0
a real number that represents the x-coordinate of the point.
- + y : Real [1] = 0
a real number that represents the y-coordinate of the point.

B.3.3.6 Real [PrimitiveType]

Real is a primitive data type used to represent the mathematical concept of real.

Description

Real is used as a type for typed elements whose values are in the infinite set of real numbers. Note that integer values are also considered real values and as such can be assigned to real-typed elements.

Abstract Syntax

- Figure B.2 The primitive types

B.3.3.7 String [PrimitiveType]

String is a primitive data type used to represent a sequence of characters in some suitable character set. Character sets may include both ASCII and Unicode characters.

Description

String is used as a type for typed elements in the metamodel that have text values. The allowed values for String depend on the semantics of the text in each context. A string value is a sequence of characters surrounded by double quotes (").

Abstract Syntax

- Figure B.2 The primitive types

B.4 Diagram Interchange

The Diagram Interchange (DI) package contains a model enabling interchange of graphical information that language users have control over, such as position of nodes and line routing points. Language specifications specialize elements of DI to define diagram interchange for a language.

B.4.1 Overview

The Diagram Interchange (DI) package contains a number of types used in the definition of diagram interchange models. The package imports the Diagram Common package (see “Diagram Common” on page 483), as shown in Figure B.5, that contains various relevant data types. The DI package contains mainly abstract types that are to be properly extended and refined by concrete types in domain-specific DI packages. In this sense, the DI package plays the role of a framework that is meant for extension rather than a component that is ready to be used out of the box. The benefit of this design is capture common assumptions in the DI package in order to facilitate the integration between various graphical domains that define their DI packages as extensions.

Diagrams are generally considered depictions of part or all of the elements in a domain-specific model. Therefore, one of the best practices adopted in the design of the DI package and that can be subsumed by the extending domain-specific DI packages is to minimize any redundancy with the depicted model when possible. For example, the text representing the name of a UML class is not defined as part of the UML class shape. This is primarily achieved by the fact that diagram elements reference their counterparts in the domain model as their context model elements instead of duplicating data from them. This design has the side effect of coupling the diagram models with their corresponding domain models, which is generally a common practice by tools. However, the DI package does not enforce this best practice and domain-specific DI packages can decide to have some level of duplication to decouple the models.

Another best practice adopted by the DI package is to avoid defining any data that is not changeable by the user but is rather derivable from the diagram’s model context, like graphical rendering details. For example, the option to render a UML actor as a stick man or a as rectangle can be defined in a DI model as a boolean property to allow a user to choose between them. However, the definition of the actual line segments making up such shapes need not be interchanged in a DI model as it can be defined in the tool itself.

Other decisions that are left to the individual domain-specific DI packages include: whether to allow 1-n vs. m-n relationships between the domain elements and their referencing diagram elements, the formatting properties (styles) that affect the aesthetics of diagrams rather than their semantics that are allowed to be interchanged, and the degree of pragmatic redundancy that is allowed in the DI models to balance their footprint with the ease of their import/export.

B.4.2 Abstract Syntax

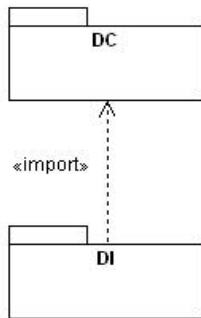

Figure B.5 – Dependencies of the DI package

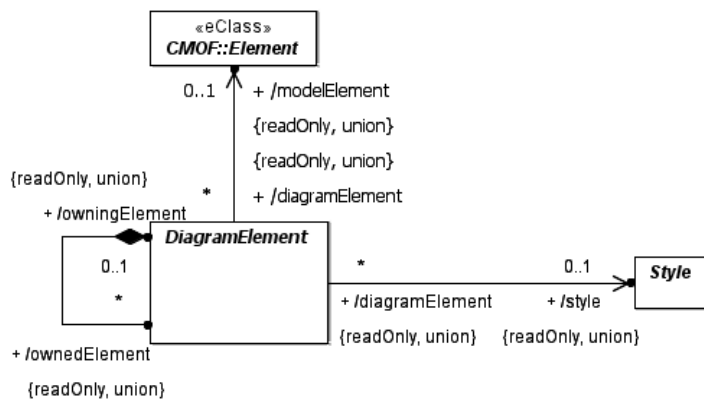

Figure B.6 – Diagram Element

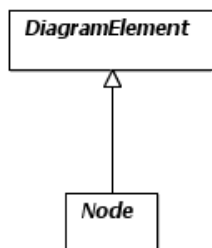

Figure B.7 – Node

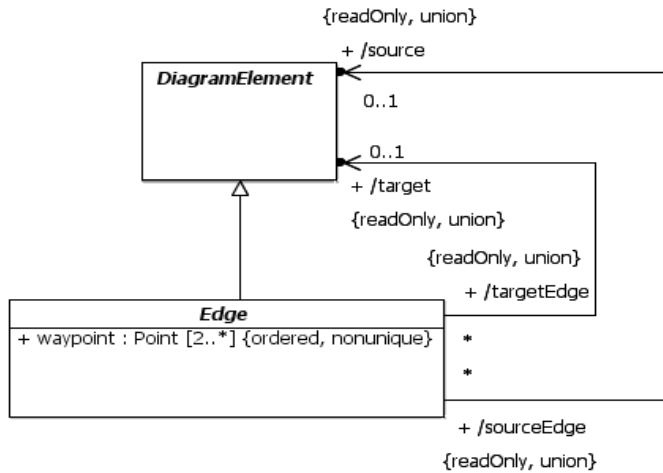

Figure B.8 – Edge

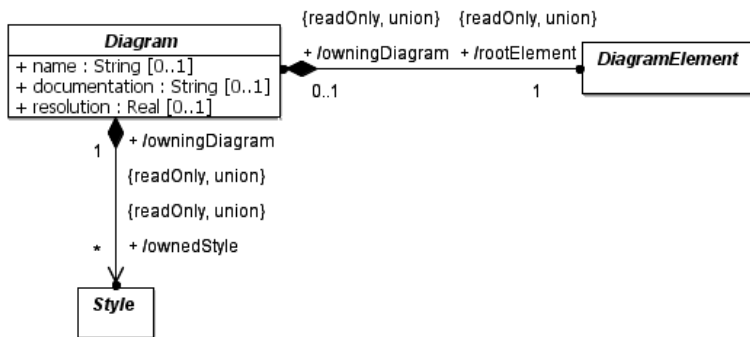

Figure B.9 – Diagram

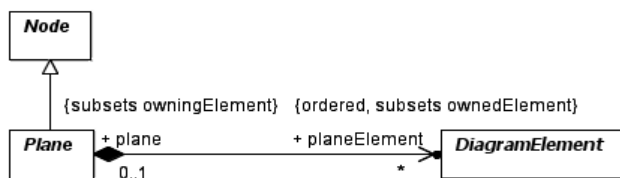

Figure B.10 – Plane

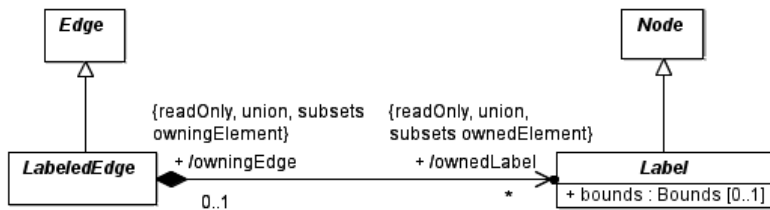

Figure B.11 – Labeled Edge

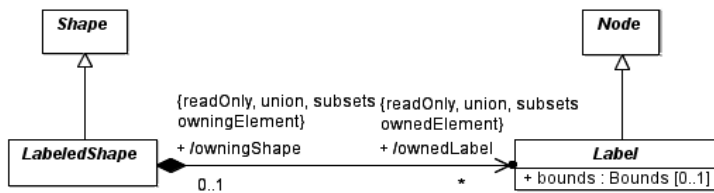

Figure B.12 – Labeled Shape

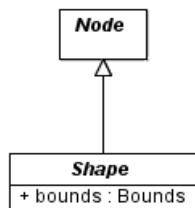

Figure B.13 – Shape

B.4.3 Classifier Descriptions

B.4.3.1 Diagram [Class]

Diagram is a container of a graph of diagram elements depicting all or part of a model.

Description

Diagram represents a depiction of all or part of a MOF model. A model can have one or more diagrams, each of which has a name and a description. A diagram contains the root of a graph of diagram elements that could reference various elements in a model. The root element is defined as a derived union, allowing domain-specific diagrams to specialize the root. All lengths specified by diagram elements are expressed in logical units of lengths. This unit of length would map to a unit of screen resolution (i.e., pixel) when rendering to the screen. To allow for predictable lengths when printing diagrams to paper, a diagram can also specify an intended printing resolution in Unit Per Inch (UPI). For example, a UPI of 300 means that a diagram element that is 300 unit wide would print as 1 inch wide on paper. A diagram can also own

a collection of styles that are referenced by its diagram elements. Styles contain unique combination of formatting properties used by different elements across the diagram. This allows for a large number of diagram elements to reference a small number of unique styles, which would dramatically reduce a diagram's footprint.

Abstract Syntax

- Figure B.9 Diagram

Attributes

- + name : String [0..1]
the name of the diagram.
- + documentation : String [0..1]
the documentation of the diagram.
- + resolution : Real [0..1]

the printing resolution of the diagram expressed in Unit Per Inch (UPI).

Associations

- ? + /rootElement : DiagramElement [1] {readOnly, union}
the root of containment for all diagram elements contained in the diagram.
- ? + /ownedStyle : Style [*] {readOnly, union}
the collection of styles owned by the diagram and referenced by its contained diagram elements.

B.4.3.2 DiagramElement [Class]

DiagramElement is the abstract supertype of all elements that can be nested in a diagram. It has two subtypes: Node and Edge.

Description

DiagramElement specifies an element that can be owned by a diagram and rendered to graphics. It is an abstract class that is further specialized by classes Node and Edge. A diagram element can either depict (reference) another context model element from an abstract syntax model (like UML or BPMN) or be purely notational (i.e., for enhancing the diagram understanding). In the case of depiction, data from both the diagram element and the model element are used for rendering. For example, the text of the name label of a UML class shape comes from the class, while the color of the label comes from the diagram element. A diagram element can reference a maximum of one model element, which can be any MOF-based element. The model element reference is a derived union and can be specialized in a domain-specific DI metamodel to be of a more concrete type.

Diagram elements can also own other diagram elements in a graph-like hierarchy. The collection of owned diagram elements is defined as a derived union. Domain-specific DI metamodels can specialize this collections to define what other diagram elements can be nested in a given diagram element.

Diagram elements can be specialized in a domain-specific DI metamodel to have domain-specific properties. Some of those properties augment the semantics of diagram elements and are therefore defined on the diagram elements. Other properties are considered formatting properties that influence the visual rendering of diagram elements but do not contribute to their semantics. Examples of such formatting properties include font, fill and stroke properties. Such properties tend to have similar values for diagram elements across the diagram and therefore to reduce the footprint of

diagrams, they are defined in Style elements that are owned by the diagram and referenced by individual diagram elements. For every unique combination of values for the style properties there would be a separate style element that is owned by the diagram. See “DiagramElement [Class]” on page 491 for more details.

There shall always be other properties that some tools wish to interchange that cannot be made normative. These can be interchanged using the extensibility mechanism that is native to the used interchange format (for example, an XSD schema following the XMI mapping would allow extraneous data to be placed on elements within <xmi:extension> tags, while a different XSD schema could allow this through xsd:any and xsd:anyAttribute elements placed in the definitions of extensible complex types).

Abstract Syntax

- Figure B.6 Diagram Element
- Figure B.7 Node
- Figure B.8 Edge
- Figure B.9 Diagram
- Figure B.10 Plane

Specializations

- Node
- Edge

Associations

- + /owningDiagram : Diagram [0..1] {readOnly, union}
a reference to the diagram that directly owns this diagram element. The reference is only set for the root element in a diagram.
- + /owningElement : DiagramElement [0..1] {readOnly, union}
a reference to the diagram element that directly owns this diagram element. The reference is set for all elements except the root element in a diagram.
- ? + /ownedElement : DiagramElement [*] {readOnly, union}
a collection of diagram elements that are owned by this diagram element.
- + /modelElement : Element [0..1] {readOnly, union}
a reference to a context model element, which can be any MOF-based element, for the diagram element.
- + /style : Style [0..1] {readOnly, union}
a reference to an optional style containing formatting properties for the diagram element.

B.4.3.3 Edge [Class]

Edge specifies a given edge in a graph of diagram elements. It represents a polyline connection between two graph elements: a source and a target.

Description

Edge represents a given connection between two elements in a diagram, a source element and a target element. An edge often references a relationship element (like a UML generalization or a BPMN message flow) as a context model element. It can also be purely notational, i.e., does not reference any model element. When referencing a relationship model element, the edge's source and target reference the relationship's source and target respectively as their model elements. If the edge's source and target can be derived unambiguously from other info (like the edge's model element or the edge's class type), they are not explicitly set on the edge to avoid redundancy, otherwise they need to be set. The source and target are defined as derived unions to allow domain-specific DI metamodels to specialize them appropriately.

An edge is often depicted as a line with 2 or more points (i.e., one or more connected line segments) in the coordinate system, called waypoints. The first point typically intersects with the edge's source, while the last point typically intersects with the edge's target. Any points in between establish a route for the line to traverse in the diagram.

Abstract Syntax

- Figure B.8 Edge
- Figure B.11 Labeled Edge

Generalizations

- DiagramElement

Specializations

- LabeledEdge

Attributes

- + waypoint : Point [2..*] {ordered, nonunique}

a list of two or more points relative to the origin of the coordinate system (e.g., the origin of a containing plane) that specifies the connected line segments of the edge.

2.4.3.3.0.1 Associations

- + /source : DiagramElement [0..1] {readOnly, union}

the edge's source diagram element, i.e., where the edge starts from. It is optional and needs to be set only if it cannot be unambiguously derived.

- + /target : DiagramElement [0..1] {readOnly, union}

the edge's target diagram element, i.e., where the edge ends at. It is optional and needs to be set only if it cannot be unambiguously derived.

B.4.3.4 Label [Class]

Label represents a node that is owned by another main diagram element in a plane and that depicts some (usually textual) aspect of that element within its own separate bounds.

Description

Label represents an owned node of another diagram element, typically a LabeledShape or a LabeledEdge. A label typically depicts some (usually textual) aspect of its owning element that needs to be laid out separately using the label's own bounds. The bounds are optional and if not specified, the label will be positioned in its default position.

A label's model element is typically not specified as it can be derived from its owning element. However, if the model element cannot be unambiguously derived, then a label could be given its own separate model element to disambiguate it.

Abstract Syntax

- Figure B.11 (Labeled Edge)
- Figure B.12 Labeled Shape

Generalizations

- Node

Attributes

- + bounds : Bounds [1]
the bounds (x, y, width and height) of the label relative to the origin of a containing plane.

B.4.3.5 LabeledEdge [Class]

LabeledEdge represents an edge that owns a collection of labels.

Description

LabeledEdge is an edge that owns a collection of labels (see “LabeledEdge [Class]” on page 494) that depict some aspects of it. An example is a UML association that has a number of labels (e.g., a name label, two role name labels and two multiplicity labels) positioned beside it. The existence of a label in this collection specifies that it is visible. The separate optional bounds of the label indicate where it should be positioned and if not specified the label can be positioned in its default position.

Abstract Syntax

- Figure B.11 Labeled Edge

Generalizations

- Edge

Associations

- ? + /ownedLabel : Label [*] {readOnly, union, subsets ownedNode}
the collection of labels owned by this edge.

B.4.3.6 LabeledShape [Class]

LabeledShape represents a shape that owns a collection of labels.

Description

LabeledShape is a shape that owns a collection of labels (see “LabeledShape [Class]” on page 494) that depict some aspects of it. An example is a UML port shape that is rendered as a filled box and has a name label positioned beside it. The existence of a label in this collection specifies that it is visible. The separate optional bounds of the label indicate where it should be positioned and if not specified the label can be positioned in its default position.

Abstract Syntax

- Figure B.12 Labeled Shape

Generalizations

- Shape

Associations

- ? + /ownedLabel : Label [*] {readOnly, union, subsets ownedNode}
the collection of labels owned by this shape.

B.4.3.7 Node [Class]

Node specifies a given node in a graph of diagram elements.

Description

Node represents a given node (or vertex) in a diagram, which is a graph of diagram elements. A node often references a non-relationship element (like a UML class or a BPMN activity) as a model element. It can also be purely notational, i.e., does not reference any model element.

The abstract node class does not have any particular layout characteristics. However, it may get specialized in a domain-specific DI metamodel to define nodes that have certain layout characteristics. Examples include planes with infinite bounds, shapes with limited bounds, tree items and graph vertices...etc.

Abstract Syntax

- Figure B.7 Node
- Figure B.10 Plane
- Figure B.11 Labeled Edge
- Figure B.12 Labeled Shape
- Figure B.13 Shape

Generalizations

- DiagramElement

Specializations

- Label
- Shape
- Plane

B.4.3.8 Plane [Class]

Plane is a node with an infinite bounds in the x-y coordinate system that owns a collection of shapes and edges that are laid out relative to its origin point.

Description

Plane has an origin point (0, 0) and an infinite size along the x and y axes. The coordinate system of the plane increases along the x-axis from left to right and along the y-axis from top to bottom. All the nested shapes and edges are laid out relative to their plane's origin.

A plane is often chosen as a root element for a two dimensional diagram that depicts an inter-connected graph of shapes and edges. A plane may have its own reference to a model element, in which case the whole plane is considered a depiction of that element. Alternatively, a plane without a reference to a model element is simply a layout container for its shapes and edges.

The collection of plane elements (shapes and edges) in a plane is ordered with the order specifying the z-order of these plane elements relative to each other. The higher the z-order, the more to the front (on top) the plane element is.

Abstract Syntax

- Figure B.10 Plane

Generalizations

- Node

Associations

- ? + planeElement : DiagramElement [*] {subsets ownedNode}

the ordered collection of diagram elements owned by this plane with the order defining the z-order of the diagram element.

B.4.3.9 Shape [Class]

Shape represents a node that has bounds that is relevant to the origin of a containing plane.

Description

Shape represents a node that is directly or indirectly owned by a plane (See “Shape [Class]” on page 496.) and that is laid out according to a given bounds that is relevant to the origin of the plane. A shape does not have any particular graphical rendering, i.e., the rendering is domain-specific.

A shape can be purely notational (i.e., does not reference any model element), like a block arrow pointing to a UML class shape with some textual message or an overlay rectangle with some transparent fill enclosing a bunch of shapes on the diagram to make them stand out. However, a shape often represents a depiction of a non-relational element from a business model (like UML class or BPMN activity) and hence references such an element as its model element.

Abstract Syntax

- Figure B.13 Shape
- Figure B.12 Labeled Shape

Generalizations

- Node

Specializations

- LabeledShape

Attributes

- + bounds : Bounds [1]

the bounds (x, y, width and height) of the shape relative to the origin of a containing plane.

B.4.3.10 Style [Class]

A style is a container for a collection of properties that affect the formatting of a set of diagram elements rather than their structure or semantics.

Description

A style represents a bag of properties that affect the appearance of a group of diagram elements. A style property (like font, fill, or stroke) is distinguishable from a property on a diagram element in that it is meant for the aesthetics of the element rather than being part of its intrinsic syntax.

A style tends to have only a few unique value combinations for its properties across the diagram. Such combinations are represented by different style instances owned by the diagram and referenced by the diagram elements. This allows for conserving the footprint of diagrams (over making style instances owned by diagram elements).

Style is defined as an abstract class without prescribing any style properties to leave it up to domain-specific DI metamodels to define concrete style classes that are applicable to their diagram element types.

Abstract Syntax

- Figure B.6 Diagram Element
- Figure B.9 Diagram

Annex C Glossary

(informative)

A

Activity	Work that a company or organization performs using business processes. An activity can be atomic or non-atomic (compound). The types of activities that are a part of a Process Model are: Process, Sub-Process, and Task.
Abstract Process	A Process that represents the interactions between a private business process and another process or participant.
Artifact	A graphical object that provides supporting information about the Process or elements within the Process. However, it does not directly affect the flow of the Process.
Association	A connecting object that is used to link information and Artifacts with Flow Objects. An association is represented as a dotted graphical line with an arrowhead to represent the direction of flow.
Atomic Activity	An activity not broken down to a finer level of Process Model detail. It is a leaf in the tree-structure hierarchy of Process activities. Graphically it will appear as a Task in BPMN.

B

Business Analyst	A specialist who analyzes business needs and problems, consults with users and stakeholders to identify opportunities for improving business return through information technology, and defines, manages, and monitors the requirements into business processes.
Business Process	A defined set of business activities that represent the steps required to achieve a business objective. It includes the flow and use of information and resources.
Business Process Management	The services and tools that support process management (for example, process analysis, definition, processing, monitoring and administration), including support for human and application-level interaction. BPM tools can eliminate manual processes and automate the routing of requests between departments and applications.
BPM System	The technology that enables BPM.

C

Choreography	An ordered sequence of B2B message exchanges between two or more Participants. In a Choreography there is no central controller, responsible entity, or observer of the Process.
Collaboration	Collaboration is the act of sending messages between any two Participants in a BPMN model. The two Participants represent two separate BPML processes.
Collapsed Sub-Process	A Sub-Process that hides its flow details. The Collapsed Sub-Process object uses a marker to distinguish it as a Sub-Process, rather than a Task. The marker is a small square with a plus sign (+) inside.

Compensation Flow	Flow that defines the set of activities that are performed while the transaction is being rolled back to compensate for activities that were performed during the Normal Flow of the Process. A Compensation Flow can also be called from a Compensate End or Intermediate Event.
Compound Activity	An activity that has detail that is defined as a flow of other activities. It is a branch (or trunk) in the tree-structure hierarchy of Process activities. Graphically, it will appear as a Process or Sub-Process in BPMN.
Controlled Flow	Flow that proceeds from one Flow Object to another, via a Sequence Flow link, but is subject to either conditions or dependencies from other flow as defined by a Gateway. Typically, this is seen as a Sequence flow between two activities, with a conditional indicator (mini-diamond) or a Sequence Flow connected to a Gateway.
D	
Decision	A gateway within a business process where the Sequence Flow can take one of several alternative paths. Also known as "Or-Split."
E	
End Event	An Event that indicates where a path in the process will end. In terms of Sequence Flows, the End Event ends the flow of the Process, and thus, will not have any outgoing Sequence Flows. An End Event can have a specific Result that will appear as a marker within the center of the End Event shape. End Event Results are Message, Error, Compensation, Signal, Link, and Multiple. The End Event shares the same basic shape of the Start Event and Intermediate Event, a circle, but is drawn with a thick single line.
Event Context	An Event Context is the set of activities that can be interrupted by an exception (Intermediate Event). This can be one activity or a group of activities in an expanded Sub-Process.
Exception	An event that occurs during the performance of the Process that causes a diversion from the Normal Flow of the Process. Exceptions can be generated by Intermediate Events, such as time, error, or message.
Exception Flow	A Sequence Flow path that originates from an Intermediate Event attached to the boundary of an activity. The Process does not traverse this path unless the Activity is interrupted by the triggering of a boundary Intermediate Event (an Exception - see above).
Expanded Sub-Process	A Sub-Process that exposes its flow detail within the context of its Parent Process. An Expanded Sub-Process is displayed as a rounded rectangle that is enlarged to display the Flow Objects within.
F	
Flow	A directional connector between elements in a Process, Collaboration, or Choreography. A Sequence Flows represents the sequence of Flow Objects in a Process or Choreography. A Message Flow represents the transmission of a Message between Collaboration Participants. The term Flow is often used to represent the overall progression of how a Process or Process segment would be performed.
Flow Object	A graphical object that can be connected to or from a Sequence Flow. In a Process, Flow Objects are Events, Activities, and Gateways. In a Choreography, Flow Objects are Events, Choreography Activities, and Gateways.

Fork A point in the Process where one Sequence Flow path is split into two or more paths that are run in parallel within the Process, allowing multiple activities to run simultaneously rather than sequentially. BPMN uses multiple outgoing Sequence Flows from Activities or Events or a Parallel Gateway to perform a Fork. Also known as “AND-Split.”

I

Intermediate Event An event that occurs after a Process has been started. An Intermediate Event affects the flow of the process by showing where messages and delays are expected, distributing the Normal Flow through exception handling, or showing the extra flow required for compensation. However, an Intermediate Event does not start or directly terminate a process. An Intermediate Event is displayed as a circle, drawn with a thin double line.

J

Join A point in the Process where two or more parallel Sequence Flow paths are combined into one Sequence Flow path. BPMN uses a Parallel Gateway to perform a Join. Also known as “AND-Join.”

L

Lane A partition that is used to organize and categorize activities within a Pool. A Lane extends the entire length of the Pool either vertically or horizontally. Lanes are often used for such things as internal roles (e.g., Manager, Associate), systems (e.g., an enterprise application), or an internal department (e.g., shipping, finance).

M

Merge A point in the Process where two or more alternative Sequence Flow paths are combined into one Sequence Flow path. No synchronization is required because no parallel activity runs at the join point. BPMN uses multiple incoming Sequence Flows for an Activity or an Exclusive Gateway to perform a Merge. Also known as “OR-Join.”

Message An Object that depicts the contents of a communication between two Participants. A message is transmitted through a Message Flow and has an identity that can be used for alternative branching of a Process through the Event-Based Exclusive Gateway.

Message Flow A Connecting Object that shows the flow of messages between two Participants. A Message Flow is represented by a dashed lined.

N

Normal Flow A flow that originates from a Start Event and continues through activities on alternative and parallel paths until reaching an End Event.

P

Parent Process A Process that holds a Sub-Process within its boundaries.

Participant A business entity (e.g., a company, company division, or a customer) or a business role (e.g., a buyer or a seller) that controls or is responsible for a business process. If Pools are used, then a Participant would be associated with one Pool. In a Collaboration, Participants are informally known as “Pools.”

Pool A Pool represents a Participant in a Collaboration. Graphically, a Pool is a container for partitioning a Process from other Pools/Participants. A Pool is not required to contain a Process, i.e., it can be a “black box.”

Private Business Process	A process that is internal to a specific organization and is the type of process that has been generally called a workflow or BPM process.
Process	A sequence or flow of Activities in an organization with the objective of carrying out work. In BPMN, a Process is depicted as a graph of Flow Elements, which are a set of Activities, Events, Gateways, and Sequence Flow that adhere to a finite execution semantics.
R	
Result	The consequence of reaching an End Event. Types of Results include Message, Error, Compensation, Signal, Link, and Multiple.
S	
Sequence Flow	A connecting object that shows the order in which activities are performed in a Process and is represented with a solid graphical line. Each Flow has only one source and only one target. A Sequence Flow can cross the boundaries between Lanes of a Pool but cannot cross the boundaries of a Pool.
Start Event	An Event that indicates where a particular Process starts. The Start Event starts the flow of the Process and does not have any incoming Sequence Flow, but can have a Trigger. The Start Event is displayed as a circle, drawn with a single thin line.
Sub-Process	A Process that is included within another Process. The Sub-Process can be in a collapsed view that hides its details. A Sub-Process can be in an expanded view that shows its details within the view of the Process that it is contained in. A Sub-Process shares the same shape as the Task, which is a rectangle that has rounded corners.
Swimlane	A Swimlane is a graphical container for partitioning a set of activities from other activities. BPMN has two different types of Swimlanes. See “Pool” and “Lane.”
T	
Task	An atomic activity that is included within a Process. A Task is used when the work in the Process is not broken down to a finer level of Process Model detail. Generally, an end-user, an application, or both will perform the Task. A Task object shares the same shape as the Sub-Process, which is a rectangle that has rounded corners.
Token	A theoretical concept that is used as an aid to define the behavior of a Process that is being performed. The behavior of Process elements can be defined by describing how they interact with a token as it “traverses” the structure of the Process. For example, a token will pass through an Exclusive Gateway, but continue down only one of the Gateway's outgoing Sequence Flow.
Transaction	A Sub-Process that represents a set of coordinated activities carried out by independent, loosely-coupled systems in accordance with a contractually defined business relationship. This coordination leads to an agreed, consistent, and verifiable outcome across all participants.
Trigger	A mechanism that detects an occurrence and can cause additional processing in response, such as the start of a business Process. Triggers are associated with Start Events and Intermediate Events and can be of the type: Message, Timer, Conditional, Signal, Link, and Multiple.
U	
Uncontrolled Flow	Flow that proceeds without dependencies or conditional expressions. Typically, an Uncontrolled Flow is a Sequence Flow between two Activities that do not have a conditional indicator (mini-diamond) or an intervening Gateway.