



Business Motivation Model

Version 1.2 Beta 2 Specification (convenience document with change bars)

OMG Document Number: dtc/2013-08-25
Standard document URL: <http://www.omg.org/spec/BMM/1.1/PDF>

USE OF SPECIFICATION - TERMS, CONDITIONS & NOTICES

The material in this document details an Object Management Group specification in accordance with the terms, conditions and notices set forth below. This document does not represent a commitment to implement any portion of this specification in any company's products. The information contained in this document is subject to change without notice.

LICENSES

The companies listed above have granted to the Object Management Group, Inc. (OMG) a nonexclusive, royalty-free, paid up, worldwide license to copy and distribute this document and to modify this document and distribute copies of the modified version. Each of the copyright holders listed above has agreed that no person shall be deemed to have infringed the copyright in the included material of any such copyright holder by reason of having used the specification set forth herein or having conformed any computer software to the specification.

Subject to all of the terms and conditions below, the owners of the copyright in this specification hereby grant you a fully-paid up, non-exclusive, nontransferable, perpetual, worldwide license (without the right to sublicense), to use this specification to create and distribute software and special purpose specifications that are based upon this specification, and to use, copy, and distribute this specification as provided under the Copyright Act; provided that: (1) both the copyright notice identified above and this permission notice appear on any copies of this specification; (2) the use of the specifications is for informational purposes and will not be copied or posted on any network computer or broadcast in any media and will not be otherwise resold or transferred for commercial purposes; and (3) no modifications are made to this specification. This limited permission automatically terminates without notice if you breach any of these terms or conditions. Upon termination, you will destroy immediately any copies of the specifications in your possession or control.

PATENTS

The attention of adopters is directed to the possibility that compliance with or adoption of OMG specifications may require use of an invention covered by patent rights. OMG shall not be responsible for identifying patents for which a license may be required by any OMG specification, or for conducting legal inquiries into the legal validity or scope of those patents that are brought to its attention. OMG specifications are prospective and advisory only. Prospective users are responsible for protecting themselves against liability for infringement of patents.

GENERAL USE RESTRICTIONS

Any unauthorized use of this specification may violate copyright laws, trademark laws, and communications regulations and statutes. This document contains information which is protected by copyright. All Rights Reserved. No part of this work covered by copyright herein may be reproduced or used in any form or by any means--graphic, electronic, or mechanical, including photocopying, recording, taping, or information storage and retrieval systems--without permission of the copyright owner.

DISCLAIMER OF WARRANTY

WHILE THIS PUBLICATION IS BELIEVED TO BE ACCURATE, IT IS PROVIDED "AS IS" AND MAY CONTAIN ERRORS OR MISPRINTS. THE OBJECT MANAGEMENT GROUP AND THE COMPANIES LISTED ABOVE MAKE NO WARRANTY OF ANY KIND, EXPRESS OR IMPLIED, WITH REGARD TO THIS PUBLICATION, INCLUDING BUT NOT LIMITED TO ANY WARRANTY OF TITLE OR OWNERSHIP, IMPLIED WARRANTY OF MERCHANTABILITY OR WARRANTY OF FITNESS FOR A PARTICULAR PURPOSE OR USE. IN NO EVENT SHALL THE OBJECT MANAGEMENT GROUP OR ANY OF THE COMPANIES LISTED ABOVE BE LIABLE FOR ERRORS CONTAINED HEREIN OR FOR DIRECT, INDIRECT, INCIDENTAL, SPECIAL, CONSEQUENTIAL, RELIANCE OR COVER DAMAGES, INCLUDING LOSS OF PROFITS, REVENUE, DATA OR USE, INCURRED BY ANY USER OR ANY THIRD PARTY IN CONNECTION WITH THE FURNISHING, PERFORMANCE, OR USE OF THIS MATERIAL, EVEN IF ADVISED OF THE POSSIBILITY OF SUCH DAMAGES.

The entire risk as to the quality and performance of software developed using this specification is borne by you. This disclaimer of warranty constitutes an essential part of the license granted to you to use this specification.

RESTRICTED RIGHTS LEGEND

Use, duplication or disclosure by the U.S. Government is subject to the restrictions set forth in subparagraph (c) (1) (ii) of The Rights in Technical Data and Computer Software Clause at DFARS 252.227-7013 or in subparagraph (c)(1) and (2) of the Commercial Computer Software - Restricted Rights clauses at 48 C.F.R. 52.227-19 or as specified in 48 C.F.R. 227-7202-2 of the DoD F.A.R. Supplement and its successors, or as specified in 48 C.F.R. 12.212 of the Federal Acquisition Regulations and its successors, as applicable. The specification copyright owners are as indicated above and may be contacted through the Object Management Group, 140 Kendrick Street, Needham, MA 02494, U.S.A.

TRADEMARKS

MDA®, Model Driven Architecture®, UML®, UML Cube logo®, OMG Logo®, CORBA® and XMI® are registered trademarks of the Object Management Group, Inc., and Object Management Group™, OMG™, Unified Modeling Language™, Model Driven Architecture Logo™, Model Driven Architecture Diagram™, CORBA logos™, XMI Logo™, CWM™, CWM Logo™, IIOP™, MOF™, OMG Interface Definition Language (IDL)™, and OMG Systems Modeling Language (OMG SysML)™ are trademarks of the Object Management Group. All other products or company names mentioned are used for identification purposes only, and may be trademarks of their respective owners.

COMPLIANCE

The copyright holders listed above acknowledge that the Object Management Group (acting itself or through its designees) is and shall at all times be the sole entity that may authorize developers, suppliers and sellers of computer software to use certification marks, trademarks or other special designations to indicate compliance with these materials.

Software developed under the terms of this license may claim compliance or conformance with this specification if and only if the software compliance is of a nature fully matching the applicable compliance points as stated in the specification. Software developed only partially matching the applicable compliance points may claim only that the software was based on this specification, but may not claim compliance or conformance with this specification. In the event that testing suites are implemented or approved by Object Management Group, Inc., software developed using this specification may claim compliance or conformance with the specification only if the software satisfactorily completes the testing suites.

OMG's Issue Reporting Procedure

All OMG specifications are subject to continuous review and improvement. As part of this process we encourage readers to report any ambiguities, inconsistencies, or inaccuracies they may find by completing the Issue Reporting Form listed on the main web page <http://www.omg.org>, under Documents, Report a Bug/Issue (<http://www.omg.org/technology/agreement.htm>).

Table of Contents

Preface	v
1 Scope	1
1.1 Introduction	1
1.2 What is the Business Motivation Model?	1
1.3 Other Elements of a Full Business Model	2
1.4 Business Rules in the Business Motivation Model	3
1.5 Methodologies and the Business Motivation Model	3
1.6 Beneficiaries of the Business Motivation Model	3
1.6.1 Developers of Business Plans	3
1.6.2 Business Modelers	4
1.6.3 Implementers of software tools and repositories	4
2 Conformance	4
3 Normative References	4
4 Terms and Definitions	5
5 Symbols	5
6 Additional Information	6
6.1 Changes to Adopted OMG Specifications	6
6.2 How to Read this Specification	6
6.3 Acknowledgements	6
7 The Business Motivation Model	9
7.1 Overview	9
7.2 Key Ideas in the Business Motivation Model	10
7.2.1 Business Perspective	16
7.2.2 Motivation	10
7.2.3 Reaction to Change	10
7.2.4 Separation of Concerns	11
7.2.5 Decomposition	11
7.2.6 Metrics	11
7.3 Overview of BMM Structure	12
7.3.1 End	12
7.3.2 Means	13
7.3.3 Course of Action	13
7.3.4 Directive	13
7.3.5 Influencers	14
7.3.6 Assessments	14

7.3.7 Externally-referenced Business Model Elements	14
7.3.8 Organization Unit	15
7.3.9 Business Process	15
7.3.10 Business Rule	16
7.3.11 Associations between Externally-referenced Concepts	16
7.3.12 Common Business Vocabulary	16
7.4 Processes Supported by the Business Motivation Model	16
7.5 Business Motivation Model Structure	17

8 The Core Elements of the Business Motivation Model .. 21

8.1 The End Concepts	21
8.1.1 Categories of End	21
8.1.2 Vision	21
8.1.3 Desired Result	22
8.1.4 Goal	23
8.1.5 Objective	24
8.1.6 Facts that Organize Ends	25
8.2 The Means Concepts	26
8.2.1 Categories of Means	26
8.2.2 Mission	27
8.2.3 Course of Action	28
8.2.4 Strategy	29
8.2.5 Tactic	30
8.2.6 Directive	31
8.2.7 Business Rule Enforcement Level	32
8.2.8 Directive as Regulation	32
8.2.9 Categories of Directive	34
8.2.10 Business Policy	35
8.2.11 Business Rule	36
8.2.12 Facts that Organize Means	37
8.3 Expressing Core Elements of the Business Motivation Model	38
8.4 Influencers and Assessments	38
8.4.1 Influencers on the Ends and Means	39
8.4.2 Categories of Influencer	39
8.4.3 Influencing Organization	43
8.4.4 Directive as Regulation	45
8.4.5 Assessing the Impact of Influencers on Ends and/or Means	45
8.4.6 Assessment	46
8.4.7 Potential Impact	49
8.4.8 EU-Rent Example: Reaction to Influencers	57
8.5 Placeholders	52
8.5.1 Organization Unit	52
8.5.2 Business Process	54
8.5.3 Asset and Liability	55

9 BMM Concepts Catalog 59

9.1 Concepts	59
9.2 Attributes	69
9.3 Additional Vocabulary	69

9.4 Mapping of SBVR Structured English fact types to UML	
Association Names	70
9.5 Mapping of SBVR Structured English Fact Types to UML Role Names	72
Annex A - BMM Diagram as Originally Published	75
Annex B - Metrics for the BMM	77
Annex C - Background for EU-Rent Examples	79
Annex D -The BMM in the Context of the Zachman	
Architecture Framework	81
Annex E - BMM History	85
Annex F - Related OMG Business Modeling Specifications	91
Annex G - Defaults for Categorization	96
Annex H - Bibliography	103

Preface

About the Object Management Group

OMG

Founded in 1989, the Object Management Group, Inc. (OMG) is an open membership, not-for-profit computer industry standards consortium that produces and maintains computer industry specifications for interoperable, portable and reusable enterprise applications in distributed, heterogeneous environments. Membership includes Information Technology vendors, end users, government agencies and academia.

OMG member companies write, adopt, and maintain its specifications following a mature, open process. OMG's specifications implement the Model Driven Architecture® (MDA®), maximizing ROI through a full-lifecycle approach to enterprise integration that covers multiple operating systems, programming languages, middleware and networking infrastructures, and software development environments. OMG's specifications include: UML® (Unified Modeling Language™); CORBA® (Common Object Request Broker Architecture); CWM™ (Common Warehouse Metamodel); and industry-specific standards for dozens of vertical markets.

More information on the OMG is available at <http://www.omg.org/>.

OMG Specifications

As noted, OMG specifications address middleware, modeling and vertical domain frameworks. A catalog of all OMG Specifications is available from the OMG website at:

http://www.omg.org/technology/documents/spec_catalog.htm

Specifications within the Catalog are organized by the following categories:

OMG Modeling Specifications

- UML
- MOF
- XMI
- CWM
- Profile specifications.

OMG Middleware Specifications

- CORBA/IIOP
- IDL/Language Mappings
- Specialized CORBA specifications
- CORBA Component Model (CCM).

Platform Specific Model and Interface Specifications

- CORBA services

- CORBA facilities
- OMG Domain specifications
- OMG Embedded Intelligence specifications
- OMG Security specifications.

All of OMG's formal specifications may be downloaded without charge from our website. (Products implementing OMG specifications are available from individual suppliers.) Copies of specifications, available in PostScript and PDF format, may be obtained from the Specifications Catalog cited above or by contacting the Object Management Group, Inc. (as of January 16, 2006) at:

OMG Headquarters
140 Kendrick Street
Building A, Suite 300
Needham, MA 02494
USA
Tel: +1-781-444-0404
Fax: +1-781-444-0320
Email: pubs@omg.org

Certain OMG specifications are also available as ISO standards. Please consult <http://www.iso.org>

Issues

The reader is encouraged to report any technical or editing issues/problems with this specification to <http://www.omg.org/technology/agreement.htm>.

1 Scope

1.1 Introduction

The Business Rules Group (BRG) developed the Business Motivation Model and published Version 1.0 on the BRG web site (www.businessrulesgroup.org) in November 2000. The latest version, version 1.3, was published in September 2007.

The Business Motivation Model provides a scheme or structure for developing, communicating, and managing business plans in an organized manner. Specifically, the Business Motivation Model does all of the following:

- It identifies factors that motivate the establishing of business plans.
- It identifies and defines the elements of business plans.
- It indicates how all these factors and elements inter-relate.

Among these elements are those that provide governance for and guidance to the business — Business Policies and Business Rules.

The structure of the BMM provides the basis for logical design of easily-constructed tools for storing, cross-referencing, and reporting the elements of business plans for business enterprises.

1.2 What is the Business Motivation Model?

The Business Motivation Model contains:

- A set of built-in concepts that define the elements of business plans. They are associated in a structure that is methodology-neutral; it will support a range of approaches for creating and maintaining a Business Motivation Model for an enterprise, and is particularly strong in support of processes that are driven by business change.
- Roles in the structure for three essential concepts: Business Process, Business Rule, and Organization Unit. They participate in associations within the Business Motivation Model, but also (it is assumed) in other associations outside its scope - as is the case in SBVR and BPMN, both adopted OMG specifications. OMG does not have a general specification for organization structure.. They are regarded as references to elements that will be defined and maintained outside an enterprise's Business Motivation Model.

The Business Motivation Model is simple. Its concepts have only basic attributes - identifier and text description. Most of its associations are unconstrained: optional and many-to-many.

Software tools that support the Business Motivation Model usually provide simple recording and reporting functionality, with some analysis capabilities (e.g., reporting of goals that are not quantified by objectives, business rules that are not derived from any business policy).

The Business Motivation Model is not:

- A specification for a business development management process or tool.
- A specification for a project definition or management process or tool.
- A specification for a full business model.

It could be included in such specifications, but that is beyond the scope of this one.

There are two major areas of the Business Motivation Model.

1. The first is the Ends and Means of business plans. Among the Ends are things the enterprise wishes to achieve — for example, Goals and Objectives. Among the Means are things the enterprise will employ to achieve those Ends — for example, Strategies, Tactics, Business Policies, and Business Rules.
2. The second is the Influencers that shape the elements of the business plans, and the Assessments made about the impacts of such Influencers on Ends and Means (i.e., Strengths, Weaknesses, Opportunities, and Threats).

The Ends, Means, and Influencers are related to each other in order to answer the following two fundamental questions:

1. **What is needed to achieve what the enterprise wishes to achieve?** This question is answered by laying out the particular elements of the business plans — in other words, the Means necessary to achieve the desired Ends.
2. **Why does each element of the business plan exist?** This question is answered by identifying the particular Ends that each of the Means serves, and the Influencers that underlie the choices made in this regard. This is what is meant by ‘motivation.’

All elements of the Business Motivation Model are developed from a business perspective. The basic idea is to develop a business model for the elements of the business plans **before** system design or technical development is begun. In this manner, the business plans can become the foundation for such activity, connecting system solutions firmly to their business intent.

1.3 Other Elements of a Full Business Model

The Business Motivation Model is not a full business model. For example, the elements of business plans do not prescribe in detail any of the following, each of which is an essential part of a full business model.

- **Business Processes:** business plans include Courses of Action – what the enterprise has to do to achieve its Ends – transformed into Business Processes that encompass activities, sequencing, dependencies, interactions, triggering by business events, etc. Business Process specification is outside the scope of business plans. However the Business Motivation Model does include a placeholder for Business Process, to provide for integration with emerging Business Process standards.
- **Workflows:** the basis of workflow is assignment of responsibilities for Business Processes to roles in the organization. Design of workflow is outside the scope of business plans. However, the business plans may include Strategies or Tactics that configure organization structure to achieve effective workflow.
- **Business Vocabulary:** also needed is full specification of the terms and facts needed to support the business. However, the business plans do provide a business basis for such development — namely, the concepts and vocabulary used in the elements of the business plans, particularly in its Business Rules.

Refer to Annex D for comments about additional elements of a full business model.

1.4 Business Rules in the Business Motivation Model

Business Rules play an important role in development of business plans. For example, they can serve the following purposes:

- Make business tactics sufficiently well developed to guide the actual performance of work.
- Provide fallback positions when some element of the business plans fails.

- Resolve conflicts when the Ends the business seeks are in conflict with one another.

Because of this key role — which is often make-or-break for the very success of business plans — developing the motivation for Business Rules from the business perspective is fundamentally important.

1.5 Methodologies and the Business Motivation Model

It is important to note that the Business Motivation Model is not in any sense a methodology. Indeed, it is entirely neutral with respect to methodology or particular approach, with only several general exceptions as follows:

- The requirements development process should be business-driven.
- Organized business plans should be a fundamental deliverable in any such process.
- Business Rules and Business Processes are key elements of such business plans.

One way to think of the Business Motivation Model is as a blueprint purposely designed to support a range of methodological approaches. Implementation of the Model would result in the elements of business plans being stored and related to other information about the enterprise, no matter what methodology was used for discovering and defining them.

In the design for any such implementation, each concept of the Business Motivation Model (i.e., each concept listed in the Concepts Catalog) should be assigned two attributes — ‘name’ and ‘description’ — to be included in the implementation. User enterprises and repository vendors could, of course, choose to include additional attributes.

1.6 Beneficiaries of the Business Motivation Model

Three types of people are expected to benefit from the Business Motivation Model.

1.6.1 Developers of Business Plans

The Business Motivation Model is a conceptual tool for engineering the business itself. It provides developers of business plans with:

- A set of concepts that acts as a check-list of factors to be considered
- A standard vocabulary
- A flexible model to support their development processes

They also use tools that implement the Business Motivation Model for storage and management of their business plans.

1.6.2 Business Modelers

 Modelers who develop detailed business models will, in the future, use standards and models based on MG specifications such as BPMN and SBVR

The Business Motivation Model will support them in two ways:

1. The content of their enterprise’s Business Motivation Model will help to guide and shape their more detailed models.
2. Eventually specifications such as BPMN and SBVR, together with the Business Motivation Model (or something

with similar scope) should be merged into a single business-oriented modeling architecture, and implemented in integrated tool suites. Until then, tools based on the Business Motivation Model could provide a straightforward way of relating business processes, business rules and organization units to each other, and to the desired results, courses of action and business policies that affect them.

1.6.3 Implementers of software tools and repositories

The Business Motivation Model provides the basis of a logical data design that has been implemented in the databases of tools that support the model.

Tool developers might also choose:

- To elaborate on the Business Motivation Model, with additional attributes, more-normalized entities, and more refined associations,
- To use the Business Motivation Model in specifications of tools that support models with broader scope than the Business Motivation Model.

Both of these are beyond the scope of this specification.

2 Conformance

Software that conforms with the specification will be able to import and export XMI documents that conform with the XMI rules applied to the normative metamodel contained in OMG document dtc/07-08-05.

3 Normative References

The following normative documents contain provisions which, through reference in this text, constitute provisions of this specification. For dated references, subsequent amendments to, or revisions of, any of these publications do not apply.

- Merriam-Webster Unabridged Dictionary [MWUD]
- Oxford Dictionary of English [ODE]
- Semantics of Business Vocabulary and Business Rules [SBVR]

4 Terms and Definitions

For the purposes of this specification, the terms and definitions given in the normative reference and the following apply.

enterprise

“a business or company” [Oxford Dictionary of English, definition 2]. An enterprise can be either for-profit or not-for-profit — similar concepts apply. Also, the 'enterprise' can be some subset of a larger enterprise; again, similar concepts should apply.

concept

“unit of knowledge created by a unique combination of characteristics” [SBVR, adopted from ISO 1087-1 (English)]

fact

“proposition that is taken as true” [SBVR]

fact type

“concept that is the meaning of a verb phrase that involves one or more noun concepts and whose instances are all actualities” [SBVR]. For example, the fact type “city is in country” involves the noun concepts “city” and “country” and some actualities are “Paris is in France,” “Geneva is in Switzerland,” “Melbourne is in Australia.” In a UML model, a fact type would typically be represented as an association.

necessity

“a modal property that qualifies an assertion of a whole proposition just when it is not considered possible that the proposition is false.” [SBVR]

noun concept

“concept that is the meaning of a noun or noun phrase” [SBVR]. For example, “city”, “country”, “person”, “car”, Paris, France. In a UML model, a noun concept would typically be represented as a class or an instance.

verb concept

Synonym for “fact type” [SBVR]

5 Symbols

BPDM Business Process Definition Metamodel - OMG specification

BPMN Business Process Model and Notation OMG Specification

BRG Business Rules Group (www.businessrulesgroup.org)

MWUD Merriam-Webster Unabridged Dictionary

NODE New Oxford Dictionary of English

ODE Oxford Dictionary of English (replacement for NODE)

SBVR Semantics of Business Vocabulary and Business Rules - OMG specification

6 Additional Information

6.1 Changes to Adopted OMG Specifications

This specification does not require changes to any OMG adopted specifications.

SBVR has adopted the definition of “Business Policy” from the BMM as published by the BRG, which is the basis of this specification. If this definition is revised in future versions, the impact on SBVR will need to be taken into account.

6.2 How to Read this Specification

The rest of this document contains the technical content of this specification. It is organized (as is the BRG-published version of the BMM) around the core concepts of the BMM - Ends, Means, and Influencers & Assessments.

Chapter 9 provides a complete concepts catalog, organized in alphabetic sequence of noun concepts.

The formal definitions are presented in SBVR Structured English. This is described in Annexes C and D of the SBVR specification. Note that, in the BMM, fact types are taken to be many-to-many associations with optional participation, unless constrained otherwise by “necessity” clauses.

Although the chapters are organized in a logical manner and can be read sequentially, this is a reference specification and is intended to support being read in a non-sequential manner. Cross-references are provided to facilitate browsing and search.

6.3 Acknowledgements

The following OMG member organizations submitted this specification:

- Adaptive Inc.
- Business Semantics Ltd.
- Business Rule Solutions LLC.
- Mega International

The following OMG member organizations supported this specification:

- Business Rules Group
- EDS
- Fair Isaac Corporation
- Hendryx and Associates
- KnowGravity Inc.
- Neumont University

The following were the voting members of the Finalization Task Force:

- Manfred Koethe, 88solutions
- Pete Rivett, Adaptive
- Ronald G Ross, Business Rule Solutions
- John Hall, Business Rules Group (chair)
- Donald Chapin, Business Semantics Ltd
- Duane Clarkson, Deere & Company
- Fred Cummins, EDS
- James Taylor, Fair, Isaac & Co.
- Allan Kolber, Inferware

- Markus Schacher, KnowGravity Inc.
- Antoine Lonjon, MEGA International
- Cory Casanave, Model Driven Solutions
- Ed Barkmeyer, NIST
- Tony Morgan, Neumont University
- Bobbin Teegarden, No Magic, Inc.
- John Pellant, Pegasystems
- Said Tabet, RuleML
- Paul Vincent, Tibco
- David Bridgeland, Unisys
- Andy Evans, Xactium

The BMM metamodel, and the views of it used as diagrams in this specification, were maintained in Artisan Studio.

7 The Business Motivation Model

7.1 Overview

Fundamental to the Business Motivation Model is the notion of ‘motivation:’ if an enterprise prescribes a certain approach for its business activity, it ought to be able to say ‘why;’ that is, what result(s) the approach is meant to achieve.

Sometimes it is difficult to uncover such motivation, especially in operations that have been going on for some time. All too often it turns out to be “...because we had to find a workaround for a system that didn’t do quite what was needed.” This may describe business work practice, information systems, or both.

A cornerstone of any work addressing motivation has to be the enterprise’s aspirations (its Vision) and its action plans for how to realize them (its Mission). Refinements were introduced — Vision into Goals and Objectives, and Mission into Strategies for approaching Goals, and Tactics for achieving Objectives. The general term *End* was adopted to refer broadly to any of the ‘aspiration’ concepts (Vision, Goal, Objective) and the term *Means* to refer generally to any of the ‘action plan’ concepts (Mission, Strategy, Tactic). This conjunction of Ends and Means — ‘being’ and ‘doing’ — provides the core concepts of the Model¹.

An enterprise, however, cannot operate on this Model alone — the business needs to take into account the numerous Influencers that can hinder or assist its operation. These Influencers provide Opportunities that would help the enterprise operate, as well as Threats that would thwart it. Influencers also represent Strengths from within that the enterprise could exploit, or Weaknesses that it should compensate for.

But is an Influencer inherently a Strength or Weakness — is it always a Threat or Opportunity? That determination comes from an Assessment of the impact of an Influencer on the stated Ends and Means — an Assessment such as is developed in SWOT² analysis. In this commonly-used technique, Internal Influencers (assessed to be Strengths and Weaknesses) and External Influencers (assessed to be Opportunities and Threats) are analyzed as a part of business plan development.

Once an Assessment has identified relevant Influencers in terms of their impact on Ends and Means, Directives (Business Policies and Business Rules) can be put in place to govern and guide the enterprise Courses of Action. Directives keep the enterprise on course and moving toward its Desired Results. Because of their integral role in guiding Courses of Action, Directives are included in the set of Means concepts.

Business Rules are noteworthy in that regard. Business Rules sharpen the Business Tactics because they make Courses of Action concrete at the operational level. Business Rules can also provide specific remedies when a Course of Action fails, and specific resolutions to conflicts that inevitably arise among the Ends. In short, Business Rules provide the leverage needed for building effective, adaptable business solutions and systems.

Understanding the motivation for Business Rules is crucial in that regard.

- When a Business Rule is encountered, you can ask where it would fit — which Influencer, on which End or Means, does it address?

1. In fact, this is the essential distinction between Ends (the ‘being’ — “what you aspire to be”) and Means (the ‘doing’ — “the actions you intend to take to get there”). This distinction is expressed in the terms ‘Desired Result’ and ‘Course of Action’.

2. Note that SWOT is an example of a well-established technique: other techniques (and specializations of Assessment) may be substituted – but they should be adequate replacements for SWOT.

- When a Business Rule does not seem to fit, it can be challenged. Does it perhaps support some older Means or End that is no longer relevant to the enterprise? Was it a workaround for some historical information system deficiency or organizational issue that is no longer relevant?

7.2 Key Ideas in the Business Motivation Model

7.2.1 Business Perspective

All elements of an enterprise Business Motivation Model are developed from a business perspective. The idea is to develop a business model for the elements of the business plans before beginning system design or technical development, or even detailed business modeling. The business plans then become the foundation for such activity, connecting system solutions firmly to their business intent.

7.2.2 Motivation

Enterprises do not - or should not - act randomly. When an enterprise executes a business process or applies a business rule, it should be able to say why.

Business processes realize courses of action. Courses of action are undertaken to ensure that the enterprise makes progress towards one or more of its goals (which might include “to stay where we are, relative to our market and competitors”). Goals are defined because people in authority in the enterprise:

- assess the effect of some influences on the enterprise,
- decide what the goals should be.

Some of the logic of business processes may be expressed in business rules. Business rules are derived from business policies. Business policies are defined because people in authority in the enterprise:

- assess the effect of some influences on the enterprise,
- decide what the policies should be.

Since much of the motivation for what an enterprise does is based on people in the enterprise deciding what is best for it, the enterprise should be able to say who decided, and on what assessments of what influences. And when.

In practice, real businesses do not have complete traceability of motivation. But, as and when they choose to move towards it, the Business Motivation Model will support it.

7.2.3 Reaction to Change

A fundamental assumption of the Business Motivation Model is that what an enterprise does is driven not by change, but by how the enterprise decides to react to change. The recognition of changes caused by influencers (or, sometimes, no change when change was anticipated) and the assessment of their impact on the enterprise is crucial.

The Business Motivation Model does not require a specific process for reaction to change. Whatever process is used, the model supports traceability:

- Forward, from impact of influence to specification of business processes, business rules, and organization responsibilities.

- Backward, for an enterprise to demonstrate why it does what it does the way it does it.

Both are important for governance, and especially for regulatory compliance.

7.2.4 Separation of Concerns

Substantial effort went into making the concepts in the Business Motivation Model as simple as possible. One effect of this is separation of concerns - the distinctions between:

- Ends and means - what an enterprise wants to be, as opposed to what it has decided to do. Means can be changed without changing the ends; vice versa is, perhaps, not so common.
- Changes caused by influencers and assessment of their impact. The impact of a given change may be assessed differently by different people in the enterprise.
- Assessments, and the decisions based on them as expressed in business policies and ends.
- Courses of action (decisions on how to exploit resources and capabilities) and business policies (directives that enable and constrain courses of action).
- “How” and “How well.” Courses of action define how capabilities will be used; measures of how well they are used are defined within objectives they support. Objectives can be changed without changing courses of action.

7.2.5 Decomposition

The Business Motivation Model is applicable to any enterprise large enough to need to define and manage business plans. This can mean that different organization units in the same enterprise each have their own Business Motivation Models, which may include elements refined from corresponding elements owned by higher-level organization units.

There are three decomposition (includes/included in) associations in the Business Motivation Model, on:

- Desired Result
- Course of Action: there is also a separate relationship, ‘enabled by’
- Business Policy

Keeping these decompositions in step is left as a matter for methodology and tools.

In practice, organization boundaries have usually been determined by organization structure³. Decomposition of desired results, courses of action, and business policies have been guided by this.

7.2.6 Metrics

Measures of performance are defined in an enterprise’s Business Motivation Model as objectives. They may be based on risks and potential rewards identified in assessments.

Key Performance Indicators (KPI) / Critical Success Factors (CSF) are not especially distinguished in the model; enterprises can make the distinction if they choose to.

3. There has been some limited experience of decomposition by collaborative groups and shared-practice groups, but most has been by organization structure.

7.3 Overview of BMM Structure

Figure 7.1 provides an overview of the Business Motivation Model.

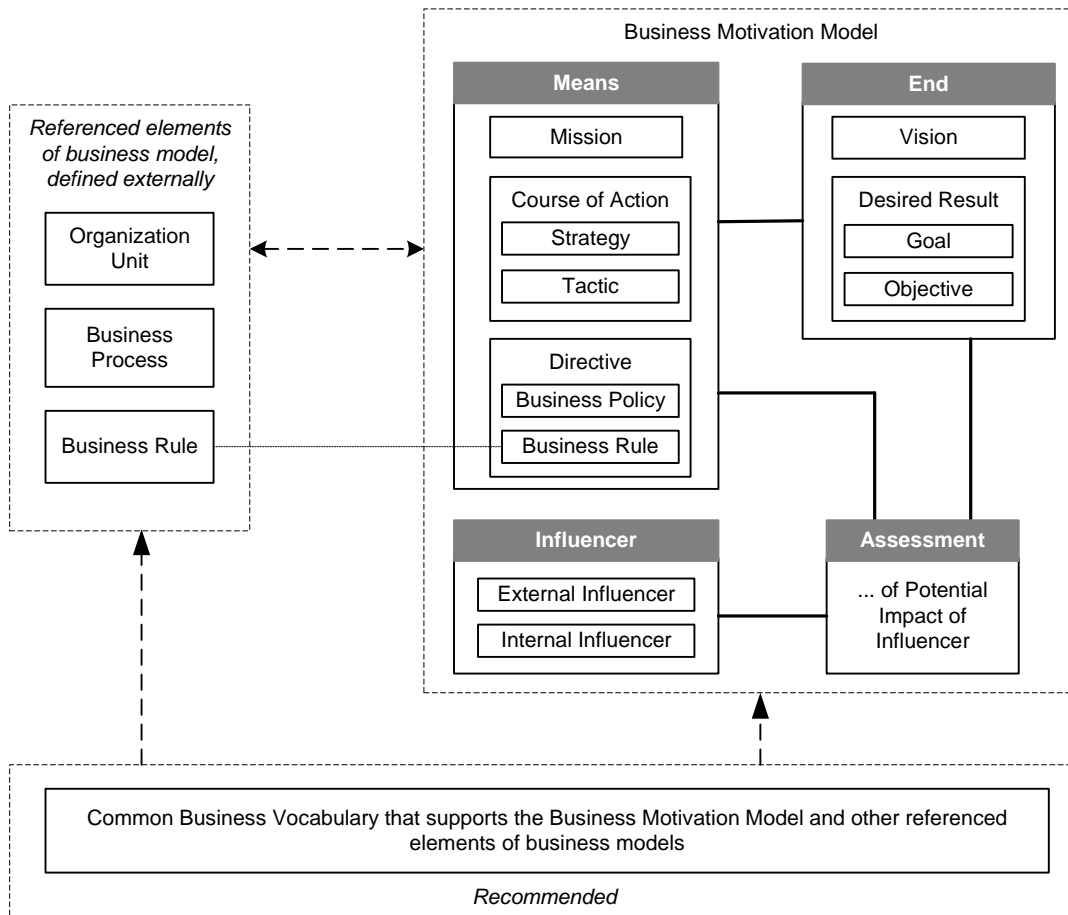

Figure 7.1 - BMM Overview

7.3.1 End

Ends are about what an enterprise wants to be.

Ends can be about changing what the enterprise is (e.g., developing new lines of business, moving into new markets) or about maintaining its current position relative its market and competition. The definition of an end does not say how it will be achieved.

In the Business Motivation Model, Ends are categorized as Vision and Desired Results, and Desired Results as Goals and Objectives.

A Vision is an overall image of what the organization wants to be or become. An enterprise can use the Business Motivation Model without defining a Vision explicitly.

Desired Results - Goals and Objectives - are more specific.

A Goal tends to be longer term, and defined qualitatively rather than quantitatively. It should be narrow - focused enough that Objectives can be defined for it.

An Objective is a step along the way towards a Goal. It must have an end date, and criteria to determine whether it has been reached or not. Objectives provide the basis for measuring whether progress is being made towards Goals.

7.3.2 Means

Means are about what an enterprise has decided to do in order to become what it wants to be.

A Means is some “device, capability, regime, technique, restriction, agency, instrument, or method that may be called upon, activated, or enforced to achieve Ends.” It does not include either the tasks (business processes and workflow) necessary to exploit it, nor responsibility for such tasks.

In the Business Motivation Model, Means are organized into Mission, Courses of Action, and Directives.

A Mission indicates the ongoing operational activity of the enterprise. Its definition should be broad enough to cover all Strategies and the complete area of operations. An enterprise can use the Business Motivation Model without defining a Mission explicitly.

7.3.3 Course of Action

Courses of Action are what the enterprise has decided to do. A Course of Action is more than simply a resource, skill, or competency that the enterprise can call upon. It is a way of configuring some aspect of the enterprise (things, processes, locations, people, time) to channel efforts towards Desired Results - the result of a decision by the enterprise about the best way to use its resources, skills, and competencies.

A Course of Action defines what has to be done, not how well it has to be done. Measures of performance are defined in Objectives that are supported by the Courses of Action.

In the Business Motivation Model, Courses of Action are categorized as Strategies and Tactics. The model does not make a hard distinction between the two. Enterprises define their own criteria.

Strategies tend to be long term and fairly broad in scope. Each Strategy is implemented by Tactics, which tend to be shorter term and narrower in scope. A Tactic may contribute to the implementation of more than one Strategy.

There is a de-facto correspondence between Course of Action and Desired Results. Generally, Strategies are selected to move the enterprise towards its goals, and Tactics to ensure that it meets its Objectives. But this is not hard-wired into the model; enterprises can make the correspondences they need.

Courses of Action do not necessarily have to support Desired Results directly; some are selected to enable other Courses of Action.

7.3.4 Directive

In the Business Motivation Model, Directives are categorized as Business Policies and Business Rules.

In general, Business Policies exist to govern – that is, control, guide, and shape – the Strategies and Tactics. They define what can be done and what must not be done, and may indicate how or set limits on how it should be done.

Compared to a Business Rule, a Business Policy tends to be less formally-structured; it may not be atomic (i.e., not focused on a single aspect of governance or guidance) and may be less formally articulated.



Business policies are not directly practicable. Practicable Directives are Business Rules, and they need to be defined as such, and managed for consistency and completeness. Business Rules are derived from Business Policies.

Apart from its role in the structure, 'Business Rule' is outside the scope of the Business Motivation Model. Its place in the structure provides a "hook" to another model, where 'Business Rule' is defined and associated with other concepts. This is discussed further in "Externally-referenced Business Model Elements," below.

7.3.5 Influencers

An Influencer is something that can cause changes that affect the enterprise in its employment of its Means or achievement of its Ends. Alternatively, it might confirm that there are no changes where changes might have been expected.

Influencers may be Internal (from within the enterprise) or External (from outside the enterprise boundary). If the enterprise being modeled is an Organization Unit within a larger organization, it may choose to treat the larger organization as an External Influencer.

The Business Motivation Model provides an example set of categories of Influencer. In practice, enterprises define their own set.

7.3.6 Assessments

An influence - a change caused by an Influencer - is neutral. It is more or less simply just 'there' until the enterprise decides how to react to it. An Assessment is a judgment about the influence on the enterprise's ability to employ its Means or achieve its Ends. The decisions are reflected in changes to the Ends and/or Means.

Different people might make different Assessments of a given influence on the same Ends and Means, perhaps even the same people at different points in time. The model supports a record of which people made which Assessments and when, providing an audit trail for future reference.

The Business Motivation Model suggests SWOT (Strength, Weakness, Opportunity, Threat) as an example of an approach for making assessments. In practice, enterprises can substitute different approaches.

The model also includes Potential Impacts that can be identified to support Assessments. Potential Impacts are categorized as Risk and Potential Reward.

As well as more general associations between Assessment, Ends and Means, there is a direct association "Directive is motivated by Potential Impact." This is one of the minor enhancements in version 1.1 of the Business Motivation Model, based on experience of using the model in risk management.

7.3.7 Externally-referenced Business Model Elements

Three concepts: Organization Unit, Business Process, and Business Rule have roles in the structure of the Business Motivation Model but actually belong in other standards where they are defined and associated with related concepts needed for detailed business modeling.



The BRG anticipated that the best sources for the required external standards would be OMG specifications, such as Business Process Model and Notation (BPMN), Semantics of Business Vocabulary and Business Rules (SBVR), and the organization structure models used by BMM user enterprises

7.3.8 Organization Unit

Organization Unit has two roles:

- It is a concept in the Business Motivation Model, participating in the following associations:
 - defines Ends,
 - establishes Means,
 - makes Assessments,
 - recognizes Influencers,
 - may be defined by a Strategy,
 - may be responsible for Business Processes.

 The BPMN concept 'performer', which can be a specific individual, a group, an organization role or position, or an organization, is the BMM concept of an organization unit in the roles of being responsible for activities in an organization

- It is usually the basis for defining the boundaries of the enterprise being modeled. The decomposition of Business Policies, Courses of Action, and Desired Results and assignment of responsibilities within the enterprise is often guided by (or, at least, consistent with) the definition of units within the organization structure.

 One way in which the model supports this is that a Directive (a Business Policy or Business Rule) at one level can act in the role of a Regulation for units lower down the organization structure. Business Process

Business Processes realize Courses of Action. They provide processing steps, sequences, (including cycles branches and synchronization), structure (decomposition and reuse), interactions, and connection to events that trigger the processes.

Courses of Action are governed by Business Policies; Business Processes are also governed by Business Policies.

'Business Process' participates in the following associations:

- realizes Courses of Action,
- is governed by Business Policies,
- may be guided by Business Rules,
- is the responsibility of one or more Organization Units.

'Business Process' is a draft definition, taken from the August 2004 draft of BDPM and anticipating a definition to be adopted from BDPM when it is further developed.

7.3.9 Business Rule

 Business Rules provide specific, practicable guidance to implement Business Policies. Some Business Rules could be automated in software; some are practicable only by people.

- 'Business Rule' participates in the following associations:
 - is derived from Business Policy,
 - may guide Business Processes,
 - may have an enforcement level effected by a Tactic.

‘Business Rule’ is adopted from SBVR.

7.3.10 Associations between Externally-referenced Concepts

The Business Motivation Model includes associations between externally-referenced concepts: ‘Organization Unit is responsible for Business Process’ and ‘Business Process is guided by Business Rule.’

These are loosely defined. It is recognized, for example, that there can be several kinds of responsibility for a business process (e.g., definition, execution, compliance). In practice, categories of responsibility can be defined as needed.

However, when the OMG specifications for BPMN, SBVR, and OSM are eventually integrated, they will, presumably, contain specific associations between Business Process, Business Rule, and Organization Unit. In that case, the loose associations in the Business Motivation Model might not be needed, except perhaps as a short-term measure when an enterprise Business Motivation Model is being developed.

7.3.11 Common Business Vocabulary

In practice, it is helpful if an enterprise uses a common vocabulary for its Business Motivation Model, its business processes and business rules, and its allocation of responsibilities.

However, this is not essential for use of use of the Business Motivation Model, and is outside the scope of this specification.

7.4 Processes Supported by the Business Motivation Model

The Business Motivation Model is neutral with respect to methodology. One way to think of it is as a blueprint that will support a range of methodological approaches. Implementation of the model would result in a repository in which the elements of business plans could be stored, connected, and related to other information about the enterprise, no matter what methodology was used for discovering and defining them.

There are some general assumptions:

- Creation and population of an enterprise’s Business Motivation Model should be business-driven.
- Organized business plans should be a fundamental deliverable.
- Business rules, business processes, and organizational responsibilities are needed to realize the plans, and it is valuable to trace them back to the relevant elements of the plans.

One example of a methodological approach is an implied progression through the model for an enterprise, illustrated below. The boxes represent ongoing activities, and the arrows indicate logical dependencies. An arrow drawn from ‘A’ to ‘B’ means: “If you are doing ‘B,’ you also need to be doing ‘A.’” How the activities are undertaken will vary from methodology to methodology.

This progression forms the basis of an end-to-end process for dealing with change, from recognition of influence to implemented response.

The progression can be fully traced in the Assessments, Ends, and Means stored in the Business Motivation Model for the enterprise, and the connections to Business Processes, Business Rules, and Organization Responsibilities stored in the related business models for the enterprise. The traceability is reversible, so that an enterprise can show why it has the processes and rules it has.

These capabilities are important for governance, and essential for Regulatory Compliance.

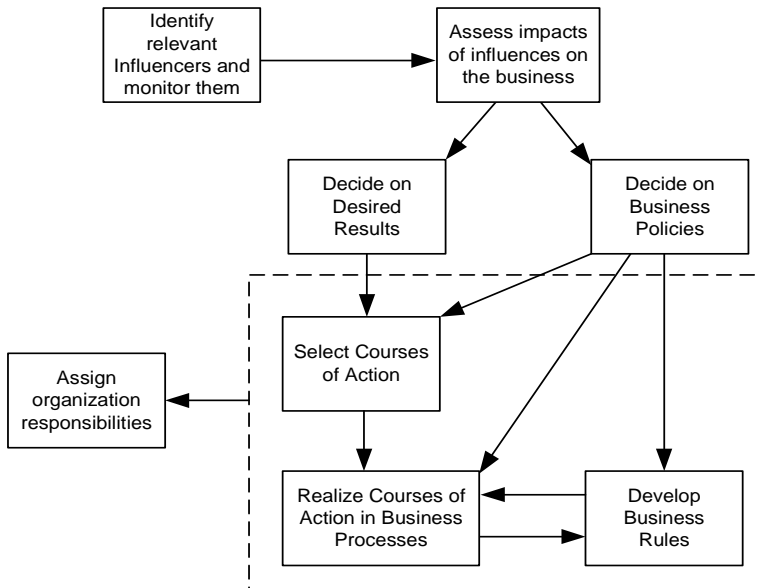

Figure 7.2 - Logical progression through the Business Motivation Model

This implied progression would support processes for three typical business scenarios for using the Business Motivation Model:

- “Stay where we are”: the enterprise reacts to change in its environment, e.g., Regulation and Competition, (rather than seeking to change its business) and undertakes defensive activity to maintain its current position relative to its market and competitors.
- Expand/Diversify: the enterprise retains its business model substantially unchanged, and adds Ends and Courses of Action to introduce new products/services and/or operate in new territories.
- New business: the enterprise will need a ‘starter’ model. Industry reference models (e.g., eTOM, for the telecommunications industry, from the Telemanagement Forum) may provide a good basis.

7.5 Business Motivation Model Structure

The two figures following provide an overview of the Business Motivation Model:

- Figure 7.3 “BMM Core Concepts” shows the concepts that are defined within the Business Motivation Model.
- Figure 7.4 “BMM Placeholders” shows five concepts - Business Process, Business Rule, Organization Unit, Asset, and Liability - that are referenced by the BMM but defined in detail in other specifications, and their associations with BMM core concepts.

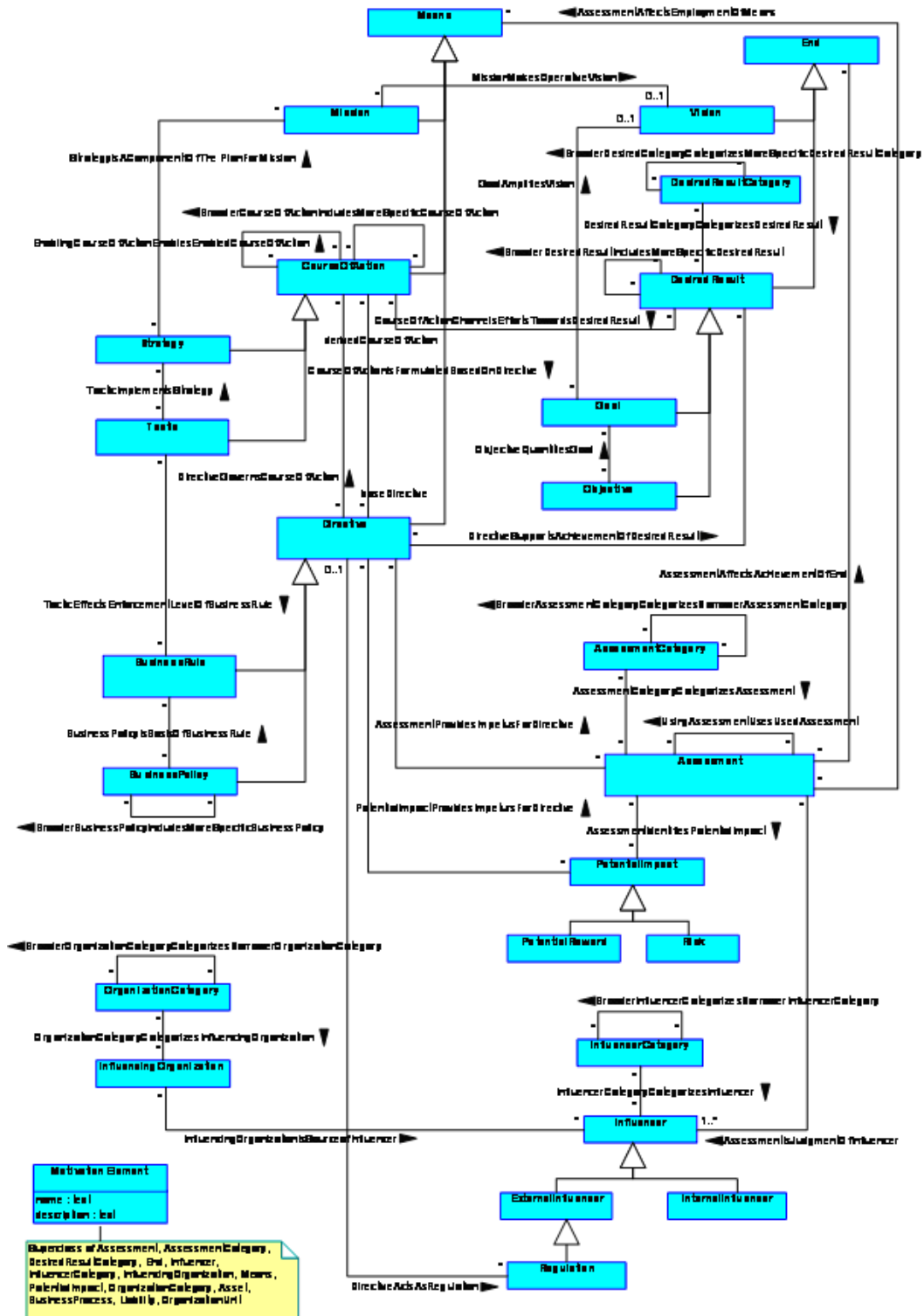

Figure 7.3 BMM Core Concepts

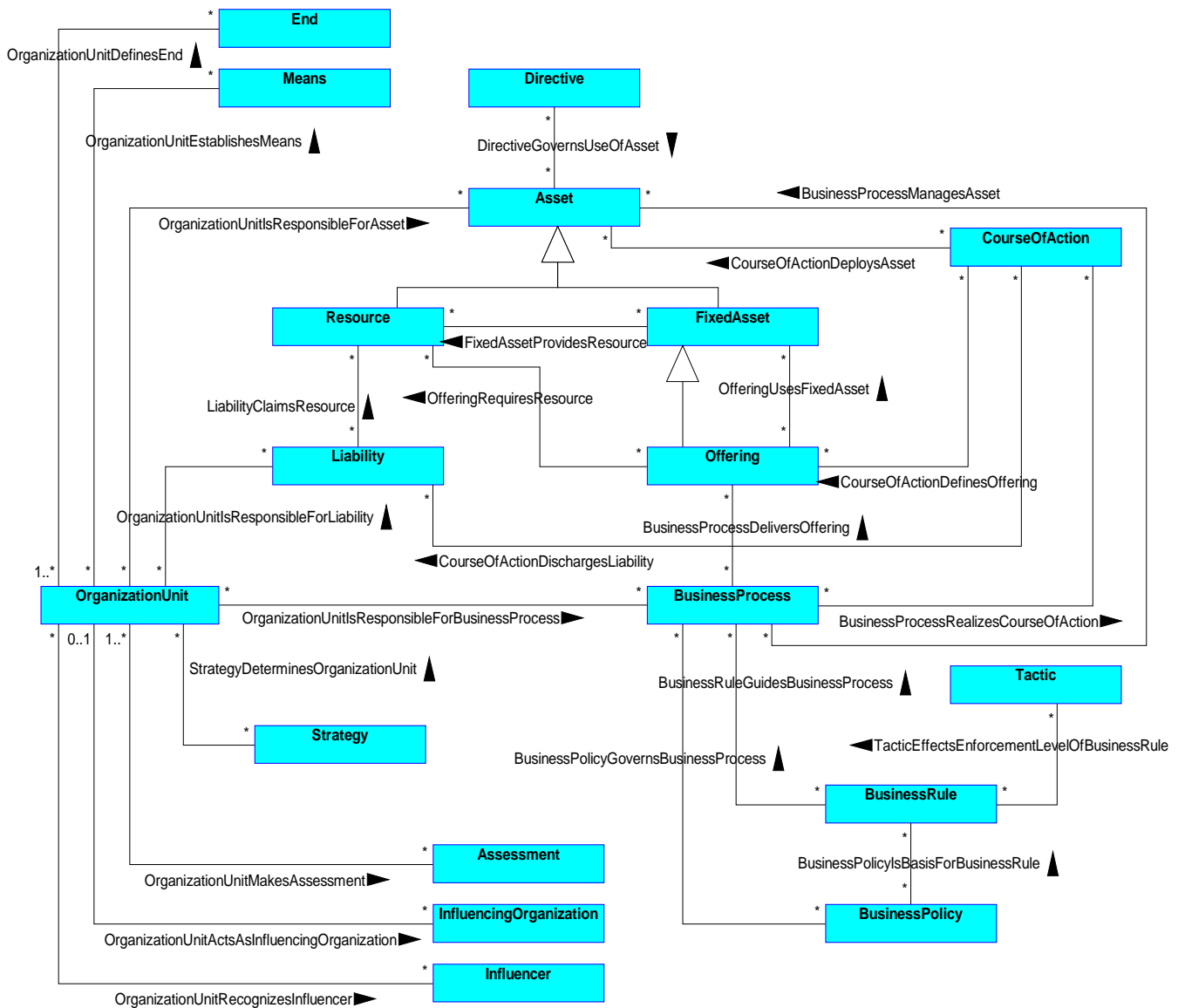

Figure 7.4 BMM Placeholders

8 The Core Elements of the Business Motivation Model

The main elements of the business plans are its Ends and Means. These fundamental terms represent two hierarchies, as shown in Figure 8.1 and Figure 8.5.

8.1 The End Concepts

An End is something the business seeks to accomplish. The important thing to remember about an End is that it does not include any indication of **how** it will be achieved.

In describing Ends, it is useful to document who *defined* the End and at what point in time, so that an audit trail exists for future reference. This, of course, cannot always be mandated.

8.1.1 Categories of End

End concepts can be arranged in a hierarchy, as shown in Figure 8.1.

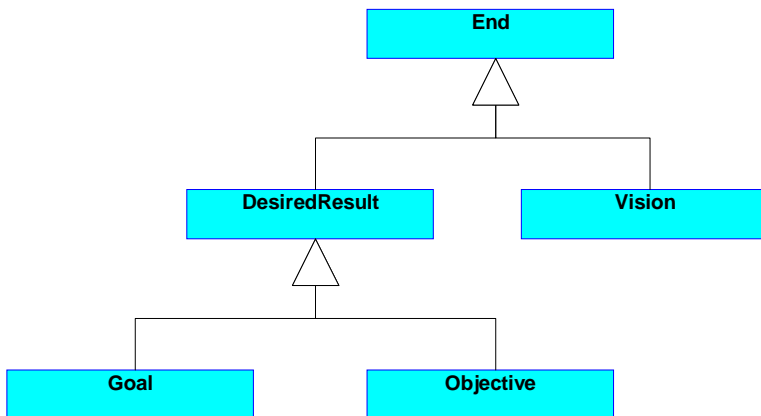

Figure 8.1 - The Hierarchy of “End” concepts

An End may be either a Vision or some Desired Result (a Goal or an Objective). The essence is that these are kinds of things, in varying detail, that the enterprise is trying to accomplish.

Vision is an overall image of what the organization wants to be or become. It usually encompasses the entire organization and is long-term in its perspective. Desired Results, on the other hand, are the more specific Goals and Objectives that the enterprise, or some part of it, intends to achieve.

8.1.2 Vision

A Vision describes the future state of the enterprise, without regard to how it is to be achieved.

A Vision is the ultimate, possibly unattainable, state the enterprise would like to achieve. A Vision is often compound, rather than focused toward one particular aspect of the business problem. A Goal, in contrast, should generally be attainable and should be more specifically oriented to a single aspect of the business problem.

A Vision is supported or *made operative* by Missions. It is *amplified by* Goals.

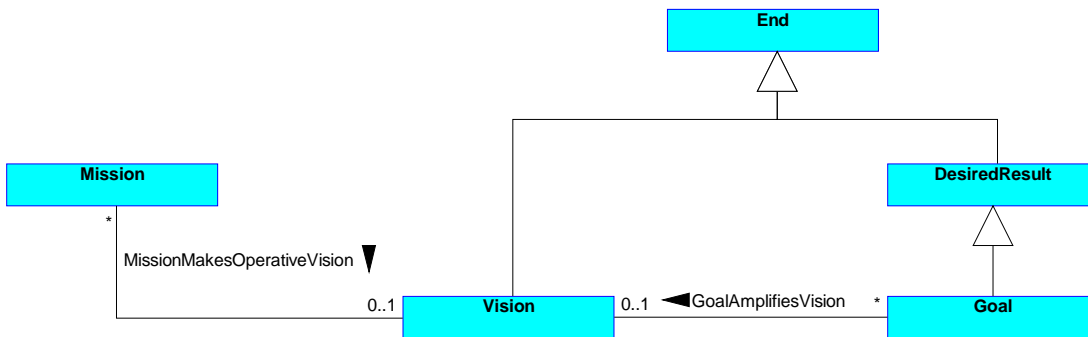

Figure 8.2 - Vision

Examples of Vision include the following:

Table 8.1 - Examples of Vision

Enterprise	Vision
EU-Rent	Be the car rental brand of choice for business users in the countries in which we operate.
Pizza Company	Be the city's favorite pizza place.
Consulting Company	Be the premier consulting company in the industry.
Retail Pharmacy	Be the low-cost health care provider with the best customer service.
Municipal Police Department	Be a professional, trusted provider of police services — a leader in cooperative efforts with the neighborhood and other agencies to make our city safer.

8.1.3 Desired Result

A Desired Result is an End that is a state or target that the enterprise intends to maintain or sustain. A Desired Result *is supported by* Courses of Action.

8.1.3.1 Categories of Desired Result

Desired Result includes the following concepts:

- Goal
- Objective

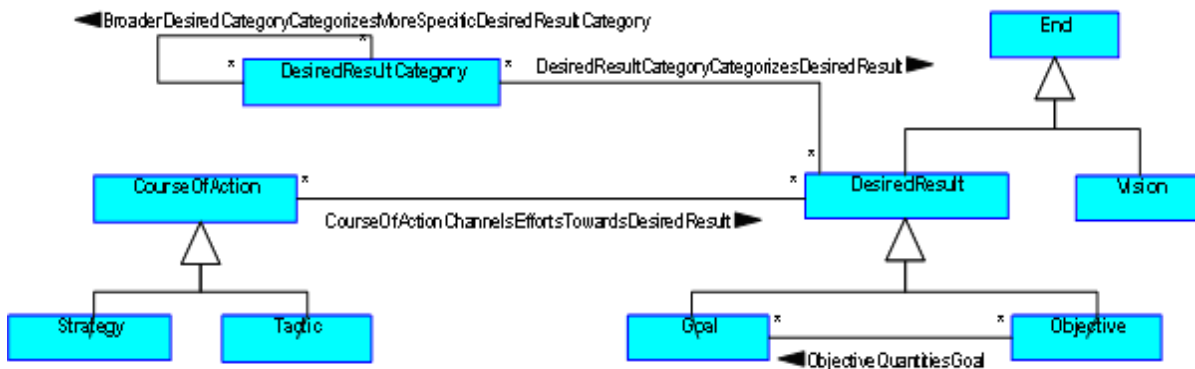

Figure 8.3- Desired Results — Goals and Objectives

Compared to an Objective, a Goal tends to be longer term, qualitative (rather than quantitative), general (rather than specific), and ongoing. Compared to a Goal, an Objective tends to be short term, quantitative (rather than qualitative), specific (rather than general), and not continuing beyond its time frame (which may be cyclical).

Objectives differ from Goals in that Objectives should always be time-targeted and measurable. Goals, in contrast, are not specific in these ways.

Desired Results *are supported by* Courses of Action, which can be either Strategies or Tactics. Generally, Goals are supported by Strategies, and Objectives are achieved by Tactics¹.

In many enterprises there is a continuum from major Strategies that impact the whole of the business to minor Tactics with limited, local effects. The dividing line between ‘minor Strategy’ and ‘major Tactic’ is blurred. Also, over time, some Courses of Action may evolve from Tactic to Strategy, and some Strategies may devolve into Tactics. Some enterprises do make a hard distinction between Strategies and Tactics; these enterprises may choose to pair Strategies only with Goals, and Tactics only with Objectives.

Other enterprises use other bases for distinguishing Strategies and Tactics. For example, some enterprises distinguish between Strategy and Tactic based on planning horizon. In this case, Strategies are put into place to support the long-term Goals (i.e., a planning horizon that is typically several years or more) while Tactics are the Courses of Action implemented to deal with the shorter planning horizon of a year or less (the current operational plans). Still other enterprises distinguish Strategy (a Course of Action that is for “the gaining of a specific advantage”) from Tactic, which is a Course of Action that is for “the deployment of specific resources to gain that advantage.”



As well as the built-in categories of Desired Result - Goal and Objective - the Model also supports Desired Result Category for stakeholder-defined categorization.

A Desired Result may be in more than one Desired Result Category, and Desired Result Categories may themselves be categorized in broader categories; a more specific category may be included in more than one broader category.

The Model does not provide a default set of stakeholder-defined categories. Enterprises can define whatever Desired Result Categories they need, such as 'quality', 'service levels', 'cost/benefit', 'regulatory compliance', and might further categorize some as key performance indicators.

1. An enterprise that prefers to strictly maintain this pairing can do so by specifying an appropriate constraint. It may also want to specialize the Model for its own use by replacing the fact type ‘Desired Result is supported by Course of Action’ with two more specific fact types: ‘Goal is supported by Strategy;’ ‘Objective is achieved by Tactic.’

8.1.4 Goal

A Goal is a statement about a state or condition of the enterprise to be brought about or sustained through appropriate Means. A Goal *amplifies* a Vision — that is, it indicates what must be satisfied on a continuing basis to effectively attain the Vision.

A Goal should be narrow — focused enough that it can be *quantified by* Objectives. A Vision, in contrast, is too broad or grand for it to be specifically measured directly by Objectives. However, determining whether a statement is a Vision or a Goal is often impossible without in-depth knowledge of the context and intent of the business planners.

Table 8.2 - Examples of Goal

Enterprise	Goal
EU-Rent	To be a ‘premium brand’ car rental company, positioned alongside companies such as Hertz and Avis.
EU-Rent	To provide industry-leading customer service.
EU-Rent	To provide well-maintained cars.
EU-Rent	To have vehicles available for rental when and where customers expect them.
Pizza Company	To deliver pizzas in an expedient amount of time.
Consulting Company	To improve customer satisfaction (over the next five years).
Publishing Company	To improve customer satisfaction (over the next five years).
e-Business Company	To have more customers than any other e-business.

8.1.5 Objective

An Objective is a statement of an attainable, time-targeted, and measurable target that the enterprise seeks to meet in order to achieve its Goals.

- **Attainable.** It is self-evident that Objectives should be attainable. If they are not, the business plans are unrealistic and will likely fail.
- **Time-targeted.** All Objectives should be time-targeted. This means that either an absolute time frame (e.g., “by January 1, 2007”) or relative time frame (e.g., “within two years”) should be included in each Objective. This time frame indicates when the Objective is to be met.
- **Measurable.** Objectives should be measurable. This means they must include some explicit criteria for determining whether the Objective is being met in practice. This criteria may be fairly exacting (for example, “on-time 95% of the time”). At the very minimum, the criteria must provide a basis for making a “yes or no” determination (e.g., “up and running”). Such criteria may be the basis for certain Business Rules, created specifically to compute or derive the relevant evaluation.

This understanding of ‘Objective’ is consistent with the industry’s popular “SMART” criteria that an Objective be: **S**pecific, **M**easurable, **A**ttainable, **R**elevant, and **T**ime-Based.

Statements of Objective should always begin with the time-targeted phrase, followed by a quantified noun. Example time-targeted phrases:

- By 09/01/2001

- Effective immediately
- After 2 years
- Within 5 weeks

- On or before June 1, 2007
- On April 15, 2007

An Objective *quantifies* a Goal — that is, it provides the basis for measures to determine whether the Goal is being achieved. Conversely, the Goal *is quantified* by these measurable Objectives. For example, the Goal “To provide industry-leading customer service” is quantified by the Objective “Effective immediately, a ranking of 8 or better on a monthly customer satisfaction scale of 1-10” and by the Objective “By Jan. 1, 2007, a B+ grade level on the annual Better Business Bureau ratings.”

Table 8.3 - Examples of Objective

Enterprise	Objective
EU-Rent	By end of current year, be rated by A C Nielson in the top 6 car rental companies in each operating country within the European Community.
EU-Rent	By end of current year, be rated by A C Nielsen in the top 9 car rental companies in all other operating countries.
EU-Rent	By end of current year, to score 85% on EU-Rent’s quarterly customer satisfaction survey.
EU-Rent	During 4th quarter of current year, no more than 1% of rentals need the car to be replaced because of mechanical breakdown (excluding accidents).
Pizza Company	By January 1, 2007, 95% on-time pizza delivery.
Consulting Company	By June 30, 2008, an operational customer call center.
e-Business Company	Within six months, 10% increase in product sales.

8.1.6 Facts that Organize Ends

Besides those mentioned above, other logical connections (i.e., fact types) are required to fully organize the Ends. These logical connections provide additional structure among elements of the Ends themselves.

8.1.6.1 Interrelating Desired Results

One Desired Result can *include* other Desired Results; a Desired Result can be *included in* some other Desired Result. In other words, there can be a ‘parts explosion’ of Desired Results. This connection should be used only to associate like instances — that is, Goals only to other Goals and Objectives only to other Objectives.

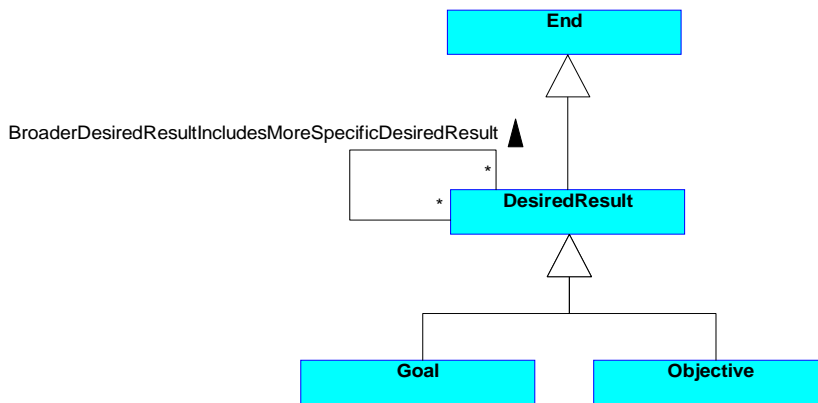

Figure 8.4 - Interrelating Desired Results

A ‘parts explosion’ of Desired Results happens when there is a decomposition of some higher-level Goal (or Objective) into lower-level Goals (or Objectives). Such decomposition occurs, for example, when elements of the business plans created by one level of management are handed down to a lower organizational level for more detailed planning or implementation. This creates a ‘recursion’ among the elements, from higher level to lower level. For example, the Goal “To keep customers satisfied” includes the sub-Goal “To deliver pizzas in an expedient amount of time” and the sub-Goal “To produce tasty pizzas.”

8.2 The Means Concepts

A Means represents any device, capability, regime, technique, restriction, agency, instrument, or method that may be called upon, activated, or enforced to achieve Ends. Remember that a Means does not indicate either the steps (business processes and workflow) necessary to exploit it, nor responsibility for such tasks, but rather only the capabilities that can be exploited to achieve the desired Ends.

In describing Means, it is useful to document who *established* the Means and at what point in time, so that an audit trail exists for future reference. This practice, of course, cannot always be mandated.

8.2.1 Categories of Means

Means concepts can be arranged in a hierarchy, as shown in Figure 8.5.

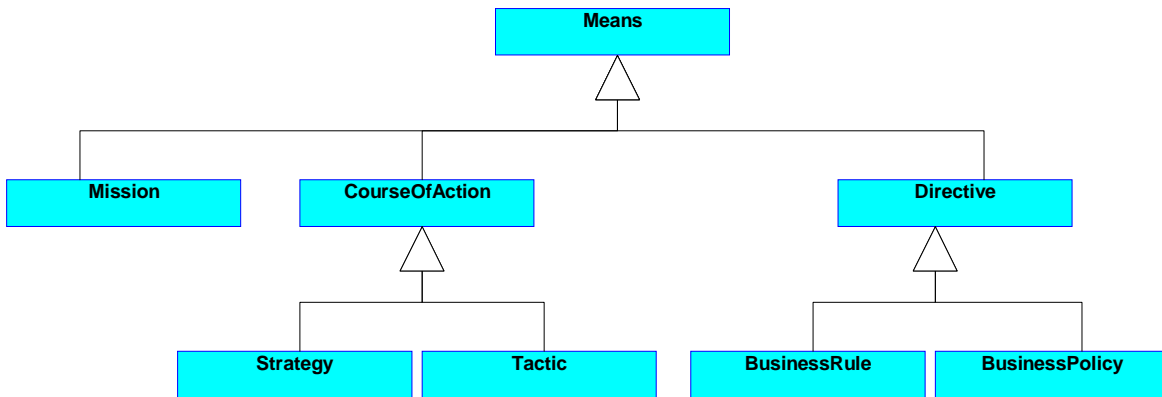

Figure 8.5- The Hierarchy of 'Means' Concepts

A Means may be either a Mission, a Course of Action (a Strategy or Tactic), or a Directive (Business Policy or Business Rule).

Mission, like its counterpart Vision, indicates a correspondingly long-term approach — one that is focused on achieving the Vision. Like Vision, Mission is not very specific; it is something broadly stated, in terms of the overall functioning of the enterprise.

Apart from the basic Mission of the enterprise, the Means of the Business Motivation Model have been carefully organized into Courses of Action and Directives.

In some respects, Courses of Action are the more basic of the two. In and of themselves, however, Courses of Action tend to be rather blunt instruments. They require Directives to have any real chance of success.

In contrast to Courses of Action, Directives cannot really stand on their own. They exist to give the Courses of Action a fine edge — in other words, to ensure that the Courses of Action will be applied intelligently and within the boundaries of what is acceptable or optimal for the enterprise. In short, Directives represent encoded (i.e., written down) knowledge that ensures the highest possible chances of success for the Courses of Action.

A Directive always has to do with governance or guidance. A Course of Action, in contrast, identifies an active approach in moving toward the Ends. A Course of Action is always action-dominated (action-oriented).

8.2.2 Mission

A Mission indicates the ongoing operational activity of the enterprise. The Mission describes what the business is or will be doing on a day-to-day basis.

A Mission *makes* a Vision *operative* — that is, it indicates the ongoing activity that makes the Vision a reality. A Mission is *planned by means* of Strategies.

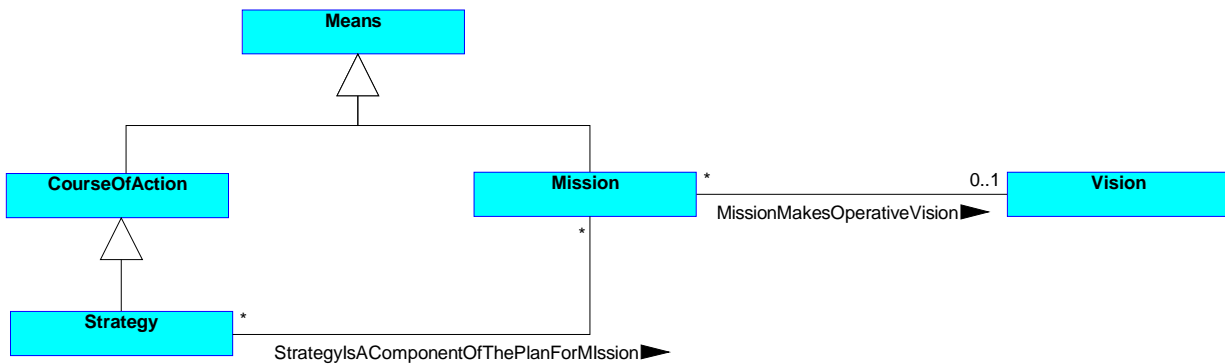

Figure 8.6 - Mission

A Mission statement should consist of the following three items only and should be formed using brief statements of them.

1. An action part (for example, “provide”)
2. A product or service part (for example, “pizzas”)
3. A market or customer part (for example, “customers city-wide”)

The Mission statement should be focused on day-to-day operations, generic enough to cover all Strategies, and broad enough to cover the complete area of operations.

Examples of Mission are listed in Table 8.4.

Table 8.4 - Examples of Mission

Enterprise	Objective
EU-Rent	Provide car rental service across Europe and North America for both business and personal customers.
Pizza Company	Provide pizza to customers city-wide.
Consulting Company	Provide consulting, outsourcing, and staff augmentation services to companies in North America.
Retail Pharmacy	Provide generic and ethical drugs to the retail market.

8.2.3 Course of Action

A Course of Action is an approach or plan for configuring some aspect of the enterprise involving things, processes, locations, people, timing, or motivation undertaken to achieve Desired Results. In other words, a Course of Action *channels efforts towards* Desired Results. To help ensure success in this regard, Courses of Action *are governed by* Directives.

Courses of Action, which include Strategies and Tactics, represent the basic elements of a general plan or overall solution — in other words, an overall approach — that the enterprise will take to achieve its Desired Results. It is important to remember that Courses of Action are not Business Processes; rather, Courses of Action can be *realized* by Business Processes – that is, made operative by Business Processes.

8.2.3.1 Categories of Course of Action

Course of Action includes the following concepts:

- Strategy
- Tactic

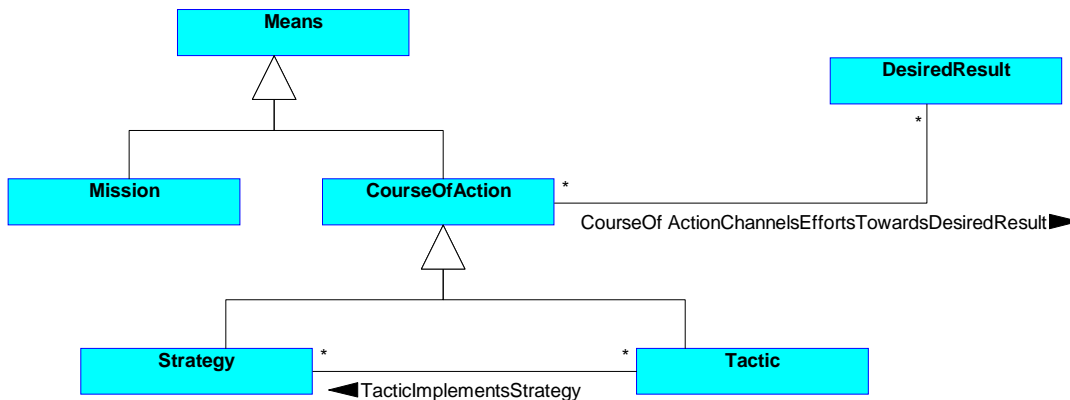

Figure 8.7- Courses of Action

Compared to Tactics, Strategies tend to be longer term and broader in scope. A Strategy *is implemented by* Tactics. Strategies usually *channel efforts towards* Goals, rather than Objectives.

Compared to a Strategy, a Tactic tends to be shorter term and narrower in scope. Tactics *implement* Strategies; they are courses of action that will support those Strategies. Tactics generally *channel efforts towards* Objectives, rather than Goals.

Determining whether a Course of Action is a Strategy or a Tactic may be impossible without in-depth knowledge of the context and intent of the business planners. In fact, in the course of developing and analyzing business plans, some elements may change category as the target problem is understood better. For example, an element originally defined as a Tactic may subsequently be elevated to a Strategy. The reverse is also likely to occur. In other words, the business plans will gradually evolve toward greater accuracy in specification, as well as greater coherence and completeness.

8.2.4 Strategy

A Strategy is one *component of* the plan for the Mission. A Strategy represents the essential Course of Action to achieve Ends — Goals in particular. A Strategy usually *channels efforts towards* those Goals.

A Strategy is more than simply a resource, skill, or competency that the enterprise can call upon; rather, a Strategy is accepted by the enterprise as the right approach to achieve its Goals, given the environmental constraints and risks.

Examples of Strategy include the following:

Table 8.5 - Examples of Strategy

Enterprise	Strategy
EU-Rent	Operate nation-wide in each country of operation, focusing on major airports, competing head-to-head, on-airport, with other premium car rental companies.
EU-Rent	Manage car purchase and disposal at local area level, with national (operating company) guidance covering: <ul style="list-style-type: none"> • What models may be bought from which manufacturers; • Overall numbers and mix of models; • When to dispose of cars, by mileage and age; • Phasing of purchasing and delivery.
EU-Rent	Join an established rewards scheme run by a third party (i.e., outsource rather than building own scheme).
Pizza Company	Deliver pizzas to the location of the customer's choice.
Consulting Company	Implement a Customer Relationship Management System.
Consulting Company	Increase repeat business
e-Business Company	Buy other e-business mailing lists.

8.2.5 Tactic

A Tactic is a Course of Action that represents part of the detailing of Strategies. A Tactic *implements* Strategies. For example, the Tactic “Call first-time customers personally” implements the Strategy “Increase repeat business.”

Tactics generally *channel efforts towards* Objectives. For example, the Tactic “Ship products for free” channels efforts towards the Objective “Within six months, 10% increase in product sales.”

Examples of Strategy include the following:

Table 8.6 - Examples of Tactic

Enterprise	Tactic
EU-Rent	Encourage rental extensions.
EU-Rent	Outsource maintenance for small branches.
EU-Rent	Create standard specifications of car models, selecting from options offered by the manufacturers. Note: these will be trade-offs between ‘rentable’ and ‘high residual value for sales.’
EU-Rent	Equalize use of cars across rentals so that mileage is similar for cars of the same car group and age.
EU-Rent	Comply with car manufacturers’ maintenance schedules.
Pizza Company	Hire drivers with their own vehicles to deliver pizzas.

Table 8.6 - Examples of Tactic

Enterprise	Tactic
Consulting Company	Provide each member of the sales force with a palmtop.
Consulting Company	Call first-time customers personally.
e-Business Company	Ship products for free.

8.2.6 Directive

As the name suggests, Directives indicate how the Courses of Action should, or should not, be carried out — in other words, they *govern* Courses of Action. Specifically, a Directive defines or constrains or liberates some aspect of an enterprise. It is intended to assert business structure or to control or influence the behavior of the business, and is stated in declarative form.

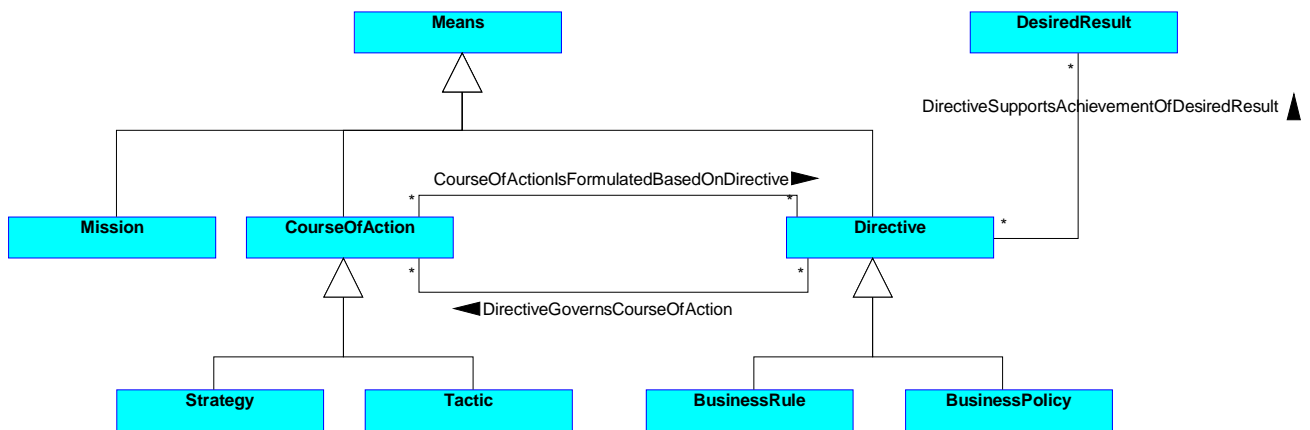

Figure 8.8 - Interrelating Directives with Courses of Action and Ends

Directives *govern* Courses of Action. For example, the Business Rule “Pizzas may not be delivered beyond a radius of 30 miles” governs the Strategy “Deliver pizzas to the location of the customer's choice.” This governance applies to Tactics as well. For example, the Tactic “Encourage rental extensions” is governed by the Business Policy “Allow extension of rentals by phone.”

It is expected that all Courses of Action should *be governed by* some Directive, especially as the business plans evolve and become more coherent and complete. Any Course of Action not *governed by* a Directive should be examined carefully to discover potential omissions.

On the other hand, having too many Directives may become unduly constraining. The correct balance in this regard can be identified only by having in-depth knowledge of the context and intent of the business people participating in the planning.

In striking this balance it should be remembered that, unless a Directive is made explicit, it is assumed that no constraint on other elements of the business plans will be exercised. ‘Unstated’ Directives simply cannot be addressed in the Model – quite literally, they can be recognized only by stating them². To be taken into account within the Model, every Directive must be explicit and recorded in an official manner³.

It is also possible for the Courses of Action to be *formulated based on* Directives. For example, the Tactics ‘Comply with manufacturer’s maintenance schedules’ and ‘Equalize use of cars across rentals so that mileage is similar for cars of the same car group and age’ are both formulated based on the Business Policy ‘Depreciation of cars must be minimized.’ The Directive thereby serves as the source of the Course of Action.

Occasionally a Directive is defined to *support the achievement of* a Desired Result directly. For example:

- The Business Policy “The cell phone numbers of customer representatives should be available to customers” supports achieving the Goal “To provide high-quality customer support.”
- The Objective “Within six months, 10% increase in product sales” is supported by this Business Rule that defines product sales: “Product sales must be computed as total sales, minus all of the following: sales tax, shipping charges, and maintenance contract fees.”

8.2.7 Business Rule Enforcement Level

A Business Rule that guides behavior⁴ has an enforcement level. Enforcement levels represent alternatives in a graded or ordered scale, each of which indicates the severity of action imposed to put or keep a rule in force. An example of a range of enforcement levels, from ‘strictly enforced’ to ‘guideline’⁵ is shown in Table 8.7.

Table 8.7 - Enforcement levels

Value	Meaning
strictly enforced	If the rule is violated, the penalty is always applied..
deferred enforcement	Strictly enforced, but enforcement may be delayed — e.g., waiting for resource with required skills.
pre-authorized override	Enforced, but exceptions allowed, with prior approval for actors with before-the-fact override authorization.
post-justified override	If not approved after the fact, you may be subject to sanction or other consequences.
override with explanation	Comment must be provided when the violation occurs
guideline	Suggested, but not enforced.

2. For Business Policies in particular, this represents a de facto boundary between Model and methodology. To be workable, a practical methodology must address the reality of implicit Business Policies within the business.
3. Making Business Rules explicit is a fundamental principle of the Business Rule approach. Refer to the *Business Rule Manifesto* [BRMAN].
4. Only business rules that guide behavior (SBVR ‘operative business rule’) require enforcement. Definitional business rules (SBVR ‘structural business rule’) are “true by definition”.
5. From the OMG specification for “Semantics of Business Vocabulary and Business Rules” [SBVR]

Examples of Enforcement Level include the following:

Table 8.8 - Examples of enforcement level

Enterprise	Directive	Enforcement Level
EU-Rent	A EU-Rent agent who is found, after a managerial review, to have rented a vehicle to a customer without a valid driver’s license, is to be fired.	strictly enforced
Pizza Company	A driver who is convicted of one moving traffic violation while driving for the company will be counseled by a manager concerning safe driving.	pre-authorized override
e-Business Company	A customer rated negative by more than ten other customers will be blocked forever from doing business.	override with explanation

Deciding what enforcement level is to be applied to a Business Rule is often a Tactic within business plans. In the BMM, Tactic *effects enforcement level of* Business Rule.

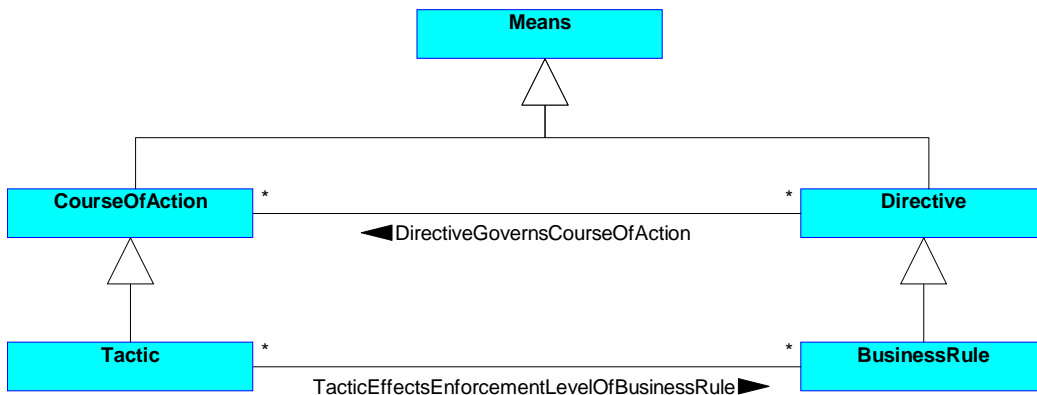

Figure 8.9 - Setting Enforcement Level

8.2.8 Directive as Regulation

A Directive may *act as* some other Organization Unit’s Regulation. The Business Rules and Business Policies determined at one level in an organization may be effectively the ‘law’ (Regulation) for lower-level organizations.

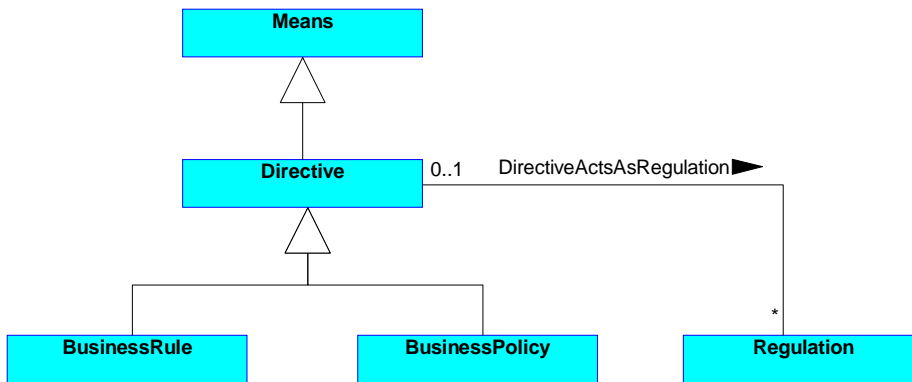

Figure 8.10 - Directive as Regulation

For example, production and sales divisions both have to comply with company policy on safety at work. These units in turn have to determine their own local policies and rules for their particular compliance with the ‘law’ (company policy) imposed from above. Furthermore, the rules and policies they come up with will most likely be unique; rules for safety within the production division are different from those in sales.

8.2.9 Categories of Directive

Directive includes the following concepts:

- Business Policy
- Business Rule

Compared to a Business Rule, a Business Policy tends to be less structured⁶, less discrete, and usually not atomic — that is, not focused on a single aspect of governance or guidance. Also compared to a Business Rule, a Business Policy tends to be less compliant with standard business vocabulary, and less formally articulated⁷.

In contrast to a Business Policy, a Business Rule is highly structured and is carefully expressed in terms of standard vocabulary. A Business Rule should be discrete and atomic — that is, represent only a single aspect of governance or guidance.



Business Policies provide broader governance or guidance that is not directly *practicable*. Business Rules provide specific, *practicable* governance or guidance to implement Business Policies. ‘Practicable’ means that a person who understands a Business Rule could observe a relevant situation (including his or her own behavior) and decide directly whether or not the business was complying with the rule.



Some Business Rules could be automated in software; some are practicable only by people. Business Policies are not directly automatable.

6. This means ‘structured’ in a natural language sense, not ‘structured’ in any technical sense.

7. ‘Less formally’ should not be interpreted as ‘less carefully.’

8.2.10 Business Policy

A Business Policy is a Directive that is not directly enforceable⁸ whose purpose is to govern or guide the enterprise. Business Policies provide the *basis for* Business Rules. Business Policies also *govern* Business Processes.

The formulation of a Business Policy, which is always under the enterprise’s control, is by some party who is authorized to manage, control, or regulate the enterprise by selecting from a variety of alternatives in response to one or more Assessments.

Business Policies that exist merely to enable a Strategy in a direct and trivial manner should be avoided. For example, suppose the enterprise has the Strategy “Encourage repeat business.” A Business Policy that says “Repeat business should be encouraged” is trivial and does not need to be expressed.

In general, Business Policies exist to govern – that is, control, guide, and shape – the Strategies and Tactics. For example, the Business Policy “We will not make on-site visits” governs the Strategy “Encourage repeat business,” as well as the specific Tactics that might be selected to implement the Strategy. Specifically, no Tactic requiring on-site visits will be permitted to support the Strategy — even though on-site visits would probably be effective in that regard. On the other hand, a Tactic involving sending coupons by mail would be acceptable under the Business Policy since it involves no on-site visits.

Examples of Business Policy include the following:

Table 8.9 - Examples of Business Policy

Source	Business Policy
EU-Rent	<p>Depreciation of rental cars must be minimized.</p> <p>Compare the (non-practicable) Business Policy with related (practicable) Business Rules:</p> <ul style="list-style-type: none"> • <i>The Car assigned to a Rental must be: at the time of assignment, of the available Cars in the requested Car Group, the one with the lowest mileage.</i> • <i>A Rental cannot be extended by phone if the Car's odometer reading is greater than (next service mileage – 500).</i>
EU-Rent	<p>Rental payments must be guaranteed in advance.</p> <p>Compare with Business Rule based on this policy:</p> <ul style="list-style-type: none"> • <i>A provisional charge for the estimated cost of the Rental must be made against a valid credit card held by the Renter before the Car is handed over.</i>
EU-Rent	<p>Rental cars must not be exported.</p> <p>Compare with Business Rule based on this policy:</p> <ul style="list-style-type: none"> • <i>An 'out of country' car can be rented only on a one-way rental with drop-off at a branch in its country of registration.</i>
EU-Rent	<p>Rental contracts are made under the law of the country in which the pick-up branch is located.</p>

8. “Not directly enforceable” means that some interpretation of the directive (e.g. in business rules) is needed in order to detect violations

Table 8.9 - Examples of Business Policy

Source	Business Policy
EU-Rent	Rentals must comply with relevant laws and regulations of all countries to be visited.
Pizza Company	Safety in the kitchen, and in the streets, comes first.
e-Business Company	A business representative will personally contact each customer who makes a complaint.

8.2.11 Business Rule

A Business Rule is a Directive, intended to govern, guide, or influence business behavior, in support of Business Policy that has been formulated in response to an Opportunity, Threat, Strength, or Weakness. It is a single Directive that does not require additional interpretation to undertake Strategies or Tactics. Often, a Business Rule *is derived from* Business Policy. Business Rules *guide* Business Processes.

Formally, a Business Rule is a rule that is under business jurisdiction⁹. A rule always introduces an obligation or necessity.

Table 8.10 - Examples of Business Rule

Source	Business Rule
EU-Rent	Each Car purchased must match the standard specification of its Car Model.
EU-Rent	The Car assigned to a Rental must be: at the time of assignment, of the available Cars in the requested Car Group, the one with the lowest mileage.
EU-Rent	A customer must present a valid driver's license in order to rent a EU-Rent vehicle.
EU-Rent	A Car whose odometer reading is greater than (next service mileage – 200) must be scheduled for service.
EU-Rent	The rental of a car whose odometer reading is greater than (next service mileage – 500) may be extended only if the car is exchanged at an EU-Rent branch.
EU-Rent	Every driver on a rental must be over 21 years old.
Pizza Company	Pizzas must be delivered within one hour.
Pizza Company	Pizzas may not be delivered beyond a radius of 30 miles.
e-Business Company	The order tax amount must be calculated at the time the order is placed.
e-Business Company	An order must not contain more than 25 order items.

9. This definition is adopted from the OMG specification for “Semantics of Business Vocabulary and Business Rules” (SBVR)

8.2.12 Facts that Organize Means

Besides those mentioned above, other logical connections (i.e., fact types) are required to fully organize the Means. These logical connections provide additional structure among elements of the Means themselves.

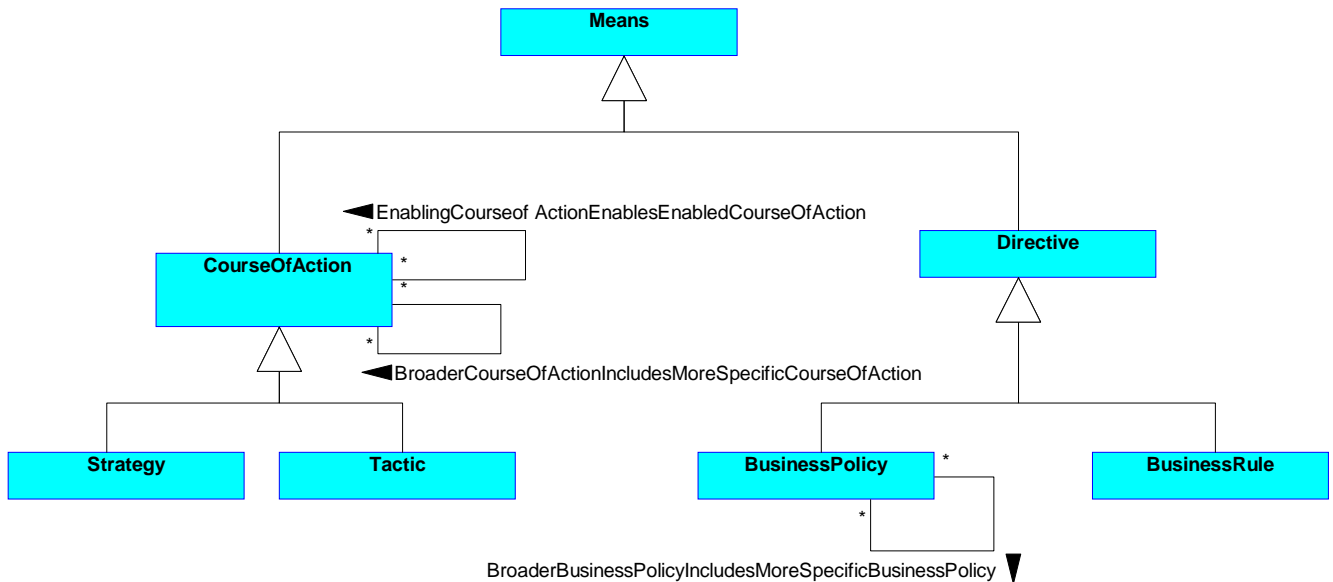

Figure 8.11 - Facts involving Means

8.2.12.1 Interrelating Courses of Action — Composition

One Course of Action can *include* other Courses of Action; a Course of Action can be *included in* other Courses of Action. In other words, there can be a ‘parts explosion’ of Courses of Action. This connection should be used only to associate like instances — that is, Strategies only to other Strategies and Tactics only to other Tactics.

Such ‘parts explosion’ happens when there is a decomposition of some higher-level Course of Action into lower-level Courses of Action. This decomposition occurs, for example, when elements of the business plans created by one level of management are handed down to a lower organizational level for more detailed planning or implementation. This creates a ‘recursion’ among the elements, from higher level to lower level. For example, the Strategy “Ensure that the stock of available vehicles never falls below an acceptable level” includes sub-Strategies appropriate to each geographic region.

8.2.12.2 Interrelating Courses of Action — Enabling

One Course of Action can be *enabled by* another Course of Action. In other words, the latter Course of Action provides basic support that makes the former Course of Action viable. This connection should generally be used to associate like instances — that is, Strategies only to other Strategies and Tactics only to other Tactics.

For example, the Strategy “Ensure that the stock of available vehicles never falls below an acceptable level” is enabled by the Strategy “Maintain vehicles in good working condition.” For another example, the Tactic “Provide each member of the sales force with a palmtop” enables the Tactic “Input sales orders at the source.”

8.2.12.3 Interrelating Business Policies

One Business Policy can *include* other Business Policies; a Business Policy can be *included in* other Business Policies. In other words, there can be a 'parts explosion' of Business Policies. For example, the Business Policy “Safety first” can be decomposed into more specific policies that deal with vehicle safety and workplace safety.

8.3 Expressing Core Elements of the Business Motivation Model

It is expected that statements an enterprise gives representing its Ends and its Directives will be laden with words that are judgmental, qualitative, and/or comparative. Indeed, the inclusion of such words is one fundamental characteristic of these elements.

Table 8.11 - Examples of “qualitative” words

Best	Biggest	Clear
Closest	Convenient	Courteous
Durable	Effective	Efficient
Expedient	Fast(est)	Leading-Edge
Low(est)-cost	Premier	Professional
Reliable	Responsive	Quickest

These ‘qualitative’ (judgmental or comparative) words should be avoided in expressing Missions, Strategies, and Tactics when the words actually refer to a desired end-state. Statements containing such words should be carefully analyzed and then re-stated as appropriate Desired Results or Directives. Indeed, the absence of adjectives suggesting desired end-states is one fundamental way in which Courses of Action are distinguished from Desired Results and Directives.

However, qualitative words may be used in Courses of Action if the words do not refer to the end-state desired. For example, the Tactic “ship products for free” includes the adjective ‘free.’ This is valid word usage in a Course of Action since it does not describe the Desired Result.

8.4 Influencers and Assessments

To fully understand the elements of business plans, it is necessary to identify the Influencers that shape them. This helps communicate the full intent of the Means and Ends by explaining the context in which they were formulated.

Influencers, however, are neutral — they are more or less simply just ‘there’ until someone makes an Assessment about how they are likely to impact some End or Means. Influencers should always be stated in a neutral, factual manner. Therefore, Influencers should be devoid of qualitative words. The presence of qualitative words indicates a statement *about* an Influencer — in other words, an Assessment.

This section describes the concepts that define these aspects of the Business Motivation Model. Understanding these elements supports intelligent revision of the business plans, possibly well after the business plans and related application system(s) have been implemented.

8.4.1 Influencers on the Ends and Means

An Influencer can be anything that has the capability to ‘produce an effect without apparent exertion of tangible force or direct exercise of command, and often without deliberate effort or intent.’ The Influencers specifically of concern to business plans are those that can impact the enterprise in its employment of Means or achievement of its Ends. This impact *has influence that is judged in Assessments*.

Influencers should not simply be named but described as well. Such amplification communicates sufficient background and/or contextual information for other planning participants to make appropriate, relevant Assessments.

In describing Influencers, remember they are always neutral, and must be *assessed* to determine implications for business plans. Suppose a statement is made that ostensibly describes some Influencer. If it appears that a Business Rule can be derived *directly* from the statement, then the statement is almost certainly not an Influencer. For example, consider the statement “The company color is blue.” This leads directly to the Business Rule “Each web site screen must contain the company color blue.” Because no Assessment needs to be made, the statement is of another kind – in this case most likely a Business Policy.

In describing Influencers, it is also useful to document who *recognizes* the Influencer and at what point in time, so that an audit trail exists for future reference. This practice, of course, cannot always be mandated.

8.4.2 Categories of Influencer

Influencers impact an enterprise’s employment of means or achievement of ends. There are two built-in categories of influencer:

- External: an influencer that is outside the enterprise's organizational boundaries
- Internal: an influencer from within the enterprise.

Beyond these, an enterprise can define whatever Influencer Categories it requires. Enterprises that do not have a preferred set of categories may choose to use the default set provided in Annex G, modifying and extending it as required.

This default set provides general categories that are used for examples and discussion in this specification.

It is suggested that each Influencer is categorized as (at least) one of the general categories and as either internal or external, as described in the following tables.

Influencer Categories may themselves be categorized in broader categories; a narrower category may be included in more than one broader category

Management of consistency when Influencers are categorized in multiple categories is a matter for methodology, practice and tools, and is beyond the scope of this specification.

8.4.2.1 Example: External Influencers

External Influencers are those outside an enterprise's organizational boundaries that can impact its employment of Means or achievement of Ends. Influencer Categories usually also categorized as External Influencer include the following.

Table 8.12 - Influencer Categories usually categorized as External Influencers

Influencer Category	Description
Competitor	A rival enterprise in a struggle for advantage over the subject enterprise.
Customer	A role played by an individual or enterprise that has investigated, ordered, received, or paid for products or services from the subject enterprise.
Environment	The aggregate of surrounding conditions or Influencers affecting the existence or development of an enterprise.
Partner	An enterprise that shares risks and profit with the subject enterprise (or is associated with the subject enterprise to share risks and profit) because this is mutually beneficial.
Regulation	An order prescribed by an authority such as a government body or the management of an enterprise.
Supplier	A role played by an individual or enterprise that can furnish or provide products or services to the subject enterprise.
Technology	The role of technology, including its developments and limitations — there may be prerequisites for use of technology; there may be enterprise activity that technology enables or restricts.

Examples of External Influencer include the following:

Table 8.13 - Examples of External Influencer

Enterprise	External Influencer	Category
EU-Rent	Two smaller competitors have merged and the joint enterprise is now bigger than EU-Rent in several European countries.	Competitor
EU-Rent	'Premium brand' car rental companies such as Hertz and Avis have a 'high quality, value for money' image – and can charge higher rates.	Competitor
EU-Rent	Budget airlines offering low-cost, short-haul flights, often to secondary airports.	Competitor
EU-Rent	EU-Rent's primary target is business customers, but it recognizes the need to appeal also to personal renters.	Customer
EU-Rent	Market research has determined that customers: <ul style="list-style-type: none"> generally accept that the rates for 'premium brand' car rental companies will be higher than the 'cheap and cheerful' competition. tend to see 'on-airport' companies as premium and 'off-airport' as cheap and cheerful. 	Customer
EU-Rent	Car parking and storage in city centers is limited and expensive.	Environment

Table 8.13 - Examples of External Influencer

Enterprise	External Influencer	Category
EU-Rent	The car rental market in Eastern Europe growing year-on-year by at least 5% per year.	Environment
EU-Rent	All on-airport car rental companies offer similar types of car, and are physically lined up in a row. If any promotes a special offer, others react almost immediately, so there is very little room for maneuver against competitors on product, service, or price.	Environment & Competitors
EU-Rent	EC-Lease, which finances cars for EU-Rent at preferential terms within several EC countries, in return for a share of EU-Rent profits in those countries.	Partner
EU-Rent	Laws and regulations in each country of operation for: <ul style="list-style-type: none"> • driver license and insurance; • roadworthiness of cars, including emissions; • protection of customer personal information. 	Regulation
EU-Rent	Car manufacturers – car models and options offered, prices, contract terms, and conditions.	Supplier
EU-Rent	Insurers – cover offered, options, premiums.	Supplier
EU-Rent	Vehicle identification and tracking systems.	Technology
EU-Rent	Availability and cost of (environment-friendly) electric and LPG cars.	Technology
EU-Rent	Internet support for self service rental reservations.	Technology
Pizza Company	<p>“Depreciation starts when you first use the property in your business or for the production of income. It ends when you take the property out of service, deduct all your depreciable cost or other basis, or no longer use the property in your business or for the production of income.”</p> <p>IRS 1999 1040 Forms and Instructions, 1999 Instructions for Schedule C, Profit and Loss from a Business Part II. Expenses, p. C-3</p>	Regulation

8.4.2.2 Example: Internal Influencers

Internal Influencers are those from within an enterprise that can impact its employment of Means or achievement of Ends. Influencer Categories usually also categorized as Internal Influencer include the following.

Table 8.14 - Influencer Categories usually categorized as Internal Influencers

Influencer Categories	Description
Assumption	Something that is taken for granted or without proof.
Corporate Value	An ideal, custom, or institution that an enterprise promotes or agrees with (either positive or negative).
- Explicit Value	A Corporate Value explicitly set forth and declared.
- Implicit Value	A Corporate Value not explicitly declared but nonetheless understood by some or all of the people in an enterprise.
Habit	A customary practice or use.
Infrastructure	The basic underlying framework or features of a system.
Issue	A point in question or a matter that is in dispute as between contending partners.
Management Prerogative	A right or privilege exercised by virtue of ownership or position in an enterprise.
Resource	The resources available for carrying out the business of an enterprise, especially their quality.

The default set also includes two categories, Implied Influencer and Explicit Influencer, for further categorization of influences categorized as Corporate Values.

Examples of Internal Influencer include the following:

Table 8.15 - Examples of Internal Influencer

Enterprise	Internal Influencer	Category
EU-Rent	EU-Rent needs to expand its business year on year.	Assumption
EU-Rent	A loyalty rewards program is essential for attracting business customers.	Assumption
EU-Rent	Managers are generally promoted from within the company.	Habit
EU-Rent	Successful branch managers are usually allowed to remain at their branches for as long as they want to.	Habit
EU-Rent	Branch counter staff receive two days' introductory training. Further training is informal, on the job.	Habit
EU-Rent	Rental branches are clustered in and around major cities, with large branches at airports and city centers, medium-sized branches in suburbs and nearby towns, and small agencies in hotels and travel agents' premises.	Infrastructure
EU-Rent	Cars are owned by local areas, not by rental branches. The cars owned by a local area are available to all branches in the area.	Infrastructure

Table 8.15 - Examples of Internal Influencer

Enterprise	Internal Influencer	Category
EU-Rent	Rental reservations can be made by telephone, via Internet, or in person. A rental branch can accept an in-person reservation for any other EU-Rent branch.	Infrastructure
EU-Rent	The internet rentals software was developed for individual rentals. It has few facilities to support corporate rental agreements.	Infrastructure
EU-Rent	To what extent car maintenance and servicing should be outsourced.	Issue
EU-Rent	The EU-Rent board has decided to give priority to Eastern Europe for business expansion in the next three years.	Management Prerogative
EU-Rent	Branch managers have authority to offer ad-hoc discounts in reaction to competitors' offers. They use their discretion in doing so, as the reduced price will affect branch financial performance.	Management Prerogative
EU-Rent	Cars – popular models from reputable manufacturers, low mileage, environment-friendly, low-cost maintenance.	Resource
EU-Rent	Branch staff: <ul style="list-style-type: none"> • Counter clerks - high turnover, variable quality • Managers - low turnover, high quality 	Resource
EU-Rent	EU-Rent is environment-friendly. All the car models it offers for rental have good fuel economy and low emissions.	Explicit Corporate Value
EU-Rent	EU-Rent offers quality, service and value for money, rather than lowest possible price.	Explicit Corporate Value
EU-Rent	Rental branch staff are supportive of colleagues and customers. For example, if there is a long queue of customers, they will help colleagues on the counter without needing direction from the manager to do so, and may delay a rest break until the queue is cleared.	Implicit Corporate Value
EU-Rent	Rental branch staff take good care of cars. For example, if they notice problems, (e.g., oil leaks, muffler noise, tire wear) they ensure that maintenance staff are alerted, even if it is not their direct responsibility to do so.	Implicit Corporate Value
e-Business Company	Short lunch hours.	Implicit Corporate Value
Accounting Company	Regional managers have considerable latitude.	Management Prerogative

8.4.3 Influencing Organization

It is also useful to be able to connect an Influencer to one or more Influencing Organizations; for example:

- To connect Regulation Influencers to their originating Regulators.
- To reference some specific competitor companies from a Competitor Influencer.

- To reference a Technology influencer to organizations involved in its development or delivery.

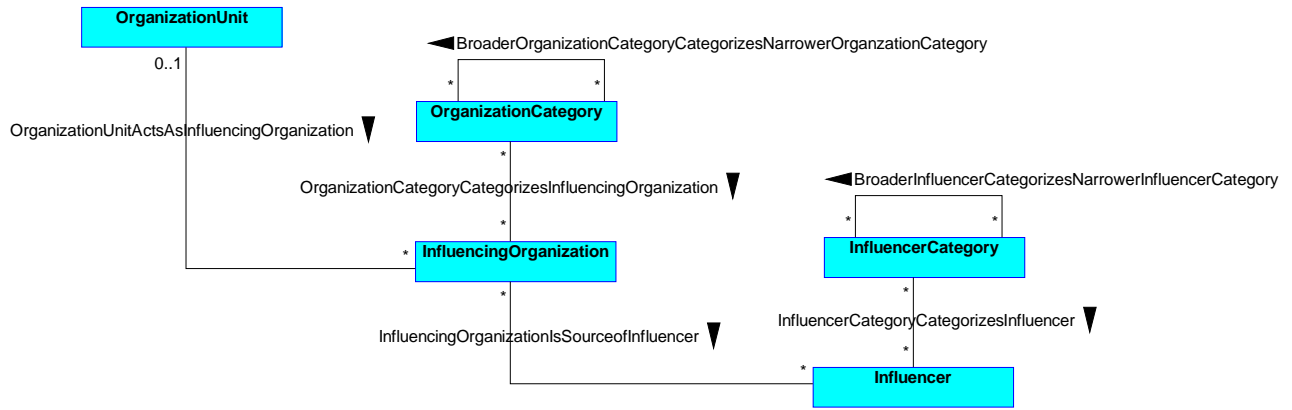

Figure 8.12 - Influencer and Influencing Organization

An Influencing Organization is an organization that is external to the enterprise modeled in a given enterprise BMM, and that influences that enterprise.

An Influencing Organization *is the source of* Influencers. An Influencer may have multiple sources, or none.

The Model also supports Organization Category for categorization of Influencing Organizations, but does not provide a default set of categories. Enterprises can define whatever Organization Categories they need. Organization Categories may themselves be categorized in broader categories; a narrower category may be included in more than one broader category

An Organization Unit from the same organization as the enterprise modeled in a BMM can act as an Influencing Organization for some Influencers. An Organization Unit playing this role would normally be outside the boundary of the enterprise modeled in the BMM.

For example, a Directive on working conditions from the Human Resources Department may have to be treated as Regulation by an operating department, such as Production. The Human Resources Department, from the perspective of the Production Department, would be acting like an external regulator. Similarly, there might be internal sources for other kinds of Influencer, such as Customer, Competitor, Technology.

8.4.4 Directive as Regulation

One Influencer Category, Regulation, is explicitly defined in the Model.

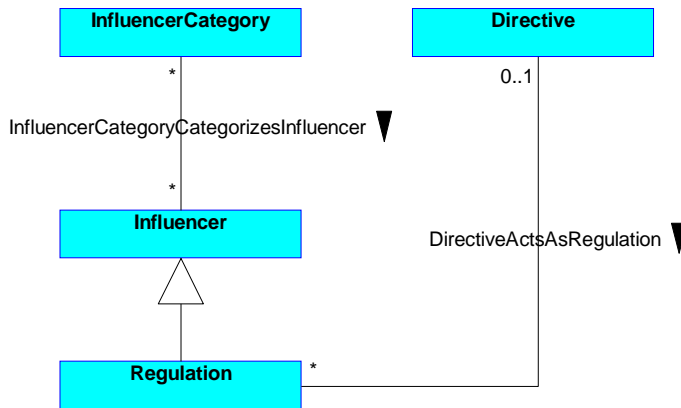

Figure 8.13 - Directive as Regulation

This supports the requirement discussed in Clause 8.2.6 for Directive to be able to act as a Regulation within an enterprise.

8.4.5 Assessing the Impact of Influencers on Ends and/or Means

Influencers are neutral — they are more or less simply just ‘there’ until someone makes an Assessment of them as they relate to Ends and/or Means. Such an Assessment represents a *judgment of* an Influencer with respect to its impact on Ends and/or Means. Specifically, the Assessment indicates that the Influencer *affects the employment of* Means and/or *affects the achievement of* Ends, in certain ways.

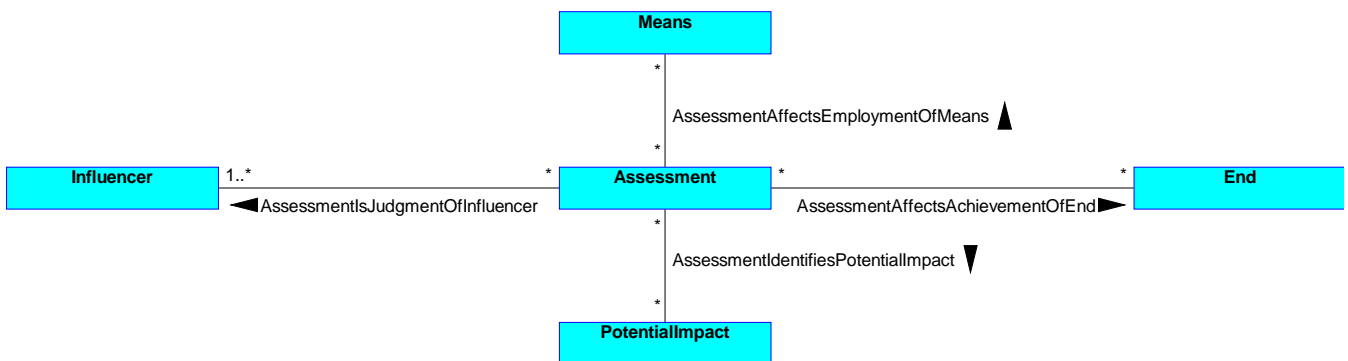

Figure 8.14 - Concepts for Assessments of Influencers on Ends and/or Means

If an Assessment is related to both a Means and an End, then this suggests that the particular Means is somehow related to the particular End. Specifically, if there is not a fact relating them — such as ‘Course of Action channels efforts towards Desired Result’ or ‘Directive supports achievement of Desired Result’ — then careful consideration should be given to that omission.

8.4.6 Assessment

An Assessment is a *judgment of* some Influencer that affects the organization’s ability to employ its Means or achieve its Ends. In other words, an Assessment expresses a logical connection (i.e., fact type) between Influencers and the Ends and/or Means of the business plans. In this way, an Assessment indicates which Influencers are relevant to which Ends and/or Means.

Different people or groups of people¹⁰ might make different Assessments of the very same Influencers on the very same Ends and Means — and perhaps even the same person or group of people at different points in time. It is very important to indicate which person or group of people *makes* which Assessment of an Influencer at which point in time, so that an audit trail exists for future reference. This practice, of course, cannot always be mandated.

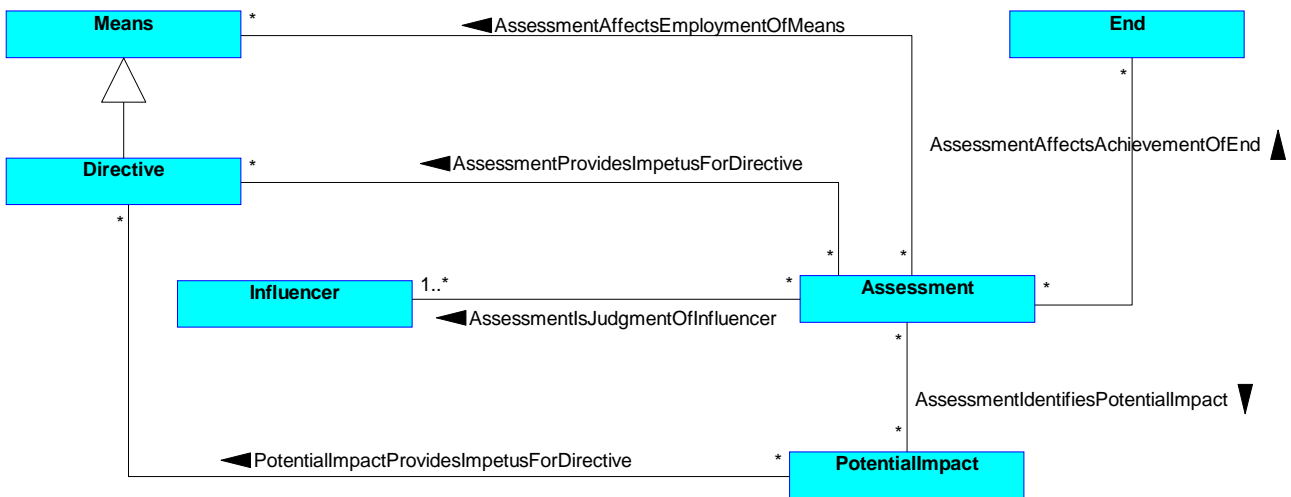

Figure 8.15 - Assessment and Directive

An Assessment can *provide the impetus for* Directives that *govern* Courses of Action and/or *support the achievement of* Ends. In other words, the Directive *is motivated by* the Assessment.

8.4.6.1 Use of Assessments by Assessments

Assessments can also use other assessments, as illustrated in Figure 8.16.

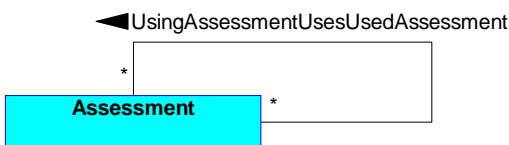

Figure 8.16 - Assessment Uses Assessment

10. Organization Unit. The BMM does not elaborate organizational structures – their importance is recognized, but they are outside the scope of the model.

Typical use of this association is connecting an assessment to other assessments referenced while arriving at the judgment. These associations can then be used for many purposes, including

- Decision support for making new assessments - identifying the full set of concerns taken into account in earlier assessments.
- Compliance audit - justifying decisions made in reacting to change.

8.4.6.2 Categories of Assessment

The BMM supports a general categorization structure for Assessment, as illustrated in Figure 8.17.

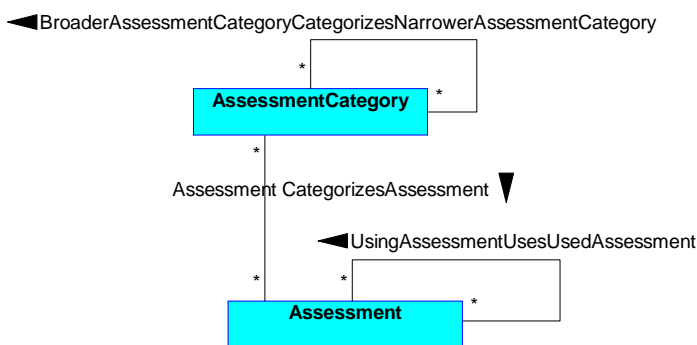

Figure 8.17 - Categories of Assessment

Categories of assessment may themselves be categorized in broader categories; a narrower category may be included in more than one broader category

SWOT - Strength, Weakness, Opportunity, Threat - is a frequently-used set of categories for Assessment. There are other approaches, but if an enterprise does not have another preferred set, SWOT is a sound default. The Assessment Category definitions for SWOT are provided in Annex G: Categorization Defaults.

SWOT is used as the illustrative approach for discussion and examples in the rest of this specification.

8.4.6.3 Strength

This category of Assessment indicates some advantage or area of excellence within the enterprise that can impact its employment of Means or achievement of Ends.

Some examples of Strength Assessments are listed below.

Table 8.16 - Examples of Strength Assessments

Enterprise	Strength	Affects
EU-Rent	Infrastructure: geographical distribution of branches	Appeal to business customers.
EU-Rent	Implicit corporate values: environment-friendly, value rather than price – good positioning of EU-Rent, differentiating from competitors.	Promotion to all customers as a 'premium brand.'
EU-Rent	Resource: rental branch managers – ground-level leaders of the customer-facing business.	Building branch networks around major cities and airports.

8.4.6.4 Weakness

This category of Assessment indicates some area of inadequacy within the enterprise that can impact its employment of Means or achievement of Ends.

Some examples of Weakness Assessments are listed below.

Table 8.17 - Examples of Weakness Assessments

Enterprise	Weakness	Affects
EU-Rent	The software for internet rentals has few facilities for self-service of corporate rental agreements – e.g., analyzing car usage by employees, removing people who have left their employment with the corporate customer.	Appeal to businesses for corporate agreements.
EU-Rent	High turnover of branch counter staff frequently causes shortage of experienced staff in branches. This can cause delays in dealing with exceptions and problems.	Provision of high-quality customer service.

8.4.6.5 Opportunity

This category of Assessment indicates that some Influencer can have a favorable impact on the organization’s employment of Means or achievement of Ends. For example, the bankruptcy of Pizza Company’s major competitor in Region-Y is assessed to be an Opportunity in its Goal “To increase market share.”

Some examples of Opportunity Assessments are listed below.

Table 8.18 - Examples of Opportunity Assessments

Enterprise	Opportunity	Affects
EU-Rent	EU-Rent thinks there is room for competition in the ‘premium brand’ car rental market.	Appeal to business users. Increase in rental rates.
EU-Rent	Depreciation on cars between their purchase, new, and their sale at the end of their rental life is a critical factor in financial success. Their employment with the corporate customer.	Improved management of depreciation would reduce costs.

8.4.6.6 Threat

This category of Assessment indicates that some Influencer can have an unfavorable impact on the organization’s employment of Means or achievement of Ends.

Some examples of Threat Assessments are listed below.

Table 8.19 - Examples of Threat Assessments

Enterprise	Threat	Affects
EU-Rent	Budget airlines provide low-cost flights to major cities, but using secondary airports where EU-Rent does not have branches.	Appeal to business users. Expansion into Eastern Europe.
EU-Rent	Budget airlines offer a cost effective and faster alternative to car rental for short distances (say, up to 200 miles).	Building 'premium' business from major airports.
EU-Rent	Congestion charges in European city centers: <ul style="list-style-type: none"> • Discourage customers from renting cars in city centers. • Increase EU-Rent operational costs when moving cars to and from city offices. 	Positioning city offices – moving them outside congestion zones will reduce convenience for business customers.

8.4.7 Potential Impact

An Assessment records judgments about the impact (or potential for impact) of some Influencer on Ends and/or Means in terms of Potential Impacts. In other words, an Assessment *identifies* some Potential Impact(s) that *is/are significant to* that Assessment. Each Potential Impact is an evaluation that quantifies or qualifies some aspect of an Assessment in specific terms, types, or dimensions.

A Potential Impact *significant to* an Assessment can *provide the impetus for* Directives that *govern* Courses of Action or *support the achievement of* Ends. An Influencer may lead to the creation of a Business Policy *only* through an Assessment having been made that *identifies* some Potential Impact.

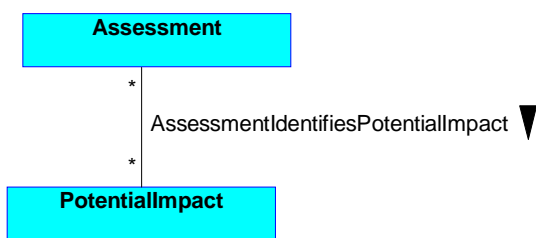

Figure 8.18 - Assessment and Potential Impacts

8.4.7.1 Categories of Potential Impact

Potential Impacts are categorized as follows:

- Risk
- Potential Reward

Risks are typically regarded to be negative impacts, whereas Rewards are considered positive.

Where there is more than one Assessment associated with a single instance of an End or Means, the total impact should be evaluated to uncover tradeoffs between Risks and Potential Rewards. This is the basis of risk/benefit analysis.

8.4.7.2 Risk

A Risk is a category of Impact Value that indicates the impact and probability of loss. Some Risks are expressible as formulae.

- Probability of loss (e.g., 5% probability)
- Potential loss (e.g., \$500,000 loss)
- Unit-of-measure (e.g., loss in USD)

Table 8.20 - Examples of Risk

Enterprise	Assessment	Risk
EU-Rent	Opportunity: room for competition in the ‘premium brand’ car rental market.	Failure to position EU-Rent as a premium brand risks loss of an estimated 15% of current customers without replacement by new customers.
EU-Rent	Opportunity: targeting business customers & increasing rental rates.	Many unrented cars at weekends, with rates undercut by the ‘cheap and cheerful’ competition.
EU-Rent	Threat: stringent emission control requirements in Scandinavia – have to be met by any EU-Rent car that might be driven in Scandinavia.	Severe financial penalties for failure to comply.

8.4.7.3 Potential Reward

A Potential Reward is a category of Potential Impact that indicates the probability of gain. Some Potential Rewards are expressible as formulae, for example:

- Probability of gain (e.g., 30% probability)
- Potential gain (e.g., \$40,000 gain)

Table 8.21 - Examples of Potential Reward

Enterprise	Assessment	Potential Reward
EU-Rent	Opportunity: room for competition in the ‘premium brand’ car rental market.	Market acceptance would support an average increase of 12% on rental rates. In moving up-market, EU-Rent expects to replace at least 15% of its current customers.
EU-Rent	Opportunity: improved management of depreciation of cars.	Reduction of depreciation costs by 3%.

8.4.8 EU-Rent Example: Reaction to Influencers

EU-Rent needs to decide how it wants to position itself in the car rental market.

- ‘Premium’ car rental companies, such as Hertz and Avis, have a ‘high quality, value for money’ image. *(These EU-Rent Competitors are External Influencers.)*
- Customers generally accept that the rates for premium companies will be higher than the ‘cheap and cheerful’ competition. Customers tend to see ‘on-airport’ companies as premium, and ‘off-airport’ companies as cheap and cheerful. *(These Customers – determined by market research – are External Influencers for EU-Rent.)*
- EU-Rent thinks there is room for competition in the premium market. *(This is an Opportunity Assessment.)*
- EU-Rent decides that it wants to be a premium car rental company. *(This is a Goal.)*
- To achieve this, EU-Rent decides to be nation-wide in each of its countries of operation, focusing on major airports, and to compete head-to-head, on-airport, with other premium car rental companies. *(This is a Strategy.)*
- A problem for on-airport car rental companies is that all the competitors offer similar types of car, and are physically lined up in a row. *(This Environment is an External Influencer for EU-Rent.)* There is very little room for maneuver on product, service, or price. *(This is a Weakness Assessment.)*
- This on-airport constraint on pricing means that depreciation on cars between their purchase as new cars, and their sale at the end of their rental life will be a critical factor in financial success *(This is an Opportunity Assessment.)* In response to this, EU-Rent decides that depreciation of cars must be minimized. *(This is a Business Policy.)*
- EU-Rent has a Strategy for car purchase and disposal, covering:
 - what models to buy from which manufacturers,
 - what overall numbers and mix and cars to buy,
 - when to dispose of cars, by mileage and age,
 - how to phase purchasing and delivery of cars,
 - etc.
- Within this Strategy, EU-Rent develops Tactics¹¹ for its “minimize depreciation” Business Policy, and Business Rules to govern and guide these Tactics. For example:

- Create standard specifications of car models, selecting from options offered by the manufacturers – this is a trade-off.

Table 8.22 - Examples of Tactics and Business Rules

Tactics	Business Rules
Create standard specifications of car models, selecting from options offered by the manufacturers – this is a trade-off between ‘rentable’ and ‘high residual value for sales.’	Each Car purchased must match the standard specification of its Car Model.
Equalize of use of cars across rentals.	The Car assigned to a Rental must be: at the time of assignment, of the available Cars in the requested Car Group, the one with the lowest mileage.
Comply with manufacturer’s maintenance schedule.	Any Car whose odometer reading is greater than (next service mileage – 200) must be scheduled for service.
	A Rental cannot be extended by phone if the Car’s odometer reading is greater than (next service mileage – 500). The Customer must bring it to an EU-Rent branch for a change of car.

8.5 Placeholders

Four concepts - Asset, Organization Unit, Business Process, and Business Rule - have roles in the structure of the Business Motivation Model but actually belong in other standards, where they are defined and associated with related concepts needed for detailed business modeling.



The defaults for the required external standards are OMG's specifications for Business Process Model and Notation (BPMN) and Semantics of Business Vocabulary and Business Rules (SBVR). In practice, enterprises could use alternative external standards.



Business Rule is a core concept of the BMM (albeit that its definition is adopted from SBVR). Business Processes in a BMM are placeholders for association with concepts in BPMN. OMG does not have a general specification for organization structure. BMM placeholders for Organization Units reference parts of the organization structure used in the enterprise's operational business.

Assets, discussed in clause 8.5.3, are not yet referenced to any particular OMG specifications.

8.5.1 Organization Unit

It is difficult to avoid references to ‘Who’ in discussions of ‘Why.’ Generally, it is not adequate to say, “the motivation is that the company wants it that way.” This leads to the perpetuation of unnecessary rules — unnecessary either because the business requirement for them has passed, or because they were not Business Rules in the first place (e.g., they were imposed as workarounds in systems that did not fully support business needs).

11. These Tactics will be realized in Business Processes. As before, however, the detailing of these Business Processes is outside the scope of the BMM.

Being able to pin down the motivation more precisely is essential. After all, if a responsible party cannot be found for a rule, it should probably be challenged. The Model therefore supports identifying those parties who play key roles with respect to motivation.

This capability is reflected in the Model by linking elements of the business plans to specific parts of the organization (i.e., its Organization Units). This has been done where the connection is important for developing, analyzing, challenging, and maintaining the business plans.

These logical connections (i.e., fact types) include the following:

- Organization Unit *is responsible for* Assets
- Organization Unit *is responsible for* Liabilities
- Organization Unit *defines* Ends
- Organization Unit *establishes* Means
- Organization Unit *acts as* Influencing Organization
- Organization Unit *recognizes* Influencers
- Organization Unit *makes* Assessments
- Organization Unit *is defined by* Strategies
- Organization Unit *is responsible for* Business Processes

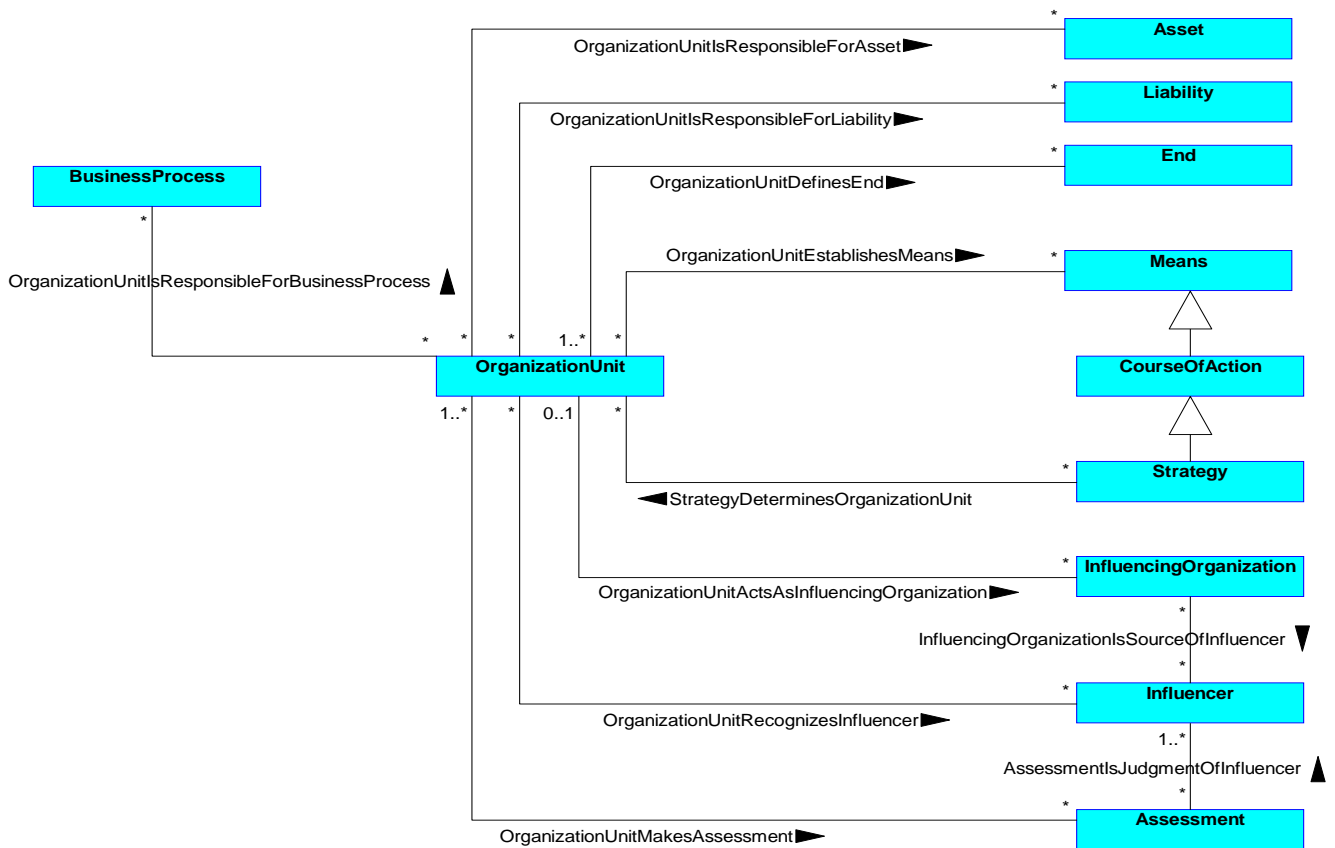

Figure 8.19 - Organization unit

8.5.2 Business Process

To expand on the ‘being-doing’ relationships between Ends and Means, Business Processes need to be considered.

It is widely recognized that Business Processes and Business Rules are closely related. It is important to be clear on the differences.

Business Processes *realize* Courses of Action – they provide detail of activities, plus sequencing, control, and synchronization that enable the enterprise to undertake its Courses of Action. Business Rules *guide* Business Processes – they provide the basis for decisions that need to be made within Business Processes.

Business Processes, Courses of Action, and Business Rules are all developed to help the enterprise reach its Goals. They need to be coherent and consistent. This is feasible if they are governed by a coherent and consistent set of Business Policies.

Business Processes *are governed by* Business Policies, which:

- Provide guidance (both directly and via Courses of Action) on what Business Processes have to do.
- Set limits on how Business Processes may undertake what they have to do.



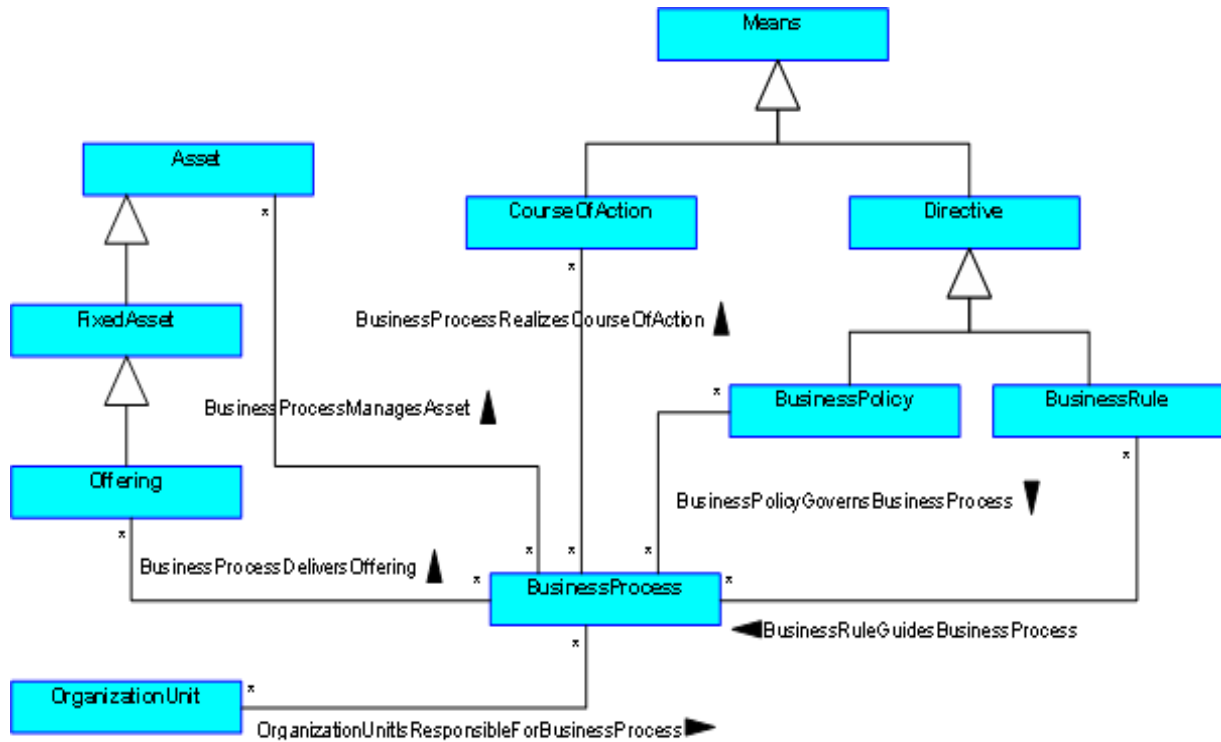

Figure 8.20 - Business Process

‘Business Process’ in the Model is a placeholder for a concept to be adopted from an external standard, such as BPMN. Each Business Process is *the responsibility of* some Organization Unit (the process owner). There are other facts connecting Business Process and Organization Unit; for example, assignment of activities in Business Processes to roles in the organization is the basis of workflow. However, these connections are again outside the scope of the BMM, and are appropriately addressed by other standard(s).

8.5.3 Asset and Liability

When Courses of Action are being defined, ‘things’ that are used in operating the enterprise often have to be considered. They are represented in the Model as Assets, of two kinds:

- Fixed Assets: things that are kept long-term, maintained, reused, and perhaps eventually replaced. They can be tangible, such as equipment and buildings, or intangible, such as patents and licenses.
- Resources: things that are consumed and replenished, such as raw materials, parts, finished goods, and cash.

Two things should be borne in mind. Firstly, the term “Asset” has an accounting flavor, but it is not used in that sense in the Model. Most BMM users will probably have an operational perspective. They will want to refer to the real things in the business - the actual equipment, buildings, and stocks of materials - and that is what “Asset” means in the Model. The accounting perspective would be the monetary values, rather than the things themselves.

Also, a BMM can include Assets that might not be explicitly valued financially, such as skills of people in the enterprise.

Secondly, Asset, Resource, and Fixed Asset are placeholders - references to things defined in detail **elsewhere in the enterprise**, outside its BMM. Only those that are relevant to governance decisions need be included. There is no requirement for a coherent, complete structure of Assets within a BMM; that will be maintained in the system(s) referenced by the BMM placeholders.

One type of Asset that is often explicitly referenced is the enterprise's products and services, called "Offering" in the Model. An Offering is a specification of a product or service - an intangible Fixed Asset. Instances of it, such as quantities of finished goods, would be a Resource.

As well as Assets, enterprises also need to consider Liabilities - again, not in an accounting sense. A Liability in the Model is a reservation of Resource(s) to meet commitments, such as materials needed to fulfill a contract, or cash to pay taxes.

These concepts are illustrated in Figure 8.21.

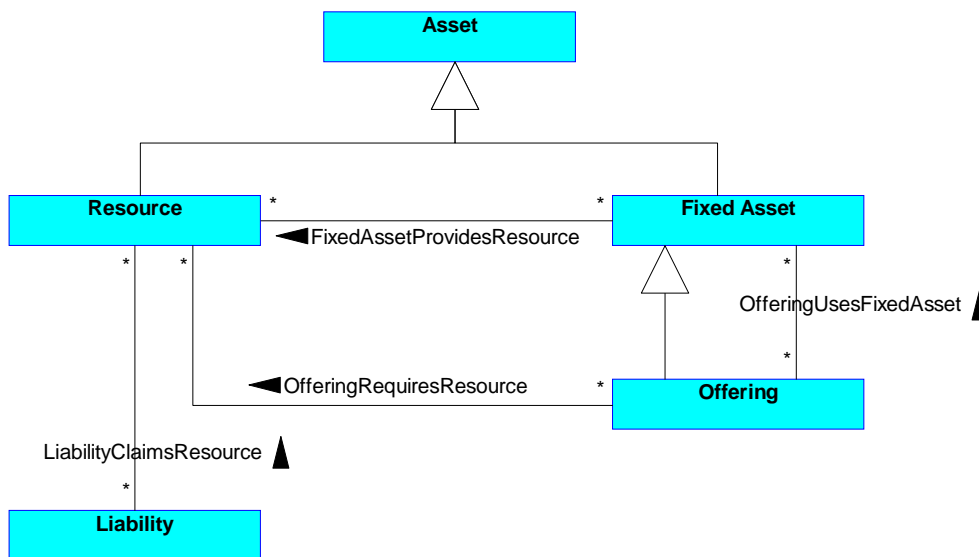

Figure 8.21 - Asset and Liability

Some Fixed Assets *provide* Resources in the form of capacity over time; for example: production equipment, storage buildings, skills possessed by people. The Resources they provide are either consumed, or are dissipated as time passes without their being used.

Offerings - specifications of products and services - may *use* intangible Fixed Assets, such as designs, licenses, patents, and brands. An Offering *requires* Resources - materials, equipment capacity, people's time - for production of things that meet the specification.

A Liability *claims* Resources; it reserves resources needed to meet commitments - which means that the resources cannot be used for other purposes.



Figure 8.22 illustrates connection of Asset and Liability to the rest of the Model.

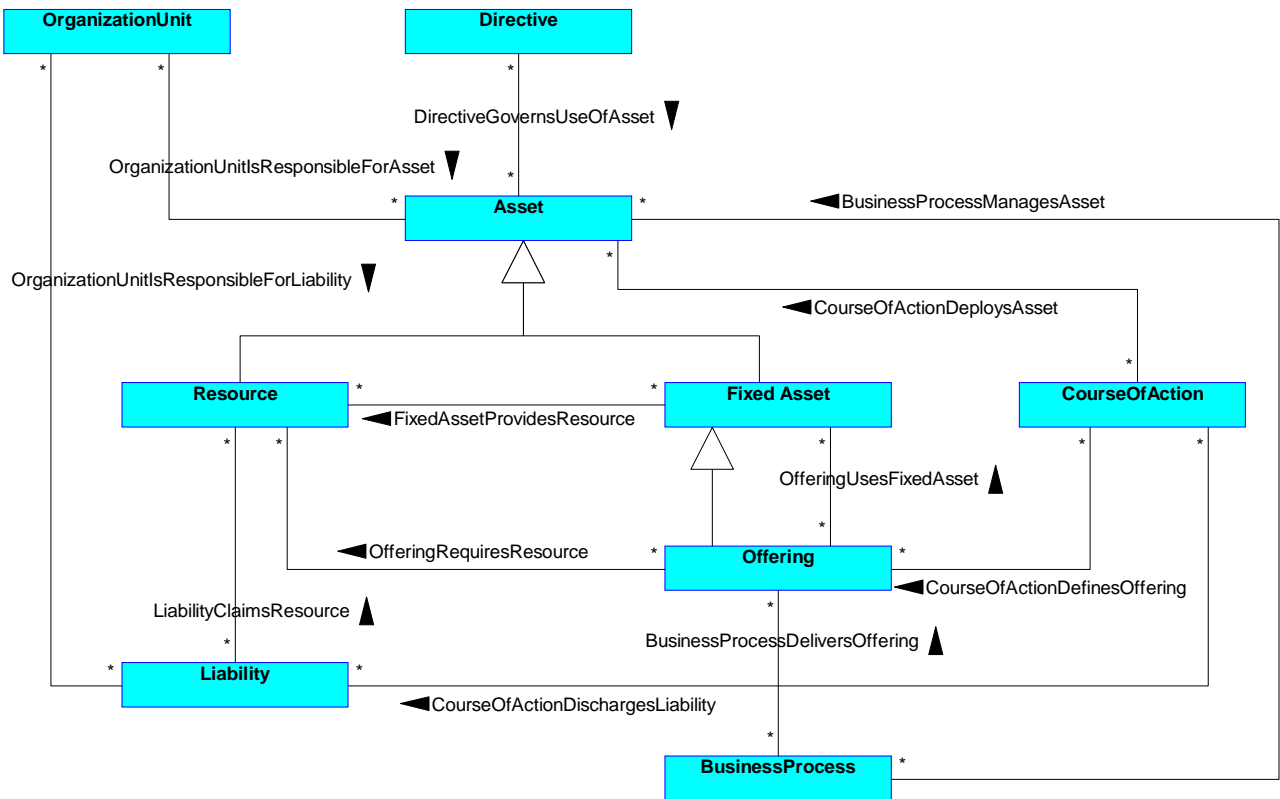

Figure 8.22 - Asset and Liability Associations

Courses of Action may

- *deploy* Assets: determine how Assets will be assigned and used in realizing the Courses of Action.
- *define* Offerings, the products and services that can be supplied by the enterprise
- *discharge* Liabilities: ensure that commitments are met.

A Directive may *govern use of* Assets, regardless of which Courses of Action *deploy* them.

Other placeholders may be associated with Assets and Liabilities. Business Processes may:

- *deliver* Offerings
- *manage* Assets

An Organization Unit may *be responsible for* Assets and/or Liabilities.

8.6 Associations between concepts of the same type

Some BMM associations are between concepts of the same type, playing different roles:

- "Enabling Course of Action enables Enabled Course of Action"

- "Broader Course of Action includes More Specific Course of Action
- "Broader Desired Result includes More Specific Desired Result
- "Broader Desired Result Category categorizes Narrower Desired Result Category
- "Broader Assessment Category categorizes Narrower Assessment Category
- "Using Assessment uses Used Assessment
- "Broader Business Policy includes More Specific Business Policy
- "Broader Organization Category categorizes Narrower Organization Category
- "Broader Influencer categorizes Narrower Influencer Category

This type of association has two constraints.

First, such associations are transitive. For example, if Course of Action 'A' includes Course of Action 'B', and Course of Action 'B' includes Course of Action 'C', then Course of Action 'A' includes Course of Action 'C'. This is obviously true for 'includes', but it is also true for other verbs in this type of association. For example:

- "If Course of Action Z requires Course of Action Y to enable it, and Course of Action Y requires Course of Action X to enable it, then Course of Action Z requires Course of Action X to enable it.
- "If Desired Result Category P categorizes Desired Result Category Q, then any Desired Result Category that categorizes Desired Result Category P also categorizes Desired Result Category Q.

Second, loops of association are not permitted. For example, if Desired Result Category P categorizes Desired Result Category Q, then neither Desired Result Category Q nor any of its descendants in 'categorizes' associations may categorize Desired Result Category P or any of its ancestors in 'categorizes' associations.

Tools that support BMM should ensure that these constraints are enforced.

9 BMM Concepts Catalog

This chapter presents the full Concepts Catalog for the BMM as a business vocabulary represented in SBVR Structured English, which is described in the OMG's specification for [SBVR](#).

In SBVR Structured English, the simple passive form of a verb phrase is assumed. A synonymous form for the reverse reading is needed only if the simple passive form is not used. E.g., given 'business policy governs business process,' 'business process is governed by business policy' is implied. But 'business rule is derived from business policy' is included as an explicit synonymous form for 'business policy is basis for business rule.'

9.1 Concepts

assessment

General Concept	motivation element
Definition	judgment that an influencer affects the employment of means and/or the achievement of ends
Note	An assessment expresses a logical connection between influencers and the ends and/or means of the business plans.
Dictionary Basis	to analyze critically and judge definitively the nature, significance, status, or merit of: determine the importance, size, or value of [MWUD 'assess' (4)]
Note	If an assessment is related to both a means and an end, then this suggests that the particular means is somehow related to the particular end. Specifically, if there is not a fact relating them — such as 'course of action channels efforts towards desired result' or 'directive supports achievement of desired result' — then careful consideration should be given to that omission.

assessment expresses impact of influencer on end or means

Necessity	Each assessment expresses impact of at least one influencer on at least one end or at least one means
-----------	-----------------------------------------------------------------------------------------------------------------------------------------------------------------------

assessment affects achievement of end

Synonymous Form	end has achievement affected by assessment
-----------------	----------------------------------------------------------------------------

assessment affects employment of means

Synonymous Form	means has employment affected by assessment
-----------------	-----------------------------------------------------------------------------

assessment is judgment of influencer

Synonymous Form	influencer is judged in assessment
-----------------	--------------------------------------------------------------------

assessment provides impetus for directive

Synonymous Form	directive is motivated by assessment
-----------------	----------------------------------------------------------------------

assessment identifies potential impact

Synonymous Form	potential impact is significant to assessment
Necessity	Each assessment identifies at least one potential impact

using assessment

General Concept [assessment](#)
Concept Type [role](#)

used assessment

General Concept [assessment](#)
Concept Type [role](#)

using assessment uses used assessment

assessment category

General Concept [motivation element](#)
Definition category of [assessment](#)
Dictionary Basis a class or division of people or things regarded as having particular shared characteristics [ODE, 'category' 1]
Note Annex G describes a set of categories of assessment, based on the widely-used SWOT (Strength, Weakness, Opportunity, Threat) approach, which is suggested as a default.

assessment category categorizes assessment

broader assessment category

General Concept [assessment category](#)
Concept Type: [role](#)

narrower assessment category

General Concept [assessment category](#)
Concept Type: [role](#)

broader assessment category categorizes narrower assessment category

asset

General Concept [motivation element](#)
Definition something of value owned by the enterprise
Note An [asset](#) is an actual thing (tangible or intangible) owned by the enterprise, rather than the accounting sense of "asset" - the monetary value of the thing.
Note Categories of [asset](#) are: [fixed asset](#), [resource](#).
Dictionary Basis an item of value owned [MWUD 'asset' 3]

business policy

Definition [directive](#) **that** is concerned with directly controlling, influencing, or regulating the actions of an enterprise and the people in it **and that** is not directly enforceable
Dictionary Basis a definite course or method of action selected (as by a government, institution, group, or individual) from among alternatives and in the light of given conditions to guide and usually determine present and future decisions [MWUD 'Policy' {5a}]
Note The purpose of a business policy is to govern or guide the enterprise. The formulation of a business policy is under an enterprise's control by a party authorized to manage, control, or regulate the enterprise, by selection from alternatives in response to a combination of assessments.

- Note 'Not directly enforceable' means that some interpretation of the directive (e.g. in business rules) is needed in order to detect violations.
- Note Compared to a business rule, a business policy tends to be: less structured; less discrete; less atomic; less compliant with standard business vocabulary; less formally articulated.

business policy is basis for business rule

Synonymous Form [business rule is derived from business policy](#)

business policy governs business process

broader business policy

General Concept [business policy](#)
 Concept Type [role](#)

more specific business policy

General Concept [business policy](#)
 Concept Type [role](#)

broader business policy includes more specific business policy

Synonymous Form: [more specific business policy is included in broader business policy](#)

business process

- General Concept [motivation element](#)
- Note The concept 'business process' is adopted from the OMG's Business Process Modeling and Notation (BPMN) specification. The placeholder definition is given below.
- Definition a sequence or flow of Activities in an organization with the objective of carrying out work
- Source: [BPMN](#) (10) ['Process']
- Note Processes can be defined at any level from enterprise-wide Processes to Processes performed by a single person (from BPMN clause 10, Process)
- Note An Activity is work that is performed within a Business Process. The types of Activities that are a part of a Process are: Task, Sub-Process, and Call Activity, which allows the inclusion of re-usable Tasks and Processes (from BPMN clause 10.2, Activities)



business process delivers offering

business process manages asset

business process realizes course of action

business rule

- Definition [directive](#) that is practicable
- Definition SBVR: rule that is under business jurisdiction
- Dictionary Basis one of a set of explicit or understood regulations or principles governing conduct or procedure within a particular area of activity; a law or principle that operates within a particular sphere of knowledge, describing or prescribing what is possible or allowable standard on which a judgment or decision may be based [ODE "rule"]

Note	<p>‘Practicable’ means that a person who understands a directive could observe a relevant situation (including his or her own behavior) and recognize directly whether or not the business was complying with that directive.</p> <p>For rules that govern activity (SBVR ‘operative business rule’) this recognition is about the behavior of people and what form compliant behavior takes. For example: “each rental must be guaranteed by a valid credit card held by the renter of the rental”</p> <p>For definitional rules (SBVR ‘structural business rule’) this recognition is about evaluation of the criteria vested in the rule to produce consistent outcomes for decisions or calculations. For example: “a car model requested for a rental must be a car model of the car group specified for the rental”.</p>
Note	A rule is a claim of obligation or necessity
Note	A business rule is: highly structured; discrete; atomic; carefully expressed in terms of standard vocabulary.

business rule guides business process

course of action

Definition	means that is an approach or plan for configuring some aspect of the enterprise involving things, processes, locations, people, timing, or motivation undertaken to achieve ends
Note	Categories of course of action include: strategy , tactic
Dictionary Basis	a mode of action; “if you persist in that course you will surely fail,” “once a nation is embarked on a course of action it becomes extremely difficult for any retraction to take place” [www.dictionary.com - Source: WordNet® 2.0 'course of action']
Dictionary Basis	a chosen manner of conducting oneself: way of acting “our wisest course is to retreat” [MWCD 'course' (3b)]

course of action channels efforts towards desired result

Synonymous Form	desired result <i>is supported by</i> course of action
-----------------	----------------------------------------------------------------------------------------

course of action deploys asset

Definition	the course of action determines which assets will be used and how they will be used in realizing the course of action
------------	-----------------------------------------------------------------------------------------------------------------------------------------------------------------------

course of action discharges liability

Definition	the course of action ensures that the commitment for which the liability claims resources is met
------------	------------------------------------------------------------------------------------------------------------------

course of action is formulated based on directive

Synonymous Form:	directive <i>is source of</i> course of action
------------------	--------------------------------------------------------------------------------

broader course of action

General Concept	course of action
Concept Type	role

more specific course of action

General Concept	course of action
Concept Type	role

broader course of action *includes* more specific course of action

Synonymous Form: more specific course of action *is included in* broader course of action

enabling course of action

General Concept course of action
Concept Type role

enabled course of action

General Concept course of action
Concept Type role

enabling course of action *enables* enabled course of action

desired result

Definition end that is a state or target that the enterprise intends to maintain or sustain
Dictionary Basis a favorable outcome of an undertaking or contest [ODE 'result' (bullet 1)]
Note Categories of desired result include: goal, objective.

broader desired result

General Concept desired result
Concept Type role

more specific desired result

General Concept desired result
Concept Type role

broader desired result *includes* more specific desired result

Synonymous Form: more specific desired result *is included in* broader desired result
Necessity more specific desired result and broader desired result are of the same type.
Note Specifically, goals may include (sub)goals, and objectives may include (sub)objectives.
Necessity no goal includes objectives
Necessity no objective includes goals
Note goal and objective are related via a separate, distinct fact type quantifies / is quantified by.

desired result category

General Concept category of assessment
Dictionary Basis: a class or division of people or things regarded as having particular shared characteristics ODE ['category 1']

desired result category *categorizes* desired result

broader desired result category

broader desired result category

General Concept: desired result category
Concept Type: role

more specific desired result category

General Concept: desired result category

Concept Type: [role](#)

broader desired result category *categorizes* more specific desired result

directive

Definition: [means](#) that defines or constrains some aspect of an enterprise
Synonym: [element of guidance](#) [Source: **SBVR**]
Note: A directive is intended to assert business structure or to control or influence the behavior of the enterprise.
Note: Categories of [directive](#) include: [business policy](#), [business rule](#).
Dictionary Basis: an official or authoritative instruction [ODE 'directive']

directive acts as regulation

Synonymous Form: [regulation is a role played by directive](#)
Note: A [business policy](#) or [business rule](#) made by senior management may be obeyed as regulation lower down in the organization.

directive supports achievement of desired result

Synonymous Form: [desired result has achievement supported by directive](#)

directive governs course of action

directive governs use of asset

Synonymous Form: [asset has use governed by directive](#)
Definition: [the course of action governs use of the asset](#) regardless of which [courses of action deploy the asset](#)

end

General Concept: [motivation element](#)
Definition: something that is to be accomplished.
Dictionary Basis: an outcome worked toward especially with forethought, deliberate planning, and organized effort [MWUD 'end' (4a)]
Note: Categories of [end](#) include: [vision](#); [desired result](#)

end is impacted by influencer

Note: The potential impacts of [influencers](#) on an [end](#) are expressed in [assessments](#).

fixed asset

[asset](#) that is maintained over time and reused
Example: Production equipment, IT equipment, buildings, vehicles.
Example: Patents, brands, licenses, designs, people's skills.
Dictionary Basis: tangible assets (as land, buildings, machinery, equipment) of a permanent or long-term nature [MWUD, 'fixed assets']
Dictionary Basis: long-term assets either tangible or intangible (as land, buildings, patents, or franchises) [MWUD, 'capital assets']

fixed asset provides resource

Note	Some fixed assets provide resources as capacity that is available over time, e.g., production equipment, buildings, people's skills. These are usually tangible, but could be, for example, software licenses that limit the number of concurrent users.
Note	Some intangible fixed assets, such as patents, designs, specifications and brands, are not limited by capacity and can be used wherever and whenever needed.

goal

Definition	<u>end</u> that is a state or condition of the enterprise to be brought about or sustained through appropriate means
Dictionary Basis	the end toward which effort or ambition is directed [MWUD 'goal' (2)]
Dictionary Basis	the object of a person's ambition or effort; an aim or desired result [ODE 'goal' (2)]
Note	Compared to an <u>objective</u> , a <u>goal</u> tends to be: ongoing; qualitative (rather than quantitative); general (rather than specific); longer term.

goal amplifies vision

Necessity	Each <u>goal amplifies</u> at most one <u>vision</u> .
-----------	--------------------------------------------------------

influencer

General Concept	<u>motivation element</u>
Definition	something that has the capability of producing an effect without apparent exertion of tangible force or direct exercise of command, and often without deliberate effort or intent
Dictionary Basis	the capacity to have an effect on the character, development, or behavior of someone or something, or the effect itself [NODE 'influence' (1)]
Note	Categories of <u>influencer</u> include: <u>external influencer</u> ; <u>internal influencer</u>

external influencer

Definition	<u>influencer</u> outside an enterprise's organizational boundaries that can impact its employment of <u>means</u> or achievement of <u>ends</u>
Note	Categories of external influencer might include: <u>competitor</u> ; <u>customer</u> ; <u>environment</u> ; <u>partner</u>

internal influencer

Definition	<u>influencer</u> from within an enterprise that can impact its employment of <u>means</u> or achievement of <u>ends</u>
Note	Categories of internal influencer might include: <u>assumption</u> ; <u>corporate value</u> ; <u>habit</u> ; <u>infrastructure</u> ; <u>issue</u> , <u>management prerogative</u> , <u>resource</u>

influencer has effect on end or means judged in assessment

influencer category

General Concept	<u>motivation element</u>
Definition	category of <u>influencer</u>
Dictionary Basis	a class or division of people or things regarded as having particular shared characteristics [ODE, 'category' (1)]
Note	Annex G describes a set of categories of influencer, recommended as a default set.

influencer category categorizes influencer

broader influencer category

General Concept [assessment category](#)

Concept Type: [role](#)

narrower influencer category

General Concept [assessment category](#)

Concept Type: [role](#)

broader influencer category categorizes narrower influencer category

influencing organization

General Concept [motivation element](#)

Definition organization that is external to the enterprise modeled in a given [enterprise BMM](#), and that influences that enterprise

influencing organization is source of influencer

Synonymous Form: [influencer is from influencing organization](#)

liability

General Concept [motivation element](#)

Definition reservation of some resource to meet commitments

Note A liability is a reservation of actual resources (materials, finished goods, people's time, cash, etc.) to meet commitments, rather than the accounting sense of "liability" - the monetary value of these resources.

Dictionary Basis something for which one is liable: as (1): an amount that is owed whether payable in money, other property, or services [MWUD]

means

General Concept [motivation element](#)

Definition device, capability, regime, technique, restriction, agency, instrument, or method that may be called upon, activated, or enforced to achieve [ends](#)

Dictionary Basis an action or system by which a result is brought about; a method [ODE 'means' (1)]

Note Categories of [means](#) include: [mission](#); [course of action](#); [directive](#)

means is impacted by influencer

Note Impact of influencer on means is expressed in assessments.

mission

Definition [means](#) that is the ongoing operational activity of an enterprise

Dictionary Basis the chief function or responsibility of an organization or institution [MWUD 'mission' (4b)]

mission makes operative vision

Necessity Each [mission makes operative at most one vision](#).

mission is planned by means of strategy

Synonymous Form: strategy *is a component of the plan for* mission

objective

Definition	end that is a specific time-targeted, measurable, attainable target that an enterprise seeks to meet in order to achieve its goals
Dictionary Basis	something toward which effort is directed: an aim or end of action [MWUD 'objective' (1)]
Note	Compared to a goal , an objective is: short-term; not continuing beyond its time frame (although such time frames can be cyclical – monthly, quarterly, etc.).

objective quantifies goal

Definition	objectives provide the basis for measures to determine that progress is being made towards a goal .
------------	-------------------------------------------------------------------------------------------------------------------------------------

offering

Definition	fixed asset that is a specification of a product or service that can be supplied by the enterprise
Note	Instances of offerings, such as finished goods, are a kind of resource.
Dictionary Basis	a thing produced for entertainment or sale [ODE, 'offering' 2nd bullet]
Dictionary Basis	to make available or accessible [MWUD, 'offer' 5]

offering requires resource

Definition	The resource is required for making and delivering instances of the offering
------------	--------------------------------------------------------------------------------------------------------------

offering uses fixed asset

Note	An offering may use an intangible fixed asset, such as a patent, design, license, or brand. This is different from the resources required to make and deliver the offering - see ' offering requires resource '.
------	----------------------------------------------------------------------------------------------------------------------------------------------------------------------------------------------------------------------------------

organization category

General Concept	motivation element
Definition	category of influencing organization
Dictionary Basis	a class or division of people or things regarded as having particular shared characteristics [ODE, 'category' (1)]

organization category categorizes influencing organization

broader organization category

General Concept	assessment category
Concept Type:	role

narrower organization category

General Concept	assessment category
Concept Type:	role

broader organization category categorizes narrower organization category

organization unit

General Concept	motivation element
Definition	An administrative or functional unit within an organization structure.



Example:	Within a formal organization structure, organization units might be: the corporation, business units, divisions, departments, groups, teams, or individual roles. Less formally, they might be committees, projects, or task forces.
Note	BPMN includes the concept 'Performer' (the resource that will perform or will be responsible for an Activity) which corresponds to an organization unit's having responsibility for a business process. In BPMN: <ul style="list-style-type: none"> a. A Performer can be specified in the form of a specific individual, a group, an organization role or position, or an organization b. An Activity is work that is performed within a Business Process. See 'business process', above.
Dictionary Basis	a group of people that has a more or less constant membership, a body of officers, a purpose, and usually a set of regulations [MWUD 'organization' (2a)]

organization unit acts as influencing organization

organization unit makes assessment

Necessity Each assessment is made by at least one organization unit.

organization unit defines end

Necessity Each end is defined by at least one organization unit.

organization unit establishes means

organization unit is responsible for asset

Synonymous Form: asset is responsibility of organization unit

organization unit is responsible for liability

Synonymous Form: liability is responsibility of organization unit

organization unit is responsible for business process

Synonymous Form business process is responsibility of organization unit

organization unit recognizes influencer

potential impact

General Concept motivation element
Definition evaluation that quantifies or qualifies an assessment in specific terms, types, or dimensions
Note Categories of potential impact include: potential reward; risk.

potential impact provides impetus for directive

Synonymous Form directive is motivated by potential impact

potential reward

Definition potential impact that indicates the probability of gain
Dictionary Basis something that is given in return for good or evil done or received and especially that is offered or given for some service or attainment [MWUD 'Reward' (1)]
Note Some Potential Rewards are expressible as formulae, for example:

Probability of gain (e.g., 30% probability)
Potential gain (e.g., \$40,000 gain)
Unit of measure (e.g., gain in USD)

regulation

Definition influencer that is an order prescribed by an authority such as a government body or the management of an enterprise
Dictionary Basis a rule or directive made and maintained by an authority [ODE 'regulation' (1)]
Dictionary Basis a rule or order having the force of law issued by an executive authority of a government [MWUD: 'regulation' (2b)].

resource

Definition asset that is consumed in the operations of the enterprise and replenished
Example: Raw materials, parts, finished goods, cash.
Example: Some resources are capacity of fixed assets over time; for example production capacity, storage space, people's time - they are consumed, or dissipated by not being used.
Dictionary Basis a stock or supply of money, materials, staff, and other assets that can be drawn on by a person or organization in order to function effectively [ODE]
Dictionary Basis assets of a short-term nature (as cash, accounts receivable, or merchandise) [MWUD, 'current asset']

risk

Definition potential impact that indicates the possibility of loss, injury, disadvantage, or destruction
Dictionary Basis the possibility of loss, injury, disadvantage, or destruction [MWUD 'risk' (1)]
Note Some Risks are expressible as formulae.
Probability of loss. (e.g., 5% probability)
Potential loss (e.g., \$500,000 loss)
Unit-of-measure (e.g., loss in USD)

strategy

Definition course of action that is an element of a plan devised through the science and art of business leadership exercised to ensure the most advantageous conditions
Dictionary Basis the science and art of military command exercised to meet the enemy in combat under advantageous conditions [MWUD 'strategy' (1a2)]
Dictionary Basis a careful plan or method or a clever stratagem [MWUD 'strategy' (2a)]
Note Compared to a tactic, a strategy tends to be: longer term; broader in scope.

strategy determines organization unit

tactic

Definition course of action that is a device or expedient to be employed as part of a strategy
Note Compared to a strategy, a tactic tends to be:
• shorter term
• narrower in scope
Dictionary Basis a device or expedient for accomplishing an end [MWUD 'tactics' (2b)]

Dictionary Basis a plan scheme or trick with a particular aim [ODE 'device' (2)]

tactic effects enforcement level of business rule

Synonymous Form business rule has enforcement level effected by tactic

Note Only business rules that guide behavior (SBVR 'operative business rule') require enforcement. Definitional business rules (SBVR 'structural business rule') are "true by definition".

tactic implements strategy

vision

Definition end that is about the future state of the enterprise, without regard to how it is to be achieved

Dictionary Basis a mental image of what the future will or could be like [NODE 'vision' (2), bullet 1]

9.2 Attributes

motivation element

Definition top-level concept in BMM

Note Created as a modeling construct (a "superclass") to simplify the association of each concept in BMM with 'name' and 'description.'

Note Categories of motivation element include: assessment, business process, end, influencer, means, organization unit, potential impact, influencer category, influencing organization, organization category, assessment category, asset, liability

motivation element has motivation element description

Synonymous Form motivation element description is of motivation element

motivation element has motivation element name

Synonymous Form: motivation element name is of motivation element

motivation element description

Definition an account of a concept in an enterprise BMM

Dictionary Basis a spoken or written account of a person, object, or event [ODE 'description' (1)]

motivation element name

Definition a word or set of words by which a concept in an enterprise BMM is known or referred to

Dictionary Basis a word or set of words by which a person, animal, place, or thing is known, addressed, or referred to [ODE 'name' (1)]

9.3 Additional Vocabulary

enterprise BMM

Definition BMM for an enterprise

Example BMM for EU-Rent

Example BMM for EU-Rent UK Service Depots.

BMM

Definition

The Business Motivation Model defined in this specification, as a metamodel,

Synonym

The Business Motivation Model

9.4 Mapping of SBVR Structured English fact types to UML Association Names

BMM concept names are represented in the UML model of BMM in “CamelCase.” Each word of the concept name (as given in SBVR Structured English) begins with a capital letter, and there are no spaces between words. For example, [course of action](#) is represented in the UML model as CourseOfAction.

Each noun concept in the BMM Concepts Catalog is represented as a class in the UML model, with its name in CamelCase.

Most fact types (verb concepts) in the BMM Concepts Catalog are represented as associations in the UML model. Association names are formed by:

- Selecting the active form of the verb in the verb concept, e.g., *implements* rather than *is implemented by*.
- Using the whole verb concept representation in CamelCase, e.g., [tactic implements strategy](#) is represented by the association TacticImplementsStrategy.

The exception is ‘category of’ (specialization) fact types, such as “objective is a category of desired result” which are often embedded in definitions and not explicitly named in SBVR Structured English. They are shown on the UML model as un-named generalization-specialization associations.

The following table provides the complete mapping.

BMM fact type in SBVR Structured English	UML Association Name
assessment affects achievement of end	AssessmentAffectsAchievementOfEnd
assessment affects employment of means	AssessmentAffectsEmploymentOfMeans
assessment identifies potential impact	AssessmentIdentifiesPotentialImpact
assessment is judgment of influencer	AssessmentsJudgmentOfInfluencer
assessment provides impetus for directive	AssessmentProvidesImpetusForDirective
assessment category categorizes assessment	AssessmentCategoryCategorizesAssessment
broader assessment category categorizes more specific assessment category	BroaderAssessmentCategoryCategorizesNarrowerAssessmentCategory
broader business policy includes more specific business policy	BroaderBusinessPolicyIncludesMoreSpecificBusinessPolicy
broader course of action includes more specific course of action	BroaderCourseOfActionIncludesMoreSpecificCourseOfAction
broader desired result includes more specific desired result	BroaderDesiredResultIncludesMoreSpecificDesiredResult
broader desired result category includes more specific desired result category	BroaderDesiredResultCategoryIncludesMoreSpecificDesiredResultCategory
broader influencer category categorizes more specific influencer category	BroaderInfluencerCategoryCategorizesNarrowerInfluencerCategory
broader organization category categorizes more specific organization category	BroaderOrganizationCategoryCategorizesNarrowerOrganizationCategory





business policy <i>governs</i> business process	BusinessPolicyGovernsBusinessProcess
business policy <i>is basis for</i> business rule	BusinessPolicyIsBasisForBusinessRule
business process <i>delivers</i> offering	BusinessProcessDeliversOffering
business process <i>manages</i> asset	BusinessProcessManagesAsset
business process <i>realizes</i> course of action	BusinessProcessRealizesCourseofAction
business rule <i>guides</i> business process	BusinessRuleGuidesBusinessProcess
course of action <i>channels efforts towards</i> desired result	CourseofActionChannelsEffortsTowardsDesiredResult
course of action <i>defines</i> offering	CourseOfActionDefinesOffering
course of action <i>deploys</i> asset	CourseOfActionDeploysAsset
course of action <i>discharges</i> liability	CourseOfActionDischargesLiability
course of action <i>is formulated based on</i> directive	CourseOfActionIsFormulatedBasedOnDirective
desired result category <i>categorizes</i> desired result	DesiredResultCategoryCategorizesDesiredResult
directive <i>acts as</i> regulation	DirectiveActsAsRegulation
directive <i>governs use of</i> asset	DirectiveGovernsUseOfAsset
directive <i>governs</i> course of action	DirectiveGovernsCourseOfAction
directive <i>supports achievement of</i> desired result	DirectiveSupportsAchievementOfDesiredResult
enabling course of action <i>enables</i> enabled course of action	EnablingCourseOfActionEnablesEnabledCourseOfAction
fixed asset <i>provides</i> resource	FixedAssetProvidesResource
goal <i>amplifies</i> vision	GoalAmplifiesVision
influencer category <i>categorizes</i> influencer	InfluencerCategoryCategorizesInfluencer
influencing organization <i>is source of</i> influencer	InfluencingOrganizationIsSourceOfInfluencer
liability <i>claims</i> resource	LiabilityClaimsResource
mission <i>makes operative</i> vision	MissionMakesOperativeVision
objective <i>quantifies</i> goal	ObjectiveQuantifiesGoal
offering <i>requires</i> resource	OfferingRequiresResource
offering <i>uses</i> fixed asset	OfferingUsesFixedAsset
organization unit <i>acts as</i> influencing organization	OrganizationUnitActsAsInfluencingOrganization
organization category <i>categorizes</i> influencing organization	OrganizationCategoryCategorizesInfluencingOrganization
organization unit <i>defines</i> end	OrganizationUnitDefinesEnd
organization unit <i>establishes</i> means	OrganizationUnitEstablishesMeans
organization unit <i>is responsible for</i> asset	OrganizationUnitIsResponsibleForAsset
organization unit <i>is responsible for</i> business process	OrganizationUnitIsResponsibleForBusinessProcess
organization unit <i>is responsible for</i> liability	OrganizationUnitIsResponsibleForLiability
organization unit <i>makes</i> assessment	OrganizationUnitMakesAssessment

organization unit recognizes influencer	OrganizationUnitRecognizesInfluencer
potential impact provides impetus for directive	PotentialImpactProvidesImpetusForDirective
strategy determines organization unit	StrategyDeterminesOrganizationUnit
strategy is a component of the plan for mission	StrategyIsAComponentOfThePlanForMission
tactic effects enforcement level of business rule	TacticEffectsEnforcementLevelOfBusinessRule
tactic implements strategy	TacticImplementsStrategy
using assessment uses used assessment	UsingAssessmentUsesUsedAssessment

9.5 Mapping of SBVR Structured English Fact Types to UML Role Names

In the BMM Concepts Catalog, role names are defined for fact types in which both roles are played by the same noun concept e.g., [broader business policy includes more specific business policy](#). They are used in the corresponding association names in the BMM UML/MOF model, and represented in CamelCase, except that the first letter is in lower case e.g., [broader business policy](#) maps to broaderBusinessPolicy.

For other fact types, UML role names have been constructed using the verb and the noun concept term e.g., [tactic implements strategy](#) maps to the UML role names implementingTactic and implementedStrategy.

The following table provides the complete mapping.

BMM fact type in SBVR Structured English	'From' Role	'To' Role
assessment affects achievement of end	judgingAssessment	affectedEnd
assessment affects employment of means	judgingAssessment	affectedMeans
assessment identifies potential impact	identifyingAssessment	identifiedPotentialImpact
assessment is judgment of influencer	judgingAssessment	judgedInfluencer
assessment provides impetus for directive	motivatingAssessment	motivatedDirective
assessment category categorizes assessment	categorizingAssessmentCategory	categorizedAssessment
broader assessment category categorizes more specific assessment category	broaderAssessmentCategory	narrowerAssessmentCategory
broader business policy includes more specific business policy	broaderBusinessPolicy	moreSpecificBusinessPolicy
broader course of action includes more specific course of action	broaderCourseOfAction	moreSpecificCourseOfAction
broader desired result includes more specific desired result	broaderDesiredResult	moreSpecificDesiredResult
broader influencer category categorizes more specific influencer category	broaderInfluencerCategory	narrowerInfluencerCategory
broader organization category categorizes more specific organization category	broaderOrganizationCategory	narrowerOrganizationCategory
business policy governs business process	governingBusinessPolicy	governedBusinessProcess
business policy is basis for business rule	baseBusinessPolicy	derivedBusinessRule
business process delivers offering	deliveringBusinessProcess	deliveredOffering

business process <i>manages</i> asset	managingBusinessProcess	managedAsset
business process <i>realizes</i> course of action	realizingBusinessProcess	realizedCourseOfAction
business rule <i>guides</i> business process	guidingBusinessRule	guidedBusinessProcess
course of action <i>channels efforts towards</i> desired result	supportingCourseOfAction	supportedDesiredResult
course of action <i>defines</i> offering	definingCourseOfAction	definedOffering
course of action <i>deploys</i> asset	deployingCourseOfAction	deployedAsset
course of action <i>discharges</i> liability	dischargingCourseOfAction	dischargedLiability
course of action <i>is formulated based on</i> directive	derivedCourseOfAction	baseDirective
directive <i>acts as</i> regulation	regulatingDirective	directiveRegulation
directive <i>governs</i> course of action	governingDirective	governedCourseOfAction
directive <i>governs use of</i> asset	governingDirective	governedAsset
directive <i>supports achievement of</i> desired result	supportingDirective	supportedDesiredResult
enabling course of action <i>enables</i> enabled course of action	enablingCourseOfAction	enabledCourseOfAction
fixed asset <i>provides</i> resource	providingFixedAsset	providedResource
goal <i>amplifies</i> vision	amplifyingGoal	amplifiedVision
influencer category <i>categorizes</i> influencer	categorizingInfluencerCategory	categorizedInfluencer
influencing organization <i>is source of</i> influencer	sourceInfluencingOrganization	providedInfluencer
liability <i>claims</i> resource	claimingLiability	claimedResource
mission <i>makes operative</i> vision	deliveringMission	operativeVision
objective <i>quantifies</i> goal	quantifyingObjective	quantifiedGoal
offering <i>requires</i> resource	requiringOffering	requiredResource
offering <i>uses</i> fixed asset	usingOffering	usedFixedAsset
organization category <i>categorizes</i> influencing organization	categorizingOrganizationCategory	categorizedInfluencingOrganization
organization unit <i>acts as</i> influencing organization	influencingOrganizationUnit	internalInfluencingOrganization
organization unit <i>defines</i> end	definingOrganizationUnit	definedEnd
organization unit <i>establishes</i> means	establishingOrganizationUnit	establishedMeans
organization unit <i>is responsible for</i> asset	responsibleOrganizationUnit	managedAsset
organization unit <i>is responsible for</i> business process	responsibleOrganizationUnit	managedBusinessProcess
organization unit <i>is responsible for</i> liability	responsibleOrganizationUnit	managedLiability
organization unit <i>makes</i> assessment	assessingOrganizationUnit	madeAssessment
organization unit <i>recognizes</i> influencer	recognizingOrganizationUnit	recognizedInfluencer
potential impact <i>provides impetus for</i> directive	motivatingPotentialImpact	motivatedDirective
strategy <i>determines</i> organization unit	determiningStrategy	determinedOrganizationUnit
strategy <i>is a component of the plan for</i> mission	missionComponent	plannedMission

tactic effects enforcement level of business rule

effectingTactic

enforcedBusinessRule

tactic implements strategy

implementingTactic

implementedStrategy

using assessment uses used assessment

usingAssessment

usedAssessment

Annex A

BMM Diagram as Originally Published

(Informative)

This annex presents the BMM as published by the BRG on www.businessrulesgroup.org.

The graphic representation of the Business Motivation Model is based on three non-normative conventions, as follows. These conventions have been purposely kept neutral of any particular modeling notations. The BRG selected conventions that are largely self-explanatory and visually intuitive.

- **Box:** A box of any size represents a core concept. The name in the box is the preferred term (name) given to that concept. Refer to the Concepts Catalog for the precise meaning of each term.
- **Box-Within-A-Box:** This indicates categorization — in other words, a box within a box indicates that one concept is a category of the other concept. Another way to think about this is that the inner box represents a specific kind, type, class, or variation of the outside box.

This graphic representation of categories does not imply any constraints; specifically it does not imply that:

- The list of categories is mutual exclusive.
- The list of categories is exhaustive.
- Any category is mandatory.

When any of these constraints do apply, that fact is always documented explicitly in the Concepts Catalog.

- **Connection-Between-Boxes:** A line connecting any two boxes (or the same box twice) indicates a logical connection — that is, a fact type — between core concepts.

Crucial to any line is its labels. These labels are written carefully as verbs or verb phrases (in both directions) so that the logical connections of the Model can be read as simple English sentences. These sentences convey the exact meaning of the connections in the context of the Model; however, more explanation is given in the Concepts Catalog, along with the definitions for each of the terms involved.

This graphic representation of logical connections (fact types) does not imply any constraints; specifically it does not imply that:

- The logical connection is mandatory for any concept involved.
- Any upper or lower limits apply to the logical connection.

When any such constraint does apply, that fact is always documented explicitly in the Concepts Catalog. In the absence of such documented constraint, the connection lines can be taken to represent simple unconstrained fact types (i.e., ‘many-to-many’ and optional in both directions).

Two special conventions are worth noting.

- When a fact type involves three or more concepts, a simple line cannot be used to represent the fact type. In this case, the fact type is shown as a concept box, named with a term for the fact type (shown suffixed with *) and having unlabeled lines radiating from the box to the fact type’s participating concepts. One reading of the fact type is given in a Legend.

- A shaded (orange) box represents a concept that is related to concepts of the Model but this concept does not, itself, fall within the scope of the Model.

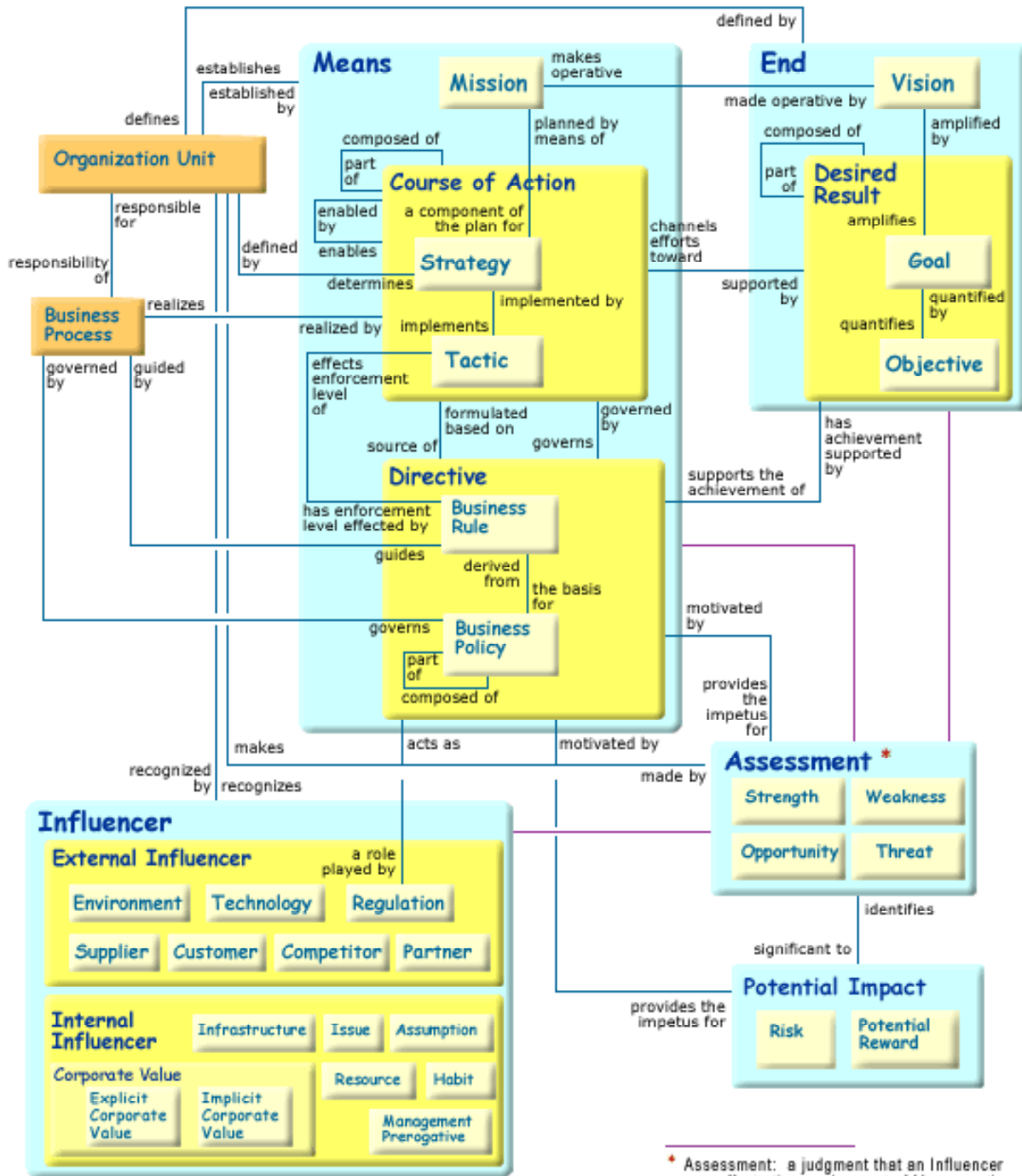

Annex B

Metrics for the BMM

(Informative)

Implicit in many areas of the Business Motivation Model is the subject of metrics. In almost all organizations there are ‘things of interest’ that are heavily measured and tracked.¹ These metrics govern, control, and influence a wide range of important aspects of the organization. The very fact these ‘things’ are so heavily measured makes them important.

Some of the most important metrics of an enterprise are established by its Goals. Each Goal can have one or more measures of performance. For example, a metric of the Goal “To be profitable” is the measure of performance ‘annual net revenue.’ Another measure of performance of this Goal might be ‘monthly net revenue.’

Some of the example Goals presented earlier have been extended below to illustrate measures of performance:

Table B.1 - Measures of performance

Enterprise	Goal	Measure(s) of Performance
EU-Rent	To provide industry-leading customer service.	market share
EU-Rent	To provide well-maintained cars.	quality of product
EU-Rent	To have vehicles available for rental when and where customers expect them.	usage %, order fulfillment
Pizza company	To deliver pizzas in an expedient amount of time.	elapsed time
Publishing company	To improve customer satisfaction (over the next five years).	customer satisfaction
Consulting company	To improve customer satisfaction (over the next five years).	customer satisfaction
e-Business company	To improve customer satisfaction (over the next five years).	market share

Objectives should always be measurable. Therefore Objectives, by definition, will have metrics. The metrics for an Objective are established by the measures of performance of the Goal that the Objective quantifies. To be able to do this, an appropriate unit-of-measure for the metric must be determined for each Objective. The Objective then expresses the target value that the metric should attain in the timeframe specified. In that way, while a Goal sets the direction, its corresponding Objectives set the milestones to be attained in pursuing the Goal. For example, to quantify the Goal "To be profitable" the enterprise might set one Objective to have a monthly net revenue of at least \$5 million (by a specified date) and another Objective to have an annual net revenue of at least \$100 million (by a specified date).

1. Rule management is outside of the scope of the Model; however, the enterprise should consider Business Rules to be one of the ‘things of interest’ that it carefully ‘measures and tracks’. Management of rules over time is important not only to performance assessment and improvement, but also addresses related issues, such as response to changes in Influencers.

Metrics are imperative for Potential Impacts. Without thoughtful and careful identification of appropriate metrics, the Risk / Potential Reward evaluation becomes meaningless.

If a metric is particularly important, it may attain a special status and be called a Key Performance Indicator (KPI) or a Critical Success Factor (CSF) — or something else. The choice of signifier is unimportant. The enterprise will decide on many different things to be measured². Each of these measurements will have differing degrees of importance relative to the attainment of some Objective or set of Objectives. The fact that the enterprise has decided to measure, evaluate, and act on the results of the metrics is the important thing.

2. In fact, if the Zachman Framework is used, it is possible to identify important 'things' to be measured in virtually every cell.

Annex C

Background for EU-Rent Examples

(Informative)

This annex provides an overview of the fictitious car rental company used for examples throughout the specification.

EU-Rent is a car rental company that operates in several countries in Western Europe and North America. In each of its countries of operation, EU-Rent has an operating company that defines a number of local areas in which it locates rental branches and service depots.

EU-Rent rents cars to customers, and offers standard models from major manufacturers. Car models are categorized into groups ranging from 'economy' to 'luxury,' with a different tariff for each group.

Rental branches do not own specific cars. Each local area owns a pool of cars that are available to the rental branches in the area. Each branch has an allocation (capacity, not actual cars) from the pool, which it uses to meet demand for rental bookings. If it exhausts its allocation it can request additional capacity, which is provided from a reserve pool on a 'first come, first served' basis.

Tariffs are set nationally. The operational rental business is managed mainly at the local area and branch level, with fairly strong national guidance on car purchase and disposal – what models can be purchased, how long to keep them, etc. – and global guidance on customer service and the EU-Rent brand.

EU-Rent accepts both rental bookings in advance and walk-in rentals. Advance bookings are accepted by phone, Internet, or in person in branches. An EU-Rent branch can accept a booking for pick-up at any EU-Rent branch world-wide.

EU-Rent is a medium-sized company catering to the general car rental market. It has two major concerns:

- It is facing increasing competition from companies offering lower rates, especially in vacation and resort areas.
- It sees opportunities for expansion as Eastern European countries enter the European Community, and business and trade increase.

In response, EU-Rent has decided to:

- Position itself in the market as a 'premium' brand, alongside the bigger players such as Hertz and Avis.
- Expand into Eastern Europe, focusing on major business centers.
- Target business renters, in two ways:
 - As individuals, offering convenient locations, high-quality service (value for money rather than lowest possible price), and an attractive loyalty rewards scheme for frequent renters.
 - As companies, offering corporate agreements in which discounted rental tariffs are offered in return for 'captive business.'

EU-Rent represents itself as environment-friendly and uses electric and LPG cars where suitable models are available.

Annex D

The BMM in the Context of the Zachman Architecture Framework

(Informative)

John Zachman has provided a useful context for discussing the architecture of an enterprise. His 'Framework for Enterprise Architecture' [ZACH] is a matrix that describes the various ways the stakeholders of an enterprise view the business and its systems.

The Framework characterizes architecture in terms of the perspectives of the different stakeholders (represented by rows in the matrix) and focuses on the different aspects (or 'abstractions') of architecture (represented by the columns). The rows represent, successively, the Planner, Owner, Designer, Builder, and Subcontractor perspectives. The columns reflect the abstractions dealing with the aspects of Data, Process, Location, Role, Timing, and Motivation (What, How, Where, Who, When, and Why).

The Business Motivation Model addresses the business Owner's perspective (i.e., row two) of the sixth aspect (i.e., the Motivation or 'Why' column)¹. Indeed, the name of the Model directly reflects this focus on motivation.

Also noteworthy is that the positioning of the Model in row two means that all references to Business Rules in the Model describe or prescribe elements involved in the structure and operation of the business — not its information systems or its technology.

D.1 Relationship to Other Aspects of the Business Model

As acknowledged at the beginning of this document and again just above, motivation is just one aspect of a complete business model. So, while every effort was made to limit the scope of the Model to this single abstraction, selective reference to elements of other abstractions were sometimes necessary — specifically, to concepts of the 'Who' and 'How' columns.

D.2 The 'Who' Connections

It is difficult to avoid references to 'Who' in discussions of 'Why.' Generally, it is not adequate to say, 'the motivation is that the company wants it that way.' This leads to the perpetuation of unnecessary rules — unnecessary either because the business requirement for them has passed, or because they were not Business Rules in the first place (e.g., they were imposed as workarounds in systems that did not fully support business needs).

Being able to pin down the motivation more precisely is essential. After all, if a responsible party cannot be found for a rule, it should probably be challenged. The Model therefore supports identifying those parties who play key roles with respect to motivation.

1. The BRG's 1995 paper [BRWATR] addressed the first and sixth aspects (that is, the data and motivation columns) from the Designer's perspective (that is, row three).

This capability is reflected in the Model by linking elements of the business plans to specific parts of the organization (i.e., its Organization Units). This has been done where the connection is important for developing, analyzing, challenging, and maintaining the business plans.

The Model uses the following definition for ‘organization’ on a provisional basis: “Any named group of people within the enterprise with a purpose and a budget.” An Organization Unit is simply an organization that is part of another organization.

These definitions should be considered merely placeholders². As stated in the main body of the document, ‘Organization Unit’ does not fall within the scope of the Model. In terms of the Framework, Organization Unit remains part of the ‘Who’ abstraction.

D.3 The 'How' Connections

To expand on the ‘being-doing’ relationships between Ends and Means, the ‘How’ column of the Framework needs to be considered. ‘How’ is specified as Business Processes.

It is widely recognized that Business Processes and Business Rules are closely related. It is important to be clear on the differences.

Business Processes realize Courses of Action – they provide detail of activities, plus sequencing, control, and synchronization that enable the enterprise to undertake its Courses of Action. Business Rules guide Business Processes – they provide the basis for decisions that need to be made within Business Processes.

Business Processes, Courses of Action, and Business Rules are all developed to help the enterprise reach its Goals. They need to be coherent and consistent. This is feasible if they are governed by a coherent and consistent set of Business Policies.

Business Processes are governed by Business Policies, which:

- Provide guidance (both directly and via Courses of Action) on what Business Processes have to do.
- Set limits on how Business Processes may undertake what they have to do.



‘Business Process’ in the Model is a placeholder for a concept adopted from the OMG’s Business Process Model and Notation (BPMN) specification.

Each Business Process is the responsibility of some Organization Unit (the process owner). There are other facts connecting Business Process and Organization Unit; for example, assignment of activities in Business Processes to roles in the organization is the basis of workflow. However, these connections are again outside the scope of the Model, and are appropriately addressed by some other standard(s).

D.4 Additional Aspects of the Business Model

The other abstractions of the Framework at row 2 are significant in a complete business model. For example,

- The ‘Where’ aspect — a Logistics Model identifying where the business will operate and how those locations are linked together. Such a model might also prescribe application of Business Rules in different places (including differences that need to be accommodated in globalization of the enterprise).

2. In 2006, the OMG issued an RFP for an Organization Structure Metamodel, from which a standard is expected to emerge by 2008.

- The ‘When’ aspect — an Event Model describing the events in the business cycle and how those events cause changes or activities in the enterprise.

In addition, all six abstractions of the Framework have potential interdependencies. For example, workflow to accomplish the same Ends may be different for different categories of location.

Annex E BMM History

(Informative)

E.1 Releases

The Business Motivation Model was developed by the Business Rules Group (BRG) and made freely available from the BRG web site (www.businessrulesgroup.org). There have been three releases: of the Business Motivation Model:

- Release 1.0 was published in November 2000 as “Organizing Business Plans ~ The Standard Model for Business Rule Motivation”
- Release 1.1, a general update in response to feedback from practice, was published in January 2005 under the revised title “The Business Motivation Model - Business Governance in a Volatile World”
- Release 1.2, some minor changes in response to OMG RFC requirements, was published in September 2005.

E.2 Release 1.0

E.2.1 Preface to Release 1.0

Background

In 1995, the Business Rules Group¹ (BRG), then under the auspices of GUIDE International published a seminal work, “Defining Business Rules ~ What Are They Really?” That document focused on understanding Business Rules from an information system perspective. That work provides key insights on the basic structure of Business Rules — that is, what Business Rules really are.

Since 1997, the BRG has focused its energies on understanding Business Rules from a business perspective. This in turn required a full, business-oriented understanding of how the elements of business plans should be organized. The BRG found that although many professionals have used planning methodologies over the years, no standard existed in that area, and many of the basic concepts were hazy and ad hoc. In particular, there was no inclusion of Business Rule in such approaches — a crucial omission.

This document presents the work of the BRG to correct these problems. It reflects the consensus of the BRG — and collectively the members’ many years of practical experience — about business planning. The BRG believes that business plans, especially as they relate to engineering business processes that include automated components, can and should be organized according to the elements of the Model presented in this document.

E.2.2 Organization of this Document

Note: this section is from the preface to the BRG paper describing release 1 of the Business Motivation Model. It describes that document, not the OMG specification of BMM

1. For more on the background and history of the BRG, refer to [BRGHIST]

This document centers on an explanation of the Model. It begins by describing two major topical areas and the role they play.

Section 2 describes the major concepts of the Model in broad terms — Ends and Means, Influences, and Assessments of those Influences on the Ends and Means.

Sections 3 and 4 are the heart of the document, presenting Model concepts in detail. As well as providing the concept descriptions that define the Model, these sections contain numerous examples.

Many of these examples are based on a (fictitious) car rental company, EU-Rent,² that continues the case study the BRG used in its earlier report. Although there are individual examples drawn from other sources, EU-Rent provides at least one example of every concept, within the context of a single organization. This provides some coherence across the examples and illustrates the relationships between many of the concepts.

The other examples were taken selectively from a wide set of enterprises. While the BRG used real-world samples as the basis for these examples, it discovered that real-world samples often do not conform exactly to the prescriptions for the various concepts presented in this document. The BRG found that the wording of these real-world statements is typically an amalgamation — using language designed for the consumption of vested audiences. Therefore, the samples have been reworded as appropriate for use with the Model. The BRG believes this is an important part of the value of its work.

Section 5 briefly discusses metrics in the context of the Model.

E.2.3 The Annexes

Annex A. The Model is included in graphic form in Annex A, which makes for handy reference.

Annex B. The real meaning of the concepts in the Model is in the concept definitions. These definitions are an integral part of the Model — indeed, the Model diagram is meaningless without them. Annex B contains all the definitions in the form of a Glossary of Definitions, which the BRG prefers to call the Concepts Catalog³.

Annex C. The Model is diagrammatically presented in this document using neutral, non-normative conventions. These conventions, explained in Annex C, are intended only for visual illustration of the Model's concepts and fact types.

Annex D. The document uses many examples from the EU-Rent case study, an overview of which is presented in Annex D.

Annex E. The positioning of the Model with respect to the Zachman Architecture Framework is discussed in Annex E, which also comments on other artifacts of business models, including Organization Unit and Business Process.

Annex F. A bibliography of relevant reference material is presented in Annex F.

E.2.4 Audiences for the Model

Who are the audiences for the Model? Primary audiences include the following:

- Developers of business plans. For that audience, the Model is a conceptual tool for engineering the business itself.

2. The EU-Rent case study was developed by John Hall of Model Systems.

3. “Semantics of Business Vocabulary and Business Rules” [SBVR] focuses on concepts, rather than merely on terms. Therefore the Group prefers the name ‘Concepts Catalog,’ rather than ‘Glossary of Definitions.’

- Analysts supporting the developers of business plans. For that audience, the Model is a tool for organizing and clarifying business plans.
- Implementers and users of software tools and repositories: For that audience, the Model is a formal scheme for structuring information about such business plans.

A final point is this. The BRG uses the word ‘enterprise’ in this document for convenience. The enterprise can be either for-profit or not-for-profit — similar concepts apply. Also, the ‘enterprise’ can be some subset of a larger enterprise; again, similar concepts should apply.

E.2.5 Participants in Release 1.0

Co-editors

- Ronald G. Ross, Business Rule Solutions LLC
- Keri Anderson Healy, Automated Reasoning Corp.

Contributors

- Allan B. Kolber, Butler Technology Solutions
- Cheryl K. Estep
- David C. Hay, Essential Strategies, Inc.
- Dennis Struck, DATA Engineering
- Gladys S.W. Lam, Business Rule Solutions LLC
- James D. Funk, S. C. Johnson
- John D. Healy, Automated Reasoning Corp.
- John Hall, Model Systems
- John A. Zachman, Zachman International
- Keri Anderson Healy, Automated Reasoning Corp.
- Michael Eulenberg, Owl Mountain
- Neal A. Fishman, Equifax, Inc.
- Ronald G. Ross, Business Rule Solutions LLC
- Terry Moriarty, Inastrol
- Warren L. Selkow

E.3 BMM Releases 1.1 and 1.2

E.3.1 Preface to Release 1.1

The time lapse between Release 1.0 and Release 1.1 of the Business Motivation Model is just over four years. The Model has shown remarkable stability during that period. This brief Preface to Release 1.1 identifies the relatively small number of updates and improvements to the Model that the Business Rules Group (BRG) has made. These changes were based on:

- application of the Model in actual practice.
- suggestions from various conferences and presentations in Europe and North America.
- world-wide feedback via the BRG's website.
- intense work starting in 2003 on "Semantics of Business Vocabulary and Business Rules" (SBVR), a response to an RFP produced by the Object Management Group (OMG) entitled "Business Semantics of Business Rules."

Perhaps the most notable changes in Release 1.1 are (a) the new name for the Model itself, "The Business Motivation Model," and (b) the new title of this document, "The Business Motivation Model ~ Business Governance in a Volatile World." The BRG received compelling arguments that the original name of the document, "Organizing Business Plans ~ The Standard Model for Business Rule Motivation," did not accurately reflect the purpose and content of the Model.

These arguments were centered on two main points:

- 'Business Plan' means many things to many people, and generally has broader connotations than the BRG intended. For example, "schedule of planned business activities" comes to mind for some people, whereas "proposed plan created to attract venture capital" comes to mind for others. Rather, the focus of the Model is on the elements of business governance (e.g., strategies, tactics, policies, goals, objectives, etc.); how these elements are inter-related; and what purposes they serve – i.e., their business motivation.
- Although the Model does address the business motivation for business rules – after all, business rules are certainly an element of business governance – including 'business rule' in the title of the document gave it a prominence that outweighed its actual role. In fact, as noted below, the Model does not even define Business Rule, but rather will adopt the definition from "Semantics of Business Vocabulary and Business Rules" (SBVR).

As mentioned above, the structure of the Model in Release 1.1 has changed very little from Release 1.0. The most significant adjustments involve sharpened definitions. For example, a dictionary basis has been added for each term in the Model. Beyond that, several concepts have been renamed, and several fact types have been added or revised. In addition, numerous examples have been added throughout the document.

The only new concept added to the Model is a placeholder for Business Process. The BRG has recognized the need to indicate how Business Process is related to the elements of the Model, and this placeholder permits it to do so. By placeholder, the BRG emphasizes that it is not suggesting any standard view of Business Process; instead, that it intends to defer to other standards activities for relevant definition(s). For example, work is currently being undertaken in the OMG to develop a standard Business Process Definition Metamodel (BPDM).

The final noteworthy adjustment in Release 1.1 is that an outside definition has been adopted for 'Business Rule.' As noted earlier, the focus of this document is on the elements of business governance and, in the Model, Business Rules are viewed as simply one such element. As in the case of the placeholder for Business Process, the adopted definition for Business Rule permits the BRG to indicate how Business Rules relate to other elements of the Model, but to defer to other standards activities for comprehensive definition and treatment.⁴

E.3.2 Preface to Release 1.2

In September 2005, the Object Management Group (OMG) voted to accept the Business Motivation Model as the subject of a Request for Comment (RFC). This means that the OMG is willing to consider the Business Motivation Model as a specification to be adopted by the OMG, subject to comment from any interested parties.

Adoption as an OMG specification carries the intention that the Business Motivation Model would, in time, be submitted to the International Standards Organization (ISO) as a standard.

One of the OMG's conditions for RFC acceptance was an explicit statement about attributes that would be required to be included in compliant implementations of the Business Motivation Model. This has been included in Section 1.4.

E.3.3 Participants in Releases 1.1 and 1.2

Co-editors:

- John Hall, Model Systems
- Keri Anderson Healy, Automated Reasoning Corp.
- Ronald G. Ross, Business Rule Solutions LLC

Contributors:

- Donald Chapin, Business Semantics Ltd
- Cheryl K. Estep
- John Hall, Model Systems
- John D. Healy, Automated Reasoning Corp.
- Keri Anderson Healy, Automated Reasoning Corp.
- Allan B. Kolber
- Ronald G. Ross, Business Rule Solutions LLC
- Markus Schacher, KnowGravity Inc.

4. For succinct discussion of the fundamental principles of the Business Rule approach, refer to [BRGMAN] available in a variety of languages, including: English, German, Dutch, French, and Turkish.

Annex F

Related OMG Business Modeling Specifications

(Informative)

F.1 Need for Integration

Business-oriented modeling in the OMG has been addressed by initiatives for several specifications independently and in parallel, with the intention of integrating them later. Compatibility between the developments is being handled informally in binary collaborations between submission teams.

This is different from the development of, for example, the UML, where all aspects of Platform Independent Models were developed as a coherent whole.

The OMG specifications of particular relevance to the Business Motivation Model are:

- Business Process Model and Notation (BPMN)
- Semantics of Business Vocabulary and Business Rules (SBVR)

These three need to be integrated because they are so closely related in business-oriented modeling.

A first step towards integration could be provision of simple cross-referencing in a Business Motivation Model for the enterprise. The minimum requirement would be:

- Reference schemes for Organization Unit, Business Process and Business Rule that supported unique identification of their instances.
- Availability of the references outside the tools that support Business Process Model and Notation (BPMN), Semantics of Business Vocabulary and Business Rules (SBVR) and the organization structure model used by the enterprise. Specifically, these references should be available to a tool that supports the Business Motivation Model.



F.2 Business Process Model and Notation (BPMN)

The fragment of the Business Motivation Model that addresses Business Process is illustrated below.

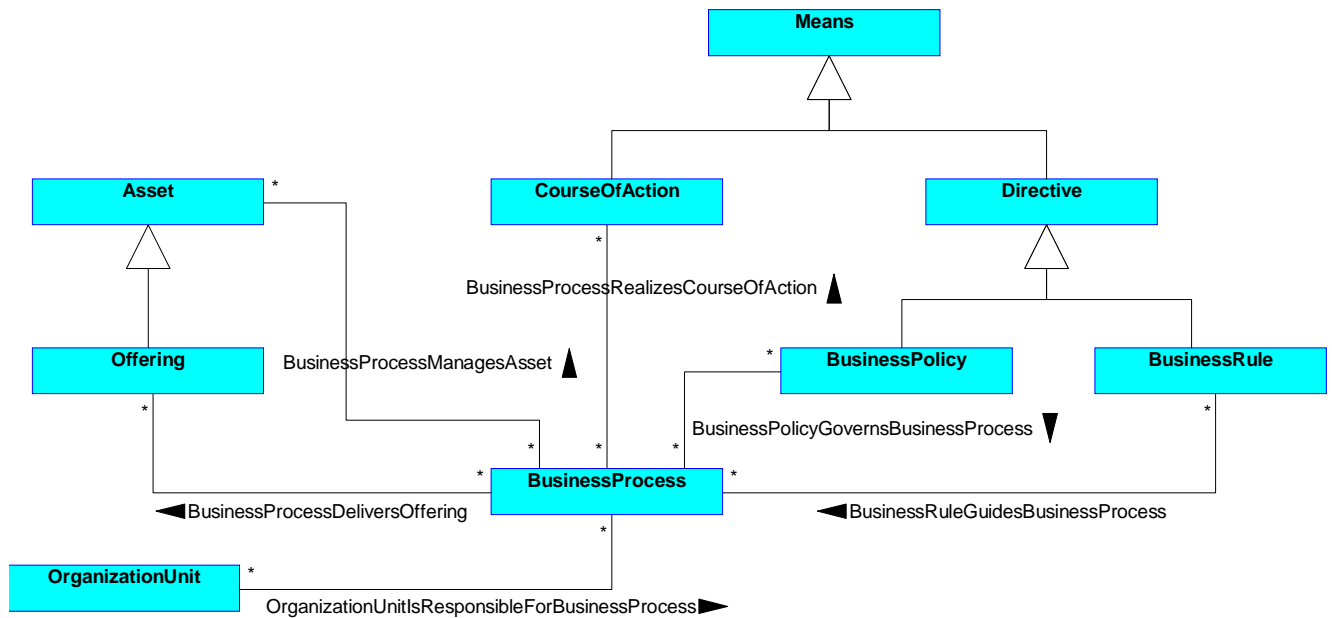

Figure F.1 - Business Process fragment of BMM



The concept 'Process' in the BPMN specification [BPMN] is adopted as BMM's definition of 'business process' (see Clause 9.1, above)

The concept 'Performer' in the BPMN specification [BPMN] corresponds in BMM to organization unit's role as being responsible for business process.

F.3 Semantics of Business Vocabulary and Business Rules (SBVR)

The fragment of the Business Motivation Model that addresses Business Rule and Business Policy is illustrated below.

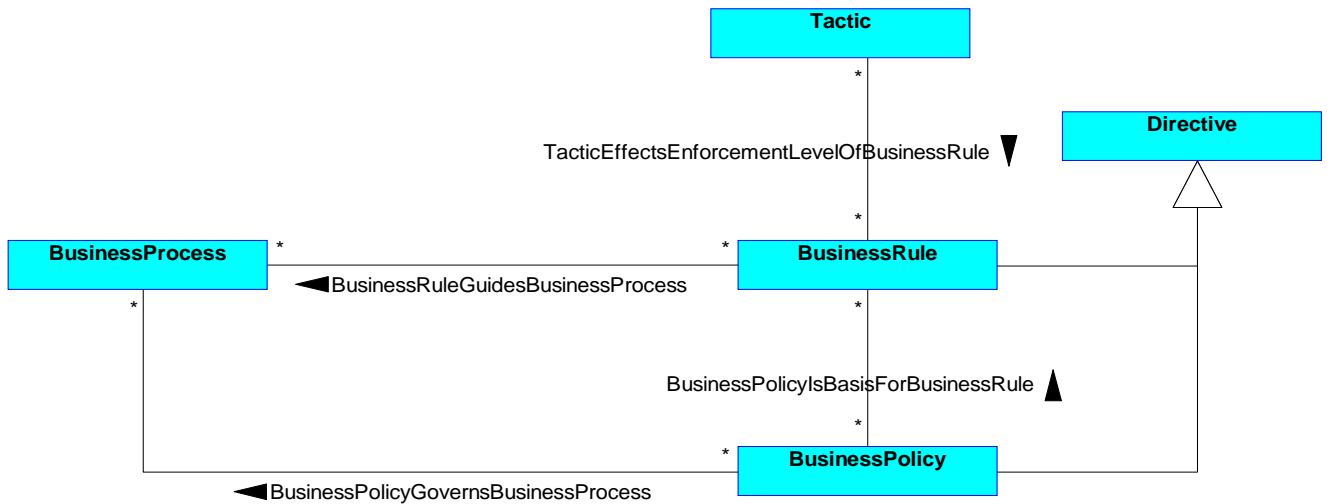

Figure F.2 - Business Rule fragment of BMM

The corresponding part of the SBVR Specification [SBVR] is:

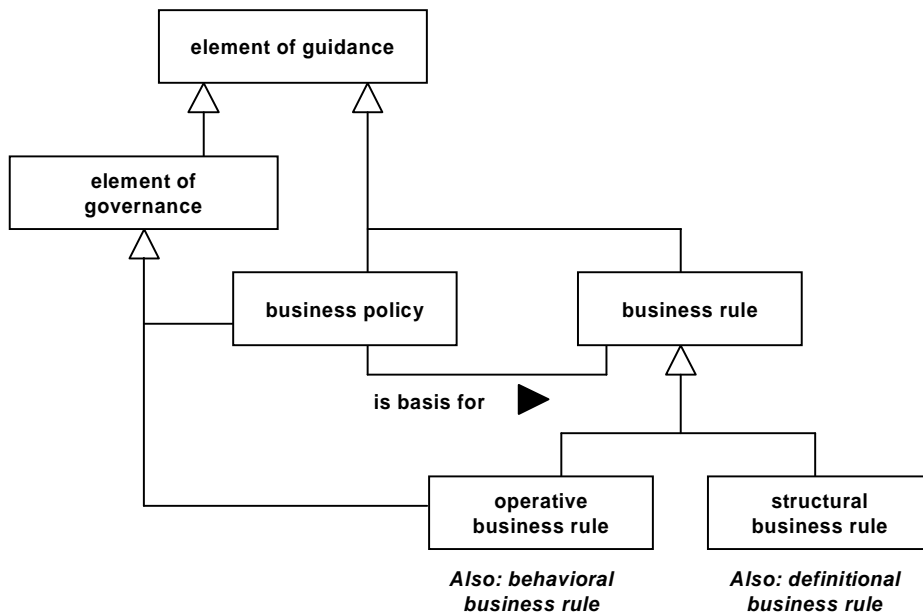

Figure F.3 - Business Rule fragment of SBVR

Business Policy and Business Rule are already aligned in the two models.

F.4 Organization Structure Model

The fragment of the Business Motivation Model that addresses Organization Unit is illustrated below:

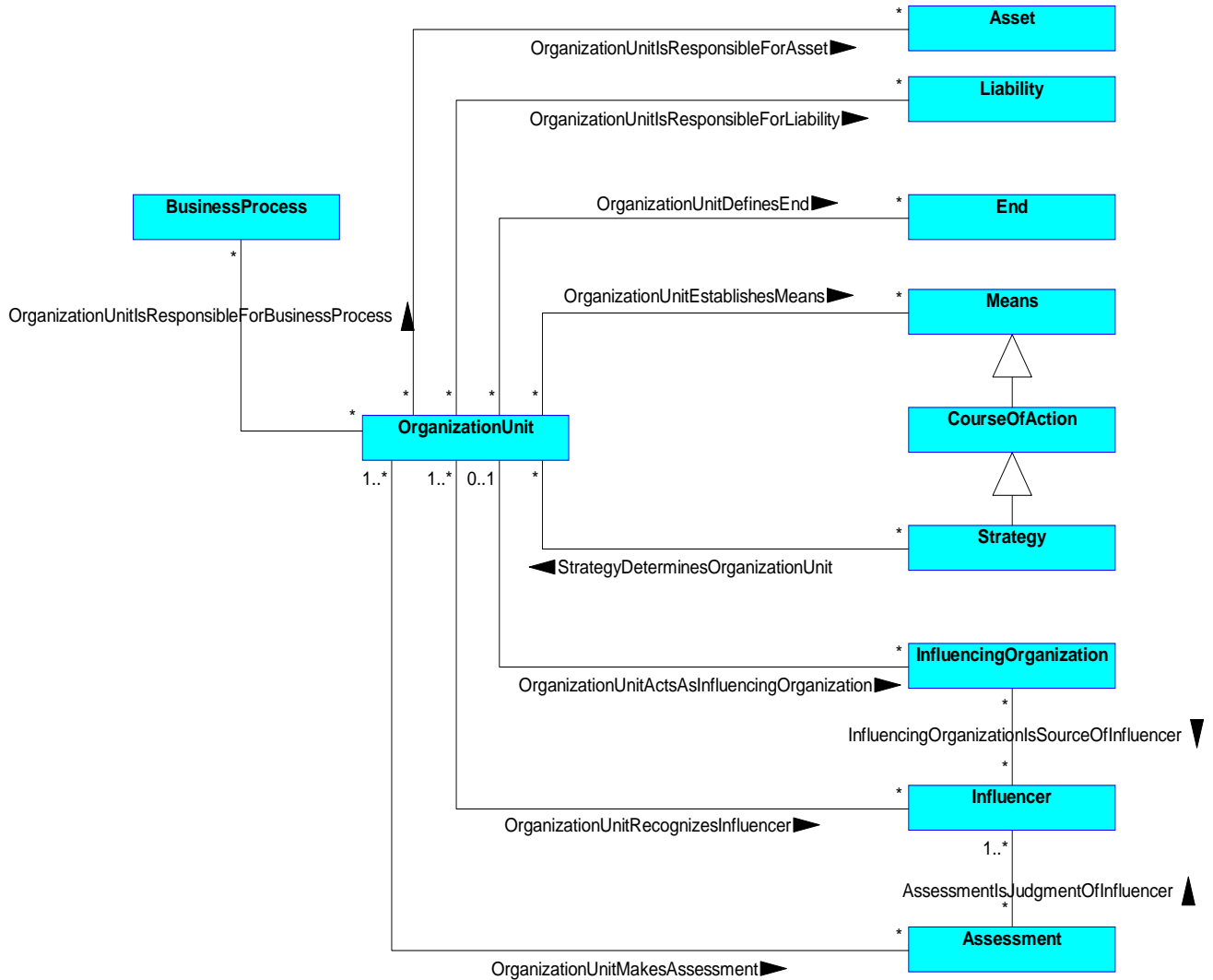

Figure F.4 - Organization Unit fragment of BMM

OMG does not have a general specification for organization structure. A broad definition for Organization Unit is provided in Clause 9. BMM placeholders for Organization Units are references to units in the organization unit model used by the enterprise.

The concept 'Performer' in the BPMN specification [BPMN] corresponds in BMM to organization unit's role as being responsible for business process.

Annex G

Defaults for Categorization

(Informative)

The Business Motivation Model does not prescribe fixed categories of Assessment or Influencer. This annex describes categories for both that are recommended by the Business Rules Group (developers of the original Business Motivation Model) as default sets for enterprises that do not already have preferred categories.

G.1 SWOT Assessments

An Assessment is a judgment about some Influencer that affects the organization’s ability to employ its Means or achieve its Ends. A widely-used scheme for categorizing assessments is that the effect of the influencer indicates a Strength or Weakness of the enterprise, an Opportunity for, or a Threat to, the enterprise (SWOT).

The relevant fragment of the BMM MOF Model is illustrated in Figure G.1.



Figure G.1 - Assessment Category

In a tool that supports the BMM, an enterprise that wanted to use SWOT would define four new instances of AssessmentCategory: “Strength,” “Weakness,” “Opportunity,” and “Threat.”

The enterprise could also define other Assessment Categories.

It is left to methodology and practice, and perhaps capabilities of BMM support tools, to manage multiple categorization of Assessments.

To extend its business vocabulary (as expressed in the Concepts Catalog in SBVR Structured English) the enterprise could add the following entries.

opportunity

Definition	assessment that an influencer can have a favorable impact on the employment of means or achievement of ends.
Dictionary Basis	a combination of circumstances, time, and place suitable or favorable for a particular activity or action [MWUD 'opportunity' (1a)]
Dictionary Basis	an advantageous circumstance or combination of circumstances especially when affecting security, wealth, or freedom (as from constraint): a time, place, or condition favoring advancement or progress [MWUD 'opportunity' (1b)]
Dictionary Basis	a time or set of circumstances that makes it possible to do something [ODE 'opportunity']

strength

Definition	assessment that an influencer indicates an advantage or area of excellence within an enterprise that can impact its employment of means or achievement of ends
Dictionary Basis	a good or beneficial quality or attribute of a person or thing [ODE 'strength' (4)]

threat

Definition	assessment that an influencer can have an unfavorable impact on the enterprise's employment of means or achievement of ends
Dictionary Basis	something that by its very nature or relation to another threatens the welfare of the latter [MWUD 'threat' (2)]
Dictionary Basis	the possibility of trouble, danger, or ruin [ODE 'threat' (2, bullet 1)]

weakness

Definition	assessment that an influencer indicates an area of inadequacy within an enterprise that can impact its employment of means or achievement of ends
Dictionary Basis	disadvantage or fault [ODE 'weakness' (bullet 1)]
Dictionary Basis	lacking in power to perform properly a function or office [MWUD 'weak' (4a)]
Dictionary Basis	lacking skill or proficiency [MWUD 'weak' (4b)]

G.2 Categories of Influencer

An influencer is something that has the capability of causing the enterprise to assess whether employment of its needs or achievement of its ends could be affected by the influencer. It is useful to be able to categorize influencers to assist in, for example, analysis of what kinds of change caused the enterprise to react, and what assessments and decisions were made.

The BMM does not mandate any particular set of categories. However, the categories here provide a useful default set for enterprises that do not have a preferred set of categories. They were built up by the Business Rules Group out of their practice in using and developing the BMM up to the time when it was adopted by the OMG.

The relevant fragment of the BMM MOF Model is illustrated in Figure G.2.



Figure G.2 - Influencer Category

In a tool that supports the BMM, an enterprise that wanted to use the default set of categories described below would define a new instance of AssessmentCategory for each one.

The enterprise could also define other Influencer Categories.

There are three sets of Influencer Categories described here:

- A general set of categories that have been frequently used in practice, including Competition, Regulation, Corporate Value, Technology.
- Internal/External (built into BMM), for categorization of influencers as being from inside or outside the enterprise boundaries. For example, influencers in the general category 'Customer' would usually be external; influencers in the general category 'Management Prerogative' would usually be internal.
- Implied/Explicit, for categorization of influencers as being explicitly described or 'just known' by people in the enterprise. For example, a corporate value "You take problems to your boss - you don't go over your boss's head" might be implied - not officially published by the company, but understood by employees.

A given influencer would typically be categorized as being of one or more general categories, and as either 'internal' or 'external'. Implied/Explicit categorization is used for corporate values. The default suggestions for multiple categorizations are summarized in Table G.1.

Table G.1 - Suggested combinations of categories

Internal/External		Implied/Explicit	
external influencer	internal influencer	explicit influencer	implied influencer
competitor customer environment partner regulation supplier technology	assumption corporate value habit infrastructure issue management prerogative resource	corporate value	corporate value

These suggestions are not exhaustive. For example, an enterprise might want to categorize an influencer as internal technology or another as external assumption.

It is left to methodology and practice, and perhaps capabilities of BMM support tools, to manage multiple categorization of Influencers.

To extend its business vocabulary (as expressed in the Concepts Catalog in SBVR Structured English) the enterprise could add the following entries.

General Categories

assumption

Definition

[internal influencer](#) that is taken for granted or without proof

Dictionary Basis

a thing that is accepted as true or as certain to happen, without proof [NODE 'assumption' (1)]

competitor

Definition

[external influencer](#) that is a rival enterprise in a struggle for advantage over the subject enterprise.

Dictionary Basis

an organization or country that is engaged in commercial or economic competition with others [ODE 'competitor', bullet]

Dictionary Basis

a contest between rivals: a match or trial between contestants [MWUD 'competition' (2)]

Dictionary Basis

a market condition in which a large number of independent buyers and sellers compete for identical commodities, deal freely with each other, and retain the right of entry and exit from the market [MWUD 'competition' (4b)]

corporate value

Definition

[internal influencer](#) that is an ideal, custom, or institution that an enterprise promotes or agrees with. It may be positive or negative, depending on point of view.

Dictionary Basis

principles or standards of behavior; one's judgment of what is important in life [ODE 'values' (2)]

customer

- Definition [external influencer](#) that is a role played by an individual or enterprise that has investigated, ordered, received, or paid for products or services from the subject enterprise.
- Dictionary Basis a person or organization that buys goods or services from a shop or business [ODE 'customer' (1)]
- Dictionary Basis an official or authoritative instruction [ODE 'directive']

environment

- Definition [external influencer](#) that is the aggregate of surrounding conditions or Influencers affecting the existence or development of an enterprise.
- Dictionary Basis the surroundings or conditions in which a person, animal, or plant lives or operates [ODE 'environment' (1)]

explicit corporate value

- Definition [corporate value](#) that is explicitly declared
- Dictionary Basis See [corporate value](#)

habit

- Definition [internal influencer](#) that is a customary practice or use
- Dictionary Basis a settled or regular tendency or practice, especially one that is hard to give up [ODE 'habit' (1)]

implicit corporate value

- Definition [corporate value](#) that is not explicitly declared but understood by some or all of the people in an enterprise
- Note See corporate value

infrastructure

- Definition [internal influencer](#) that is the basic physical and organizational structures and facilities needed for the operation of the enterprise
- Dictionary Basis the basic physical and organizational structures and facilities (e.g., buildings, roads, power supplies) needed for the operation of a society or enterprise [ODE 'infrastructure']

issue

- Definition [internal influencer](#) that is a point in question or a matter that is in dispute as between contending partners
- Dictionary Basis an important topic or problem for debate or discussion [ODE 'issue' (1)]

management prerogative

- Definition [internal influencer](#) that is a right or privilege exercised by virtue of ownership or position in an enterprise
- Dictionary Basis a right or privilege exclusive to a particular individual or class [ODE 'prerogative']

partner

Definition	external influencer that is an enterprise that shares risks and profit with the subject enterprise (or is associated with the subject enterprise to share risks and profit) because this is mutually beneficial
Dictionary Basis	a person who takes part in an undertaking with another or others, especially in a business or firm with shared risks and profits [ODE 'partner']

regulation

Definition	external influencer that is an order prescribed by an authority such as a government body or the management of an enterprise
Dictionary Basis	a rule or element of guidance made and maintained by an authority [ODE 'regulation' (1)]
Dictionary Basis	a rule or order having the force of law issued by an executive authority of a government [MWUD: 'regulation' (2b)].

resource quality

Definition	influencer that is the quality or availability of resources
------------	---------------------------------------------------------------------------------------------

supplier

Definition	external influencer that is a role played by an individual or enterprise that can furnish or provide products or services to the subject enterprise
Synonym	vendor
Dictionary Basis	make (something needed or wanted) available to someone; provide [ODE 'supply']

technology

Definition	external influencer that is caused by developments in and limitations of technology
Dictionary Basis	the application of scientific knowledge for practical purposes, especially in industry: machinery and equipment developed from such scientific knowledge [ODE 'technology']
Note	There may be prerequisites for use of technology; there may be enterprise activity that technology enables or restricts.

Internal/External Categories

Categories [internal influencer](#) and [external influencer](#) are built into BMM.

Categories of [external influencer](#) include: [competitor](#); [customer](#); [environment](#); [partner](#)

Categories of [internal influencer](#) include: [assumption](#); [corporate value](#); [habit](#); [infrastructure](#); [issue](#), [management prerogative](#), [resource](#)

Implied/Explicit Categories

explicit influencer

Definition	influencer that is explicitly described
Note	Categories of influencer often also categorized as explicit influencers include: corporate value .

implied influencer



Definition	influencer that is not explicitly described but understood by some or all of the people in an enterprise.
------------	---------------------------------------------------------------------------------------------------------------------------

Note

Categories of [influencer](#) often also categorized as [explicit influencers](#) include: [corporate value](#).

Annex H Bibliography

(Informative)

BMM-XMI	BMM in XMI, OMG document dtc/07-08-05.xmi
BPDM	Business Process Definition Metamodel, OMG Specification, available from www.omg.org
 BPMN	Business Process Model and Notation Version 2.0 (http://www.omg.org/spec/BPMN/2.0).
BRGHIST	A Brief History of the Business Rule Approach, Business Rules Journal, Vol. 7, No. 11 (November 2006), available from www.BRCommunity.com/a2006/b317.html
BRMAN	Business Rules Manifesto Version 2.0, Business Rules Group (Nov 2003), available from www.businessrulesgroup.org
BRWATR	Business Rules ~ What are they Really? 4th ed. (July 2000), formerly known as the "GUIDE Business Rules Project Report," (1995); available from www.businessrulesgroup.org
MWUD	Merriam-Webster Unabridged Dictionary, Merriam-Webster (January 2002), ISBN: 0877792011
ODE	Oxford Dictionary of English, Oxford University Press (Aug 2005), ISBN: 0198610572
NODE	New Oxford Dictionary of English, Oxford University Press (1998), <i>superseded by ODE</i>
 SBVR	Semantics of Business Vocabulary and Business Rules (http://www.omg.org/spec/SBVR/1.1)
SWOT	Neal Fishman,, "SWOT Assessment", DataToKnowledge Newsletter, Volume 27, No. 6 (November/December 1999), pp. 3-4
ZACH	John A. Zachman, "A Framework for Information Systems Architecture," IBM Systems Journal, Vol. 26, No. 3 (1987).

INDEX

A

Acknowledgements 6
Additional Information 6
Assessment 15, 52
Assessments 20, 44
Asset 61
Attributes 75

B

BMM Overview 18
Business Motivation Model 1
Business Policy 41
Business Process 21, 60
Business Process Definition Metamodel (BPDM) 20
Business Processes 2
Business Rule 21, 42
Business Rules 3
Business Rules Group (BRG) 1
Business Vocabulary 2

C

Categories of End 27
Changes to Adopted OMG Specifications 6
Composition 43
Concepts 65
Concepts Catalog 65
Conformance 4
Core Elements 44
Course of Action 19, 34
Critical Success Factor (CSF) 84

D

Decomposition 17
Definitions 5
Desired Result 28, 31
Directive 19, 37, 39
Directive as Regulation 51

E

Enabling 43
End 18
End Concepts 27
Enforcement Level 38
External Influencers 46

G

Goal 29

H

How to Read this Specification 6

I

Influencer Categories 45
Influencers 15, 20, 44
Influencing Organization 49

K

Key Performance Indicator (KPI) 84

L

Liability 62

M

Means 19, 32
Metrics 17, 83
Mission 15, 33
Motivation 15, 16

N

Normative References 4

O

Objective 30
Opportunity 54
Organization Structure Metamodel (OSM) 20
Organization Unit 21, 58

P

Placeholders 58
Potential Impact 55
Potential Reward 56

Q

Qualitative words 44

R

Reaction to Change 16
References 4
Regulation 39
Releases 91
Reward 56
Risk 56

S

SBVR Structured English 65
Scope 1
Semantics of Business Vocabulary and Business Rules (SBVR) 20
Separation of Concerns 17
Specific, Measurable, Attainable, Relevant, and Time-Based (SMART) 30
Strategy 35
Strength 53
Strength, Weakness, Opportunity, Threat (SWOT) 20
SWOT Assessments 103
Symbols 5

T

Tactic 35, 36

Terms 5

Terms and definitions 5

Threat 54

V

Vision 27

Vision) 15

W

Weakness 54

Workflows 2

Z

Zachman Architecture Framework 87